

Identification of Faults in HVDC System using Wavelet Analysis

K.Satyanarayana*, **Saheb Hussain MD****, **B.Ramesh***

*Ph.D Scholar, EEE Department, Vignan University (A.P), India, ksatya.eee@gmail.com

**Assistant Professor, EEE Department, VIIT (A.P), India, saheb228@vignanvizag.com

Article Info

Article history:

Received Nov 10th, 2012

Revised Mar 16th, 2012

Accepted Mar 26th, 2012

Keyword:

Faults
HVDC Transmission
Multi-Resolution Analysis (MRA)
Wavelets

ABSTRACT

The identification and classification of faults is important for safe and optimal operation of power systems. For secure operation of a system a feasible approach is to monitor signals so that accurate and rapid classification of fault is possible for making correct protection control. To identify HVDC faults by using pure frequency or pure time domain based method is difficult. The pure frequency domain based methods are not suitable for time varying transients and the pure time domain based methods are very easily influenced by noise. Wavelet analysis is one of the methods used for providing discriminative features with small dimensions to classify different disturbances in HVDC transmission system. This paper explores the application of wavelet based Multi-Resolution Analysis (MRA) for signal decomposition to monitor some faults in HVDC system. The faults in HVDC system can be classified by monitoring the signals both on AC and DC sides of the HVDC system. The fault classifier can be developed from these monitored signals which show promising features to classify different disturbances in the HVDC system.

*Copyright © 2012 Insitute of Advanced Engineering and Science.
All rights reserved.*

Corresponding Author:

K.Satyanarayana,
Departement of Electrical and Electronics Engineering,
Paladugu Parvathi Devi College of Engineering & Technology,
Surampalli Village, Near Nunna, Vijayawada.
Email: r.bonigala@gmail.com, ksatya.eee@gmail.com

1. INTRODUCTION

The high voltage direct current (HVDC) is most essential for bulk power transfer and large scale demands. Due to heavy power demand, maintenance of power quality has become very difficult. Most common disturbances are faults on the system which can be classified as symmetrical and non-symmetrical faults. These disturbances lead to heavy damage to HVDC transmission system and converter stations due to bulk power. The other disturbance like internal faults in converter and equipments also produce same effect. Some are very severe while some have less impact. Hence the identification and controlling of these faults is essential and control system plays a prominent role in the overall performance of the transmission system. Fault identification and classification is very important for the secure and optimal exploitation of electric power systems [1]. The Wavelet Analysis can be used as a tool for providing discriminative features with small dimensions to classify different disturbances in HVDC transmission system. This paper explores the application of wavelet based multi-resolution analysis (MRA) for signal decomposition to monitor some of the faults (e.g.- L-G Fault, LL-G,LLL-G, DC line fault) in the HVDC system. The faults in HVDC System can be classified by monitoring the signals both on AC and DC sides of the HVDC System like Inverter side AC phase currents, DC Voltage, DC current, and Valve Currents. The fault classifier can be developed from these monitored signals which show promising features to classify different disturbances in the HVDC System. The simulation results are also presented to verify the performance of the proposed method. The

method has been used to classify different faults as well as to identify faulted phase(s) and valve(s) in case of AC faults and Commutation failure respectively.

Rashmi A.Keswani, et.all describes fault identification and classification is very important for the secure and optimal exploitation of electric power systems. The Wavelet Analysis can be used as a tool for providing discriminative features with small dimensions to classify different disturbances in HVDC transmission system. This paper explores the application of wavelet based multi-resolution analysis (MRA) for signal decomposition to monitor some of the faults (e.g.- L-G Fault, DC line fault, Commutation failure) in the HVDC system [2]. The simulation results are also presented to verify the performance of the proposed method. The method has been used to classify different faults as well as to identify faulted phase(s) and valve(s) in case of AC faults and Commutation failure respectively [3], [4].

L L Lai, et.all describes a neural network and its simulation results for fault diagnosis in HVDC systems [5]. Fault diagnosis is carried out by mapping input data patterns, which represent the behavior of the system, to one or more fault conditions. The behavior of the converters is described in terms of the time varying patterns of conducting thyristor and ac & dc fault characteristics. A three-layer neural network consisting of 20 input nodes, 12 hidden nodes and 2 output nodes is used [6]. This paper will describe the performance of the network for ac and dc faults due to changes in number of hidden layers, number of neurons in the layer, learning rate and momentum. Dynamic characteristics of networks for different configurations are studied too.

Cailiang Gao, Zhiwei Liao, et.all presented on the singular value decomposition and support vector machines, a new fault diagnosis of commutation failures method in HVDC system was proposed. The coefficient matrix acquired from wavelet package transform is first decomposed on singular value, by which fault current are mapped to different time-frequency sub-space [7]. Then the singular value is put into support vector machines to carry out the SVM training and fault type identification. The new method in this paper has high recognition rate, identification speed and stability. It can solve the fault type classification well.

2. RESEARCH METHOD

A 12- pulse HVDC test system is considered for the study in Matlab/Simulink environment [8]. A 1000 MW (500 kV, 2kA) DC interconnection is used to transmit power from a 500 kV, 5000 MVA, 60 Hz network (AC system 1, having a SCR of 5) to 345 kV, 10000 MVA, 50 Hz network of AC system 2, having a SCR of 2.5. The AC networks are represented by damped L-R equivalents with an angle of 80 degrees at fundamental frequency (60 Hz or 50 Hz) and at the third harmonic. The rectifier and the inverter are 12-pulse converters using two universal bridge blocks connected in series. The converters are interconnected through a 300 km distributed parameter line and 0.5 H smoothing reactor. The converter transformer ($Y_g/Y/\Delta$) is modelled with three-phase transformer (three-Windings). The tap position is rather at a fixed position determined by a multiplication factor applied on the primary nominal voltage of the converter transformers (0.9 on rectifier side; 0.96 on inverter side). The configuration of the system is given in Fig. 1.

Table 1. Ratings of 12-pulse HVDC system

Parameters	Inverter side	Rectifier side
Voltage (kV)	245	500
Power (MVA)	10000	5000
Frequency (Hz)	50	60

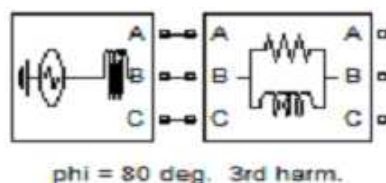

Figure 1. AC system at rectifier side

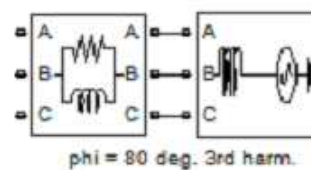

Figure 2. AC system at inverter side

2.1. The AC systems

The AC networks, both at the rectifier and inverter end, are modelled as infinite sources separated from their respective commutating buses by system impedances. The impedances are represented as L-R/L networks having the same damping at the fundamental and the third harmonic frequencies [9]. The impedance angles of the receiving end and the sending end systems are selected to be 80 degrees. This is likely to be more representative in the case of resonance at low frequencies.

2.2. DC system

The DC system is composed of smoothing reactors and a DC transmission line modelled with distributed parameter line with lumped losses [10]. This model is based on the Bergeron's travelling wave method used by the Electromagnetic Transient Program (EMTP).

2.3. The converter transformers

The 1200 MVA converter transformer is modelled with three-phase transformer (Three-Windings). The parameters adopted (based on AC rated conditions) are considered as typical for transformers found in HVDC installation such as leakage.

2.4. AC filters and capacitor banks

On AC side of 12-pulse HVDC converter, current harmonics of the order of 11, 13, 25 and higher are generated. Filters are installed in order to limit the amount of harmonics to the level required by the network. In the conversion process, the converter consumes reactive power, which is compensated in part by the filter banks and the rest by capacitor banks of 600 Mvar on each side.

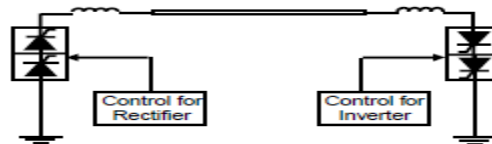

Figure 3. DC system

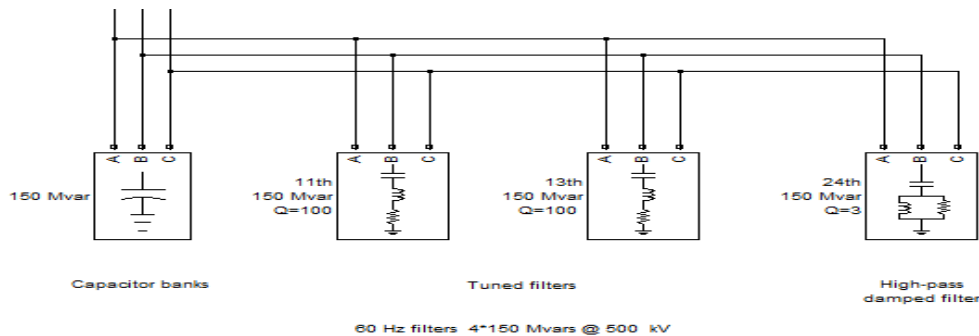

Figure 4. AC filters and capacitor banks

2.5. Control systems

The rectifier and the inverter control both have a voltage and a current regulator operating in parallel calculating firing angle α_v and α_i . Both regulators are of the proportional and integral type (PI). In normal operation, [11] the rectifier controls the current at the I_d reference value whereas the inverter controls the voltage at the V_d ref reference value. The I_d margin and V_d margin parameters are respectively 0.1 p.u. and 0.05 p.u.

The following faults were simulated:

- AC Faults at inverter end (Symmetrical & Unsymmetrical faults)
- DC line Faults (at various lengths from the rectifier end i.e. at rectifier, at 100kms from rectifier end, at inverter end)

The following signals were monitored:

- Inverter side Phase Currents and voltages
- Rectifier side Phase Currents and voltage
- DC Voltage
- DC Current

3. RESULTS AND ANALYSIS

The wavelet transform is used to identify and classify of different faults in HVDC system (i.e. AC faults and DC fault). From the test system, voltage and current signals are monitored at two locations namely; ac inverter side and DC rectifier side [12], [13]. First simulation describes the classification and identification of signals based on DC side monitoring. Second simulation describes the classification and identification of signals based on Inverter ac side monitoring. In both simulations fault is applied for 5 cycle's i.e. 0.7- 0.8 sec. The following four system fault cases were simulated

1. Normal operating case used as base case
2. DC line fault
3. LG at inverter end

For each of the above cases following four signals were monitored.

Inverter side phase A, voltage inverter side phase A current, DC voltage and DC current. Two signals were monitored an AC side and two signals on the DC side of the system. The wavelet based feature extraction technique was applied to these signals to discriminate and identify the faults. The following algorithm briefly identifies the type of fault.

3.1 Algorithm:

Step-1: Start the program in new m-file.

Step-2: Load the denoised voltage and current signals.

Step-3: Decompose the signal with db4 for desired resolution level.

Step-4: Obtain the detailed coefficients at each level

Step-5: Calculate the absolute mean of detailed coefficients at each resolution level.

Step-6: End

3.2 Wavelet decomposition program:

```
load[denoised current or voltage signal (X)]
```

```
s=length(X);
```

```
g=0;h=initial no.of samples;h1=h+g;
```

```
for p=1:no.of cycles
```

```
  k=X(h1:h1+no.of samples per cycle);
```

```
  [c,l]=wavedec (k,8,'db4');
```

```
  cd8=detcoef(c,l,8);
```

```
  r=abs(cd8);ref(p)=sum(r);
```

```
  h1=h1+no.of samples per cycle;
```

```
end
```

```
X=[ref(p)]
```

```
X1=mean(ref)
```

3.3 DC Side Monitoring

3.3.1 Normal case:

The normal DC voltage and current wave forms are shown in Figure 5 here the voltage and current signals having transient and steady state periods. Transient signal period is 0 to 0.3sec and steady state signal period is 0.3 to sec. the magnitude of DC voltage and DC current is 1pu.

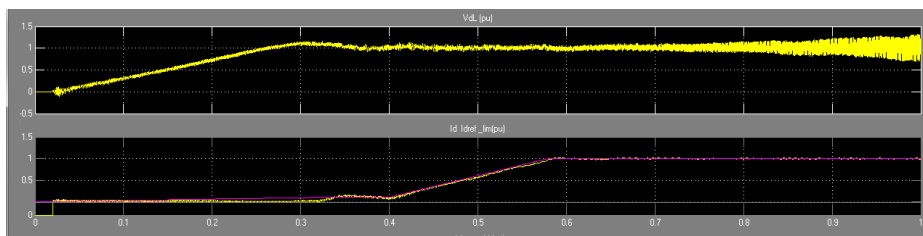

Figure 5. DC voltage and current under normal condition

3.3.2 DC line fault case

With the application of the fault at $t=0.7$ sec the DC current shown in figure 3.2.increases to 2.3pu and DC voltage shown in fig 5.2.fall to zero at the inverter. The voltage dependent current order limit senses the DC voltage drop and reduces the reference current to 0.3pu. Now the rectifier firing angle is forced to 160 and now the rectifier operates in inverter mode. The DC line voltage becomes negative and energy stored in

the line is return to AC network causing rapid extinction of the fault current at its next zero crossing. The firing angle alpha is released at t=0.8sec and the normal DC voltage and DC current will recover at approximately 0.4sec when fault is cleared.

3.3.3 AC fault case

A single phase to ground fault is applied to the phase A of the inverter bus the duration of the fault was 5 cycles (100msec). when this fault is applied at t=0.7sec the fault causes the voltage to collapse as shown in Figure 7 and DC current rises to 2pu as shown in Figure 7 the rectifier current controller attends to reduce the current by increasing it firing angle alpha and operating in its inverter region. The DC current decreases to low average value as determine by VDCOL the fault is cleared at t=0.8sec the VDCOL operates and rises the reference current to 1pu. The system recovers in approximately 0.3sec after fault clear.

The percentage variations in three cases are shown in below Figure 7. The percentage increasing of voltage and current under normal, DC fault and AC fault cases are represented by different colors.

3.3.4 Observation by DC side monitoring

The percentage variations in three cases are shown in below Figure 8. The percentage increasing of voltage and current under normal, DC fault and AC fault cases are represented by different colors.

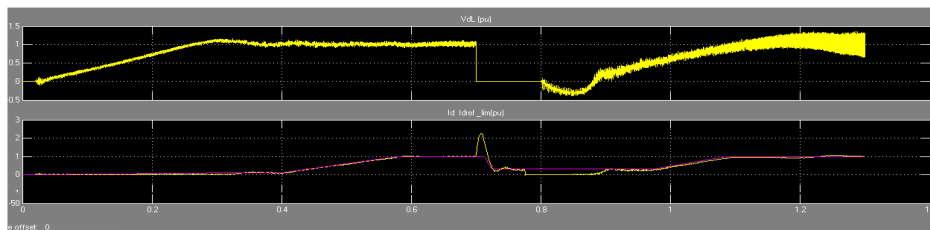

Figure 6. DC voltage and DC current for DC fault

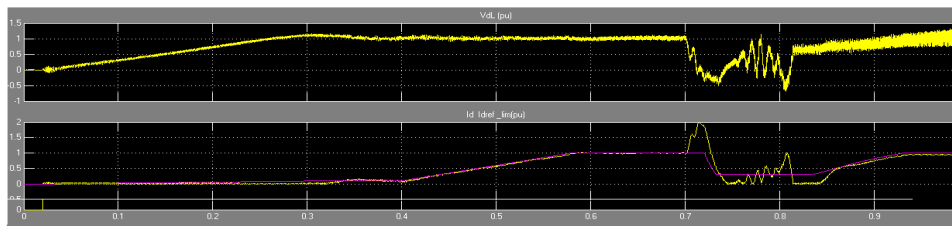

Figure 7. DC voltage and DC current signals for AC faults

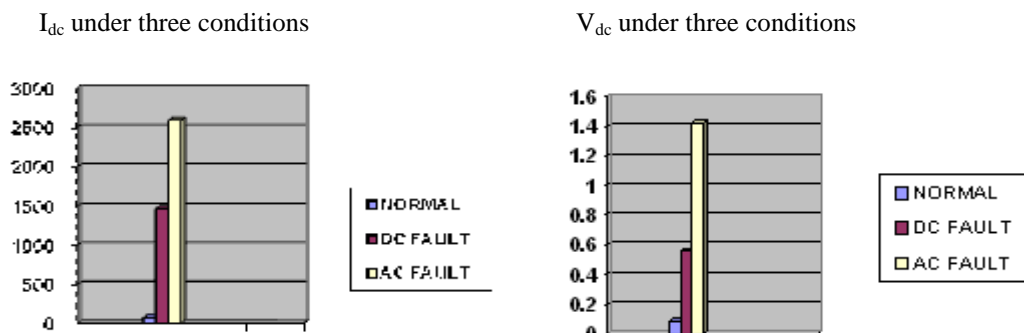

Figure 8. Percentage variations of DC voltage and current in three cases

If observe at DC side monitoring whenever the disturbance is occurs corresponding the mean values of DC current and DC voltage denoised signals are increased with respect to disturbance. if it is DC fault the mean values of current is increased by 95.05% and the voltage value is increased by 83.9% and if the disturbance is AC fault corresponding the mean values of current is more increased by 97.2% and the voltage is increased by 93.6% when compared with normal operating condition (NOC).

Table 1. Percentage variation in between DC & AC faults at DC side

Type of fault	DC current (Idc)	DC voltage (V dc)
DC fault	95.05%	83.9%
AC fault	97.2%	93.6%

3.4 Inverter Side Monitoring

3.4.1 Normal case

The three phase voltages and currents under normal operating condition are shown in Figure 9. The voltage magnitude of each phase is same and + or - 1 pu. The phase current signals magnitude is also same.

3.4.2 DC line fault case

The three phase voltage signals were shown in Figure 10 in which phase fault is occurs corresponding that phase voltages and currents magnitudes were changed there is no change in remaining healthy phases it is shown in Figure 10. Here fault is happened in phase A at time $t=0.7$ sec the voltage magnitude is become zero and remaining phases B and C magnitudes are same as normal operating condition. The current magnitude also decreases to negative value.

3.4.3 AC fault (LG) case

The three phase voltage signals were shown in Figure 11. in which phase fault is occurs corresponding that phase voltages and currents magnitudes were changed there is no change in remaining healthy phases it is shown in Figure 11. Here fault is happened in phase A at time $t=0.7$ sec the voltage magnitude is become zero and remaining phases B and C magnitudes are same as normal operating condition. The current magnitude also decreases to negative value.

3.4.4 Observation by inverter side monitoring

The percentage variations in three cases are shown in below Figure 12. The percentage increasing of voltage and current under normal, DC fault and AC fault cases are represented by different colors.

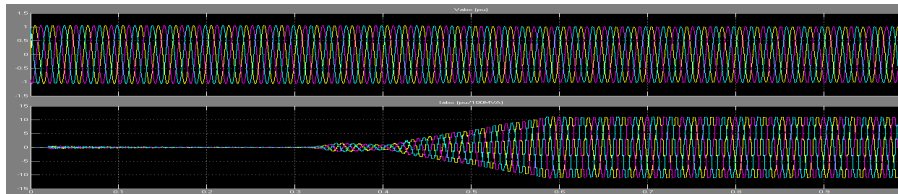

Figure 9. The phase voltages and current waves for normal case

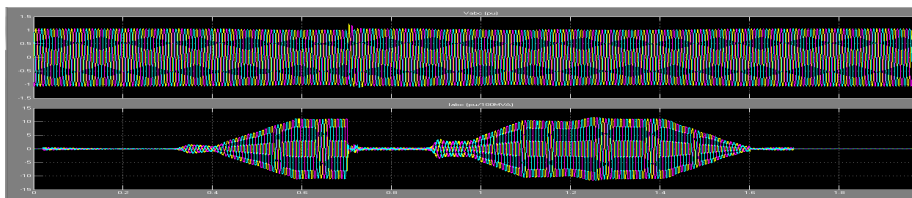

Figure 10. AC voltage and current signals for DC fault

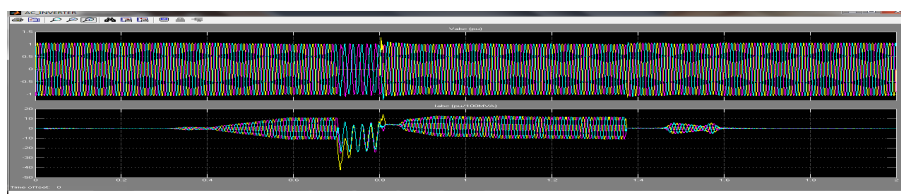

Figure 11. Inverter side phase voltage and current signals for AC fault

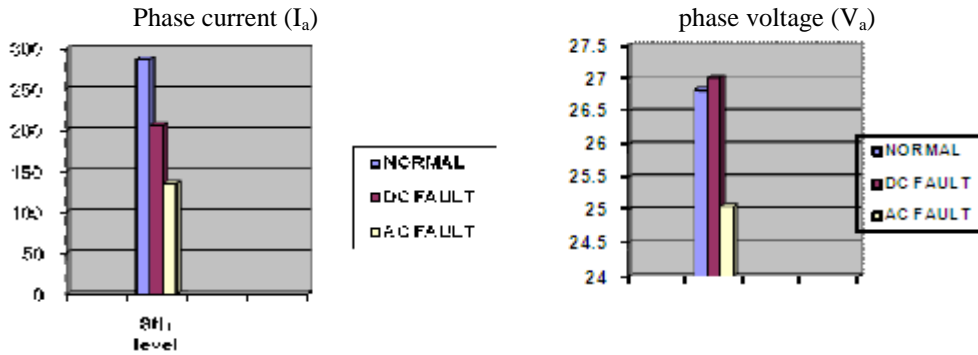

Figure 12. Percentage variations of phase voltage and currents in three cases

If observe the Table 2. At inverter side monitoring whenever the disturbance is occurs corresponding the mean values of phase currents and voltages denoised signals are decreased or increased with respect to disturbance. if it is DC fault the mean values of current is decreased by 28.02% and the voltage value is increased by 0.68% and if the disturbance is AC fault corresponding the mean values of current is more decreased by 52.81% and the voltage is decreased by 6.58% when compared with normal operating condition (NOC).based on this information at inverter side monitoring we can identify the type of fault in HVDC system.

Table 2. Percentage variation in between DC & AC faults at inverter side

Type of fault	Phase current	Phase voltage
DC fault	28.02%	0.68%
AC fault	52.81%	6.58%

4. CONCLUSION

This paper introduces a new technique that is based on wavelet multi-resolution signal decomposition for classifying typical disturbances in HVDC systems. The ability to recognize and react quickly to these disturbances can be extremely useful in to secure an optimal operation of such systems. The wavelet-based proposed technique shows highEfficiency compared with fast Fourier transform and short time Fourier transforms. The main advantage of the proposed method comes from its ability to extract discriminative, translation invariant features with small dimensionality from the signals monitored on the AC and DC sides of the HVDC system. Simple rules were obtained and can be implemented to design an automated recognition and protection system. In order to further reduce the computational burden of processing the monitored signals and obtaining a precise disturbance classification, a study was made to utilize only the AC current at the faulted side of the HVDC system. The proposed technique proves that monitoring only the AC voltage and current at the faulted side can produce unique features to differentiate between typical disturbances. Similarly, monitoring signals from the DC side also show promising features that can help classify different disturbances that might occur anywhere in the HVDC system

REFERENCES

- [1] Rashmi A.Keswani "Identification of Fault in HVDC Converters using Wavelet Based Multi-Resolution Analysis" IEEE Transactions on Power System
- [2] A.M.Gaouda, V.K.Sood, A.Y.Chikhani, "Disturbance Monitoring in HVDC Systems Using Wavelet Multiresolution Analysis", IEEE Transactions on Power System, Vol. 16, No.4, November 2000. pp. 678 – 684.
- [3] A.M.Gaouda, E.F.El-Saadany, M.M.A.Salama, V.K.Sood, A.Y.Chikhani, "Monitoring HVDC Systems using Wavelet Multiresolution Analysis", IEEE Transaction on Power systems, Vol.16, No.4, pp 662- 669, Nov.'01.
- [4] Narendra Bawane, A.G.Kothari, D.P.Kothari, "Application of Wavelet Analysis for Monitoring HVDC System", International Conference On Computer Applications in Electrical Engineering- Recent Advances, Roorkee, Sep.29 –Oct.1, 2005.
- [5] L.Shang, G.Herold, J.Jaeger, R.Krebs, A.Kumar "Analysis and Identification of HVDC system Faults Using Wavelet Modulus Maxima", IEE transactions November 2001.

- [6] Jaeho Choi, Hongkyun Kim, Jinmok Lee, Gyo-Bum Chung, "Power Disturbance Classifier using Wavelet Based Neural Network", *Journal of Power Electronics*, Vol. 6, No. 4, October 2006, pp 307 – 313.
- [7] N. Kandil, V.K. Sood, K. Khorasani and R.V. Patel, "Fault identification in an AC-DC transmission system using neural networks," *IEEE Transactions on Power Systems*, Vol.7, No.2, May. 1992, pp. 812-819.
- [8] S. Santoso, E.J Powers, W.M Grady, P. Hofmann, "Power quality assessment via wavelet transform analysis," *IEEE Transactions on Power Delivery* Vol. 11, No2, Apr.1996.
- [9] S. Santoso, E.J. Powers, W.M. Grady, "Power quality disturbance data compression using wavelet transform methods," *IEEE Transaction on Power Delivery* Vol.12, No3, July 97, pp.1250- 1257.
- [10] S. Santoso, W.M. Grady, E.J. Powers, Jeff Lamoree, Siddhart C. Bhatt, "Characterization of Distribution Power quality events with Fourier and Wavelet Transforms," *IEEE Transaction on Power Delivery* Vol.15, No1, Jan. 2000, pp.247-254.
- [11] A.M. Gaouda, M. Salama, A. Chikhani, and M. Sultan, " Application of wavelet analysis for monitoring dynamic performance in industrial plants," *North American Power Symposium*, Oct. 1997, Laramie, Wyoming.
- [12] S. J. Huang, C.T. Hsieh, and C.L. Huang, "Application of Morlet Wavelets to Supervise Power System Disturbances," *IEEE Transactions on Power Delivery* Vol. 14, No.1, Jan. 99, pp235-243
- [13] A.M Gaouda, M. Salama, M. Sultan, and A. Chikhani, "Power quality detection and classification using wavelet-multi-x Symposium, Oct. 1997, pp 332-338.

BIBLIOGRAPHY OF AUTHORS



K.Satyanarayana was born in India, A.P, in 1986. He received the B.Tech degree from JNTU, Hyerarabad and M.E degree from JNTU, Kakinada, A.P, India in 2008, 2011 respectively. From 2009-2011 He worked as Assistant professor in Electrical & Electronics Engineering. He is pursuing Ph.D in Vignan University. His research interests include power systems and power electronics. He has published 9 publications in various international journals and conference



Saheb Hussain was born in India, A.P, in 1987. He received the B.Tech from JNTUH and M.E, degree from JNTU, Kakinada A.P, India in 2008, 2011 respectively. He is working as Asst.professor in Electrical & Electronics Engineering in Vignan Institute of Information Technology. His research interests include power systems and its applications.



B.Ramesh He received the B.Tech from JNTUH and M.Tech degree from ANU, Guntur, A.P, India in 2009, 2011 respectively. He is working as Asst.professor in Paladugu Parvathi Devi College of Engineering & Technology. His research interests include power systems and its applications.