

Air Force Institute of Technology

AFIT Scholar

Theses and Dissertations

Student Graduate Works

3-10-2006

Evaluation of Chlorinated Solvent Removal Efficiency among Three Wetland Plant Species: A Mesocom Study

Jun Yan

Follow this and additional works at: <https://scholar.afit.edu/etd>



Part of the [Environmental Chemistry Commons](#), and the [Environmental Sciences Commons](#)

Recommended Citation

Yan, Jun, "Evaluation of Chlorinated Solvent Removal Efficiency among Three Wetland Plant Species: A Mesocom Study" (2006). *Theses and Dissertations*. 3395.

<https://scholar.afit.edu/etd/3395>

This Thesis is brought to you for free and open access by the Student Graduate Works at AFIT Scholar. It has been accepted for inclusion in Theses and Dissertations by an authorized administrator of AFIT Scholar. For more information, please contact richard.mansfield@afit.edu.



**EVALUATION OF CHLORINATED SOLVENT
REMOVAL EFFICIENCY AMONG THREE
WETLAND PLANT SPECIES: A MESOCOM STUDY**

THESIS

Jun Yan, 2nd Lt, USAF

AFIT/GEM/ENV/06M-18

**DEPARTMENT OF THE AIR FORCE
AIR UNIVERSITY
AIR FORCE INSTITUTE OF TECHNOLOGY**

Wright-Patterson Air Force Base, Ohio

APPROVED FOR PUBLIC RELEASE; DISTRIBUTION UNLIMITED.

The views expressed in this thesis are those of the author and do not reflect the official policy or position of the United States Air Force, Department of Defense, or the U.S. Government.

AFIT/GEM/ENV/06M-18

**EVALUATION OF CHLORINATED SOLVENT REMOVAL EFFICIENCY
AMONG THREE WETLAND PLANT SPECIES: A MESOCOM STUDY**

THESIS

Presented to the Faculty

Department of Systems and Engineering Management

Graduate School of Engineering and Management

Air Force Institute of Technology

Air University

Air Education and Training Command

In Partial Fulfillment of the Requirements for the
Degree of Master of Science in Engineering Management

Jun Yan, BS

2nd Lt, USAF

March 2006

APPROVED FOR PUBLIC RELEASE; DISTRIBUTION UNLIMITED.

**EVALUATION OF CHLORINATED SOLVENT REMOVAL EFFICIENCY
AMONG THREE WETLAND PLANT SPECIES: A MESOCOM STUDY**

Jun Yan, B.S.
2nd LT, USAF

Approved:

/signed/

10 March 2006

Charles A. Bleckmann (Chairman)

date

/signed/

10 March 2006

James P. Amon (Member)

date

/signed/

10 March 2006

Abinash Agrawal (Member)

date

Abstract

The purpose of this research was to study three different wetland plant species and to compare the chlorinated solvent removal efficiency among each species. Each plant has a different characteristic favorable for chlorinated solvent degradation.

Eleocharis erythropoda (Spike Rush) are plants with thin tube like leaves and large root mass. *Carex Comosa* (longhaired Sedge) has broad leaves and *Scirpus Atrovirens* (Green Bulrush) are broad leafed wetland plants with a long flowering stem. Previous research had shown that wetlands were effective at degrading PCE. However, wetlands are composed of many different plant species and it is unknown which species are most effective at pollutant remediation. In order to study individual plants, twelve PVC column reactors had been built and each column has an upward flowing ground water scheme similar to both the constructed wetland and natural fen wetlands. Each column will be planted with one individual plant species and low concentrations of PCE will be injected into the plant mesocosm. It is my hypothesis that PCE will be degraded into daughter products in all the mesocosms. However, this experiment will attempt identify which plant is the most efficient at PCE degradation.

Acknowledgments

I would like to express my sincere appreciation to my advisor Dr. Amon for his continual help, advice and guidance through out this entire thesis process. His insights were pivotal in the completion of thesis. I am also very grateful for Dr. Agrawal's proactive involvement in my research. His expertise in Gas Chromatograph analysis was a tremendous help. I would also like to thank Dr. Shelley and Dr. Bleckmann for providing the tools and encouragement that propelled me to the very end.

Lastly but not least, I would like to thank my beautiful wife, who never gave up on me and gave me the joy I needed to carryout this endeavor.

Jun Yan

Table of Contents

| | Page |
|--|------|
| Abstract..... | iv |
| Acknowledgments..... | v |
| Table of Contents..... | vi |
| List of Figures..... | ix |
| List of Tables..... | xii |
| I. Introduction..... | 1 |
| Background..... | 1 |
| Conventional Treatment Methods..... | 3 |
| Bioremediation..... | 4 |
| Phytoremediation..... | 7 |
| Wetlands..... | 10 |
| Problem Statement..... | 12 |
| Research Objective and Hypothesis..... | 13 |
| Research Question..... | 13 |
| II. Literature Review..... | 14 |
| Natural Attenuation..... | 14 |
| Thermodynamics..... | 14 |
| Bioremediation..... | 18 |
| Phytoremediation..... | 21 |
| III. Methods..... | 24 |
| Column Construction..... | 24 |
| Planting Timeline..... | 28 |
| Syringe Pump Injection Rate..... | 28 |
| Inflow Rate..... | 29 |

| | Page |
|---|------|
| Water and Organic content:..... | 30 |
| Standard Preparation | 31 |
| Sampling Schedule | 33 |
| Gas Chromatograph..... | 34 |
| Samples for IC..... | 34 |
| Residence Time Sampling..... | 35 |
| Ion Chromatograph..... | 35 |
| General Supplies..... | 36 |
| IV. Results..... | 37 |
| Pre PCE Injection Baseline Results..... | 37 |
| Time Series Data Sets..... | 39 |
| PCE Concentration: | 51 |
| TCE Data | 54 |
| TCE and PCE Comparison..... | 56 |
| Sulfate and Nitrate Comparison | 59 |
| Conductivity | 62 |
| Residence Time | 63 |
| V. Discussion | 65 |
| Pre and Post Methane comparison | 66 |
| PCE concentration Decrease | 67 |
| 6 th Week..... | 70 |
| TCE: | 73 |
| Sulfate and Nitrate comparison | 76 |

| | Page |
|---|------|
| Methane and TCE..... | 79 |
| VI Conclusion..... | 83 |
| Answers to specific research questions..... | 83 |
| Limitations..... | 87 |
| Appendices..... | 88 |
| Bibliography..... | 103 |
| Vita | 108 |

List of Figures

| | Page |
|--|------|
| Figure 1.1 PCE is degraded to TCE in a reductive dechlorination reaction | 5 |
| Figure 1.2. PCE reduction pathway | 6 |
| Figure 1.3. Phytoremediation mechanism | 9 |
| Figure 1.4. Constructed wetland with three perforated PVC pipes at the bottom | 11 |
| Figure 1.5. Cross-section of wetland soil layers | 12 |
| Figure 2.1 Redox potential of possible subsurface reactions..... | 17 |
| Figure 2.2 Underground chemical composition change with time | 18 |
| Figure 3.1 Mesocosm placement within greenhouse | 25 |
| Figure 3.5 Experimental set up | 27 |
| Figure 4.1 Background methane concentration pre-PCE injections | 38 |
| Figure 4.2 Average PCE Concentration for first sample set..... | 39 |
| Figure 4.4 Average methane concentration for the first sample set | 41 |
| Figure 4.5 Methane comparison in (mmol/L) pre and post PCE injections | 42 |
| Figure 4.6 PCE comparisons 2 and 4 weeks after continuous PCE injections began | 43 |
| Figure 4.7 TCE comparisons 2 and 4 weeks after continuous PCE injections began | 44 |
| Figure 4.8 PCE data 2 weeks after injections began..... | 46 |
| Figure 4.9 PCE data 4 weeks after injections began..... | 46 |
| Figure 4.10 PCE data 6 weeks after injections began..... | 46 |
| Figure 4.11 TCE data 2 weeks after injections began | 47 |
| Figure 4.12 TCE data 4 weeks after injections began | 47 |
| Figure 4.13 TCE data 6 weeks after injections began | 48 |
| Figure 4.14 Carex comosa methane comparison | 49 |

| | Page |
|--|------|
| Figure 4.15 <i>Scirpus atrovirens</i> methane comparison..... | 50 |
| Figure 4.16 <i>Eleocharis erythropoda</i> methane comparison..... | 50 |
| Figure 4.17 Control methane comparison..... | 50 |
| Figure 4.18 PCE Concentration decrease between ports after 2 weeks..... | 51 |
| Figure 4.19 Cumulative percentage of PCE removed at 2 weeks..... | 52 |
| Figure 4.20 PCE Concentration decrease between ports at 6 weeks | 53 |
| Figure 4.21 Percentage of PCE removed at 6 weeks | 54 |
| Figure 4.22 TCE concentration at 2 weeks..... | 55 |
| Figure 4.23 TCE Concentration 6 weeks after continuous PCE injection began | 56 |
| Figure 4.24 <i>Carex comosa</i> PCE-TCE comparison | 57 |
| Figure 4.25 <i>Scirpus atrovirens</i> PCE-TCE comparison..... | 57 |
| Figure 4.26 <i>Eleocharis erythropoda</i> PCE-TCE comparison | 58 |
| Figure 4.27 Control PCE –TCE comparison | 58 |
| Figure 4.28 Average nitrate concentrations with depth..... | 59 |
| Figure 4.29 Average Sulfate concentrations for all four treatments..... | 61 |
| Figure 4.30 Average conductivity for each treatment | 63 |
| Figure 4.31 KBr breakthrough measurement..... | 64 |
| Figure 5.1 PCE & TCE comparison at week 2. | 69 |
| Figure 5.2 6th week comparison of PCE removal between 0” and 9” | 70 |
| Figure 5.3 6th week PCE concentration decrease between 0” to 54” | 71 |
| Figure 5.4 6th Week PCE removed between 0” and 15”..... | 72 |
| Figure 5.5 Average TCE concentrations from port 7 | 74 |

| | Page |
|--|------|
| Figure 5.6 Overlay of nitrate trend with 6th week TCE concentration | 77 |
| Figure 5.7 Overlay of sulfate trend with 6th week TCE concentration | 78 |
| Figure 5.8 Overlay of Carex comosa reactor methane and TCE concentration | 81 |
| Figure 5.9 Overlay of Scirpus atrovirens reactor methane and TCE concentration..... | 81 |
| Figure 5.9 Overlay of Eleocharis erythropoda reactor methane and TCE concentration.. | 82 |
| Figure 5.9 Overlay of control reactor methane and TCE concentration..... | 82 |

List of Tables

| | Page |
|---|------|
| Table 1.1 . Physical properties of chlorinated solvents | 2 |
| Table 1.2. EPA's MCL and potential health effects of chlorinated solvents | 2 |
| Table 2.1 Delta G of electron ACCEPTOR half cell reactions | 15 |
| Table 2.2 Delta G of electron DONOR half cell reaction..... | 15 |
| Table 3.1 Plant species and number of reactors..... | 24 |
| Table 3.2 Plant and control column placement..... | 24 |
| Table 3.3 Initial PCE injection calibration result..... | 29 |
| Table 3.3 Tubing characteristic and Flow rate..... | 30 |
| Table 3.4 Effluent flow rate calculate over 36 hrs..... | 30 |
| Table 3.5 Water content and organic content of soil. | 31 |
| Table 3.6: Stock solution Prep | 32 |
| Table 3.7 Detection limits on the GC | 34 |

EVALUATION OF CHLORINATED SOLVENT DEGRADATION EFFICIENCY AMONG THREE WETLAND PLANT SPECIES: A MESOCOM STUDY

I. Introduction

Background

Tetrachloroethylene (PCE) and its degradation products: Trichloroethylene (TCE), Dichloroethylene (DCE), and Vinyl chloride (VC), are chlorinated solvents belonging to a class of very persistent and toxic environmental pollutants. They were frequently used after WWII as industrial degreasing and dry cleaning agents (Pankow and Cherry, 1996). However, rampant use and improper disposal have led to widespread contamination (Freedman and Gossett, 1989). Chlorinated solvents enter the environment through dispersive loss during use, improper waste dispersal, and accidental spills (Bouwer, 1992). These chlorinated solvents are DNAPLS, allowing them to sink below the water table to form pools at the bottom of an aquifer (Masters, 1997). These pools of contaminants also have low absolute solubility. PCE for example, has an absolute solubility of around 150 mg/L (Yaws, 2004), which means that pools of chlorinated solvents will persist in groundwater aquifers for decades. However, PCE is just soluble enough to contaminate any surrounding groundwater with concentrations far exceeding EPA's Maximum Contaminant Level (MCL) of just 0.005 mg/L (Johnson and Pankow, 1992). Therefore, these properties make chlorinated solvents a group of very persistent and widespread environmental pollutants (Table 1.1).

The abundance of PCE and TCE in groundwater is of particular concern due to their carcinogenic properties (Fan, 1988). EPA started to regulate chlorinated solvents in

the Safe Drinking Water Act of 1986 (Freedman and Gossett, 1989) and passed maximum contaminant level standards to protect public health while balancing economic feasibility (EPA, 2002). These pollution standards dictate the clean up response of chlorinated solvents and Table 1.2 below lists some of the EPA standards concerning chlorinated ethenes.

Table 1.1 . Physical properties of chlorinated solvents (Yaws, 2004)

| Compound | Density (g/mL) at 25 oC | Solubility (mg/L) | Henry's Const (atm*m ³ /mol) | Log Kow | Vapor Pressure (mm Hg) |
|----------------------------|-------------------------|-------------------|---|---------|------------------------|
| Tetrachloroethylene | 1.613 | 150 | 0.0269 | 3.4 | 17.8 |
| Trichloroethylene | 1.458 | 1,100 | 0.0116 | 2.42 | 57.9 |
| cis-1,2-Dichloroethylene | 1.265 | 3,500 | 0.0074 | 1.86 | 208 |
| trans-1,2-Dichloroethylene | 1.244 | 6,300 | 0.0067 | 2.09 | 324 |
| 1,1-Dichloroethylene | 1.117 | 3,345 | 0.0228 | 2.13 | 600 |
| Vinyl Chloride | 0.903 | 2,697 | 0.0224 | 1.62 | 2,660 |

Table 1.2. EPA's MCL and potential health effects of chlorinated solvents (EPA, 2002)

| Contaminant | MCLG (mg/L) | MCL (mg/L) | Potential Health Effects from Ingestion of Water | Sources of Contaminant in Drinking Water |
|-----------------------------------|-------------|------------|--|---|
| <u>Tetrachloroethylene</u> | zero | 0.005 | Liver problems; increased risk of | Discharge from factories and dry cleaners |
| <u>Trichloroethylene</u> | zero | 0.005 | Liver problems; increased risk of | Discharge from metal degreasing sites and other |
| <u>1-Dichloroethylene</u> | 0.007 | 0.007 | Liver problems | Discharge from industrial chemical factories |
| <u>cis-1,2-Dichloroethylene</u> | 0.07 | 0.07 | Liver problems | Discharge from industrial chemical factories |
| <u>trans-1,2-Dichloroethylene</u> | 0.1 | 0.1 | Liver problems | Discharge from industrial chemical factories |
| <u>Vinyl chloride</u> | zero | 0.002 | Increased risk of cancer | Leaching from PVC pipes; discharge from plastic |

Unfortunately many military sites are in violation of EPA standards. Since 1998, 1400 groundwater contaminants sites were placed on the Nation Priorities List (NPL) and TCE was the most frequently detected chemical on these sites (Lee, 1998). Out of the 1400 installations listed on the NPL, 126 were under the direct responsibility of the DoD (USGAO, 1995). Some examples of DoD installations are current military bases,

decommissioned bases, or storage depots. The total clean up cost for the DoD is estimated to be upwards of \$30 billion (Astin and Sanders, 1996).

Conventional Treatment Methods

Previous chlorinated solvent removal processes involved the use of the “pump-and-treat” method to pump contaminated groundwater to the surface for treatment above ground. This method was similar to conventional drinking water treatment and this methodology had been well documented (EPA, 1996). However, the “pump-and-treat” method has several disadvantages. First, the physical treatments used by this method only concentrate PCE into another medium and does not promote the degradation of PCE. Second, chlorinated solvents are denser than water and have low capillary pressure, thus allowing them to seep into pore spaces along the bottom of an aquifer. The seepage into pore spaces reduces the availability of contaminants and increases the duration of cleanup to decades, possibly even centuries (Pankow and Cherry, 1996). Finally, above ground treatment facilities are expensive to construct and have continual high operating and maintenance cost throughout the lifetime of the cleanup (Vogel, 1998).

Other soil and groundwater treatments includes soil venting, in which clean gas are pumped into the contaminated subsurface. Afterwards, these gases become laden with chlorinated solvents and are then vented into the atmosphere. This method takes advantage of the high vapor pressure of chlorinated solvents to transfer contaminants from a liquid to a gaseous phase (Russell, 1992). But volatilization is another cause for concern because of the carcinogenic properties of gaseous chlorinated compounds (Lyngge et al, 1997). Other treatments included soil excavation, surfactant flushing, and thermal treatments (EPA, 2004). However these methods still only convert chlorinated solvents

into a different medium and require additional contaminant processing. A much more economic and efficient solution would be the complete destruction of chlorinated solvents.

Bioremediation

Due to the need for cost effective treatment technology that could remediate contaminated sites to the standards set forth by EPA, bioremediation has become a viable alternative to conventional treatment methods. This method encourages the growth of indigenous or introduced microorganisms in the subsurface to metabolically facilitate the complete degradation of potential contaminants. Biodegradation of chlorinated solvents was first seen in 1980 at a Palo Alto groundwater recharge project (Bouwer and McCarty, 1983); subsequent laboratory studies showed that chlorinated products could be degraded under both anaerobic and aerobic conditions (Freedman and Gossett, 1989; Wilson and Wilson, 1985, Lee et al, 1998).

Field studies have also shown that aquifers have a number of indigenous microbial populations with a carrying capacity of around 10^6 - 10^7 microorganisms per gram of dry soil (Bouwer, 1992). ATP extraction also indicates that around 10% of the cells in the subsurface are metabolically active (Bouwer, 1992). These microorganisms are from three main groups: prokaryotes, eukaryotes, archeabacteria. Each group has its own particular niche within the subsurface but the two most important classes of microbes, for bioremediation, appears bacteria and archeabacteria (Chapelle, 1993).

Under anaerobic conditions, bacteria obtain energy by conducting a reductive dechlorination reaction where chlorinated solvents combine with hydrogen to produce a less chlorinated product. This reaction uses highly chlorinated chemicals as electron

acceptors and introduces a hydrogen atom to replace a chlorine atom in the compound (see Figure 1.1). Figure 1.2 below shows how PCE can be sequentially degraded into TCE, DCE, VC, and ethylene through reductive dechlorination (Vogel and McCarthy, 1985; Freedman and Gossett, 1989).

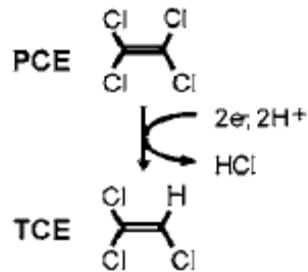

Figure 1.1 PCE is degraded to TCE in a reductive dechlorination reaction (Schmit and Vos, 2004)

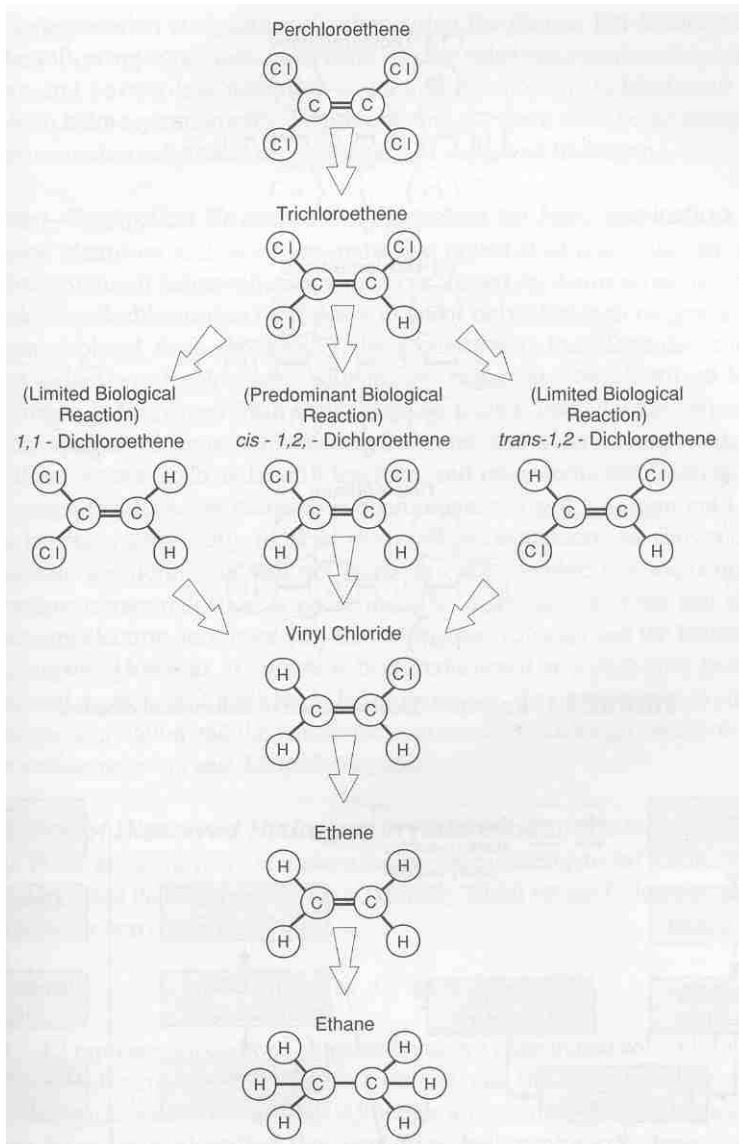

Figure 1.2. PCE reduction pathway (Wiedemeier et al., 1999).

However, the rate of reductive dechlorination decreases as the number of attached chlorine atom decrease (Bouwer, 1993). So PCE, being saturated with four chlorine atoms, is a good electron acceptor and is readily degraded. TCE, with three chlorine atoms is also a good candidate for reductive dechlorination (Bouwer, 1993). VC, with only one chlorine atom attached, becomes the rate limiting step and could lead to a possible accumulation of VC in the subsurface (Chapelle, 1993).

Bacteria can also aerobically degrade chlorinated solvents through a co-metabolic process. During this reaction, bacteria did not gain any energy from the degradation. Instead contaminants were fortuitously degraded as bacteria produced an enzyme used for methane or ammonia oxidation (Wilson and Wilson, 1985; Yang et al. 1999). Studies have found that these methanotrophic bacteria, in the presence of methane, could fortuitously degrade chlorinated compounds such as TCE, DCE and VC into non-chlorinated products (Eguchi et al, 2001, Little et al, 1988). However this reaction was best for degrading less chlorinated compounds such as VC, DCE and TCE. Fully chlorinated PCE was not shown to degrade at all under co-metabolic conditions (Fogel et al., 1986). The rate of co-metabolic chlorinated solvent degradation was fastest for VC and slower for DCE and TCE (Bouwer, 1992).

Bioremediation has great potential for contaminate cleanup. However, anaerobic degradation is efficient at degrading highly chlorinated compounds, while aerobic degradation is efficient at degrading less chlorinated compounds. A better clean up solution would be to combine both degradation processes to take advantage of their respective benefits.

Phytoremediation

Phytoremediation in wetlands could be one solution allowing combined aerobic and anaerobic contaminate clean up (Lorah and Olsen, 1999, Lee et al, 1998). This process uses plants in the treatment of contaminated soils and could be a viable *in-situ* treatment to promote sequential anaerobic and aerobic microbial degradation (Cunningham, 1997). In the subsurface, plant roots interact with surrounding soil and forms a zone called the rhizosphere. Roots extrude photosynthetic products such as

amino acids, sugar, and vitamins into the rhizosphere (Walton, 1994). These products may serve as substrates to stimulate microbial facilitated degradation (Schnoor, 1995). In the process it has also been found that wetland plants possess a specialized gas transport tissue, called aerenchyma, used during oxygen transport to roots (Armstrong et al, 2000). However, some oxygen escapes and radially diffuses from the root into the surrounding rhizosphere, creating a zone of aeration millimeters wide surrounding the plant root (Armstrong et al, 2000; Bankston, 2002). The result is that an aerobic gradient is created within the rhizosphere and elsewhere the soil remains anaerobic. suggesting the potential for sequential anaerobic then aerobic chlorinated solvent degradation. Highly chlorinated contaminates, such as PCE & TCE, could be degraded in the anaerobic regions through reductive dechlorination (Vogel and McCarthy, 1985). Less chlorinated products of this reaction, such as DCE & VC, could diffuse into the aerated zones along the rhizosphere to be further degraded during co-metabolic reactions.

Some other mechanisms of phytoremediation include phytoextraction, phytodegradation, phytostabilization and phytovolatilization (Lunney, 2004). Phytoextraction is the process in which plants extract pollutants and degraded them by phytodegradation or incorporate them into plant biomass thru phytostabilization. Finally pollutants could be volatilized into the atmosphere through phytovolatilization (Lunney, 2004).

Plants could be used in many on-site remediation efforts of shallow aquifers and contaminated soil. They have been suited for degrading toxic organic contaminates such as benzene and chlorinated solvents or for accumulating inorganic heavy metals in plant

roots and shoots (Schnoor et al, 1995). Figure 1.3 below summarizes the phytoremediation mechanisms at work.

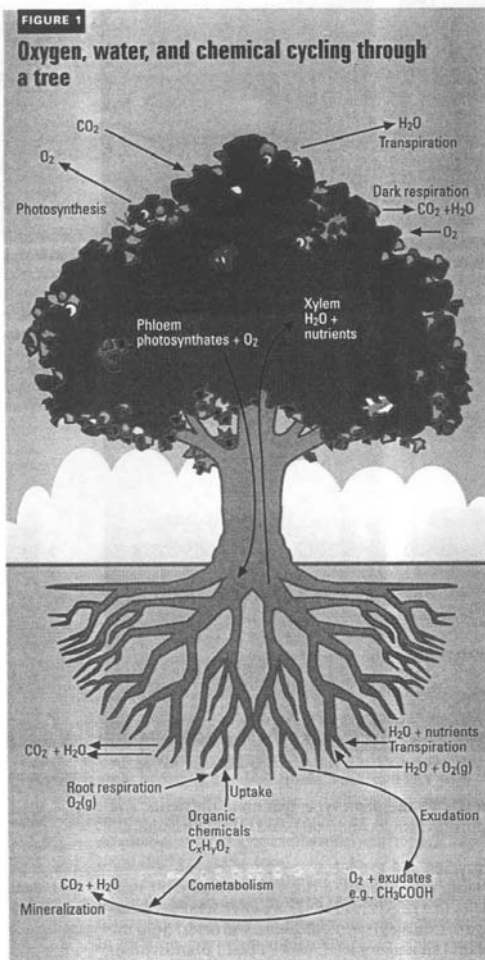

Figure 1.3. Phytoremediation mechanism (Schnoor et al, 1995)

Wetlands

Lorah and Olson in 1995 conducted a microbial study of a natural groundwater fed wetland at Lauderick Creek near the TCE contaminated sites of the Aberdeen Proving Ground (Lorah and Olson, 1999). TCE and tetrachloroethane (PCA) were shown to be degraded with subsequent increase of degradation products such as DCE and VC (Lorah and Olson, 1999). However these daughter products were soon degraded as well and not detectable at the surface (Lorah and Olson, 1999). Later, in 2003, Lorah and Voytek showed that dehalorespiration and methanogenic microbial populations were present in subsurface of these wetlands (Lorah and Voytek, 2003).

The observations by Lorah and Olson showed that it might be feasible to use wetlands for phytoremediation. In August 2002, constructed wetlands were built at Wright-Patterson AFB to conduct further studies. The constructed wetlands were modeled after natural upward flowing fens (Amon et al, 2002). Fens are a type of wetland fed by upward flowing groundwater source. The groundwater is recharged nearby at an area of higher elevation and it is discharged into fens where the groundwater flow reaches the surface (Amon et al. 2002). During phytoremediation contact with root surface is essential (Van der Lelie, 2001) and a fen wetland provides contaminated groundwater with significant root surface contact area and contact time (Amon, personal comm. 2005).

The constructed wetlands cells were built over an aquifer contaminated with PCE. Water was pump from the same aquifer and fed into the wetland. The cells were approximately 120 feet long, 60 feet wide, with an impermeable liner at 6 feet depth (Clemmer, 2003). Contaminated groundwater are pumped from an underground aquifer

and enters the wetland through three-inch diameter perforated PVC pipes, which are enclosed in a nine inch gravel layer, at the bottom of the constructed wetland (see Figure 1.4) (Clemmer, 2003). This configuration allows groundwater to enter the wetland in an upward flow schematic similar to fens. Above the gravel layer is 18 inches of 10% wood chip and hydric soil mix (Clemmer, 2003). The wood chips provide an organic carbon energy source for the microbes (Chapelle, 1993) and the hydric soils are very similar to local wetland soils with silt and clay inclusions (Amon et al, 2006 unpublished). Finally, 36 inches of wetland hydric soil are placed on top (see figure 1.5). Sampling tubes are set at depths of 9, 27, and 44 inches below the surface. The exit weir is located across from the inlet pipe and could be used to control water levels in the wetland (Clemmer, 2003). A study by Soboleweski (2004) has showed a 90% PCE degradation in the constructed wetland and subsequent increase in daughter products such as TCE, DCE and vinyl chloride.

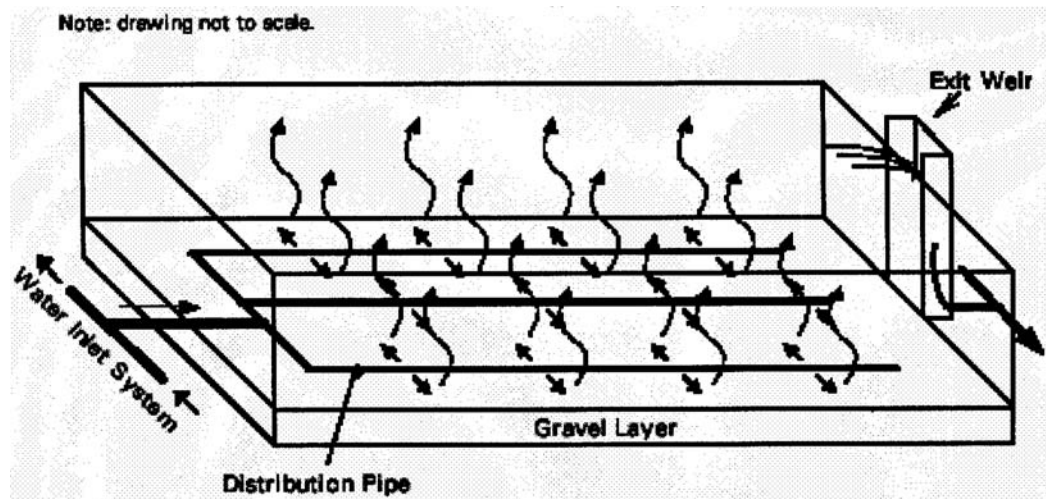

Figure 1.4. Constructed wetland with three perforated PVC pipes at the bottom (Clemmer, 2003)

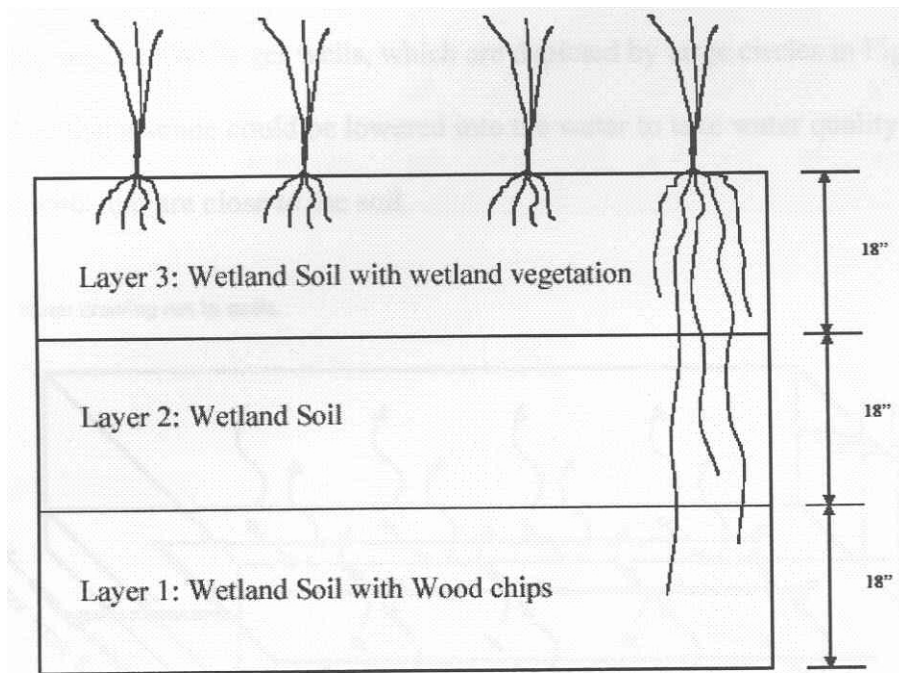

Figure 1.5. Cross-section of wetland soil layers (Sobolewski, 2003)

Many species of local wetland plants were planted in the constructed wetland. The plants were laid down in a grid pattern to determine which species might be most suitable for the treatment of PCE (Amon, person comm, 2005). Some plants such as *Eleocharis erythropoda* have the potential of being a good choice for remediation due to its large and deep root mass. Other plants such as *Carex comosa* and *Scirpus atrovirens* have broad leaves that are capable of volatilizing contaminants. However no studies have been done to compare treatment efficiencies among different plants.

Problem Statement

Studies have shown the effectiveness of phytoremediation at degrading chlorinated solvents (Bankston, 2002; Schnoor, 1995; Lelie, 2001). However, plant species have a variety physical property such as: exudates quality, exudates concentration, plant metabolism, root adsorption surface area, root morphology, leaf size,

temperature tolerance and toxic compound tolerance (Shann and Boyle, 1994). When studies use a consortium of plants, difficulties often arise in characterizing the remediation efficiency of individual plants. For example at the constructed wetland at WPAFB, numerous plant species were planted in separate plots but they soon became mixed due to natural reseeding processes (Amon, personal comm. 2005).

Research Objective and Hypothesis

Different plants species need to be studied individually to compare the remediation efficiency of each species. This research studied three different wetland plants species and an unplanted control, under a laboratory setting. Each plant had a different characteristic favorable for chlorinated solvent degradation. *Eleocharis erythropoda* (Spike Rush) has thin tube like leaves and large root mass. *Carex comosa* (Bearded Sedge) has broad leaves and *Scirpus atrovirens* (Green Bulrush) is broad leafed wetland plant with a long flowering stem during reproduction. PCE will be injected into the plant mesocosm and any possible PCE degradation will be observed. The hypothesis is that PCE will be degraded into daughter products in all the mesocosms; however, the question will be which plant is the most efficient at chlorinated solvent degradation and is there difference between the planted reactors and the control reactors?

Research Question

1. Are there significant differences in the chlorinated solvent removal among the plant species and the unplanted control treatment?
2. Is there a difference in sulfate, nitrate and methane concentration among the mesocosm?
3. Do the sulfate, nitrate, and methane concentration influence PCE degradation?

II. Literature Review

Natural Attenuation

Natural attenuation is the observed reduction in contaminate concentration as it migrates in the subsurface. The concentration reductions are due to the processes of dilution, dispersion, sorption, volatilization, and biotic transformation (Wiedemeier et al., 1999). Degradation mechanisms such as sorption, volatilization, and dispersion are nondestructive and only decrease the contaminant concentrations but not the contaminant mass. However, biodegradation degrades contaminants into harmless components and is the most important attenuation mechanism in the reduction of contaminant mass and concentration (Wiedemeier et al., 1999).

Thermodynamics

To better understand biodegradation, it would be helpful to first understand the thermodynamic principals behind subsurface biological reactions. All biological reactions are constrained by the laws of thermodynamics. One of the biological reactions used during subsurface contaminate degradation is biologically mediated electron transfer during oxidation-reduction reactions (Wiedemeier et al., 1999). This reaction results in the oxidation of an electron donor and reduction of an electron acceptor to release energy. The energy produced can be quantified in terms of Gibbs free energy (ΔG_r^o), which is the maximum useful energy change for a chemical reaction at standard state (Zumdahl, 1997). The amount of energy available is dependent on the electron acceptor and donors used during the reaction. Table 2.1 and 2.2 below provides some examples of Gibbs free energy (Wiedemeier et al., 1999), calculated for electron acceptor half reactions and electron donor half reactions.

Table 2.1 Delta G of electron ACCEPTOR half cell reactions (Wiedemeier et al., 1999)

| Half-Cell Reaction | ΔG_r° (kcal/mol e ⁻) |
|---|--|
| $4e^- + 4H^+ + O_2 \Rightarrow 2H_2O$ Aerobic respiration | -18.5 |
| $5e^- + 6H^+ + NO_3^- \Rightarrow 0.5N_2 + 3H_2O$ Denitrification | -16.9 |
| $e^- + Fe^{3+} \Rightarrow Fe^{2+}$ Fe(III) reduction | -17.8 |
| $8e^- + 9.5H^+ + SO_4^{2-} \Rightarrow 0.5HS^- + 0.5H_2S + 4H_2O$ Sulfate reduction | 5.3 |
| $8e^- + 8H^+ + CO_{2,g} \Rightarrow CH_{4,g} + 2H_2O$ Methanogenesis | 5.9 |
| $C_2Cl_{4,g} + H^+ + 2e^- \Rightarrow C_2HCl_3 + Cl^-$ PCE reductive dechlorination | -9.9 |
| $C_2HCl_3 + H^+ + 2e^- \Rightarrow C_2H_2Cl_2 + Cl^-$ TCE reductive dechlorination | -9.6 |
| $C_2H_2Cl_2 + H^+ + 2e^- \Rightarrow C_2H_3Cl + Cl^-$ <i>cis</i> -DCE reductive dechlorination | -7.2 |
| $C_2H_3Cl + H^+ + 2e^- \Rightarrow C_2H_4 + Cl^-$ VC reductive dechlorination | -8.8 |

Table 2.2 Delta G of electron DONOR half cell reaction (Wiedemeier et al., 1999).

| Half-Cell Reaction | ΔG_r° (kcal/mol e ⁻) |
|---|--|
| $1/2H_2 \Rightarrow H^+ + e^-$ Hydrogen oxidation | -9.9 |
| $1/4CH_2O + 1/4H_2O \Rightarrow 1/4CO_2 + H^+ + e^-$ Carbohydrate oxidation | -10.0 |
| $4H_2O + C_2H_2Cl_2 \Rightarrow 2CO_2 + 10H^+ + 8e^- + 2Cl^-$ DCE oxidation | -16.1 |
| $4H_2O + C_2H_3Cl \Rightarrow 2CO_2 + 11H^+ + 10e^- + Cl^-$ Vinyl chloride oxidation | -11.4 |

A negative Gibbs free energy means that the reaction is exothermic and will proceed from left to right as shown on the tables above. Notice how aerobic respiration has the greatest ΔG_r° allowing bacteria specializing in aerobic respiration to out compete most other bacterial species if supplies are readily available (Bouwer, 1992).

If oxygen is limited, such as in underground aquifers, other electron acceptors such as nitrate, iron (III), sulfate, Mn(IV) PCE, TCE, and CO₂ can be used (Mitsch,

1993). However, none of these electron acceptors are as efficient as oxygen and in turn have a smaller ΔG_r° .

From the definition above, the ΔG_r° in Table 2.1 and 2.2 represents the maximum energy gained under ideal conditions and with free electron donors readily available. However, in the subsurface environment, electron donors are not readily available and microorganisms need to couple both oxidation and reduction half reactions to carry out the whole oxidation-reduction reaction. When two half reactions are combined the ΔG_r° of the two reactions are summed. The reaction will occur in nature only if the sum of the ΔG_r° results in a net energy gain (Wiedemeier et al., 1999).

One method to predict whether a reaction will occur is to examine the oxidation-reduction potential or redox potential of the groundwater and then compare it to the redox potential of a chemical reaction. Redox potentials or E_h° is measured in mV and ranges from -400 to 800mV. A high redox potential represents oxidizing zones containing high concentrations of electron acceptors, whereas a low redox potential represents reducing zones with a low concentration of electron acceptors. Most subsurface chemical reactions have a preferential redox range for reactions to take place (Mitsch, 1993). For example, Figure 2.4 below shows that oxygen and nitrate reduction occurs in high redox potential zone with an E_h° at +820mV. Using oxygen and nitrates as electron acceptors generates a high energy yield and those microorganisms are able to compete for resources in oxidizing environments with high concentrations of the electron acceptors. On the other hand, optimum reductive dechlorination occurs in sulfate and CO_2 redox zones with E_h° around -220mV. Reductive dechlorination of PCE does not generate a high energy

yield and highly reducing conditions are needed before reductive dechlorination could take place (Bouwer, 1992).

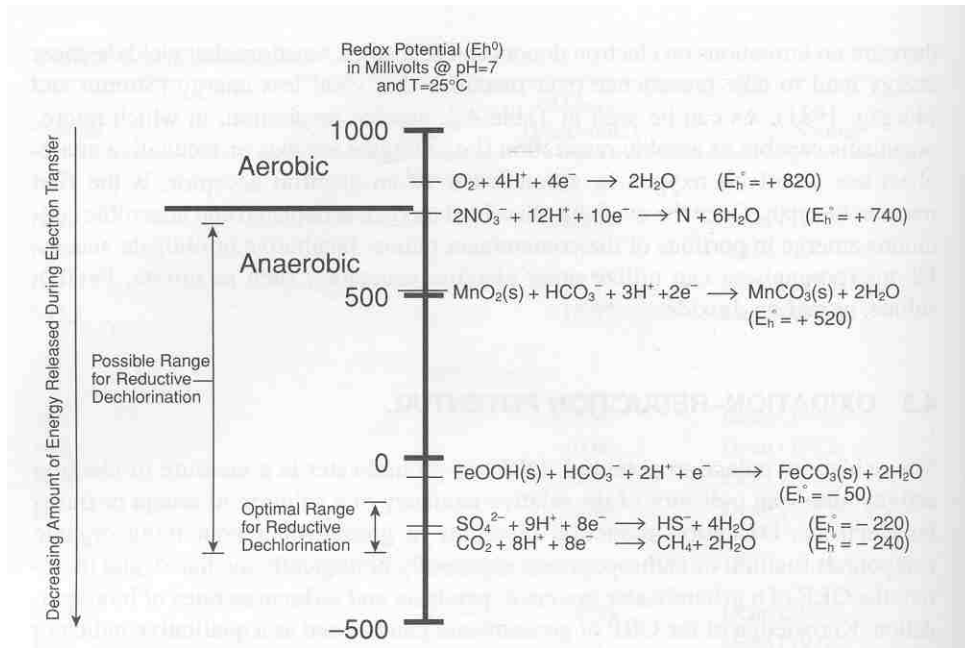

Figure 2.1 Redox potential of possible subsurface reactions (Wiedemeier et al., 1999).

Bacteria are adapted to utilizing different electron acceptors during subsurface redox reactions and the goal of the redox reactions is to produce energy needed for cell growth. Based on thermodynamic principals, microorganisms would preferentially use oxygen and nitrate, because using these electron acceptors allow for a greater Gibbs free energy gain when compared with PCE. This process of utilizing the redox reaction with the greatest energy gain eventually changes the underground chemical composition and Figure 2.5 below shows the succession of underground chemical composition over time (Mitsch, 1993). This change in geochemistry is facilitated by microbes and an analysis of electron donor and electron acceptor in the subsurface could provide an indicator of what type of microbial population is present (Bouwer, 1992; Chapelle, 1993). So in an anaerobic environment, optimized PCE and TCE dechlorination will occur only if

competing electron acceptors with high energy yields are depleted and the subsurface environment becomes highly reductive.

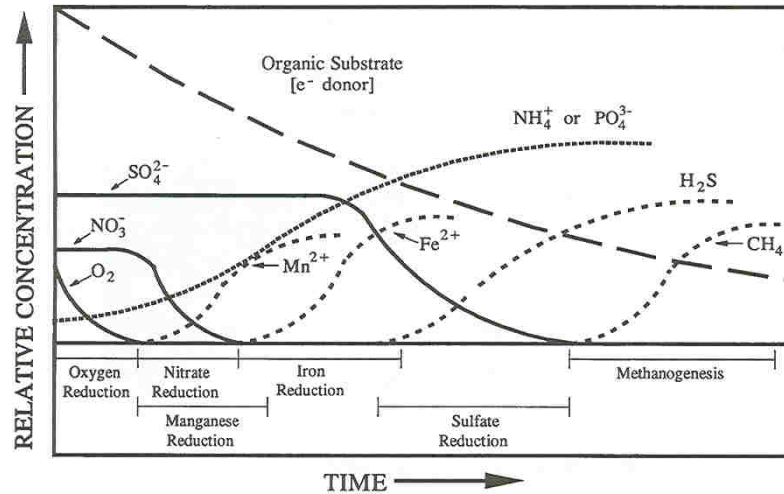

Figure 2.2 Underground chemical composition change with time (Mitsch, 1993)

Bioremediation

However, chlorinated solvent bioremediation is complex and several distinct bacterial communities may be needed for successful chlorinated solvent mineralization. Therefore it would be helpful to understand the chemical reactions that facilitate biotic degradation. The two main reactions used during biotic chlorinated solvent degradation are co-metabolic reactions and reductive dechlorination (Chapelle, 1993).

Under aerobic conditions co-metabolic chlorinated solvent degradation is possible (Wilson and Wilson, 1985; Little et al., 1988, Eguchi, 2001). During co-metabolic reactions bacteria produce monooxygenase enzymes that degrades methane or ammonium in the presence of oxygen (Yang et al., 1999). This reaction is used to generate energy and gain the carbon needed for bacteria growth and survival. Studies by Wilson and Wilson, showed that monooxygenase was a non-specific enzyme and could fortuitously degrade chlorinated contaminants along with the primary substrate. Later research

revealed that methanotrophic bacteria, such as *Methylococcus capsulatus*, used monooxygenase to degrade TCE, DCE, and VC into carbon dioxide (Fogel, 1986).

However co-metabolic degradation is best for degrading low chlorinated compounds such as VC and DCE. While TCE was shown to have some degradation and fully chlorinated PCE was not shown to degrade at all (Bouwer, 1992). Another limitation is that co-metabolic degradation will only proceed in the presence of methane and oxygen (Fogel, 1986). Yetbiotic methane generation occurs in highly anaerobic conditions and very limited amounts of methane are present in an aerobic environment. Therefore, the conditions necessary to carry out co-metabolic reactions typically do not occur in a natural environment and need to be engineered (Wiedemeier et al., 1999).

Under anaerobic conditions, bacteria could obtain energy by conducting Reductive Dechlorination Reactions (RDR), where chlorinated solvents react with hydrogen to produce a less chlorinated product. This reaction uses highly chlorinated compounds as electron acceptors and introduces a hydrogen atom to replace a chlorine atom in the compound (Vogel and McCarthy, 1985; Freeman and Gossett, 1989).

Fermentation products (lactate, methanol) and man-made chemicals(toluene) have been used to stimulate RDR (Freedman and Gossett, 1989). However, those compounds appears to be indirect electron donors that will produce dissolved hydrogen through further fermentation (Wiedemeier et al., 1999). Dissolved hydrogen is a high energy electron donor consumed by a wide variety of subsurface bacterial species (Wiedemeier et al., 1999). It is used by methanogens, nitrated reducers, sulfate reducers, and iron reducers (Wiedemeier et al., 1999). It is also the main electron donor used in anaerobic reductive dechlorination reactions (Wiedemeier et al., 1999). Subsurface

bacteria may utilize a variety of electron acceptors but they all compete for the limited amount of electron donor in the subsurface.

In a wetland, oxygen is frequently in limited supply (Mitsch, 1993). Some plants could diffuse oxygen into the soil but the gradient of aeration may only be a few millimeters thick (Bankston, 2002; Armstrong, 2000). However, many bacteria are adapted to carry out reduction reactions under anaerobic conditions (Freeman and Gossett, 1989). Each reduction reaction has a redox potential, depending on the type of terminal electron acceptor available. Chlorinated compounds are fairly electronegative and could be a good electron acceptors during reduction reactions (Smidt and Vos, 2004). One study showed that methanogenic conditions produce a favorable environment for microbes to use PCE as electron acceptors (Vogel and McCarty, 1985). In this reaction a chlorine atom is replaced by a hydrogen atom and PCE is sequentially transformed into TCE, DCE, and VC (Vogel and McCarty, 1985). Reductive dechlorination progresses rapidly for highly chlorinated compounds but as the number of attached chlorine atom decreases the reaction slows down and the final dechlorination of vinyl chloride is the rate limiting step (Freedman and Gossett, 1989). Therefore vinyl chloride, a carcinogenic substance, (Lynge et al, 1997) has been found to accumulate during reductive dechlorination (Freedman and Gossett, 1989). But a later study showed that refined methanogenic bacterial cultures that were acclimated to the subsurface environment could fully dehalogenate PCE to ethylene if sufficient electron donors were available (Smidt and Vos, 2004).

Currently studies have been focused at identifying the bacteria that could fully metabolize chlorinated solvents and a group of halorespiring bacteria (HRB) has been

found to readily metabolize chlorinated solvents into harmless byproducts. These bacteria rely strictly on halorespiration and use hydrogen as the electron donor (Smidt and Vos, 2004). One genus in this group, *Dehalococcoides*, is able to fully dehalogenate PCE into ethane in a four step process (Smidt and Vos, 2004).

Bioremediation offers great potential for chlorinated solvent clean up. However, highly chlorinated species like PCE degrade rapidly under anaerobic conditions and less chlorinated species like DCE or VC are more readily degraded in an aerobic environment (Lee et al, 1998). An more efficient degradation process is needed to combine both anaerobic and aerobic degradation.

Phytoremediation

Phytoremediation is a subset of bioremediation and it uses plants in the treatment of contaminated soils, sediments, and water. Phytoremediation could be a viable in-situ treatment option to promote sequential anaerobic and aerobic microbial degradation (Cunningham, 1997). Some wetland plants could transport oxygen into the rhizosphere (Bankston, 2002; Armstrong, 200) and provide an aerobic gradient along the rhizosphere for co-metabolic chlorinated solvents degradation to take place. The rhizosphere is a specialized region of root and microbe interaction, with organic substrate and oxygen to support a microorganism community up to 100 times more abundant than non-vegetated soils (Walton, 1994). However the dimension of this zone of interaction is dependent on plant species. Competition from aerobic bacteria quick deplete any oxygen diffused by the plants (Walton, 1994) and soil just few millimeters away from the rhizosphere could be anaerobic. This is advantageous in chlorinated solvent remediation because anaerobic microbes could reductively dechlorinate PCE under methanogenic conditions (Vogel and

McCarthy, 1985). However, the rates of dechlorination under anaerobic conditions are slow (Crowley, 1997) and only specialized *Dehalococcoides* grown in labs could fully degrade PCE to ethane (Smidt and Vos, 2004). PCE daughter products not degraded under reductive dehalogenation could possibly be transported to the rhizosphere. There aerobic microbes could proceed to degrade PCE daughter products such as TCE, DCE, and VC into ethylene, methane or carbon dioxide (Wilson and Wilson, 1985; Fogel, 1985).

Plants also release organic carbon such as amino acids, vitamins, and sugars into the root rhizosphere (Walton, 1994) to further stimulate microbial degradation (Schnoor, 1995). This sequential anaerobic and aerobic bioremediation involves microbial interaction within the subsurface. But EPA studies have shown that plant themselves could also directly extrude contaminate degrading enzymes such as dehalogenase, nitroreductase, peroxidase, lactase, and nitrilase (Schnoor, 1995). Plants could also directly uptake pollutants. But direct uptake is dependent on three factors: the physicochemical properties of the compound, environmental conditions, and plant characteristics (Cunningham, 1997). Chemical properties, such as water solubility and octanol-water partition coefficient, are important in the determining the availability of the pollutant. For example, contaminant uptake studies using poplar trees have showed that a moderately hydrophobic organic chemical with Log Kow= 0.5-3 could be taken up and translocated to above ground tissues (Schnoor, 1995). The environmental conditions are also important. For example soil with concentrated ferrous iron content could be oxidized into insoluble ferric iron from oxygen in the rhizosphere. Ferric iron then coats the root surface and prevents the uptake of pollutants (Mitsch, 1993). Finally plant

characteristics are important as well because root surface area could significantly affect adsorption rate. Roots with numerous root hairs would have a higher surface area to absorb pollutants (Cunningham, 1997). Once the chlorinated solvents are taken up into the plant biomass, they undergo hydroxylation and glycosilation to change them into more soluble forms (Cunningham, 1997). These pollutants are then sequestered into plant cytoplasm or cell wall matrix.

The amount of pollutant degradation can be highly dependent on the species of plants used for remediation (Shann and Boyle, 1994). Many different type of growth properties exist such as: exudates quality and amount, plant metabolism, root adsorption characteristic and morphology, leaf size, temperature tolerance and toxic compound tolerance. So choosing the right species fit to degrade a particular type of contaminate is very important in developing a phytoremediation treatment plan (Shann and boyle, 1994)

III. Methods

Column Construction

My study was designed to examine three different wetland plant species and an unplanted control mesocosm subjected to continuous injection of low concentrated PCE solutions. In order to study individual plant species, twelve PVC column reactors were built to replicate the constructed wetland. Each column had an upward flowing ground water scheme similar to both the WPAFB constructed wetland and a natural fen wetland. The columns were divided into three mesocosm and each mesocosm was planted with one wetland plant species. A fourth mesocosm was set aside and reserved as a control with no plants. Each reactor was then randomly placed along a glass wall within a greenhouse. See table 3.1 and 3.2 for a list of reactors and plant species. Figure 3.1 shows a picture of the actual column setup within the greenhouse.

Table 3.1 Plant species and number of reactors

| | | | |
|---------------------|---------------------------|-------------------------------|------------|
| <i>Carex comosa</i> | <i>Scirpus atrovirens</i> | <i>Eleocharis erythropoda</i> | Control |
| 2 reactor | 4 reactors | 3 reactors | 3 reactors |

Table 3.2 Plant and control column placement

| Reactor | Plant species | Reactor | Plant species |
|---------|-------------------------------|---------|-------------------------------|
| 1 | <i>Carex comosa</i> | 7 | <i>Eleocharis erythropoda</i> |
| 2 | <i>Carex comosa</i> | 8 | Control |
| 3 | Control | 9 | <i>Scirpus atrovirens</i> |
| 4 | <i>Eleocharis erythropoda</i> | 10 | <i>Eleocharis erythropoda</i> |
| 5 | <i>Scirpus atrovirens</i> | 11 | Control |
| 6 | <i>Scirpus atrovirens</i> | 12 | <i>Scirpus atrovirens</i> |



Figure 3.1 Mesocosm placement within greenhouse

The reactors were built to approximate the dimensions found at the WPAFB constructed wetland and the plant species were chosen to simulate the WPAFB wetlands. Figure 3.2 – 3.4 shows a schematic of the column reactors, sampling port and sampling port placements. The reactors were constructed from 6” diameter PVC pipes 60” in height, with an internal volume of 0.9817 ft³ or 27.7 L. Along the sides of the columns, 1/2” soil extraction and water sampling ports were drilled. An influent port was located on bottom of the reactor and 7 sampling ports were placed along the length of the reactors. Ports 1- 4 were located on bottom half of the reactors and spaced 6 inches apart. Ports 5 – 7 were located along the upper half of the reactor and spaced 9 inches apart. Each sampling port consisted of a 1/2” diameter PVC pipe 5.5 inches long. The sampling pipes were perforated with slits 3/4” apart to allow water to flow through the pipes. Inside the sampling pipe, a 3/4” diameter polyethylene tube 4 inches long was inserted

half way into the sampling pipe. This was connected to a Fisher 3-way valve to allow for sampling. Each sampling pipe was placed 30 degrees apart along the circumference of the column. This placement was necessary to avoid channeling within the soil. Finally an outflow port was placed 6 inches above port 7 to allow the out flow of excess water.

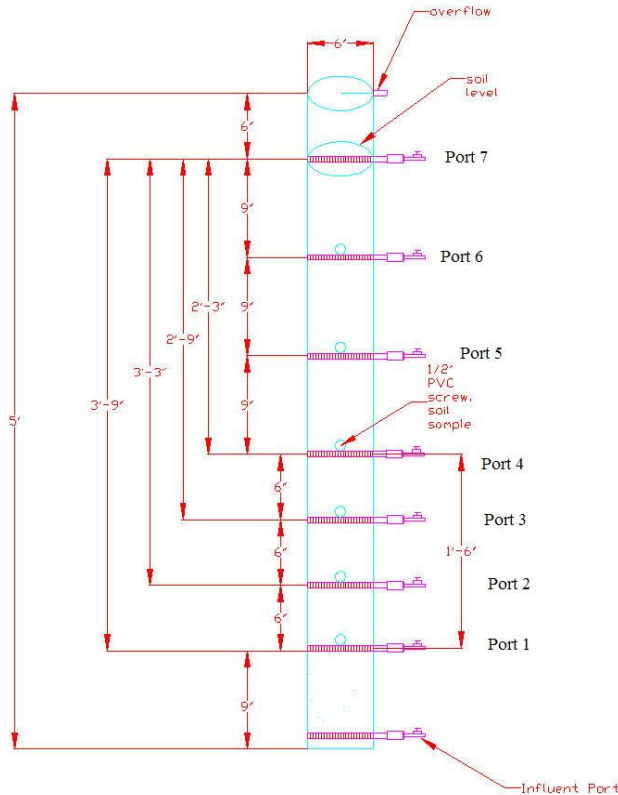

Figure 3.2 Column schematic with dimen

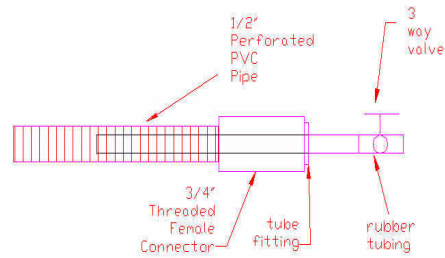

Figure 3.3 Sampling tube schematic

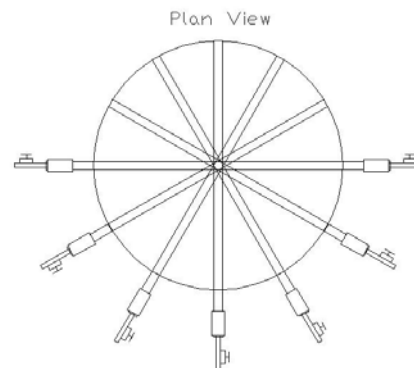

Figure 3.4 Sampling port placement

Water was distributed as shown on Figure 3.5. Pure distilled water could leach ions out of the soil in the mesocosm. So water in the reservoir was filled every three days using 50% tap water and 50% distilled water. Water was pumped into the column reactors using 2 Cole-palmer masterflex peristaltic L/S pumps (Cole Palmer, Vernon

Hills, IL). Each pump was connected to six column reactors and the pump rate was maintained 2.0 mL/min throughout the experiment. An 8 channel, 3 roller, pumphead, with 6 standard small cartridges was attached to each pump and used to distribute the water to columns. A KDScientific model 100 syringe pump and a 300mL mixing chamber were placed between the pump and reservoir to allow for PCE injection into the columns. Water was drawn from the mixing chamber and pumped through a manifold in an effort to ensure equal flow into all of the columns. The water was then delivered to each column using a transparent Nalgen FEP Teflon tubing with 1/8" I.D. Figure 3.5 below shows the setup used during the experiment.

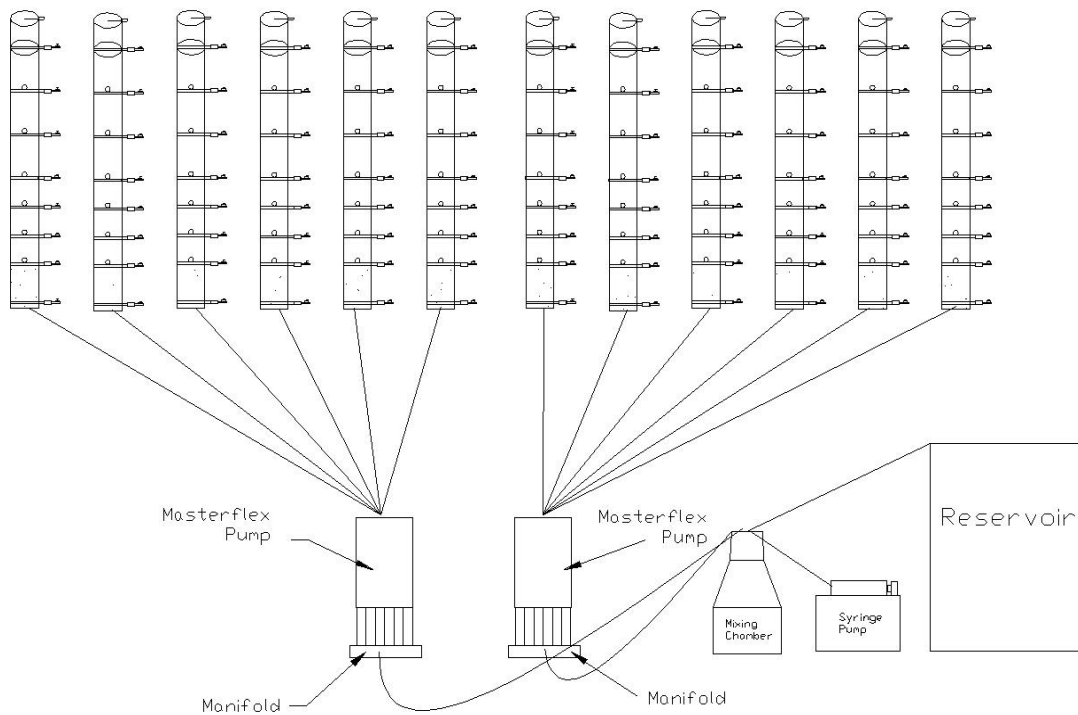

Figure 3.5 Experimental set up

Planting Timeline

Each column reactor has 6 inches of pea gravel placed along the bottom. The soil substrate used in the columns consisted of hydric soils from taken from the Beaver creek wetlands. On May 20th, approximately 325 liters of soil was inoculated with one top to bottom core sample from the WPAFB's constructed wetland. The core sample was 7.5 cm in diameter and ran the entire depth of the constructed wetland. This was done to try to populate the greenhouse mesocosms with microbial species that was already present in the constructed wetland. The soil substrate was then mixed to homogenize the soil and filled into the columns. On May 24th, wetland plants were transplanted into the reactors and allowed approximately 3 month to overcome the shock of transplanting and to acclimate to the new habitats within the columns. The primary purpose of this development period was to promote the growth of the root systems shown to be important during plant assisted PCE degradation (Walton, 1994).

Syringe Pump Injection Rate

The injection rate and stock PCE concentration was experimentally calibrated on September 20, 2006 to achieve the desired PCE concentration of around 50 ppb for injection into the column reactors (see Table 3.3). The syringe pump holds a 50cc Hamilton Gastight Teflon plunger syringe (Hamilton, Reno, NV) and injects a 100 ppm stock PCE solution into the mixing chamber. In Table 3.3 below, two samples were taken from the influent port of column 2 and 10 and measured twice on the GC to determine their PCE concentration. Samples were taken when the syringe pump was injecting at rate of 1ml/hr, 1.2 mL/hr, and 1.4 mL/hr. In end a syringe pump injection

rate of 1.6 mL/Hr was used throughout the experiment to ensure that the PCE concentration pumped into the columns did not fall below 50 ppb.

Table 3.3 Initial PCE injection calibration result

| 1 ml/Hr syringe pump injection rate. | | 1.2 ml/Hr syringe pump injection rate. | | 1.4 ml/Hr syringe pump injection rate. | |
|--------------------------------------|----------------|--|----------------|--|----------------|
| Port | PCE Conc (ppb) | Port | PCE Conc (ppb) | Port | PCE Conc (ppb) |
| 2 IFF | 25.60436 | 2 IFF | 31.57188 | 2 IFF | 53.72962 |
| 2 IFF | 23.6021 | 2 IFF | 31.54772 | 2 IFF | 45.92896 |
| 10 IFF | 31.36048 | 10 IFF | 41.53788 | 10 IFF | 58.870868 |
| 10 IFF | 30.38502 | 10 IFF | 38.40916 | 10 IFF | 54.95272 |

Inflow Rate

A flow rate measurement was conducted on September 21, 2005 by measuring the bubble velocity within a tube. As stated above in the column construction section, each column was connected to the pump using a transparent Teflon tubing with an 1/8" ID. While the column was connected to the pump, a 30 cm section of the tubing was marked off and the time it took for a bubble to traverse that 30 cm was measured with a stop watch. The velocity of the bubble and the inner area of the tubing are then calculated. The bubble velocity is used to represent the velocity of the water flowing through the tubing.

Subsequently, the flow rate for each column could be calculated from the bubble velocity and the area of the tubing. The results for flow rate are shown in Table 3.3. This method takes into account the backpressure from the columns because the pump is connected to the column while the measurements are gathered. However, some possible errors from this method could be the friction and capillary forces between the bubble and the tubing inner surface. Another error could be the compression of the air bubble as it traverses through the tube.

Table 3.3 Tubing characteristic and Flow rate

| | | |
|---------------------|--------|-----------------|
| Tubing ID 1/8": | 0.3175 | cm |
| Tubing Area: | 0.0792 | cm ² |
| Distance Travelled: | 30 | cm |

| | Col 1 | Col 2 | Col 3 | Col 4 | Col 5 | Col 6 | Col 7 | Col 8 | Col 9 | Col 10 | Col 11 | Col 12 |
|--------------------------|-------|-------|-------|-------|-------|-------|-------|-------|-------|--------|--------|--------|
| Bubble Travel Time (sec) | 62 | 70 | 78 | 62 | 72 | 73 | 66 | 71 | 62 | 74 | 71 | 66 |
| Bubble Velocity (cm/sec) | 0.48 | 0.43 | 0.38 | 0.48 | 0.42 | 0.41 | 0.45 | 0.42 | 0.48 | 0.41 | 0.42 | 0.45 |
| Flow rate (CC/Min) | 2.30 | 2.04 | 1.83 | 2.30 | 1.98 | 1.95 | 2.16 | 2.01 | 2.30 | 1.93 | 2.01 | 2.16 |

An effluent flow rate was also gathered from the effluent port by measuring the volume of liquid accumulated within a certain time span. The results are shown below on Table 3.4. Column 3 and 12 did not have any flow at the top of the column during the measurement time period and no effluent flow rate data was gathered.

Table 3.4 Effluent flow rate calculate over 36 hrs.

| Column: | Col 1 | Col 2 | Col 3 | Col 4 | Col 5 | Col 6 | Col 7 | Col 8 | Col 9 | Col 10 | Col 11 | Col 12 |
|--------------------|-------|-------|-------|-------|-------|-------|-------|-------|-------|--------|--------|--------|
| Flow rate(mL/min): | 2.17 | 2.16 | | 1.95 | 2.08 | 2.01 | 1.91 | 2.10 | 2.10 | 1.94 | 2.09 | |

Water and Organic content:

The water and organic content of soil in each column were measured on August 31, 2005. A soil sample was taken out of port 7 and weighted. It was then placed into a 99 °C oven for 16 hours to dry out the sample. The dried soil was then weighted again to calculate the water content of soil. The same soil sample was then baked in a 500 °C furnace for 8 hours to burn off the organic content of the soil. See Table 3.2 for the water content and organic matter for each column reactor. The water content of the soils ranged from 42% to 48% and the organic matter for each column were consistent at around 10%.

Table 3.5 Water content and organic content of soil. Water content is calculated from mass of water and mass of wet soil. The organic content is a percentage of the mass organics and the mass of dry soil.

| Column | Water Content (Mw/Mwet)*100 | Organic Content (Mo/Mdry)*100 |
|---------------------------|--------------------------------|----------------------------------|
| 1 Carex Comosa | 41.9% | 10.2% |
| 2 Carex Comosa | 46.0% | 10.8% |
| 3 Control | 43.7% | 10.4% |
| 4 Eleocharis erythropoda | 45.4% | 10.6% |
| 5 Scirpus atrovirens | 49.0% | 10.5% |
| 6 Scirpus atrovirens | 47.2% | 10.5% |
| 7 Eleocharis erythropoda | 44.9% | 9.7% |
| 8 Control | 47.1% | 10.3% |
| 9 Scirpus atrovirens | 48.5% | 10.2% |
| 10 Eleocharis erythropoda | 46.5% | 9.8% |
| 11 Control | 45.3% | 10.0% |
| 5 Scirpus atrovirens | 48.2% | 10.0% |

Standard Preparation

Standards were prepared for PCE, TCE, cisDCE and transDCE during September and October. Standards preparation were calculated using the equation $C_1V_1 = C_2V_2$. The stock solutions for the standards were prepared by injecting 2 μ L of pure PCE into a capped 160 mL serum bottle. The bottle was then spun for 48 hrs to 72 hrs. Table 3.6 below list the calculations used to find the concentration within the stock bottles.

C_1 : is the initial concentration of stock

V_1 : is the initial volume of stock

C_2 : is the desired concentration of standards

V_2 : is the volume of the standards

Table 3.6: Stock solution Prep

| PCE Stock Preparation for standards: | | | TCE Stock Preparation for standards: | | |
|---|--------|------------|---|--------|------------|
| Volume of pure PCE: | 2 | μL | Volume of pure TCE: | 2 | μL |
| Density: | 1.623 | mg/μL 20oC | Density: | 1.458 | mg/μL 20oC |
| Stock bottle volume: | 160 | mL | Stock bottle volume: | 160 | mL |
| Mass of PCE: | 3.246 | mg | Mass of TCE: | 2.916 | mg |
| Concentration PCE: | 20.288 | mg/L(ppm) | Concentration TCE: | 18.225 | mg/L(ppm) |
| cisDCE Stock Preparation for standards: | | | transDCE Stock Preparation for standards: | | |
| Volume of pure cDCE: | 2 | μL | Volume of pure tDCE: | 2 | μL |
| Density: | 1.282 | mg/μL 20oC | Density: | 1.26 | mg/μL 20oC |
| Stock bottle volume: | 160 | mL | Stock bottle volume: | 160 | mL |
| Mass of DCE: | 2.564 | mg | Mass of DCE: | 2.52 | mg |
| Concentration DCE: | 16.025 | mg/L(ppm) | Concentration DCE: | 15.750 | mg/L(ppm) |

Each standard bottle was created by injecting 5, 15, 30, 150, or 250 μL of stock solution into a 15 mL serum bottle filled with DI water. The new concentration within each standard bottle was then calculated using the equation $C_1V_1 = C_2V_2$ and the bottles were spun for 1 hr to allow for the stock solution to completely diffuse. After 1 hr, the spinning process stopped and 5 mL was withdrawn and injected into an empty Nitrogen gas filled serum bottle. This created a standard bottle with 5mL of liquid and 10mL of headspace. Spin the newly injected standard bottle overnight for 12 hr to allow for equilibration. Afterwards initiate head space analysis of the standards on GC. This standard preparation process best approximated the sampling methods used in this experiment and allows for a more accurate calibration.

VC, methane and ethylene gas standards are prepared using gaseous standard preparation procedure. First, purge a 72 mL serum bottle with the desired gas for 30 minutes. Then use a Hamilton gastight syringe to withdraw 2, 5, 20, 50, or 200 μL of gas and inject it into a serum bottle filled with 5 mL of DI water. In the end the serum bottle will have 10mL of headspace and 5mL of liquid volume. The bottle is then spun over

night for 12 hrs to allow for equilibration. The concentration in the gas and water is calculated using ideal gas and mass fraction equation. After equilibration initiate head space analysis of the standards on the GC.

Sampling Schedule

The first set of water samples was collected on Aug 15, 2004 to establish a baseline condition within the column reactors. Samples were collected from ports 7, 5, and 1 for columns one through two and port 7, 6, 4, and 1 for columns three through six. The six columns sampled contained a representative sample of the different wetland plants under observation.

Starting September 18, 2005, PCE injections began. The goal was to inject 50 ppb PCE solution continuously into the column reactors over the experimental period. This injection of chlorinated solvents was designed to simulate an upward flowing contaminant plume traveling past the roots system of a wetland plant. After PCE injections began, the plants were given approximately 2 weeks to acclimate to the presence of PCE and to allow for possible development microbial colonies capable of degrading PCE.

The second of water samples from the reactors were collected on October 1, 2005. The third sample was conducted 4 weeks after PCE injections began on Oct 16, 2005. A final sample set was conducted on Nov. 3, 2005 or 6 weeks after PCE injections began. Each sampling set collected samples from seven sampling ports and one influent port per reactor. All together the twelve reactors combine to give 106 samples per sampling set. (see appendix A for sampling method)

Gas Chromatograph

A Hewlett-Packard model 6890 was the only GC used during the experiment. The GC was setup with a split inlet into two columns. The column used for the FID (Flame ionization detector) was a JW Scientific Inc, Cat# 1134332, 30m x 0.320 mm. The column for ECD (Electron capture detector) was a Hewlett-Packard HP-624, 30m x 0.320mm x 1.8 μ m film thickness. Table 3.7 below shows the detection limit on the GC. PCE, TCE, 1,2 cDCE, and 1,2 tDCE was analyzed on ECD, while methane was analyzed on the FID. Test on ethylene was conducted to determine the residence time, however no detection limit analysis was conducted. VC, 1,1DCE, and ethene was not analyzed in this experiment. (See appendix B for GC methods)

Table 3.7 Detection limits on the GC

| | R-time | Detection Limit (ECD) Concentration (ppb) | Detection Limit (FID) Concentration (ppb) |
|----------|--------|--|--|
| PCE | 7.565 | 0.23 | none |
| TCE | 5.485 | 0.56 | none |
| 1,2 cDCE | 2.586 | 0.45 | none |
| 1,2 tDCE | 3.175 | 2.188 | none |
| Methane | 1.533 | none | 0.2 |
| Ethylene | 2.422 | N/A | N/A |

Samples for IC

Nitrate, sulfate, nitrite and residence time samples were gathered for IC analysis. The ion samples were gathered from all 106 ports on twelve columns. Sampling methodology was similar to the chlorinated samples methodology stated in Appendix A.

The ions of interest during sampling were sulfate and nitrate. The samples were collected by first opening the port and allowing it to flush with 10 mL of liquid. The samples was then gathered and stored in a screw capped 10mL vial from cole-palmer.

Each sample vial was then spun for 10 min on a 10,000 rpm centrifuge to separate out the particular matter. The liquid samples were then transferred to a 10 mL Dionex autosampler vial.

Residence Time Sampling

A breakthrough test using Potassium Bromide (KBr) had been conducted to determine the retention time within the columns. As water was injected into the bottom of the column, it traveled up the column and out through the outlet port. The amount of time needed for the water to progress through the entire column was the retention time (RT). The retention time was useful in determining how long chlorinated solvents are in contact with the soil and root matrix in the column. The longer the contact time the more opportunity there was for degradation or uptake into plant tissues. The breakthrough test was conducted by injecting 60 mL of 6g/L KBr solution into the inlet port. Two analysis procedures had been used to measure the breakthrough curve. The first procedure used a conductivity meter to continuously monitor any increase in conductivity at top of column 9. The resulting increase in conductivity should form a breakthrough curve allowing for the calculations of retention time. The second procedure used a time-series method to take samples from column 9 port 4 every 30 minutes. Samples were gathered over a period of 35 hours. The KBr samples were then analyzed on an IC to determine the bromide concentrations of each sample and then plotted to form a breakthrough curve.

Ion Chromatograph

A Dionex Ion Chromatograph equipped with AS-50 autosampler was used for the analysis. Brad Short Improved Control Program was the methods used to analyze each

sample for sulfate and nitrate. Bromide Tracer JY Control Program was the IC method used to measure bromide concentration (see Appendix C for IC methods).

General Supplies

All PCE, TCE, cDCE, and tDCE chemicals were reagent grade and purchased from Fisher Scientific. The chemicals have been in storage for at least 1.5 yrs at room temperature in a fire proof case. All GC gases used were ordered from WSU lab supply shop. Nitrogen gas was zero grade nitrogen (99.9%) and methane was ultra high purity (99.95%). 10% w/v KBr stock solution was acquired from Fisher Scientific.

IV. Results

Pre PCE Injection Baseline Results

In order to assess the PCE degradation potential, a baseline pollutant concentration level was established. This baseline would allow for the meaningful comparisons of results and possible assessment of reactor conditions before and after PCE injection. PCE was not injected during the first sample set and consequently PCE, TCE and other chlorinated degradation products were not detected within the reactors. Figure 4.1 plots out the methane concentration pre-PCE injection. The control (unplanted) column had the highest methane concentration and the maximum was reached at 45". The planted columns had less peak methane concentration than the control columns and tended to peak at 27" or 36". Feed water from the reservoir contained no methane and the methane concentration within all treatment started at zero. All the planted columns had less methane concentration than the control reactors, indicating that the plants within the columns were influencing the ground water chemistry.

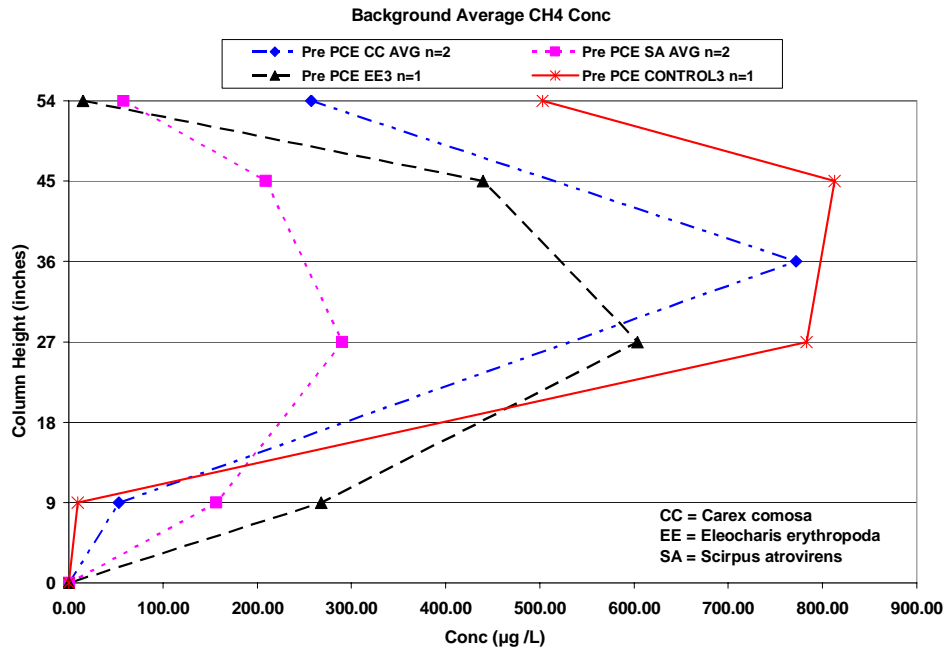

Figure 4.1 Background methane concentration pre-PCE injections ($\mu\text{g/L}$)

Time Series Data Sets

During first and second sampling, the injection methods were still under development and resulted in varying PCE concentrations at the influent ports. For all time series data, the Y-axis represents column height along the column, from 0” at the influent port to 54” at port 7 and the X-axis was the contaminant concentration in ppb.

The first sampling set was conducted 2 weeks after continuous PCE injections began and Figure 4.2 below shows the average PCE concentration. The largest PCE concentration decrease for all treatments occurred along the bottom of the columns, between 0” and 15”. At the top half of the columns, PCE concentration decreased slowly for all treatments. The significant PCE concentration decrease occurred at the bottom of the reactors indicating that some type PCE removal process was taking place just 2 weeks after injections began.

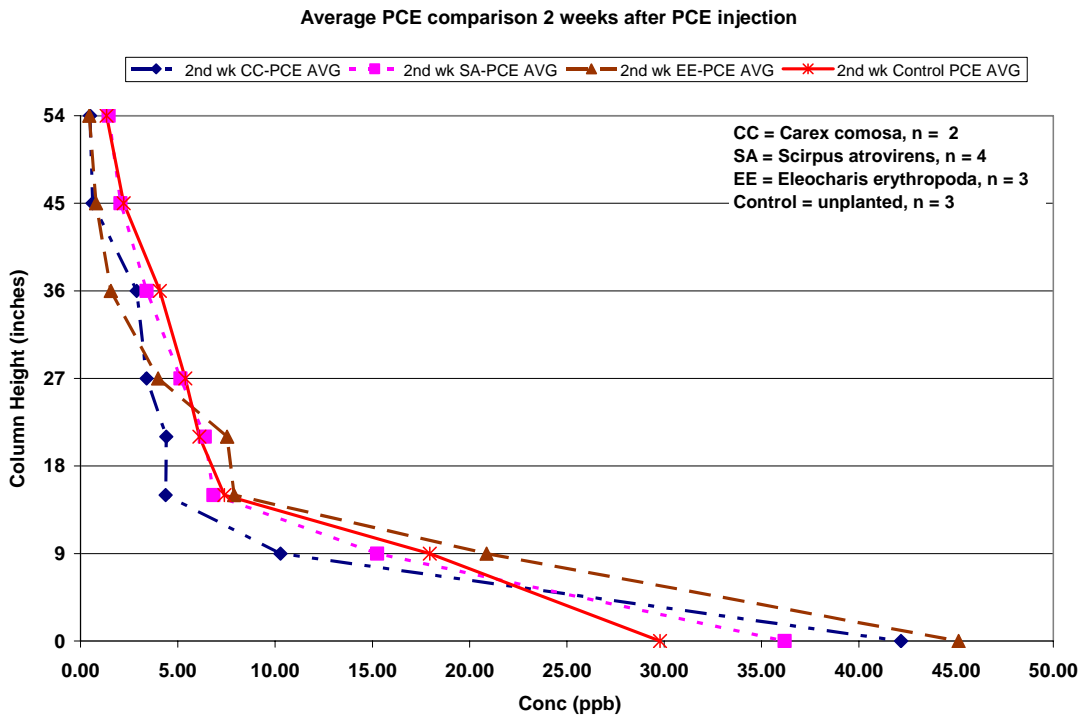

Figure 4.2 Average PCE Concentration for first sample set .

Figure 4.3 below, illustrates the average TCE concentration within the columns. TCE was not detected during background sampling and presence of TCE within the columns proves that PCE dechlorination was taking place. The primary trend for this data set shows that TCE concentration increased towards the middle of the column, with EE columns having the most TCE, followed by the control column. It is also of note that between 45” and 54” the TCE concentrations decreased for *Carex comosa* and *Eleocharis erythropoda*, while it increased for the control columns and for *Scirpus atrovirens*. The highest TCE concentration in this sampling set was only 4 ppb. So 15 days after continuous PCE injections began the column reactors may not have fully developed its chlorinated solvent degradation potential.

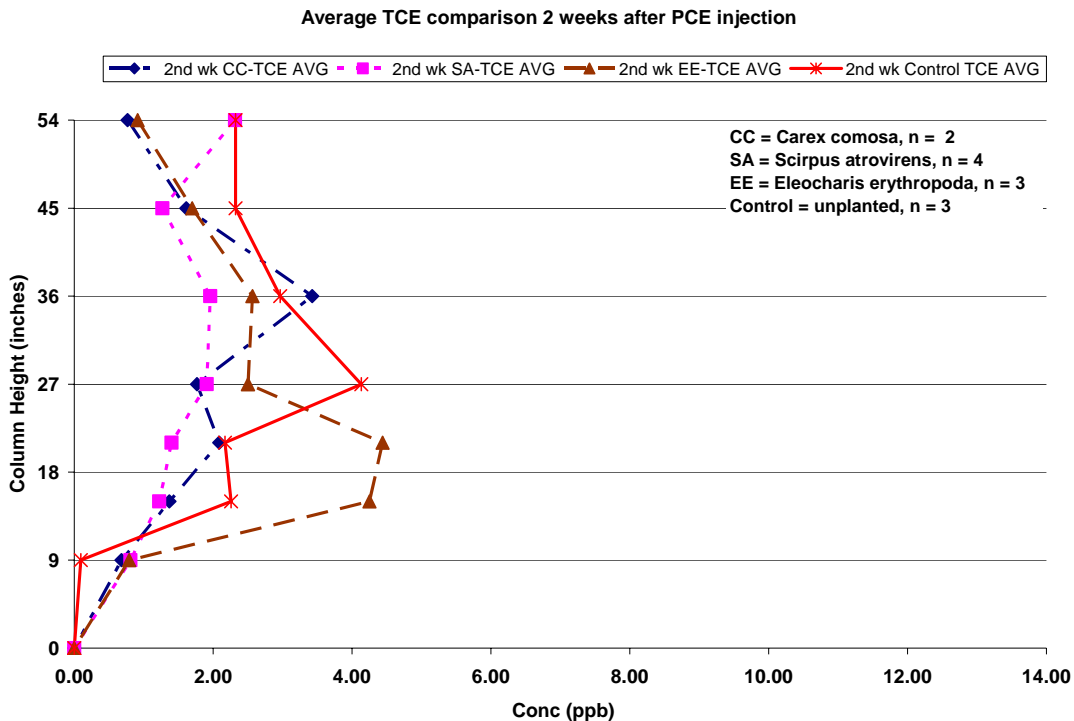

Figure 4.3 Average TCE concentration for the first sample set

The third chemical under observation was methane, which was detected in both the background samples and post-PCE injection samples. Figure 4.4 below shows that the planted reactors had an increase methane concentration towards the middle of the columns and the concentration decreased towards the top. This is consistent with pre-PCE methane results shown on Figure 4.1. The only exception was the control reactors, in which the average concentration increased all the way to port 6 and then remained steady to the very top of the columns.

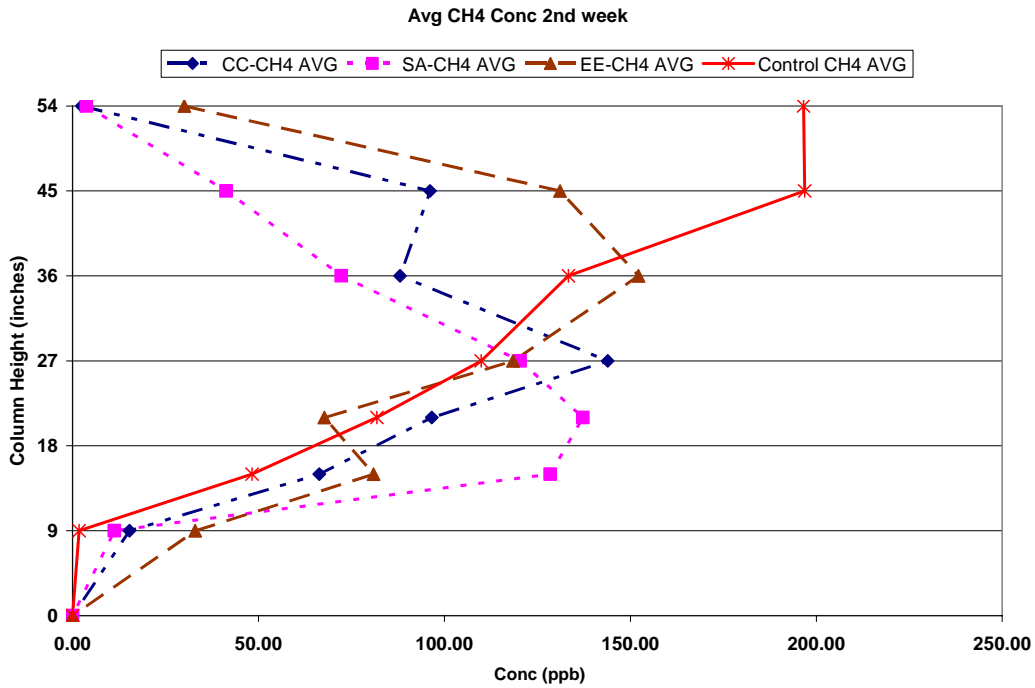

Figure 4.4 Average methane concentration for the first sample set

Further comparisons between methane concentration pre and post PCE injections are shown in Figure 4.5. The methane concentration for both data sets maintained similar trend of increasing towards the middle but decreasing towards the top of the columns. However, the methane concentrations pre-PCE injections were significantly greater than post-PCE injections. This shows that methanogenic activities were reduced after PCE has been introduced.

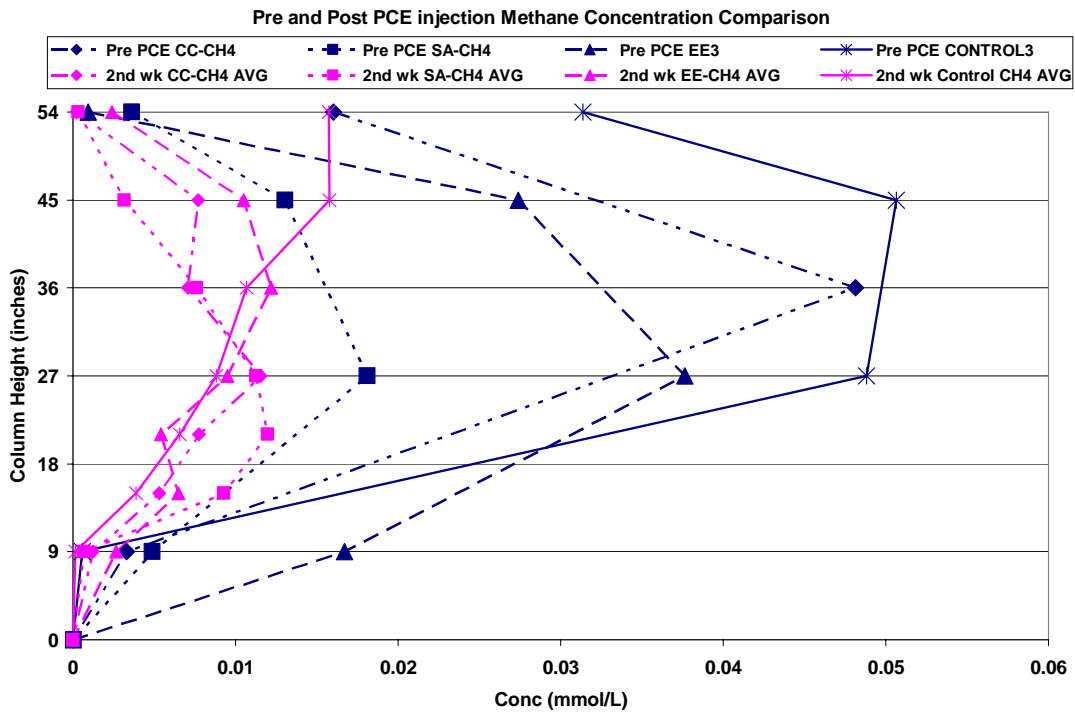

Figure 4.5 Methane comparison in (mmol/L) pre and post PCE injections

Sampling Set #2:

The second sampling set was conducted 4 weeks after continuous PCE injections began. Figure 4.6 presents the data for 2 weeks and 4 weeks data and allows for comparison between the two sampling sets. The PCE concentration for the 4th week sampling set was greater than the 2nd week samples. The trend for PCE decrease during the 4th week was much more linear and more PCE penetrated at 54” near the top of the column.

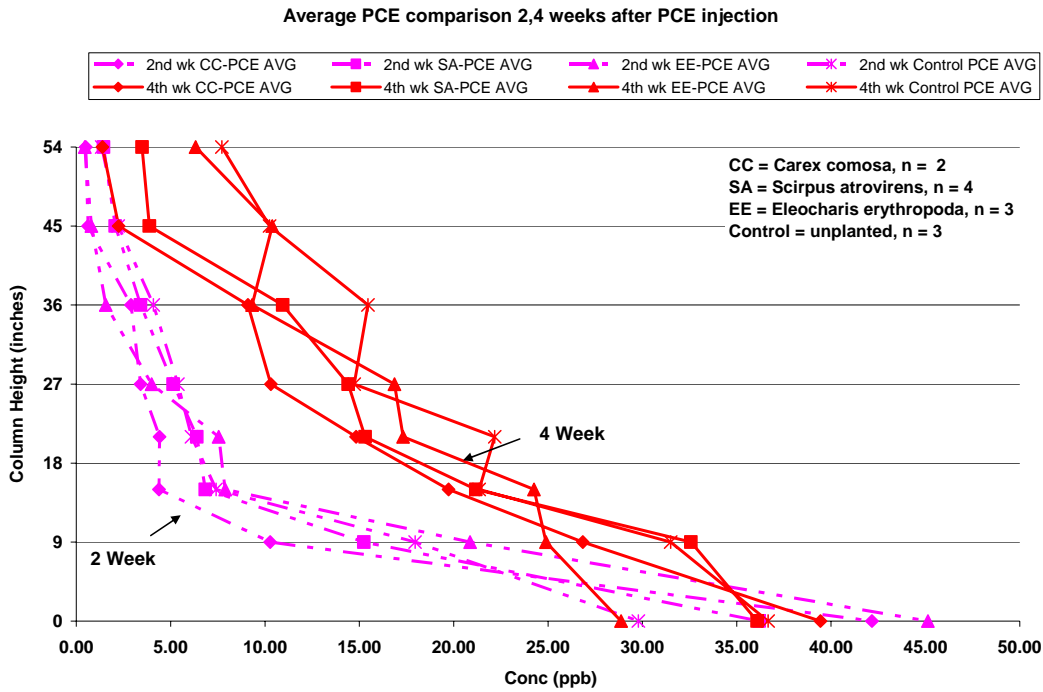

Figure 4.6 PCE comparisons 2 and 4 weeks after continuous PCE injections began

In Figure 4.7 below, comparisons of TCE concentrations were made at the 2 week and 4 week point. As shown on the graph, the average TCE concentration had increased for all treatments after 4 weeks. However, the TCE concentration for all treatments still remained less than the PCE concentration. The second sampling set also showed that the TCE trend for all treatments increased to a maximum at 36" and then decreased above it. However, at 54" TCE had not been fully removed and all treatments had detectable levels remaining. At 54" The control columns had the greatest TCE concentration followed by *Eleocharis erythropoda*.

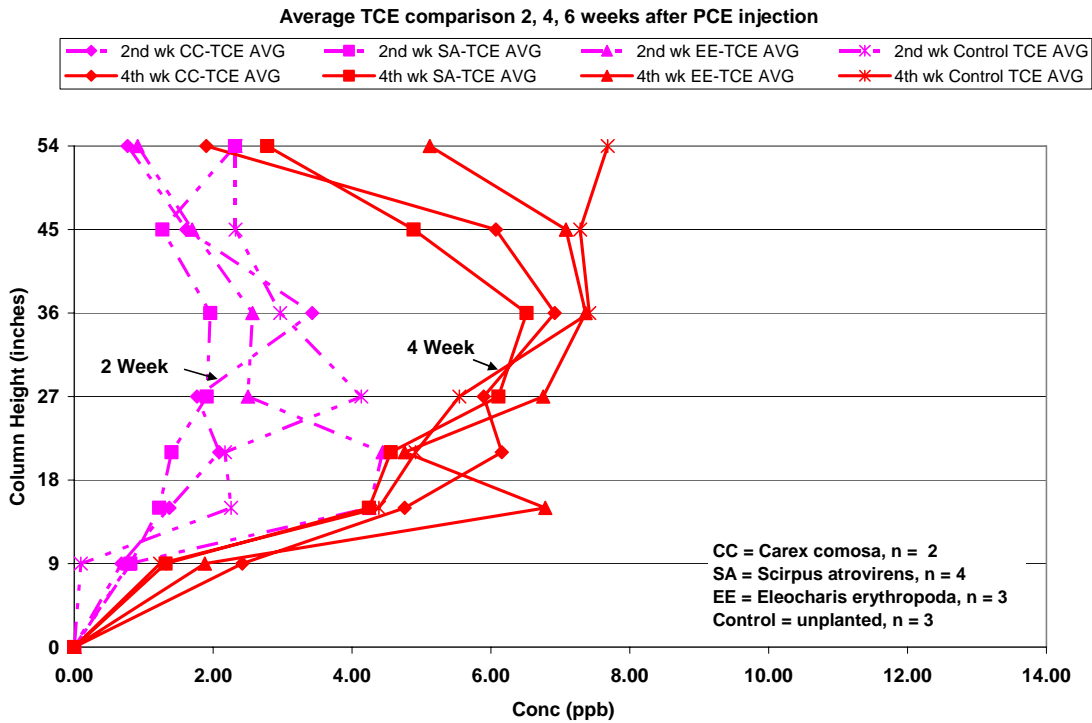

Figure 4.7 TCE comparisons 2 and 4 weeks after continuous PCE injections began

Sampling Set #3:

The third sampling set was conducted 6 weeks after continuous PCE injections began. In Figure 4.8 -4.10 the PCE results for all three data sets were compared, comparisons of the average PCE concentrations were made at the 2, 4 and 6th week point. The trend for the 6th week sampling set was similar to 2nd week samples and the majority of PCE concentration decrease occurred below 15". For all treatments, the 6th week samples had more PCE than the 2nd week samples but it had less PCE than the 4th week samples. Showing that PCE removal at 6th week was more efficient than at the 4th week.

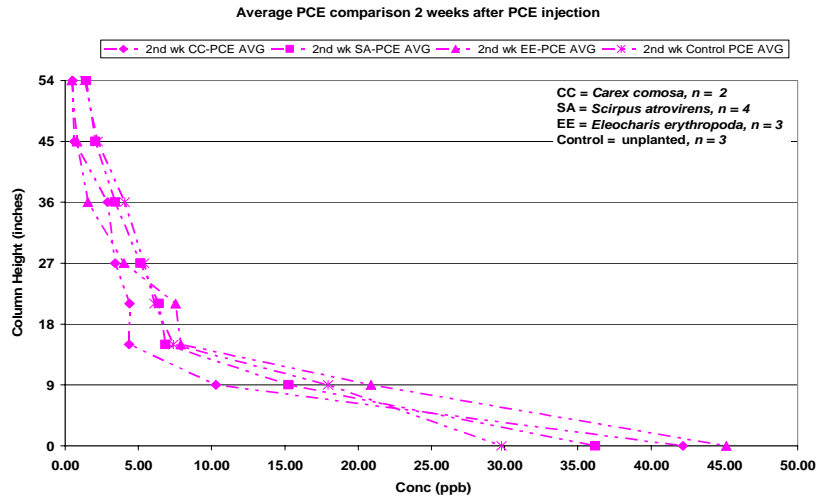

Figure 4.8 PCE data 2 weeks after injections began

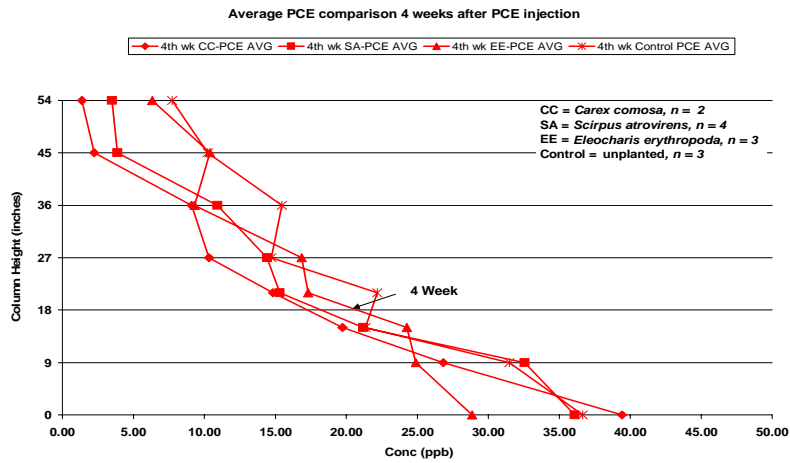

Figure 4.9 PCE data 4 weeks after injections began

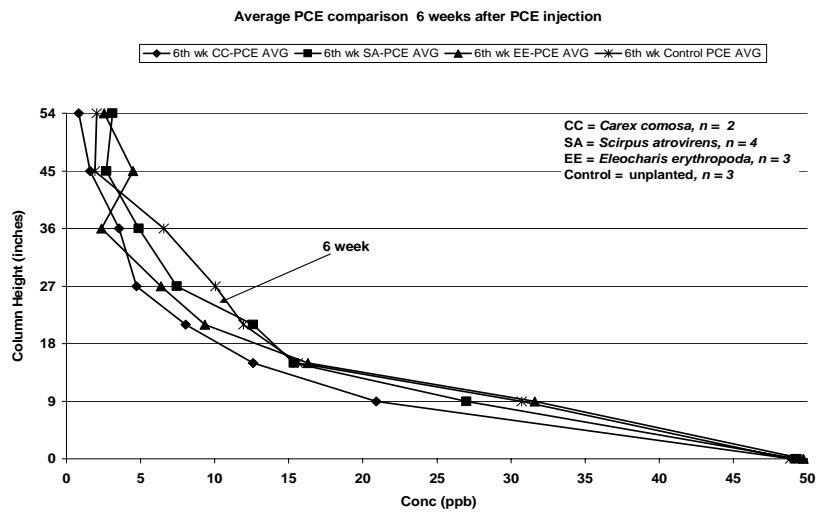

Figure 4.10 PCE data 6 weeks after injections began

Figure 4.11 – 4.13 shows that the TCE concentrations at 6th week had increased. The planted columns followed the same trend of increasing in the middle of the columns and decreasing near the top. The control columns on the other hand continued have increasing concentration through out the entire length of column. At 6h week the increase in TCE concentration below 15” correlated well to the decrease in PCE concentration PCE data shown in Figure 4.10 above.

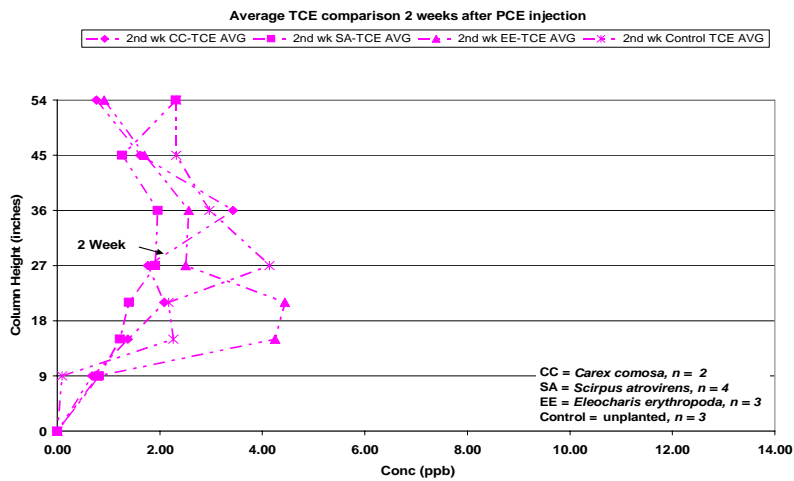

Figure 4.11 TCE data 2 weeks after injections began

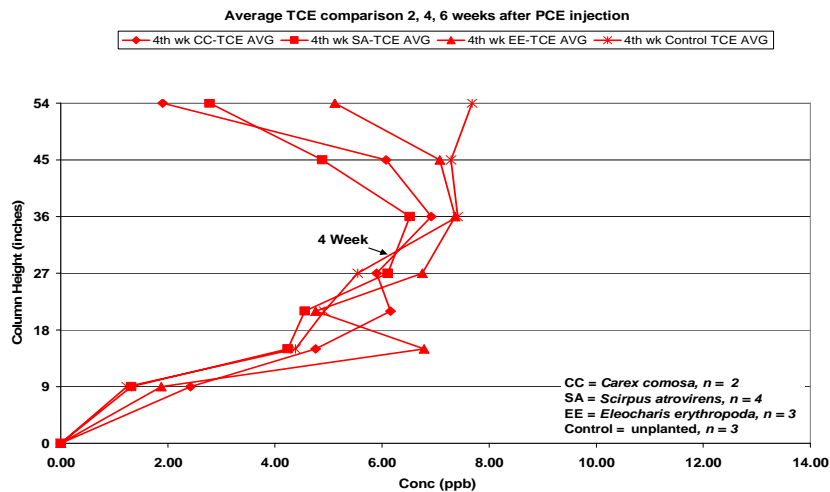

Figure 4.12 TCE data 4 weeks after injections began .

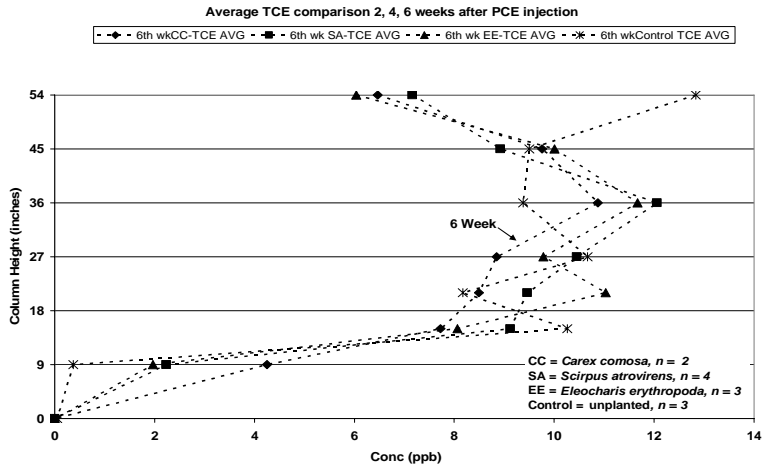

Figure 4.13 TCE data 6 weeks after injections began

Figure 4.14-4.17 compares the methane concentrations among the *Carex comosa*, *Scirpus atrovirens*, *Eleocharis erythropoda*, and control column respectively. In Figure 4.14, the maximum methane concentration was achieved at 27"; afterwards the concentration decreased to near zero at the top of the column. In addition, a lower methane concentration was observed in the 6th week sample set. In Figure 4.15, the *Scirpus atrovirens* maximum methane concentration was achieved at 21". It also showed a significantly lower methane concentration in the 6th week sampling set. In Figure 4.16, *Eleocharis erythropoda* maximum methane concentration was achieved at 36". Finally in Figure 4.17, the control column's methane concentration increased throughout the length of the column and the maximum concentration was found near the top of column at 54". The methane concentration for the control samples stopped increasing as it approached the top of the column, suggesting something is inhibiting methane production near the top. In the all sample sets no *cis*-DCE or *trans*-DCE or any other PCE degradation products were detected.

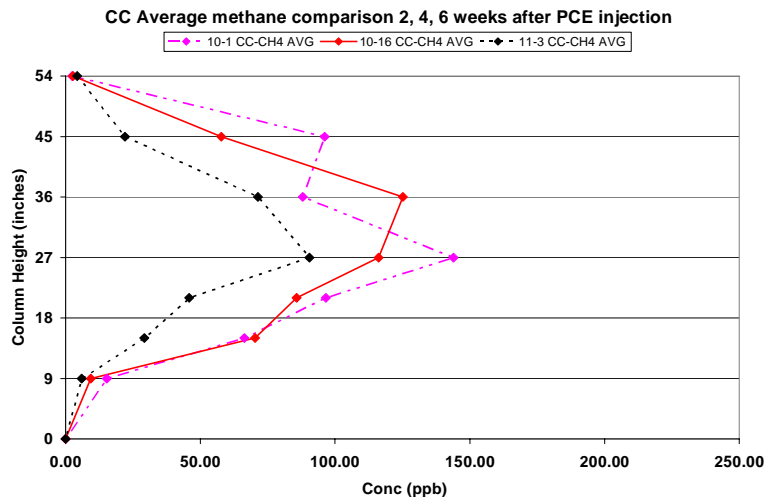

Figure 4.14 Carex comosa methane comparison .

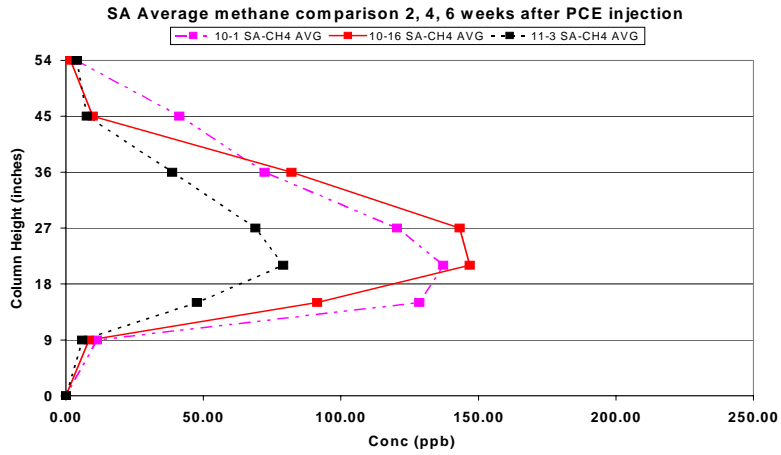

Figure 4.15 *Scirpus atrovirens* methane comparison

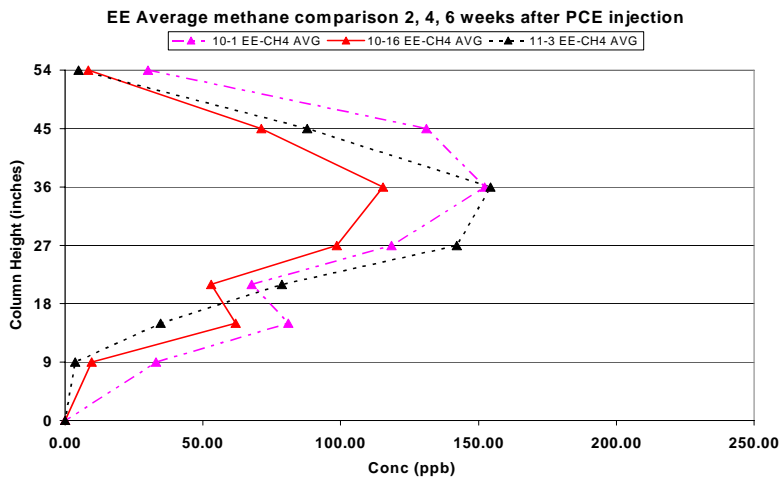

Figure 4.16 *Eleocharis erythropoda* methane comparison

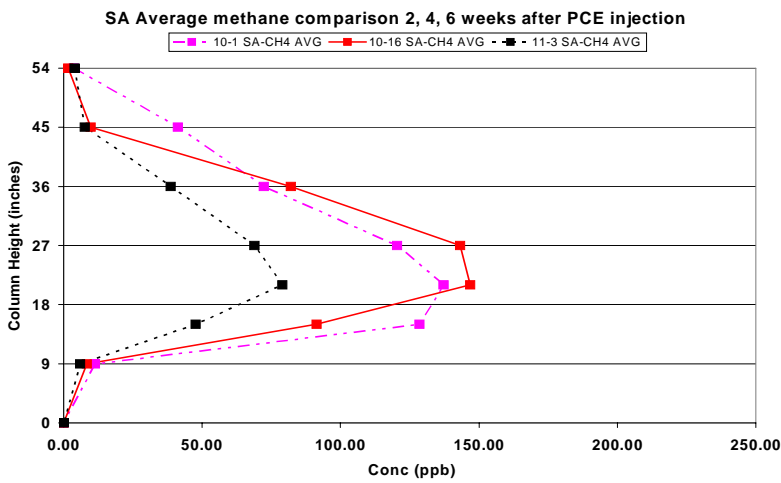

Figure 4.17 Control methane comparison .

PCE Concentration:

The following charts are used to compare the PCE removal effectiveness of different plants. Figure 4.18 shows PCE concentration decrease between each port at week 2. Each bar represents the amount of PCE decrease between two ports for a particular treatment. For example, the average concentration decrease for *Carex comosa* between the influent port and port 1 is about 32 ppb. The error bars on the graph represents the standard deviation of the data. Unfortunately, all data sets had a significant standard deviation due to the limited sample size of each species. Figure 4.18 shows that the greatest PCE concentration decrease occurred below 15”.

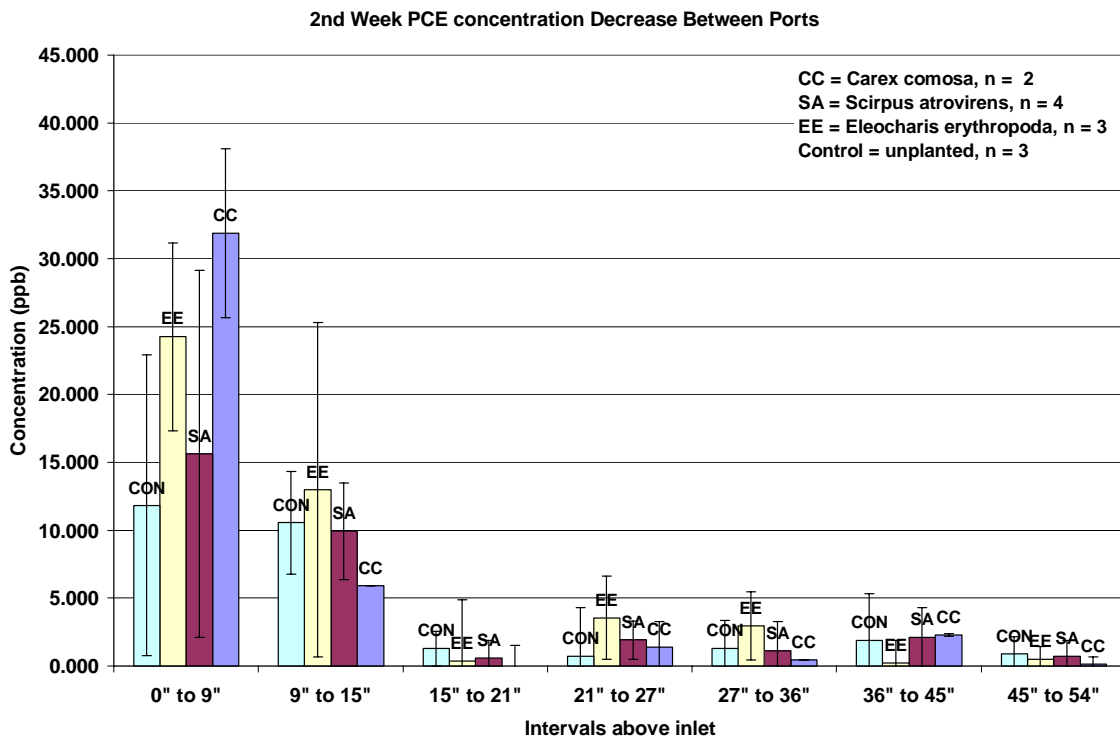

Figure 4.18 PCE Concentration decrease between ports after 2 weeks of continuous PCE injection. Student t-analysis with an alpha = 0.1, showed that between 0” and 9” *Carex comosa*’s concentration decrease was significantly greater than the control reactors. All other ports showed no significant difference between treatments.

Figure 4.19 shows the cumulative percentage of PCE removed at each port. For example at 9", the control column had about 38% PCE concentration decrease. At 15", *Carex comosa* had the greatest percentage of PCE concentration decrease, with 90% drop in PCE concentration. Near the top of the column at 54", *Carex comosa* and *Eleocharis erythropoda* had the greatest removal percentage with about 99% of PCE removed at port 7 or 54"

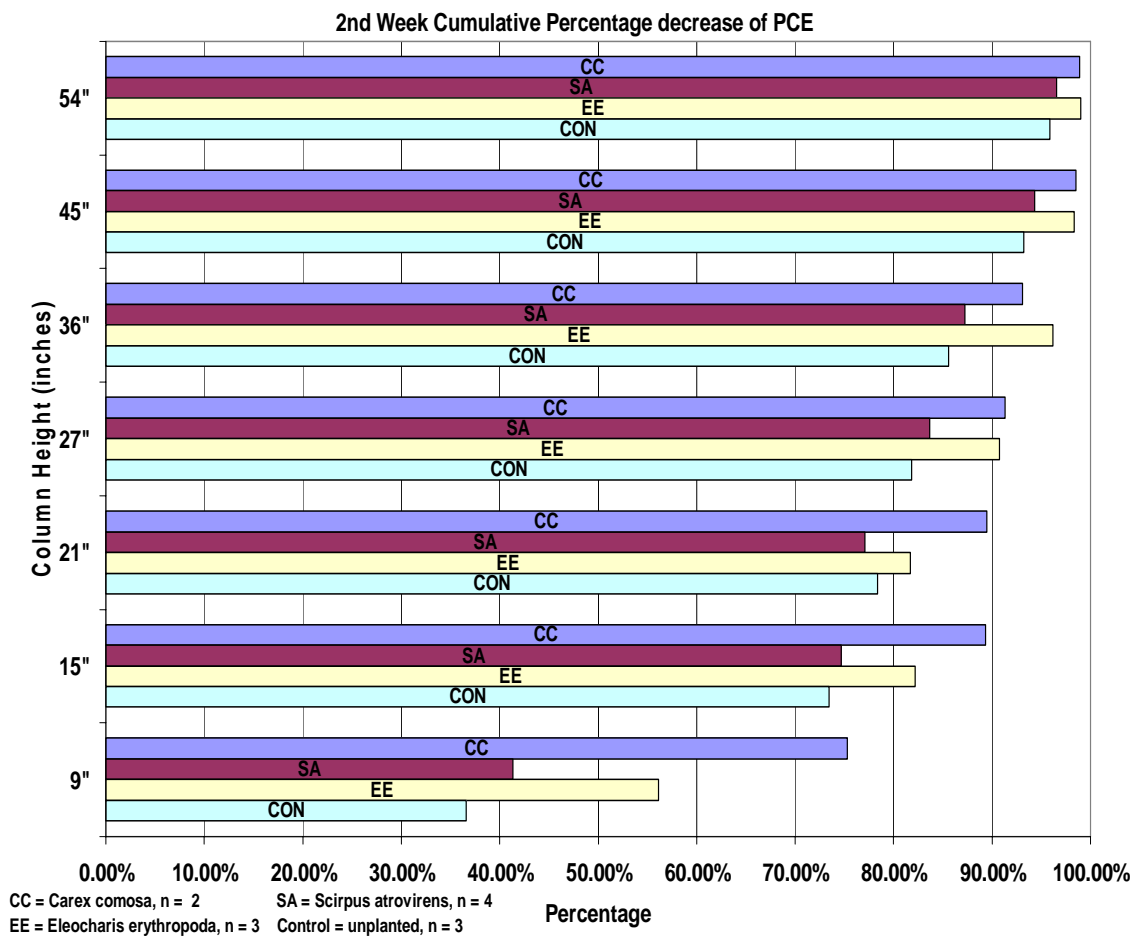

Figure 4.19 Cumulative percentage of PCE removed at 2 weeks

Figure 4.20 below shows the PCE removal between ports after six weeks of continuous PCE injections. *Carex comosa's* most active zone of PCE decrease was still between 0 and 9 inches. Between 9" and 15" all treatments had less PCE removals but *Carex comosa* had the greatest drop in PCE removal .

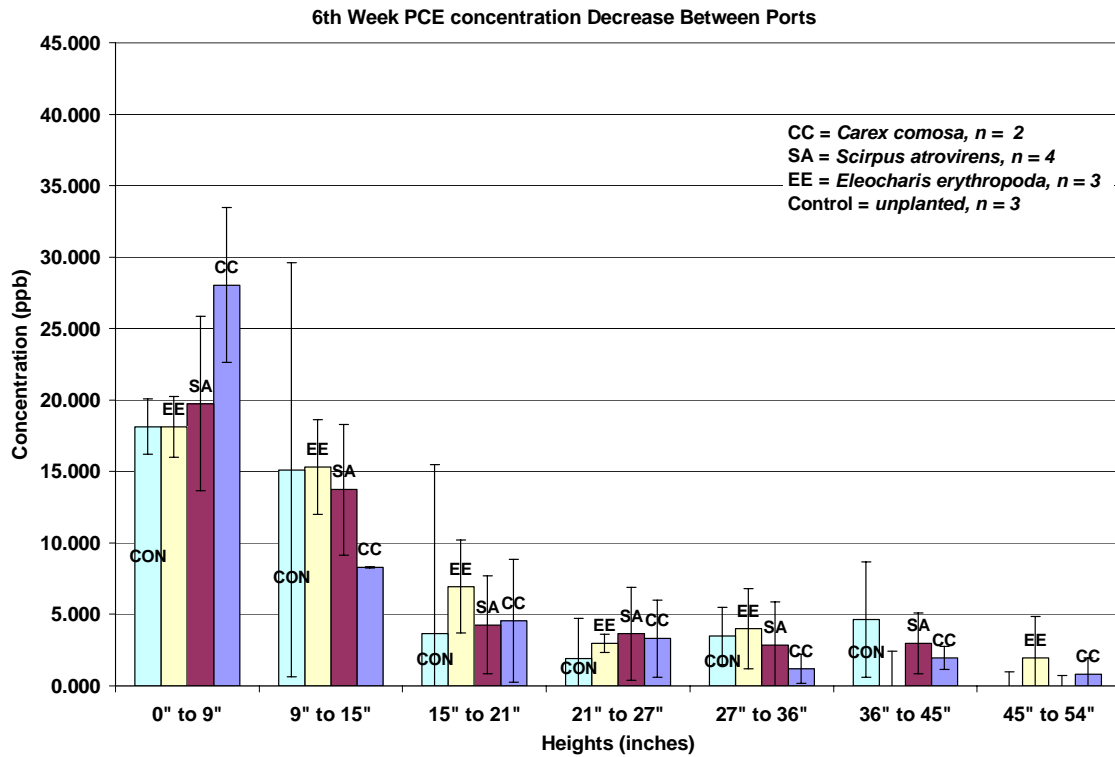

Figure 4.20 PCE Concentration decrease between ports at 6 weeks. Student t-analysis performed on the data, with an alpha = 0.1, showed that between the influent and port 1, the *Carex comosa* decrease was significantly greater than all of the other treatments. All other ports showed no significant difference between treatments.

Figure 4.21 below shows the cumulative percent of PCE decrease after 6 weeks. *Carex comosa* had the greatest decrease in PCE concentration with about 96% decrease at port 7. However, the other treatments also showed significant percentage of PCE removal, with every treatment removing greater than 90% of the initial PCE injection.

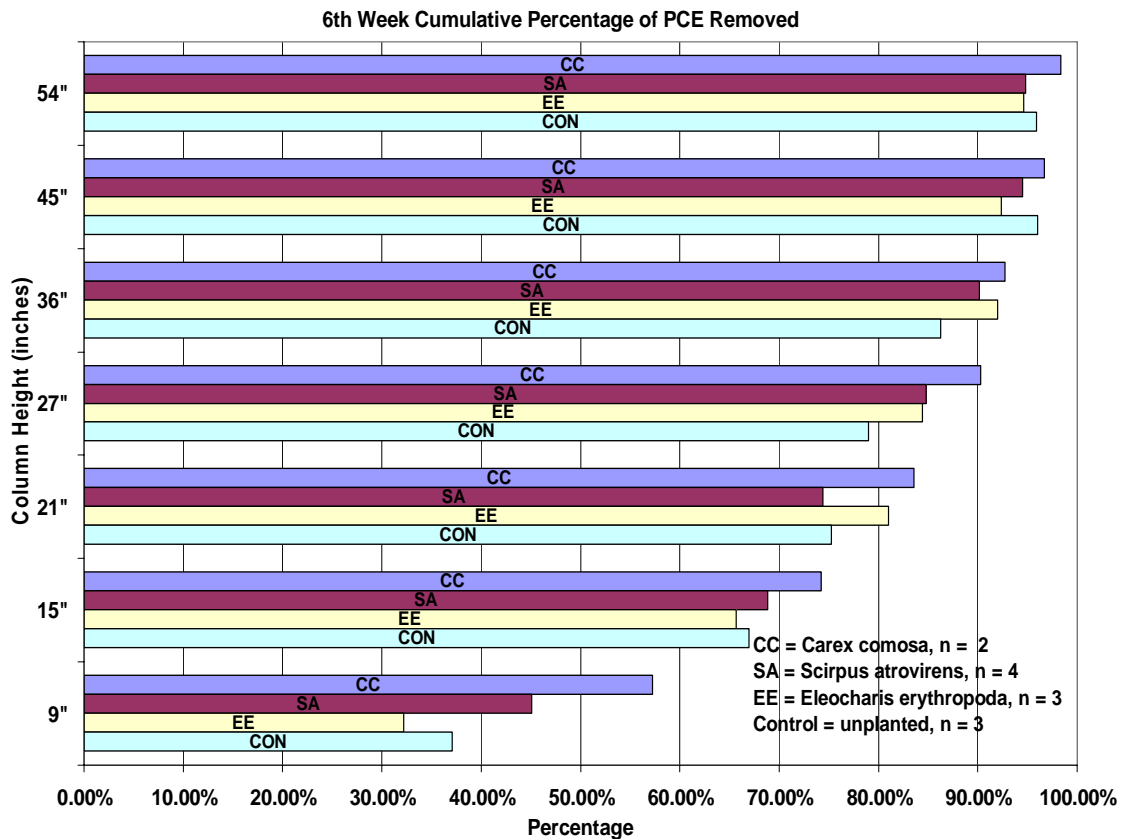

Figure 4.21 Percentage of PCE removed at 6 weeks

TCE Data

After 2 weeks of continuous PCE injections, Figure 4.22 below compares the TCE concentration among the treatments. There were large standard deviations among each of the treatments but comparisons of the average concentrations showed that below 21", *Eleocharis erythropoda* had the highest TCE concentration. At 27" the control reactors had the greatest concentration of TCE and above 27" TCE concentration because

to decrease among all treatments. Finally at 54", the control reactors had the greatest concentration among all the treatments.

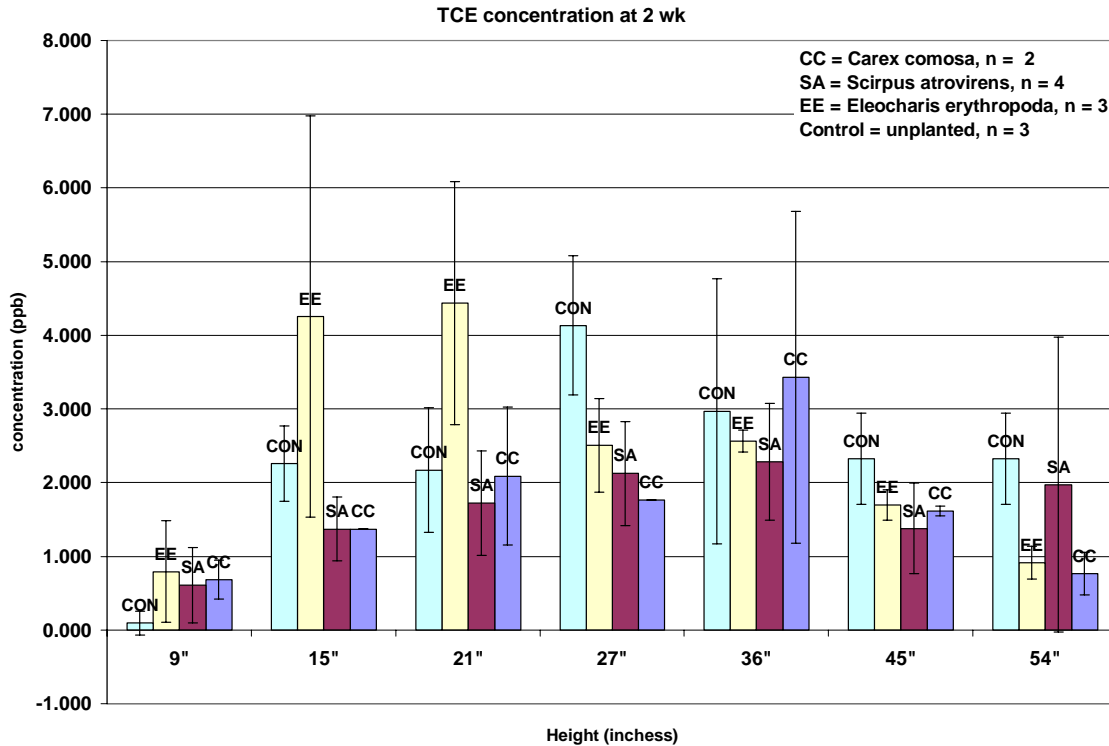

Figure 4.22 TCE concentration at 2 weeks

After 6 weeks of continuous PCE injections, Figure 4.23 below compares the TCE concentration among the treatments. TCE were detected at 9" and *Carex comosa* had the highest concentration. At 15" all treatments had higher concentration of TCE, with the control columns having the highest TCE concentration. Between 15" and 36" all planted columns had increasing concentration of TCE. Above 36" the TCE concentrations within the planted columns decreased. However the control column's TCE concentration maintained about the same level until 45" whereby it increased to have the highest concentration of TCE among all the treatments.

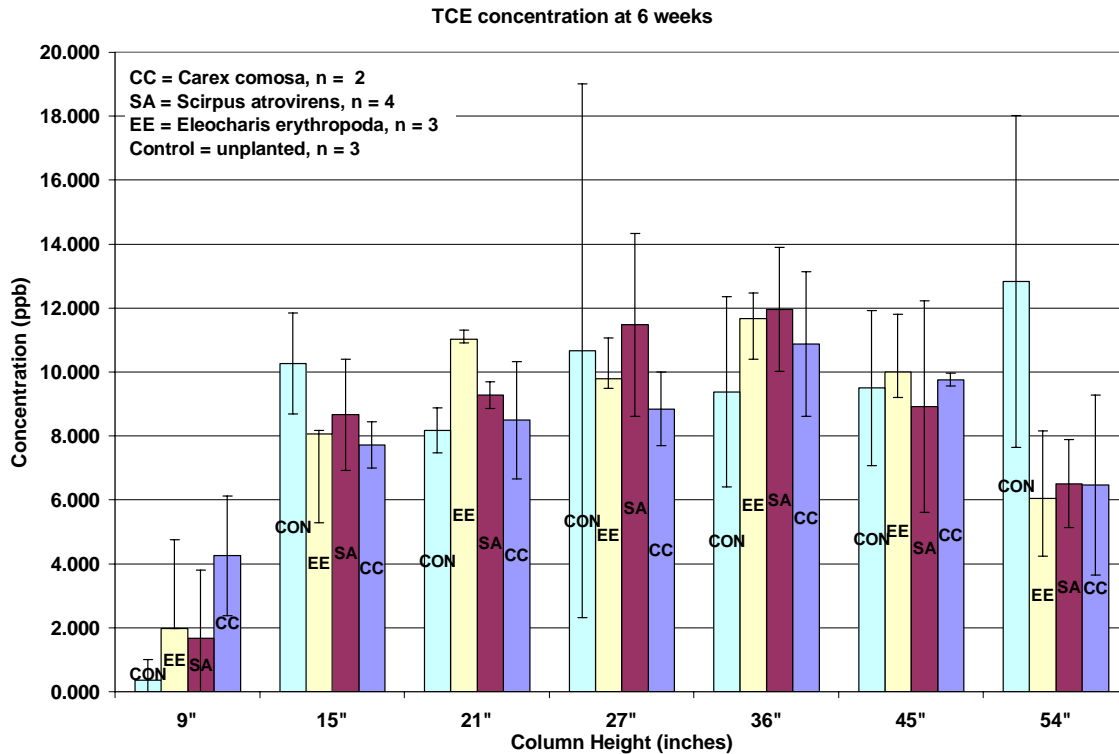

Figure 4.23 TCE Concentration 6 weeks after continuous PCE injection began

TCE and PCE Comparison

Since, TCE was not detected during the initial background sampling of the reactors, any TCE detected after PCE injections began was due to the degradation of PCE. Under ideal conditions, the molar concentration of TCE detected should equal the molar concentration of PCE decrease between each port. After 6 weeks of continuous PCE injections, comparisons were made between PCE decrease and the TCE increase (see Figures 4.24 – 4.27). All concentrations were in units of mmol/L to allow for comparison between different species.

The results from all four treatments showed that initially there was a large decrease in PCE concentration between the influent 0" and 9" and the increase in TCE concentration did not match the PCE decrease. Between 9" and 15", *Scirpus atrovirens*

and control reactors had increased TCE removal. Between, 15” and 45” the PCE concentration decreased at a slower rate but the TCE concentration increase still did not match PCE concentration decrease.

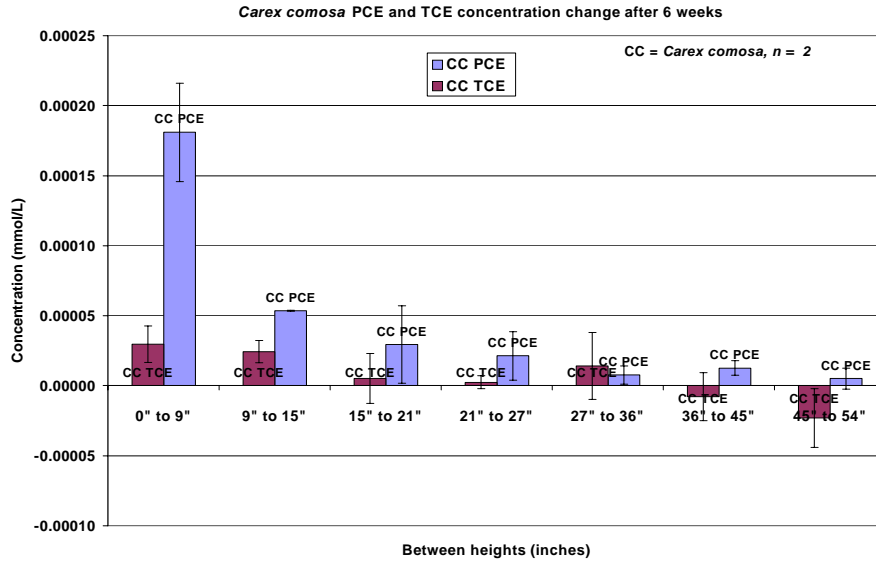

Figure 4.24 *Carex comosa* PCE-TCE comparison

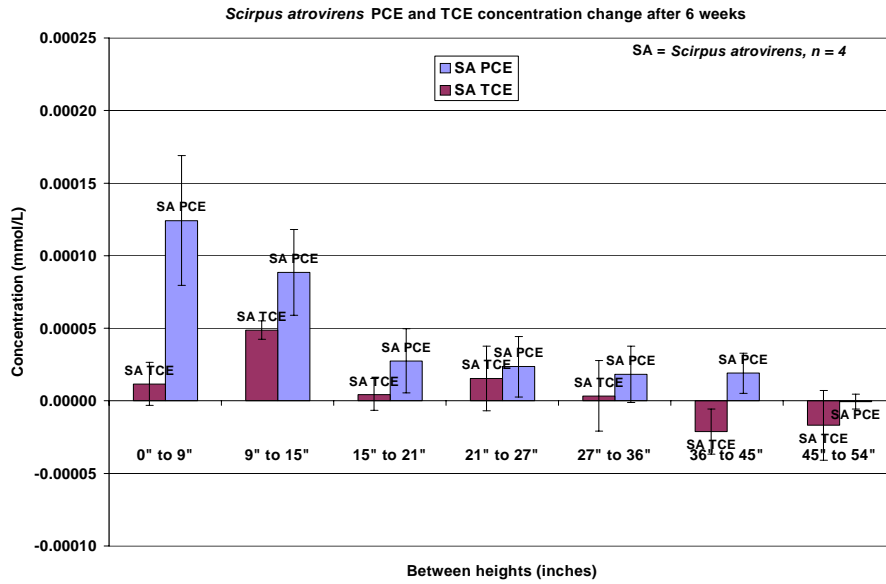

Figure 4.25 *Scirpus atrovirens* PCE-TCE comparison

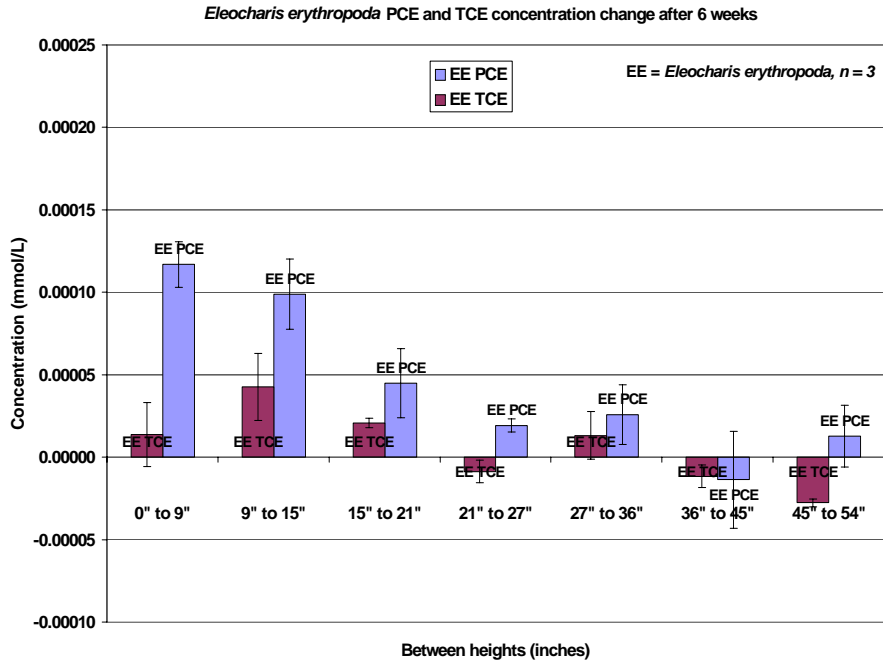

Figure 4.26 *Eleocharis erythropoda* PCE-TCE comparison

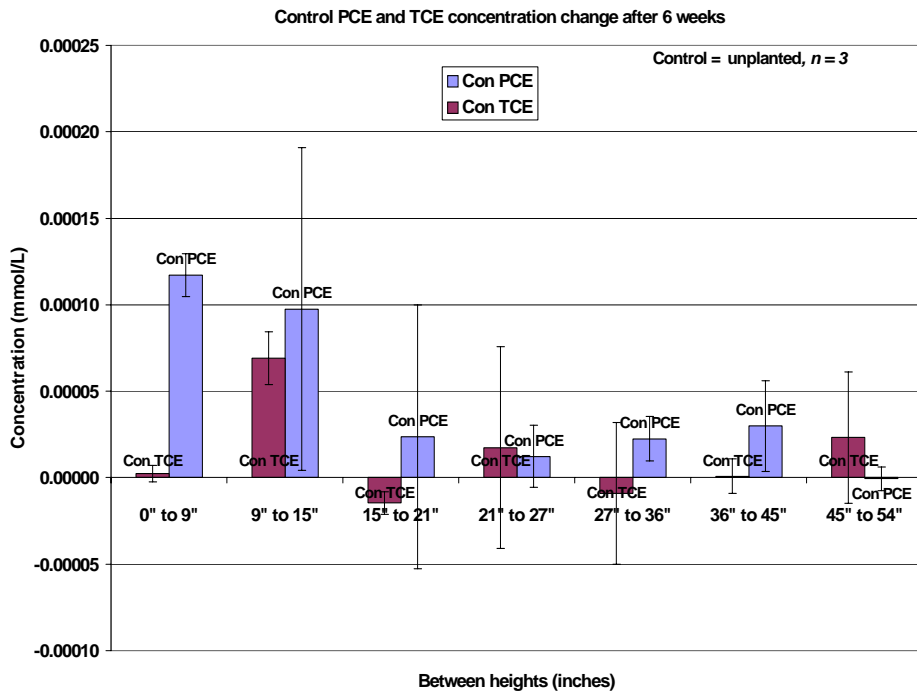

Figure 4.27 Control PCE –TCE comparison

Sulfate and Nitrate Comparison

Sulfate, nitrite and nitrate are natural occurring chemicals within the subsurface. Sulfates (SO_4^{-2}) are formed from the oxidation of hydrogen sulfide. Nitrite (NO_2^-) and nitrate (NO_3^-) are formed from the aerobic oxidation of ammonium ions NH_4^+ (Mitsch, 1993). Like PCE, both nitrate, nitrite and sulfate are electron acceptors and, in an anaerobic environment, microbes could combine these chemicals with an electron donor to produce energy (Wiedemeier et al., 1999). Microbes preferentially use the chemical that produces the most energy and Figure 2.5, shows the succession of the chemicals within the subsurface (Mitsch, 1993). So the presence of these chemicals may influence optimum PCE dechlorination within the subsurface.

Figure 4.28 and 4.29 below presents the average nitrate and sulfate concentration found within the columns. No nitrite was detected among any of the columns.

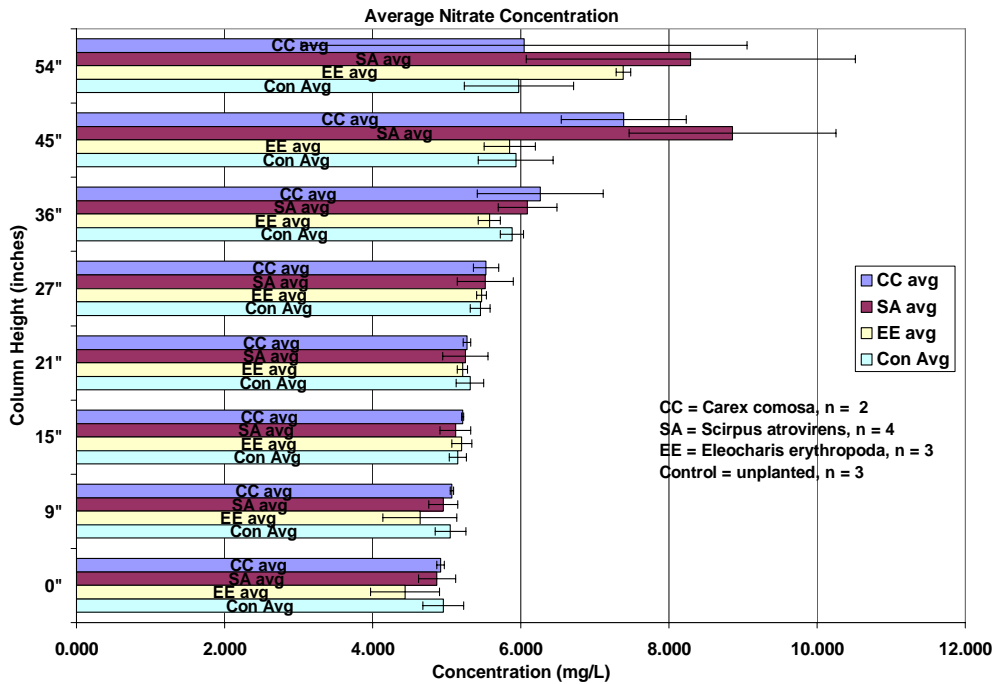

Figure 4.28 Average nitrate concentrations with depth

The nitrate concentration for all four treatments grew at a very slow rate to 36". Above 36", planted treatments had a large increase in the nitrate concentration. However, the control treatment had little change in nitrate concentration and it maintained approximately the same nitrate concentration above 36". At 45", a student-t analysis with $\alpha=0.1$ found the nitrate concentration for *Scirpus atrovirens* to be statistically greater than both *Eleocharis erythropoda* and control columns (p-value = .003). At 54" there was no statistically difference between all treatments.

Figure 4.29 shows the average sulfate concentration found within the columns. A student-t analysis with $\alpha=0.1$ was also performed for the sulfate concentration and it showed that *Eleocharis erythropoda* had statistically greater sulfate concentration than all other treatment at 0" and 9". Between 15" and 27" all treatments had no statistical difference in sulfate concentrations and they are slowly decreasing. At the top of the columns between 45" and 54" the sulfate concentrations for *Carex comosa*, *Scirpus atrovirens*, and control reactor started to increase. Comparisons showed that the control reactors had statistically greater sulfate concentration than *Eleocharis erythropoda* at 54" (p -value = 0.07). No significant difference were detected among the other treatments.

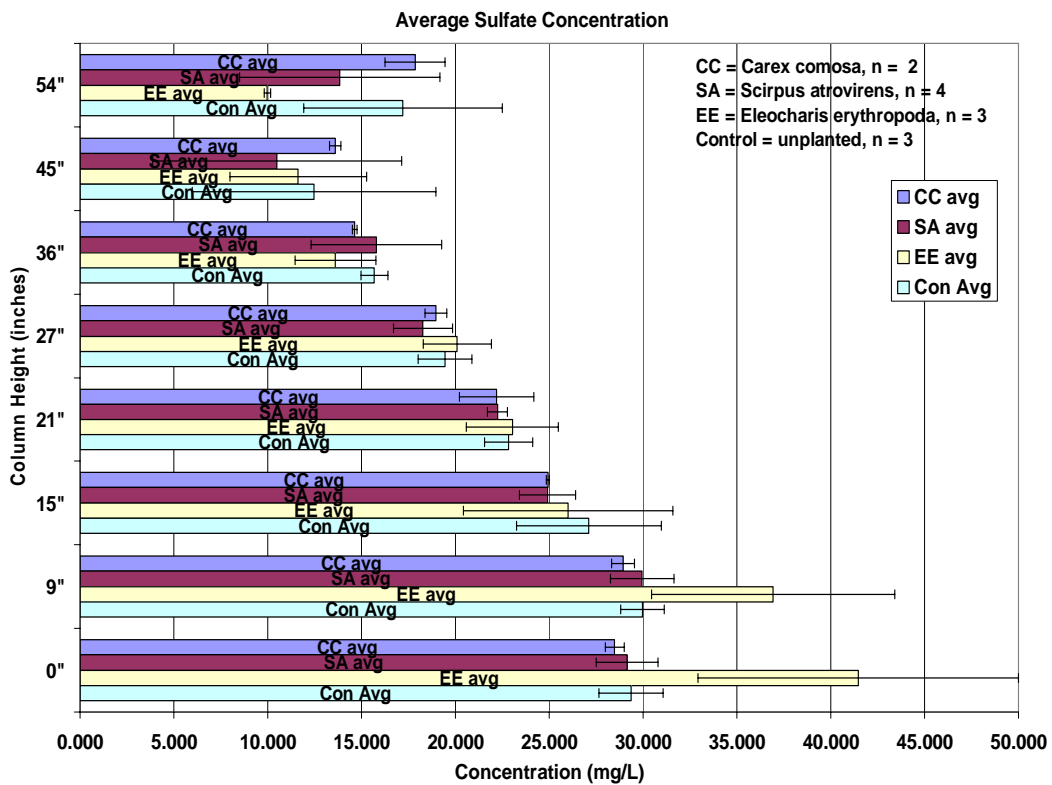

Figure 4.29 Average Sulfate concentrations for all four treatments

Conductivity

Soil conductivity is an indirect measure of the ion content within the soil. Increase in conductivity could be correlated to an increase in ion concentration. However, soil conductivity does not differentiate between what species or mixtures of ions are in the soil. It could also be used to measure bromide concentration during retention time analysis. Finally, conductivity could be used as an indirect measure of the plant's evapotranspiration rate. If conductivity rises as water travels through the column, it could indicate that plants are actively transpiring water, causing an increase in salt concentration. Such an increase in salt concentration could be harmful to the plants, and actions should be taken to flush out the excess salts.

The soil conductivity within the columns has been measured to give a better understanding of the ion activity within the soil. Average conductivity results are shown below in Figure 4.30. All inflow was from the same reservoir tank, so at 0" there were no differences in conductivity results. Between 9" and 36" the soil had little impact on the conductivity, and no significant difference was found between treatments. However, above port 36" the conductivity reading started to increase for all of the planted treatments. This suggests that evapotranspiration is influencing the salt concentration within the top of the columns. *Scirpus atrovirens* had the greatest conductivity increase, followed by *Carex comosa*, both plants have broad leaves useful during evapotranspiration. Only the control treatment did not show a significant increase in conductivity. If evapotranspiration is occurring, it suggests that phytovolatilization of chlorinated chemicals could also be occurring.

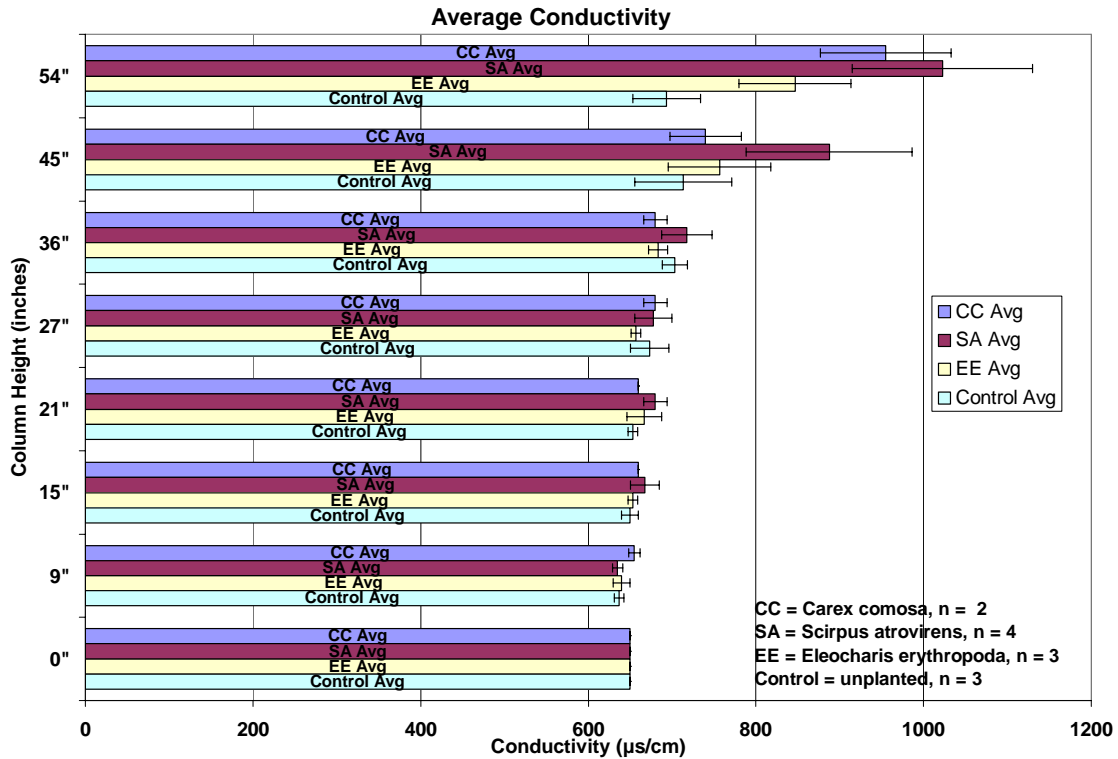

Figure 4.30 Average conductivity for each treatment

Residence Time

In order to assess the residence time for the column reactors several KBr breakthrough tests were conducted. The first test was conducted by injecting a 60 mL plug of 6g/L KBr solution into the influent port of column 9 and the conductivity was measured at the top of the column. However, the conductivity measurements fluctuated with temperature and did not produce any reliable breakthrough curve.

In another attempt to quantify the residence time within the columns a second KBr breakthrough test was performed. KBr was initially injected into the influent port of column 9 and over a period 3.5 days samples were taken out at 27" above the influent port. KBr concentrations from the samples were measured using an IC and the results are shown below in Figure 4.31. After 3.5 days the peak and tail of the curve was still not detected.

Towards the end of the sampling period, in addition to 27", more samples were gathered at 36" and 45" above the influent port (see Figure 4.26). The time for KBr to travel from 27" to 36" and from 36" to 45" could be seen on the figure below. At 27" there was a concentration of 11.5 mg/L at the 58th hr and 36" reached the same concentration 11 hrs later. The same increase could be seen at the 36" and 45" point. At 36" there was a concentration of 9.4 mg/L at the 58th hr and port 6 reached approximately the same concentration 11 hrs later. The total length from influent port to the top most port is 54 inches. If it takes 11 hrs for KBr to travel 9 inches, then residence for the entire column could be interpolated to be 66hr or 2.75 day.

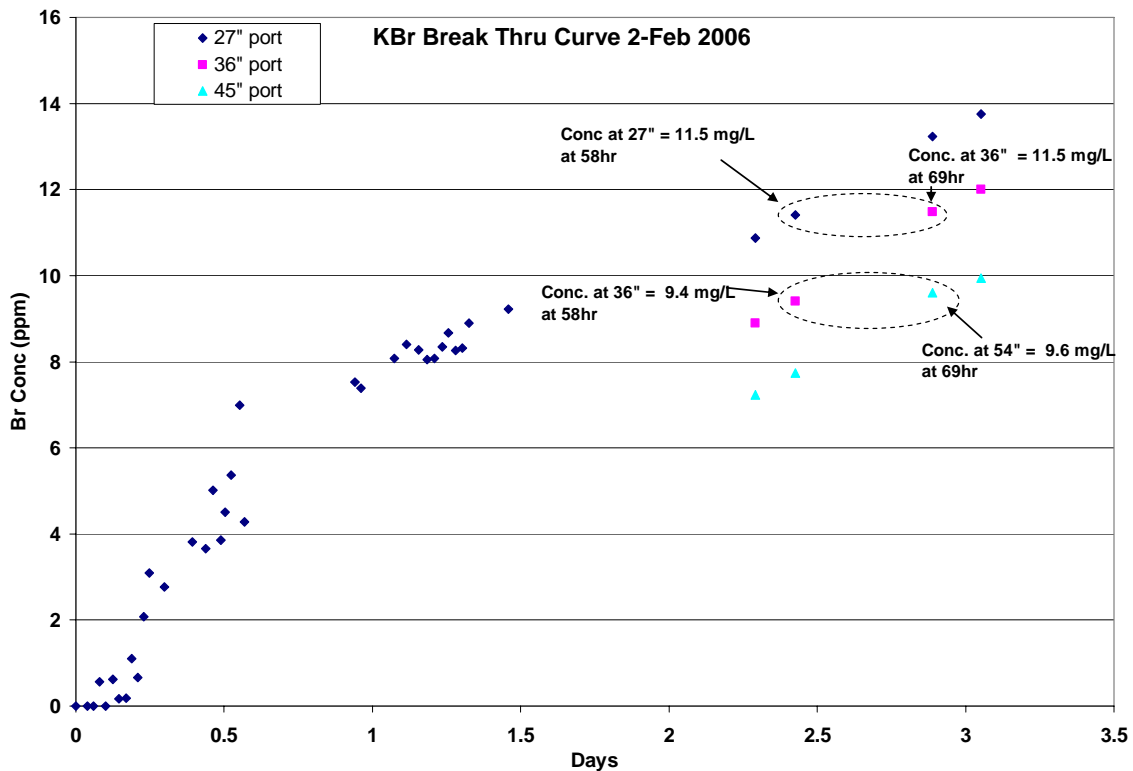

Figure 4.31 KBr breakthrough measurement

V. Discussion

The increase in methane concentration at middle of the mesocosms indicates that methane was being produced within the lower half the columns. It has been shown that methanogenesis occurs under anaerobic conditions (Wiedemeier et al., 1999) and the increases in methane concentration suggest that pockets of anaerobic conditions were developing in the lower half of the columns. This is important because microbial reductive dechlorination of PCE appears to require anaerobic conditions (Bouwer, 1991).

As the water travels up the columns less methane was detected towards the top. This suggests that methane loss is occurring at the upper half of the columns. One possibility is that methane could be oxidized by methanotrophic microbes residing within the root's rhizosphere and within the soil matrix. Plants roots could also be uptaking methane and subsequently volatilizing it into the atmosphere, thus reducing the methane concentration near the surface. Finally, another possibility is that methane is very volatile and could be escaping through the soil pores and into the atmosphere. At port 7 (54") along the column, (Figure 4.1) each of the columns with plants had a lower methane concentration when compare to the control columns without plants. This suggests that, while methane could be escaping through the soil pores, it is occurring at a much slower rate than either plant assisted methane degradation or volatilization. This experiment did not measure the volatilization rate within the column reactors so it can not be determined whether methane degradation or methane volatilization is the dominant process.

However, previously research showed that methane degradation exists during aerobic conditions where methanotrophic bacteria use methane as an energy source

(Chapelle, 1993). Research also showed that co-metabolic degradation of chlorinated solvent could be carried out by methanotrophic bacteria when methane is the primary substrate (Eguchi et al, 2001; Little et al 1998).

Nitrate measurements in the results showed that nitrate concentration for all planted mesocosms increased near the top of the column and the unplanted control columns had no increase in nitrate concentration. Nitrate is produced from ammonium oxidation (Mitsch, 1993) and the increase in nitrate concentration at the tops suggests that ammonium oxidation is occurring. Research has also shown that ammonium oxidizing bacteria could also co-metabolically degrade TCE (Yang et al, 1999).

So, the methane concentration decrease and nitrate concentration increase above 36" suggests that co-metabolic TCE degradation could be occurring. Previous research has suggested that during co-metabolic TCE degradation, the TCE is broken down into TCE epoxide intermediate which then are converted by heterotrophic organisms into CO₂ (Little et al, 1988). However, future research is needed to determine the contaminant volatilization rate of wetland plants in order confirm TCE is being degraded instead being phyto-volatilized into the atmosphere.

Pre and Post Methane comparison

Methane concentration pre-PCE injections were greater than post-PCE injection for all treatments. The methane within the reactors was produced by using carbon dioxide as an electron acceptor during methanogenesis (Chapelle, 1993). This process requires an electron donor and may compete with reductive dechlorination of PCE. PCE reduction reactions have low ΔG_r° and do not generate a lot of energy (Wiedemeier et al.,

1999). However, PCE reduction reactions have a higher ΔG_r^o than methanogenesis (See Table 2.1) and PCE reducers could be competitive with methane generating bacteria for the limited amount of electron donor present in subsurface environment. Therefore, within a natural environment PCE reduction could take up the electron donors normally used for methane production, causing a decrease in methane concentration. The reduction in methane concentration post PCE injection suggests that reductive dechlorination reactions are taking place within the reactors at expense of methane production.

PCE concentration Decrease

After 2 weeks of continuous PCE injections, the water in the reservoir will have been replaced 5 to 6 times. The results of 2nd week PCE concentration decrease between different column intervals is shown in figure 4.18. Between the column intervals 0” to 9”, a student-t comparison of PCE removal showed that the *Carex comosa* PCE concentration decrease was significantly greater than control reactors. No significant differences were shown between the other planted treatments and the control columns. Between 0” and 9”, the 2nd week TCE data (Figure 4.22) showed that the least amount of TCE was detected within the control reactors. Therefore, this suggested that low PCE concentration removal resulted in low concentration of TCE detected.

Between 9” and 15”, *Carex comosa* had a significant drop in PCE concentration removal and *Eleocharis erythropoda* reactors were better at removing PCE at those depths. This suggested that *Carex comosa* could be a better candidate for PCE removal at lower depth below ground around 50” below ground, while *Eleocharis erythropoda*

and the control columns are better at PCE removal slightly higher up around 40" below ground.

Above port 2 (15"), there was less removal of PCE concentrations and no statistically significant difference was detected between mesocosms. The decrease in PCE removal above port 2 suggest that methane and nitrate concentrations increase within the reactors maybe influencing PCE degradation.

Optimum PCE reduction occurs in the same redox zone as methanogenesis (Wiedemeier et al., 1999), so the fact that methane concentration increased at the bottom of the reactors (Figure 4.14 -4.17) indicates that conditions are favorable for PCE reduction. However, methanogenesis reactions also competes with PCE for electron donors (Chapelle, 1993). So the increase in methane production could also inhibit PCE reduction and could be the reason why less PCE was removed above 15"

Nitrate concentration in the groundwater would also influence PCE reduction rates. Nitrate reduction produces more energy than PCE reduction (Wiedemeier et al., 1999) and bacteria would preferentially use nitrate in the subsurface (Mitsch, 1993). So the increase in nitrate concentration at the top of planted columns (Figure 4.23) could also inhibit PCE reduction.

However, this was only 2 weeks after PCE injections began and the mesocosm within the columns are only beginning to adapt to the presence of a new chemical. It may not have developed the microbial capability to degrade PCE. Figure 5.1 below shows the absolute value of PCE concentration decrease as compared to the TCE concentration increase between the influent port and port 2 (0" to 15"). It could be seen that for all treatments the PCE concentration decrease was significantly greater than the

concentration of TCE formed. No comparisons were made for PCE concentration decrease between treatments due variability among influent concentration.

Significant amounts of PCE concentration decrease occurred between the 0” and 15” and the lack of TCE increase suggests several possibilities. One, PCE could be sorbed onto soil and organic particles instead of degrading. Two, TCE maybe degraded as well and the low TCE concentration shown on Figure 5.1 could be due to the fact that TCE has been degraded to DCE or VC which are harder to detect. Three, low concentration of TCE could also be due to TCE binding to soil particles. Previous experiments showed that significant amounts of TCE could bind to hydric soils much like the one used in this experiment (Enwright, 2002).

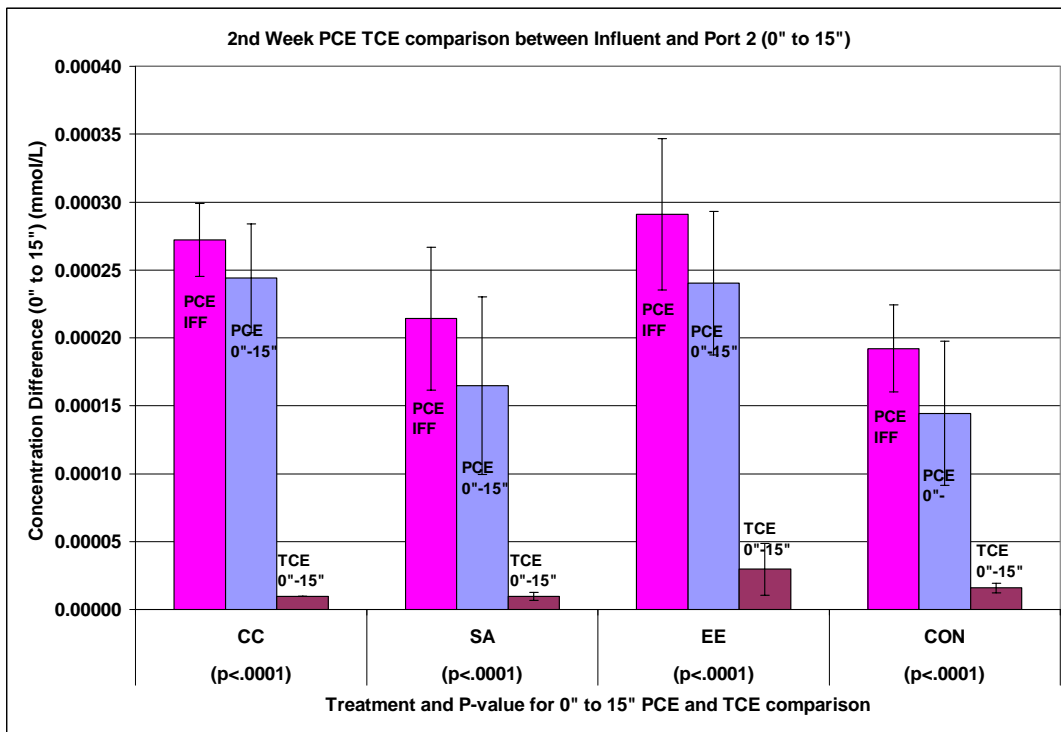

Figure 5.1 PCE & TCE comparison at week 2. PCE influent concentration and absolute value of PCE decrease and TCE increase between influent and port 2. With a P-value < 0.0001 there are significant differences among 0-15” TCE and PCE for all treatments

6th Week

After 6 weeks of continuous PCE injections, the PCE concentration removed between each port is shown in figure 4.16. A student-t comparison among mesocosms showed that between the interval 0'' to 9'' *Carex comosa* had the greatest concentration of PCE removed (see Figure 5.2).

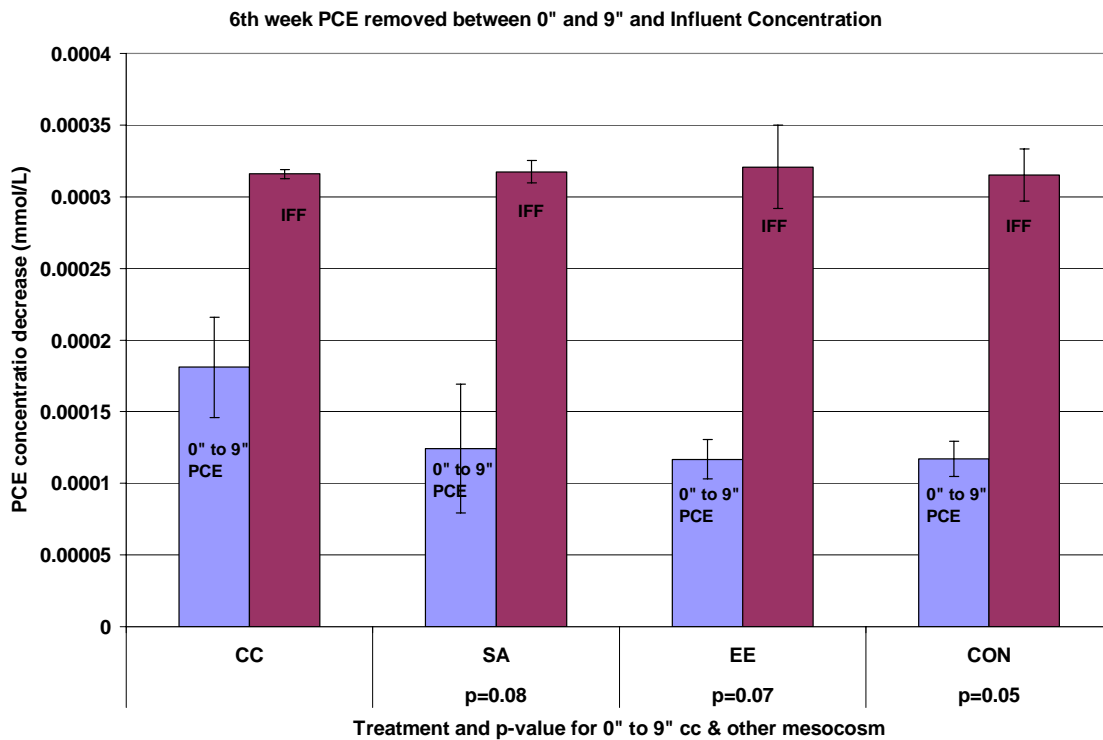

Figure 5.2 6th week comparison of PCE removal between 0'' and 9''. Comparisons and p-values are between *Carex comosa* and other treatments.

Analysis of other ports did not show any statistical significant PCE concentration difference between treatments. Figure 5.3 shows the total PCE concentration removed within the entire column (0'' to 54'') and there were no significant difference in the total amount of PCE removal between each treatment. So even though *Carex comosa* had greater reduction of PCE concentration between the 0'' and 9'', overall along the entire length there was no difference between the removal efficiency of all the treatments..

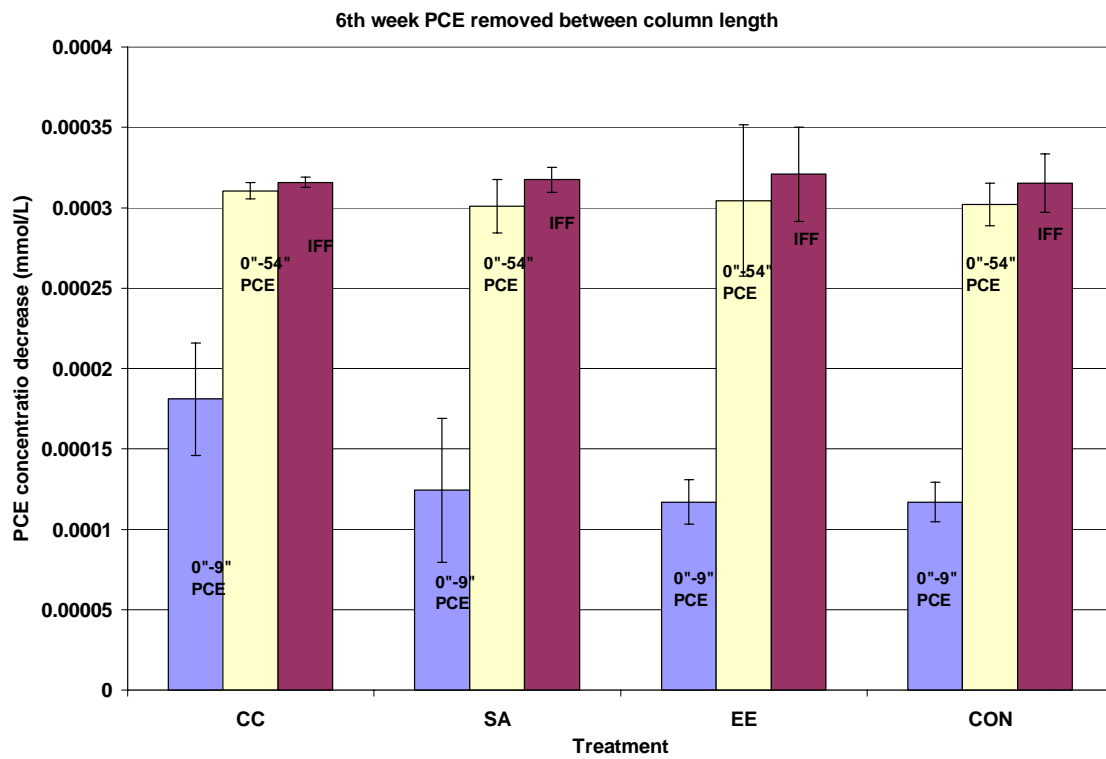

Figure 5.3 6th week PCE concentration decrease between 0" to 54" , between 0" and 9" and the influent PCE concentration. There was no significant difference among treatments for 0" to 54" PCE removal. ($p > 0.1$)

As with week 2 data, it is important to understand how much TCE was detected and compare it with the concentration of PCE removed. Figure 5.4 shows a comparison of PCE and TCE concentration difference between the influent port and port 2 (0'' and 15''). It could be seen that the 6th week PCE concentration decrease was still greater than TCE concentration detected. However, the TCE concentration at week 6 was statistically greater than the TCE concentration at week 2. This data suggests that: One, less TCE sorption was occurring because more TCE was detected during week 6. Two, microbial colonies were beginning to establish themselves and starting to become more effective at PCE degradation at week 6. Three, the discrepancy between PCE and TCE concentration could be due to TCE degrading into daughters products (DCE isomers, VC, ethene, CO₂) or being phyto-volatilized by plants (Lunney, 2004).

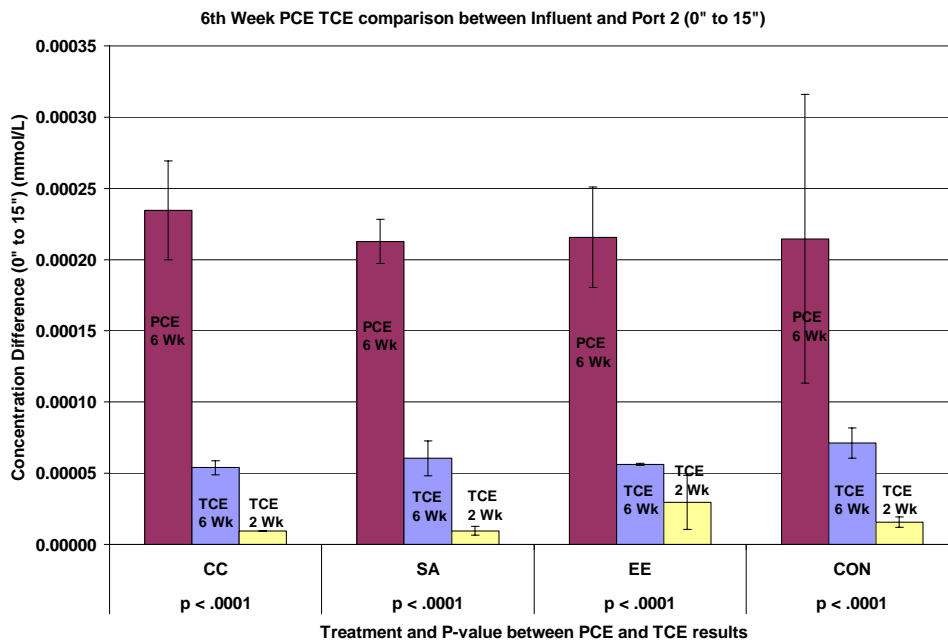

Figure 5.4 6th Week PCE removed between 0'' and 15'' . 2nd and 6th week comparison of TCE removed between 0'' and 15''. Student t-test showed significant difference between the TCE increase at week 6 with TCE increase at week 2. P-values shows comparison between 6th and 2nd week PCE removal

TCE:

Since the 6th week results showed no significant difference in total PCE removal among all four treatments (Figure 5.3), the next question of concern is the removal efficiency of TCE. Figure 4.13 showed that the 6th week TCE concentration for all planted columns initially increased to a maximum in the middle of the reactors and then the concentration began to decrease along the upper half of the columns. The build up of TCE concentration within the bottom half of the reactors could be due to the slow rate of TCE reduction. Studies have shown that reductive dehalogenation of PCE could occur under anaerobic conditions but as the number of chlorine atoms on the molecule decrease the rate of reductive dechlorination also decreases (Chapelle, 1993). So TCE with one less chlorine atom, would take longer to degrade, causing a temporary TCE build up in the lower half of the reactors. In the upper half of the reactors, TCE removal has begun to occur, as seen by the decreasing concentration of TCE within the planted columns (Figure 4.9). This suggests that plants have an influence on TCE concentration and possible mechanisms behind the removal will be explained below.

The control treatments also had a TCE concentration increase in the lower half of the reactors but it did not exhibit the same TCE concentration decrease in the upper half of the reactors, as seen in the planted columns. This was especially true between ports 6 and 7 (45'' and 54'') where the control column TCE concentration increased to a maximum level.

Therefore, a student-t test with an alpha=0.1 was conducted on the week 6 TCE concentration found at port 7 (54''). Port 7 is the highest port on the column and would be most representative of the effluent concentration. Figure 5.5 below shows that at port 7

the average TCE concentration within the control reactors was statistically greater than the TCE concentration found within the planted reactors. However, a comparison among each of the planted reactors showed no significant difference among the planted reactors.

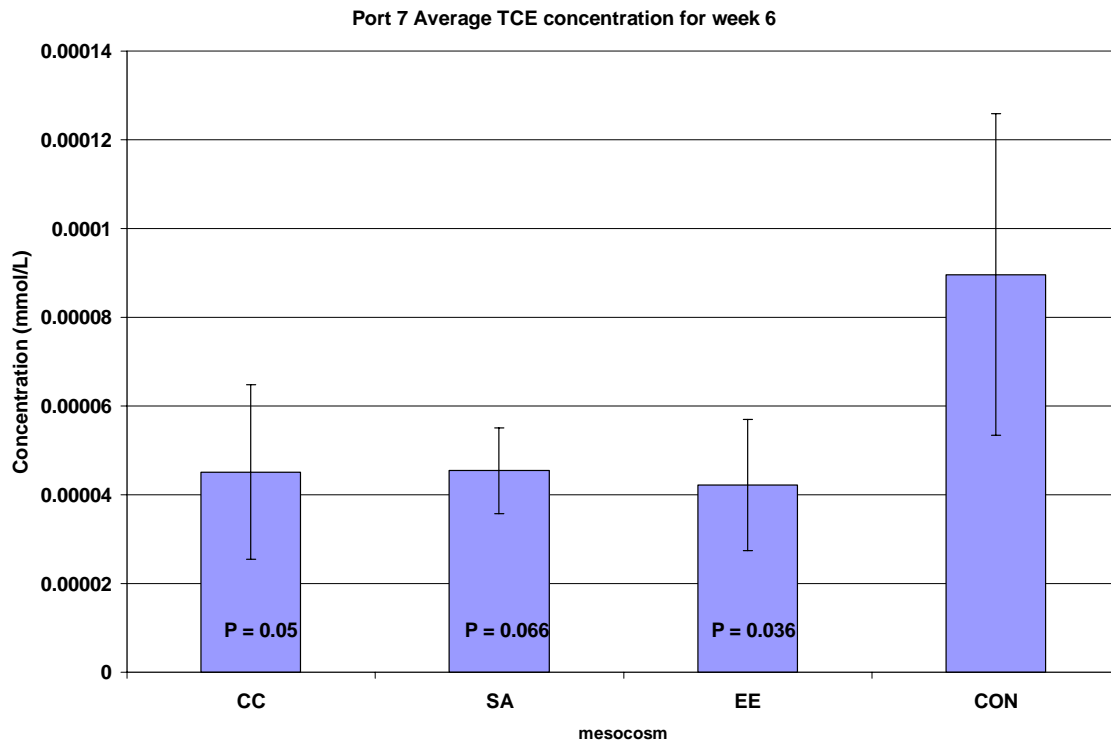

Figure 5.5 Average TCE concentrations from port 7. P-values on the figure are generated from a student-t test between the control reactors and each of the planted reactors.

Since the decrease in TCE concentration occurred only for planted columns, the results supported the fact that plants have an effect on the TCE concentrations in the subsurface. The presence of roots near the top of the columns could affect TCE concentrations in several ways. Plant roots could uptake TCE through phytoextraction and then volatilize gaseous TCE into the atmosphere through phytovolatilization (Lunney, 2004). Plants could also be transporting oxygen into the soil (Armstrong et. al, 2000; Bankston, 2002) which in turn support aerobic co-metabolic degradation of TCE.

Plant roots extrude photosynthetic products such as amino acids, sugar, and vitamins into the rhizosphere (Walton, 1994) and the substrates could then be used to stimulate microbial facilitated degradation.

Plant uptake of TCE and oxygen transport within the plant root was not investigated during this experiment. Future study is also needed to assess the volatilization rate with plants to determine how much contaminant is being volatilized into the atmosphere. Plant tissues could also be examined to determine how much contaminants has been sequestered into plant tissues such as roots and leaves.

In this experiment 1,2 cisDCE, 1,2 transDCE, and ethylene was not detected. These chemicals are degradation products of PCE and the non-detection of these chemicals suggest several possibilities. One, previous research showed that *Dehalococcoides* could degrade PCE all the way to ethane(Smidt and Vos, 2004). Previous research also showed that iron reducer could degrade DCE isomers and VC (Lee, 1998). So if the conversion rate PCE degradation products are very quick, then no accumulation would be detected. Two, co-metabolic degradation of TCE results in the production of CO₂ (Little et al, 1988). A study has proposed that during co-metabolic TCE degradation, TCE is first converted into TCE epoxide and then it is degraded by heterotrophic bacteria into CO₂ (Little et all, 1988). The carbon dioxide could then be dissolved in water and become part of the carbonate cycle or it could escape through soil pore into the atmosphere. Therefore no DCE or VC would accumulate during co-metabolic TCE degradation. Three, plants could have an influence on the concentrations of these chemicals. Phytoextraction and phytovolatilization (Lunney, 2004) could allow possible transport of these products into the atmosphere.

Sulfate and Nitrate comparison

Sulfate and nitrate concentration within the column reactors were investigated in this experiment. Figure 5.6 below overlaid the nitrate reading above the TCE concentration to compare the trend between nitrate and TCE (Nitrate concentration is ppm). Below 27 inches the nitrate concentration did not significantly increase. In that same zone the majority of TCE has been detected and nitrate did not appear to have any effect on TCE production. However, it is unclear whether more TCE could have been detected if the nitrate concentration was lower.

Above 36", the nitrate concentration for the planted mesocosms started to increase. This suggested that plant roots were having an influence on soil chemistry at those depths. Above 36" TCE concentrations started to decline for all planted columns. This suggested two possibilities: One, nitrate is produced from ammonia oxidation and the enzymes used during ammonia oxidation could also co-metabolize TCE (Yang, 1999). So the increased nitrate and decreased TCE concentration could indicate that TCE is being co-metabolically degraded into CO₂. Two, the wetland plants could also influence TCE concentration through uptake and venting.

Above 36", the unplanted control reactors had no increase in nitrate concentration. This reiterated the suggestion that plants do have an influence on the nitrate concentration. At the same depth TCE concentration also increased within the control reactors. Again this suggest two possibilities: One, microbes reducing nitrate out competes PCE reducing microbes (Chapelle, 1993) and the presence of nitrate would inhibit microbial reductive dechlorination of PCE. Therefore, within the unplanted control there was less nitrate available to inhibit PCE reduction and TCE concentration

would increase. Two, the lack of plants could be causing TCE to accumulate within the columns, since no uptake or volatilization could occur.

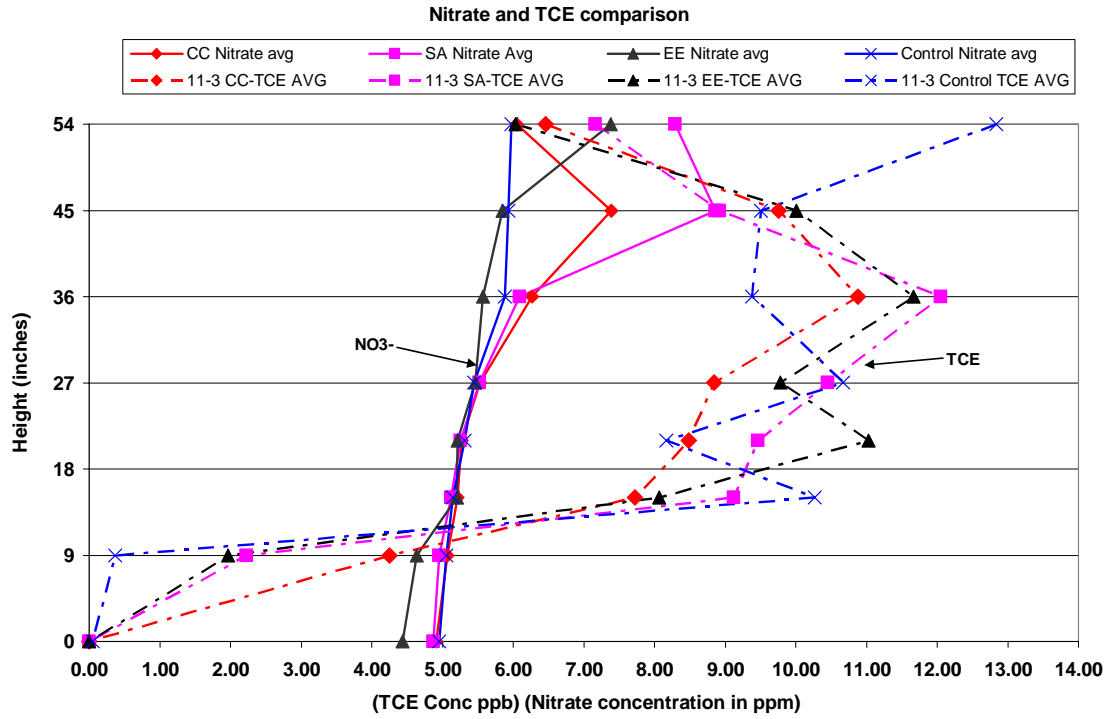

Figure 5.6 Overlay of nitrate trend with 6th week TCE concentration for comparison.

Figure 5.7 below overlaid the sulfate reading above the TCE concentration to compare the trend between sulfate and TCE (sulfate concentration is in ppm) Sulfate reduction has approximately the same redox potential as PCE reduction (see Figure 2.4). The decrease in sulfate concentration suggests that sulfate reduction reactions are taking place and that PCE reduction could also occur. TCE was compared with sulfate because any TCE detected within the reactors be attributed to PCE degradation. According to the figure there is no correlation between sulfate concentration and TCE production. Along the length of the column TCE concentration are varying independent of the sulfate concentration.

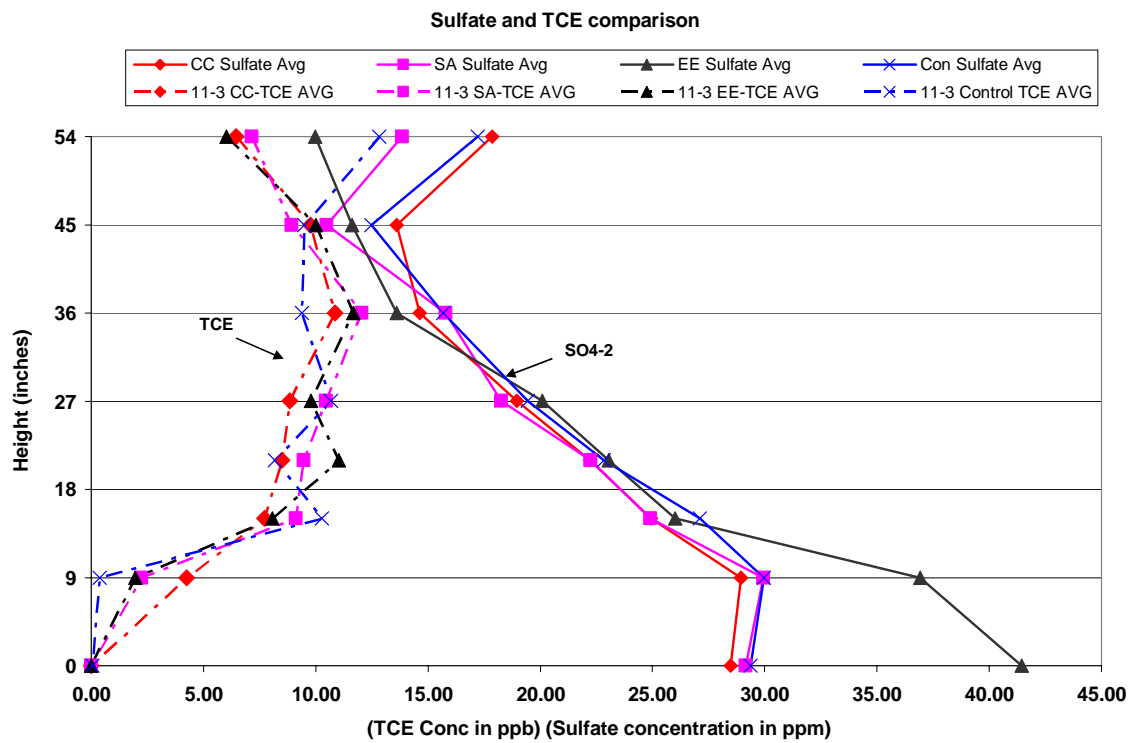

Figure 5.7 Overlay of sulfate trend with 6th week TCE concentration for comparison.

Methane and TCE

Methane production in subsurface competes with reductive dechlorination for electron donors (Wiedemeier et al., 1999). So an increase in methane concentration in the reactors could also impact the PCE removal rate. Figure 5.8 -5.11 overlays the methane with TCE concentration and compares the trend of two species. TCE was used in the comparison instead of PCE because TCE detected in the columns could be attributed to PCE degradation.

The figures below are taken from the 6th week samples and below 18 inches TCE concentration increased as methane increased. This suggests that the bottom of the column provides the necessary reductive environment for both methanogenesis and reductive dechlorination. However, between 18" and 36" TCE concentration for all treatment remained steady and did not have a large increase. At the same depth the methane concentration varied among treatments. The methane concentration for the planted columns reached a maximum at different depth: *Carex comosa* reached a maximum at 27", for *Scirpus atrovirens* at 21", for *Eleocharis erythropoda* at 36". Since the TCE concentration leveled off at the middle of the column and methane concentration increased, it suggest that methanogenesis is out competing PCE degradation. The leveling off of TCE concentration could also suggest that iron reducing microbes could be reducing TCE to a DCE isomer (Lee et al, 1998).

Above 36" inches, both methane and TCE concentration decreased for the planted columns. However the control columns continued to increase in both methane and TCE. This suggests that plants have an influence on both methane and TCE concentration. In the planted columns, co-metabolic degradation of TCE could be taking

place or plants could directly uptake and vent TCE. In the control column no plants are available to transport oxygen to the root rhizosphere (Armstrong, 2000) and therefore methane oxidation and TCE co-metabolic degradation may be inhibited. Another possible suggestion for the TCE increase within the control columns could be TCE accumulating within the columns because plants are not available for phytovolatilization.

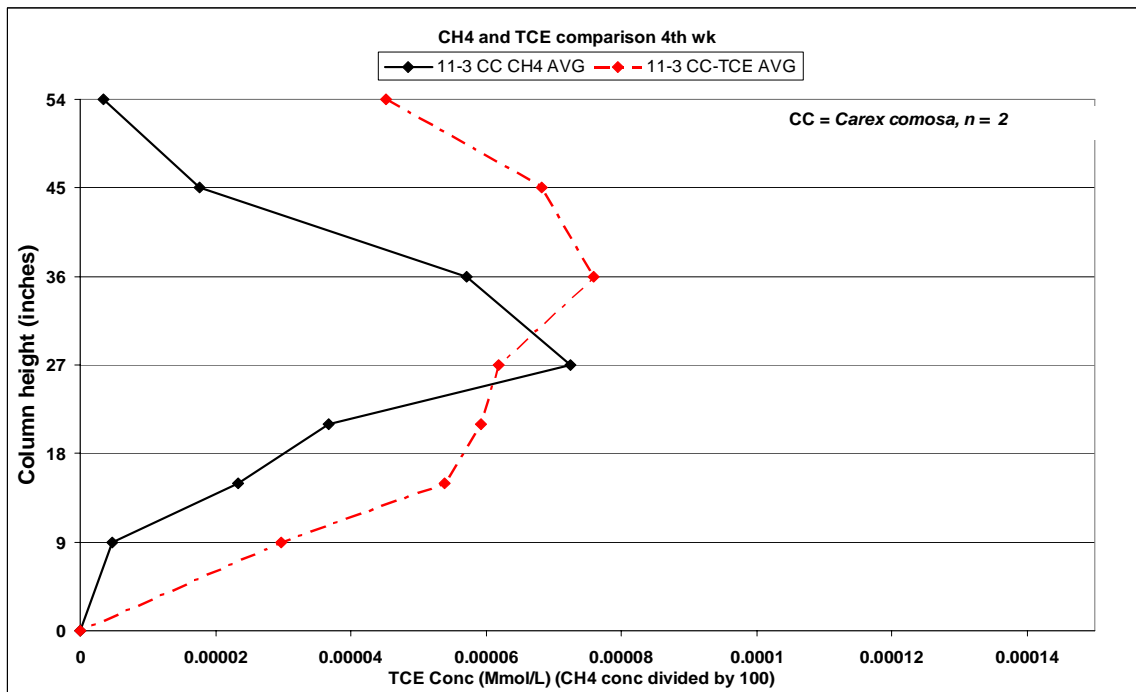

Figure 5.8 Overlay of *Carex comosa* reactor methane and TCE concentration for comparison

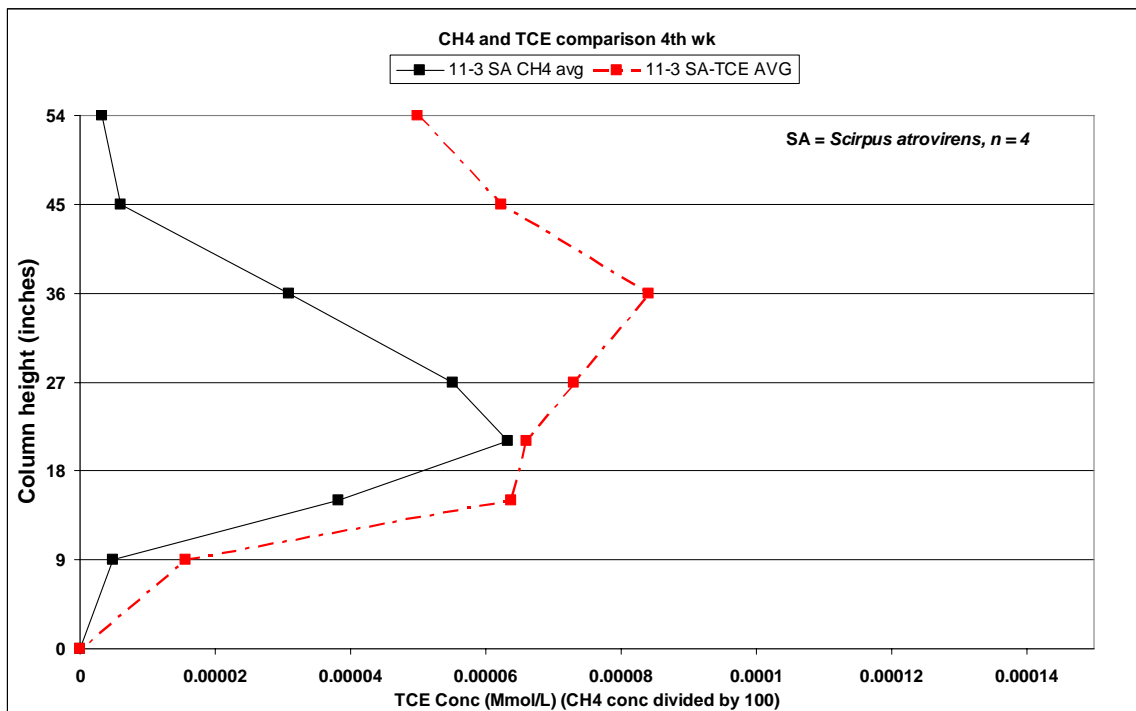

Figure 5.9 Overlay of *Scirpus atrovirens* reactor methane and TCE concentration for comparison

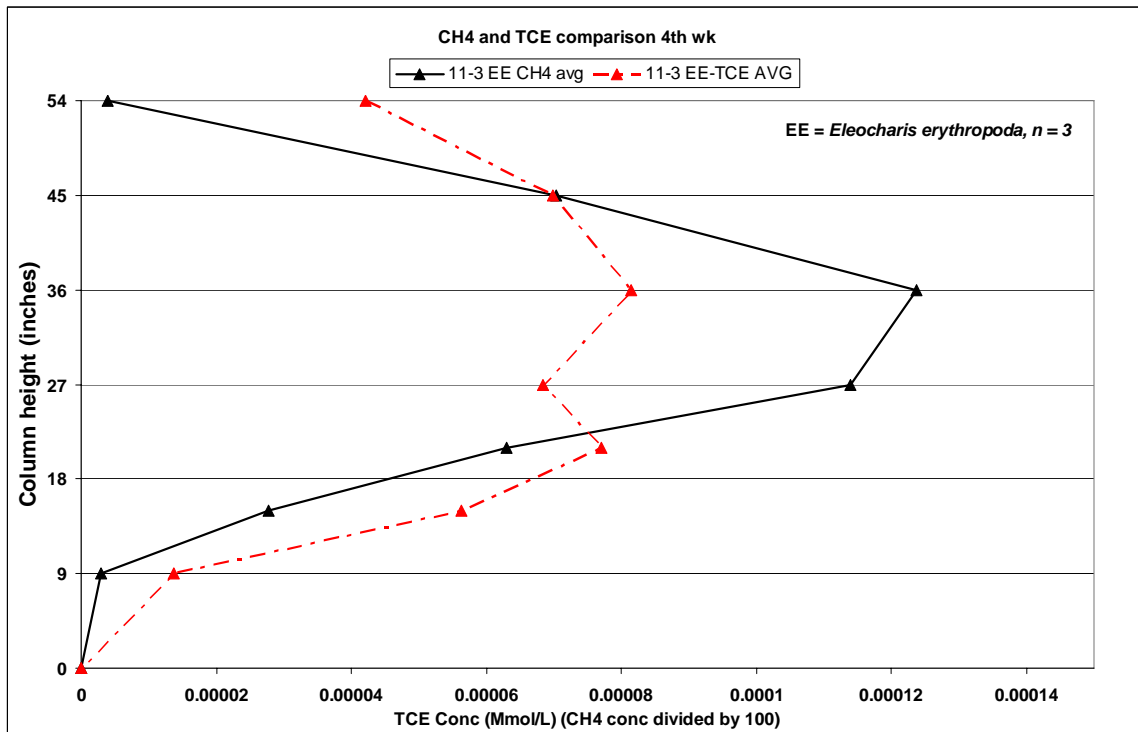

Figure 5.9 Overlay of *Eleocharis erythropoda* reactor methane and TCE concentration for comparison

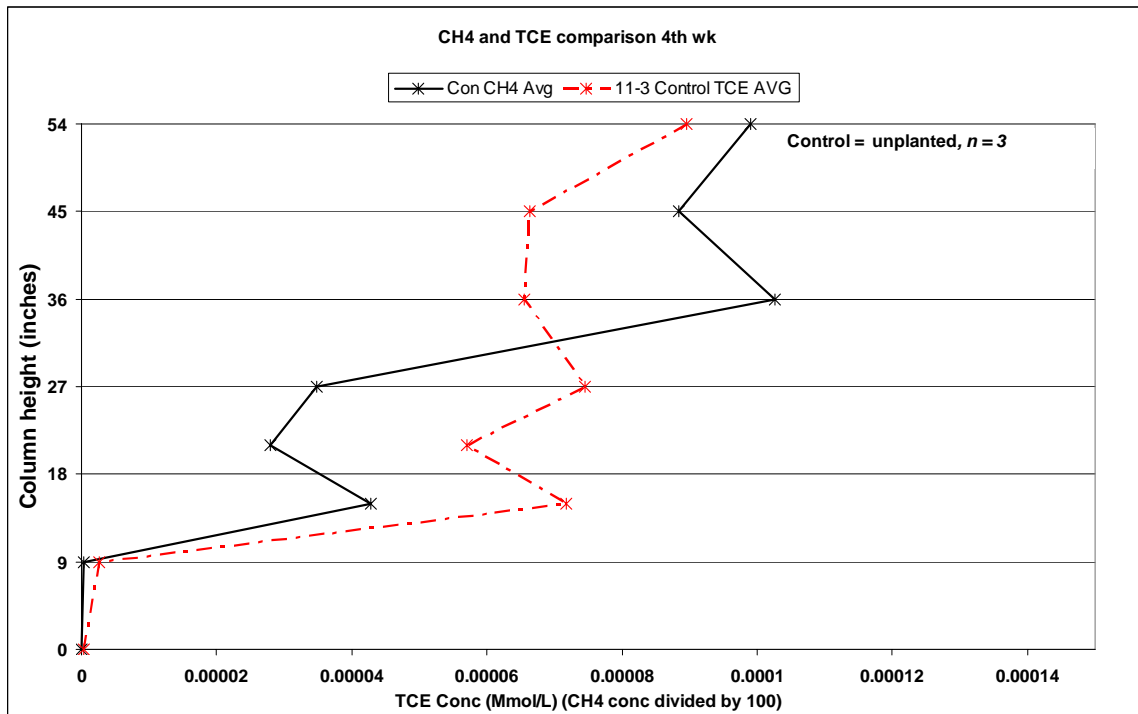

Figure 5.9 Overlay of control reactor methane and TCE concentration for comparison

VI Conclusion

The purpose of this research was to study three different wetland plant species and an unplanted control, in order to determine which plant species was best for chlorinated solvent removal. A low concentrated PCE solution will be injected into the plant mesocosm and then samples will be gathered and analyzed to determine the concentrations of chlorinated ethenes within the mesocosms. This studied was modeled after the constructed wetland at WPAFB and column reactors were constructed to determine the PCE removal efficiency among each plant species. A total of seven sampling ports were spaced along the length of the columns to allow for better assessment of contaminant concentration at different depth within the columns. A sampling methodology was developed for the column reactors and samples were gathered for conductivity, chlorinated solvent, nitrate and sulfate measurements.

Answers to specific research questions

1. *Is there a significant difference in chlorinated solvent degradation among the plant species and the unplanted control treatment?*

The presence of TCE in the columns demonstrated that PCE was being degraded. However, after 6 weeks of continuous PCE injections there were no significant differences in total PCE removal among any of the treatments. Between the influent port and port 7 (0" to 54"): *Carex comosa* removed 48.14 +/- 0.797 ppb, *Scirpus atrovirens* removed 47.14 +/- 3.054, *Eleocharis erythropoda* removed 47.19 +/- 7.304 ppb, and the control column removed 47.139 +/- 2.062 ppb. All treatments including the control reactors removed approximately the same concentration of PCE. However, the PCE concentration removed does not differentiate between removal mechanisms. Sorption,

degradation, phyto-volatilization, and phyto-assimilation are all combined to produce the removal results shown.

The total PCE degradation could be determined by analyzing the concentration of TCE formed. At port 7 (54”) the TCE concentration are as follows: *Carex comosa* TCE concentration was 6.463 +/- 2.822 ppb, *Scirpus atrovirens* TCE concentration was 6.510 +/- 1.383, *Eleocharis erythropoda* TCE concentration was 6.037 +/- 2.118 ppb, and the control column TCE concentration was 12.833 +/- 5.191 ppb.

There was no significant TCE concentration difference between the planted treatments. However, the control columns had significantly greater TCE concentration at the 54” near the top the column. This suggests several possibilities: One, without plants, phytovolatilization will not occur and thus TCE may be accumulating within the mesocosms. Two, the control mesocosm had high methane concentrations (Figure 4.13) at the top of the reactors. The accumulation in methane suggested that both methane oxidation and co-metabolic TCE degradation maybe inhibited . Thus, TCE would not accumulate within the columns. Third, the control columns had no increase in nitrate concentration suggesting that ammonia oxidation was not occurring and again co-metabolic TCE degradation was not occurring. Thus leading to an increase in TCE concentration.

TCE is monitored by the EPA and any treatment option would also require the removal of TCE from the system. So even though there were no differences in PCE degradation among mesocosms, the unplanted control mesocosm was not efficient at TCE removal. Therefore plants are needed in any constructed wetland pollution

treatment option. However, the planted columns showed no significant difference in total PCE removed and it also showed no difference in the TCE concentration at port 7. More studies are needed to determine possible contaminant removal mechanism with each plant. But based on just my results all three wetland plants species under observation could be viable candidate for wetland pollution treatments.

2. *Is there a difference in sulfate, nitrate and methane concentration among the reactors?*

There was a difference in the sulfate concentration among the reactors. At the bottom of the column at 0" and 9" *Eleocharis erythropoda* had significantly greater sulfate concentration. Between 9" and 45" there was no significant difference in sulfate concentration among all treatments. At 54" the control columns had significantly greater sulfate concentration than *Eleocharis erythropoda* and a comparison of the other treatments did not show any significant difference. Even though sulfate had some differences between treatments, the results were not consistent with expectations and no conclusions could be drawn.

Between 0" and 36" there was no significant difference in nitrate concentration among all the treatments. However, at 45", a student-t analysis with $\alpha=0.1$ found the nitrate concentration for *Scirpus atrovirens* to be statistically greater than both *Eleocharis erythropoda* and control columns (p-value = .003). All other treatments have no statistical difference. At 54" there was no statistical difference among all treatments.

The methane concentration below 18" increased for all treatments. This suggests that the bottom of the column provides the necessary reductive environment for both

methanogenesis. However, between 18” and 36” the methane concentration varied among treatments. The methane concentration for the planted columns reached a maximum at different depth: *Carex comosa* reached a maximum at 27”, for *Scirpus atrovirens* at 21”, for *Eleocharis erythropoda* at 36”.

Above 36” inches, methane decreased for the planted columns. However the control columns continued to have methane increase. This suggests that plants are influencing methane concentration, methane are removed either through aerobic methane oxidation or plants themselves are uptaking methane.

3. Do the sulfate, nitrate, and methane concentration influence PCE degradation?

Results showed that sulfate concentration did not influence PCE degradation (Figure 5.7). However, nitrate concentrations did have an influence on PCE degradation. Figure 5.6 showed that above 36”, the nitrate concentration for the planted columns increased, suggesting that plant roots were having an influence on groundwater chemistry at those depths. At those same depths TCE concentration started to decrease for the planted columns. So increasing nitrate concentration suggests that less TCE was formed or that TCE was being co-metabolically degraded to CO₂.

The control reactors maintained the same nitrate concentration between 36” and 54 ” and TCE concentrations in the control reactors started to increase at those depth. This suggested that the lack of nitrate increase was causing TCE to accumulate within the mesocosm.

Methane also influence TCE degradation and below 18” the methane and TCE concentration increased together. However, above 18”, TCE concentration remained steady while methane concentration for all treatments increased. This suggests that when methane concentration increased over a certain threshold it inhibited PCE degradation. Finally, above 36” methane and TCE both decreased for the planted columns. Suggesting that methane could be oxidized at those depth and co-metabolic degradation of TCE could be taking place.

Limitations

Some benefits that may be associated with plant assisted contaminate remediation include direct removal of chlorinated solvents through the mechanism of phytoextraction, phytodegradation, and phytostabilization. This laboratory study was conducted under controlled conditions and does not fully reflect natural conditions. The temperature inside the greenhouse laboratory never dropped below 15 °C and lighting was controlled to give at least 13 hrs of light each day. These conditions were quite different from the constructed wetland, where the climate varies considerably during each season.

Appendices

Appendix A: Chlorinated Ethene Sampling Method

All samples for the gas chromatograph were gathered with a Hamilton Gastight 10mL syringes. Samples are stored in a 10 mL serum bottles and capped with a 20mm Teflon coated serum stopper and aluminum crimps. The following list goes over the sampling procedure used during chlorinated ethene sampling.

Sample bottle preparation:

1. Cap each serum bottle with Teflon coated caps and crimp tightly.
2. Flush each serum bottle with approximately 60 mL of nitrogen gas

Sampling Methodology:

1. Start at the column one and move laterally, sampling the top ports (port 7) of each consecutive column.
2. After port 7 of all the columns have been sampled, proceed to the next lower port (port 6) and again move laterally until all of the columns have been sampled. Proceed in this pattern until all desired ports are sampled.

Port sampling procedure:

1. Open desired port and purge the dead space in the sampling tubing by draining and discarding 15 mL of liquid. Measure with graduated cylinder. This flushes out the dirt blockage inside the sampling tube, as well as any liquid that accumulated in the dead space.
2. Afterwards, attach a 10mL gastight syringe to the port and fill syringe by slowly drawing back on the plunger.
3. After sampling tilt the syringe with needle facing up and eject any bubbles inside the syringe.
4. If sample fluid contains dirt particles and the fluid is not transparent, keep the syringe inverted and allow dirt particles to settle for 10 minutes.
5. Keeping the syringe inverted, inject 5mL into an inverted 15 mL serum bottle. Do not inject any of the soil particles from the bottom of the syringe.
6. Keep the serum bottle inverted, to be transported back to lab

7. Spin sample bottle overnight for 12 hrs to achieve equilibrium. Keep the bottles inverted at all times to maintain a water seal and prevent gas from escaping.
8. After 12 hrs perform head space analysis on the GC.

Appendix B: GC 6890 Run Method

| | | | | |
|-------------------------|-------------------|------------|------|--------------------------------|
| | 6890 | GC | | METHOD |
| OVEN | | | | |
| Initial temp: | 50 | 'C | | Maximum temp: 240 |
| Initial time: | 2 | min | | Equilibration time: 1 min |
| Ramps: | | | | |
| # | Rate | Final Temp | | Final Time |
| 1 | 10 | 100 | | 1.25 |
| 2 | 0.0(Off) | | | |
| Post temp: | 50 | 'C | | |
| Post time: | 0 | min | | |
| Run time: | 8.25 | min | | |
| FRONT INLET | | | | BACK INLET |
| Mode: | Splitless | | | Mode: |
| Initial Temp: | 200 | 'C | (On) | Initial Temp: |
| Pressure: | 5.45 | psi | (On) | Initial Temp: |
| Purge flow: | 19.7 | mL/min | | Pressure: |
| Purge Time: | 0 | min | | 0 psi (Off) |
| Total Flow: | 24.2 | mL/min | | Total Flow: |
| Gas Saver: | Off | | | 45 mL/min |
| Gas Type: | Helium | | | Gas saver: |
| | | | | Off |
| | | | | Gas type: |
| | | | | Helium |
| COLUMN 1 | | | | COLUMN 2 |
| Capillary column | Column | | | Capillary column |
| Model Number: | J&W | 1134332 | | Model Number: |
| GS Gas Pro | | | | Agilent |
| Max Temp: | 230 | 'C | | 9091V-413 |
| Nominal Length: | 30 | m | | HP-624 special analysis column |
| Nominal Diameter: | 320 | um | | Max Temp: |
| Nominal film thickness: | 0 | | | 260 'C |
| Mode: | Constant flow | | | Nominal Length: |
| Initial Flow: | 2.1 | mL/min | | 30 m |
| Nominal init pressure: | 9.85 | psi | | Nominal Diameter: |
| Average Velocity: | 34 | cm/sec | | 320 um |
| Inlet: | Front Inlet | | | Nominal film thickness: |
| Outlet: | Front detector | | | 1.8 um |
| Outlet Pressure: | ambient | | | Mode: |
| | | | | Initial Flow: |
| | | | | 2 mL/min |
| | | | | Nominal init pressure: |
| | | | | 9.84 psi |
| | | | | Average Velocity: |
| | | | | 34 cm/sec |
| | | | | Inlet: |
| | | | | Front Inlet |
| | | | | Outlet: |
| | | | | Back detector |
| | | | | ambient |
| | | | | Outlet Pressure: |
| | | | | ambient |
| FRONT DETECTOR (FID) | | | | BACK DETECTOR (ECD) |
| Temperature: | 250 | 'C | (On) | Temperature: |
| hydrogen flow: | 40 | mL/min | (On) | 250 'C (On) |
| Air flow: | 450 | mL/min | (On) | Anode Purge flow: |
| Mode: | istat makeup flow | | | 6 mL/min (On) |
| Makeup flow: | 45 | mL/min | | Mode: |
| Make up gas type: | Nitrogen | | | Constant Makeup Flow |
| Flame: | On | | | Makeup Flow: |
| Electrometer: | On | | | 60 mL/min (On) |
| Lit Offset: | 2 | | | Makeup Gas Type |
| | | | | Nitrogen |
| | | | | Adjust offset |
| | | | | 60 |
| SIGNAL | 1 | | | SIGNAL |
| Data Rate: | 20 | Hz | | 2 |
| Type: | Front Detector | | | Data Rate: |
| Save Data: | On | | | 20 Hz |
| Zero: | 0 | (Off) | | Type: |
| Range: | 0 | | | back detector |
| Fast Peaks: | Off | | | Save Data: |
| Attenuation: | 0 | | | On |
| | | | | Zero: |
| | | | | 0 (Off) |
| | | | | Range: |
| | | | | 0 |
| | | | | Fast Peaks: |
| | | | | Off |
| | | | | Attenuation: |
| | | | | 0 |
| COMP | 1 | | | COLUMN |
| Derive from | front | detector | | COMP |
| | | | | 2 |
| | | | | Derive from |
| | | | | back detector |

Appendix C: IC run method

| Brad Improved Short Program: | Bromide Tracer JY |
|--|--|
| Cartridge serial number: 040602435015 type: EluGen-OH. | Cartridge serial number: 040602435015 type: EluGen-OH. |
| Pressure.LowerLimit = 200 | Pressure.LowerLimit = 200 |
| Pressure.UpperLimit = 2500 | Pressure.UpperLimit = 2500 |
| %A.Equate = "Water" | %A.Equate = "Water" |
| %B.Equate = "%B" | %B.Equate = "%B" |
| %C.Equate = "%C" | %C.Equate = "%C" |
| %D.Equate = "%D" | %D.Equate = "%D" |
| Flush Volume = 100 | Flush Volume = 100 |
| Wait FlushState | Wait FlushState |
| Wait finished | Wait finished |
| NeedleHeight = 5 | NeedleHeight = 5 |
| CutSegmentVolume = 10 | CutSegmentVolume = 10 |
| SyringeSpeed = 3 | SyringeSpeed = 3 |
| ColumnTemperature = 30 | ColumnTemperature = 30 |
| Cycle = 0 | Cycle = 0 |
| Data_Collection_Rate = 2.0 | Data_Collection_Rate = 2.0 |
| Temperature_Compensation = 1.7 | Temperature_Compensation = 1.7 |
| Oven_Temperature = 30 | Oven_Temperature = 30 |
| Suppressor_Type = SRS | Suppressor_Type = SRS |
| Suppressor_Current = 100 | Suppressor_Current = 135 |
| Flow = 1.50 | Concentration = 35.00 |
| %B = 0.0 | EluentGenerator.Curve = 5 |
| %C = 0.0 | Flow = 1.50 |
| %D = 0.0 | %B = 0.0 |
| Pump.Curve = 5 | %C = 0.0 |
| WaitForTemperature = False | %D = 0.0 |
| Wait SamplePrep | Pump.Curve = 5 |
| Wait finished | WaitForTemperature = False |
| Concentration = 1.00 | Wait SamplePrep |
| EluentGenerator.Curve = 5 | Wait finished |

Appendix D: Student-t P-value calculations

2nd week PCE p-value comparison of PCE removal between ports

Port 6 to 7

| Level | Minus Level | Difference | Lower CL | Upper CL | p-Value |
|--------------|-------------|------------|----------|----------|----------|
| 10-1 Con PCE | 10-1 CC PCE | 0.749667 | -1.49438 | 2.993716 | 0.463224 |
| 10-1 SA PCE | 10-1 CC PCE | 0.6045 | -1.52439 | 2.733393 | 0.530974 |
| 10-1 EE PCE | 10-1 CC PCE | 0.375 | -1.86905 | 2.61905 | 0.71002 |
| 10-1 Con PCE | 10-1 EE PCE | 0.374667 | -1.63247 | 2.381806 | 0.678226 |
| 10-1 SA PCE | 10-1 EE PCE | 0.2295 | -1.64801 | 2.107007 | 0.785191 |
| 10-1 Con PCE | 10-1 SA PCE | 0.145167 | -1.73234 | 2.022673 | 0.862922 |

5 to 6

| Level | Level | Difference | Lower CL | Upper CL | p-Value |
|--------------|--------------|------------|----------|----------|----------|
| 10-1 CC PCE | 10-1 EE PCE | 2.032667 | -2.89966 | 6.964993 | 0.369767 |
| 10-1 SA PCE | 10-1 EE PCE | 1.858917 | -2.26776 | 5.985597 | 0.329286 |
| 10-1 Con PCE | 10-1 EE PCE | 1.623 | -2.78861 | 6.034607 | 0.420893 |
| 10-1 CC PCE | 10-1 Con PCE | 0.409667 | -4.52266 | 5.341993 | 0.852882 |
| 10-1 SA PCE | 10-1 Con PCE | 0.235917 | -3.89076 | 4.362597 | 0.898373 |
| 10-1 CC PCE | 10-1 SA PCE | 0.17375 | -4.50547 | 4.852966 | 0.933867 |

4 to 5

| Level | Level | Difference | Lower CL | Upper CL | p-Value |
|--------------|--------------|------------|----------|----------|----------|
| 10-1 EE PCE | 10-1 CC PCE | 2.507 | -3.59177 | 8.605768 | 0.363423 |
| 10-1 EE PCE | 10-1 SA PCE | 1.824 | -2.20996 | 5.857956 | 0.32046 |
| 10-1 EE PCE | 10-1 Con PCE | 1.645667 | -2.66681 | 5.958147 | 0.396855 |
| 10-1 Con PCE | 10-1 CC PCE | 0.861333 | -5.23743 | 6.960101 | 0.748193 |
| 10-1 SA PCE | 10-1 CC PCE | 0.683 | -5.22211 | 6.588107 | 0.792364 |
| 10-1 Con PCE | 10-1 SA PCE | 0.178333 | -3.85562 | 4.212289 | 0.919677 |

3 to 4

| Level | Level | Difference | Lower CL | Upper CL | p-Value |
|-------------|--------------|------------|----------|----------|----------|
| 10-1 EE PCE | 10-1 Con PCE | 2.83 | -2.06682 | 7.726824 | 0.219337 |
| 10-1 CC PCE | 10-1 Con PCE | 1.987833 | -3.48698 | 7.462649 | 0.426739 |
| 10-1 EE PCE | 10-1 SA PCE | 1.637667 | -2.94289 | 6.218226 | 0.433573 |
| 10-1 SA PCE | 10-1 Con PCE | 1.192333 | -3.38823 | 5.772893 | 0.564945 |
| 10-1 EE PCE | 10-1 CC PCE | 0.842167 | -4.63265 | 6.316982 | 0.731967 |
| 10-1 CC PCE | 10-1 SA PCE | 0.7955 | -4.39837 | 5.989366 | 0.733071 |

Port 2 to 3

| Level | Minus Level | Difference | Lower CL | Upper CL | p-Value |
|-------------|-------------|------------|----------|----------|----------|
| 10-1 Con | 10-1 CC | | - | | |
| PCE | PCE | 1.322333 | 4.01346 | 6.658131 | 0.583369 |
| 10-1 Con | 10-1 EE | | - | | |
| PCE | PCE | 0.943333 | 3.82915 | 5.715816 | 0.660647 |
| 10-1 Con | 10-1 SA | | - | | |
| PCE | PCE | 0.722833 | 3.74142 | 5.187082 | 0.718567 |
| | 10-1 CC | | - | | |
| 10-1 SA PCE | PCE | 0.5995 | 4.46248 | 5.661482 | 0.791691 |
| | 10-1 CC | | - | | |
| 10-1 EE PCE | PCE | 0.379 | -4.9568 | 5.714798 | 0.873955 |
| | 10-1 EE | | - | | |
| 10-1 SA PCE | PCE | 0.2205 | 4.24375 | 4.684749 | 0.912124 |

Port 1 to 2

| Level | Minus Level | Difference | Lower CL | Upper CL | p-Value |
|-------------|-------------|------------|----------|----------|----------|
| | 10-1 CC | | - | | |
| 10-1 EE PCE | PCE | 7.085833 | -7.2229 | 21.3946 | 0.286498 |
| 10-1 Con | 10-1 CC | | - | | |
| PCE | PCE | 4.6595 | -9.6493 | 18.96826 | 0.474204 |
| | 10-1 CC | | - | | |
| 10-1 SA PCE | PCE | 4.03075 | -9.5437 | 17.60523 | 0.512857 |
| | 10-1 SA | | - | | |
| 10-1 EE PCE | PCE | 3.055083 | -8.9165 | 15.02665 | 0.572445 |
| | 10-1 Con | | - | | |
| 10-1 EE PCE | PCE | 2.426333 | 10.3718 | 15.22448 | 0.67354 |
| 10-1 Con | 10-1 SA | | - | | |
| PCE | PCE | 0.62875 | 11.3428 | 12.60032 | 0.906589 |

Port iff to 1

| Level | Minus Level | Difference | Lower CL | Upper CL | p-Value |
|-------------|-------------|------------|----------|----------|-----------------|
| | 10-1 Con | | - | | |
| 10-1 CC PCE | PCE | 20.06317 | -2.6238 | 42.75012 | 0.075755 |
| | 10-1 SA | | - | | |
| 10-1 CC PCE | PCE | 16.267 | -5.2557 | 37.78973 | 0.119518 |
| | 10-1 Con | | - | | |
| 10-1 EE PCE | PCE | 12.42267 | -7.8692 | 32.71449 | 0.195718 |
| | 10-1 SA | | - | | |
| 10-1 EE PCE | PCE | 8.6265 | 10.3548 | 27.60777 | 0.325257 |
| | 10-1 EE | | - | | |
| 10-1 CC PCE | PCE | 7.6405 | 15.0465 | 30.32745 | 0.45973 |
| | 10-1 Con | | - | | |
| 10-1 SA PCE | PCE | 3.79617 | 15.1851 | 22.77743 | 0.656942 |

6th week PCE p-value comparison of PCE removal between ports

Port 6 to 7

| Level | Minus Level | Difference | Lower CL | Upper CL | p-Value |
|-------------|------------------|------------|----------|----------|----------|
| 11-3 EE PCE | 11-3 Control PCE | 2.0625 | -0.975 | 5.100004 | 0.152395 |
| 11-3 EE PCE | 11-3 SA PCE | 2.02225 | -0.85938 | 4.90388 | 0.140991 |
| 11-3 EE PCE | 11-3 CC PCE | 1.1745 | -2.15292 | 4.501919 | 0.431471 |
| 11-3 CC PCE | 11-3 Control PCE | 0.888 | -2.1495 | 3.925504 | 0.511653 |
| 11-3 CC PCE | 11-3 SA PCE | 0.84775 | -2.03388 | 3.72938 | 0.509076 |
| 11-3 SA PCE | 11-3 Control PCE | 0.04025 | -2.50111 | 2.581609 | 0.971171 |

Port 5-6

| Level | Minus Level | Difference | Lower CL | Upper CL | p-Value |
|------------------|-------------|------------|----------|----------|-----------------|
| 11-3 Control PCE | 11-3 EE PCE | 6.750667 | 0.03737 | 13.46396 | 0.049041 |
| 11-3 SA PCE | 11-3 EE PCE | 5.0885 | -1.28029 | 11.45729 | 0.100783 |
| 11-3 CC PCE | 11-3 EE PCE | 4.0715 | -3.28255 | 11.42555 | 0.231817 |
| 11-3 Control PCE | 11-3 CC PCE | 2.679167 | -4.03413 | 9.39246 | 0.376754 |
| 11-3 Control PCE | 11-3 SA PCE | 1.662167 | -3.95458 | 7.27891 | 0.506656 |
| 11-3 SA PCE | 11-3 CC PCE | 1.017 | -5.35179 | 7.38579 | 0.71692 |

Port 4-5

| Level | Minus Level | Difference | Lower CL | Upper CL | p-Value |
|------------------|------------------|------------|----------|----------|----------|
| 11-3 EE PCE | 11-3 CC PCE | 2.813 | -3.1187 | 8.744701 | 0.299116 |
| 11-3 Control PCE | 11-3 CC PCE | 2.296167 | -3.11871 | 7.711044 | 0.349394 |
| 11-3 SA PCE | 11-3 CC PCE | 1.657 | -3.48 | 6.794004 | 0.470537 |
| 11-3 EE PCE | 11-3 SA PCE | 1.156 | -3.981 | 6.293004 | 0.611107 |
| 11-3 Control PCE | 11-3 SA PCE | 0.639167 | -3.89124 | 5.169578 | 0.748445 |
| 11-3 EE PCE | 11-3 Control PCE | 0.516833 | -4.89804 | 5.931711 | 0.827886 |

Port 3-4

| Level | Minus Level | Difference | Lower CL | Upper CL | p-Value |
|-------------|------------------|------------|----------|----------|----------|
| 11-3 SA PCE | 11-3 Control PCE | 1.73525 | -3.32276 | 6.793256 | 0.443937 |
| 11-3 CC PCE | 11-3 Control PCE | 1.3955 | -4.64997 | 7.440973 | 0.602132 |
| 11-3 EE PCE | 11-3 Control PCE | 1.0625 | -4.98297 | 7.107973 | 0.690157 |
| 11-3 SA PCE | 11-3 EE PCE | 0.67275 | -5.06249 | 6.407989 | 0.789507 |
| 11-3 SA PCE | 11-3 CC PCE | 0.33975 | -5.39549 | 6.074989 | 0.892544 |
| 11-3 CC PCE | 11-3 EE PCE | 0.333 | -6.28948 | 6.955484 | 0.908694 |

Port 2-3

| Level | Minus Level | Difference | Lower CL | Upper CL | p-Value |
|-------------|------------------|------------|----------|----------|----------|
| 11-3 EE PCE | 11-3 Control PCE | 3.294667 | -11.8225 | 18.41183 | 0.622179 |
| 11-3 EE PCE | 11-3 SA PCE | 2.68075 | -11.6606 | 17.02215 | 0.671819 |
| 11-3 EE PCE | 11-3 CC PCE | 2.397 | -14.163 | 18.95702 | 0.742194 |
| 11-3 CC PCE | 11-3 Control PCE | 0.897667 | -14.2195 | 16.01483 | 0.892289 |
| 11-3 SA PCE | 11-3 Control PCE | 0.613917 | -12.034 | 13.26184 | 0.911845 |
| 11-3 CC PCE | 11-3 SA PCE | 0.28375 | -14.0576 | 14.62515 | 0.963991 |

Port 1-2

| Level | Minus Level | Difference | Lower CL | Upper CL | p-Value |
|------------------|-------------|------------|----------|----------|----------|
| 11-3 EE PCE | 11-3 CC PCE | 7.007 | -12.8348 | 26.84881 | 0.431263 |
| 11-3 Control PCE | 11-3 CC PCE | 6.805333 | -11.3077 | 24.91834 | 0.403806 |
| 11-3 SA PCE | 11-3 CC PCE | 5.4095 | -11.774 | 22.59301 | 0.480871 |

Week 6, port 7 TCE Student t test results

| Level | Minus level | Difference | Lower CL | Upper CL | p-Value |
|---------|-------------|------------|-----------|----------|----------|
| Con TCE | EE TCE | 4.74E-05 | -8.01E-07 | 9.55E-05 | 0.052979 |
| Con TCE | CC TCE | 4.44E-05 | -4.00E-06 | 9.25E-05 | 0.065837 |
| Con TCE | SA TCE | 4.41E-05 | 3.80E-06 | 8.43E-05 | 0.036177 |
| SA TCE | EE TCE | 3.30E-06 | -4.20E-05 | 4.90E-05 | 0.869194 |
| CC TCE | EE TCE | 3.00E-06 | -5.00E-05 | 5.57E-05 | 0.8968 |
| SA TCE | CC TCE | 3.00E-07 | -4.50E-05 | 4.60E-05 | 0.988043 |

2nd week Comparison of PCE decrease and TCE increase between 0'' and 15''

| Level | minus Level | Diff. | Lower CL | Upper CL | P-value |
|---------|-------------|----------|----------|-----------|-----------|
| CC PCE | CC TCE | 0.000234 | 0.000148 | 0.00032 | 0.0000291 |
| SA PCE | SA TCE | 0.000155 | 0.000094 | 0.0002161 | 0.000058 |
| EE PCE | EE TCE | 0.00021 | 0.00014 | 0.0002806 | 0.0000097 |
| CON PCE | Con TCE | 0.000129 | 0.000058 | 0.0001989 | 0.0013278 |

2nd and 6th week Comparison TCE increase between 0'' and 15''

| Level | minus Level | Difference | Lower CL | Upper CL | p-Value |
|----------|-------------|------------|----------|----------|-----------|
| CC TCE6 | CC TCE2 | 4.44E-05 | 2.30E-05 | 6.55E-05 | 0.0004401 |
| SA TCE6 | SA TCE2 | 5.09E-05 | 3.60E-05 | 6.58E-05 | 0.0000028 |
| EE TCE6 | EE TCE2 | 2.66E-05 | 7.30E-06 | 4.59E-05 | 0.0100556 |
| Con TCE6 | Con TCE2 | 5.55E-05 | 3.80E-05 | 7.28E-05 | 0.0000053 |

Appendix E. 2nd week data

| Col 1 CC3 Column 1-6 | | | | | | | | | | | | | | | | |
|----------------------|--------------|-------|--------------|--------|-----------------|-------|-------------------|-------|------|-------|----------|-------|--------|-------|------------------|-------|
| RT: | 7.565 PCE | | 5.485 TCE | | 2.588 CisDCE | | 3.171 TransDCE | | VC | | Ethylene | | Ethane | | 1.533 Methane | |
| ports | P.A. | Conc. | P.A. | Conc. | P.A. | Conc. | P.A. | Conc. | P.A. | Conc. | P.A. | Conc. | P.A. | Conc. | P.A. | Conc. |
| 54 | 56.34 | 0.87 | 13.58 | 0.9723 | | | | | | | | | | | 19.77 | 4.93 |
| 45 | 40.19 | 0.62 | 23.19 | 1.6604 | | | | | | | | | | | 299.63 | 74.79 |
| 36 | 182.63 | 2.83 | 25.61 | 1.8337 | | | | | | | | | | | 377.46 | 94.21 |
| 27 | | | | | | | | | | | | | | | | |
| 21 | 260.1 | 4.03 | 38.4 | 2.7494 | | | | | | | | | | | 253.34 | 63.23 |
| 15 | 188.63 | 2.92 | 19.09 | 1.3668 | | | | | | | | | | | 158.92 | 39.67 |
| 9 | 569.11 | 8.82 | 6.9 | 0.494 | | | | | | | | | | | 70.33 | 17.55 |
| 0 | 2910.7 | 45.12 | 0 | 0 | | | | | | | | | | | 0 | 0.00 |

| Col 2 CC2 Column | | | | | | | | | | | | | | | | |
|------------------|--------------|-------|--------------|--------|--------|-------|----------|-------|------|-------|----------|-------|--------|-------|------------------|--------|
| RT: | 7.565 PCE | | 5.485 TCE | | CisDCE | | TransDCE | | VC | | Ethylene | | Ethane | | 1.533 Methane | |
| ports | P.A. | Conc. | P.A. | Conc. | P.A. | Conc. | P.A. | Conc. | P.A. | Conc. | P.A. | Conc. | P.A. | Conc. | P.A. | Conc. |
| 7 | 7.474 | 0.12 | 7.82 | 0.5599 | | | | | | | | | | | 0 | 0.00 |
| 6 | 39.7 | 0.62 | 21.9 | 1.568 | | | | | | | | | | | 470.57 | 117.45 |
| 5 | 190.64 | 2.95 | 70.1 | 5.0192 | | | | | | | | | | | 328.3 | 81.94 |
| 4 | 219.31 | 3.40 | 24.67 | 1.7664 | | | | | | | | | | | 576.53 | 143.90 |
| 3 | 308.43 | 4.78 | 19.9 | 1.4248 | | | | | | | | | | | 520.87 | 130.01 |
| 2 | 376.43 | 5.83 | 19.2 | 1.3747 | | | | | | | | | | | 372.77 | 93.04 |
| 1 | 756.44 | 11.72 | 12.1 | 0.8664 | | | | | | | | | | | 52.18 | 13.02 |
| IFF | 2530.6 | 39.22 | 0 | 0 | | | | | | | | | | | 0 | 0.00 |

| Col 3 Control3 column | | | | | | | | | | | | | | | | |
|-----------------------|--------------|-------|--------------|--------|--------|-------|----------|-------|------|-------|----------|-------|--------|-------|------------------|--------|
| RT: | 7.565 PCE | | 5.485 TCE | | CisDCE | | TransDCE | | VC | | Ethylene | | Ethane | | 1.533 Methane | |
| ports | P.A. | Conc. | P.A. | Conc. | P.A. | Conc. | P.A. | Conc. | P.A. | Conc. | P.A. | Conc. | P.A. | Conc. | P.A. | Conc. |
| 7 | 178.11 | 2.76 | 25.96 | 1.8587 | | | | | | | | | | | 846.75 | 211.35 |
| 6 | 327.89 | 5.08 | 23.97 | 1.7163 | | | | | | | | | | | 966.07 | 241.13 |
| 5 | 215.74 | 3.34 | 15.94 | 1.1413 | | | | | | | | | | | 684.44 | 170.84 |
| 4 | 446.54 | 6.92 | 72.88 | 5.2182 | | | | | | | | | | | 278.27 | 69.46 |
| 3 | 228.12 | 3.54 | 20.1 | 1.4392 | | | | | | | | | | | 318.48 | 79.49 |
| 2 | 252.33 | 3.91 | 24.17 | 1.7306 | | | | | | | | | | | 308.81 | 77.08 |
| 1 | 676.39 | 10.48 | 3.94 | 0.2821 | | | | | | | | | | | 21.39 | 5.34 |
| IFF | 2252.6 | 34.92 | 0 | 0 | | | | | | | | | | | 0 | 0.00 |

| Col 4 EE3 column | | | | | | | | | | | | | | | | |
|------------------|--------------|-------|--------------|--------|--------|-------|----------|-------|------|-------|----------|-------|--------|-------|------------------|--------|
| RT: | 7.565 PCE | | 5.485 TCE | | CisDCE | | TransDCE | | VC | | Ethylene | | Ethane | | 1.533 Methane | |
| ports | P.A. | Conc. | P.A. | Conc. | P.A. | Conc. | P.A. | Conc. | P.A. | Conc. | P.A. | Conc. | P.A. | Conc. | P.A. | Conc. |
| 7 | 14.96 | 0.23 | 14.93 | 1.069 | | | | | | | | | | | 172.42 | 43.04 |
| 6 | 16.33 | 0.25 | 23.42 | 1.6769 | | | | | | | | | | | 687.37 | 171.57 |
| 5 | 111.5 | 1.73 | 34.36 | 2.4602 | | | | | | | | | | | 455.55 | 113.71 |
| 4 | 282.07 | 4.37 | 26.9 | 1.926 | | | | | | | | | | | 454.84 | 113.53 |
| 3 | 733.6 | 11.37 | 60.44 | 4.3275 | | | | | | | | | | | 124.01 | 30.95 |
| 2 | 473.19 | 7.33 | 15.5 | 1.1098 | | | | | | | | | | | 276.24 | 68.95 |
| 1 | 468.38 | 7.26 | 15.46 | 1.1069 | | | | | | | | | | | 293.83 | 73.34 |
| IFF | 2273.6 | 35.24 | 0 | 0 | | | | | | | | | | | 0 | 0.00 |

| Col 5 SA3 column | | | | | | | | | | | | | | | | |
|------------------|--------------|-------|--------------|--------|--------|-------|----------|-------|------|-------|----------|-------|--------|-------|------------------|--------|
| RT: | 7.565 PCE | | 5.485 TCE | | CisDCE | | TransDCE | | VC | | Ethylene | | Ethane | | 1.533 Methane | |
| ports | P.A. | Conc. | P.A. | Conc. | P.A. | Conc. | P.A. | Conc. | P.A. | Conc. | P.A. | Conc. | P.A. | Conc. | P.A. | Conc. |
| 7 | 80.68 | 1.25 | 12.98 | 0.9294 | | | | | | | | | | | 0 | 0.00 |
| 6 | 81.66 | 1.27 | 16.13 | 1.1549 | | | | | | | | | | | 66.23 | 16.53 |
| 5 | 312.62 | 4.85 | 28.33 | 2.0284 | | | | | | | | | | | 364.01 | 90.86 |
| 4 | 292.88 | 4.54 | 23.83 | 1.7062 | | | | | | | | | | | 609.4 | 152.11 |
| 3 | 351.2 | 5.44 | 15.58 | 1.1155 | | | | | | | | | | | 611.85 | 152.72 |
| 2 | 306.65 | 4.75 | 15.56 | 1.1141 | | | | | | | | | | | 721.98 | 180.21 |
| 1 | 687.74 | 10.66 | 15.21 | 1.089 | | | | | | | | | | | 84.18 | 21.01 |
| IFF | 2645.8 | 41.01 | 0 | 0 | | | | | | | | | | | 0 | 0.00 |

| Col 6 SA2 column | | | | | | | | | | | | | | | | |
|------------------|--------------|-------|--------------|--------|--------|-------|----------|-------|------|-------|----------|-------|--------|-------|------------------|--------|
| RT: | 7.565 PCE | | 5.485 TCE | | CisDCE | | TransDCE | | VC | | Ethylene | | Ethane | | 1.533 Methane | |
| ports | P.A. | Conc. | P.A. | Conc. | P.A. | Conc. | P.A. | Conc. | P.A. | Conc. | P.A. | Conc. | P.A. | Conc. | P.A. | Conc. |
| 7 | 135.97 | 2.11 | 14.63 | 1.0475 | | | | | | | | | | | 12.99 | 3.24 |
| 6 | 275.71 | 4.27 | 8.79 | 0.6294 | | | | | | | | | | | 298.62 | 74.54 |
| 5 | 279.35 | 4.33 | 19.22 | 1.3762 | | | | | | | | | | | 329.09 | 82.14 |
| 4 | 374.45 | 5.80 | 18.82 | 1.3475 | | | | | | | | | | | 558.45 | 139.39 |
| 3 | 501.28 | 7.77 | 17.96 | 1.2859 | | | | | | | | | | | 744.69 | 185.87 |
| 2 | 488.88 | 7.58 | 12.59 | 0.9014 | | | | | | | | | | | 660.94 | 164.97 |
| 1 | 1074.2 | 16.65 | 5.15 | 0.3687 | | | | | | | | | | | 35.31 | 8.81 |
| IFF | 2522.6 | 39.10 | 0 | 0 | | | | | | | | | | | 0 | 0.00 |

Col 7 EE2 Column used 10/8 stds

| RT: | 7.565 PCE | | 5.485 TCE | | 2.588 CisDCE | | 3.171 TransDCE | | VC | | Ethylene | | Ethane | | 1.533 Methane | |
|-------|--------------|-------|--------------|--------|-----------------|-------|-------------------|-------|------|-------|----------|-------|--------|-------|------------------|--------|
| ports | P.A. | Conc. | P.A. | Conc. | P.A. | Conc. | P.A. | Conc. | P.A. | Conc. | P.A. | Conc. | P.A. | Conc. | P.A. | Conc. |
| 7 | 43.33 | 0.67 | 10.59 | 0.7582 | | | | | | | | | | | 68.4 | 17.07 |
| 6 | 35.96 | 0.56 | 20.97 | 1.5015 | | | | | | | | | | | 276.36 | 68.98 |
| 5 | 90.27 | 1.40 | 37.32 | 2.6721 | | | | | | | | | | | 763.98 | 190.69 |
| 4 | 130.5 | 2.02 | 33.5 | 2.3986 | | | | | | | | | | | 525.39 | 131.14 |
| 3 | 202.56 | 3.14 | 85.75 | 6.1397 | | | | | | | | | | | 339.26 | 84.68 |
| 2 | 524.06 | 8.12 | 80.49 | 5.7631 | | | | | | | | | | | 442.71 | 110.50 |
| 1 | 1467.3 | 22.74 | 17.67 | 1.2652 | | | | | | | | | | | 101.01 | 25.21 |
| IFF | 3307.1 | 51.26 | 0 | 0 | | | | | | | | | | | 0 | 0.00 |

Col 8 Control 2 Column

| RT: | 7.565 PCE | | 5.485 TCE | | CisDCE | | TransDCE | | VC | | Ethylene | | Ethane | | 1.533 Methane | |
|-------|--------------|-------|--------------|--------|--------|-------|----------|-------|------|-------|----------|-------|--------|-------|------------------|--------|
| ports | P.A. | Conc. | P.A. | Conc. | P.A. | Conc. | P.A. | Conc. | P.A. | Conc. | P.A. | Conc. | P.A. | Conc. | P.A. | Conc. |
| 7 | 24.52 | 0.38 | 29.09 | 2.0828 | | | | | | | | | | | 764.61 | 190.85 |
| 6 | 42.95 | 0.67 | 41.25 | 2.9535 | | | | | | | | | | | 548.48 | 136.90 |
| 5 | 377.47 | 5.85 | 42.21 | 3.0222 | | | | | | | | | | | 433.96 | 108.32 |
| 4 | 348.94 | 5.41 | 48.46 | 3.4697 | | | | | | | | | | | 321.36 | 80.21 |
| 3 | 493.79 | 7.65 | 27.63 | 1.9783 | | | | | | | | | | | 136.87 | 34.16 |
| 2 | 671.36 | 10.41 | 31.94 | 2.2869 | | | | | | | | | | | 37.52 | 9.36 |
| 1 | 1381.8 | 21.42 | 0 | 0 | | | | | | | | | | | 0 | 0.00 |
| IFF | 1613.2 | 25.01 | 0 | 0 | | | | | | | | | | | 0 | 0.00 |

Col 9 SA1 column

| RT: | 7.565 PCE | | 5.485 TCE | | CisDCE | | TransDCE | | VC | | Ethylene | | Ethane | | 1.533 Methane | |
|-------|--------------|-------|--------------|--------|--------|-------|----------|-------|------|-------|----------|-------|--------|-------|------------------|--------|
| ports | P.A. | Conc. | P.A. | Conc. | P.A. | Conc. | P.A. | Conc. | P.A. | Conc. | P.A. | Conc. | P.A. | Conc. | P.A. | Conc. |
| 7 | 29.9 | 0.46 | 13.22 | 0.9466 | | | | | | | | | | | 18.39 | 4.59 |
| 6 | 99.2 | 1.54 | 23.84 | 1.7069 | | | | | | | | | | | 134.54 | 33.58 |
| 5 | 382.34 | 5.93 | 45.49 | 3.2571 | | | | | | | | | | | 651.64 | 162.65 |
| 4 | 337.23 | 5.23 | 38.6 | 2.7638 | | | | | | | | | | | 802.81 | 200.38 |
| 3 | 587.43 | 9.11 | 37.51 | 2.6857 | | | | | | | | | | | 744.53 | 185.83 |
| 2 | 648.78 | 10.06 | 25.37 | 1.8165 | | | | | | | | | | | 313.51 | 78.25 |
| 1 | 1583.5 | 24.54 | 0 | 0 | | | | | | | | | | | 0 | 0.00 |
| IFF | 1561.9 | 24.21 | 0 | 0 | | | | | | | | | | | 0 | 0.00 |

Col 10 EE1 column

| RT: | 7.565 PCE | | 5.485 TCE | | CisDCE | | TransDCE | | VC | | Ethylene | | Ethane | | 1.533 Methane | |
|-------|--------------|-------|--------------|--------|--------|-------|----------|-------|------|-------|----------|-------|--------|-------|------------------|--------|
| ports | P.A. | Conc. | P.A. | Conc. | P.A. | Conc. | P.A. | Conc. | P.A. | Conc. | P.A. | Conc. | P.A. | Conc. | P.A. | Conc. |
| 7 | | | | | | | | | | | | | | | | |
| 6 | 102.75 | 1.59 | 26.72 | 1.9132 | | | | | | | | | | | 611.78 | 152.70 |
| 5 | | | | | | | | | | | | | | | | |
| 4 | 360.3 | 5.58 | 44.46 | 3.1833 | | | | | | | | | | | 443.3 | 110.65 |
| 3 | 523.51 | 8.11 | 39.78 | 2.8482 | | | | | | | | | | | 350.42 | 87.46 |
| 2 | 530.55 | 8.22 | 82.16 | 5.8827 | | | | | | | | | | | 253.75 | 63.34 |
| 1 | 2104.3 | 32.62 | 0 | 0 | | | | | | | | | | | 1.4 | 0.35 |
| IFF | 3154.1 | 48.89 | 0 | 0 | | | | | | | | | | | 0 | 0.00 |

Col 11 Control1 column

| RT: | 7.565 PCE | | 5.485 TCE | | CisDCE | | TransDCE | | VC | | Ethylene | | Ethane | | 1.533 Methane | |
|-------|--------------|-------|--------------|--------|--------|-------|----------|-------|------|-------|----------|-------|--------|-------|------------------|--------|
| ports | P.A. | Conc. | P.A. | Conc. | P.A. | Conc. | P.A. | Conc. | P.A. | Conc. | P.A. | Conc. | P.A. | Conc. | P.A. | Conc. |
| 7 | 57.21 | 0.89 | 42.29 | 3.028 | | | | | | | | | | | 751.41 | 187.55 |
| 6 | 58.23 | 0.90 | 32.02 | 2.2926 | | | | | | | | | | | 851.9 | 212.63 |
| 5 | 196.71 | 3.05 | 66.16 | 4.7371 | | | | | | | | | | | 484.6 | 120.96 |
| 4 | 247.09 | 3.83 | 51.9 | 3.716 | | | | | | | | | | | 720.72 | 179.89 |
| 3 | 459.79 | 7.13 | 43.26 | 3.0974 | | | | | | | | | | | 528.52 | 131.92 |
| 2 | 508.73 | 7.89 | 38.54 | 2.7595 | | | | | | | | | | | 234.17 | 58.45 |
| 1 | 1416.8 | 21.96 | 0 | 0 | | | | | | | | | | | 0 | 0.00 |
| IFF | 1899.6 | 29.44 | 0 | 0 | | | | | | | | | | | 0 | 0.00 |

Col 12 SA0 column

| RT: | 7.565 PCE | | 5.485 TCE | | CisDCE | | TransDCE | | VC | | Ethylene | | Ethane | | 1.533 Methane | |
|-------|--------------|-------|--------------|--------|--------|-------|----------|-------|------|-------|----------|-------|--------|-------|------------------|-------|
| ports | P.A. | Conc. | P.A. | Conc. | P.A. | Conc. | P.A. | Conc. | P.A. | Conc. | P.A. | Conc. | P.A. | Conc. | P.A. | Conc. |
| 7 | 63.42 | 0.98 | 69.41 | 4.9698 | | | | | | | | | | | 31.77 | 7.93 |
| 6 | 41.68 | 0.65 | 28.26 | 2.0234 | | | | | | | | | | | 131.63 | 32.85 |
| 5 | 65.95 | 1.02 | 34.52 | 2.4716 | | | | | | | | | | | 175.21 | 43.73 |
| 4 | 326.55 | 5.06 | 37.33 | 2.6728 | | | | | | | | | | | 278.98 | 69.63 |
| 3 | 384.34 | 5.96 | 25.17 | 1.8022 | | | | | | | | | | | 292.92 | 73.11 |
| 2 | 527.68 | 8.18 | 23.1 | 1.654 | | | | | | | | | | | 161.25 | 40.25 |
| 1 | 1187.7 | 18.41 | 13.55 | 0.9702 | | | | | | | | | | | 15.87 | 3.96 |
| IFF | 1836.6 | 28.47 | 0 | 0 | | | | | | | | | | | 0 | 0.00 |

Appendix F. 4th week data

| Col 1 CC3 Column All Conc In (µg /L) | | | | | | | | | | | | | | | | |
|--------------------------------------|--------------|-------|--------------|--------|-----------------|-------|-------------------|-------|------|-------|----------|-------|--------|-------|------------------|--------|
| RT: | 7.565 PCE | | 5.485 TCE | | 2.588 CisDCE | | 3.171 TransDCE | | VC | | Ethylene | | Ethane | | 1.533 Methane | |
| ports | P.A. | Conc. | P.A. | Conc. | P.A. | Conc. | P.A. | Conc. | P.A. | Conc. | P.A. | Conc. | P.A. | Conc. | P.A. | Conc. |
| 7 | 115.5 | 1.79 | 29.8 | 2.1337 | | | | | | | | | | | 1.2 | 0.30 |
| 6 | 88.1 | 1.37 | 74.3 | 5.3199 | | | | | | | | | | | 202.2 | 50.47 |
| 5 | 754.6 | 11.70 | 99.6 | 7.1314 | | | | | | | | | | | 521.9 | 130.27 |
| 4 | 616.9 | 9.56 | 80.9 | 5.7924 | | | | | | | | | | | 549.5 | 137.16 |
| 3 | 921.7 | 14.29 | 85.3 | 6.1075 | | | | | | | | | | | 330.9 | 82.59 |
| 2 | 1438.8 | 22.30 | 75.2 | 5.3843 | | | | | | | | | | | 327.3 | 81.69 |
| 1 | 1829 | 28.35 | 23.9 | 1.7112 | | | | | | | | | | | 36.3 | 9.06 |
| IFF | 2480.1 | 38.44 | 0 | 0 | | | | | | | | | | | 0 | 0.00 |

| Col 2 CC2 Column | | | | | | | | | | | | | | | | |
|------------------|--------------|-------|--------------|--------|-----------------|-------|-------------------|-------|------|-------|----------|-------|--------|-------|------------------|--------|
| RT: | 7.565 PCE | | 5.485 TCE | | 2.588 CisDCE | | 3.171 TransDCE | | VC | | Ethylene | | Ethane | | 1.533 Methane | |
| ports | P.A. | Conc. | P.A. | Conc. | P.A. | Conc. | P.A. | Conc. | P.A. | Conc. | P.A. | Conc. | P.A. | Conc. | P.A. | Conc. |
| 7 | 62.5 | 0.97 | 23.3 | 1.6683 | | | | | | | | | | | 20.9 | 5.22 |
| 6 | 200.7 | 3.11 | 95.3 | 6.8235 | | | | | | | | | | | 261.1 | 65.17 |
| 5 | 419.5 | 6.50 | 93.7 | 6.7089 | | | | | | | | | | | 480.4 | 119.91 |
| 4 | 714 | 11.07 | 83.8 | 6.0001 | | | | | | | | | | | 381.2 | 95.15 |
| 3 | 991.1 | 15.36 | 86.7 | 6.2077 | | | | | | | | | | | 356.3 | 88.93 |
| 2 | 1106.6 | 17.15 | 57.7 | 4.1313 | | | | | | | | | | | 236.2 | 58.96 |
| 1 | 1634.4 | 25.33 | 43.7 | 3.1289 | | | | | | | | | | | 38 | 9.48 |
| IFF | 2609.2 | 40.44 | 0 | 0 | | | | | | | | | | | 0 | 0.00 |

| Col 3 Control3 column | | | | | | | | | | | | | | | | |
|-----------------------|--------------|-------|--------------|--------|-----------------|-------|-------------------|-------|------|-------|----------|-------|--------|-------|------------------|--------|
| RT: | 7.565 PCE | | 5.485 TCE | | 2.588 CisDCE | | 3.171 TransDCE | | VC | | Ethylene | | Ethane | | 1.533 Methane | |
| ports | P.A. | Conc. | P.A. | Conc. | P.A. | Conc. | P.A. | Conc. | P.A. | Conc. | P.A. | Conc. | P.A. | Conc. | P.A. | Conc. |
| 7 | 861.2 | 13.35 | 64 | 4.5824 | | | | | | | | | | | 543.7 | 135.71 |
| 6 | 1025 | 15.89 | 58.5 | 4.1886 | | | | | | | | | | | 474.9 | 118.54 |
| 5 | 1222.3 | 18.95 | 100.9 | 7.2244 | | | | | | | | | | | 409.6 | 102.24 |
| 4 | 1146.5 | 17.77 | 65.2 | 4.6683 | | | | | | | | | | | 700 | 174.72 |
| 3 | 1536.4 | 23.81 | 60.2 | 4.3103 | | | | | | | | | | | 384.2 | 95.90 |
| 2 | 1360.5 | 21.09 | 52.3 | 3.7447 | | | | | | | | | | | 311.1 | 77.65 |
| 1 | 2068 | 32.05 | 34.5 | 2.4702 | | | | | | | | | | | 81 | 20.22 |
| IFF | 3158.4 | 48.96 | 0 | 0 | | | | | | | | | | | 0 | 0.00 |

| Col 4 EE3 column | | | | | | | | | | | | | | | | |
|------------------|--------------|-------|--------------|--------|-----------------|-------|-------------------|-------|------|-------|----------|-------|--------|-------|------------------|--------|
| RT: | 7.565 PCE | | 5.485 TCE | | 2.588 CisDCE | | 3.171 TransDCE | | VC | | Ethylene | | Ethane | | 1.533 Methane | |
| ports | P.A. | Conc. | P.A. | Conc. | P.A. | Conc. | P.A. | Conc. | P.A. | Conc. | P.A. | Conc. | P.A. | Conc. | P.A. | Conc. |
| 7 | 209 | 3.24 | 88.1 | 6.308 | | | | | | | | | | | 18.9 | 4.72 |
| 6 | 232.1 | 3.60 | 116.9 | 8.37 | | | | | | | | | | | 316.1 | 78.90 |
| 5 | 630.1 | 9.77 | 110.9 | 7.9404 | | | | | | | | | | | 403.4 | 100.69 |
| 4 | 1007.6 | 15.62 | 95 | 6.802 | | | | | | | | | | | 447.9 | 111.80 |
| 3 | 1104.9 | 17.13 | 60 | 4.296 | | | | | | | | | | | 235.5 | 58.78 |
| 2 | 976.5 | 15.14 | 71.7 | 5.1337 | | | | | | | | | | | 479.6 | 119.71 |
| 1 | 1780.7 | 27.60 | 30.9 | 2.2124 | | | | | | | | | | | 110 | 27.46 |
| IFF | 2579.7 | 39.99 | 0 | 0 | | | | | | | | | | | 0 | 0.00 |

| Col 5 SA3 column | | | | | | | | | | | | | | | | |
|------------------|--------------|-------|--------------|--------|-----------------|-------|-------------------|-------|------|-------|----------|-------|--------|-------|------------------|--------|
| RT: | 7.565 PCE | | 5.485 TCE | | 2.588 CisDCE | | 3.171 TransDCE | | VC | | Ethylene | | Ethane | | 1.533 Methane | |
| ports | P.A. | Conc. | P.A. | Conc. | P.A. | Conc. | P.A. | Conc. | P.A. | Conc. | P.A. | Conc. | P.A. | Conc. | P.A. | Conc. |
| 7 | 209.9 | 3.25 | 29.7 | 2.1265 | | | | | | | | | | | 0.8 | 0.20 |
| 6 | 394.4 | 6.11 | 59.6 | 4.2674 | | | | | | | | | | | 37.2 | 9.29 |
| 5 | 722.4 | 11.20 | 76.8 | 5.4989 | | | | | | | | | | | 195.4 | 48.77 |
| 4 | 1211.9 | 18.78 | 77.4 | 5.5418 | | | | | | | | | | | 523.4 | 130.64 |
| 3 | 1122.6 | 17.40 | 60.4 | 4.3246 | | | | | | | | | | | 730.9 | 182.43 |
| 2 | 1293.8 | 20.05 | 55.2 | 3.9523 | | | | | | | | | | | 543.9 | 135.76 |
| 1 | 2022.2 | 31.34 | 46.9 | 3.358 | | | | | | | | | | | 94.9 | 23.69 |
| IFF | 2463.3 | 38.18 | 0 | 0 | | | | | | | | | | | 0 | 0.00 |

| Col 6 SA2 column | | | | | | | | | | | | | | | | |
|------------------|--------------|-------|--------------|--------|-----------------|-------|-------------------|-------|------|-------|----------|-------|--------|-------|------------------|--------|
| RT: | 7.565 PCE | | 5.485 TCE | | 2.588 CisDCE | | 3.171 TransDCE | | VC | | Ethylene | | Ethane | | 1.533 Methane | |
| ports | P.A. | Conc. | P.A. | Conc. | P.A. | Conc. | P.A. | Conc. | P.A. | Conc. | P.A. | Conc. | P.A. | Conc. | P.A. | Conc. |
| 7 | 359.6 | 5.57 | 47.3 | 3.3867 | | | | | | | | | | | 5.3 | 1.32 |
| 6 | 134.8 | 2.09 | 61.1 | 4.3748 | | | | | | | | | | | 13.4 | 3.34 |
| 5 | 437.7 | 6.78 | 72.6 | 5.1982 | | | | | | | | | | | 417.5 | 104.21 |
| 4 | 624.5 | 9.68 | 73.3 | 5.2483 | | | | | | | | | | | 626.6 | 156.40 |
| 3 | 954.8 | 14.80 | 54.1 | 3.8736 | | | | | | | | | | | 484.8 | 121.01 |
| 2 | 1381.2 | 21.41 | 55.8 | 3.9953 | | | | | | | | | | | 387.7 | 96.77 |
| 1 | 2100.4 | 32.56 | 5.2 | 0.3723 | | | | | | | | | | | 5.6 | 1.40 |
| IFF | 2800 | 43.40 | 0 | 0 | | | | | | | | | | | 0 | 0.00 |

| Col 7 EE2 Column used 10/8 stds | | | | | | | | | | | | | | | | |
|---------------------------------|--------------|-------|--------------|--------|-----------------|-------|-------------------|-------|------|-------|----------|-------|--------|-------|------------------|--------|
| RT: | 7.565 PCE | | 5.485 TCE | | 2.588 CisDCE | | 3.171 TransDCE | | VC | | Ethylene | | Ethane | | 1.533 Methane | |
| ports | P.A. | Conc. | P.A. | Conc. | P.A. | Conc. | P.A. | Conc. | P.A. | Conc. | P.A. | Conc. | P.A. | Conc. | P.A. | Conc. |
| 7 | 549.4 | 8.52 | 73.5 | 5.2626 | | | | | | | | | | | 54 | 13.48 |
| 6 | 723.8 | 11.22 | 87.2 | 6.2435 | | | | | | | | | | | 265.7 | 66.32 |
| 5 | 670.4 | 10.39 | 106 | 7.5896 | | | | | | | | | | | 410.9 | 102.56 |
| 4 | 1142.1 | 17.70 | 102.5 | 7.339 | | | | | | | | | | | 367.8 | 91.80 |
| 3 | 1010.6 | 15.66 | 74.6 | 5.3414 | | | | | | | | | | | 237.8 | 59.35 |
| 2 | 1272.8 | 19.73 | 59.4 | 4.253 | | | | | | | | | | | 104.4 | 26.06 |
| 1 | 2444.2 | 37.89 | 17.7 | 1.2673 | | | | | | | | | | | 5 | 1.25 |
| IFF | 1200 | 18.60 | 0 | 0 | | | | | | | | | | | 0 | 0.00 |

| Col 8 Control 2 Column | | | | | | | | | | | | | | | | |
|------------------------|--------------|-------|--------------|--------|-----------------|-------|-------------------|-------|------|-------|----------|-------|--------|-------|------------------|--------|
| RT: | 7.565 PCE | | 5.485 TCE | | 2.588 CisDCE | | 3.171 TransDCE | | VC | | Ethylene | | Ethane | | 1.533 Methane | |
| ports | P.A. | Conc. | P.A. | Conc. | P.A. | Conc. | P.A. | Conc. | P.A. | Conc. | P.A. | Conc. | P.A. | Conc. | P.A. | Conc. |
| 7 | 134.5 | 2.08 | 150.6 | 10.783 | | | | | | | | | | | 360.1 | 89.88 |
| 6 | 296.7 | 4.60 | 145 | 10.382 | | | | | | | | | | | 374.7 | 93.53 |
| 5 | 771.7 | 11.96 | 106.3 | 7.6111 | | | | | | | | | | | 460.9 | 115.04 |
| 4 | 754 | 11.69 | 89.7 | 6.4225 | | | | | | | | | | | 281.1 | 70.16 |
| 3 | 1324.2 | 20.53 | 77.1 | 5.5204 | | | | | | | | | | | 70.6 | 17.62 |
| 2 | 1394.6 | 21.62 | 70.2 | 5.0263 | | | | | | | | | | | 24.1 | 6.02 |
| 1 | 1996.9 | 30.95 | 0 | 0 | | | | | | | | | | | 0 | 0.00 |
| IFF | 1572.2 | 24.37 | 0 | 0 | | | | | | | | | | | 0 | 0.00 |

| Col 9 SA1 column | | | | | | | | | | | | | | | | |
|------------------|--------------|-------|--------------|--------|-----------------|-------|-------------------|-------|------|-------|----------|-------|--------|-------|------------------|--------|
| RT: | 7.565 PCE | | 5.485 TCE | | 2.588 CisDCE | | 3.171 TransDCE | | VC | | Ethylene | | Ethane | | 1.533 Methane | |
| ports | P.A. | Conc. | P.A. | Conc. | P.A. | Conc. | P.A. | Conc. | P.A. | Conc. | P.A. | Conc. | P.A. | Conc. | P.A. | Conc. |
| 7 | 103.8 | 1.61 | 39.4 | 2.821 | | | | | | | | | | | 14.6 | 3.64 |
| 6 | 220.7 | 3.42 | 84.1 | 6.0216 | | | | | | | | | | | 66.6 | 16.62 |
| 5 | 956.4 | 14.82 | 123.6 | 8.8498 | | | | | | | | | | | 374 | 93.35 |
| 4 | 953.3 | 14.78 | 105.3 | 7.5395 | | | | | | | | | | | 570.9 | 142.50 |
| 3 | 884.2 | 13.71 | 76.5 | 5.4774 | | | | | | | | | | | 549.1 | 137.06 |
| 2 | 1424.5 | 22.08 | 66.8 | 4.7829 | | | | | | | | | | | 167.4 | 41.78 |
| 1 | 2182 | 33.82 | 3.1 | 0.222 | | | | | | | | | | | 0 | 0.00 |
| IFF | 1720.7 | 26.67 | 0 | 0 | | | | | | | | | | | 0 | 0.00 |

| Col 10 EE1 column | | | | | | | | | | | | | | | | |
|-------------------|--------------|-------|--------------|--------|-----------------|-------|-------------------|-------|------|-------|----------|-------|--------|-------|------------------|--------|
| RT: | 7.565 PCE | | 5.485 TCE | | 2.588 CisDCE | | 3.171 TransDCE | | VC | | Ethylene | | Ethane | | 1.533 Methane | |
| ports | P.A. | Conc. | P.A. | Conc. | P.A. | Conc. | P.A. | Conc. | P.A. | Conc. | P.A. | Conc. | P.A. | Conc. | P.A. | Conc. |
| 7 | 463.9 | 7.19 | 53 | 3.7948 | | | | | | | | | | | 36.4 | 6.81 |
| 6 | 1053.2 | 16.32 | 92.6 | 6.6302 | | | | | | | | | | | 274.6 | 68.54 |
| 5 | 501.8 | 7.78 | 91.7 | 6.5657 | | | | | | | | | | | 573.3 | 143.10 |
| 4 | 1112.7 | 17.25 | 85.5 | 6.1218 | | | | | | | | | | | 368.4 | 91.95 |
| 3 | 1236.3 | 19.16 | 64.8 | 4.6397 | | | | | | | | | | | 163.8 | 40.88 |
| 2 | 2445 | 37.90 | 153.2 | 10.969 | | | | | | | | | | | 159.6 | 39.84 |
| 1 | 593 | 9.19 | 30.2 | 2.1623 | | | | | | | | | | | 0 | 0.00 |
| IFF | 1808.7 | 28.03 | 0 | 0 | | | | | | | | | | | 0 | 0.00 |

| Col 11 Control1 column | | | | | | | | | | | | | | | | |
|------------------------|--------------|-------|--------------|--------|-----------------|-------|-------------------|-------|------|-------|----------|-------|--------|-------|------------------|--------|
| RT: | 7.565 PCE | | 5.485 TCE | | 2.588 CisDCE | | 3.171 TransDCE | | VC | | Ethylene | | Ethane | | 1.533 Methane | |
| ports | P.A. | Conc. | P.A. | Conc. | P.A. | Conc. | P.A. | Conc. | P.A. | Conc. | P.A. | Conc. | P.A. | Conc. | P.A. | Conc. |
| 7 | 105.9 | 1.64 | 77.3 | 5.5347 | | | | | | | | | | | 900.4 | 224.74 |
| 6 | 121.5 | 1.88 | 142.4 | 10.196 | | | | | | | | | | | 639.3 | 159.57 |
| 5 | 411.6 | 6.38 | 119.8 | 8.5777 | | | | | | | | | | | 429.9 | 107.30 |
| 4 | 593.1 | 9.19 | 105 | 7.518 | | | | | | | | | | | 428.7 | 107.00 |
| 3 | 706.4 | 10.95 | 77 | 5.5132 | | | | | | | | | | | 200.5 | 50.04 |
| 2 | 1095.3 | 16.98 | 77.3 | 5.5347 | | | | | | | | | | | 73.4 | 18.32 |
| 1 | 1609.4 | 24.95 | 0 | 0 | | | | | | | | | | | 0 | 0.00 |
| IFF | 1502.3 | 23.29 | 0 | 0 | | | | | | | | | | | 0 | 0.00 |

Week 4 column 12 data was an outlier due to the low PCE readings within the columns. column 12 data was not used during average calculations.

Appendix G. 6th week data

| Col 1 CC3 Column 1-6 ALL CONC IN ppb(µg /L) | | | | | | | | | | | | | | | | |
|---|--------------|-------|--------------|--------|-----------------|-------|-------------------|-------|------|-------|----------|-------|--------|-------|------------------|--------|
| RT: | 7.565 PCE | | 5.485 TCE | | 2.588 CisDCE | | 3.171 TransDCE | | VC | | Ethylene | | Ethane | | 1.533 Methane | |
| ports | P.A. | Conc. | P.A. | Conc. | P.A. | Conc. | P.A. | Conc. | P.A. | Conc. | P.A. | Conc. | P.A. | Conc. | P.A. | Conc. |
| 7 | 38.8 | 0.60 | 62.4 | 4.4678 | | | | | | | | | | | 3.93 | 0.98 |
| 6 | 35.9 | 0.56 | 138.25 | 9.8987 | | | | | | | | | | | 94.77 | 23.65 |
| 5 | 125.07 | 1.94 | 129.55 | 9.2758 | | | | | | | | | | | 370.12 | 92.38 |
| 4 | 154.87 | 2.40 | 134.97 | 9.6639 | | | | | | | | | | | 505.84 | 126.26 |
| 3 | 491.06 | 7.61 | 136.66 | 9.7849 | | | | | | | | | | | 174.9 | 43.66 |
| 2 | 589.45 | 9.14 | 100.78 | 7.2158 | | | | | | | | | | | 90.5 | 22.59 |
| 1 | 1123.6 | 17.42 | 40.94 | 2.9313 | | | | | | | | | | | 19.9 | 4.97 |
| IFF | 3180.9 | 49.30 | 0 | 0 | | | | | | | | | | | 0 | 0.00 |
| Col 2 CC2 Column | | | | | | | | | | | | | | | | |
| RT: | 7.565 PCE | | 5.485 TCE | | CisDCE | | TransDCE | | VC | | Ethylene | | Ethane | | 1.533 Methane | |
| ports | P.A. | Conc. | P.A. | Conc. | P.A. | Conc. | P.A. | Conc. | P.A. | Conc. | P.A. | Conc. | P.A. | Conc. | P.A. | Conc. |
| 7 | 66.47 | 1.03 | 118.14 | 8.4588 | | | | | | | | | | | 30.7 | 7.66 |
| 6 | 171.04 | 2.65 | 134.4 | 9.623 | | | | | | | | | | | 80.97 | 20.21 |
| 5 | 333.71 | 5.17 | 174.3 | 12.48 | | | | | | | | | | | 201.7 | 50.34 |
| 4 | 457.1 | 7.09 | 112.18 | 8.0321 | | | | | | | | | | | 219.49 | 54.78 |
| 3 | 547.17 | 8.48 | 100.47 | 7.1937 | | | | | | | | | | | 192.3 | 48.00 |
| 2 | 1036.3 | 16.06 | 114.98 | 8.2326 | | | | | | | | | | | 143.57 | 35.84 |
| 1 | 1574.5 | 24.40 | 77.87 | 5.5755 | | | | | | | | | | | 27.3 | 6.81 |
| IFF | 3135.9 | 48.61 | 0 | 0 | | | | | | | | | | | 0 | 0.00 |
| Col 3 Control3 column | | | | | | | | | | | | | | | | |
| RT: | 7.565 PCE | | 5.485 TCE | | CisDCE | | TransDCE | | VC | | Ethylene | | Ethane | | 1.533 Methane | |
| ports | P.A. | Conc. | P.A. | Conc. | P.A. | Conc. | P.A. | Conc. | P.A. | Conc. | P.A. | Conc. | P.A. | Conc. | P.A. | Conc. |
| 7 | 191.34 | 2.97 | 142.19 | 10.181 | | | | | | | | | | | 790.7 | 197.36 |
| 6 | 243.44 | 3.77 | 95.74 | 6.855 | | | | | | | | | | | 485.92 | 121.29 |
| 5 | 581.6 | 9.01 | 98.6 | 7.0598 | | | | | | | | | | | 531.76 | 132.73 |
| 4 | 935.54 | 14.50 | 113.74 | 8.1438 | | | | | | | | | | | 350.16 | 87.40 |
| 3 | 1188.7 | 18.42 | 103.01 | 7.3755 | | | | | | | | | | | 233.34 | 58.24 |
| 2 | 1017.8 | 15.78 | 121.09 | 8.67 | | | | | | | | | | | 274.06 | 68.41 |
| 1 | 1855.4 | 28.76 | 15.45 | 1.1062 | | | | | | | | | | | 5.3 | 1.32 |
| IFF | 3126.9 | 48.47 | 0 | 0 | | | | | | | | | | | 0 | 0.00 |
| Col 4 EE3 column | | | | | | | | | | | | | | | | |
| RT: | 7.565 PCE | | 5.485 TCE | | CisDCE | | TransDCE | | VC | | Ethylene | | Ethane | | 1.533 Methane | |
| ports | P.A. | Conc. | P.A. | Conc. | P.A. | Conc. | P.A. | Conc. | P.A. | Conc. | P.A. | Conc. | P.A. | Conc. | P.A. | Conc. |
| 7 | 36.04 | 0.56 | 63.4 | 4.5394 | | | | | | | | | | | 4.7 | 1.17 |
| 6 | 30.59 | 0.47 | 122.08 | 8.7409 | | | | | | | | | | | 421.69 | 105.25 |
| 5 | 101.2 | 1.57 | 154.95 | 11.094 | | | | | | | | | | | 431.26 | 107.64 |
| 4 | 487.75 | 7.56 | 149.2 | 10.683 | | | | | | | | | | | 476.82 | 119.01 |
| 3 | 707.88 | 10.97 | 156.9 | 11.234 | | | | | | | | | | | 359.87 | 89.82 |
| 2 | 1008.4 | 15.63 | 111.42 | 7.9777 | | | | | | | | | | | 197.05 | 49.18 |
| 1 | 2148 | 33.29 | 55.03 | 3.9401 | | | | | | | | | | | 28.8 | 7.19 |
| IFF | 3413.9 | 52.92 | 0 | 0 | | | | | | | | | | | 0 | 0.00 |
| Col 5 SA3 column | | | | | | | | | | | | | | | | |
| RT: | 7.565 PCE | | 5.485 TCE | | CisDCE | | TransDCE | | VC | | Ethylene | | Ethane | | 1.533 Methane | |
| ports | P.A. | Conc. | P.A. | Conc. | P.A. | Conc. | P.A. | Conc. | P.A. | Conc. | P.A. | Conc. | P.A. | Conc. | P.A. | Conc. |
| 7 | 333.37 | 5.17 | 106.65 | 7.6361 | | | | | | | | | | | 7 | 1.75 |
| 6 | 303.13 | 4.70 | 183.75 | 13.157 | | | | | | | | | | | 18.3 | 4.57 |
| 5 | 335.59 | 5.20 | 205.16 | 14.689 | | | | | | | | | | | 148.55 | 37.08 |
| 4 | 635.03 | 9.84 | 138.67 | 9.9288 | | | | | | | | | | | 477.06 | 119.07 |
| 3 | 890.59 | 13.80 | 129.31 | 9.2586 | | | | | | | | | | | 503.13 | 125.58 |
| 2 | 932.17 | 14.45 | 142.06 | 10.171 | | | | | | | | | | | 297.45 | 74.24 |
| 1 | 1726.9 | 26.77 | 61.85 | 4.4285 | | | | | | | | | | | 63.8 | 15.92 |
| IFF | 3097 | 48.00 | 0 | 0 | | | | | | | | | | | 0 | 0.00 |
| Col 6 SA2 column | | | | | | | | | | | | | | | | |
| RT: | 7.565 PCE | | 5.485 TCE | | CisDCE | | TransDCE | | VC | | Ethylene | | Ethane | | 1.533 Methane | |
| ports | P.A. | Conc. | P.A. | Conc. | P.A. | Conc. | P.A. | Conc. | P.A. | Conc. | P.A. | Conc. | P.A. | Conc. | P.A. | Conc. |
| 7 | 90.89 | 1.41 | 102.3 | 7.3247 | | | | | | | | | | | 4.73 | 1.18 |
| 6 | 36.4 | 0.56 | 71.2 | 5.0979 | | | | | | | | | | | 26.3 | 6.56 |
| 5 | 167.71 | 2.60 | 158.76 | 11.367 | | | | | | | | | | | 182.27 | 45.49 |
| 4 | 469.2 | 7.27 | 183.16 | 13.114 | | | | | | | | | | | 246.72 | 61.58 |
| 3 | 766.73 | 11.88 | 131.7 | 9.4297 | | | | | | | | | | | 330.2 | 82.42 |
| 2 | 1069.6 | 16.58 | 98.22 | 7.0326 | | | | | | | | | | | 209.14 | 52.20 |
| 1 | 1950.8 | 30.24 | 0 | 0 | | | | | | | | | | | 1.03 | 0.26 |
| IFF | 3158 | 48.95 | 0 | 0 | | | | | | | | | | | 0 | 0.00 |

| Col 7 EE2 Column used 10/8 stds | | | | | | | | | | | | | | | | |
|---------------------------------|--------------|-------|--------------|--------|-----------------|-------|-------------------|-------|------|-------|----------|-------|--------|-------|------------------|--------|
| RT: | 7.565 PCE | | 5.485 TCE | | 2.588 CisDCE | | 3.171 TransDCE | | VC | | Ethylene | | Ethane | | 1.533 Methane | |
| ports | P.A. | Conc. | P.A. | Conc. | P.A. | Conc. | P.A. | Conc. | P.A. | Conc. | P.A. | Conc. | P.A. | Conc. | P.A. | Conc. |
| 7 | 290.54 | 4.50 | 105.23 | 7.5345 | | | | | | | | | | | 33.95 | 8.47 |
| 6 | 549.18 | 8.51 | 157.44 | 11.273 | | | | | | | | | | | 282.55 | 70.52 |
| 5 | 205.04 | 3.18 | 170.92 | 12.238 | | | | | | | | | | | 805.93 | 201.16 |
| 4 | 334.64 | 5.19 | 124.06 | 8.8827 | | | | | | | | | | | 662.02 | 165.24 |
| 3 | 497.81 | 7.72 | 151.23 | 10.828 | | | | | | | | | | | 270.35 | 67.48 |
| 2 | 1094.1 | 16.96 | 113.81 | 8.1488 | | | | | | | | | | | 80.52 | 20.10 |
| 1 | 1931 | 29.93 | 0 | 0 | | | | | | | | | | | 0 | 0.00 |
| IFF | 3002 | 46.53 | 0 | 0 | | | | | | | | | | | 0 | 0.00 |

| Col 8 Control 2 Column | | | | | | | | | | | | | | | | |
|------------------------|--------------|-------|--------------|--------|--------|-------|----------|-------|------|-------|----------|-------|--------|-------|------------------|--------|
| RT: | 7.565 PCE | | 5.485 TCE | | CisDCE | | TransDCE | | VC | | Ethylene | | Ethane | | 1.533 Methane | |
| ports | P.A. | Conc. | P.A. | Conc. | P.A. | Conc. | P.A. | Conc. | P.A. | Conc. | P.A. | Conc. | P.A. | Conc. | P.A. | Conc. |
| 7 | 31.68 | 0.49 | 132.72 | 9.5028 | | | | | | | | | | | 513.4 | 128.14 |
| 6 | 41.86 | 0.65 | 162.15 | 11.61 | | | | | | | | | | | 527.67 | 131.71 |
| 5 | 579.69 | 8.99 | 177.76 | 12.728 | | | | | | | | | | | 383.56 | 95.74 |
| 4 | 802.63 | 12.44 | 279.14 | 19.986 | | | | | | | | | | | 157.38 | 39.28 |
| 3 | 719.9 | 11.16 | 117.4 | 8.4058 | | | | | | | | | | | 90.62 | 22.62 |
| 2 | 1835 | 28.44 | 143.62 | 10.283 | | | | | | | | | | | 7.48 | 1.87 |
| 1 | 1953.3 | 30.28 | 0 | 0 | | | | | | | | | | | 0 | 0.00 |
| IFF | 2985 | 46.27 | 0 | 0 | | | | | | | | | | | 0 | 0.00 |

| Col 9 SA1 column | | | | | | | | | | | | | | | | |
|------------------|--------------|-------|--------------|--------|--------|-------|----------|-------|------|-------|----------|-------|--------|-------|------------------|--------|
| RT: | 7.565 PCE | | 5.485 TCE | | CisDCE | | TransDCE | | VC | | Ethylene | | Ethane | | 1.533 Methane | |
| ports | P.A. | Conc. | P.A. | Conc. | P.A. | Conc. | P.A. | Conc. | P.A. | Conc. | P.A. | Conc. | P.A. | Conc. | P.A. | Conc. |
| 7 | 57.68 | 0.89 | 63.67 | 4.5588 | | | | | | | | | | | 16.52 | 4.12 |
| 6 | 119.31 | 1.85 | 124.56 | 8.9185 | | | | | | | | | | | 42.7 | 10.66 |
| 5 | 464.81 | 7.20 | 162.87 | 11.661 | | | | | | | | | | | 172 | 42.93 |
| 4 | 702.14 | 10.88 | 203.08 | 14.541 | | | | | | | | | | | 666.3 | 166.31 |
| 3 | 646.85 | 10.03 | 121.83 | 8.723 | | | | | | | | | | | 331.46 | 82.73 |
| 2 | 1213.1 | 18.80 | 101.61 | 7.2753 | | | | | | | | | | | 196.12 | 48.95 |
| 1 | 2499.2 | 38.74 | 0 | 0 | | | | | | | | | | | 0 | 0.00 |
| IFF | 3284 | 50.90 | 0 | 0 | | | | | | | | | | | 0 | 0.00 |

| Col 10 EE1 column | | | | | | | | | | | | | | | | |
|-------------------|--------------|-------|--------------|--------|--------|-------|----------|-------|------|-------|----------|-------|--------|-------|------------------|--------|
| RT: | 7.565 PCE | | 5.485 TCE | | CisDCE | | TransDCE | | VC | | Ethylene | | Ethane | | 1.533 Methane | |
| ports | P.A. | Conc. | P.A. | Conc. | P.A. | Conc. | P.A. | Conc. | P.A. | Conc. | P.A. | Conc. | P.A. | Conc. | P.A. | Conc. |
| 7 | 259.36 | 4.02 | 564.9 | 40.447 | | | | | | | | | | | 0 | 0.00 |
| 6 | 517.2 | 8.02 | 107.41 | 7.6906 | | | | | | | | | | | 247.73 | 61.83 |
| 5 | 704.2 | 10.92 | 257.6 | 18.444 | | | | | | | | | | | 429.98 | 107.32 |
| 4 | 743.02 | 11.52 | 29.45 | 2.1086 | | | | | | | | | | | 401.01 | 100.09 |
| 3 | 802.96 | 12.45 | 157.37 | 11.268 | | | | | | | | | | | 332.68 | 83.04 |
| 2 | 1168.2 | 18.11 | 231.26 | 16.558 | | | | | | | | | | | 135.89 | 33.92 |
| 1 | 1651.1 | 25.59 | 18.5 | 1.3246 | | | | | | | | | | | 1.27 | 0.32 |
| IFF | 1063.6 | 16.49 | 0 | 0 | | | | | | | | | | | 0 | 0.00 |

| Col 11 Control1 column | | | | | | | | | | | | | | | | |
|------------------------|--------------|-------|--------------|--------|--------|-------|----------|-------|------|-------|----------|-------|--------|-------|------------------|--------|
| RT: | 7.565 PCE | | 5.485 TCE | | CisDCE | | TransDCE | | VC | | Ethylene | | Ethane | | 1.533 Methane | |
| ports | P.A. | Conc. | P.A. | Conc. | P.A. | Conc. | P.A. | Conc. | P.A. | Conc. | P.A. | Conc. | P.A. | Conc. | P.A. | Conc. |
| 7 | 170.63 | 2.64 | 262.77 | 18.814 | | | | | | | | | | | 181.93 | 45.41 |
| 6 | 88.94 | 1.38 | 140.25 | 10.042 | | | | | | | | | | | 313.07 | 78.14 |
| 5 | 109.24 | 1.69 | 116.54 | 8.3443 | | | | | | | | | | | 623.67 | 155.67 |
| 4 | 206.62 | 3.20 | 54.05 | 3.87 | | | | | | | | | | | 14.53 | 3.63 |
| 3 | 405.43 | 6.28 | 121.9 | 8.728 | | | | | | | | | | | 96.3 | 24.04 |
| 2 | 168.65 | 2.61 | 165.37 | 11.84 | | | | | | | | | | | 359.49 | 89.73 |
| 1 | 2138.6 | 33.15 | 0 | 0 | | | | | | | | | | | 0 | 0.00 |
| IFF | 3345 | 51.85 | 2 | 0.1432 | | | | | | | | | | | 0 | 0.00 |

| Col 12 SA0 column | | | | | | | | | | | | | | | | |
|-------------------|--------------|-------|--------------|--------|--------|-------|----------|-------|------|-------|----------|-------|--------|-------|------------------|-------|
| RT: | 7.565 PCE | | 5.485 TCE | | CisDCE | | TransDCE | | VC | | Ethylene | | Ethane | | 1.533 Methane | |
| ports | P.A. | Conc. | P.A. | Conc. | P.A. | Conc. | P.A. | Conc. | P.A. | Conc. | P.A. | Conc. | P.A. | Conc. | P.A. | Conc. |
| 7 | 176.06 | 2.73 | 91.08 | 6.5213 | | | | | | | | | | | 36.47 | 9.10 |
| 6 | 183.77 | 2.85 | 118.79 | 8.5054 | | | | | | | | | | | 46.52 | 11.61 |
| 5 | 440.58 | 6.83 | 141.09 | 10.102 | | | | | | | | | | | 133.82 | 33.40 |
| 4 | 336.36 | 5.21 | 116.11 | 8.3135 | | | | | | | | | | | 104.52 | 26.09 |
| 3 | 778.75 | 12.07 | 135.39 | 9.6939 | | | | | | | | | | | 115.99 | 28.95 |
| 2 | 969.88 | 15.03 | 142.01 | 10.168 | | | | | | | | | | | 66.87 | 16.69 |
| 1 | 1548.5 | 24.00 | 31.55 | 2.259 | | | | | | | | | | | 7.53 | 1.88 |
| IFF | 3284 | 50.90 | 0 | 0 | | | | | | | | | | | 0 | 0.00 |

Week 6 column 10 data was an outlier due to the low PCE readings within the columns. column 10 data was not used during average calculations.

Appendix H nitrate and sulfate raw data

CC3 ALL CONC IN ppm(mg /L)

| 12.25 Chloride | 12.83 Nitrite | 14.76 Nitrate | 15.09 Sulfate |
|-------------------|------------------|------------------|------------------|
| Conc. | Conc. | Conc. | Conc. |
| 119.714 | | 8.175 | 18.989 |
| 107.655 | | 6.795 | 13.810 |
| 105.232 | | 5.663 | 14.549 |
| 104.911 | | 5.408 | 18.546 |
| 104.551 | | 5.307 | 23.610 |
| 103.750 | | 5.223 | 24.881 |
| 100.840 | | 5.052 | 29.373 |
| 97.348 | | 4.879 | 28.843 |

11/18/2005 Col 7 EE2 ALL CONC IN ppm(mg /L)

| RT: | 12.250 Chloride | 12.830 Nitrite | 14.760 Nitrate | 15.090 Sulfate |
|-------|--------------------|-------------------|-------------------|-------------------|
| ports | Conc. | Conc. | Conc. | Conc. |
| 7 | 124.023 | | 7.417 | 9.812 |
| 6 | 111.089 | | 5.814 | 10.979 |
| 5 | 112.377 | | 5.692 | 12.726 |
| 4 | 114.207 | | 5.487 | 18.922 |
| 3 | 116.872 | | 5.282 | 21.312 |
| 2 | 118.283 | | 5.120 | 26.564 |
| 1 | 121.167 | | 4.954 | 35.540 |
| IFF | 132.301 | | 4.268 | 41.211 |

CC2 ALL CONC IN ppm(mg /L)

| 12.25 Chloride | 12.83 Nitrite | 14.76 Nitrate | 15.09 Sulfate |
|-------------------|------------------|------------------|------------------|
| Conc. | Conc. | Conc. | Conc. |
| 121.285 | | 3.918 | 16.718 |
| 106.194 | | 7.988 | 13.392 |
| 101.802 | | 6.866 | 14.721 |
| 100.963 | | 5.653 | 19.369 |
| 100.676 | | 5.235 | 20.802 |
| 100.789 | | 5.204 | 24.981 |
| 98.448 | | 5.085 | 28.493 |
| 95.327 | | 4.951 | 28.134 |

Col 8 CON 2 ALL CONC IN ppm(mg /L)

| RT: | 12.250 Chloride | 12.830 Nitrite | 14.760 Nitrate | 15.090 Sulfate |
|-------|--------------------|-------------------|-------------------|-------------------|
| ports | Conc. | Conc. | Conc. | Conc. |
| 7 | 107.495 | n.a. | 5.985 | 11.287 |
| 6 | 106.149 | n.a. | 6.206 | 8.018 |
| 5 | 106.878 | n.a. | 5.743 | 16.454 |
| 4 | 106.731 | n.a. | 5.590 | 20.150 |
| 3 | 106.236 | n.a. | 5.501 | 23.361 |
| 2 | 105.538 | n.a. | 5.221 | 29.735 |
| 1 | 104.392 | n.a. | 5.204 | 30.672 |
| IFF | 104.250 | n.a. | 5.160 | 30.604 |

CON ALL CONC IN ppm(mg /L)

| 12.25 Chloride | 12.83 Nitrite | 14.76 Nitrate | 15.09 Sulfate |
|-------------------|------------------|------------------|------------------|
| Conc. | Conc. | Conc. | Conc. |
| 99.690 | | 5.228 | 21.462 |
| 99.373 | | 5.348 | 19.919 |
| 97.200 | | 6.055 | 15.531 |
| 97.416 | | 5.328 | 17.789 |
| 98.406 | | 5.129 | 21.368 |
| 97.950 | | 5.015 | 22.683 |
| 98.179 | | 4.812 | 28.641 |
| 94.936 | | 4.641 | 27.416 |

Col 9 SA1 ALL CONC IN ppm(mg /L)

| RT: | 12.250 Chloride | 12.830 Nitrite | 14.760 Nitrate | 15.090 Sulfate |
|-------|--------------------|-------------------|-------------------|-------------------|
| ports | Conc. | Conc. | Conc. | Conc. |
| 54 | 221.897 | n.a. | 11.417 | 19.089 |
| 45 | 112.613 | n.a. | 7.950 | 15.979 |
| 36 | 106.619 | n.a. | 6.157 | 18.623 |
| 27 | 106.668 | n.a. | 5.719 | 20.478 |
| 21 | 107.410 | n.a. | 5.655 | 21.508 |
| 15 | 106.553 | n.a. | 5.387 | 26.127 |
| 9 | 104.510 | n.a. | 5.130 | 30.748 |
| 0 | 104.705 | n.a. | 5.128 | 30.649 |

EE3 ALL CONC IN ppm(mg /L)

| 12.25 Chloride | 12.83 Nitrite | 14.76 Nitrate | 15.09 Sulfate |
|-------------------|------------------|------------------|------------------|
| Conc. | Conc. | Conc. | Conc. |
| 151.81756 | | 7.462 | 10.012 |
| 135.0578 | | 6.21 | 8.346 |
| 137.45724 | | 5.63 | 12.036 |
| 140.01008 | | 5.39 | 22.198 |
| 144.02705 | | 5.14 | 25.857 |
| 148.4497 | | 5.13 | 31.281 |
| 151.77573 | | 4.065 | 43.984 |
| 167.96252 | | 4.08 | 50.110 |

Col 10 EE1 ALL CONC IN ppm(mg /L)

| RT: | 12.250 Chloride | 12.830 Nitrite | 14.760 Nitrate | 15.090 Sulfate |
|-------|--------------------|-------------------|-------------------|-------------------|
| ports | Conc. | Conc. | Conc. | Conc. |
| 7 | 106.872 | 0.000 | 7.275 | 10.128 |
| 6 | 100.698 | 0.012 | 5.523 | 15.550 |
| 5 | 100.891 | 0.011 | 5.409 | 16.056 |
| 4 | 101.098 | 0.000 | 5.518 | 19.196 |
| 3 | 102.576 | 0.000 | 5.207 | 21.967 |
| 2 | 103.731 | 0.000 | 5.357 | 20.181 |
| 1 | 105.538 | 0.000 | 4.901 | 31.258 |
| IFF | 112.629 | 0.000 | 4.966 | 33.057 |

SA3 ALL CONC IN ppm(mg /L)

| 12.25 Chloride | 12.83 Nitrite | 14.76 Nitrate | 15.09 Sulfate |
|-------------------|------------------|------------------|------------------|
| Conc. | Conc. | Conc. | Conc. |
| 132.898 | | 8.243 | 15.949 |
| 109.440 | | 8.417 | 15.321 |
| 99.705 | | 6.623 | 14.689 |
| 98.710 | | 5.755 | 18.028 |
| 99.650 | | 5.093 | 22.422 |
| 99.605 | | 5.002 | 22.888 |
| 98.263 | | 4.817 | 28.948 |
| 94.535 | | 4.641 | 27.534 |

Col 11 CON ALL CONC IN ppm(mg /L)

| RT: | 12.250 Chloride | 12.830 Nitrite | 14.760 Nitrate | 15.090 Sulfate |
|-------|--------------------|-------------------|-------------------|-------------------|
| ports | Conc. | Conc. | Conc. | Conc. |
| 7 | 119.511 | n.a. | 6.709 | 18.880 |
| 6 | 106.757 | n.a. | 6.241 | 9.485 |
| 5 | 107.090 | n.a. | 5.846 | 15.072 |
| 4 | 106.126 | n.a. | 5.437 | 20.379 |
| 3 | 105.628 | n.a. | 5.313 | 23.769 |
| 2 | 105.958 | n.a. | 5.211 | 28.912 |
| 1 | 104.220 | n.a. | 5.136 | 30.600 |
| IFF | 102.658 | n.a. | 5.066 | 30.067 |

SA2 ALL CONC IN ppm(mg /L)

| 12.25 Chloride | 12.83 Nitrite | 14.76 Nitrate | 15.09 Sulfate |
|-------------------|------------------|------------------|------------------|
| Conc. | Conc. | Conc. | Conc. |
| 126.403 | | 7.158 | 13.848 |
| 147.302 | | 10.933 | 1.739 |
| 100.883 | | 5.737 | 11.342 |
| 99.298 | | 4.954 | 16.731 |
| 99.529 | | 4.958 | 22.310 |
| 99.981 | | 4.914 | 24.697 |
| 96.210 | | 4.752 | 28.174 |
| 95.204 | | 4.663 | 27.933 |

Col 12 SA 0 ALL CONC IN ppm(mg /L)

| RT: | 12.250 Chloride | 12.830 Nitrite | 14.760 Nitrate | 15.090 Sulfate |
|-------|--------------------|-------------------|-------------------|-------------------|
| ports | Conc. | Conc. | Conc. | Conc. |
| 7 | 106.187 | n.a. | 6.351 | 6.534 |
| 6 | 120.845 | n.a. | 8.138 | 8.966 |
| 5 | 106.669 | n.a. | 5.841 | 18.491 |
| 4 | 105.077 | n.a. | 5.648 | 17.860 |
| 3 | 105.188 | n.a. | 5.300 | 22.768 |
| 2 | 104.148 | n.a. | 5.167 | 25.907 |
| 1 | 103.528 | n.a. | 5.106 | 31.898 |
| IFF | 104.067 | n.a. | 5.035 | 30.473 |

Bibliography

(1) Literature Cited

- (1) Amon, J. P.; Shelly, M. L.; Agrawal, A., Development of a wetland constructed for treatment of groundwater contaminated by chlorinated ethenes. Hydrology, soil, and vegetation. *Submitted to environmental engineering*, 2006.
- (2) Anderson, T. A.; Coats, J. R. (Eds). *Bioremediation through rhizosphere technology*; American Chemical Society: Washington, DC: 1994; p 249.
- (3) Armstrong, W.; Cousins, D.; Armstrong, J.; Turner, D. W.; Beckett, P. M. Oxygen Distribution in Wetland Plant Roots and Permeability Barriers to Gas-exchange with the Rhizosphere: a Microelectrode and Modelling Study with *Phragmites australis*. *Annals of Botany* 2000, 86, 687-703.
- (4) Astin, J. and Sanders, D.A. The Role of Cost in Remedy Selection *J. of Env. Cleanup Costs, Technologies, and Techniques* 1996, 6 (3), 55-67.
- (5) Bankston, J. L.; Sola, D. L.; Komor, A. T.; Dwyer, D. F. Degradation of trichloroethylene in wetland microcosms containing broad-leaved cattail and eastern cottonwood. *Water Res.* 2002, 36 (6), 1539-1546.
- (6) Bower, E. J. *Bioremediation of Organic Contaminates in the subsurface* In Mitchell, R. (Ed.); *Environmental Microbiology*; John Wiley & Sons: New York: 1992; p 287-318.
- (7) Bower, E. J.; McCARTY, P. L. Transformations of 1- and 2-Carbon Halogenated Aliphatic Organic Compounds Under Methanogenic Conditions. *Applied And Environmental Microbiology* 1983, Vol. 45 (No. 4), 1286-1294.
- (8) Bower, E. J.; Rittmann, B. E.; McCarty, P. L. Anaerobic Degradation of Halogenated 1 and 2 Carbon Organic Compounds. *Environmental Science & Technology* 1981, 15 (5), 596-599.
- (9) Chapelle, F. H. *Groundwater Microbiology and Geochemistr*; John Wiley and Sons Inc.: New York: 1993; p 588.

- (10) Clemmer, N. D. Characterization of Chlorinated Solvent Degradation in a Constructed Wetland. Graduate School of Engineering and Management. *MS thesis* 2003, AFIT/GEE/ENV/03-03.
- (11) Cunningham, S. D.; Shann, J. R.; Crowley, D. E. *Phytoremediation of contaminated water and soil*; In Kruger, E. L.; Anderson, T. A.; Coats, J. R. (Eds.); *Phytoremediation of soil and water contaminants*; American Chemical Society: Washington, D.C.: 1997; p 2-9.
- (12) Dolan, E. M.; McCarty, L. P. Small-column microcosm for assessing methane-stimulated vinyl chloride transformation in aquifer samples. *Environmental Science & Technology* 1995, 29 (8), 1892.
- (13) Eguchi, Masahiro et al. A Field Evaluation Of In Situ Biodegradation Of Trichloroethylene Through Methane Injection. *Water Resource* 2001, 35 (9), 2145-2152.
- (14) Environmental Protection Agency (EPA). *Treatment Technology for site cleanup: Annual Status Report (11th edition)*.; EPA: Washington, D.C.: Office of solid waste and Emergency Response, 2004; EPA-542-R-03-001.
- (15) Environmental Protection Agency (EPA). *Drinking Water Standards*. Adapted from EPA 816-F-02-013 <http://www.epa.gov/safewater/mcl.html>. 2002, 2005 (Feb/01), 1.
- (16) Environmental Protection Agency (EPA). *Innovative Treatment Technologies: Annual Status Report (8th Edition)*.; EPA: Washington, D.C.: Office of solid waste and Emergency response, 1996; EPA-542-R-96-010.
- (17) Fan, A. M. Trichloroethylene: water contamination and health risk assessment. . *Rev. Environ. Contam toxicol* 1988, 101, 55-92.
- (18) Fogel, M.; Tadde, A.; Fogel, S. Biodegradation of Chlorinated Ethenes by a Methane-Utilizing Mixed Culture. *Applied And Environmental Microbiology* 1986, 4, 720-724.
- (19) Freemann, D. L.; Gossett, J. M. Biological Reductive Dechlorination of Tetrachloroethylene and Trichloroethylene to Ethylene under Methanogenic Conditions. *Applied and Environmental Microbiology* 1989, 55 (9), 2144-2151.

- (20) Isalou, Mansour; Sleep, E. B.; Liss, N. S. Biodegradation of high concentrations of tetrachloroethene in a continuous flow column system. *Environmental Science & Technology* 1998, 32 (22), 3579.
- (21) Johnson, R. L.; Pankow, J. F. Dissolution of Dense Chlorinated Solvents into Groundwater. 2. Source Functions for Pools of Solvent. *Environ. Sci. Technol.* 1992, 26, 896-901.
- (22) Lee, M. D.; Odom, J. M.; Buchanan, R. J. New Perspectives On Microbial Dehalogenation Of Chlorinated Solvents: Insights from the Field. *Annu. Rev. Microbiol.* 1998, 52, 423-452.
- (23) Lelie, Dan van der; Schwitzguebel, J. P.; Glass, D. J.; Vangronsveld, J.; Baker, A. Assessing Phytoremediation's Progress. *Environmental science and technology* 2001, 35 (21), A446-A452.
- (24) Little, C. Deane et al. Trichloroethylene Biodegradation by a Methane-Oxidizing Bacterium *Applied And Environmental Microbiology* 1988, 54 (4), 951-956.
- (25) Lorah, M. M.; Voytek, M. A.; Spencer, T. A. Preliminary Assessment of Microbial Communities and Biodegradation of Chlorinated Volatile Organic Compounds in Wetland at Cluster 13, Lauderick Creek Area, Aberdeen Proving Ground, Maryland. *USGS* 2003, 03-4119.
- (26) Lorah, M.; Olsen, L. Degradation of 1,1,2,2-Tetrachloroethane in a Freshwater Tidal Wetland: Field and Laboratory Evidence. *Environ. Sci. Technol.* 1999, 33, 227-234.
- (27) Lunney, A. I.; Zeeb, B. A.; Reimer, K. J. Uptake of weathered DDT in vascular plants: Potential for phytoremediation. *Environmental Science & Technology* 2004, 38 (22), 6147.
- (28) Lynge, E.; Anttila, A.; Hemminki, K. Organic solvents and cancer. *Cancer Causes & Control* 1997, 8 (3), 406-419.
- (29) Masters, G. M. *Introduction to environmental engineering and science*; Prentice Hall: Upper Saddle River, N.J: 1997; p 651.
- (30) Mitsch, W. J.; Gosselink, J. G. *Wetland*; Van Nostrand Reinhold: New York: 1993; p 721.

- (31) Pankow, James F. and Cherry, John A. *Dense Chlorinated Solvents and other DNAPLs in Groundwater*; Waterloo Press: Portland, Oregon: 1996; p 515.
- (32) Pankow, J. F.; Cherry, J. A. *Dense Chlorinated Solvents and other DNAPLs in Groundwater*; Waterloo Press: Portland: 1996; p 511.
- (33) Schnoor, J. L.; Louis, L. A.; Mccutcheon, S. C.; Wolfe, N. L.; Carreira, L. H. Phytoremediation of Organic and Nutrient contamination. *Environmental science and technology* 1995, 29 (7), 318A-323A.
- (34) Smidt, Hauke and de Vos, Willem M. Anaerobic Microbial Degradation. *Annu. Rev. Microbiol.* 2004, 58, 43-73.
- (35) Sobolewski, T. A. Characterization of solvent degradation profile due to microbial and chemical processes in a constructed wetland. 2003, *AFIT/GEM/ENV/04M-17*.
- (36) United States General Accounting Office. *Environmental Protection: Challenges in Defense Environmental Program Management*; US Government Printing Office: Washington D.C., 1995; GAO/T-NSIAD-95-121.
- (37) USDA and NRCS. The Plant Database, Version 3.5 <http://plants.usda.gov> National Plant Data Center, Baton Rouge, LA 70874-4490 USA. 2004, .
- (38) Van Der Lelie, Daniel; Schwitzguebel, J.; Glass, D. J.; Vangronsveld, J.; Baker, A. Assessing Phytoremediation's Progress. *Environmental Science and Technology* 2001, 35 (21), A446.
- (39) Vogel, T.; Criddle, C.; McCarty, P. Transformations of halogenated aliphatic compounds. *Environmental Science & Technology* 1987, 21 (8), 722-736.
- (40) Vogel, T. M.; Roudier, P. Considering innovative groundwater technologies. *Pollution Engineering* 1998, , 18.
- (41) White, J. C.; Parrish, Z. D.; Isleyen, M.; Gent, M. P. N.; Iannucci-Berger, W.; Eitzer, B. D.; Mattina, M. I. Influence of nutrient amendments on the phytoextraction of weathered 2,2-bis(p-chlorophenyl)-1,1-dichloroethylene by cucurbits. *Environ. Toxicol. Chem.* 2005, 24 (4), 987-994.

- (42) Wiedemeier, T. H.; Rifai, H. S.; Newell, C. J.; Wilson, J. T. *Natural Attenuation of Fuels and Chlorinated Solvents in the Subsurface*; John Wiley & Sons, Inc: New York: 1999; p 611.
- (43) Wilson, J. T.; Wilson, B. H. Biotransformation of Trichloroethylene in Soil . *Applied And Environmental Microbiology* 1985, 49 (1), 242-243.
- (44) Yang, Lei et al. Feasibility of bioremediation of trichloroethylene contaminated sites by nitrifying bacteria through cometabolism with ammonia. *Journal of Hazardous Materials* 1999, B69, 111-126.
- (45) Zumdahl, s. s. *Chemistry*; Houghton Mifflin Company: Boston: 1997; p 1118.

Vita

2nd Lt Jun Yan graduated from Niles North High School in Skokie, Illinois. He attended the University of Illinois at Champaign-Urbana and completed his undergraduate studies in Civil Engineering in 2004. Upon graduation he was commissioned through the Air Force ROTC and entered AFIT's Graduate School of Engineering and Management. His next assignment will be at Misawa AB, Japan.

REPORT DOCUMENTATION PAGE

Form Approved
OMB No. 074-0188

The public reporting burden for this collection of information is estimated to average 1 hour per response, including the time for reviewing instructions, searching existing data sources, gathering and maintaining the data needed, and completing and reviewing the collection of information. Send comments regarding this burden estimate or any other aspect of the collection of information, including suggestions for reducing this burden to Department of Defense, Washington Headquarters Services, Directorate for Information Operations and Reports (0704-0188), 1215 Jefferson Davis Highway, Suite 1204, Arlington, VA 22202-4302. Respondents should be aware that notwithstanding any other provision of law, no person shall be subject to a penalty for failing to comply with a collection of information if it does not display a currently valid OMB control number.

PLEASE DO NOT RETURN YOUR FORM TO THE ABOVE ADDRESS.

| | | | | | | |
|--|----------------------|--|---|--|--|--|
| 1. REPORT DATE (DD-MM-YYYY) 23-03-2006 | | 2. REPORT TYPE Master's Thesis | | 3. DATES COVERED (From – To) Jan 2005 – Mar 2006 | | |
| 4. TITLE AND SUBTITLE Evaluation Of Chlorinated Solvents Removal Efficiency Among Three Wetland Plant Species: A Mesocom Study | | | | 5a. CONTRACT NUMBER | | |
| | | | | 5b. GRANT NUMBER | | |
| | | | | 5c. PROGRAM ELEMENT NUMBER | | |
| 6. AUTHOR(S) Jun Yan, 2 nd Lt, USAF | | | | 5d. PROJECT NUMBER | | |
| | | | | 5e. TASK NUMBER | | |
| | | | | 5f. WORK UNIT NUMBER | | |
| 7. PERFORMING ORGANIZATION NAMES(S) AND ADDRESS(S) Air Force Institute of Technology Graduate School of Engineering and Management (AFIT/ENV) 2950 Hobson Way WPAFB OH 45433-7765 | | | | 8. PERFORMING ORGANIZATION REPORT NUMBER AFIT/GEM/ENV/06M-18 | | |
| 9. SPONSORING/MONITORING AGENCY NAME(S) AND ADDRESS(ES) N/A | | | | 10. SPONSOR/MONITOR'S ACRONYM(S) | | |
| | | | | 11. SPONSOR/MONITOR'S REPORT NUMBER(S) | | |
| 12. DISTRIBUTION/AVAILABILITY STATEMENT APPROVED FOR PUBLIC RELEASE; DISTRIBUTION UNLIMITED. | | | | | | |
| 13. SUPPLEMENTARY NOTES | | | | | | |
| 14. ABSTRACT Different species of plants need to be studied individually to compare the remediation efficiency of each species. This research will study three different wetland plants species and an unplanted control, under a laboratory setting. Each plant has a different characteristic favorable for chlorinated solvent degradation. <i>Eleocharis erythropoda</i> (Spike Rush) are plants with thin tube like leaves and large root mass. <i>Carex comosa</i> (Bearded Sedge) has broad leaves and <i>Scirpus atrovirens</i> (Green Bulrush) are broad leafed wetland plants with a long flowering stem during reproduction. PCE will be injected into the plant mesocosm and any possible PCE degradation will be observed. It is my hypothesis that PCE will be degraded into daughter products in all the mesocosms. However, the question will be which plant is the most efficient at chlorinated solvent degradation and is there difference between the planted reactors and the control reactors? | | | | | | |
| 15. SUBJECT TERMS Phytoremediation, bioremediation, PCE, TCE, chlorinated solvents | | | | | | |
| 16. SECURITY CLASSIFICATION OF: | | | 17. LIMITATION OF ABSTRACT UU | 18. NUMBER OF PAGES 122 | 19a. NAME OF RESPONSIBLE PERSON Bleckmann, Charles A., Civilian (ENV) | |
| REPORT U | ABSTRACT U | c. THIS PAGE U | | | 19b. TELEPHONE NUMBER (Include area code) (937) 255-3636, ext 4721; e-mail: Charles.Bleckmann@afit.edu | |