



ระบบควบคุมแบบไฮบริดโดยอิงแรงและสัญญาณไฟฟ้ากล้ามเนื้อ สำหรับหุ่นยนต์ทำกายภาพบำบัด

สรุจ พันธุ์จันทร์^{1*} และ สยาม เจริญเสียง²

บทคัดย่อ

งานวิจัยนี้นำเสนอระบบควบคุมแบบไฮบริดสำหรับหุ่นยนต์กายภาพบำบัดที่ใช้สัญญาณจากเซ็นเซอร์วัดแรงและเซ็นเซอร์วัดสัญญาณไฟฟ้ากล้ามเนื้อ ระบบควบคุมแบบไฮบริดนี้ได้ใช้ควบคุมการทำงานส่วนข้อศอกของแขนกลแบบสวมใส่ได้ 4 องศาอิสระ การควบคุมแรงในระบบไฮบริดนี้ใช้สมการแอดมิตแตนซ์ในการควบคุมการเคลื่อนไหวของข้อต่อแขนกลให้เป็นไปตามแรงที่กระทำจากภายนอก แต่เนื่องจากผลตอบสนองของระบบควบคุมแบบแอดมิตแตนซ์มีผลตอบสนองที่มีการสั่นมากเมื่อผู้ใช้งานเคลื่อนที่แขนและหยุดอย่างรวดเร็ว ดังนั้นสัญญาณไฟฟ้ากล้ามเนื้อจึงถูกนำมาตรวจจับการเกร็งของกล้ามเนื้อผู้ใช้งาน และสั่งงานให้ระบบควบคุมแรงแบบแอดมิตแตนซ์หยุดการรับค่าสัญญาณจากเซ็นเซอร์วัดแรงเพื่อให้การตอบสนองของระบบไม่มีการสั่นเมื่อผู้ใช้งานหยุดการเคลื่อนที่แขนกะทันหัน นอกจากนี้ในส่วนของารชดเชยแรงโน้มถ่วงที่ส่งผลต่อแขนกลได้ใช้โครงข่ายประสาทเทียมแบบ Generalized Regression Neural Network (GRNN) ในการประมาณค่าชดเชยแรงโน้มถ่วง ซึ่งจากผลการทดลองพบว่าโครงข่ายประสาทเทียมสามารถคำนวณค่าชดเชยแรงโน้มถ่วงได้มีความถูกต้องถึง 97.32% และผลตอบสนองของระบบเร็วขึ้น 83.13% หลังจากใช้ประโยชน์จากสัญญาณไฟฟ้ากล้ามเนื้อในระบบควบคุมแบบไฮบริด

คำสำคัญ: การควบคุมแรง สัญญาณไฟฟ้ากล้ามเนื้อ การควบคุมแบบไฮบริด แขนกลแบบสวมใส่ได้
การกายภาพบำบัด

¹ นักศึกษาระดับปริญญาเอก สถาบันวิทยาการหุ่นยนต์ภาคสนาม มหาวิทยาลัยเทคโนโลยีพระจอมเกล้าธนบุรี

² รองศาสตราจารย์ สถาบันวิทยาการหุ่นยนต์ภาคสนาม มหาวิทยาลัยเทคโนโลยีพระจอมเกล้าธนบุรี

* ผู้มีพันธะประสานงาน โทร. 08-7996-1958 อีเมล: sa_panjant@icloud.com



Hybrid Force/EMG Based Control System for Rehabilitation Robot

Sarut Panjan^{1*} and Siam Charoenseang²

Abstract

This paper presents a hybrid control system of rehabilitation robot with force and EMG signals. The proposed control system is implemented on the elbow joint of the 4 DOF universal exoskeleton. Admittance control method is applied to control this rehabilitation robot. However, the transient response of the admittance control cloud lead in a large overshoot when the user moves exoskeleton joint quickly then suddenly stops. Hence, the EMG sensor is used to detect the muscle contraction and then the force input will be set to zero for improving transient response of the hybrid controller. Furthermore, the generalized regression neural network (GRNN) is applied for predicting the static gravity force compensation. The experimental result indicates that the GRNN can predict the static gravity force with accuracy of 97.32%. Moreover, 83.13% of the transient response is improved by the utilization of the EMG signal in the hybrid controller.

Keywords: Force Control, EMG Based Control, Hybrid Control, Exoskeleton, Rehabilitation

¹ Ph.D. Student, Institute of Field Robotics, King Mongkut's University of Technology Thonburi

² Associate Professor, Institute of Field Robotics, King Mongkut's University of Technology Thonburi

* Corresponding Author Tel. 08-7996-1958 e-mail: sa_panjan@icloud.com



1. Introduction

According to the World Health Organization (WHO), 15 million people worldwide suffer from a stroke in every year [1]. In the United States, more than 4 million people survived from a stroke are disabled. Seventy-five percent of stroke patients have impaired motor skills [2]. For getting back to a normal life, the patient should get rehabilitation as quickly as possible. Traditional method for stroke recovery is rehabilitation therapy by physiotherapist. For recent years, some robots have been utilized in rehabilitation therapy tasks for improving upper-limb motor skill. Generally, almost robots are pre-programmed before runtime using a position control scheme. However, the robot should be interacted by physical force from the user during rehabilitation. Hence, the most commonly used technique to control the interaction between patient and robot is an impedance control [3]. The impedance control scheme was proposed by Hogan [4-7]. In his research, Hogan presented the control of dynamic interaction between a manipulator and its environment. The position, velocity, or acceleration are required for the impedance control technique and a resulting force is an output of this technique. Another important technique is admittance control which is the inverse of the impedance control. However, the admittance controller is highly sensitive to friction and other uncertainties [8]. At present, the impedance and admittance control technique are applied to many robot controllers. The wearable orthosis for tremor assessment and suppression (WOTAS) used the impedance control technique for controlling each joint of the WOTAS exoskeleton [9]. The MIT-MANUS robot utilized impedance controller to control the position of the robot end-effector

[10,11]. Beside the impedance control, the admittance control is applied to the MGA upper limb exoskeleton for controlling position/velocity when external force exert on each joint [12]. The unique exoskeleton system (EXO-UL7) used the PID admittance control as the upper-level control and the linear PID control as the lower-level control [13]. The impedance and admittance control generally require system modelling. However, the system modelling of complex structure is hard to obtain. Hence, the neural network could be applied to estimate the system modelling. Xiuxia and team proposed the lower extreme carrying exoskeleton robot adaptive control using wavelet neural network [14]. They used the neural network to identify the dynamic model of exoskeleton. The exoskeleton joint angle, joint velocity, and joint acceleration are set as inputs of the network while the joint torque is set as output. The input and output of the system are used to predict the dynamic parameters of that system. However, recording the input and output of the system with dynamic parameters takes a longer time than the recording of the static parameters. However, the network trained with static parameters cannot take care of the dynamic parameters, effectively. Hence, the electromyography signal (EMG) is explored to control the exoskeleton. Rosen and team proposed the Performances of Hill-Type and Neural Network Muscle Models-Toward a Myo signal-Based Exoskeleton [15]. In their research, the EMG signal is applied to that system as an input and the output of this system is the estimated force. Generally, the controller with EMG signal from the human muscle does not require the dynamic parameters of the robot but it requires gain tuning to determine the appropriate thresholds for each user.

Hence, this paper focuses on the utilization of hybrid control systems for controlling the exoskeleton arm. The developed control system presents the hybrid control technique which combines force and EMG sensors to solve the problems from each previous controller. This control system will be implemented on the single joint of the universal exoskeleton arm. It was designed and built at the Institute of Field Robotics (FIBO), Thailand [16]. The generalized regression neural network (GRNN) is utilized for predicting the static gravity compensation which is maps between the joint angle as input and the force at the elbow as output of the training model. However, the dynamic parameters of the exoskeleton structure cannot be compensated with GRNN. So, the transient response will be oscillated if the user moves the arm quickly. To solve this problem, the EMG signals of the biceps and triceps muscles are used to detect the muscle contraction. However, each person has different EMG signal magnitude during the user move his/her arm. Hence, a time-relationship of the biceps and triceps EMG signal is used to control the input force of the exoskeleton joint. The force input will be set to zero when the EMG signals of the biceps and triceps muscles appear simultaneously. Hence, this proposed hybrid control system can be utilized for controlling rehabilitation robot with force and EMG signals. This control system does not require exact dynamic parameters of the robot. Moreover, the EMG and force sensors are utilized to this proposed control system for improving the system transient response.

2. System Overview

Configuration of the proposed system is shown in Figure 1. This system consists of a

universal exoskeleton arm used to assist human arm movement. Force sensors are mounted on each joint of the exoskeleton. Joint angle and joint torque will be sent to the main computer via the motion control card and the data acquisition module. The MYO™ armband with eight EMG electrodes is used to detect the electrical activity of the biceps and triceps muscles as shown in Figure 2. All sensors send data to the main computer for calculating joint position and velocity of exoskeleton arm.



Figure 1 System Overview of Exoskeleton Arm



Figure 2 Number of Electrodes on the MYO Armband

3. Design and Material

The structure of rehabilitation robot is designed to offer 4 degrees of freedom. Joint 1, 2, and 3 represent shoulder joints and joint 4 represents elbow joint as shown in Figure 3. This robot is designed to support weight of user/patient arm during rehabilitation task. Hence, a 6061-O aluminum sheet with the thickness of 5 mm. was used for the exoskeleton links because this material is lightweight and rigid. This material has maximum tensile strength up to 120 MPa or 18,000 psi and maximum yield strength up to 55 MPa or 8,000 psi. Since the main structure of the robot arm is built from the conductive material, the analog signal from the force sensor can be disturbed by the electrical noise from the AC servo motor. Hence, the 3D printer is used to create the non-conductive mechanical part which is ABS plastic material for mounting the force sensor as shown in Figure 4.

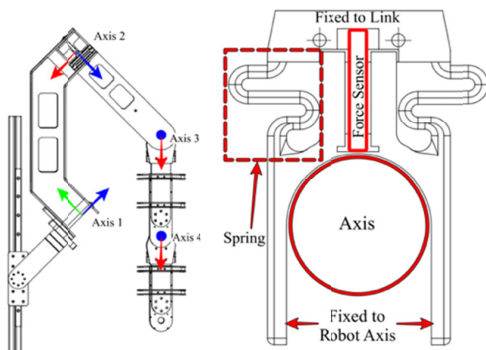

Figure 3 Structure Design of Robot Arm and Force Sensor Mount

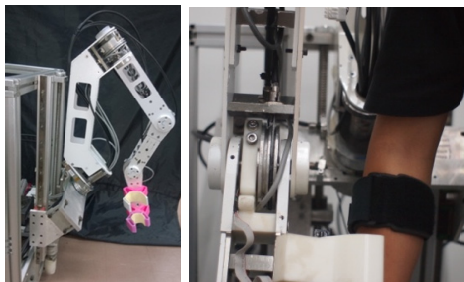

Figure 4 Materials used for Robot Arm Structure and Force Sensor Mount

4. System Components

The system consists of two main components which are hardware and software components. The hardware components include with an upper limb exoskeleton arm and bio-signal sensors which are the MYO armband. Upper limb exoskeleton arm receives the desired position/velocity from the main computer. It also returns the current position/velocity and force data to the main computer. The software component consists of exoskeleton arm manager and bio-signal manager.

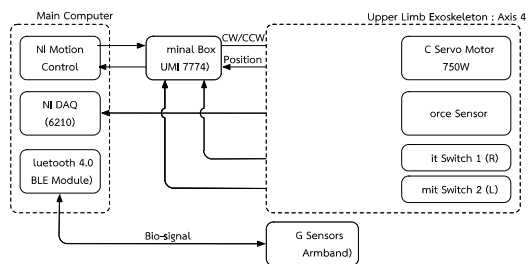

Figure 5 Hardware Components

In Figure 5, the upper limb exoskeleton receives the desired position and velocity from the main computer via a motion control card. After that the current position/velocity from the exoskeleton will be sent to the main computer. Force sensor is installed on the exoskeleton joint for sensing the external force exerted on exoskeleton joint in clockwise and counter clockwise directions. The force sensor signal is amplified before being sent to the main computer. Bio-signal sensor set is also used for detecting muscle activation. This sensor sends bio-signals to the main computer via Bluetooth 4.0 BLE module.

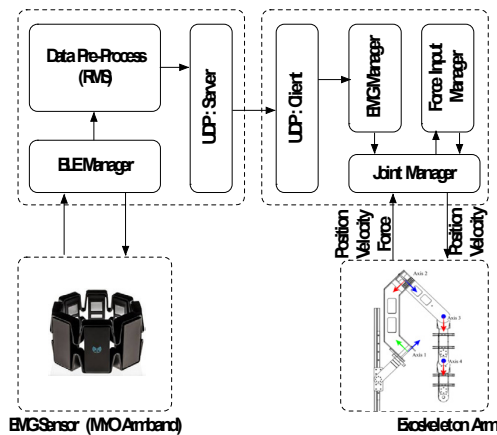

Figure 6 Software Components

In Figure 6, the joint manager is used to control the elbow joint motion of the exoskeleton arm. It will receive a physical force data, current position, and velocity from the exoskeleton arm. The force input manager calculates the static gravity force compensation and sends that data to the joint manager for compensating the physical force input. The EMG data are sent from the MYO armband to the bio-signal manager via BLE module. Data from MYO armband were filtered by bio-signal manager with the median pass filter. After that, the EMG signal will be sent to the joint manager through UDP protocol for limiting the force input. The joint manager will receive all data for calculating the desired position and velocity command and send them to the exoskeleton arm.

5. Force Input Manager

Force input manager is used to calculate the static gravity force compensation. This compensation value will be sent to the joint manager for compensating the physical force input. In general, the physical parameters of the system are used to calculate the gravity force compensation. However, the exact physical

parameters of this system are hard to be modelled because the friction force in bowden cable which is applied to transmit the power of this exoskeleton is nonlinearity. As mentioned above, the proposed gravity compensation focuses on the compensation without physical parameters of the exoskeleton arm. To solve this problem, the generalized regression neural network is applied to predict the gravity compensation value of given joint position because the training time of the GRNN is short ant it can take care a large input-output mapping.

6. EMG-Signal Manager

The EMG-signal manager is used to receive an array of biological signals from the MYO armband manager via the UDP protocol. The biological signals of 8 EMG electrodes on MYO armband are converted to the root mean square values by Equation 1. The electrode number 1-4 obtain signals from the biceps muscle activity and the electrode number 5-8 receive signals from the triceps muscle activity.

$$RMS = \sqrt{\frac{1}{n} \sum_{n} x^2(t)} \quad (1)$$

The RMS EMG data is used to detect an activation of the biceps and triceps muscle. During elbow flexion movement, the biceps muscle is contracted and the triceps muscle is relaxed then the biceps RMS EMG value is greater than the triceps RMS EMG values. On the contrary, the triceps RMS EMG values are greater than the biceps RMS EMG value during elbow extension. Therefore, the biceps and triceps RMS EMG values appear simultaneously during the user arm contraction.

7. Joint Manager

This joint manager is programmed to receive raw force data, force compensation, joint angle, and EMG data for controlling the joint motion of the exoskeleton robot as shown in Fig. 7.

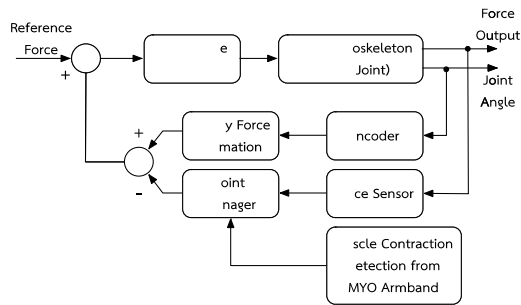

Figure 7 Control Loop of the Exoskeleton Arm

The admittance control is applied to calculate the joint motion. To describe the admittance control for this system, the Equation 2 is used to calculate the desired robot velocity, where k_a is an admittance gain, F is a force exerted on each joint, and F_c is a gravity compensated value.

$$\dot{x}_d = k_a(F - F_c) \quad (2)$$

The force output can be calculated with Equation 3[15], where k_p, k_d are the proportional and derivative gains. x_d and \dot{x}_d are the desired robot position and velocity. x and \dot{x} are current joint position and velocity of exoskeleton joint.

$$\tau_j = k_p(x_d - x) + k_d(\dot{x}_d - \dot{x}) \quad (3)$$

The joint manager receives biceps and triceps EMG signals for improving the transient response in case of arm contraction. If EMG signals of biceps and triceps muscles activity appear at the same time and greater than a threshold, the joint manager will improve transient response by setting the force input to zero.

8. Results and Discussions

8.1 Gravity Estimation

An experiment is conducted to investigate the gravity force estimation with the GRNN method. The GRNN method requires training data of joint angle-force mappings. To record the training data, the exoskeleton joint is set to rotate from 0-90 degrees. Then, the force data is recorded as the output and the exoskeleton joint angle as the input. The GRNN method is utilized to predict the gravity force output. The relationship between gravity force and exoskeleton joint angle can be plotted as in Figure 8

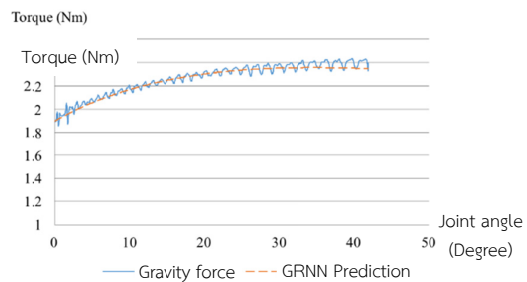

Figure 8 Force Data Reading from Exoskeleton and GRNN's Prediction

In Figure 8, the horizontal axis represents the joint angle and the vertical axis represents force data. The force value of exoskeleton arm is plotted as a solid line and gravity force estimation value of the GRNN method is plotted as a dash line. The GRNN method can predict the gravity force with accuracy of 97.32% as shown in Figure 8. However, the GRNN method can predict only static force.

8.2 EMG Signal Preprocessing

The EMG signal is used to detect the muscle activity for improving the system's transient response. The first experiment is set to explore the relationship between EMG signal data and upper limb movement. The MYO armband is used to sense the upper limb

muscle activity. The root mean square (RMS) method is used to convert the EMG signal to magnitude of muscle contraction as shown in Figure 9.

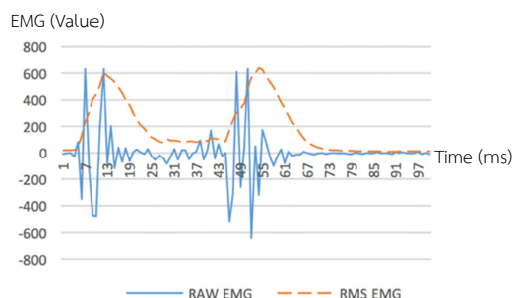

Figure 9 Raw vs. RMS EMG Signals during Muscle Contraction

In Figure 9, the horizontal axis represents time and the vertical axis represents EMG signal amplitude. The results show the raw and RMS values of the EMG signals. The RMS value can be converted from the raw EMG signal with Equation 1. It is used to detect muscle activity for controlling the input force.

Another experiment is set to detect muscle contraction. First, user wears the MYO armband on the upper limb arm and moves the elbow then stops rapidly. It causes the biceps and triceps muscle to be active at the same time. The EMG signals of biceps and triceps muscle are shown in Figure 10.

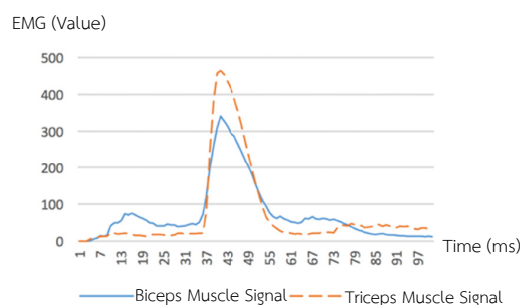

Figure 10 Muscle Contraction Detection using EMG Signal

In Figure 10, the horizontal axis represents time and the vertical axis represents EMG signal amplitude. The results show that the EMG signals of biceps and triceps muscles appear at the same time during arm contraction. The force input will be set to zero for improving the transient response when the EMG signals of biceps and triceps muscles occur simultaneously.

8.3 Admittance Control Evaluation

The admittance control is the method to control the exoskeleton's movement according to the external force. Therefore, the experiment presents the comparison between torque which occur at exoskeleton joint and joint motion response when the external force is applied to the robot. The result in Figure 11 indicates that the admittance control method has an ability to response to the external force within 132 ms. So, this exoskeleton can response to the external force in real time.

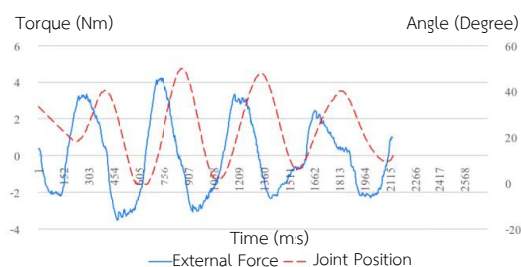

Figure 11 Joint Transient Response by Admittance Controller

8.4 Hybrid Control Evaluation

To evaluate the performance of proposed hybrid control, two experiments are set to check the joint transient response of the force controller with/without EMG signal. In each experiment, the user moves exoskeleton joint quickly then suddenly stops. Next, the joint response will be recorded and shown in Figure 12 and 13.

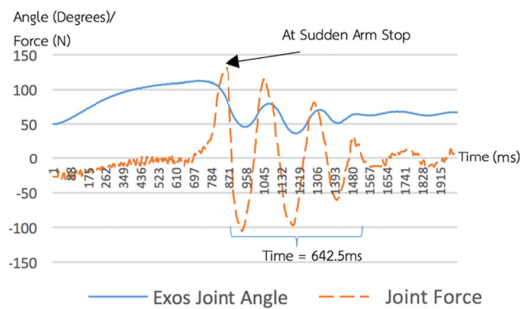

Figure 12 Joint Transient Response by Force Controller

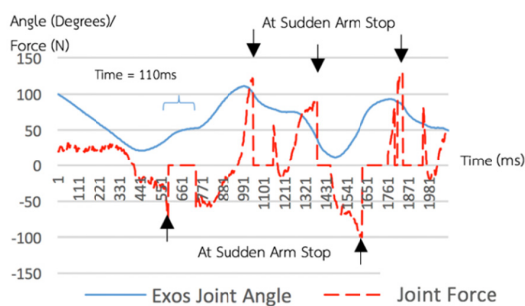

Figure 13 Joint Transient Response by Hybrid Controller

In Fig. 12 and 13, they show joint transient responses during arm contraction where the horizontal axis represents time and the vertical axis represents exoskeleton joint angle and force. The settling time for the force controller is about 642.5 milliseconds as shown in Figure 12. The settling time for the system with the hybrid controller is about 110 milliseconds as shown in Figure 13. The experimental results showed that the settling time was improved up to 83.13%.

9. Summary and Conclusions

This paper proposed the structure design and hybrid control system which utilized data from the force and EMG sensors. The rehabilitation robot structure is designed to have 4 degrees of freedom. A 6061-O aluminum sheet with thickness of 5 mm. was used for the exoskeleton links

because this material is lightweight and rigid. The force sensor mount is made of ABS plastic material for reducing the electrical noise from the AC servo motor. The GRNN is utilized for predicting the static gravity compensation which maps between the input joint angle and the output force at the elbow joint. The admittance controller is used to control motion of the exoskeleton joint. However, the transient response of the admittance control could lead in a large overshoot when the user moves exoskeleton joint quickly then suddenly stops. Hence, the EMG signal of the biceps and triceps were used to detect the muscles contraction. When the muscles contraction occurred, the force input will be set to zero for improving transient response of the hybrid controller. The GRNN can predict the static gravity force with accuracy of 97.32%. The settling time of the hybrid controller could be improved up to 83.13%. From previous experimental results, this hybrid control system could be applied to the rehabilitation robot with unknown dynamic parameters. In the future work, the proposed technique would be applied to all joints of this exoskeleton. Also, the virtual reality system would be implemented for the upper limb rehabilitation using this robotic exoskeleton. “The authors declare that there is no conflict of interest regarding the publication of this article.”

10. References

- [1] Garin, O., Ayuso-Mateos, J.L., Almansa, J., Nieto, M., Chatterji, S., Vilagut, G., Burger, H. (2010). “Validation of the World Health Organization Disability Assessment Schedule (WHO-DAS II) in Greek and its added value to the Short Form 36 (SF-36) in a sample of people with or without disabilities.” *Disability and Health Journal*. Vol. 9 No. 3 : 518-523.

- [2] Gordon, N.F., Gulanick, M., Costa, F., Fletcher, G., Franklin, B.A., Roth, E.J., and Shephard, T. (2004). "Physical Activity and Exercise Recommendations for Stroke Survivors." A Statement for Healthcare Professionals From the American Heart Association/American Stroke Association. 2532-2553.
- [3] Carignan, C., Tang, J., Roderick, S., and Naylor, M. (2007). "A Configuration-Space Approach to Controlling a Rehabilitation Arm Exoskeleton." 2007 IEEE International Conference on Rehabilitation Robotics. (179-187).
- [4] Hogan, N. (1980). "Mechanical impedance control in assistive devices and manipulators." Proceedings of the 1980 Joint Automatic Control Conference. (TA10-B).
- [5] Hogan, N. (1985). "Impedance Control: An Approach to Manipulation: Part I-Theory." Journal of Dynamic Systems, Measurement, and Control. Vol. 107 : 1-7.
- [6] Hogan, N. (1985). "Impedance control: An approach to manipulation: Part II-Implementation." Journal of Dynamic Systems, Measurement, and Control. Vol.107 : 8-16.
- [7] Hogan, N. (1985). "Impedance Control: An Approach to Manipulation: Part III-Applications." Journal of Dynamic Systems, Measurement, and Control. Vol.107 : 17-24.
- [8] Krebs, H. I., Volpe, B. T., Williams, D., Celestino, J., Charles, S. K., Lynch, D., & Hogan, N. (2007). "Robot-aided neurorehabilitation: a robot for wrist rehabilitation." IEEE Transactions on Neural Systems and Rehabilitation Engineering. (327-335).
- [9] Pons, J. L., Rocon, E., Ruiz, A. F., & Moreno, J. C. (2007). Upper-limb robotic rehabilitation exoskeleton: Tremor suppression. INTECH Open Access Publisher. (453-470).
- [10] Hogan, N., Krebs, H. I., Charnnarong, J., Srikrishna, P., and Sharon, A. (1992). "MIT-MANUS: a workstation for manual therapy and training. I." IEEE International Workshop on Robot and Human Communication. (161-165).
- [11] Krebs, H. I., Ferraro, M., Buerger, S. P., Newbery, M. J., Makiyama, A., Sandmann, M., & Hogan, N. (2004). "Rehabilitation robotics: pilot trial of a spatial extension for MIT-Manus." Journal of Neuro Engineering and Rehabilitation. Vol.1 No.5 : 1-15.
- [12] Carignan, C., & Liszka, M. (2005). "Design of an arm exoskeleton with scapula motion for shoulder rehabilitation." IEEE International Conference on Advanced Robotics. (524-531).
- [13] Yu, W., Rosen, J., and Li, X. (2011). "PID admittance control for an upper limb exoskeleton." In Proceedings of the American Control Conference. (1124-1129).
- [14] Yang, X., Lihua, G., Yang, Z., and Gu, W. (2008). "Lower extreme carrying exoskeleton robot adaptive control using wavelet neural networks." In Natural Computation IEEE International Conference. (399-403).
- [15] Rosen, J., Fuchs, M.B., and Arcan, M. (1999). "Performances of Hill-type and neural network muscle models—toward a myosignal-based exoskeleton." Computers and Biomedical Research 32. (415-439).
- [16] Charoenseang, S. and Panjan, S. (2015). "Universal Exoskeleton Arm Design for Rehabilitation." Journal of Automation and Control Engineering. Vol.3 : 492-497.