

chemorepulsion in the developing nervous system.

~~Diffusible axon outgrowth inhibiting activities in the developing rat
central nervous system~~

A Thesis submitted to the university of London
for the degree of Doctor of Philosophy.

By Nina Uche Orike
BSc, MSc

University College London
1995

ProQuest Number: 10046108

All rights reserved

INFORMATION TO ALL USERS

The quality of this reproduction is dependent upon the quality of the copy submitted.

In the unlikely event that the author did not send a complete manuscript and there are missing pages, these will be noted. Also, if material had to be removed, a note will indicate the deletion.



ProQuest 10046108

Published by ProQuest LLC(2016). Copyright of the Dissertation is held by the Author.

All rights reserved.

This work is protected against unauthorized copying under Title 17, United States Code.
Microform Edition © ProQuest LLC.

ProQuest LLC
789 East Eisenhower Parkway
P.O. Box 1346
Ann Arbor, MI 48106-1346

ABSTRACT

This work has been directed at demonstrating the existence of diffusible growth-suppressing signals which may operate during the development of the nervous system. By co-culturing explants of different brain areas I have produced evidence for the existence of at least three distinct growth-suppressing signals. Such signals could act by specifically preventing axons from innervating inappropriate territory in the central nervous system.

Evidence for the creation of territorial exclusion zones by diffusible factors is novel and in conjunction with other well described mechanisms could make important contributions to understanding axon guidance and patterning within the central nervous system. Identification of diffusible inhibitors of axon growth is not only important to the basic understanding of how neural networks become organised, but may well be critical to the problem of regeneration in the adult nervous system. I have therefore carried out research on the biochemical elucidation of the inhibitory activities. I have shown that some of these are secreted differentially according to brain area, are likely to have very short half lives and have a molecular weight range between 15 and 25KDa. If endogenous inhibitors of axon growth can be identified then there are strong possibilities for generating soluble antagonists which might eventually be of clinical relevance to pathological, degenerative and traumatic conditions of the nervous system.

TABLE OF CONTENTS

	Pages
List of tables	7
List of figures	8
Acknowledgements	10
<u>Chapter one : Introduction</u>	
1.1 Historical prespective	11
1.2 Axon guidance mediated by non-diffusible molecules	19
1.21 Contact adhesion mediated by cell adhesion molecules	19
Neural cell adhesion molecuem (NCAM)	19
L1	20
The cadherins	21
The selectins	21
The integrins	22
1.22 Contact adhesion mediated by substrate adhesion molecules	22
Laminin	23
Fibronectin	23
1.23 Contact mediated repulsion	25
The retinotectal pathway	25
Spinal nerve segementation	26
Matrix molecules	27
Myelin proteins (NI-35 and NI-250)	27
Myelin associated glycoprotein	28
1.3 Axon guidance mediated by diffusible molecules	29
1.31 Chemoattraction	29
Developing trigeminal axons	31
Spinal commissural axons	32
Cortical projection axons	32
Corticothalamic and corticocortical projections	33

1.32 Chemorepulsion	34
The lateral olfactory tract	34
Primary sensory afferents	35
Trochlear motor axons	35
Hind brain and spinal developing motor axons	36
1.4 Candidate diffusible guidance molecules	37
1.41 Collapsin	37
1.42 Semaphorins	38
1.43 Netrins	40
1.5 Growth cone motility and guidance cues	41
1.51 Growth cone structure and cytoskeletal arrangement	41
1.52 Signal transduction	43
1.53 How cell adhesion molecules translate their positive growth signals	45
1.54 How inhibitory molecules translate their negative growth signals	46
1.55 How are growth cones able to detect gradients of diffusible molecules	47
1.6 Objectives	4 8

Chapter two : Materials and methods

2.1 Materials	49
2.2 Methods	52
2.21 Embryo dissection	52
2.22 Collagen gel preparation	52
2.3 Bioassay procedure	53

Chapter three : Isochronic co-culture experiments

3.1 Introduction	55
3.2 Protocol	56
3.3 Results	59
3.4 Discussion	65

Chapter four : Conditioned media experiments

4.1 Introduction	69
4.2 Protocol	71
4.3 Results	74
4.4 Discussion	77
4.5 Protocol	78
4.6 Results	81
4.7 Discussion	86

Chapter five : Developmental regulation of inhibitory activity

5.1 Introduction	90
5.2 Protocol for heterochronic co-cultures	91
5.3 Results of heterochronic co-cultures	92
5.4 Discussion	95

Chapter six : Biochemical studies

6.0 Introduction	99
------------------	----

Part 1 : Estimation of molecular weight range of inhibitory activity in superior colliculus-conditioned media

6.11 Protocol	102
6.12 Results	104
6.13 Discussion	109

Part 2 : Separation of proteins in conditioned media by SDS gel electrophoresis

6.21 Protocol	111
6.22 Results	114
6.23 Discussion	115

Chapter seven : Final discussion

7.1 Background	117
7.2 Identification of distinct inhibitory activities	118
7.3 Conditioned media - a starting point for preliminary biochemical studies	120
7.4 Molecular weight estimation of inhibitory activity in conditioned medium	121
7.5 What is the chemical nature of the inhibitory activity in conditioned media ?	122
7.6 The inhibitory activity in superior colliculus-conditioned medium is novel	123
7.7 How does inhibitory activity bring about inhibition of neurite extension ?	124
7.8 What is the function of chemorepulsion in the developing nervous system ?	125
References	127

LIST OF TABLES

- TABLE 1 :** Combinations of E15 tissues co-cultured.
- TABLE 2 :** Mean numbers of neurites emerging from control and test explants co-cultured with different E15 explants.
- TABLE 3 :** Mean numbers of neurites extending within three defined bands from control explants and test explants cultured in cortex-conditioned media.
- TABLE 4 :** Mean numbers of neurites extending within three defined bands from control explants and test explant cultured in superior colliculus-conditioned media.
- TABLE 5 :** Mean numbers of neurites extending within three defined bands from control and test explants cultured in continuously conditioned media.
- TABLE 6 :** Combinations of E15 and E18 tissues co-cultured.
- TABLE 7 :** Mean numbers of neurites emerging from control and test explants co-cultured with different E18 explants.
- TABLE 8 :** Mean numbers of neurites extending within three bands from control and test explants cultured in superior colliculus-conditioned media, with different dialysis membrane cut-offs.

LIST OF FIGURES

- Figure 1.1** : Schematic representation of the experimental arrangement within collagen gels.
- Figure 1.2** : Schematic representation of neurites counted that emerged from each explant.
- Figure 1.3** : Dark field pictures showing a retinal explant co-cultured separately with two different flanking tissues, septum and superior colliculus.
- Figure 1.4** : Phase contrast and dark field pictures showing the effect of the same flanking explant (superior colliculus) on two different tissues (retina and bulb).
- Figure 1.5** : Phase contrast pictures showing a septal explant co-cultured separately with two different tissues (cortex and superior colliculus).
- Figure 1.6** : A simple flow diagram showing the relevant tissue interactions
- Figure 2.1** : Schematic representation of steps involved in the experimental procedure.
- Figure 2.2** : Schematic representation of an explant and its neurites showing the way in which neurite lengths were estimated.
- Figure 2.3** : Phase contrast pictures of an olfactory bulb explants cultured in superior colliculus-conditioned medium and in cortex-conditioned medium.
- Figure 2.4** : Schematic representation of steps involved in the experimental procedure.
- Figure 2.5** : Dark field pictures of a retinal explant cultured in septum-conditioned medium and in superior colliculus conditioned medium.
- Figure 2.6** : Phase contrast pictures of olfactory bulb explants cultured in septum-conditioned and in superior colliculus-conditioned media.
- Figures 2.7a and b** : Flow diagrams summarising the relevant tissue interactions in the conditioned media and the co-culture experiments.
- Figure 3.1** : Dark field pictures of a retinal explant co-cultured with E15 and with E18 superior colliculus.
- Figure 3.2 a and b** : Flow diagrams summarising the relevant tissue interactions for isochronic co-culture and heterochronic co-culture experiments.

Figure 4.1 : Diagram of the test chamber.

Figure 4.2 : Phase contrast pictures of an olfactory bulb explant cultured in superior colliculus-conditioned medium in a test chamber separated by two different molecular weight dialysis membranes.

Figure 4.3 : Photographs of polyacrylamide gels.

ACKNOWLEDGEMENTS

I would like to express my sincerest gratitude to my supervisor and friend Adrian Pini for his guidance, support and constant encouragement throughout the course of this project. I would also like to thank Julia Nash for her invaluable advice and emotional support. I am indebted to Anne McLaren for her constant encouragement, interest in my work and general well being. I thank Andrew Lumsden, Richard Wingate for their helpful and insightful comments and Bruce Cotsell for the construction of the “Gizzmo”. Last but not least, I would like to thank my family and friends, particularly my brother, Donald, my mother, and best friend Bunmi who have endeavoured to maintain my sanity during these trying times.

CHAPTER ONE

INTRODUCTION

1.1 HISTORICAL PERSPECTIVE

The nervous system consists of a complex network of neurones which are interconnected in a highly specific manner. Its development follows a specific sequence of events which begins with the proliferation of precursor cells to generate presumptive glial and nerve cells. This is then followed by a period of migration of these daughter cells to their final locations. During migration, differentiation takes place in which the nerve cells begin to extend their interconnecting axons and dendrites. When these processes make contact with one another or their targets, synaptogenesis may occur. About this time inappropriate and excess synaptic connections are eliminated. Clearly, the functioning of the nervous system will depend critically on the specificity of these connections generated during development. Therefore a fundamental problem in neurobiology is to understand how this specificity is established; i.e. what are the cues which guide migrating nerve cells to their specific positions within the nervous system, what is the nature of the signals which govern polarity and direction of outgrowth, and what are the mechanisms by which these cells actually recognise one another.

The first suggestion that neurones connect by extending axons, came from observations made by Ramon y Cajal in 1890. He observed the presence of “ameboid” thickenings, (growth cones) at the tips of axons, and correctly suggested that since they appeared to move in an ordered and directed manner, they were involved in axon pathfinding. In developing his ideas, Cajal had been impressed by the then recent observations that leukocytes could orient their movement according to gradients of diffusible factors and proposed that growth cones also responded to gradients of chemicals released by their target tissues (Cajal 1920).

The dynamic quality of growth cones and evidence supporting Cajal’s initial observations came with Harrison’s (1907) observations of living axons in tissue culture for the first time. He proposed that the growth of axons occurred by the extension of the growth cone. Harrison also suggested that the specificity of axonal growth could be due to the presence of pioneer nerve fibres (1910), which would

advance to form connections with target organs and then serve as a guide for later developing axons. He predicted that the energy needed for this initial outgrowth would come from within the cell and that the direction of the outgrowth was also determined by factors within the cell. This suggestion, although plausible, was not received enthusiastically because it did not account for the way in which the pioneer neurones were able to form the initial appropriate patterns of interconnections. Subsequently, the full recognition of the part played by pioneer nerves in axon pathfinding only became evident with their later description in the peripheral (Bate 1976) and central nervous system (Bate and Grunewald 1981). Nonetheless, Harrison's contribution to the field was valuable notably because his recognition that axon outgrowth required a semi-solid medium and could occur along grooves or small channels of the substratum laid down one of the earliest fundamental ideas of contact guidance. Since then, evidence suggesting the importance of the physical structure of the substratum has grown. Singer and his co-workers (1979) detected continuous extracellular spaces (channels) between ependymal cells in the spinal cord of embryonic newts and deduced that such channels provided cues for growing axons. Extracellular channels have also been suggested to act as 'guide posts' for embryonic chick (Krayanek and Goldberg 1981) and mouse (Silver and Sidman 1980) retinal ganglion cells. However, at present there is little evidence supporting the existence of such channels in other areas of the nervous system. There is however, evidence to suggest that growth cones may actively generate these spaces by releasing specific metallo-proteases which modify their immediate environment (Pittman 1985).

Up until the 1930's the idea that specificity of neuronal connections was attributable to specifically directed axonal outgrowth was still not widely accepted. The concept of biochemical specificity only fully developed in the second half of the century with the rise of cell biology and physiological chemistry.

The prevailing view in the 1930's championed by Paul Weiss was that initial outgrowth of axons occurred randomly, in an undirected manner. Weiss' resonance hypothesis (1936) stated that specificity arose through target responsiveness to only those axons carrying the appropriate pattern of electrical activity. This hypothesis was derived from his earlier observation of what he termed the homologous response (1923), following

investigations of the development of neuromuscular specificity in relation to the control of limb movements. In a series of transplant experiments using salamander larvae, a limb bud from a donor embryo was grafted caudally onto a normal limb bud. Several weeks later, reinnervation of the grafted limb occurred and it developed movements that were co-ordinated with that of the host limb, (the homologous response). Weiss concluded that the appropriate (homologous) patterns of limb movement resulted from inherent properties which enabled the correct muscles to receive or, 'resonate' with only those motor nerves which carried the normal patterns of activity for movement. He extended his theory of neuromuscular specificity to account for the general formation of nerve patterns during development. He suggested that axons initially projected indiscriminately and those which failed to make appropriate functional connections were eliminated. Weiss carried out further experiments in tissue culture which led him to suggest yet another mechanism for neuronal specificity, the contact guidance hypothesis (Weiss 1941, 1944). He based this theory on his observations of axons in relation to mechanical features in their environment. He observed that axons grew on lines of tension in plasma clots and scratches on the surface of culture dishes and concluded from this that axons did not require chemical cues. He suggested that guidance simply resulted as a result of the interplay between the motive power of the cell and contractions provided by adhesive contacts between the cell and the substratum. The demise of both the resonance and contact hypotheses was largely attributable to the work of Roger Sperry between the 1940's and '50s. Sperry was Weiss' student and his work at the time involved the study of the regenerative capacity of axons of the retinotectal projection. In these experiments he cut the optic nerve of newts, rotated the eye through 180°, and waited for regeneration to occur. After optic nerve regeneration, the animals with rotated eyes behaved as if their visual field was inverted and shifted to the left, implying that retinal ganglion cell axons had grown back to their correct targets, even though the connections were behaviourally inappropriate (Sperry 1944). This, and other similar experiments (Attardi and Sperry 1963) in the goldfish visual system provided evidence for a high degree of specificity in the formation of synaptic connections, and culminated in the chemoaffinity hypothesis (Sperry 1963). This proposed that the specificity of synaptic connections depended on

interactions of complimentary chemical affinities present on neurones and their targets. The establishment of appropriate connections would therefore depend on the correct and exclusive matching of molecules on pre and post synaptic sites. In this hypothesis, each neurone would carry some kind of individual identification tag, and therefore presupposed the existence of multiple distinct ligands and their receptors. Another assumption of the hypothesis was that once neuronal connections were established, they would remain rigid and inflexible. This was soon disproved by experiments which showed that retinal axons readjusted their contact sites in order that they could all be accommodated by one half of the tectum if the other half had been surgically removed (Gaze and Sharma 1970, Yoon 1971). Further evidence disproving a rigid matching proposal also came from experiments in the visual system demonstrating the flexibility of axonal projections during normal development. During development the initial set of retinal axons form a succession of temporary 'incorrect' connections, which are later refined (Chung et al. 1974, Gaze et al. 1974). The driving force for these refinements was proposed to be controlled by electrical activity within the neural pathways themselves (Fawcett and O'Leary 1985). The molecular complexity inherent in the chemoaffinity hypothesis, together with the growing evidence for the role of electrical activity in neuronal patterning (Marsh and Beams 1946, Cohan and Kater 1986), tempered enthusiasm for it. Consequently some details of Sperry's hypothesis have been revised, however the general concept of chemoaffinity is essentially correct, and his work remains critical in the field of neural development.

Research in the following decade focused on the more specific mechanisms by which growth cones were guided to their targets.

An early lead to answering these questions came from two major studies during the late 1940's and early '50's on the behaviour of cells in tissue culture. The first, carried out by Abercrombie and Heaysman (1953), was a systematic attempt to examine the social (and antisocial) behaviour of cells. Abercrombie's observations of monolayering by fibroblasts and heart myocytes in culture, led him to suggest that the surfaces of cells were capable of mediating mutual inhibition of cell division on contact. The term contact inhibition has been applied to describe the cessation of axonal extension within

the nervous system. However, in the Abercrombie and Heaysman experiments, the observed contact inhibition referred to the failure of cells to continue dividing once they had fully occupied a given space. Nerve cells do not divide; on contact with a non-permissive substratum, their growth cones collapse or deform and the axon retracts. Contact-repulsion may therefore be a more accurate description of this behaviour of nerve cells. Hughes (1953) was the first to observe this phenomenon; he observed that growth cones retracted when they contacted each other or neurites, the significance of which with respect to axon guidance only became clear much later.

Following on from Abercrombie's work, Carter (1965), also investigating cell motility, took matters a step further and examined the behaviour of cells on various surfaces. He made substrata of varying adhesiveness by vacuum-evaporating an inert metal on to a glass slide coated with cellulose acetate, and compared cell motility on these surfaces. He observed that cell movement occurred predominantly up the gradients of adhesiveness and termed this phenomenon haptotaxis i.e. the directed response of cells to a gradient of adhesiveness. He proposed that all cell movement, including cell migration involved in morphogenesis could be accounted for by this mechanism. However, it was not until the advent of time-lapse cinemicrography, when cells were observed to accumulate on portions of patterned substratum to which they adhered most strongly, that Carter's proposal was reinforced (Harris 1973) .

The significance of the physical substratum in neuronal morphogenesis was further inferred by studies carried out by Letourneau in the mid 1970's. By culturing sensory neurones on several different substrata, he was able to demonstrate a role for cell-to-substratum adhesion in the initiation, elongation and branching of axons. In his first series of experiments, he investigated the adhesive qualities of different surfaces and the strength with which growth cones attached to them. He observed that growth cones adhered most strongly to and extended axons at greater rates, on polyornithine coated surfaces compared with tissue culture plastic (Letourneau 1975a). He suggested that since there appeared to be a strong correlation between adhesion and enhanced axonal growth, the degree of adhesive interaction between the growth cone and its microenvironment must be important for the formation and guidance of neuronal processes. The most preferred substrates were polyornithine and polylysine both of

which are highly positively charged polymers; thus adhesion was probably due to an electrostatic interaction between the positively charged substrate and the negatively charged site on the external surfaces of the growth cones. In a second series of experiments, Letourneau (1975b) further demonstrated the relationship between adhesion and cell movement by showing that neurites would actively select the path of greatest adhesiveness when presented with a choice. By the time Letourneau had carried out these studies, growth cones had already been shown to possess microspikes which contacted the substratum ahead of the main body of the growth cone and which advanced by addition of intracellular vesicles at their tips (Bray 1973a). Letourneau therefore suggested that adhesion could contribute to axonal extension by promoting the addition of vesicles to microspikes. This he proposed would lead to expansion of the microspike and in turn advancement of the growth cone in a specific direction. Thus the most firmly attached filopodium would be the one most successful at steering the growth cone. Letourneau's contribution was to show that growth cones, like motile cells, could selectively adhere to and advance on specific substrates thus suggesting that axon guidance resulted from differential adhesion.

Functional evidence implicating cell substrate interactions in the development of the central nervous system (CNS), came from a description of haptotaxis (of the kind first described by Carter) in the CNS of the developing wing of the pupal moth (Nardi and Kafatos 1976a,b). These researchers observed that while sensory neurones from the tips of the wings grew towards the CNS, they were closely associated with the extracellular matrix of the upper epithelial layer. When this substratum was altered by exchanging epithelial grafts, growth cones were able to grow cross both control and distally positioned grafts, but not those displaced proximally. Supporting evidence for interactions with substrate came from scanning electron microscopy of the substratum of different proximo-distal positions which revealed a graded distribution of extracellular matrix components (Nardi 1983). Berlot and Goodman (1984) have also described a gradient of adhesion in the development of grasshopper sensory neurones originating in the antennae and limb buds. By using transmission microscopy and tissue culture manipulations, they showed that growth cones of pioneer neurones in the antennae and limb buds of grasshopper embryos preferred the surfaces of neurones

over the surfaces of epithelial cells, suggesting that these axons were guided by an adhesive hierarchy.

Directional adhesive cues need not always be presented in the form of a gradient. A growth cone encountering an environment which contains components of varying adhesiveness, could also be guided to its target by recognising specific adhesive molecules distributed at a uniform level along a preformed pathway (see diagram 1). The differential adhesion hypothesis is consistent with Steinberg's (1978) proposal of morphogenic control of embryonic tissue. Steinberg's observation that dispersed populations of embryonic cells could coalesce to form tissue, led him to propose that cells were capable of selecting one another on the basis of the differential adhesive properties on the cell surface. For instance, when presented with the choice of both dorsal and ventral half of the tectum, dissociated retinal ganglion cells from the ventral half of the retina adhere preferentially to the dorsal half of the tectum (Roth and Marchase 1976). Such studies, which followed from Holtfreter's classical cell sorting studies of the 1930s and 1940s, suggest that differential cell surface affinities play an important part in mediating the organisation of tissues.

1. Diagram illustrating two mechanisms of adhesion

Adhesive gradient

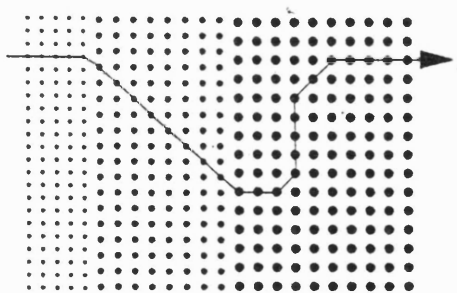

1 Axon advances up gradient of a single component.

Differential adhesion

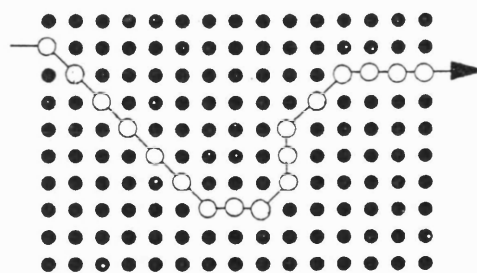

2 Axon finds specific cue (O) with which it adheres best within a mixture and follows the pattern described by that cue.

The function of adhesive gradients could be to act more globally, orienting and directing axons to appropriate intermediate targets within the embryo, whereas the role of adhesive cues which align defined tracks (Katz and Lasek 1979, Silver and Rutishauser 1984) may be to direct axons more precisely to their final targets.

Having indicated that adhesive interactions were important for the growth of axons, researchers began to speculate on the mechanisms by which adhesive interactions could affect the contractile apparatus of the growth cone in order to regulate growth cone motility.

Bray suggested that adhesion and tension were linked such that the direction of advance of a growth cone was determined by the tension existing between it and the rest of the cell. He based this proposal on calculations of the resultant force on a growth cone from a vectorial analysis of individual sensory neurones. He deduced that the filopodia of growth cones evoked a mechanical tension in the growth cones as they pulled against the substratum (Bray 1979). His later demonstration that mechanical tension directly applied to a growth cone, by pulling it with a micro-pipette, could initiate elongation of the growth cone in the direction of the force applied, led him to propose a more definitive role for mechanical tension in neurite outgrowth (Bray 1984). In his scheme, a growth cone could determine the levels of adhesion by monitoring the levels of tension that resulted as it pulled against the substratum. This tension itself could then directly trigger the contractile elements in the growth cone. If adhesion is weak, forces exerted on the cytoskeletal elements of the filopodia will be weak and break off, resulting in retraction of the filopodia. If however adhesion is strong, then tension will result between the growth cone and the rest of the cell, activating stretch sensitive systems, which in turn would draw the growth cone forward into the more adhesive environment.

In summary, over the past century, theories of axon guidance have developed from those which involved random diffuse outgrowth (Weiss 1936), to those in which specific chemical signalling is key (Sperry 1963). In parallel, some definitive ideas about the movement of growth cones emerged (Letourneau 1975, Bray 1979, 1984). Further advance was limited by lack of knowledge of the precise chemical guidance

cues involved. Since preferential adhesion was recognised as the major way in which axons were guided to their targets, subsequent research focused on identifying molecules that mediated adhesive interactions.

1.2 AXON GUIDANCE MEDIATED BY NON-DIFFUSIBLE MOLECULES

A large number of molecules which are permissive for and promote axon growth have been identified. They can broadly be divided into two groups; those that mediate adhesion between cells (cell adhesion molecules), and those that mediate adhesion between growth cones and the extracellular substratum (substrate adhesion molecules). I shall now briefly review the pertinent evidence defining their roles in axon guidance. Although each will be dealt with separately, it is likely that cells interact with different molecular species simultaneously *in vivo*.

1.21 Contact adhesion mediated by cell adhesion molecules

There are three major classes of cell adhesion molecules. Those which are calcium-independent, the immunoglobulin superfamily, those which are calcium-dependent, the cadherin and selectin families and the integrins.

In general cell adhesion molecules (CAMs) display a wide range of functional specificity. Edelman proposed that a relatively small number of adhesion molecules would be sufficient to account for even the most complex of morphogenetic events, provided they undergo certain changes in expression or chemical properties during development. He suggested that nature of these changes, collectively termed local cell surface modification, could involve changes in the number, distribution and chemical structure of the CAM's (Edelman 1983).

The Immunoglobulin superfamily

Neural cell adhesion molecule (NCAM)

There are around thirty isoforms of NCAM generated by alternative splicing of a single gene (Walsh and Doherty 1991), the major three being named after the tissues from which they were isolated. NCAM, neural cell adhesion molecule (Thiery et al. 1977), LCAM, liver cell adhesion molecule (Bertolotti et al. 1980), and Ng-CAM, neuron-

glia adhesion molecule (Grumet et al 1985 and Edelman 1984).

NCAM is the most prevalent and most extensively studied in vertebrate tissues. It is a cell surface glycoprotein which mediates homophilic binding with other NCAM molecules (Edelman 1983). It exists as three major glycoproteins, with molecular weights of 180, 140, and 120Ka. Each polypeptide form is made up of three domains, an N-terminal binding domain, a middle polysialic acid domain and a cytoplasmic domain. The different forms are identical except for the length of their carboxyl termini (Edelman 1986). During early development NCAM is expressed by neural epithelial cells soon after neural induction (Kintner and Melton 1987). However, it is not expressed during migration of neural crest cells and is re-expressed on sensory precursor cells (Thiery et al. 1982) suggesting that it is important in cell binding. Diversity in NCAM function is thought to arise as a result of modification of its structure as Edelman first suggested. This may be achieved in several ways. For instance the degree of sialylation of the middle domain modifies the adhesive properties of the molecule (Hoffman and Edelman 1983, Landmesser et al. 1990). The cytoplasmic domain of the molecule can also modify the adhesive properties of NCAMs. Neurones grow relatively poorly on monolayers of 3T3 fibroblast cells expressing isoforms of NCAM with enlarged cytoplasmic domains generated by alternative splicing of the cytoplasmic domain (Doherty et al. 1992). In addition to diversity in NCAM polypeptide structure, differential expression of these molecules could contribute to their functional diversity particularly in defining boundaries between groups of cells.

L1

Another molecule similar to NCAM that also belongs to the immunoglobulin super family is the calcium independent adhesion molecule, L1 which is expressed on postmitotic neurones (Rathjen and Schachner 1984). It appears to be specifically important in axon-axon binding because L1-blocking antibodies disrupt fasciculation (Chang et al. 1987 and Fischer et al.1987). Consistent with this, its expression is reduced after nerve tract formation, (i.e. after fasciculation has occurred), and increases after injury in peripheral nerves, when presumably it would be required for re-fasciculation (Daniloff et al. 1986).

The cadherins

The cadherins are a family of transmembrane glycoproteins which mediate calcium-dependent adhesion (Takeichi 1987). They all share highly conserved transmembrane, cytoplasmic and extracellular domains. There are at least a dozen subtypes known (Suzuki et al. 1991) each with a unique tissue distribution. Cells show dynamic expression of these molecules, some tissues express a single subtype while others express a few subtypes together (Takeichi 1987). Each subtype displays a different binding specificity and binding is homophilic (Takeichi et al. 1988). Tissue-specific expression of cadherin subtypes may explain the segregation of embryonic cell types first demonstrated by Steinberg (1970) and would be consistent with the observation that when cell layers are about to separate they express different sets of cadherins (Takeichi 1988). The differential expression of cadherins is thought to be associated with morphogenic events occurring in the embryo particularly in relation to cell sorting and forming and maintaining connections between cells (Hatta et al. 1987, Nagafuchi et al. 1987, Takeichi et al. 1989, 1990).

The selectins

The selectins are transmembrane proteins which are expressed on blood and endothelial cells and which are involved in mediating the inflammatory response. Three selectins L-, P- and E- have been identified (Bevilacqua et al. 1991) which are thought to mediate cell-cell adhesion by binding to specific carbohydrate groups on neutrophils via their lectin domains (Hynes and Lander 1992). Endothelial cells release P-selectin from intracellular stores onto the cell surface following initiation of the inflammatory response. Since P-selectin recognizes a specific carbohydrate group present on the surface of neutrophils, it binds to it bringing the neutrophils closer to the endothelial cells (Geng et al. 1990). Consistent with this role, is the finding that neutrophils preferentially bind to surfaces coated with purified P-selectin (Geng et al. 1990). L-selectin is also thought to be important in the selective adhesion of circulating lymphocytes to endothelial cells of lymphoid organs (Stoolman 1989). However, at present there is no evidence that selectins function in axon guidance.

The integrins

The integrins are receptors which mediate both cell-cell adhesion and cell-substratum adhesion and appear to have a much wider distribution than members of the calcium-dependent adhesion molecules (see later) (Krotoski 1986). They are heterodimers consisting of two single subunits, *alpha* and *beta*, both of which have several structurally related subunits and there are currently about twenty known functional pairs of these heterodimers (Hynes 1987). Integrins span the cell membrane, and have been proposed to act as transmembrane linkers between extracellular ligands and the cytoskeleton. Integrins bind their ligands by recognising specific amino acid sequences, particularly those that contain the tripeptide arg-gly-asp (RGD) sequence which is found on a number of extracellular matrix proteins (Ruoslahti and Pierschbacher 1987). The intracellular domain of the molecule, more specifically the *beta* subunit (Buck et al. 1986, Hayashi et al. 1990), interacts with the cytoskeleton through association with cytoskeletal components such as vinculin and talin (BurrIDGE et al. 1988). Evidence implicating integrins in promoting cell adhesion have mainly employed blocking antibodies, for instance the antibody JG22 which recognises the *beta* integrin subunit inhibits neural crest cell attachment and migration on laminin and fibronectin substrata *in vitro* (Bronner-Fraser 1985). *In vivo*, neural crest cell migration in avian embryos is disturbed after injection of the anti-integrin antibodies into the neural tube at the onset of neural migration (Bronner-Fraser 1986).

1.22 Contact adhesion mediated by substrate adhesion molecules

Neuronal migration and axon elongation occur through the extracellular matrix which consists of a lattice network of adhesive glycoproteins, collagens, proteoglycans and glycosaminoglycans. The finding that laminin was the active component in heart-conditioned media which promoted neurite-promoting ability (Lander et al. 1985), raised enthusiasm that extracellular matrix molecules could promote axon extension. Subsequently efforts were made to identify other extracellular matrix molecules capable of mediating adhesion.

Laminin

Laminin, the most abundant glycoprotein in the basement membrane, was first isolated from the Engelbreth-Holm-Swarm murine tumour (Timpl et al. 1979) and has been shown to be capable of influencing cell motility. *In vitro*, laminin is a potent promoter of neurite outgrowth (Hammerback et al. 1985, Liesi 1985, Gundersen 1987). *In vivo* it lines prospective pathways that axons follow to reach their targets (Cohen et al. 1986, Bronner-Fraser 1986, and Riggott and Moody 1987) and plays a prominent role in neural crest cell migration (Bronner-Fraser 1986, and Bronner-Fraser and Lallier 1988). The interactions of laminin are mediated by integrins (Bozyczko and Horwitz 1986, Tomaselli et al. 1986, Lallier and Bronner-Fraser 1991) which bind to its RGD sequence (Sasaki et al. 1988). Initially, laminin was thought to promote axon growth by simply facilitating the adhesion of growth cones to the substrata via integrins. However, Gundersen (1987) examined the specific involvement of adhesion in promoting neurite growth on extracellular substrates and found that regardless of how adhesive an alternative substratum was, laminin was always the preferred substrate for growth. This indicated that a further factor, not necessarily adhesion, was responsible for the neurite-promoting ability of laminin. Moreover recently, laminin has been found to have anti-adhesive effects (Calof and Lander 1991). Thus at present it is still unclear how laminin mediates its axon outgrowth promoting effects. Since it is less widely expressed than the CAMs, it may play a more restricted role in axon guidance.

Fibronectin

Fibronectin is a ubiquitous component of the extracellular matrix which has also been shown to promote the adhesion and migration of developing neurones. It is a large glycoprotein consisting of a dimer of similar subunits linked by disulfide bonds. There are three specific cell-binding regions: a central binding, an alternatively spliced IIIICS region, and a heparin-binding site (Hynes 1986). Most cells adhere to fibronectin by binding to the central domain because it contains the crucial RGD amino acid sequence important for ligand binding (Pierschbacher and Ruoslahti 1984). Fibronectins have also been shown to be involved in neural crest cell migration (Bronner-Fraser 1986) however, a specific role of them in neural crest cell migration is questionable because other studies have shown that crest cells do, in fact, migrate along collagen or laminin

substrata in the absence of fibronectin (Tucker and Erickson 1984).

Many extracellular matrix molecules are capable of stimulating neuronal outgrowth *in vitro*. They are all located in areas of the vertebrate embryo where they could potentially serve as permissive substrates or provide guidance cues for growing axons. However, there is little direct evidence to suggest a guidance role for extracellular matrix molecules *in vivo* or *in vitro*. McKenna and Raper (1989) were unable to show that surface gradients of laminin affected the direction of axon outgrowth, but similar experiments have not been performed with other extracellular cellular matrix components.

Recent characterisation of genes that affect growth cone guidance in *C.elegans*, has provided some persuasive evidence that extracellular matrix components may function in guidance. The migration of pioneer axons in between the epidermis and basal lamina in *C.elegans* is guided by three characterised genes; UNC 5, UNC 6, and UNC 40 (Hedgecock et al. 1990). UNC 6 encodes the laminin B2 chain, UNC 5 a transmembrane protein, which has been proposed to be a laminin B2 receptor and UNC 40 a protein which may also be another laminin B2 receptor. Both ventrally and dorsally directed circumferential migrations are disrupted in UNC-6 mutants (Culotti et al. 1994). The identification of such structurally related genes related to laminin which affect axon guidance specifically, has helped to provide some convincing evidence that extracellular matrix molecules may play a role in axon guidance *in vivo*. This contention is strengthened by identification of the candidate guidance molecule netrin-1, as a vertebrate homologue of UNC-6 (see later). In addition, homologues of various ECM components have been identified. For example, merosin is an A-chain homologue of laminin (Ehrig et al. 1990) and S-laminin a homologue of the laminin B-chain (Hunter et al. 1989). The existence of these homologues implies that extracellular matrix molecules have a much more heterogenous distribution than was once thought. In principle this, together with changes in the levels of their expression make them good candidates for axon guidance cues. The mechanisms by which extracellular matrix molecules exert their effects are still unclear but signalling mediated through integrin receptors is likely to be critical.

1.23 Contact mediated repulsion

During much of the 1980's, it was generally held that axons were guided to their targets by differential expression of adhesion molecules (reviewed above). Only in the late 1980's when it was demonstrated that growth cones could be repulsed on contact with non-target membranes (Walter et al. 1987, Kapfhammer and Raper 1987a,b) was the idea that guidance might occur through avoidance seriously considered. Kapfhammer and Raper examined a wide range of neurones and although these were not developmentally appropriate, in so far as these neurites did not make contact during development *in vivo*, the results were important because they indicated that guidance could arise as a result of contact repulsion. Crucially they provided a basis for the development of an assay of growth cone-collapsing activity, which has subsequently led to the isolation of inhibitory proteins (Davies et al. 1990, Luo et al. 1993).

The retinotectal pathway

In the rat retinotectal projection, anterior and posterior retinal axons project to posterior and anterior tectal areas respectively (Bonhoeffer and Huf 1982). Using an elegant *in vitro* assay system in which retinal axons were made to grow on substrata consisting of narrow adjacent alternating stripes of anterior and posterior tectal membrane components, Bonhoeffer and colleagues (Walter et al. 1987) showed that chick temporal but not nasal retinal axons avoided posterior membranes and grew exclusively on anterior membranes. However, both types of retinal axon grew equally well on membranes derived from either tectal region suggesting that inhibition was not absolute. Bonhoeffer interpreted this behaviour to mean that growth cones actually detected gradients of inhibitory molecules (at the stripe interfaces) and suggested that temporal retinal axons were excluded from the posterior tectum on this basis. A candidate inhibitory molecule was identified as an inositol-linked 33KDa glycoprotein present in posterior tectal membranes. When incorporated into phospholipid vesicles, the molecule caused collapse of temporal retinal axons (Stahl et al. 1990). To test the 'gradient reading' hypothesis, Baier and Bonhoeffer (1992) grew retinal axons on membrane carpets that contained a gradient of inhibitory tectal membrane components. Under these conditions, temporal growth cones failed to elongate extensively or actively turned to avoid increasing concentrations of posterior membrane components.

This strongly indicated that it is the gradient of the inhibitory protein which functions to direct temporal retinal axons away from the posterior tectum.

More recently a 25kDa glycoprotein, repulsive axon guidance signal (RAGS) has been identified and proposed to be a positional label in the retinotectal system (Drescher et al 1995). However, in the membrane stripe assay made up of alternating RAGS-COS cell membranes and mock-transfected cell membranes, both nasal and temporal axons avoided RAGS-containing membrane stripes. Thus while RAGS may have a role in guidance within the tectum, it does not appear to have the discriminatory properties required to determine position along the anterior to posterior axis. RAGS shares significant sequence homology with ligands for the receptor tyrosine kinase of the Eph subfamily which are the largest of the receptor tyrosine kinase family (Van de Geer et al. 1994). A recent study by Cheng et al. (1995) has implicated them in mediating contact-repulsion of axons involved in the formation of the retinotectal system. They showed that a specific class of these receptors, MeK 4 and its ligand ELF-1 are expressed in complementary gradients on retinal ganglion and tectal cells respectively thus ELF-1 expression is highest in the posterior tectum while correspondingly, MeK 4 expression is highest in the temporal retina. Although the distribution and properties of this receptor-ligand pair are consistent with a role in the formation of the retinotectal system, further functional studies will be needed before ELF-1 and other members of the Eph ligand family can conclusively be described as topographic guidance cues. If so, this would be the strongest evidence for the original proposal by Sperry of complimentary lock and key-type chemoaffinities.

Spinal nerve segmentation

The generation of the segmented pattern of spinal nerves in higher vertebrates in which sensory and motor nerves are confined to the anterior half of the somites results from axon repulsion by the posterior half of the somite (Keynes and Stern 1984). Using lectin-affinity chromatography, two peanut agglutinin-binding inhibitory cell surface glycoproteins (48 and 55 KDa) have been identified in posterior somite-halves. Detergent extracts of these proteins cause collapse of sensory growth cones which can be eliminated by polyclonal antisera raised against these molecules (Davies et al. 1990). Unlike the inhibitory proteins in the retinotectal projection, these glycoproteins are not

distributed as a gradient but are found exclusively in the posterior somite. In addition, sensory neurones are not able to grow on surfaces treated with membrane fractions from posterior somites indicating that inhibition is absolute. The mechanisms by which these molecules cause growth cones to collapse are at present unknown.

Matrix molecules

Several molecules present in the extracellular matrix inhibit neurite outgrowth. One such molecule is tenascin. It is a multimeric glycoprotein found in several organs and in the CNS and PNS (Spring et al. 1989). It contains several fibronectin and epidermal growth factor-like (EGF) repeats (Reichardt and Tomaselli 1991). Tenascin is of particular interest because it appears to have dual function. As a culture substrate, it mediates adhesion of neurones to astrocytes (Grumet et al. 1985), and promotes neurite outgrowth (Wehrle and Chiquet 1990) but conversely inhibits migration and axon outgrowth of other neuronal cells (Pesheva et al. 1989, Faissner and Kruse 1990). The use of domain specific antibodies strongly suggests that the bifunctionality of tenascin resides in different binding sites. The monoclonal antibody J1/tn2 which recognises the fibronectin repeats, abolishes the neurite promoting activity, but not its inhibitory-properties (Faissner and Kruse 1990). The growth-promoting effects of tenascin appear to be associated with the fibronectin repeats and the inhibitory effects appear to be associated with the EGF-repeats (Friedlander et al. 1988, Spring et al. 1989). There are several isoforms of tenascin and tenascin-like glycoproteins; J1-160 and J1 180 are two such isoforms derived from differential splicing of one gene (Spring et al. 1989). Judging from their localisation within the developing nervous system, they may be involved in the formation of boundaries which axons cannot penetrate.

Myelin associated proteins (NI-35 and NI-250)

It has been well established that neurones in the CNS fail to regenerate or regenerate extremely poorly (Cajal 1928). The reasons for this are still not clearly understood, but some progress has been made over the past ten years. The pioneering work by Aguayo and colleagues in the early 80's indicated that the environment was an important determinant for regeneration (Benfey and Aguayo 1982). However, attempts by Schwab and Thoenen (1985) to produce regeneration by providing injured neurones with additional trophic support failed. On the basis of his findings, Schwab postulated

that there must be inhibitory activities present in the adult CNS whose effects could not be overcome by neurotrophic factors. He therefore tested the ability of different glial cell classes to permit growth of central and peripheral neurones and found that growth occurred on all glial cell types (astrocytes, immature oligodendrocytes), except mature oligodendrocytes (Caroni and Schwab 1988a). In addition, conditioned medium made from oligodendrocytes failed to cause collapse (Brandtlow et al. 1990), suggesting that inhibition was contact-dependent. Biochemical analysis of oligodendrocyte membrane fractions and CNS myelin revealed the presence of two inhibitory molecules termed NI-35 and NI-250 which when incorporated into liposomes inhibited fibroblast-spreading and neurite outgrowth (Caroni and Schwab 1988a). Treatment of oligodendrocytes with monoclonal antibodies to these molecules allowed DRG axons to extend over them, strongly suggesting that these molecules were responsible for the failure of these neurites to extend over oligodendrocytes (Caroni and Schwab 1988b). Further compelling evidence supporting the activity of these molecules in preventing CNS regeneration has come from both *in vivo* and *in vitro* studies using neutralizing antibodies against these molecules. *In vitro*, the inhibitory effect of myelin is reversed following the removal of NI-35 and NI-250 with antibodies against them. *In vivo*, the regeneration of the disrupted rat corticospinal tract (CST) was increased in both animals treated with inhibitory neutralizing antibody, IN-1 (Schnell and Schwab 1990), and in the Olac rat in which oligodendrocytes and myelin are absent (Savio and Schwab 1990). More recently, experiments have shown that regeneration may be slightly enhanced if IN-1 is delivered to the lesion site in conjunction with the neurotrophic factor NT3 (Schnell et al. 1994). Although in most experimental cases, regenerating axons failed to bridge the lesion completely and therefore regeneration was limited, the results nonetheless provide a potential strategy for facilitating regeneration.

Myelin associated glycoprotein

Recently, another protein associated with CNS and PNS myelin which inhibits neurite outgrowth has been identified. McKerracher et al (1994) used DEAE anion exchange chromatography to isolate two peaks of activity from purified bovine CNS myelin, which inhibited neurite outgrowth for a neuroblastoma cell line. Western blots revealed that the major peak of inhibitory activity corresponded with the elution profile of

myelin-associated glycoprotein (MAG), a member of the immunoglobulin-gene super family. Immunodepletion by anti-MAG antibodies, resulted in loss of neurite inhibitory activity . More conclusively, when used as a culture substrate, recombinant MAG inhibited neurite outgrowth from the neuroblastoma cell line (McKerracher et al. 1994). Similarly, in a separate study, recombinant MAG expressed by Chinese hamster ovary cells (CHO) inhibited neurite outgrowth from both cerebellar and adult dorsal root ganglion neurones (Mukhopadhyay et al. 1994). McKerracher and colleagues have suggested that like NI-35 and NI-250, MAG may be a major contributor to the failure of CNS neurones to regenerate. However unlike NI-35 and NI-250, MAG is also expressed by PNS neurones, although to a much lesser extent (Quarles et al. 1983). This raises two interesting questions; first, how much is the failure of CNS axons to regenerate due to MAG and secondly, since MAG is also present in the PNS, why do these neurones appear to regenerate better than those of the CNS. It may be critical that MAG levels are 10-fold higher in CNS than in PNS myelin but in addition, McKerracher and colleagues have suggested that PNS neurones are still able to regenerate despite the presence of MAG, because of the more rapid removal of myelinated debris following peripheral damage. Consistent with this proposal is the recent report that regeneration occurs in unmyelinated nerve cells but not in myelinated nerve cells in mutant mice in which there is a delay in Wallerian degeneration (Brown et al. 1994).

1.3 Axon guidance mediated by diffusible molecules

1.31 Chemoattraction

Another way in which growth cone motility can be controlled is by chemotaxis, the phenomenon by which the direction of cell movement is determined by the concentration gradient of specific substances. Some well known examples include the invasion of vascular epithelial cells into tissues which produce angiogenic factors, the attraction of leukocytes to sites of tissue damage or local infection and the aggregation of the amoeba, *Dictyostelium discoideum*, to form a multicellular body (Gerisch et al. 1975, Devroetes 1982). The concept that a gradient of attractive factors released from a distant target could serve to guide growing axons was first proposed a century ago by

Ramon y Cajal. However, not until fairly recently has there been any evidence to support this.

The first attempt to demonstrate axonal chemotaxis was prompted by the discovery of nerve growth factor (NGF), a protein which is secreted by the targets of sympathetic and sensory neurones and which is required for their survival (Levi-Montalcini and Angeletti 1963). Evidence indicating that NGF could be a potential chemoattractant came from both *in vitro* and *in vivo* studies. *In vivo*, sympathetic neurones were observed to project to an injection site following large doses of NGF into the brain stem of neonatal rats (Menesini-Chen et al. 1978), and *in vitro*, regenerating sensory axons were shown to orient preferentially up a gradient of NGF (Gundersen and Barrett 1979), and also to turn towards a source of NGF (Gundersen and Barrett 1980). Initially, these observations taken together were thought to indicate that NGF could be a potential chemoattractant *in vivo*. However, enthusiasm for this soon fell with the crucial finding that the target cells of these neurones did not produce NGF mRNA until the first axons reached their targets (Davies et al. 1987). Consequently NGF has been precluded as an endogenous chemoattractant, nonetheless experiments using NGF have importantly demonstrated that growth cones can respond chemotactically to gradients of diffusible molecules. In addition, they have highlighted the key requirements of potential chemoattractant. These are namely that chemoattractants must be available at developmentally appropriate times and in sufficient quantity to establish a suitable gradient in the local cellular environment of developing axons. Axons exposed to a steep gradient of NGF turned towards the NGF source (Gundersen and Barrett 1979, 1980). However, only 60% (compared to 50% for random distribution of orientation) of axons exposed to a shallow gradient of NGF orientated up-gradient (Letourneau 1978), suggesting that the chemotropic effects of NGF is dependent on the steepness of the gradient. The importance of the steepness of the gradient has been further implied by recent studies in which sympathetic neurones of transgenic mice were made to express NGF during their growth towards their targets. Axon trajectories in these mice were unaffected but there was a reduction in terminal branching of these axons. However, by genetically manipulating target cells so that they over-expressed NGF, the reduction in their terminal branching was eliminated (Hoyle et al. 1993).

These researchers have therefore suggested that the initial observed reduction in terminal branching was due to the abolition of the normal target-derived NGF gradient as a result of the presence of excess NGF expressed by sensory axons. Thus when the target cells are made to express increased quantities of NGF, the normal gradient is restored, and terminal branching is maintained (Hoyle et al. 1993). This study not only indicates that an NGF gradient could be important for terminal branching and has indicated a chemotactic role for NGF in the control of terminal arborisations.

A number of neuronal systems have now emerged in which axons have been demonstrated to grow towards their targets in response to gradients of diffusible chemoattractants other than NGF (Lumsden and Davies 1983, Tessier-Lavigne et al. 1988, Heffner et al. 1990). The discovery of chemoattraction in now classical studies by Lumsden and Davies (1983, 1986) took advantage of the fact that neural explants could be successfully cultured and visualised within three dimensional collagen gel matrices (Ebendal and Jacobson 1977). The first indication that such a matrix could provide a stable substratum in which cells could migrate came from initial studies by Elsdale and Bard (1972).

Developing trigeminal sensory axons

Using a refined collagen gel preparation, Lumsden and Davies (1983, 1986) co-cultured explants of developing trigeminal neurones with their cutaneous target, the maxillary epithelium, to observe the effects of target-derived diffusible factors on neurite outgrowth. They showed that trigeminal sensory axons respond chemotactically to a factor(s), distinct from NGF. E10 trigeminal ganglion explants were cultured alone, and co-cultured at a distance of about 300-500um, with explants from E10 maxillary arch. No axon outgrowth was observed from the ganglia cultured alone, while in over 60% of the cases, axons were directed from ganglia towards the maxillary epithelium. The chemoattractant has been called Max Factor (MF) and although it has yet to be characterized, several features are consistent with its role as a diffusible chemoattractant for developing trigeminal axons. First, MF is expressed at developmentally appropriate times (from E 9.5 until at least E 19) the period during

which most of these sensory axons emerge from the trigeminal ganglion (Lumsden 1988). Secondly, axons turned within the collagen gels towards the target and did not exhibit radial outgrowth merely on the side of the ganglion facing the target (Lumsden and Davies 1983). However, since axons emerging from these ganglia were not retrogradely labelled, it is unknown whether the distribution of their cell bodies is uniform or is biased towards the target-facing aspect of the ganglia. Thirdly, when two ganglia were co-cultured in tandem next to the maxillary arch, more axons emerged from the side of the distal ganglion than from the away-facing aspect of the more proximal ganglion (Lumsden and Davies 1983). This is powerful evidence for the operation of a chemotropic gradient. However, the maxillary epithelium clearly provided trophic support because in its absence early trigeminal ganglia failed to produce axons. It therefore remains unclear whether MF and this trophic component are related.

Spinal commissural axons

The floor plate is a neuroepithelial ventral midline structure which runs the length of the developing neural tube. During development, dorsal horn commissural axons travel laterally and dorso-ventrally. On approaching the floor plate, they turn towards it cutting through the motor neurone pools. Tessier-Lavigne et al (1988) demonstrated that E11 dorsal horn explants cultured alone failed to extend commissural axons, but did so in response to the presence of an ectopic floor plate. Retrograde labelling of axons showed that they were deflected from their original trajectories and to grow towards the floor plate, suggesting that the floor plate releases a diffusible chemoattractant (Placzek et al. 1990). The effect appears to be specific to the floor plate and could not be mimicked by other explants such as E11-14 dorsal spinal cord or E11 ventral spinal cord (Tessier-Lavigne et al. 1988). A candidate molecule for the floor plate-derived chemoattractant, netrin-1, has now been identified (Serafini et al. 1994, Kennedy et al. 1994 see later).

Cortical projection axons

The basilar pons is innervated by collateral branches of layer 5 pyramidal cell corticospinal axons. During development corticospinal axons initially grow past the basilar pons into the brain stem, and only later issue collaterals which invade the pons

(O'Leary and Terashima 1988). There is strong evidence to suggest that a diffusible chemoattractant directs this collateral branching. Postnatal day 0-1 cortex was cultured either alone, or with target or non-target control tissue, or flanked by both target and non-target tissues within collagen gels. Compared to controls, a majority of axons emerged from the proximal face of cortical explants than in controls. The effect is tropic, since axons which would have missed the pons had they continued in their normal trajectories, turn preferentially towards it. The cell bodies giving rise to these axons in the cortical explants correspond to the layer 5 pyramidal cells of the cortex, suggesting that the chemoattractant is specific for these neurones (Heffner et al. 1990).

Corticothalamic and corticocortical projections

The visual cortex is arranged in distinct cell layers which project axons to different targets. Cells in the upper layers 2 and 3 project to other cortical areas, whereas cells in the lower layers 5 and 6 send axons to subcortical targets (Gilbert 1983). Using an organotypic culture system, Bolz et al (1990) demonstrated that the formation of these connections is specific and could also be due to axons being chemoattracted towards their targets. Cortical slices from rat visual cortex were co-cultured on a glass coverslip with either another visual cortical slice or with lateral thalamus embedded in a plasma clot. Axons projected from the visual cortical slices and innervated the other co-cultured explant. Retrograde labelling of these axons revealed that the origin and morphology of the cells were consistent with their distributions *in vivo*. Cells that extended axons to the thalamus were located in the deep cortical layers, whereas cells that extended axons to other cortical layers were located in the upper layers. Axons were observed to grow directly towards their appropriate target thus these results indicate that targets of cortical axons secrete specific chemoattractants which are important in the development of cortical projections.

Taken together, these studies have provided compelling evidence that certain axonal targets secrete chemoattractants. Consistent with a role of guiding axons *in vivo*, they have been shown to orient specific sets of axons and at developmentally appropriate times. However, the studies have not provided an indication of the specific contribution made by chemoattractants *in vivo*, nor their mechanism of action. Many questions

therefore still remain unanswered. Do chemoattractants act by affecting growth cones directly or do they act haptotactically, that is, through an association with the substratum? Are they solely responsible for guiding axons *in vivo*, or do they act in concert with other guidance cues? Laminin for instance is expressed on the pathway which trigeminal sensory axons use to reach their target (Riggott and Moody 1987), so it is likely that it acts together with the target-derived chemoattractant, MF, to guide these axons. Since chemoattractants have been shown to orient the growth of early developing axons, perhaps their role is to direct the earliest projecting axons in each system to form a pioneering scaffold on which other axons can grow. A full understanding of the contribution made by chemoattractants will come when these molecules and their receptors are identified and the resultant effects on axon trajectories are studied following genetic manipulations *in vivo*.

1.32 Chemorepulsion

If guidance mechanisms involving contact have their counterparts in attraction and repulsion, then diffusible chemoattractive mechanisms might also have their counterparts in repulsion. Again using the collagen gel assay system, evidence for the existence of chemorepulsants has recently emerged in a number of neural systems.

The lateral olfactory tract

Pini (1993) was the first to demonstrate existence of developmentally appropriate chemorepulsive cues *in vitro* which might guide early lateral olfactory axons. *In vivo*, at embryonic day 15, mitral and tufted cells of the olfactory bulb are arranged circumferentially and project axons to the surface of the brain to form the lateral olfactory tract. Before leaving the bulb to form this tract, they turn away from the septum, a nearby central midline structure. Later in development at E18, they extend collateral branches which innervate the underlying olfactory cortex. When E15 explants of septum or olfactory cortex were co-cultured E15 olfactory bulb explants, olfactory axons consistently grew away from these structures, strongly suggesting that they released chemorepulsive activity. However E15 olfactory bulb axons were unaffected by E18 lateral olfactory cortex explants, coincident with the stage at which these axons innervate the olfactory cortex *in vivo*. The inhibitory activity released by the septum is

unlikely to be non-specifically toxic for several reasons. First, septal explants extended axons in the vicinity of the olfactory bulb and are thus unaffected. Secondly, cortical explants extended axons radially when co-cultured similarly with E15 septum. Third, immunocytochemical observations showed that cell bodies and axons were present within the olfactory bulb explants on the septal-facing aspects. Immunocytochemical and fluorescent-tracer analyses also crucially showed that olfactory bulb axons actually turned within the explant to avoid the septum. Taken together these findings strongly imply that a gradient of repulsive factor(s) released by the septum contributes to directing olfactory tract axons laterally.

Primary sensory afferents

Primary sensory afferents of dorsal root ganglion (DRG) have a specific dorsoventral pattern of termination within the dorsal horn of the spinal cord whereas the 1A muscle spindle afferents terminate within the ventral horn (Rexed 1952). These sensory axons enter the spinal cord through the dorsal funiculus and extend ventrally to their specific termination sites. On approaching the ventral horn, some sensory axons turn away from it and ascend to the more dorsal targets. Fitzgerald et al (1993) co-cultured explants of E14-15 DRG with ventral spinal cord in the presence of NGF and observed chemorepulsion of DRG neurites, suggesting that ventral horn, secreted a diffusible inhibitory activity. The activity is developmentally regulated since E18 ventral horn explants failed to inhibit neurite outgrowth from DRG explants. The molecular identity of the inhibitory activity was not determined in this study, however there is now strong evidence to suggest that this activity is due to members of the semaphorin family (see later) and does not affect the 1A spindle afferents.

Trochlear motor axons

Trochlear motor axons originate from cell bodies near the floor plate and extend away from it along a dorsal trajectory before projecting to their target, the superior oblique muscle of the contralateral eye. This trajectory away from the floor plate is suggestive of chemorepulsion. To test for this possibility, explants containing trochlear motor neurones were co-cultured at a distance from pieces of floor plate within collagen gels. Trochlear motor axon outgrowth occurred consistently away from the floor plate, suggesting that the floor plate releases a chemorepulsant for these neurones

(Colamarino and Tessier-Lavigne 1995). Netrin-1, the chemoattractant for commissural axons is a strong candidate molecule likely to mediate this inhibitory effect. It is secreted by the floor plate (Kennedy et al. 1994), and COS cells expressing netrin-1 inhibit trochlear motor axon outgrowth in culture (Colamarino and Tessier-Lavigne 1995). Thus it appears that netrin-1 like its homolog, UNC-6 which is distributed along a ventral-dorsal gradient in *C.elegans*, may also function to attract ventrally directed axons while repelling dorsally directed ones.

Hindbrain and spinal motor axons

Motor neurones differentiate along either side of the floor plate and extend axons which leave the neural tube either via dorsal or ventral exit points. They never cross the midline and thus always project ipsilaterally. The possibility that this is due to the release of chemorepulsive activity by the floor plate was examined in two ways by Guthrie and Pini (1995). First, in chicks, pieces of floor plate were transplanted into host embryos between motor neurone pools and their axonal exit points. Following this transplantation, motor neurone patterning became disrupted around the grafted floor plate; the majority of motor axons avoided the host floor plate and adopted alternative routes to reach their normal or even inappropriate exit points. To provide evidence that this exclusion of motor axons was due to diffusible activity, explants of embryonic rat floor plate were also co-cultured with E12 basal plate explants from rat hindbrain and spinal cord in collagen gel matrices. Consistent with the transplantation experiments, motor axon outgrowth was greatly reduced from the side of the explant facing floor plate explants. Taken together, these findings strongly suggest that the floor plate secretes a chemorepellent for axons of motor neurones.

Retrograde labelling of cultured axons with the fluorescent tracer DiI, demonstrated that a large proportion of axons which emerged from basal plate explants, away from the floor plate, had turned within the explants.

In a study by Tamada et al (1995), the floor plate has been implicated in maintaining the bilaterally symmetry along the midline of the vertebrate CNS. They examined whether the floor plate released chemorepulsive activity which could be responsible for stopping uncrossed axons from crossing the midline, and also whether it released chemoattractants which guided other axons across the midline. Both uncrossed axons

of the dorsal-most alar plate and of the basal plate of the mesencephalon project ipsilaterally away from the midline. When explants of these neurones are co-cultured with explants of floor plate, they extend axons which turned away from the floor plate, indicating that it secretes chemorepulsive activity. In contrast, floor plate explants induced axon outgrowth of certain mesencephalic and myelencephalic alar plate explants which when cultured alone only extended axons from their ventral edge (Tamada et al. 1995). The study therefore indicates that the floor plate directs both the growth of axons that cross the midline and those that do not.

1.4 CANDIDATE DIFFUSIBLE GUIDANCE MOLECULES

Although a number of diffusible attractive and inhibitory activities have been detected in variety of neural systems in vertebrates, only recently have candidate chemorepellents and chemoattractants been identified (Luo et al. 1993, Kolodkin et al. 1993, Serafini et al. 1994, Kennedy et al. 1994).

1.41 Collapsin

The basis of the assay for isolation of the chemorepellent, collapsin, was Kapfhammer and Raper's (1987a,b) earlier observation of growth cone collapse. They isolated a detergent-extracted fraction from membranes of chick brains which when incorporated into lipid vesicles, caused sensory growth cones to collapse (Raper and Kapfhammer 1990). The active fraction bound to lectin and wheatgerm agglutinin, properties they used for successive purification steps that led to the identification of a 100KDa inhibitory protein, collapsin. Surprisingly, collapsin cDNA transfected into COS cells produced a recombinant soluble form of the protein which unlike the native protein only caused collapse of sensory and not retinal growth cones (Luo et al. 1993). Raper and colleagues suggested that this may be a consequence of altered expression of the native molecule by the COS cells themselves, alternatively this may reflect the existence of multiple forms of the molecule. Consistent with this idea is the fact that the predicted sequence of collapsin indicates four potential sites for glycosylation, and that two different mRNAs hybridize to collapsin cDNA, suggestive of differential splicing. What is the function of collapsin ? It is a secreted molecule which is extracted from

membranes but lacks a transmembrane domain, suggesting that it must bind tightly to cell surfaces. The carboxyl-terminus contains a very basic region, and Luo et al (1993) have suggested that this region is probably responsible for the binding of the molecule to the plasma membrane. Once secreted collapsin may well become rapidly associated with the cell membrane or extracellular matrix; if so, its effects may be exerted rather closer to its source of secretion than would be expected of a freely diffusible agent. The amino-terminal domain shows striking resemblance to that of a previously cloned protein fasciclin IV, a candidate axon guidance molecule in the grasshopper CNS (Kolodkin et al. 1992). Its association with cell membranes and the extracellular matrix indicates that like fasciclin IV, it may occupy guidance domains, acting as a short to medium range guidance cue.

1.42 Semaphorins

Soon after the sequence of collapsin was published, Kolodkin et al (1993) reported the cloning and characterisation of three Sema genes homologous to collapsin and fasciclin IV which form a family of genes encoding transmembrane and secreted molecules called the semaphorins. Each member shares a common 'sema' domain which consists of 500 amino-acids and 16 conserved cysteines (Kolodkin et al. 1993). Fasciclin IV, the first member of the family to be identified (Kolodkin et al. 1992) has now been renamed G-Sema I. Antibodies that block G-Sema I function cause defasciculation of the two sensory axons and the formation of abnormal axon branches. G-Sema I has therefore been proposed to guide these neurones by confining their growth within a specific domain (Kolodkin et al. 1993).

Other members of the semaphorin family include D-Sema I and D-Sema II in *Drosophila*, and a H-Sema III in humans. D-Sema I is a transmembrane protein, whereas D-sema II and H-sema III like collapsin are secreted proteins (Kolodkin et al. 1993).

During embryonic development, Sema II is expressed by a subset of neurones in the CNS and transiently by a single large muscle during motor neuron outgrowth and synaptogenesis (Kolodkin et al. 1993). The latter expression suggests that it may be involved in regulating the formation of synaptic connections. The patterns of segmental nerves that project to thoracic muscles which normally express Sema II were normal in

loss-of-function mutations (Matthes et al. 1995). However, gain-of-function phenotypes in transgenic *Drosophila*, in which muscles along the pathway that did not normally express sema II were made to express it ectopically were examined. They revealed abnormalities in the development of certain branches of the thoracic motor nerve; growth cones that normally innervate thoracic muscles were prevented from forming synaptic connections with these muscles. However, although these growth cones could not form synaptic connections, they were still able to extend through regions expressing high levels of sema II, suggesting that Sema II does not repel growth cones but acts more specifically to inhibit synapse formation.

The ventral horn has been shown to secrete activity which is inhibitory to NGF responsive sensory neurones (Fitzgerald et al. 1993). There is strong evidence to suggest that Sema III/collapsin mediates this inhibitory effect. First, in rat embryos, Sema III mRNA is detected at high levels in the ventral spinal cord but not the dorsal horn, at developmentally appropriate times. Second, in co-culture COS cells secreting Sema III repel NGF responsive sensory afferents but not ventrally directed NT3 responsive afferents. Sema III therefore appears to be a selective chemorepellent for NGF responsive sensory neurones that terminate dorsally (Messersmith et al. 1995).

Screening for murine members of the semaphorin family has led to the isolation of cDNAs encoding a further five new members of the semaphorin family, sem A - sem E, which includes the mouse homolog of chick collapsin sem D (Puschel et al. 1995). Like D-Sema II and sema III/collapsin, they lack a transmembrane domain and are thus likely to be secreted proteins. They have been divided into two new groups, each containing closely related members. Group III comprise three cDNAs, sem A, sem D and sem E, which are highly homologous to chick collapsin. While group IV, contains sem B and sem C. These semaphorins are expressed differentially in the mesoderm and neuroectoderm as early as embryonic day 10 and recombinant sem D secreted by (HEK293) cell aggregates has been shown to be inhibitory for neurite outgrowth of DRG axons. This inhibition was not seen when these cells were co-cultured with retinal explants or when using HEK cells expressing sem A, B or E (Puschel et al. 1995).

In summary, the last few years have seen a enormous activity in the cloning of

candidate guidance molecules. No doubt there are many more to be identified, even within each specific family. The semaphorins share a common sema domain, but outside this region there is considerable sequence variation. This latter region therefore represents a potential site for alternative splicing which would lead to the generation of further members of this family.

1.43 Netrins

A candidate molecule for the floor plate derived chemoattractant, netrin-1, has been described (Serafini et al. 1994, Kennedy et al. 1994). Membrane fractions of floor plate were shown to have activity similar to the floor plate-derived diffusible factor, but it was not feasible to isolate the chemotropic activity from it because of its small size. Instead, Tessier-Lavigne and his colleagues took the approach of screening salt extracts of various membrane fractions from embryonic chick brain and looked for those that mimicked the outgrowth-promoting effect of the floor plate on E11 commissural axons. Axon outgrowth-promoting activity was detected in membrane fractions from which two proteins netrin-1 (78KDa) and netrin-2 (75 KDa) were purified and cloned. The netrins are secreted proteins homologous to UNC-6, a laminin-related protein required for the circumferential guidance of axons and migrating mesodermal cells (Hedgecock et al. 1990). cDNA encoding netrins have been transfected into COS cells and recombinant netrin-1 and netrin-2 shown to produced commissural axon outgrowth-promoting activity (Serafini et al. 1994). Several lines of evidence indicate that netrin-1 is a floor plate chemoattractant for commissural axons. First, using RNA in situ hybridization, netrin-1 mRNA expression was observed in floor plate cells at developmentally appropriate times. Netrin-2 is not expressed in the floor plate, but in the ventral two thirds of the spinal cord, where its distribution is coincident with the path taken by commissural axons to the midline. Second, when dorsal explants are co-cultured with netrin-secreting COS cells in collagen gels, commissural axon outgrowth was promoted from the side of the explant facing the COS cells. In addition, focal sources of netrin-1 induce the turning of commissural axons within spinal explants, comparable to the chemotropic effect of the floor plate (Kennedy et al. 1994). Taken together, these experiments strongly indicate that netrin-1 is a floor plate derived chemoattractant and together with netrin-2, could guide commissural axons in the

developing spinal cord.

A second role for netrin-1 in the directing of trochlear motor axons away from the floor plate has been proposed (see earlier) (Colamarino and Tessier-Lavigne 1994). Thus it appears that netrin-1 similar to its homologue, UNC-6 in *C. elegans* (Culotti 1994), acts as a bifunctional guidance cue.

1.5 GROWTH CONE MOTILITY AND GUIDANCE CUES

As reviewed above, axons are guided to their targets by interactions of their growth cones with a variety of extracellular signals. Thus, the plasma membrane of growth cones must in some way communicate external signals to the interior of the growth cone. How then does the growth cone convert these signals into molecular forces which direct growth cone behaviour ?

To begin to answer these questions, it is important to look at the morphology of growth cones and mechanisms underlying their motility.

1.51 Growth cone structure and cytoskeleton

At the level of the light microscope, growth cones appear to possess a highly dynamic border which is continuously protruding and retracting (Bray and Chapman 1985). These protrusions are of two types; thin finger-like extensions known as filopodia (or microspikes) and broader flatter expansions called lamellipodia. Growth cones are divided into two distinct regions; a central C domain which contains organelles such as mitochondria and a more distal peripheral P domain from which filopodia and lamellipodia emerge and which is relatively free of organelles (Goldberg and Burmeister 1986). Microtubules and microfilaments are the two major cytoskeletal components of growth cones (Letourneau 1981) and have distinct differential localizations within growth cones. Microtubules are located predominantly in the C domain whilst microfilaments are located in the P domain (Yamada et al. 1970).

The presence of microfilaments and microtubules in the filopodia is consistent with the notion that the filopodia can exert a force of tension on the rest of the growth cone which in turn could then “pull” the neurite along (Bray 1979, 1984). However, other studies have indicated that neurite elongation may occur by growth cones being “pushed” from behind rather than being “pulled” (Lamoureux et al.1989). More

recently an alternative theory of growth cone motility has been proposed based on the states of actin in the filopodia. Monomeric actin in the filopodia is continuously being polymerized from G-actin at the leading edge of the growth cone to form F-actin (Forscher and Smith 1988), which is then transported to the centre of the growth cone (Okabe and Hirokawa 1991). It has been proposed that growth cone motility occurs as a function of this F-actin cycling (Hill and Kirschner 1982). In this model the growth cone is pushed forward as F-actin accumulates at the leading edge of the membrane. Two critical steps in this model are therefore the rate of formation of F-actin and the rate of its removal from the leading edge of the growth cone by retrograde transport. It has thus been proposed that the position in which a particular filopodium becomes stabilized, will lead to direct advancement of the growth cone in that direction (Gordon-Weeks 1991, Sabry 1991). Recent experiments suggest that this may be the case. High resolution video imaging of labelled cytoskeletal components of *Aplysia* neurites, shows that F-actin rapidly accumulates at the site where growth cones contact other neurones (Lin and Forscher 1993). Similarly, when grasshopper pioneer growth cones contact guide post cells, the filopodia become dilated at the contact point due to F-actin accumulation (O'Connor and Bentley 1993). These results suggest that dense accumulation of actin at the contact site must therefore underlie the direction for future growth.

Microtubules are major cytoskeletal components which primarily serve to maintain the structural integrity of the neurites and to provide a physical basis for axonal transport. In addition they have been shown to have a more direct role in regulating growth cone motility. Tanaka and Kirschner (1991) examined the behaviour of individual microtubules in living cells and observed that there was correlation between the dynamics of microtubules and growth cone motility. Most significant was their observation that before growth cones turn, they generate microtubules in the direction in which they would subsequently turn, suggesting that the orientation of microtubules may also be involved in actually directing growth cone movement. Gordon-Weeks (1991) therefore suggested that stabilization of microtubules in a particular region of the growth cone (due the stabilisation of the filopodia as a result of binding with appropriate extrinsic cues) could lead to selective protrusion and advancement of the

growth cone in that direction. Once microtubules are stabilized against depolymerisation, they can then serve as a route through which organelles can be delivered by fast axonal transport. In support of this theory is the finding by Sabry et al (1991) who observed that microtubules were highly localised in protrusions that eventually produced new neurites. Similarly, Lin and Forscher (1993) found that when growth cones of the *Aplysia* bag cells came into contact with one another, F-actin accumulation at the contact site was subsequently followed by microtubule intrusion at that site. This re-orientation of microtubules was accompanied by an advance of the C domain in the direction of the re-orientated microtubules.

1.52 Signal transduction

Clearly for extracellular signals to regulate growth cone extension and motility they must ultimately communicate with the cytoskeletal machinery. Extracellular ligands have been shown to mediate their signals through receptors which are either directly associated with the cytoskeletal components (Gumbiner 1993), and/or indirectly through second messengers (Doherty et al. 1991, Saffell et al. 1992).

Many of the molecules which are associated with intracellular signalling can be found in growth cones (Girad et al. 1988, Maness et al. 1988) making it feasible for second messengers to be involved in mediating signals from the extracellular environment. Calcium in particular has been recognized as a key candidate second messenger and there is a large body of evidence correlating local changes of intracellular calcium concentration with the modulation of growth cone behaviour (Mattson and Kater 1987, Cohan et al. 1987, Kater et al 1988). In particular both very low and very high levels of intracellular calcium have been shown to inhibit growth cone motility and neurite outgrowth (Lankford and Letourneau 1991). Calcium is considered a regulator of growth cone behaviour in which there is a graded effect of intracellular calcium concentration (Kater and Mills 1991). Changes in calcium levels has also been shown to regulate both the direction and rate of axonal outgrowth (Bedlack et al. 1992, Davenport and Kater 1992, McCaig 1989).

Several lines of evidence have also implicated protein kinase C (PKC) activation in signal transduction events following receptor-ligand binding on the growth cone cell surface. The growth-promoting effects of laminin, fibronectin and collagens appear to

be dependent on PKC activity. The ability of ciliary ganglion cells to grow on laminin can be mimicked by PKC activators and inhibited by PKC inhibitors (Bixby 1989, Bixby and Jhabvala 1990). Since PKC phosphorylates proteins, and phosphorylation by PKC has been observed in isolated growth cones (Hyman and Pfenninger 1987), this may well prove to be another important step in the signal transduction pathway. Cyclic AMP-dependent protein kinase (Ellis et al. 1985) and tyrosine kinase activity (Maness et al. 1988) have also been found in growth cones.

GAP-43 is could also be a potential regulatory protein involved in growth cone motility. It is most concentrated in the growth cone membranes (Skene et al. 1986), and is a major substrate for PKC (Coggins and Zwiers 1989). There has been some evidence to suggest its role in growth cone motility. COS and CHO cells transfected with DNA clones that induce high levels of GAP-43 expression, have been observed to give rise to the formation of filopodia (Zuber et al. 1989). In addition, growth cones depleted of GAP-43 are devoid of local F-actin accumulation (Aigner and Caroni 1995) a process associated with contact sites during growth cone movement. More critically, GAP-43 has been shown to associate with the cytoskeleton (Moss et al. 1990) suggesting that it may be involved in the regulation of growth cone motility. Nonetheless the exact role of GAP-43 in growth cone motility has remained controversial, not least because the presence of GAP-43 does not seem to be essential for all growth (Aigner and Caroni 1993), and because transgenic mice lacking the GAP-43 gene show no adverse effects on growth cone motility and have normal circuitry (Strittmatter et al. 1995).

G-proteins are also highly concentrated in growth cones (Strittmatter 1990). GTP binding proteins link transmembrane receptors to intracellular second messenger systems (Gilman 1987), and GAP-43 has been shown to stimulate the binding of GTP to G_O (Strittmatter et al. 1990). Activated G protein is then capable of altering conductance through calcium (Hescheler et al. 1987) and potassium channels (Van Dongen et al. 1988), and also of altering phospholipase C activity (Moriarty et al. 1990). It is this important consequence of altering calcium levels in growth cones that is consistent with a role for G proteins in growth cone motility. Several findings have directly implicated G proteins with growth cone activity. For instance the

neurotransmitters serotonin and dopamine both bind to receptors that are known to be linked with G proteins (Haydon et al. 1984). Also the opening of calcium channels as a result of the binding of antibodies to NCAM and L1 is blocked by pertussis toxin, a G protein inhibitor (Schuch et al. 1989). In addition, the morphoregulatory activities of NCAM and N cadherin have also been shown to be transduced by a pertussis toxin-sensitive G protein (Doherty et al. 1991). Although the exact role of G proteins in controlling neurite outgrowth is not known, taken together the evidence available suggests that they may act as co-ordinators between the extracellular signal and intracellular mechanisms which determine the polymerisation of contractile proteins of the cytoskeleton.

1.53 How cell adhesion molecules translate their positive growth signals

An important question is whether extracellular ligands involved in promoting or inhibiting axon growth mediate their activity by activating second messengers, and if so, by what means.

Schuch et al (1989) were the first to demonstrate a relationship between extracellular signals (CAMs) and intracellular calcium levels. They observed that by triggering adhesion by binding specific antibodies to NCAM and L1 receptors expressed on PC12 cells, intracellular levels of inositol phosphates IP2 and IP3 and pH became reduced whilst intracellular calcium levels became transiently increased. The increase in intracellular calcium could be inhibited by L-type calcium channel antagonists and pertussis toxin, suggesting the involvement of calcium channels and G proteins in the signal transduction pathway. More recently, Doherty and colleagues (1991) provided more direct evidence that NCAM and N-cadherin promote neurite outgrowth by the activation of G protein-dependent L and N type calcium channels by showing that a combination of N and L type calcium channel antagonists could completely inhibit neurite outgrowth from PC12 cells cultured on monolayers of 3T3 cells expressing NCAM and N-cadherin. Similarly, neurite outgrowth from PC13 cells on L1-expressing fibroblasts is inhibited by calcium channel antagonists and pertussis toxin (Williams et al. 1992). Furthermore the direct activation of calcium channels in PC12 cells by potassium depolarization or agonist-induced activation of calcium channels, mimics CAM-dependent neurite outgrowth on monolayers of control 3T3 cells not

expressing any CAMs (Saffell et al. 1992). Taken together these studies strongly imply that calcium influx through N- and L- type calcium channels, and G proteins are involved in mediating outgrowth promoted by CAMs. In essence these studies strongly indicate that adhesion molecules mediate their growth-promoting activity by inducing changes in second messenger systems. How changes in second messengers affect the cytoskeletal machinery of the growth cone to promote growth has yet to be determined.

1.54 How inhibitory molecules translate their negative growth signals

How do inhibitory molecules that inhibit neurite outgrowth affect the cytoskeleton ? Some have been shown to do so by eliciting growth cone collapse (eg NI-35, collapsin), whilst others like tenascin and some chondroitin sulphate proteoglycans (Snow et al. 1991) appear to inhibit neurite outgrowth by another mechanism, not involving collapse.

During growth cone collapse, axons retract the actin-filled filopodia, and in some cases, retract beyond the original position of the growth cone itself, suggesting that depolymerization of microtubules could occur as well. Those molecules which cause growth cone collapse must therefore affect cytoskeletal polymerisation in growth cones, whilst non-collapse inducing inhibitory molecules may simply act by making adhesion between the filopodia and the substratum less favourable, or much too favourable so that the filopodia bind so strongly to the substratum that advance is prevented.

What are the cytoskeletal changes that occur during retraction and collapse ? Fan and colleagues (1993) investigated this by looking at the cytoskeletal components of growth cones after the addition of collapsin-like growth cone collapsing activity derived from adult chick brain. They observed a severe depletion of F-actin in the collapsed growth cones but surprisingly no evidence of microtubule disruption. These experiments may indicate that there are two separate mechanisms underlying the collapse response, one that involves disruption of actin filaments and another the disruption of microtubules. An important question then, is how do extracellular inhibitory molecules actually bring about disruptions of the cytoskeleton that eventually lead to growth cone collapse ? As growth-promoting molecules have been shown to mediate their actions through receptors linked to second messenger systems, it is

possible that inhibitory molecules act similarly. Consistent with this notion is Igashi and colleagues (1993) demonstration that the growth cone-collapsing activity of myelin-derived NI-35 and inhibitory membrane extracts from embryonic chick brain could be blocked by treatment with pertussis toxin. In addition, they also showed that direct G-protein activation by the wasp venom, mastoparan, alone was able to induce growth cone collapse. Thus, collapse by these molecules is mediated by G proteins. Changes in intracellular calcium have also been implicated in mediating growth cone collapse. A sharp rise in intracellular calcium precedes collapse in dorsal root ganglion axons following the addition of liposomes containing NI-35. This growth cone collapsing activity could be blocked by treatment with dantrolene (which blocks the release of calcium from intracellular stores), suggesting that collapse is mediated by release of calcium from intracellular calcium stores (Brantlow et al. 1993). However, collapse following certain axon-axon interactions and application of brain-derived growth cone collapsing activity on sensory growth cones, have failed to elicit changes in calcium levels (Ivins et al. 1991), indicating that collapse is not necessarily mediated by rise in intracellular calcium alone.

It appears that molecules that inhibit neurite outgrowth and those that promote growth could both mediate their effects by increasing intracellular calcium concentration. It is therefore somewhat difficult to envisage how a rise in intracellular calcium could mediate both these effects. Perhaps the outcome of an increase in intracellular calcium is dependent on the absolute levels to which it is increased, and/or the rate and duration of the increase.

Exactly how increased levels of calcium or indeed other second messengers lead to growth cone collapse is not well understood. What is clear, is that collapse must at the very least involve the depolymerization of actin in the filopodia. Calcium may therefore in some way facilitate this process, so that retraction rather than protrusion is favoured.

1.55 How are growth cones able to detect gradients of diffusible molecules

At present very little is known about the mechanisms that allow growth cones to detect concentration gradients of diffusible or substratum-bound ligands. One possibility proposed by Bonhoeffer (1984) is that of a 'spatial' mechanism. In this model, the

filopodia act as primary sensors of the local environment by comparing the differences in the levels of receptor occupancy across the growth cone. Gradient detection may also involve a 'temporal' mechanism in which filopodia detect the concentration of cues in local environment by comparing receptor occupancy at different times.

1.6 RESEARCH OBJECTIVES

Over the last decade, it has become increasingly clear that diffusible signals are likely to be major determinants of axon guidance. Most recently, evidence has emerged for the existence of diffusible cues which suppress the growth of axons. Such cues may function to restrict axonal territories during the development of neural networks and may also be critical for maintaining such connections in adult life. A major area of research therefore, is to discover those regions of the developing brain in which diffusible inhibitory cues operate and to determine their molecular identity.

A primary objective is to determine whether or not the secretion of inhibitory activity is a generalised phenomenon occurring throughout the developing nervous system. I have studied this problem by co-culturing explants of different CNS regions within collagen gels. In this way the existence of inhibitory activities secreted by one brain area can be determined by observing their effects on axon-outgrowth of other neural areas. Such information will be required to determine the generality of chemorepulsion and for the crucial problem of identifying mediators by bioassay of brain fractions.

A full understanding of the chemorepulsive effect will only be possible when its mediators are isolated. Thus my other objective involved preliminary investigations of the nature of soluble factors which mediate chemorepulsion. I have attempted to determine the molecular weight ranges of inhibitory activities present in conditioned media by using dialysis membranes of different molecular weight cut-offs. In addition, conditioned media have been subjected to SDS-PAGE electrophoresis. Analysis of the banding patterns of SDS gels together with the molecular weight estimates of inhibitory activities should help to indicate the appropriate brain-derived fractions which will need to be subjected to further analysis to purify chemorepellents.

CHAPTER TWO

MATERIALS AND METHODS

2.1 MATERIALS

Stock solutions for culture experiments

1. DULBECCO'S MEM 10X

with non-essential aminoacids, without L-glutamine, sodium pyruvate and NaHCO₃.

GIBCO BRL

2. 1 X DULBECCO'S MODIFICATION OF EAGLE'S MEDIUM (DMEM)

with 3.70g/l sodium bicarbonate and glutamine. Referred to in the text as culture medium.

ICN FLOW

3. 1 X EAGLE'S MINIMUM ESSENTIAL MEDIUM (MEM)

with Earle's salts, 20mM Hepes buffer, without L-glutamine and sodium bicarbonate.

Referred to in the text as dissecting medium.

ICN FLOW

4. SODIUM BICARBONATE 7.5%

GIBCO BRL

5. PENICILLIN/STREPTOMYCIN (10µl per ml)

GIBCO BRL

Stock solutions for SDS polyacrylamide gel electrophoresis

All reagents were obtained from UK suppliers - SIGMA, FISONS and BDH.

Water used to make standard solutions was deionised (Millipore) .

1. Acrylamide/bis (30%) -

73 g acrylamide, 2g N'N' -bis-Methylene-acrylamide made up to 250ml with distilled water. Filtered and stored at 4 °C in the dark.

2. 1.5M Tris-HCL, pH 8.9 -

27.23 g Tris base (18.15 g/100ml), 80ml distilled water, adjusted to pH 8.9 with 1M HCl. Made to 100ml with distilled water and stored at 4 °C.

3. 0.5 M Tris-HCl, pH6.8 -

6 g Tris base, 60ml distilled water, adjusted to pH 6.8 with 1M HCl. Made to 100ml with distilled water and store at 4°C.

4. 10% SDS - Sodium dodecylsulphate.

10 g SDS dissolved in deionised water with gentle stirring and made up to 100ml.

5. Laemmli Sample buffer -

300mM Tris/HCl pH 6.8

50% (w/v) glycerol

5% (w/v) SDS

10% (v/v) 2-b-mercaptoethanol

Bromophenol blue and pyronine yellow (trace)

Once made, sample buffer was stored in 5ml aliquots at -20 °C and was then kept at 4 °C for up to 3 months.

6. Lower separating gel - (12 % acrylamide)

Distilled water	3.4ml
1.5M Tris -HCl pH 8.9	2.5ml
10% (w/v) SDS stock	100ul
Acrylamide/bis (30% stock)	4.0ml
10% ammonium per sulphate	100µl
Tetramethylethylenediamine (TEMED)	5µl

7. Stacking gel - (4.5% acrylamide)

Distilled water	7.05ml
0.5M Tris-HCL pH 6.8	1.25ml

10% (w/v) SDS	100µl
Acrylamide/bis (30% stock)	1.5ml
10 % ammonium sulphate (APS)	100µl
Tetramethylethylenediamine (TEMED)	10µl

8. Running buffer -

Tris base	30.3g
Glycine	144.1g
SDS	10 g

made up to 600ml with distilled water and stored at 4°C.

9. Molecular weight markers -

Protein MW markers were obtained from a Sigma protein marker kit which contained the following marker proteins ;

High MW markers (KDa)		Lower MW markers (KDa)	
Myosin	205	Bovine serum albumin	66
Beta-galactosidase	116	Egg albumin	45
Phosphorylase b	97.4	Pepsin	34.7
Bovine serum albumin	66	Trypsinogen	24
Egg albumin	45	B-lactoglobulin	18.4
Carbonic anhydrase	29	Lysozyme	14.3

10. Silver staining -

Silver staining solution :

21ml 1MNaOH solution

1.4ml 880 ammonium solution

AgNO₃ solution (0.8g AgNO₃ dissolved in 4ml water - added dropwise)

Made up to 100ml with deionised water. If a precipitate formed, more ammonium solution was added.

11. Silver staining developing solution

2.5ml 1% citric acid solution

0.25ml formaldehyde

Made up to 500ml with deionised water.

2.2 METHODS

2.21 Embryo dissection

All embryos were removed by caesarian section from timed pregnant Sprague Dawley rats (Biological Services UCL) which had been killed by inhalation of a rising concentration of carbon dioxide. The day on which a vaginal plug was first detected was designated embryonic day (E) 0.

All dissections were carried out under aseptic conditions in sterile culture dishes containing MEM/Hepes, and as far as possible tissues were kept on ice. Embryos were transferred from the Falcon tubes into a large culture dish containing MEM/Hepes and kept on ice. Using sharp dissecting scissors and forceps (no 5 Dumont watchmakers forceps), the embryos were removed from their uterine sacs and transferred to a culture dish containing fresh MEM/Hepes. Embryonic heads were then obtained by cervical dislocation and placed in another culture dish containing fresh MEM/Hepes.

The following regions were dissected from the embryonic brains using a Wild M8 microscope ; septum, olfactory bulb, cortical plate, superior colliculus and retina, depending on the experimental requirements. Test and control tissues were then cut into explants of roughly equal size.

2.22 Collagen gel preparation

(a) Preparation of collagen stock solution.

Tendons were removed aseptically from tails of adult Sprague Dawley rats obtained from Biological Services (UCL).

A total of about 5-6g wet weight of tail tendons were removed from approximately 6-7 rat tails and added to 500mls of 0.1M acetic acid and stirred continuously for 48hrs at 4 °C.

After 48hrs, the resultant gelatinous collagen solution was strained through a muslin

gauze to remove debris. The solution was then transferred into centrifuge tubes and spun at 15,000g for 1hr at 4°C. The supernatant was poured into approximately 40cm of 12,000MW cut-off dialysis tubing which had been boiled in the presence of EDTA, (diameter 20mm, Sigma) and sealed at each end. The collagen solution was dialysed against 1/10 th strength DMEM plus penicillin / streptomycin (final concentration 10ul per ml) in a large sterile container at 4°C overnight. The dialysed solution was transferred into a sterile beaker and diluted with distilled water (approx 65 : 35 collagen : water ratio). This solution was then passed through a 0.45um filter, and stored at 4 °C in a plastic falcon tube.

(b) Preparation of collagen prior to use for bioassay.

90ul of the collagen stock solution was removed and transferred into an Eppendorf tube on ice. 10ul of 10 X DMEM was added to it and vigorously mixed using a whirlimixer. Immediately prior to covering the explants with this solution, 3 - 6ul of sodium bicarbonate solution (7.5% w/v) was added to initiate the setting reaction. After thorough mixing this solution should be straw coloured and as its pH rises it becomes pink. 27ul of this collagen solution was used for each gel made.

2.3 Bioassay procedure

The following describes the general steps involved in the bioassay procedure. Additional detailed information regarding each specific experiment is given in the protocol section of each results chapter.

(a) Preparation of explants for culture.

Depending on the particular experiment, the appropriate tissues were dissected from embryo brains as previously described and put into separate culture dishes containing MEM/Hepes on ice. These were then cut into the appropriate size and shape.

(b) Embedding explants into collagen gels.

In order to place explants into collagen gels, the appropriate explants to be cultured were placed in a droplet of MEM/Hepes in a sterile 35ml culture dish (Falcon). The droplet of MEM/Hepes surrounding the explants was then removed by gentle aspiration and quickly replaced with a 27ul droplet of setting collagen solution. With a sterile

metal prodder, explants in the gel were then positioned appropriately, eg for co-culture experiments, test tissues were flanked on either side by explants at a distance of approximately 100-300um apart. Gels were then allowed to stand on a warm surface (approximately 30°C) for approximately half an hour. Control explants were similarly put into collagen gels (evenly spaced out) in a separate culture dish.

(c) Culture conditions.

3mls of culture medium from a stock solution of DMEM plus penicillin / streptomycin antibiotic (final concentration 10ul per ml), were added to each dish for culture. All explants were then incubated for 48hrs at 37°C in water-saturated humidified air containing 5% carbon dioxide. Control explants were similarly cultured for the same length of time, under the same conditions.

(d) Observing and recording results.

After 48hrs, cultures were removed from the incubator and observed under a phase contrast microscope (Wild) equipped with a camera. Photographs of explants were taken at x4 (dark field) and x10 (phase contrast) with standard technical pan black and white film (Kodak). For phase and dark field pictures the scale bars represent 100um. After photographic development, each negative was put into an image enlarger (Durst), and the projected enlarged images of each explant was traced onto blank paper.

CHAPTER THREE

Isochronic co-culture experiments

3.1 INTRODUCTION

Netrin 1, semaphorin III and its chick homologue collapsin have recently been cloned and are all highly probable candidates for endogenous chemorepellants. In addition to the possibility that homologues of these proteins exist, it is reasonable to suppose that additional diffusible growth-suppressant signals exist in the developing brain. The aim of the following experiments therefore is to test this hypothesis. Pini (1993) demonstrated that chemorepulsion and suppression (by around 30%) of axon growth occur when a single olfactory bulb explant is co-cultured with a single septal explant; in addition total axon outgrowth can be suppressed if the olfactory bulb is cultured between two septal explants. To maximize the possibility of detecting such neurite outgrowth-suppressing cues I decided to adopt this latter strategy. The experiments to be described involved culturing a single explant of one brain area flanked by two explants of another within three-dimensional collagen gels. In this way the effects of diffusible molecules emanating from the flanking explants can be tested on the neurite outgrowth of the centrally positioned explant. The experiments were performed using E15 explants for two principal reasons. First, chemorepulsive effects have previously been shown to be maximal at E15 in the septum and ventral horn, the period during which neurones in these areas are being born and issue pioneering axons (Pini 1993, Fitzgerald et al. 1993). Secondly, if chemorepulsive forces operate in guidance, it is reasonable to test for their effects during the early phases of axonogenesis. The latter consideration concerning embryonic age has governed the selection of the other neural regions used in these experiments. The results from this study provide novel data on the distribution of different neurite- outgrowth suppressant activities present in the embryonic rat brain.

3.2 PROTOCOL

In these experiments, three explants were co-cultured within a collagen gel such that two rectangular (400 x 200 μm) explants of one brain region, were positioned either side of a smaller (150 X 150 μm) explant from another. The spacing between the bilaterally placed (flanking) explants and the smaller (test) explant was approximately 100-300 μm . Explants were placed at random orientation, see methods and figure 1.1 below.

Figure 1.1 : Schematic representation of the experimental arrangement within collagen gels.

Plan view of neural explants within a collagen gel

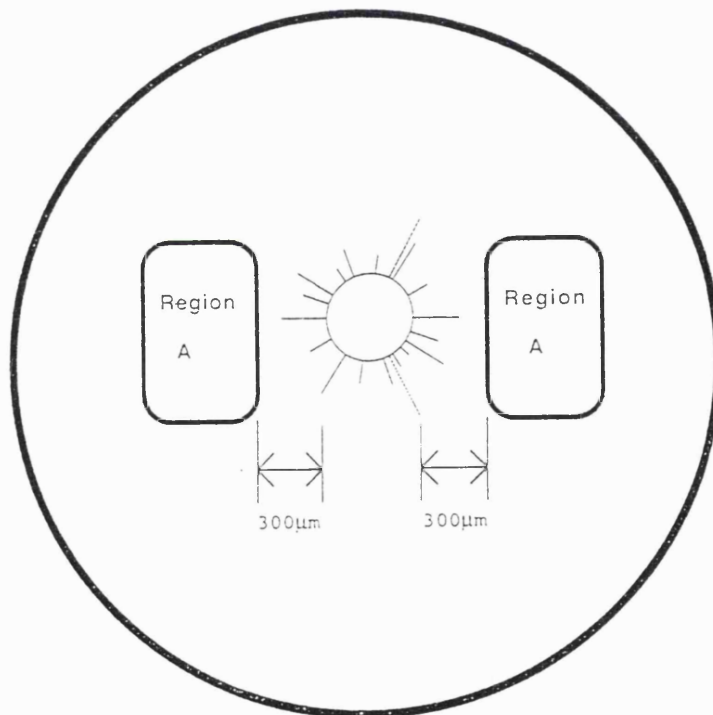

Table 1 : Combinations of iso-chronic E15 tissues co-cultured.

The abbreviations are as follows; superior colliculus SC, retina RET, cerebral cortex CTX, septum SEPT and olfactory bulb B.

Flanking Explant	Test Explant	Flanking Explant
SEPT	CTX	SEPT
CTX	SEPT	CTX
RET	SEPT	RET
SC	SEPT	SC
CTX	SC	CTX
RET	SC	RET
SC	RET	SC
SEPT	RET	SEPT
CTX	RET	CTX
SC	B	SC
CTX	B	CTX
CTX	CTX	CTX
SEPT	SEPT	SEPT

Analysis of neurite outgrowth in isochronic co-culture experiments

The number of neurites emerging from test and control explants was counted from the traced enlarged images of explants.

For statistical analysis all neurites that emerged from within 40% of the circumference of the explant that faced one or other of the flanking explants and which exhibited most neurite growth was counted (see figure 1. 2). The lengths of neurites were not measured and neurites from collateral branches were not counted. “Growth-inhibition” referred to a significant reduction (evaluated by Student’s t test) in the number of neurites emerging from within this 40% of the circumference of each explant compared with controls.

Figure 1.2 Schematic representation of neurites counted that emerged from each explant.

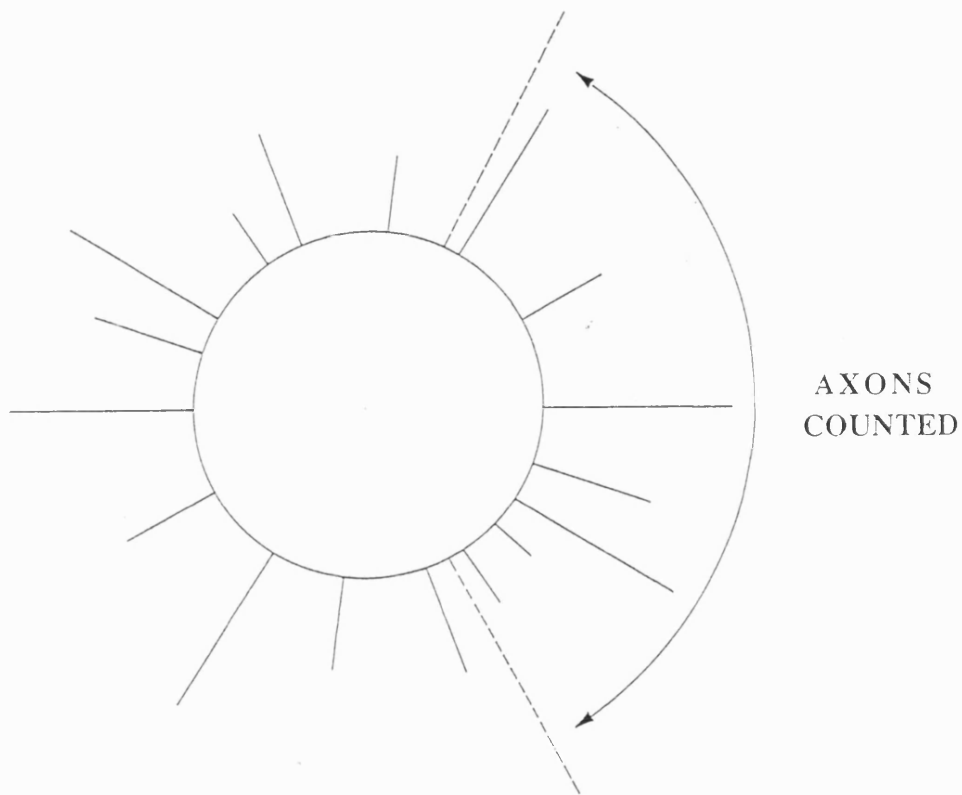

For each set of co-culture experiments, the mean numbers of neurites emerging from within 40% of the circumference of test and controls explants were calculated and expressed as a mean \pm the standard error of that mean (SEM). Statistical comparisons were made using Student's t test. The mean numbers of neurites (\pm SEM) emerging for control and test explants are given in table 2.

3.3 RESULTS

Table 2 Mean numbers of neurites emerging from control and test explants co-cultured with different E15 explants.

<u>Control</u>	<u>no of explants</u>	<u>mean no of neurites</u>	<u>SEM</u>
CTX	9	58.9	4.02
SEPT	20	68.5	2.45
SC	13	47.5	3.70
RET	18	14.5§	3.07
B	8	62.9	1.92

<u>Configuration</u>	<u>no of explants</u>	<u>mean no of neurites</u>	<u>SEM</u>
SC CTX SC	10	39.7*	2.00
SEPT CTX SEPT	10	39.9*	3.07
CTX SEPT CTX	10	48.1*	6.38
RET SEPT RET	14	35.6*	2.27
SC SEPT SC	6	75.3	2.01
CTX SC CTX	12	51.4	3.74
RET SC RET	13	35.2*	3.43
SC RET SC	18	12.0§	1.89
SEPT RET SEPT	20	3.4§*	1.45
CTX RET CTX	25	10.2§	1.24
SC B SC	11	36.7*	3.21
CTX B CTX	15	24.5*	1.65
CTX CTX CTX	10	52.1	2.30
SEPT SEPT SEPT	8	60.5	2.10

§ denotes axons emerge as fasciculated bundles.

* denotes a significant ($p < 0.01$) reduction in numbers of neurites extending compared with controls.

Neurites first appeared from all explants after 24hrs of culture. By 48hrs control explants had extended long neurites radially. However, in contrast some test explants showed a significantly marked reduction in the number of neurites emerging from the sides of the explant facing the flanking explants. These effects are illustrated in figures 1.3 to 1.5

Control explants

For internal control experiments, cortical explants were co-cultured with each other, and septal explants with each other ; no inhibition of neurite outgrowth was observed. The mean number of neurites emerging from control cortical explants was 58.9 ± 4.02 (n=10), compared with 52.1 ± 2.3 (n=8) for centrally positioned cortical explants co-cultured with two other larger cortical explants. The mean number of neurites emerging from control septal explants was 68.5 ± 2.4 (n=8), compared with 60.5 ± 2.1 (n=8) for centrally positioned septal explants co-culture with two other larger septal explants.

Cerebral cortex : Cerebral cortical explants released activity which inhibited neurite outgrowth from septal explants by 30% and olfactory bulb explants by 61% but had no significant effect on neurite outgrowth from superior colliculus or retinal explants. The effect on a septal explant co-cultured with cortical explants is shown in figure 1.5 B.

Septum : Septal explants released activity which inhibited neurite outgrowth from both cortex and retinal explants by 32% and 76% respectively. The effect on a retinal explant co-cultured with septal explants is shown in figure 1.3 B.

Superior colliculus : Superior collicular explants released activity which inhibited neurite outgrowth from both olfactory bulb and cortical explants by 42% and 32% respectively but had no significant effect on neurite outgrowth from retina or septal explants. There was a slight increase of 10% in the number of septal neurites when co-cultured with superior colliculus explants but this is just at the borderline of statistical significance. The effects of the superior colliculus on neurite outgrowth from retina, olfactory bulb and septal explants are shown in figure 1.3 C, figure 1.4 B and figure 1.5 C respectively.

Retina : Retinal explants released activity which inhibited neurite outgrowth from explants of both superior colliculus and septum by 26% and 48% respectively, the most potent inhibitory effect being observed on septal axons.

Overall the four most potent inhibitory interactions observed were those of septal explants on retinal neurites (76% inhibition), followed by cortical explants on olfactory bulb neurites (61% inhibition), followed by retinal explants on septal neurites (48% inhibition), followed by superior collicular explants on olfactory bulb neurites (42% inhibition).

Figure 1.3 Dark field pictures showing a retinal explant co-cultured separately with two different flanking tissues, septum and superior colliculus. Flanking tissues are not shown.

(A) Control retinal explant

(B) Retinal explant co-cultured with septum. Retinal neurite outgrowth is significantly reduced.

(C) Retinal explant co-cultured with superior colliculus. Retinal neurite outgrowth is unaffected.

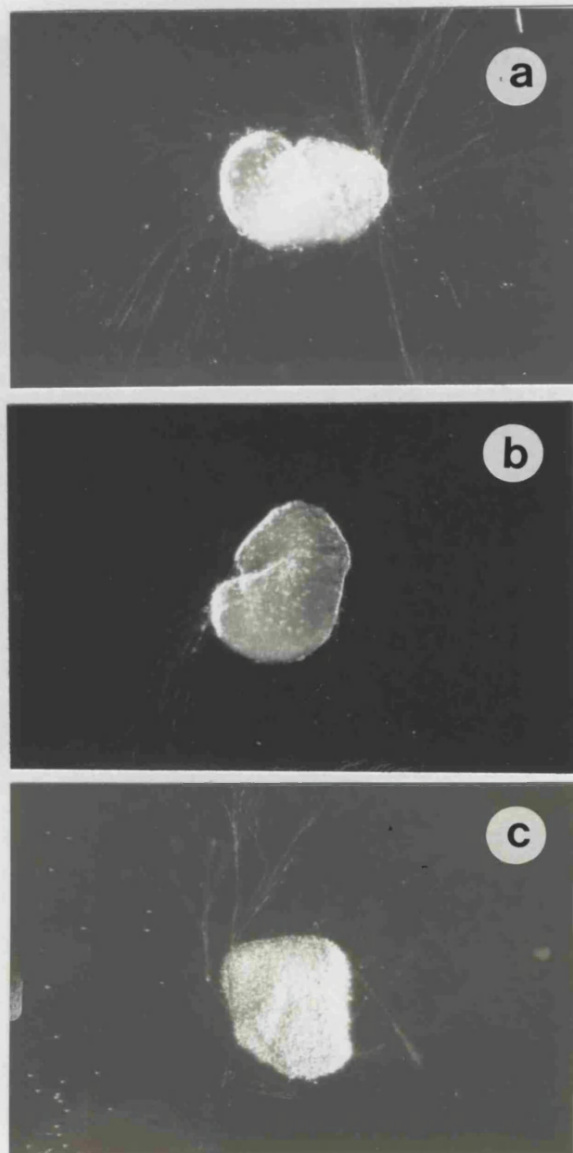

Figure 1.4 Phase contrast and dark field pictures showing the effect of the same flanking explant (superior colliculus) on two different tissues (retina and olfactory bulb). Flanking tissues are not shown.

(A) Control olfactory bulb explant

(B) Olfactory bulb explant co-cultured with superior colliculus. Olfactory bulb neurite outgrowth is inhibited.

(C) Control retinal explant

(D) Retina explant co-cultured with superior colliculus. Retinal neurite outgrowth is unaffected.

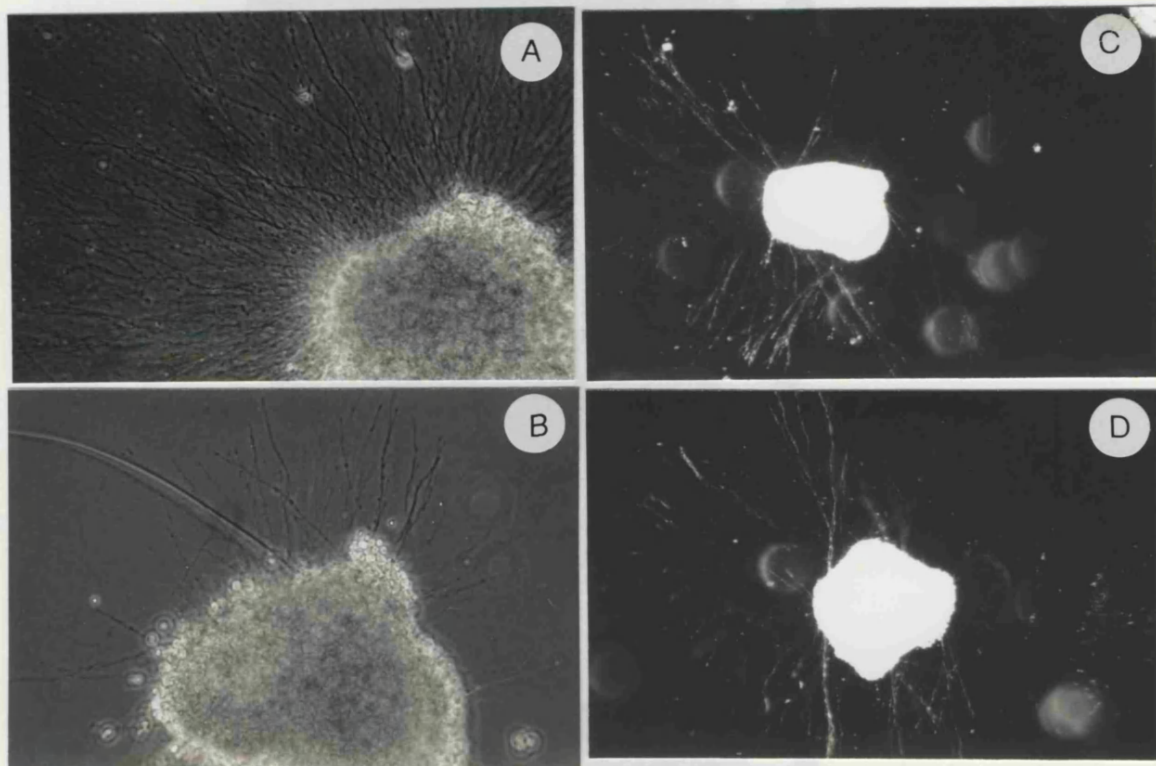
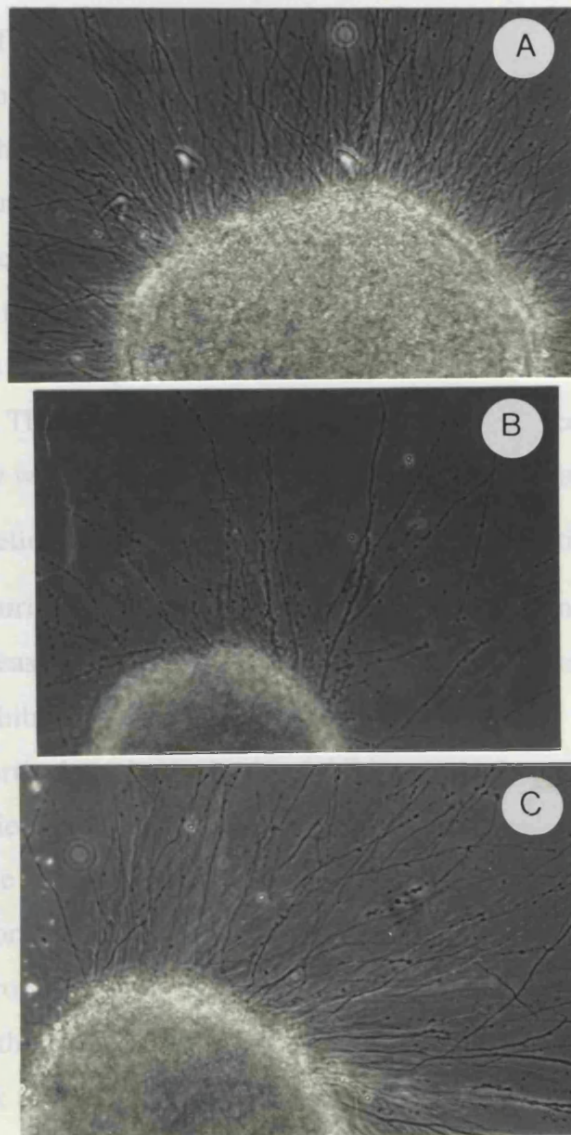

Figure 1.5 Phase contrast pictures showing a septal explant co-cultured separately with two different tissues (cortex and superior colliculus). Flanking tissues are not shown.

(A) Control septal explant

(B) Septal explant co-cultured with cortex. Septal neurite outgrowth is inhibited.

(C) Septal explant co-cultured with superior colliculus. Septal neurite outgrowth is slightly enhanced.



3.4 DISCUSSION

The hypothesis that multiple diffusible growth-suppressant signals exist in the developing brain was tested by co-culturing explants from different brain regions in three-dimensional collagen gel matrices. The strategy was based on the fact that collagen gel matrices stabilize gradients of diffusible molecules (Lumsden and Davies 1983) and therefore make it possible to observe the effects of such factors released from one brain area on the neurite outgrowth of others. A variety of explants were co-cultured irrespective of their developmental relationships because the aim was to identify regions of the brain that secrete (and respond) to growth-suppressing activities. Four brain regions, cortex, superior colliculus, retina and septum were found to release activity which significantly reduced neurite outgrowth in other defined regions. The effects on neurite outgrowth from test explants were not due to a contact-dependent interaction since explants were positioned far enough apart to ensure that no contact between neurites from test explants and flanking explants occurred. Thus the neurite inhibitory effects can only be attributed to the secretion of diffusible factors from flanking explants. The inhibitory activities are tissue specific; cerebral cortical explants release an activity which, in culture, will inhibit septal and olfactory bulb neurites, but not those of the retina. Superior collicular explants release activity which also inhibits olfactory bulb neurites but has no effect on septal or retinal neurites. Indeed there is even a slight increase in the numbers of septal neurites. Septal explants also release activity which inhibits olfactory bulb axons (Pini 1993), but in contrast to superior collicular and cortical explants, it also inhibits retinal neurites. The fact that the inhibitory activities are tissue-specific not only argues the case for the existence of multiple diffusible inhibitory activities but also importantly eliminates the possibility that these inhibitory activities are simply non-specific toxic agents. If this were case, then neurite outgrowth from all test explants would be expected to be inhibited, this is not the case. In the isotypic control experiments described on p60, large flanking explants of cortex and septum had no effect on the outgrowth of the smaller centrally positioned explants. These observations add strongly to the case that the larger explants do not release non-specific toxic effects during culture. However, another possibility is that tissue-specific effects are due to a differential tolerance of neurites to toxic agents.

The inference here being that inhibition of neurite outgrowth will occur as consequence of a particular tissue having a low susceptibility to toxic agents. This possibility is unlikely since a single test explant which is inhibited by one particular tissue is not necessarily inhibited by all other neural regions that secrete growth-inhibitory activity. For example, retinal neurite outgrowth is inhibited by activity released by the septum but not by the cortex or superior collicular explants which both release inhibitory activity. This therefore rules out the possibility that a particular tissue, retina in this case, may possess a general innate low susceptibility to non-specific toxin.

The results indicate that there are multiple growth-suppressing signals in the embryonic brain but they do not directly indicate their numbers. However, it appears that there are at least three discernable activities. First, the cortex, septum (Pini 1993) and superior colliculus all inhibit the olfactory bulb and could therefore release identical activities. Secondly, only the septum inhibits the retina and so may release an activity distinct from those released by the cortex and superior colliculus. Thirdly, the cortex and superior colliculus could both release identical activities but since only the cortex inhibits the septum its activities may be distinct. On these data, the simplest though not necessarily complete scheme, would be that the cortex, septum and superior colliculus all release an identical activity which inhibits the olfactory bulb but in addition, the cortex and septum would each release separate inhibitory activities. In summary, while it is reasonable to suppose the existence of three distinct inhibitory activities, this may not be an upper limit. The septum secretes the most potent inhibitory activity which reduces retinal neurite outgrowth by 76% and cortical neurite outgrowth by 32%. This result would be consistent with the release by the septum of two separate activities with different potencies. Alternatively, such a difference could be indicating that the extent of inhibition simply reflects differences in the number or affinity of specific receptors to a single inhibitory factor secreted by the septum. Taken together with the results of Pini (1993) a simple flow diagram of the relevant tissue interactions is shown in figure 1.6.

FIGURE 1.6

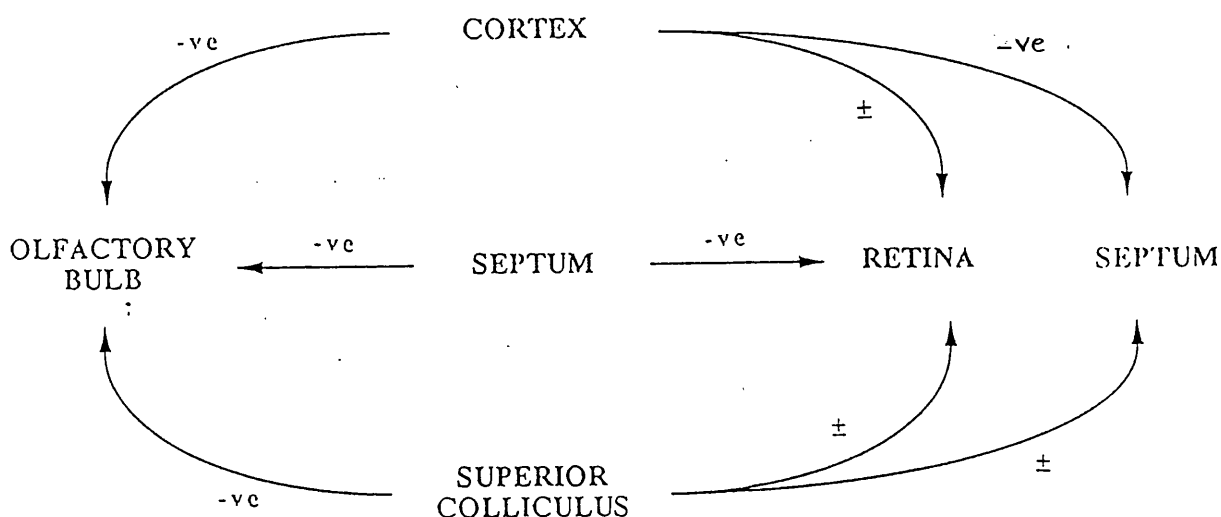

-ve denotes a significant in neurite growth inhibition, \pm denotes no effect on neurite growth and +ve denotes a significant increase in neurite growth.

It is possible that the different inhibitory effects summarised in fig 1.6 could be due to different levels of secretion by the cortex, superior colliculus and septum of the same inhibitory activity. Since the septum but not the cortex or superior colliculus inhibits the retina, and all inhibit the olfactory bulb, it follows that the cortex and superior colliculus would have to secrete activity at low to subthreshold levels, while the septum would secrete at much higher levels. If so, it is unlikely that the cortex and superior colliculus would have potent effects on the olfactory bulb. However, this is not the case; the cortex releases activity which inhibits neurite outgrowth from olfactory bulb explants by 61% while the superior colliculus inhibits these neurites by 42%. In the experiments of Pini (1993) single septal explants reduced neurite outgrowth from olfactory bulb explants by 33.5%. If the potency of this effect were to double due to the positioning of a second septal flanking explant, then inhibition of the olfactory bulb outgrowth would be close to the level of inhibition described here for cortical explants (61%) and not far dissimilar to that (42%) due to the superior colliculus. Moreover, the septum and retina exhibit mutual inhibition. Since single septal test explants are not inhibited by septal flanking explants, it follows that the mutual inhibition must be borne of distinct activities.

These results do not give any indication of the nature of the inhibitory activities or their mechanism of action. For instance it is not clear whether they inhibit neurite outgrowth by acting on growth cones directly, or haptotactically, that is, indirectly by binding to the collagen substratum. It is also unclear in these experiments whether in addition to their anti-trophic (growth inhibiting) effects these inhibitory activities have tropic (neurite-orientating) effects. It is likely that they do, in a similar fashion to the inhibitory activity secreted by the septum (Pini 1993) but determination of tropic effects has not been a primary objective of these experiments. In these co-culture experiments, test explants were almost completely surrounded by flanking explants, thus producing gradients with an entirely different shape that would exist with just one flanking explant.

Although the number of inhibitory activities is unknown, and further investigation is required to determine their molecular nature, it is clear from the results that there are multiple growth-suppressing signals present in the developing rat brain. These signals are secreted, diffusible and reduce neurite outgrowth from specific test explants *in vitro*.

CHAPTER FOUR

Conditioned media experiments

4.1 INTRODUCTION

With the recent demonstrations of neural systems in which chemorepulsion operates (Pini 1993, Fitzgerald et al. 1993, Guthrie and Pini 1995, Messersmith et al. 1995, Colamarino and Tessier Lavigne 1995, and Tamada et al. 1995) chemorepulsion has now become recognized as a potentially significant guidance mechanism. However, the full extent of its contribution to axon guidance is as yet unclear and awaits identification of further mediators and, critically, their receptors. At that stage it will then be possible to use transgenic technology to determine the role of chemorepulsion to axon guidance *in vivo*. The next major objective is therefore to attempt to identify and isolate these agents and their receptors using both biochemical techniques and bioassay. The purification of biologically active factors has consistently proven to be a long and painstaking task. However, with the use of robust *in vitro* assays two diffusible molecules, netrin 1 (Serafini et al. 1994, Kennedy et al. 1994) and collapsin/Sema 111 (Luo et al. 1993, Kolodkin et al. 1993), that mediate axon guidance *in vitro* have been isolated.

Conditioned medium would appear to be a good starting material for isolation since cells release material into the media which can affect the growth of axons in culture. Several factors secreted in culture by non-neuronal cells have been shown to promote neurite extension (Lander et al. 1983). For example, heart-conditioned medium initiates and prolongs the survival of dissociated parasympathetic ciliary ganglion cells (Collins 1980). The active component in heart conditioned medium has been identified as laminin (Lander et al. 1985). More recently, Smith and his colleagues have purified the mesoderm inducing factor, activin, from an XTC-cell line-conditioned medium (Smith et al. 1990). Neurite-promoting activity has also been found in conditioned media from neuronal cell cultures. Floorplate-conditioned medium contains activity which promotes commissural axon outgrowth from dorsal explants (Placzek et al. 1990), suggesting that under these conditions the floor plate actively secretes axon guidance factors. However, netrin-1 was not isolated from floor plate-conditioned media because of the difficulties associated with making sufficient quantities for biochemical analysis.

If chemoattractants can be secreted by target tissues, then it is entirely reasonable to assume the same of chemorepellents. Conditioned media made using tissues known to secrete neurite outgrowth-suppressant activity could then be used to provide a basis for the preliminary biochemical isolation of inhibitory factors. Tissues found to release inhibitory activity in this study are considerably larger, making the task potentially less arduous.

The aim therefore, was to make conditioned media from brain regions which my experiments had shown secrete outgrowth-suppressant activity. This would allow the hypotheses that discriminable inhibitory activities are secreted by different brain regions to be tested and could provide material for preliminary biochemical studies.

4.2 PROTOCOL

The first step was to make E15 cortex- and E15 superior colliculus-conditioned media. In these experiments defined medium was conditioned for 24hrs with neural explants, cellular material was removed by centrifugation and the conditioned media were then used to culture test explants (olfactory bulb and septum) for a 48hr period. The experimental procedure followed three sequential stages over a four-day period. See below.

(i) Primary culture conditions (day 1)

The appropriate amount of specific conditioning tissue depending on tissue type (see tissue to culture medium ratio below) was dissected from embryo brains as previously described. The conditioning tissue was put into a culture dish with fresh dissecting medium and cut into pieces (maximum size around 1mm^3). These were then cultured with the appropriate amount of culture medium for 24hrs.

Tissue to culture medium ratio :

The tissue to culture medium ratio required to make each conditioned medium varied and was dependent on maintaining the physiological pH of the medium. This ratio was arrived at by trial and error for the different brain regions such that the pH of the medium remained within physiological limits. The tissue to culture medium ratios were as follows : For E15 cortex-conditioned medium, 4 whole cortices were added to 3.5mls of culture medium. For E15 superior colliculus-conditioned medium, 5 whole superior colliculi were added to 3.5mls of culture medium.

(ii) Secondary culture conditions (day 2)

Olfactory bulb and septum were chosen as test explants. As previously described they were removed from E15 embryos, cut into small explants and put into two separate collagen gels, and positioned well apart from each other. Control explants of olfactory bulb and septum were similarly put into collagen gels in a separate culture dish. Conditioned medium (including conditioning tissues) was transferred from the culture dish and put into Eppendorf tubes. These were then centrifuged at 6000rpm for 2mins in a bench top microcentrifuge (Spectra). A total of 2mls of supernatant was then used to culture test explants in each dish for 48hrs. Control explants were grown in fresh culture medium from the same batch as was used to make the conditioned medium.

(iii) Measuring neurite outgrowth from explants (day 4)

Test and control explants were examined by phase contrast microscopy and photographed at sufficient resolution to allow counting of individual neurites. The enlarged image of each explant was traced onto blank paper.

Figure 2.1 : Schematic representation of steps involved in the experimental procedure.

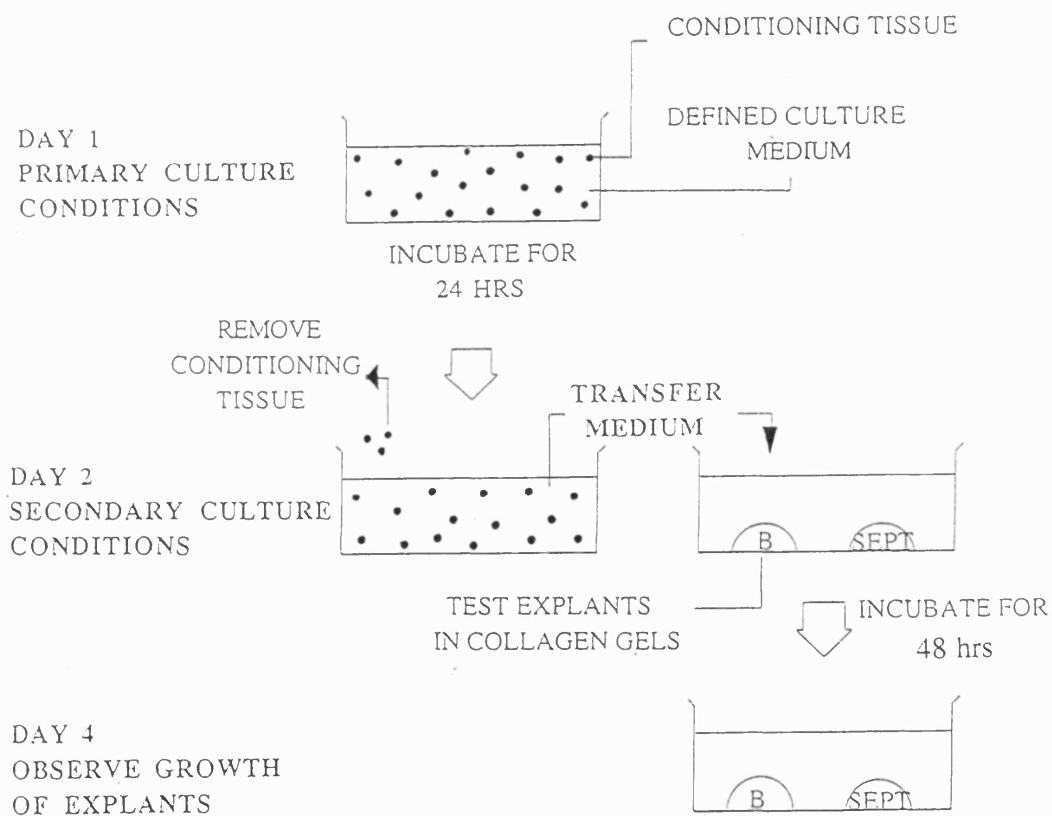

Analysis of neurite outgrowth from explants cultured in conditioned media.

The explant border and the whole length of each neurite emerging from each explant was traced. For statistical analysis, explants were approximated to a circle and the numbers of neurites extending from 40% of the circumference of each explant within three defined bands were counted. The width of these bands corresponded to 25% (band 1), 50% (band 2) and greater than 50% (band 3) of the width of the explant.

Figure 2.2 : Schematic representation of an explant and its neurites showing the way in which neurite lengths were estimated.

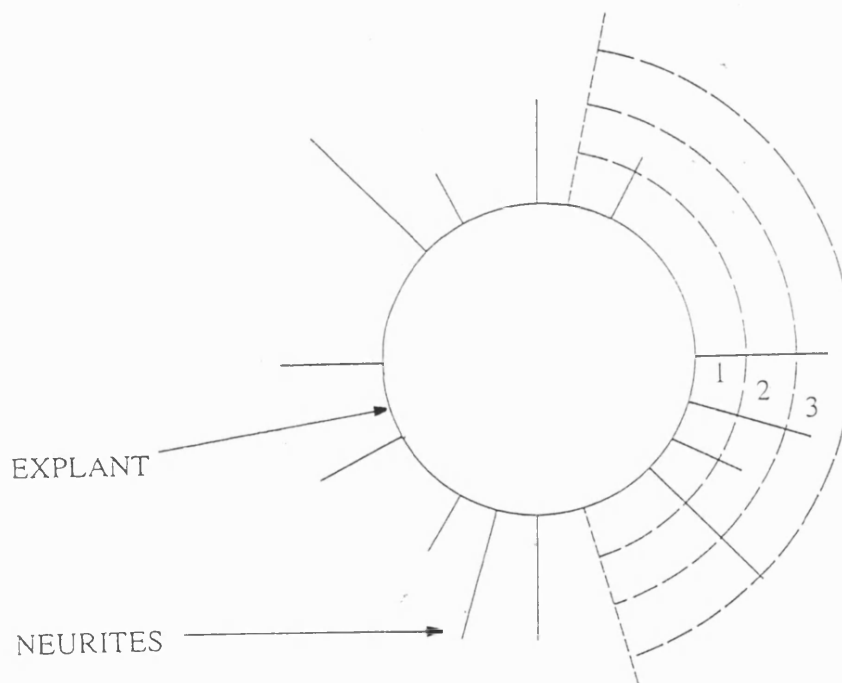

The mean numbers (\pm SEM) of neurites emerging within each band for control and test explants cultured in cortex-conditioned media and in superior colliculus-conditioned media are presented in table 3 and table 4 respectively.

4.3 RESULTS

TABLE 3 Mean numbers of neurites extending within three defined bands for control and test explants cultured in cortex-conditioned media.

<u>Control</u>	<u>Band 1</u>	<u>Band 2</u>	<u>Band 3</u>
<u>Explant</u>			
B	19.3 ± 1.77 (9)	17.1 ± 1.79 (9)	11.9 ± 2.60 (9)
SEPT	15.2 ± 0.97 (6)	13.4 ± 1.78 (6)	7.6 ± 1.97 (6)
<u>Test</u>	<u>Band 1</u>	<u>Band 2</u>	<u>Band 3</u>
<u>Explant</u>			
B	20.8 ± 1.43 (13)	16.6 ± 1.96 (13)	14.5 ± 2.05 (13)
SEPT	20.7 ± 1.94 (10)	16.2 ± 2.65 (10)	10.9 ± 1.77 (10)

TABLE 4 Mean numbers of neurites extending within three defined bands for control and test explants cultured in superior colliculus-conditioned media.

<u>Control</u>	<u>Band 1</u>	<u>Band 2</u>	<u>Band 3</u>
<u>Explant</u>			
B	20.81 ± 1.34 (16)	18.18 ± 1.54 (16)	14.0 ± 1.57 (16)
SEPT	20.6 ± 1.77 (15)	17.53 ± 1.88 (15)	9.66 ± 1.35 (15)
<u>Test</u>	<u>Band 1</u>	<u>Band 2</u>	<u>Band 3</u>
<u>Explant</u>			
B	16.66 ± 2.33 (9)	13.44 ± 2.61 (9)	9.44 ± 2.56 (9)
SEPT	17.42 ± 2.48 (7)	15.28 ± 2.06 (7)	8.85 ± 2.89 (7)

The figures in parenthesis indicates the numbers of explants counted.

Cortex-conditioned media

Neurite outgrowth was not inhibited from olfactory bulb or septal explants cultured in cortex-conditioned media. 70% of olfactory bulb neurites that emerged from explants cultured in cortex-conditioned medium extended as far as band 3, and 80% as far as band 2 compared with 62% (band 3) and 89% (band 2) of those which emerged from olfactory bulb controls. Similarly, 53% of septal neurites that emerged extended as far as band 3 and 79% as far as band 2 compared with 50% (band 3) and 88% (band 2) for control septal explants.

Superior colliculus-conditioned media

Neurite outgrowth was not inhibited from olfactory bulb or septal explants cultured in superior colliculus-conditioned media. 57% of olfactory bulb neurites that emerged from explants cultured in superior colliculus-conditioned medium extended as far as band 3, and 81% as far as band 2 compared with 67% (band 3) and 87% (band 2) of those which emerged from olfactory bulb controls. Similarly, 51% of septal neurites that emerged extended as far as band 3 and 88% as far as band 2 compared with 47% (band 3) and 85% (band 2) for control septal explants.

Typical examples of olfactory bulb explants cultured in cortex-conditioned media and superior colliculus-conditioned medium are shown in figure 2.3.

Cortex and superior colliculus-conditioned media did not inhibit neurite outgrowth from olfactory bulb or septal explants, indicating the absence of detectable inhibitory activity.

FIGURE 2.3 Phase contrast pictures of an olfactory bulb explant cultured in superior colliculus-conditioned medium and in cortex-conditioned medium.

(A) Control olfactory bulb explant

(B) Olfactory bulb explant cultured in superior colliculus-conditioned medium ; neurite outgrowth is unaffected.

(C) Olfactory bulb explant cultured in cortex-conditioned medium ; neurite outgrowth is unaffected.

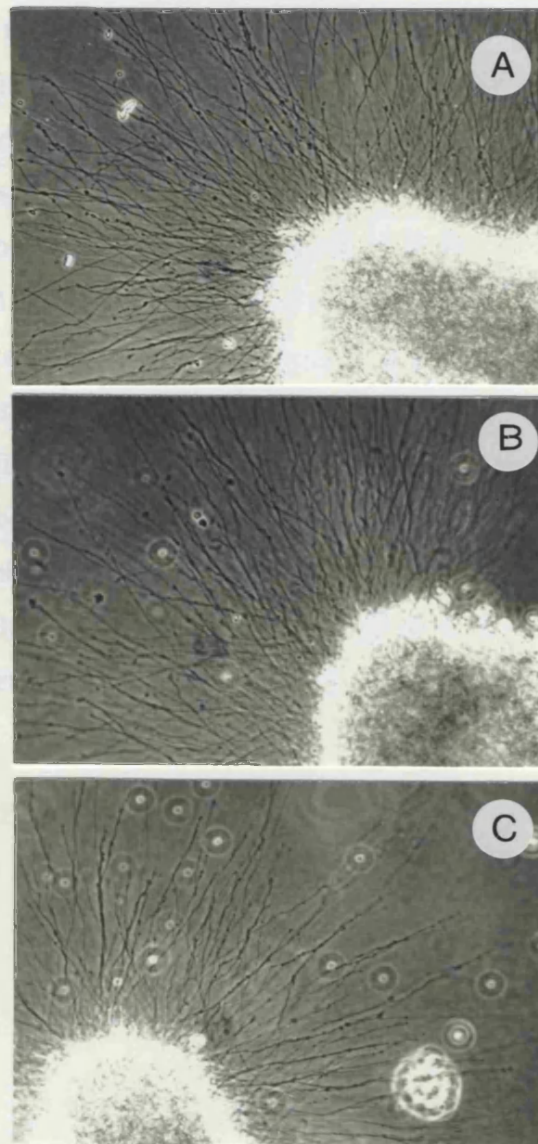

4.4 DISCUSSION

The initial experimental approach was to make conditioned media by conventional means and then test their ability to inhibit neurite outgrowth from neural test explants. Hence, tissues known to secrete inhibitory activity (cortex and superior colliculus) were each separately incubated in defined medium for 24hrs, after which the media were used to culture test explants of olfactory bulb and septum for further 48hrs. None of the conditioned media made in this way significantly inhibited neurite outgrowth from test explants. However, the precision of the methods of estimating neurite outgrowth would not preclude a 10% difference in neurite outgrowth and thus it is possible that inhibition which was undetectable occurred.

Since I had already shown (see isochronic co-culture results) that both cortex and superior colliculus secrete inhibitory activity in collagen gels, the inference was that these tissues do not do so when floating freely in media. Alternatively, once secreted, this activity could be rapidly inactivated so that over the subsequent 48hr period in which test explants are cultured, activity has fallen to such a level that it is ineffective. The former is less likely since conditioning tissues in other systems clearly secrete molecules into defined media. Therefore, the possibility that sufficient levels of activity must be maintained by the continuous secretion of activity from conditioning tissues appeared more probable. An alternative experimental strategy was devised in which test explants were cultured in collagen gels under conditions where activity could be continuously secreted by conditioning tissues.

4.5 PROTOCOL

The experimental procedure followed five sequential stages over a three day period.

(i) Preparation of conditioning tissue (day 1)

The appropriate amount of specific conditioning tissue was dissected from embryo brains as previously described. These tissues were put into a culture dish with dissecting medium and cut into explants (maximum size around 1mm^3) and then kept on ice.

(ii) Preparation of test explants (day 1)

Olfactory bulb, retina and septum were chosen as test explants. As previously described they were removed from E15 embryos, cut into small explants and put into three separate collagen gels in the same culture dish. Control explants of olfactory bulb, retina and septum were similarly put into collagen gels in a separate culture dish.

(iii) Primary culture conditions (day 1)

The conditioning explants were then transferred using a plastic pipette into a 2ml Eppendorf tube on ice. Conditioning tissues were allowed to settle for approximately 20mins after which excess dissecting medium was removed. The conditioning tissues were then resuspended in 1ml of defined culture medium. Conditioning tissues, together with culture medium, were transferred into the culture dish containing test explants embedded in collagen gels. Before incubation, additional culture medium was added to the culture dish. The additional amount added varied depending on the conditioned media made, see tissue to culture medium ratio below. Control explants were similarly cultured for 24hrs but in 3mls of defined culture medium only.

Tissue to culture medium ratio

The conditioning tissue to culture medium ratio required to make each conditioned medium varied and was dependent on maintaining the physiological pH of the medium. The ratio was arrived at by trial and error and by taking into account the different masses of the conditioning tissues.

Tissue to culture medium ratios were as follows : For E15 septum-conditioned medium, 48 whole septa in 1.3mls of culture medium. For E15 cortex conditioned medium, 4 whole cortices in 3.5mls of culture medium. For E15 superior colliculus conditioned medium, 5 whole superior colliculi in a total of 3.5mls of culture medium.

(iv) Secondary culture conditions (day 2)

After 24hrs, all the conditioned media (including conditioning tissues) were transferred from the culture dish and put into Eppendorf tubes and centrifuged at 6000rpm for 2mins in a bench top microcentrifuge (Spectra). A total of 2mls of supernatant was returned to the culture dish and reincubated for a further 24hrs. Culture medium was also removed from control explants, similarly spun for 2mins, and replaced prior to being reincubated for a further 24hrs.

(V) Measuring neurite outgrowth from explants (day 3)

Control and test explants were examined by phase contrast microscopy and photographed.

Photographic negatives were put into an image enlarger and the images of the explants and their axons were projected on to a blank piece of paper and traced.

Figure 2.4 : Schematic representation of steps involved in the experimental procedure.

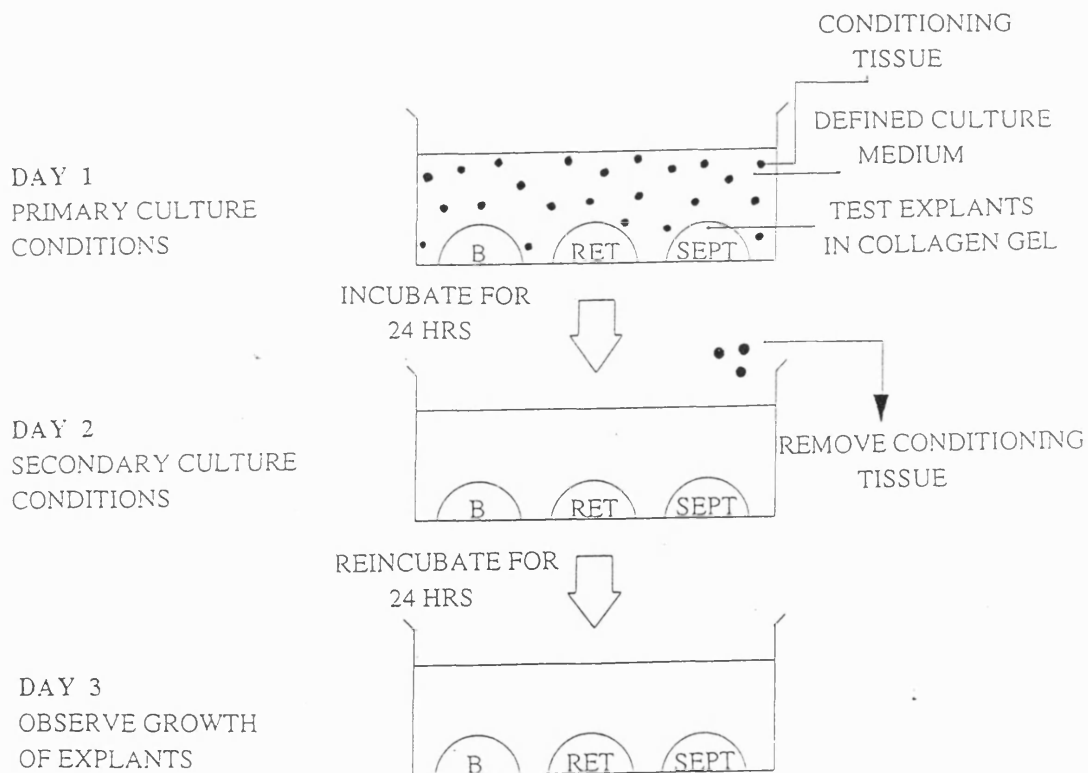

Analysis of neurite outgrowth from explants cultured in conditioned media.

The explant border and the whole length of each neurite emerging from a representative 40% of the circumference of the explant was traced, except for retinal explants. Retinal neurites emerged as fasciculated bundles and were all counted as such. For statistical analysis, explants were approximated to a circle and the numbers of neurites extending within three defined bands were counted. The width of these bands corresponded to 25% (band1), 50% (band 2) and greater than 50% (band 3) of the width of the explant. Neurite outgrowth was measured quantitatively by counting the numbers of neurites which extended within each band for control and test explants, and calculating the percentage of neurites which extended into bands 2 and 3. Growth inhibition refers to a significant reduction (evaluated by Student's t tested) in the number and percentage of neurites that emerged that extended beyond band 1 compared to control. Therefore in these experiments it is the length rather than the absolute numbers of neurites that was assessed.

Table 5 lists the mean number of neurites (\pm SEM) counted within each band for control and test explants.

4.6 RESULTS

TABLE 5 Mean numbers of neurites extending within three defined bands for control and test explants cultured in different continuously conditioned media.

<u>Control</u>	<u>Band 1</u>	<u>Band 2</u>	<u>Band 3</u>
<u>Explants</u>			
B	37.3 ± 5.83 (7)	30.8 ± 3.75 (7)	18.8 ± 3.42 (7)
SEPT	32.6 ± 1.67 (7)	28.7 ± 1.79 (7)	21.4 ± 3.5 (7)
RET	28.3 ± 2.79 (7)§	24.6 ± 2.39(7)§	14.0 ± 2.93(7)§

Number of neurites emerging from explants cultured in septum-conditioned media.

<u>Test</u>	<u>Band 1</u>	<u>Band 2</u>	<u>Band 3</u>
<u>Explants</u>			
B	30.3± 2.11 (9)	8.6 ± 2.54 (9)*	0.6 ± 0.16 (9)*
SEPT	37.5 ± 2.32 (6)	35.7 ± 3.83 (6)	28.5 ± 4.05 (6)
RET	16.0 ± 3.27 (5)§*	9.4 ± 3.06 (5)§*	3.4 ± 1.91 (5)§*

Number of neurites emerging from explants cultured in superior colliculus-conditioned media.

<u>Test</u>	<u>Band 1</u>	<u>Band 2</u>	<u>Band 3</u>
<u>Explants</u>			
B	32.8 ± 2.73 (9)	15.2 ± 2.24 (9)*	3.88 ± 1.41 (9)*
SEPT	46.9 ± 2.96 (7)	41.0 ± 3.58 (7)	28.3 ± 4.07 (7)
RET	21.6 ± 2.16 (8)§	17.6 ± 2.28 (8)§	12.8 ± 2.07 (8)§

Number of neurites emerging from explants cultured in cortex-conditioned media.

<u>Test</u>	<u>Band 1</u>	<u>Band 2</u>	<u>Band 3</u>
<u>Explants</u>			
B	37.1 ± 1.96 (6)	14.8 ± 3.25 (6)*	2.3 ± 2.14 (6)*
SEPT	36.5 ± 1.92 (8)	25.1 ± 2.30 (8)	16.1 ± 3.56 (8)
RET	24.9 ± 0.73 (9)§	20.4 ± 0.67 (9)§	14.1 ± 0.59 (9)§

§ denotes neurites emerge as fasciculated bundles, * denotes a significant ($P < 0.05$) reduction in the numbers of neurites that extend within each band compared with controls. The figures in parenthesis indicate the number of explants examined.

In contrast to the results presented on pages 74 and 75 in which media which had been conditioned prior to culture with test explants, the results presented here demonstrate that the growth of these explants is selectively suppressed by continuous conditioning.

Septum-conditioned media

Neurite outgrowth from olfactory bulb explants was inhibited in septum-conditioned medium. Only 2% of olfactory bulb neurites that emerged from explants cultured in septum-conditioned medium extended as far as band 3, and 28% as far as band 2 compared with 50% (band 3), and 82% (band 2) of those which emerged from olfactory bulb controls. The inhibitory effect on an olfactory bulb explant cultured in septum-conditioned medium is shown in figure 2.6 B.

Retinal neurite outgrowth was inhibited in septum-conditioned medium. Only 21% of retinal neurites that emerged from explants cultured in septum-conditioned medium extended as far as band 3, and 59% as far as band 2 compared with 49% (band 3) and 86% (band 2) for those which emerged from retinal controls. The number of neurites emerging from retinal explants within band 1 was also significantly reduced (to 43%) in the presence of septum conditioned-medium. The inhibitory effect on a retinal explant cultured in septum -conditioned medium is shown in figure 2.5 B .

Septal neurite outgrowth was unaffected in septum-conditioned medium. 76% of septal neurites that emerged from explants cultured in septum-conditioned medium extended as far as band 3 and 95% as far as band 2, compared with 65% (band 3) and 88% (band 2) of those which emerged from septal controls.

Cortex-conditioned media

Neurite outgrowth of olfactory bulb explants was inhibited in cortex-conditioned medium. 6% of olfactory bulb neurites that emerged from explants cultured in cortex-conditioned medium extended as far as band 3, and 40% as far as band 2 compared with 50% (band 3) and 82% (band 2) of those which emerged from olfactory bulb controls.

Retinal neurite outgrowth was unaffected in cortex-conditioned medium. 56% of retinal neurites that emerged from explants cultured in cortex-conditioned medium extended as far as band 3, and 81% as far as band 3 compared with 49% (band 3) and 86% (band 2) of those which emerged from retinal controls.

Neurite outgrowth from septal explants was not significantly affected in cortex-conditioned medium. 44% of septal neurites that emerged from explants cultured in cortex-conditioned medium extended as far as band 3 and 69% as far as band 2, compared with 65% (band 3) and 88% (band 2) of those which emerged from septal controls.

Superior colliculus-conditioned media

Neurite outgrowth of olfactory bulb explants was inhibited in superior colliculus-conditioned media. 11% of olfactory bulb neurites that emerged from explants cultured in superior colliculus-conditioned medium extended as far as band 3, and 46% as far as band 2 compared with 50% (band 3) and 82% (band 2) of those which emerged from olfactory bulb controls. The inhibitory effect on olfactory bulb explants cultured in superior colliculus -conditioned media is shown in figure 2.6 C.

Retinal neurite outgrowth was unaffected in superior colliculus-conditioned media. 59% of retinal neurites that emerged from explants cultured in superior colliculus-medium extended as far as band 3, and 81% as far as band 2 compared with 49% (band 3) and 86% (band 2) of those which emerged from retinal controls. A retinal explant cultured in superior colliculus-conditioned medium is shown in figure 2.5 C.

Septal neurite outgrowth was unaffected in superior colliculus-conditioned medium. 60% of septal neurites that emerged from explants cultured in superior colliculus-conditioned medium extended as far as band 3 and 87% as far as band 2 compared with 65% (band 3) and 88% (band 2) of septal controls. However, there was a significant increase in number of septal neurites emerging in band 1 from explants cultured in superior colliculus-conditioned medium compared with controls.

Figure 2.6 Phase contrast pictures of an olfactory bulb explant

Figure 2.5 Dark field pictures of a retinal explant cultured in septum-conditioned medium and in superior colliculus-conditioned medium.

(A) Control retinal explant

(B) Retinal explant cultured in septum conditioned media ; retinal growth is inhibited.

(C) Retina explant cultured in superior colliculus conditioned media ; retinal growth is unaffected.

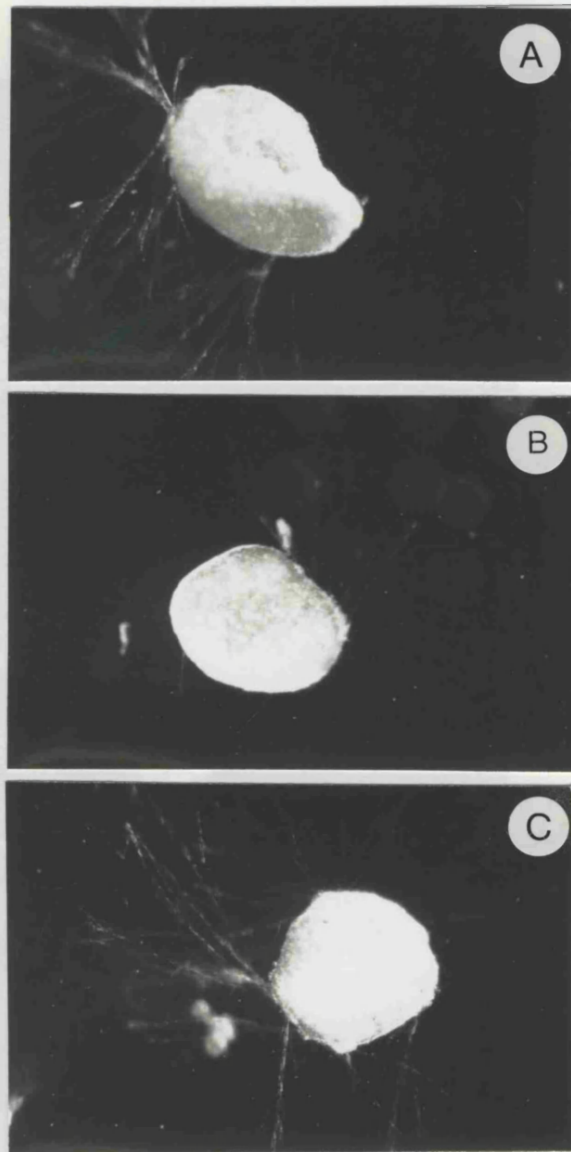
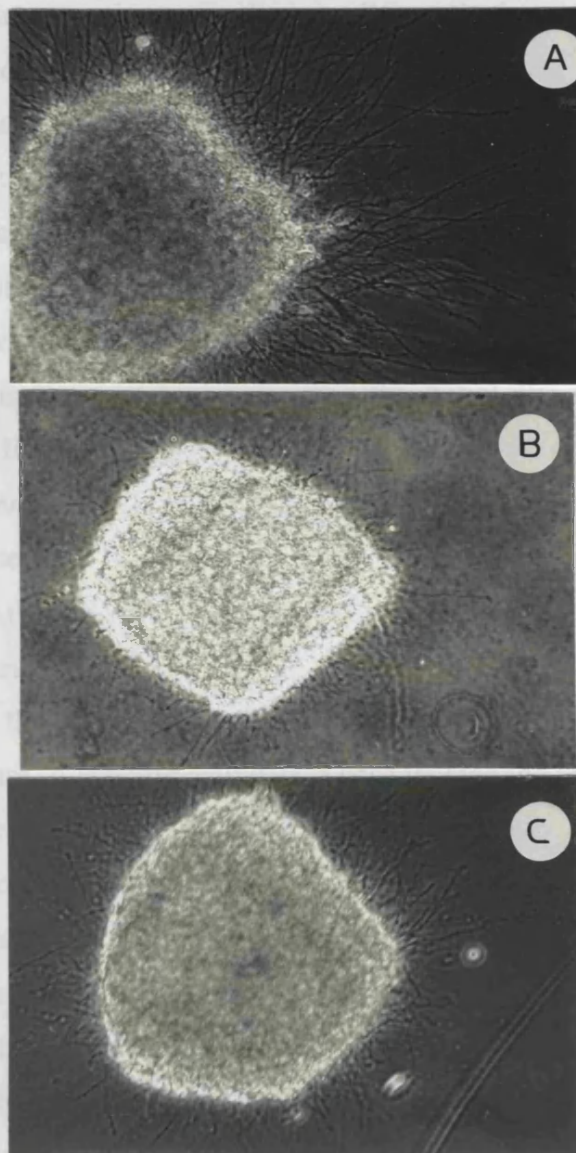

Figure 2.6 Phase contrast pictures of an olfactory bulb explant cultured in septum-conditioned and in superior colliculus conditioned media.

(A) Control olfactory bulb explant

(B) Olfactory bulb explant cultured in septum-conditioned medium, neurite outgrowth is inhibited.

(C) Olfactory bulb explant cultured in superior colliculus-conditioned medium, neurite outgrowth is inhibited.



4.7 DISCUSSION

The study was designed to reveal whether certain brain regions secrete diffusible inhibitory activity that differentially affects neurite outgrowth from other specific regions. For this purpose test explants of olfactory bulb, retina and septum were cultured in collagen gels in media continuously conditioned with pieces of cortex, superior colliculus or septum. These media contained activity which differentially inhibited the length of neurite outgrowth from specific test explants. The activities must be diffusible since conditioning tissues floated in the medium above the collagen gels in which the test explants were embedded, eliminating the possibility of contact between the tissues. The same tissue to culture medium ratio that was used previously to make preconditioned medium was also used to make continuously conditioned medium, and the conditioning period in both cases was the same (24 hrs). However, preconditioned media failed to inhibit neurite outgrowth from test explants confirming the original suggestion that conditioning tissues do secrete inhibitory activity into the medium but that this activity is inactivated or broken down. Because inhibition of neurite outgrowth is observed when medium is being continuously conditioned, the rate of secretion of inhibitory activity must be greater than the initial rate of its breakdown or rapid inactivation. In both preconditioned and continuously conditioned media the tissue pieces were incubated for the same (24hr) period. If the breakdown rates of inhibitory activity are the same in both cases (a reasonable assumption) then it follows that the effects due to the continuously conditioned medium must have occurred well within the initial 24hr incubation period.

It is possible that the inhibitory effects of conditioned media are due to factors other than the release of specific activities. These include the release of non-specific toxic agents by the conditioning tissue, the depletion of nutritive factors by conditioning tissues and changes in the pH of the conditioned media. There are compelling arguments against these possibilities. First, preconditioned medium which was made in an identical fashion to continuously conditioned medium did not affect neurite outgrowth from test explants. This argues against non-specific toxic effects, depletion of essential nutrients by the conditioning tissues and detrimental changes in pH.

Secondly, test tissues were differentially affected. In each experiment, three test tissues

were grown in collagen gels in the presence of the same conditioned medium, yet in all cases only one or two test tissues were inhibited. For instance, superior colliculus-conditioned medium contains activity which is active against olfactory bulb neurites but not against retinal or septal neurites. In no case did any conditioned medium inhibit all three test explants, further arguing against non-specific toxic effects. Finally, the possibility that inhibition occurs as a consequence of changes in pH of the conditioned media was excluded by continuous measurement of pH by reference to sensitive colourimetric indicators.

In the co-culture experiments described in chapter three, inhibition was defined as a reduction in the number of neurites, whereas in the present experiments, inhibition is defined as a reduction in the length of neurites. The results in both co-culture and conditioned media are largely consistent. Where numbers of neurites were reduced in co-culture, neurite length were reduced in conditioned media. For instance, in co-culture, cortex, superior colliculus and septum all inhibited neurite outgrowth from olfactory bulb explants. Similarly, cortex-, superior colliculus- and septum-conditioned media all inhibited neurite outgrowth from olfactory bulb explants. The septum inhibited retinal neurite outgrowth in co-culture, similarly retinal neurites were inhibited in septum-conditioned medium. Taken together, the results from both co-culture and the conditioned medium experiments are consistent with the hypothesis that different regions in the developing brain secrete distinct inhibitory activities. The results of the co-culture and conditioned medium experiments are summarised in the flow diagrams in figs 2.7A and B below.

Figure 2.7A :

Conditioned media experiments

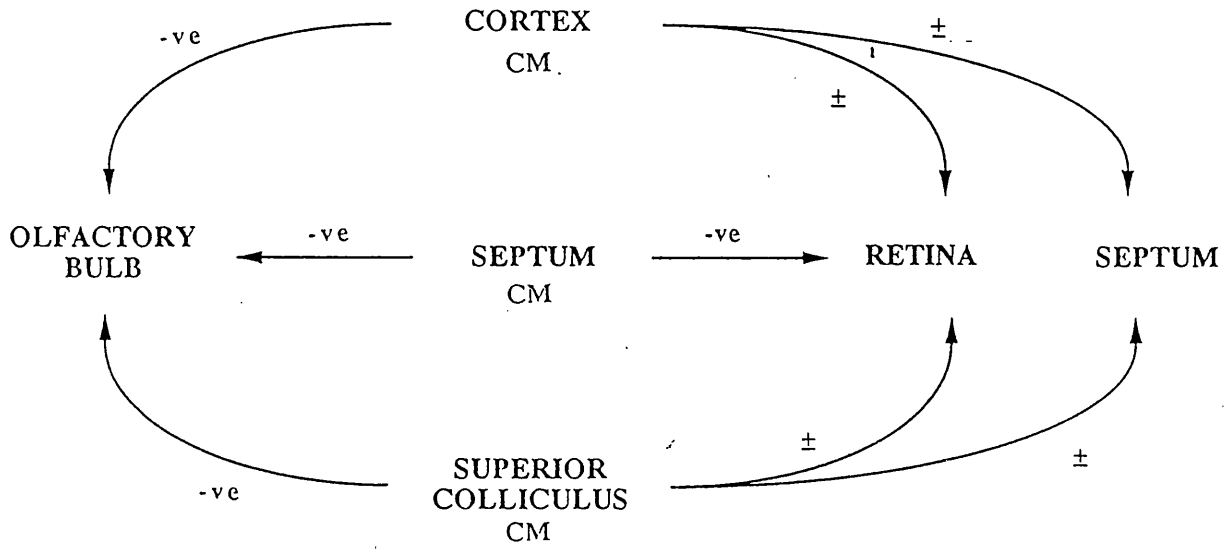
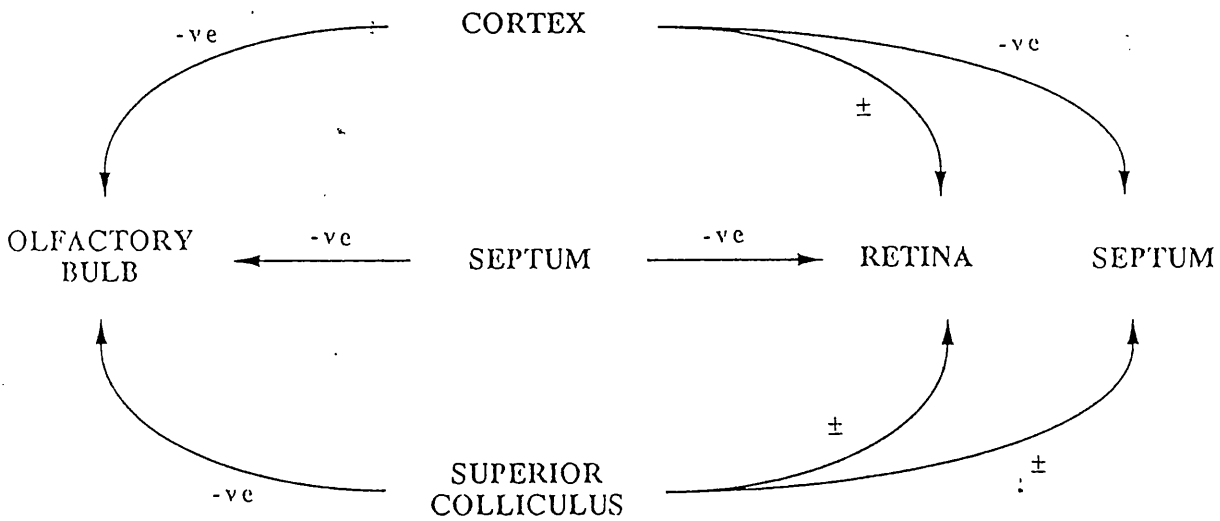

Figure 2.7B :

Co-culture experiments



-ve denotes inhibition of neurite outgrowth, ± denotes no effect on neurite outgrowth, and +ve denotes an increase in neurite outgrowth compared with controls.

In conditioned media, in contrast to co-culture, it is the length rather than the numbers of neurites emerging from test explants which is affected. This raises the question of whether these are related measurements of the same underlying phenomena. Given the complementarity between the length and number parameters, it is reasonable to assume they are. The proximity of the explants in the co-culture experiments will probably result in a locally high concentration of inhibitory activity around the test explants compared with that in conditioned medium. If so, then the differences of neurite outgrowth may simply be a function of concentration. Thus in co-culture, the length of neurites would be reduced to such an extent that they do not emerge from explants and are therefore not counted.

The number of inhibitory activities present in different conditioned media is unknown, however taken together the results demonstrate that different brain regions secrete distinct diffusible inhibitory activities. Conditioned medium may provide a useful means of obtaining secreted activities in sufficient quantity for biochemical studies.

CHAPTER FIVE

Developmental regulation of neurite outgrowth-inhibitory activity

5.1 INTRODUCTION

The study was designed to test the hypothesis that the secretion of growth-inhibitory activity within the embryonic brain is developmentally regulated, that is, it changes as a function of developmental age. It is known that chemorepulsive effects due to the septum (Pini 1993) and ventral spinal cord (Fitzgerald et al. 1993) are maximal at E15 and are undetectable by E18. I therefore decided to examine whether those brain regions which I have shown to secrete inhibitory activity at E15 continue to do so at E18. The hypothesis was tested by co-culturing E15 test explants with E18 explants which are known to secrete inhibitory effects at E15 .

5.2 PROTOCOL

The experiments were designed to determine whether septal and superior collicular explants which secrete inhibitory activity at E15 continue to do so at E18.

The experimental procedure was as for the isochronic co-culture experiments except that in this case the flanking explants in each gel were obtained from tissues from E18 embryos . Each gel therefore contained a central E15 explant flanked on either side by an E18 explants.

Table 6 : Combinations of E15 and E18 tissues co-cultured.

Flanking Tissue	Test Tissue	Flanking tissue
E18 SC	E15 B	E18 SC
E18 SEPT	E15 B	E18 SEPT
E18 SEPT	E15 RET	E18 SEPT
E18 SC	E15 RET	E18 SC

Analysis of neurite outgrowth

Neurite outgrowth from test and control explants was measured quantitatively by counting the number of neurites emerging within 40% of the circumference of each explant. Growth-inhibition refers to a significant reduction (evaluated by Student's t test) in the numbers of neurites emerging from 40% of the circumference of test explants compared with controls. Neurites formed from collateral branches were not counted (as for isochronic co-culture results).

Table 7 lists the mean numbers of neurites (\pm SEM) for control and test explants growing within the given circumference for each explant.

5.3 RESULTS

Heterochronic co-culture experiments

Table 7. Mean numbers of neurites emerging from control explants and test explants co-cultured with different E18 explants.

<u>Control</u>	<u>no of explants</u>	<u>mean no. of neurites</u>	<u>SEM</u>
E15 RET	7	4.9	1.11
E15 B	16	21.3	2.10

<u>Configuration</u>	<u>no of explants</u>	<u>mean no. of neurites</u>	<u>SEM</u>
E18SC E15RET E18SC	12	12.1*	1.61
E18SEPT E15RET E18SEPT	11	8.2	2.00
E18SC E15B E18SC	15	19.4	3.10
E18SEPT E15B E18SEPT	12	18.5	1.77

* denotes a significant ($p < 0.01$) increase in numbers of neurites extending compared with controls.

Neurites first began to appear from E15 control and E15 test explants after 24hrs of culture. By 48hrs, control and test explants had extended many neurites radially, which were not in contact with those of the flanking explants which themselves extended relatively few neurites.

E18 septum flanking explants

Unlike the inhibitory effect of E15 septal explants, E18 septal explants had no effect on neurite outgrowth of E15 olfactory bulb explants. However, in contrast to the significant inhibition of growth of E15 retinal neurites by E15 septum described in chapter three, E18 septum was without effect.

E18 superior colliculus flanking explants

Unlike the inhibitory effects of E15 superior collicular explants on E15 olfactory bulb described in chapter three, E18 superior colliculus had no significant effect on the growth of these neurites. When co-cultured with retina, E18 superior colliculus enhanced neurite outgrowth from retinal explants by 146% while E15 superior collicular explants had no effect on E15 retinal neurite outgrowth (described in chapter three). These results are shown in figure 3.1 B and C.

Figure 3.1 Dark field pictures of retina explant co-cultured with E15 and with E18 superior colliculus.

(A) Control retina explant

(B) Retina explant co-cultured with E15 superior colliculus; retinal neurite outgrowth is unaffected. Flanking tissues are not shown.

(C) Retina explant co-cultured with E18 superior colliculus; retinal neurite outgrowth is enhanced. Flanking tissues are not shown.

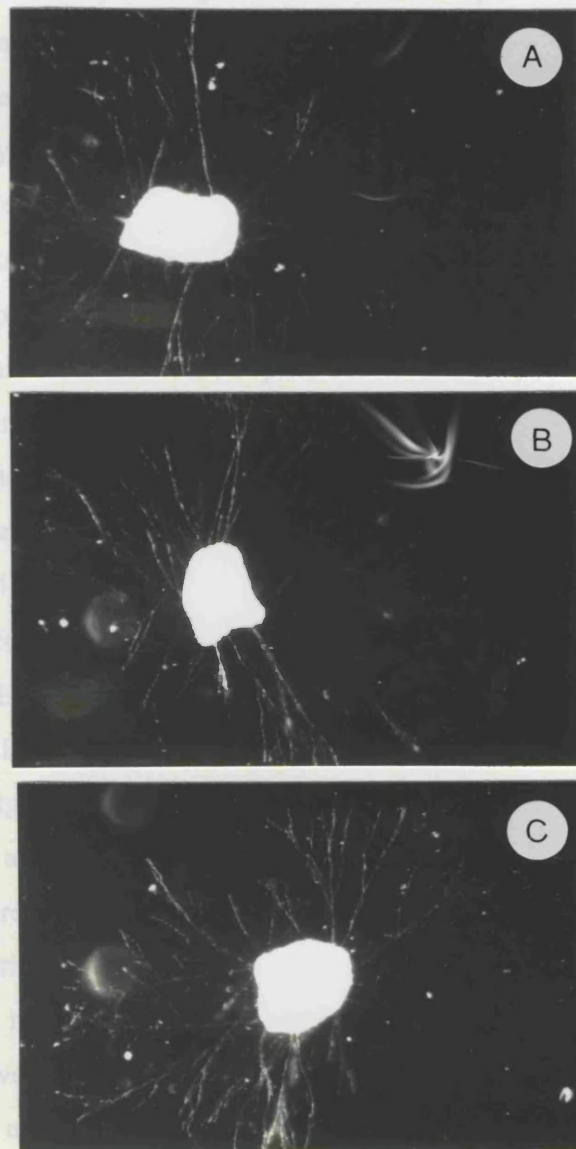

5.4 DISCUSSION

In heterochronic co-culture experiments, tissues known to secrete inhibitory activity at E15 were chosen as flanking explants, but now aged E18, in order to test specifically for the secretion of inhibitory activity as a function of developmental age. Both E15 septum (Pini 1993) and E15 superior colliculus inhibit neurite outgrowth from olfactory bulb explants. In addition, E15 septum inhibits neurite outgrowth from retinal explants while E15 superior colliculus has no effect. Hence E18 explants of these tissues were co-cultured with E15 olfactory bulb and retinal explants to determine whether they continue to secrete inhibitory activity at E18. Both E18 septum and superior colliculus failed to inhibit olfactory bulb and retinal neurite outgrowth, suggesting that these tissues either stop secreting, or secrete inhibitory activity at very low levels by E18. The loss of inhibitory effect may not be due to the lack of secretion of inhibitory activity but rather the secretion of additional growth-promoting factor(s) which would conceal any inhibitory effects. The enhancement of retinal neurite outgrowth as a result of co-culture with E18 superior colliculus is certainly suggestive of the release of additional trophic factors. Brain derived neurotrophic factor (BDNF) is a good candidate to mediate this effect since it has been shown to promote the survival and differentiation of rat and chick retinal ganglion cells (Johnson et al. 1986, Thanos et al. 1989, Rodriguez-Tebar et al. 1989). Moreover, BDNF mRNA has been detected in the tectum (Herzog et al. 1994), and retinal ganglion cells express high levels of the BDNF receptor *trk B* (Ernfors et al. 1992, Biffo et al. 1994). Taken together these findings suggest that BDNF is a major neurotrophic agent for retinal ganglion cells and thus its possible release by E18 superior collicular explants may account for the enhancement of retinal neurite outgrowth. This observation is coincident with the time of the arrival of the first afferent axons in the tectum (Lund and Bunt 1976). Interestingly, at E15 when these axons are confined to the optic stalk, superior collicular explants had no effect on retinal neurite outgrowth. These results are consistent with the idea that target structures begin to release growth factors at the time of their first innervation by afferents. Alternatively, at older developmental ages, these neural tissues may stop secreting inhibitory activity, so that the observed increase in retinal neurite outgrowth may reflect the reactions to normal levels of BDNF (or/and other growth factors) in the

absence of inhibitory activity. This result requires further investigation and it will be important to determine whether these growth promoting effects of E18 tissue can be blocked with BDNF and/or other growth factor antagonists. Moreover, it will be particularly interesting to repeat these experiments using material derived from transgenic null mutants of both receptor and protein.

Figure 3.7A and B below are flow diagrams summarising the relevant tissue interactions for isochronic co-culture and heterochronic co-culture experiments.

Figure 3.2 a : Isochronic co-culture experiment.

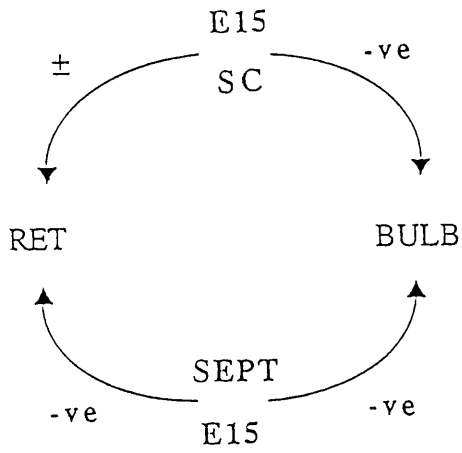
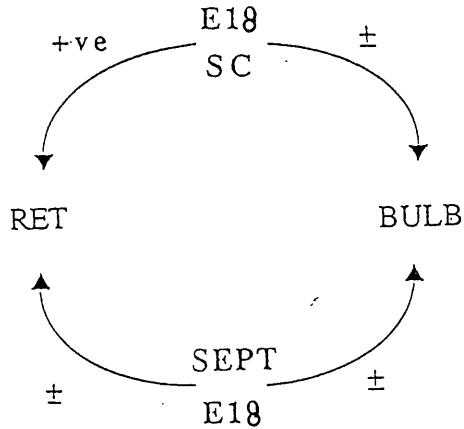

Figure 3.2 b : Heterochronic co-culture experiment.



-ve denotes a significant inhibition of neurite outgrowth, +ve denotes a significant increase in neurite outgrowth and \pm denotes no effect on neurite outgrowth.

If the role of inhibitory chemorepulsive activity in the developing brain is to steer early developing axons away from inappropriate territory, then it would be sensible to predict that the secretion of inhibitory activity by these tissues will decline with age as neurites are beginning to innervate their targets. Taken together the results strongly indicate that chemorepulsive affects decline with age and thus appears to be developmentally regulated; however it is unclear whether this is due to reduction in the secretion of inhibitors and/or the secretion of growth factors.

CHAPTER SIX

Biochemical studies

6.0 INTRODUCTION

Cells may communicate with each other directly via molecular interactions at the cell surface or indirectly through the release of secreted molecules. Cultured cells, and self-propagating cell lines in particular, can provide useful sources of material for the isolation of these factors. I have previously demonstrated that activity which is inhibitory to neurite outgrowth is secreted into defined medium by brain explants. This conditioned medium might provide convenient material from which to attempt to isolate secreted inhibitory (cell) products. Many growth factors are active in picomolar concentrations but scarce in their source material. Similar conditions will probably apply to growth-inhibitory factors thus making the possibility of isolation from millilitre amounts of conditioned medium unlikely. Nonetheless, studies on conditioned medium may be important because they could provide information about the properties of these activities, which will be valuable when attempting to isolate inhibitory factors from more substantial sources such as whole brain.

The aim was therefore to determine parameters required for isolation by estimating the molecular weight range of inhibitory activities in conditioned media. This was done by taking two experimental approaches. The first involved the use of known molecular weight cut-off dialysis membranes and the second, protein separation by SDS gel electrophoresis.

PART 1 : Estimation of molecular weight-ranges of inhibitory activities in superior colliculus-conditioned media using dialysis membranes.

Having shown that inhibitory activity in conditioned media is rapidly inactivated, I developed a method of continuous conditioning which demonstrated the existence of specific secreted growth-inhibitory activities. This work now made it possible to design a novel technique by which the molecular weight ranges of these activities could be estimated during continuous conditioning. It involved the use of a culture device constructed from two perspex blocks by Bruce Cotsell of the department of Physiology at UCL (shown in fig 4.1). A 2cm diameter well was drilled in the centre of the lower block to give a volume of 2.5mls while a hole 1cm deep and 2cm in diameter was drilled through the centre of the upper block. A double chambered configuration is obtained when a membrane is placed over the well of the lower block and the upper block is secured over it. Thus it was possible to culture test explants in the lower chamber which was separated by a dialysis membrane from continuously conditioned medium contained in the upper chamber. By using cellulose ester dialysis membranes which exclude solutes of different molecular weights, it is then possible to estimate the molecular weight-ranges of inhibitory activities deriving from particular conditioned media. Furthermore, a variety of test explants could be cultured simultaneously in the lower chamber and thus act as controls for specific activities.

Figure 4.1 :

Diagram of test chamber

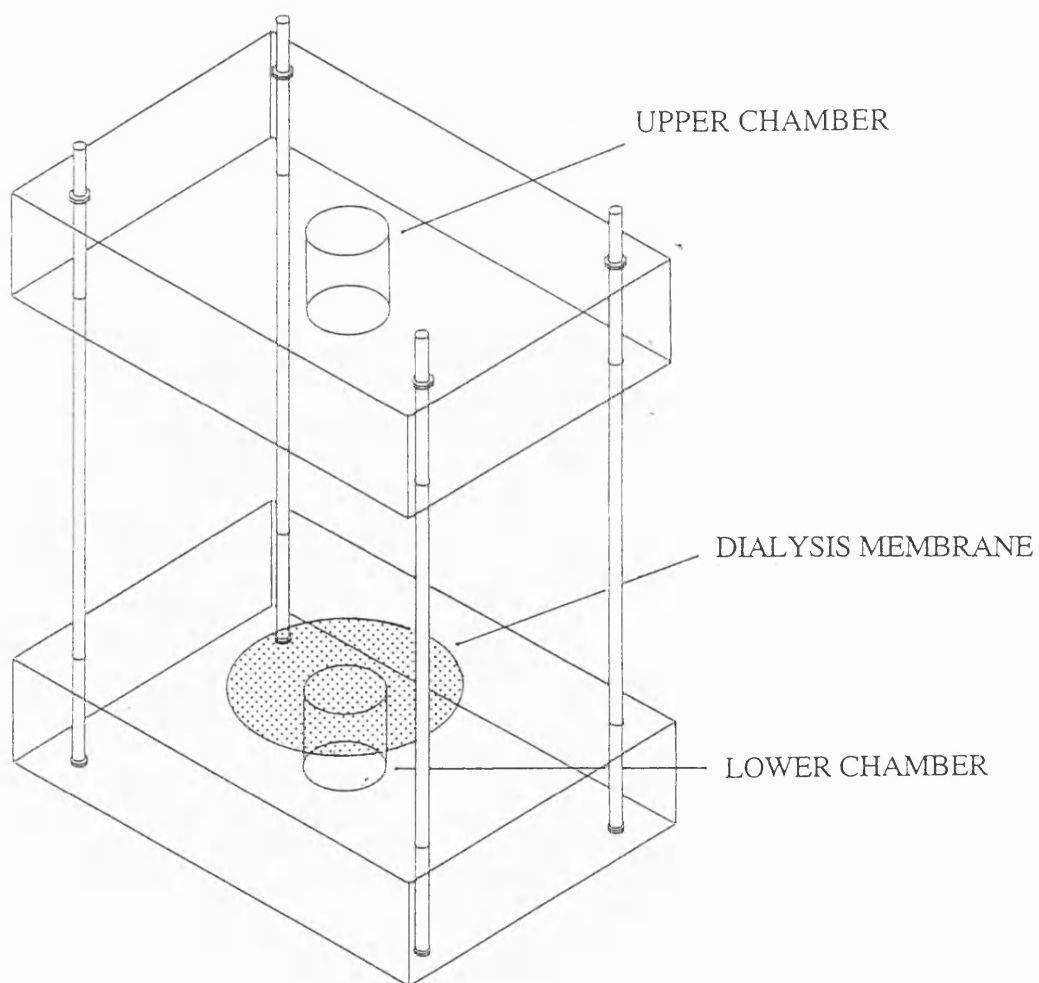

6.11 PROTOCOL

(i) Primary culture conditions (day 1)

Test explants (olfactory bulb and septum) were embedded into collagen gels on a small round sterile glass coverslip (diameter 16mm), and allowed to set in a culture dish on a warm surface. Conditioning tissues (5 superior colliculi) were cut into small pieces (as previously described) and transferred with a pipette into a 2ml Eppendorf tube and kept on ice. The explants were allowed to settle for 20 mins after which excess dissecting medium was removed and replaced with 1ml culture medium.

The two halves of the chamber were washed with deionised water, sterilized in 70% alcohol and allowed to dry. The dialysis membranes which were stored in a solution containing 0.1% sodium azide and washed for 20 minutes in 50mls of deionised water and then rewashed in 50mls of fresh deionised water before use.

Once the collagen gels on the glass slide had set, the slide was put into the lower chamber. This was then slowly filled to its capacity (2.5mls) with defined cultured medium. The washed dialysis membrane was then carefully placed over the top of the well of the lower chamber. The upper perspex half was then placed directly over it and screws were tightened carefully to give a water-tight seal without damaging the membrane; bulldog clips were then applied. Checks were made to ensure that medium did not leak and that there were no air bubbles were present. 1ml of medium containing the conditioning explants was put into the top chamber which was then covered with a culture dish lid. The whole test chamber was incubated for 24hrs. Control test explants were similarly put into collagen gels on glass slides and cultured a test chamber in defined medium for the same duration.

The convention used with respect to the exclusion properties of dialysis membranes is termed cut-off and is prefixed by a molecular weight. This indicates that solutes of molecular weight greater than the cut-off value will be excluded. Thus in the experimental results presented in fig 4.1, only solutes of molecular weights less than the various cut-off values are able to pass into the lower chamber containing the test explants.

(ii) Secondary culture conditions (day 2)

After 24hrs, the 1ml of conditioned medium was removed from the upper test chamber and spun for 5mins at 6,000g in a standard bench top centrifuge (Spectra) to remove all cellular debris. The supernatant was returned to the upper chamber and the whole test chamber was reincubated for a further 24hrs.

(iii) Observation and recording of results (day 3)

To observe test explants, the glass slide was removed from the lower chamber and put into a culture dish containing 3mls of fresh MEM / hepes. The explants were then observed under a phase contrast microscope at X4 and X10 magnification and photographed.

Analysis of neurite outgrowth from explants cultured in conditioned media.

The explant border and the whole length of each neurites emerging from a representative 40% of the circumference of the explant was traced. For statistical analysis, explants were approximated to a circle and neurite outgrowth was measured quantitatively by counting the numbers of neurites extending within three defined bands around the explants. These bands corresponded to 25% (band1), 50% (band 2) and greater than 50% (band 3) of the width of the explant. Growth-inhibition refers to a significant reduction (evaluated by Student's t test) in the number and percentage of neurites that extended beyond band 1 compared to controls.

Table 8 shows the mean numbers of neurites (\pm SEM) counted within each band for control and test explants cultured in test chambers with different molecular weight cut-off dialysis membranes.

6.12 RESULTS

TABLE 8. Mean numbers of neurites extending from control and test explants cultured continuously in dialysed superior colliculus-conditioned medium.

<u>Control</u>	<u>Band 1</u>	<u>Band 2</u>	<u>Band 3</u>
<u>Explants</u>			
B	26.41 ± 4.2 (9)	24.3 ± 3.7 (9)	17.0 ± 2.4 (9)
SEPT	36.6 ± 1.7 (7)	36.4 ± 2.1 (7)	34.3 ± 5.5 (7)

Numbers of neurites emerging from explants cultured in superior colliculus-conditioned media.

<u>Explants</u>	<u>Band 1</u>	<u>Band 2</u>	<u>Band 3</u>
B	21.1 ± 1.9 (10)	5.25 ± 1.1 (10)*	1.80 ± 2.1 (10)*
SEPT	35.1 ± 1.3 (7)	33.9 ± 3.6 (7)	31.3 ± 2.4 (10)

Numbers of neurites emerging from explants cultured with 15KDa cut-off membranes.

<u>Explants</u>	<u>Band 1</u>	<u>Band 2</u>	<u>Band 3</u>
B	25.4 ± 1.13 (10)	21.7 ± 2.23 (10)	13.7 ± 2.6 (10)
SEPT	30.3 ± 3.12 (7)	26.5 ± 4.2 (7)*	10.16 ± 3.7 (7)*

Numbers of neurites emerging from explants cultured with 25KDa cut-off membranes.

<u>Explants</u>	<u>Band 1</u>	<u>Band 2</u>	<u>Band 3</u>
B	14.7 ± 3.43 (9)*	9.6 ± 2.4 (9)*	4.75 ± 1.31 (9)*
SEPT	29.2 ± 3.16 (8)	24.6 ± 2.8 (8)*	11.3 ± 3.17 (8)*

Numbers of neurites emerging from explants cultured with 50KDa cut-off membranes.

<u>Explants</u>	<u>Band 1</u>	<u>Band 2</u>	<u>Band 3</u>
B	10.7 ± 3.2 (16)*	4.1 ± 2.23 (16)*	1.3 ± 2.31 (16)*
SEPT	27.3 ± 1.88 (8)*	23.5 ± 1.22 (8)*	17.1 ± 3.41 (8)*

Numbers of neurites emerging from explants cultured with 100KDa membranes.

<u>Explants</u>	<u>Band 1</u>	<u>Band 2</u>	<u>Band 3</u>
B	13.0 ± 1.11(13)*	3.3 ± 4.2 (13)*	0.37 ± 3.6 (13)*
SEPT	28.5 ± 2.6 (8)*	26.1 ± 3.1 (8)*	17.0 ± 2.2 (8)*

* denotes a significant reduction ($p < 0.05$) in numbers of neurites extending within each band compared with controls.

Control explants cultured in test chamber in defined medium (without membrane).

64% of olfactory bulb neurites extended as far as band 3 and 92% as far as band 2. 94% of septal neurites extended as far as band 3 and 99% as far as band 2.

colliculus
Explants cultured in superior *colliculus*-conditioned media (in test chamber without dialysis membrane).

Olfactory bulb neurite outgrowth was inhibited in superior colliculus-conditioned medium. 8% of olfactory bulb neurites that emerged from explants cultured in superior colliculus-conditioned media extended as far as band 3 and 25% as far as band 2 compared with 64% (band 3) and 92% (band 2) of those which emerged from olfactory bulb controls.

Septal neurite outgrowth was unaffected in superior colliculus-conditioned medium. 89% of septal neurites that emerged from explants cultured in superior colliculus-conditioned medium extended as far as band 3 and 97% as far as band 2, compared with 94% (band 3) and 99% (band 2) of those which emerged from septal controls.

Explants cultured in the test chamber separated with a 15KDa dialysis membrane.

Olfactory bulb neurite outgrowth was not significantly affected in 15KDa dialysed superior colliculus-conditioned medium. 53% of olfactory bulb neurites that emerged from explants cultured in superior colliculus-conditioned medium extended as far as band 3 and 85% as far as band 2 compared with 64% (band 3), 92% (band 2) of those which emerged from olfactory bulb controls.

Septal neurite outgrowth was inhibited in 15KDa dialysed superior colliculus-conditioned medium. 34% of septal neurites that emerged from explants cultured in superior colliculus-conditioned medium extended as far as band 3 and 87% as far as band 2 compared with 94% (band 3), and 99% (band 2) of those which emerged from septal controls.

Explants cultured in the test chamber separated with a 25KDa dialysis membrane.

Olfactory bulb neurite outgrowth was inhibited in 25KDa dialysed superior colliculus-conditioned medium. 27% of olfactory bulb neurites that emerged from explants cultured in superior colliculus-conditioned medium extended as far as band 3, and 65% as far as band 2, compared with 64% (band 3), 92% (band 2) of those which emerged from olfactory bulb controls.

Septal neurite outgrowth was inhibited in 25KDa dialysed superior colliculus-conditioned medium. 38 % of septal neurites that emerged from explants cultured in superior colliculus-conditioned medium extended as far as band 3, and 84% as far as band 2 compared with 94 % (band 3), 99% (band 2) of those which emerged from septal controls.

Explants cultured in the test chamber separated with a 50KDa dialysis membrane.

Olfactory bulb neurite outgrowth was inhibited in 50KDa dialysed superior colliculus-conditioned medium. 13% of olfactory bulb neurites that emerged from explants cultured in superior colliculus-conditioned medium extended as far as band 3, and 38% as far as band 2, compared with 64% (band 3), and 92% (band 2) of those which emerged from olfactory bulb controls.

Septal neurite outgrowth was inhibited in 50KDa dialysed superior colliculus-conditioned medium. 63 % of septal neurites that emerged from explants cultured in superior colliculus- conditioned medium extended as far as band 3, and 86% as far as band 2 compared with 94 % (band 3), and 99% (band 2) of those which emerged from septal controls.

Explants cultured in the test chamber separated with a 100K dialysis membrane.

Olfactory bulb neurite outgrowth was inhibited in 100KDa dialysed superior colliculus-conditioned medium. 3% of olfactory bulb neurites that emerged from explants cultured in superior colliculus conditioned medium extended as far as band 3, and 25% as far as

band 2, compared with 64% (band 3), and 92% (band 2) of those which emerged from olfactory bulb neurites.

Septal neurite outgrowth was inhibited in 100KDa dialysed superior colliculus-conditioned medium. 60 % of septal neurites that emerged from explants cultured in superior colliculus-conditioned extended as far as band 3, and 91% as far as band 2 compared with 94 % (band 3), and 99% (band 2) of those which emerged from septal controls.

The effects of neurite outgrowth on an olfactory bulb explant cultured in 15KDa and 50KDa dialysed superior colliculus-conditioned media are shown in figure 4.2 .

Figure 4.2 Phase contrast pictures of an olfactory bulb explant cultured in superior colliculus-conditioned medium in a test chamber separated by two different molecular weight dialysis membranes.

(A) Control olfactory bulb explant

(B) Olfactory bulb explant cultured in superior colliculus-conditioned media ; neurite outgrowth is inhibited.

(C) Olfactory bulb explant cultured in test chamber with 15KDa dialysis membrane ; neurite outgrowth unaffected.

(D) Olfactory bulb explant cultured in test chamber with 50KDa dialysis membrane ; neurite outgrowth is inhibited.

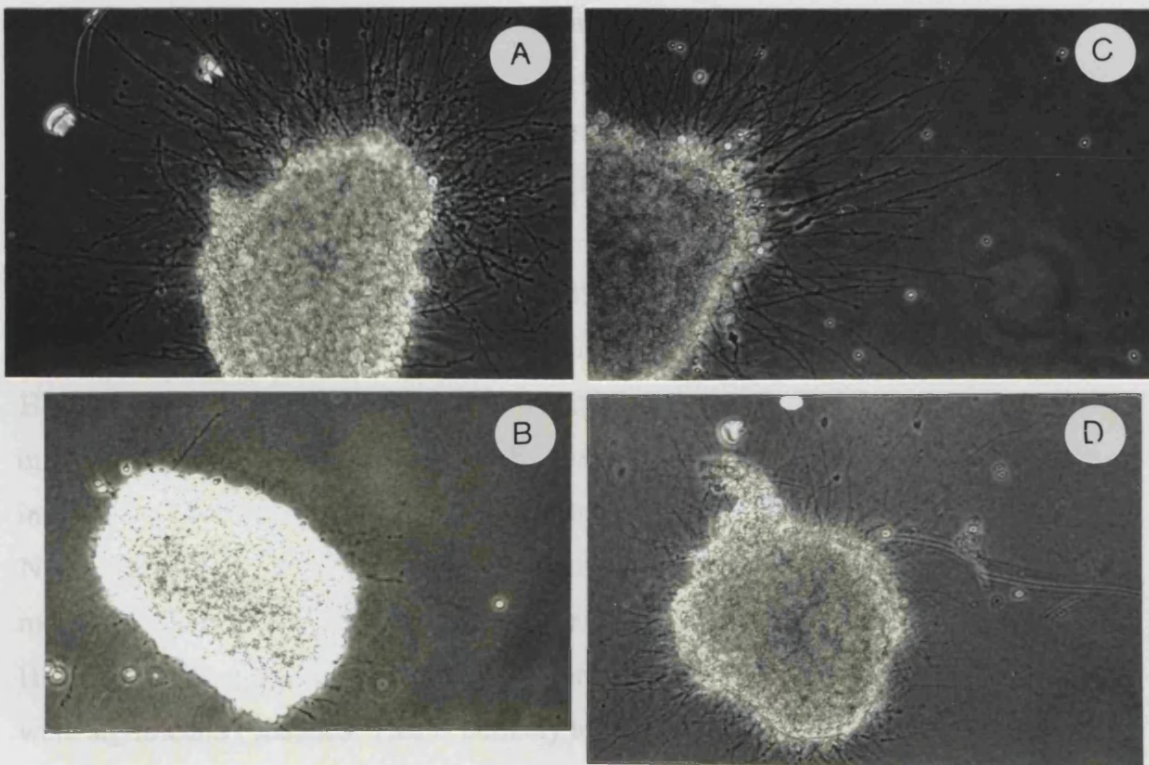

6.13 DISCUSSION

The experiments were carried out to determine the molecular weight ranges of inhibitory activities present in superior colliculus-conditioned media. The experimental design was such that a continuous supply of inhibitory activity was available for a period of 24 hrs. A test chamber was designed in which test explants were cultured in defined medium in the lower half separated by a dialysis membrane from superior colliculus-conditioned medium in the upper half. By using membranes with different molecular weight cut-offs, and observing neurite outgrowth from test explants, inhibitory activity could be assigned a molecular weight range. Membranes with molecular weight cut-offs of 15, 25, 50 and 100KDa were used, which allowed molecules with molecular weights lower than these values to pass through them. There were no significant differences in the inhibition of neurite outgrowth from olfactory bulb explants when cultured with 25, 50, or 100KDa membranes. However, inhibition was eliminated by the 15KDa cut-off membrane indicating that the molecular weight of this activity is above 15KDa and below 25KDa.

However, it is theoretically possible that the inhibitory activity is composed of factors with molecular weight less than 25KDa which pass through the membrane and then associate to form an inhibitory activity of molecular weight greater than 25KDa.

However, given current knowledge of the actions of growth modulatory molecules it is more probable that the observed inhibition resulted from the direct actions of an individual molecule(s) with molecular weight between 15 and 25KDa.

Neurite outgrowth from septal explants cultured in superior colliculus-conditioned media in the original conditioned media experiments (see chapter three) was unaffected. However in the presence of a dialysis membranes in these experimental, septal neurites were significantly reduced. This is unlikely to be due to the secretion of specific septal-inhibitory activity by superior collicular explants because this medium is not inhibitory in the absence of membranes. The most plausible explanations for inhibition of septal neurite outgrowth are likely to concern the membranes themselves. First, it is possible that they contain molecules which are toxic to nerve cells and which leach out during culture or that non-specific effects are due to the incomplete removal of sodium azide in which the membranes are stored. However, the importance of extensive washing of

cellulose ester dialysis membranes has been shown to be critical. In further experiments performed by Julia Nash in the laboratory, particular attention has been given to this problem. As cellulose ester membranes breakdown on boiling with EDTA (the standard method of treating non cellulose ester membranes to prevent leeching), she washes each membrane vigorously, over 4 to 5 cycles of 15 mins in 50mls of fresh deionised water. Following this procedure she has confirmed the presence of superior collicular derived factor(s) within a 15 to 25KDa molecular weight range which inhibits the outgrowth of olfactory bulb neurites but not that of septal neurites (Orike, Nash, and Pini, in preparation).

Notwithstanding the non-specific effects on septal neurite outgrowth, this work provides a new experimental approach to the identification of secreted inhibitory activities and strongly suggests the presence of a novel inhibitory factor(s) with a molecular weight between 15 to 25KDa. This observation is of particular interest, since the molecular weights of the two diffusible inhibitory molecules identified to date, netrin-1 and collapsin/sema III, are 78 and 100KDa respectively.

PART 2 : Separation of proteins by SDS gel electrophoresis

The last few years have seen the identification of diffusible inhibitors of neurite outgrowth. Somewhat predictably these have turned out to be proteins, namely the netrins and the collapsin/semaphorins. My experiments thus far (chapter 2) have shown that superior colliculus-conditioned medium contains activity which inhibits olfactory bulb neurite outgrowth. This activity is rapidly inactivated and has a molecular weight between 15 and 25KDa. It is possible that this activity, like the netrins and collapsin, is protein also. To examine this question, cortex- and superior colliculus-conditioned media were subjected to SDS gel electrophoresis.

6.21 PROTOCOL

The method used for separating proteins was based on the SDS-discontinuous buffer system originally described by Laemmli (1970) . In this method proteins are denatured by heat and with the detergent sodium dodecyl sulphate (SDS) and are then subjected to polyacrylamide gel electrophoresis. All electrophoresis was carried out in a Mini - Protean II electrophoresis cell (Biorad Ltd), which allows rapid analysis of protein or nucleic acid samples in miniature polyacrylamide gels. Gels were run at 20mA for approximately 1hr or until the dye front was 1cm from the end of the gel.

(i) Sample preparation

A total of 7mls of E15 and E18 cortex-conditioned medium and E15 and E18 superior colliculus-conditioned were made.

For E18 cortex-conditioned and E18 superior colliculus-conditioned media the experimental procedure was exactly as for E15 conditioned medium (previously described), except that the conditioning tissues were removed from E18 embryos. The amount of conditioning tissue used to make each conditioned media in these experiments was equivalent to the wet weight of tissue used to make the equivalent E15 conditioned media. Thus for E18 cortex conditioned medium - 0.040g wet weight of E18 cortex was added to 3.5mls of culture medium and for E18 superior colliculus conditioned media - 0.075g was added to 3.5mls.

Culture medium was conditioned for 24 hrs with these specific neural tissues as previously described and was then spun in a standard bench top centrifuge (Spectra) at

14,000g for 5mins to remove cellular debris, frozen to -70 °C for 24 hrs. The frozen conditioned media were then lyophilized for 36hrs and stored at -70 °C until required. Additionally, 7ml of each of these conditioned media were made as previously described, but this time after spinning the media were returned to the incubator and cultured for a further 48 hrs before being frozen, and then lyophilized. 0.5ul of 5-times concentrated sample buffer was added to each of the lyophilized samples and mixed thoroughly for 5mins. Just before loading, the samples were heated for 3mins in a bath of boiling water to ensure complete denaturation of proteins.

(ii) Preparing lower separating gel

The Mini-Protean II electrophoresis cell was assembled according to manufacturer's instruction, see materials for gel reagents.

The lower separating gel solution was prepared by combining all the reagents except ammonium persulphate (AMPS) and TEMED in a 20ml glass cylinder. Just before pouring the solution into the assembled gel sandwich, AMPS and TEMED were added, the solution shaken vigorously and poured between two glass plates. This was then quickly overlaid with a water-saturated isobutanol mixture. Gels were allowed to polymerize for approximately 1hr, after which the overlay solution was rinsed off with distilled water.

(iii) Preparation of stacking gel

All reagents of the stacking gel except AMPS and TEMED were combined and thoroughly mixed in a 20ml glass cylinder. AMPS and TEMED were added to the stacking gel solution and then overlaid above the separating gel. A spacer comb was inserted and positioned such that it was seated approximately 0.5cm above the separating gel. The gel was then allowed to polymerize for about 1hr.

(iv) Loading samples

300mls of running buffer were made by combining 30mls of 10 X electrode buffer with 270mls of distilled water. The gels were attached to the gel assembly unit and put into a gel tank. Approximately 115ml of running buffer was poured into the upper

chamber and the remainder in the lower chamber of the gel tank. Using a new tip for each loading, samples were then loaded into wells under the buffer with a hamilton syringe (15 ul per well). This volume was arrived at by trial and error and was the volume that gave the best resolution. The gels were calibrated by loading the first two wells with low and high molecular weight markers (Lmw and Hmw).

(v) Silver staining

Once run, gels were removed carefully from glass plates, put into a container and soaked in 50% methanol overnight. Before silver staining, gels were washed in distilled water and then in a solution containing 50:50 water/methanol and 100ul formaldehyde. Gels were then immersed in 50mls of silver staining solution (see materials) for 15mins and then washed in distilled water for 5mins. Developing solution was then added for 10mins or until bands appeared. Further development of the gels was stopped by washing with a 50% methanol / 10% acetic acid solution. Gels were stored in a solution containing 50% methanol, 10% acetic acid and 40% water until photographed.

6.22 RESULTS

At least 15 bands were observed in each of the conditioned media samples, ranging between 18 and 200K. There appeared to be no obvious differences in the banding pattern between each sample.

Figure 4.3 Picture of gels shown below.

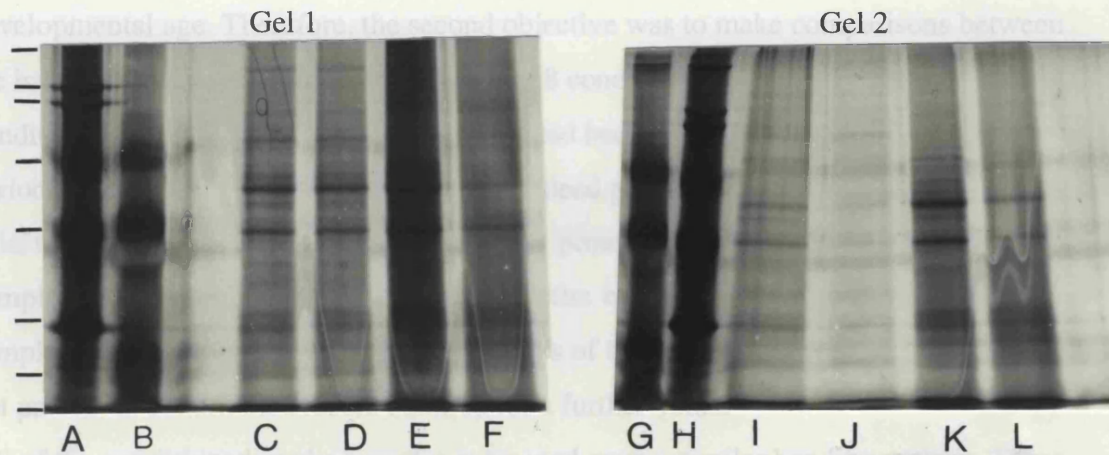

Gel 1 - Order of samples loaded :

A	B	C	D	E	F
Hmw	Lmw	E15 SCCM	E15 SCCM	E18 SCCM	E18 SCCM
		(24 hrs)	(78 hrs)	(24 hrs)	(78 hrs)

Gel 2 - order of samples loaded :

G	H	I	J	K	L
Lmw	Hmw	E15 CTXCM	E15 CTXCM	E18 CTX CM	E18 CTXCM
		(24 hrs)	(78 hrs)	(24 hrs)	(78 hrs)

SCCM denotes superior colliculus-conditioned media ; CTXCM denotes cortex conditioned media and the figure in brackets indicates the total culture period for each of the conditioned media made. Note that in the cases where conditioned media were cultured for 78 hrs, conditioning tissues were removed following the initial 24 hr culture period. Molecular weight markers indicated at the left hand margin are 205KDa, 116KDa, 97.4KDa, 66KDa, 45KDa, 29KDa, 24KDa, 18.7KDa from top to bottom.

6.23 DISCUSSION

E15 and E18 cortex- and superior colliculus-conditioned media were subjected to SDS polyacrylamide gel electrophoresis in order to determine first, whether these media contain any unique low molecular weight proteins, because my previous results (chapter 5) had shown diffusible tissue-specific inhibitory activity due to these regions. This inhibitory activity is rapidly inactivated and diminishes with increasing developmental age. Therefore, the second objective was to make comparisons between the banding patterns of E15 and equivalent E18 conditioned media, and between freshly conditioned media (24 hrs) and media which had been allowed to degrade over a further period of 48 hrs. If the inhibitory activity is indeed protein, and can be detected on SDS gels, then the expectation would be to observe protein bands in E15 conditioned media samples that are not present or reduced in the equivalent E18 conditioned media samples, and likewise protein bands in samples of freshly conditioned media which are not present in conditioned media cultured for a further 48hrs.

All of the conditioned media samples examined gave a similar banding pattern. These bands are likely to be due to the presence of secreted proteins since each sample was spun for 5mins at 14,000g before electrophoretic treatment. Since my previous experiments show that the secretion of inhibitory activity declined with developmental age and is rapidly inactivated, the observation that all the conditioned media examined appear to contain the same proteins, appears to infer that the inhibitory activity can not be protein. This may not be the case, however, it is likely that many of the apparently single bands are in fact made up of a number of proteins and thus subtle changes in banding patterns will not be detected unless these bands are further resolved. In addition, the failure to observe a significant difference in the banding patterns between the conditioned media samples may result as a consequence of the inhibitory activity being taken out of solution. Like collapsin and netrin, once secreted, the active molecule(s) may become rapidly attached to membranes and thus will not be freely distributed in the media.

There appear to be subtle differences in the intensity of some of the bands on the gels, possibly indicating that there maybe differences in protein concentration within each sample. However, at this stage no inference can be drawn about the relative

concentrations of the proteins in these bands because total protein content in each sample was not predetermined and therefore not standardised. The results clearly show that molecules with molecular weights between 18 to 25KDa appear to be present in these conditioned media, however at present, little inference can be drawn about the likelihood of these representing the inhibitory activity in the conditioned media. These results show that these conditioned media contain a complex distribution of proteins many of which are likely to be secreted. However, using whole conditioned medium does not give sufficient resolution to be immediately useful in further analysis. Given the result described in part I of this chapter, a logical next step would be to run SDS PAGE gels with E15 superior colliculus-conditioned medium which had been dialysed to exclude proteins below 15KDa and above 25KDa. In this way it might be possible to improve resolution such that active bands could be detected.

CHAPTER SEVEN

FINAL DISCUSSION

7.1 Background

The development of the nervous system follows a highly stereotyped pattern in which axons are guided with remarkable precision to their intermediate and final targets. The way in which this neural specificity is generated has been the subject of intense research. The key issues concern the nature of signalling cues which influence the rate and orientation of growth cone advance, the receptors that mediate these signals and the interactions with the cytoskeletal machinery that ultimately control growth cone motility. The research in this thesis is concerned with the first of these issues that is, the cellular and molecular mechanisms that govern growth cone guidance. Initially this was thought to be solely dependent on positive signalling mechanisms such as differential adhesion and chemoattraction which function to promote axon growth. Many cell adhesion and extracellular matrix molecules have now been identified and cloned which are differentially expressed and distributed along specific neural pathways *in vivo* (reviewed by Reichardt and Tomaselli 1991). Most of these molecules are thought to provide both permissive and growth-promoting substrata for developing axons but in addition, it is becoming increasingly clear that these molecules also perform signalling functions which operate through second messenger systems (Doherty and Walsh 1994). Similarly, chemoattractants act as positive guidance cues, since they too function to promote the growth of axons towards their targets (reviewed by Tessier-Lavigne and Placzek 1991). However, in contrast to cell adhesion and extracellular matrix molecules which are associated with cell surfaces, growth cones respond to soluble gradients of chemoattractants. An obvious question therefore, is do the molecules mediating these two guidance mechanisms translate their signals into the growth cone in the same way, or (more specifically), do they utilize the same class of receptors and affect the cytoskeletal machinery of the growth cone in the same manner? There is considerable evidence to suggest that both integrin (reviewed by Reichardt et al. 1989) and FGF receptors (Willams et al. 1994) mediate the signals of many cell adhesion and extracellular matrix molecules but nothing is known about those that mediate the signals of chemoattractants. This is primarily because up until very recently, no candidate

chemoattractants had been identified.

In addition to guidance mechanisms that involve the promotion of axon growth, strong evidence has emerged demonstrating that growth cones are also influenced by repulsive signals. As with positive guidance mechanisms, these may be mediated by contact (Davies et al. 1990, Raper and Kapfhammer 1990, Cox et al. 1990, Schwab et al. 1993) and through diffusion (Pini 1993, Fitzgerald et al. 1993, Guthrie and Pini 1995, Tamada et al. 1995 and Colamarino and Tessier-Lavigne 1995, Messersmith et al. 1995). Candidate chemorepellents that have recently been identified are, collapsin/sema III (Luo et al. 1993, Kolodkin et al. 1993) and netrin-1 (Serafini et al. 1995, Kennedy et al. 1995), while the repulsive axonal guidance signal (RAGS) is the only contact-repulsive signal cloned so far (Drescher et al. 1995).

Of critical importance in the discovery of both chemoattraction and chemorepulsion has been the development of a simple but robust *in vitro* assay system. This has involved the use of collagen gel matrices which provide a permissive substratum for axon growth and through which axons can be readily visualized (Ebendal and Jacobson 1977). More importantly, this matrix is able to stabilise gradients of soluble molecules so that the effect of such molecules secreted by one tissue on axon outgrowth of another can be examined (Lumsden and Davies 1983). In the demonstrations of both chemoattraction and chemorepulsion, explants have typically been co-cultured about 300 μ m apart in such matrices. By comparing the number and trajectories of axons extending from test explants, the effect of molecules acting in the form of a diffusion gradient secreted by the other co-cultured explant have been assessed.

7.2 Identification of distinct inhibitory activities

In order to examine the extent to which regions in the developing rat brain secrete chemorepulsive signals I have carried out similar studies using this assay system and demonstrated the existence of at least three distinct inhibitory activities. However, in my studies a single test explant from one brain area was co-cultured with two adjacent explants from another in order to maximize the concentration of chemorepulsive signal in the vicinity of the test explant. In so doing, determinations of the effect of source-to-sink gradients of inhibitory activity on axon trajectories could not be made because the

test explants were surrounded. This assay method therefore only assesses the secretion of inhibitory activity and is not a test for chemorepulsion.

Cortex, superior colliculus, septum and retina were all found to release inhibitory activity. These activities appear to be distinct, since each tissue secreted inhibitory activity which affected test tissues differentially. However, it is possible that these tissues secrete the same inhibitory activity and that the observed differential effects result as a consequence of the presence or absence of appropriate receptor(s) for the inhibitor on growth cones. This argument is unlikely since by definition any test tissue which is inhibited must possess the appropriate receptor(s) and should be inhibited by all tissues secreting inhibitory activity. Except for olfactory bulb neurites, this was not the case.

The initial demonstration of contact repulsion was based on the observation of how growth cones from anatomically different areas behave on contact with one another (Kapfhammer and Raper 1987a,b). It was from these studies that a growth cone collapse assay was developed which subsequently led the way for the first identification of a candidate *in vivo* chemorepellent, collapsin (Luo et al. 1993). Subsequently, sema III and other members of the semaphorin family, which includes collapsin, have been shown to have chemorepellent activity *in vitro* (Messersmith et al. 1995, Puschel et al. 1995). In a similar fashion to the experiments of Kapfhammer and Raper (1987) who sought to provide evidence for contact repulsion, most of the brain regions I have co-cultured were not anatomically related. This is because the purpose of these studies was to provide evidence for the existence of secreted inhibitory signals and to determine those regions which these signals affect. In a similar way to that of Kapfhammer and Raper, my approach has provided evidence for a phenomenon, namely growth suppression during development, and has given information which will be crucial to the the problem of bioassay of brain fractions.

It is not known from these studies precisely how these inhibitory activities affect axons or whether, if delivered in a suitable gradient, they will function as chemorepellents. In the experiments of Pini (1993), a source-to-sink gradient of activity secreted by single septal explants caused both chemorepulsion and inhibition of axon outgrowth (by

around 30%) from single co-cultured olfactory bulb explants. Moreover, when a single olfactory bulb explant was surrounded by two septal explants in an identical manner to the co-culture experiments described here, the numbers and lengths of axons emerging from the centrally positioned olfactory bulb explant were significantly reduced. However, Guthrie and Pini (1995) observed that the floor plate caused chemorepulsion of hindbrain and spinal motor axons, without suppression of axon growth. This may reflect differences in the concentration gradients of growth inhibitors which may also act as chemorepellents or may point to fundamental differences in the underlying mechanisms. This problem is unlikely to be resolved until factors which mediate the inhibitory effects observed in these experiments have been purified.

7.3 Conditioned media - a starting point for preliminary biochemical studies

A primary objective of this study has been to define the initial parameters required for the isolation of inhibitory activity. In order to do this, it was necessary to acquire a viable source of inhibitory activity. Since the results from the isochronic co-culture experiments provided information on those brain areas which secreted inhibitory activity, an appropriate tissue source could be selected. Preconditioned media were made in the traditional way using these tissues in the hope that they would contain secreted inhibitory activities which could subsequently be used for basic biochemical studies. However, when tested for their ability to inhibit neurite outgrowth, these conditioned media failed to do so. A likely explanation for this was that inhibitory activity was being secreted by conditioning tissues which became rapidly inactivated or degraded. Another possibility was that these inhibitory molecules possess highly positively charged terminal domains and thus bind readily to negative charges on cell surfaces, thereby removing them from the media. The first hypothesis appears to be correct because a revised method of making conditioned media in which test explants in collagen gels were cultured in medium with conditioning tissue proved to contain inhibitory activity. These media inhibited neurite outgrowth from specific test explants, consistent with the results from the isochronic co-culture experiments. The consistency of the results of conditioned media experiments with those of isochronic co-culture is

strongly suggestive of the action of the similar inhibitory factor(s) in both these assay systems. However, in conditioned media it is the lengths rather than absolute numbers of neurites extending from test explants that are affected. An explanation for this difference could be that the concentrations of inhibitory factor(s) in conditioned media were lower than those in the co-culture. Presumably because of the proximity of the explants in co-culture, there could well be a locally higher level of inhibitory activity acting on test explants. Measurements of neurite length may therefore represent a more sensitive assay of growth-inhibition. The effects of different concentrations of inhibitory activity on neurite outgrowth could be tested by comparing the lengths of test explants cultured in serial dilutions of conditioned media. Dilutions could be made by altering the tissue to culture medium ratio, either by increasing the proportion of culture medium or reducing the amount of tissue. In co-culture, the same end could be achieved by varying the distances between test and flanking explants.

As with the isochronic co-culture experiments, those using conditioned media assay for the secretion of neurite-inhibitory activity and not for chemorepulsive activity because in these experiments the inhibitory activity is not presented in a gradient. It may be possible to test conditioned media for chemotropic activity by examining neurite trajectories from test explants co-cultured in tandem with a point source of concentrated conditioned media. Regardless of whether the inhibitory activities in conditioned media are the same as those in co-culture, these experiments have demonstrated that different growth-inhibitory activities are secreted, present in conditioned media, and in principle these could be used for biochemical studies.

7.4 Molecular weight estimation of inhibitory activity in conditioned medium

The finding that inhibitory activity was not retained in pre-conditioned media posed a difficult problem with regard to the possibility of carrying out biochemical studies. It meant that simple direct tests, such as heat or trypsin treatment to test for the presence of proteins could not be done. Therefore to estimate the molecular weight range of inhibitory activities in superior- colliculus conditioned media, a new design of bioassay was required. This involved the development of a novel double chambered culture

device in which the two chambers were separated by cellulose ester dialysis membranes of varying molecular discrimination. Test explants were cultured in collagen gels in the lower chamber, while small pieces of superior collicular tissue were used to condition defined medium in the upper half of the chamber. In this way, a continuous supply of inhibitory activity was maintained for a period of 24 hr during which molecular weight estimations could be made by assessing neurite outgrowth from test explants following the use of different molecular weight cut-off membranes. Neurite outgrowth from test explants of olfactory bulb was equally inhibited when 25, 50 and 100KDa molecular weight cut-off membranes were used. However, neurite outgrowth was not inhibited in the presence of a 15KDa cut-off membrane indicating that the molecular weight of the inhibitory activity in superior colliculus conditioned media is between 15 and 25KDa.

The test chamber represents a useful and novel means of estimating the molecular weight ranges of biologically active molecules. It is particularly effective because it allows the simultaneous observation of the effect of neurite outgrowth from a variety of test explants, to provide an internal control for the presence of specific activities as well as estimations of their molecular weights. Clearly, it could be possible to use appropriate dialysis membranes to increase the precision of the molecular weight ranges for these activities. In addition, patterns of SDS PAGE gels of conditioned medium taken from lower and upper compartments of the test chamber after dialysis could be compared in order to look for significant changes in banding patterns that correlate with the effects of neurite outgrowth from test explants.

7.5 What is the chemical nature of the inhibitory activity in conditioned media ?

The next important question concerns the nature of the inhibitory activity in superior colliculus-conditioned medium. Collapsin and netrin-1, the two recently identified candidate chemorepellents are both proteins. Therefore as a first step, I considered the possibility that the inhibitory activity in superior colliculus-conditioned medium might also be protein. To examine this possibility, both cortex and superior colliculus-conditioned media were subjected to SDS-PAGE electrophoresis in order to establish

whether these conditioned media contained proteins with molecular weights between 15 and 25KDa. This was done by comparing the banding patterns of inactive and active conditioned media, and conditioned media made from E15 and E18 tissue, in order to detect protein bands that were present in one and not the other. To this end a 12% polyacrylamide gel was used since this would specifically separate proteins of molecular weights between 20 and 200KDa. Additionally, since the inhibitory activity is likely to be present in very low concentration in conditioned media, gels were stained with silver rather than Coomassie blue G-25 because protein visualisation by the former is 50 to 100 times more sensitive. Although the gels showed that conditioned media contained low molecular weight proteins, a comparison of the gel patterns of the different conditioned media revealed no obvious differences. The most probable reason for this could be the failure to achieve sufficient separation of proteins present in very small amounts. Resolving bands will involve the use of 2D gels, which would separate proteins according to their size and charge. The SDS PAGE experiments have demonstrated that secreted proteins in these conditioned media can be visualised and this in principle could provide a potentially useful means of identifying candidate inhibitory proteins, but further work will be required.

7.6 The inhibitory activity in superior colliculus-conditioned medium is novel

The inhibitory activity in superior colliculus-conditioned medium has a molecular weight(s) between 15 and 25KDa and thus a reasonable working assumption is that it is protein. Moreover, the result of the functional assays and molecular weight range estimation suggest that it is not collapsin or netrin-1 since they have molecular weights of 78 and 100KDa respectively. In addition, the superior colliculus-inhibitory activity is active against different sets of neurones. For instance, activity secreted by the superior colliculus in co-culture has no effect on the growth of retinal or NGF-responsive DRG neurones (Orike and Pini unpublished), whereas native collapsin/sema III inhibits both of these sets of neurones (Luo et al. 1993, Messersmith et al. 1995). In addition collapsin has no effect on olfactory bulb neurites (Raper personal communication) whereas the superior colliculus secretes activity which is inhibitory to these neurones.

The floor plate expresses netrin-1 (Kennedy et al. 1994) and inhibits retinal neurites (Pini unpublished) whereas the superior colliculus has no effect on retinal neurites. Taken together, this evidence strongly indicates that inhibitory activity secreted by the superior colliculus is distinct from collapsin and netrin-1 and therefore represents the identification of a novel inhibitory activity.

7.7 How does this inhibitory activity bring about inhibition of neurite extension ?

Both collapsin and RAGS cause the collapse of specific growth cones. Growth cone collapse begins with the retraction and reabsorption of the lamellipodia and filopodia, which is rapidly followed by the collapse of the growth cone. The growth cone becomes paralysed and consequently the axon is unable to extend (Kapfhammer and Raper 1987a). In neither the isochronic co-culture experiments or conditioned experiments were the effects on individual growth cones assessed and thus it has not been possible to ascertain whether these inhibitory activities cause growth cone collapse. This issue could be resolved by using the Raper and Kapfhammer (1990) growth cone collapse assay.

An important issue concerns the function of antigrowth factors and collapse-inducing factors in CNS development. Specifically, can antigrowth factors be ascribed a role in axon guidance. By creating 'no go' areas for axonal extension, antigrowth factors may simply function to prevent axons from innervating inappropriate territory. Alternatively, they could act to stop axons or terminate their unwanted branches. This model could involve growth cone collapse, such that when the growth cone reaches a critical boundary level of antigrowth factor(s) it becomes collapsed and is consequently halted from progressing further. Antigrowth factors may have a more specific role in CNS development acting as guidance cues. In this model, antigrowth factors would have to be presented in the form of a gradient. Growth cones confronting a gradient of antigrowth factors would reorient, turning in order to grow down gradient, or turn when they encountered a critical threshold concentration of antigrowth factor. Alternatively, growth cones may exhibit partial collapse and steer down-gradient away from the source of the antigrowth activity. This notion is not without precedent. Fan

and Raper (1995) have recently shown that growth cones of dorsal root ganglion cell axons are only partially collapsed on contact with beads coated with collapsin, and are able to steer away from it. In this way, specific corridors of gradients of antigrowth factors could channel axons to their appropriate targets.

Which ever means these growth inhibitory factors function in guidance, they will require receptors on growth cones to convey their signals intracellularly. Both a G protein-coupled receptor (Igarashi et al. 1993) and tyrosine receptor kinases of the Eph family (Cheng et al. 1995) have already been implicated in mediating the effects of collapsin and RAGS respectively. No doubt with the characterization of growth inhibitory factors, many other receptors will be added to this list. These signals will have to affect the cytoskeletal machinery in order to inhibit growth cone extension. Collapsin has been shown to prevent actin polymerisation at the leading edge of growth cones (Fan et al. 1993), so it is possible that the growth inhibitory factor(s) in superior conditioned media acts similarly.

7.8 What is the function of chemorepulsion in the developing nervous system ?

It is clear that all guidance cues must signal via the cell membrane and that these cues arise both within the immediate vicinity of this membrane and from more distant sources. If growth cones respond selectively to cues which are fixed in the environment then what might be the role of additional diffusible cues. Cajal first suggested that certain regions might attract axons towards them by releasing diffusible factors. This, in principle, could provide a means of bringing about specific axon-target matching when the target is situated at a distance. Similarly, selectivity of innervation could also be achieved by actively excluding axons from certain territories. Again if the repellent were diffusible, this would allow the effect to occur over a distance. In both cases a gradient of some diffusible factor would be formed which would provide information that could be 'read' by the growth cone. However, guidance along distributed gradients could be, and probably is achieved during development by non-diffusible mechanisms. For example the cell-surface ligand, ELF-1, is distributed in a gradient across the tectum which is complimentary to that of its receptor, Mek-4, in the retina. It now seems very

probable that the graded antero-posterior retino-tectal distribution of axons occurs by this or a very similar mechanism. It is unclear whether these gradients of cell surface expression are in any way determined by the operation of diffusion gradients of other molecules. Furthermore, it is unknown whether gradients of diffusible molecules act haptotactically to produce a graded series of changes in cell surface properties which would affect their interactions with growth cones. Thus it appears that graded alterations in the cellular and extracellular environment can be caused by mechanisms that involve cell contact and those that involve diffusion of soluble molecules. Moreover, it appears that both of these are employed during axon guidance, and that both may bring about attraction and repulsion and/or interact simultaneously. Once secreted a molecule may be tightly bound to the cell surface membrane or extracellular matrix and this may effectively be considered to act at the cell surface. However, if the same molecule was secreted into a different cellular milieu then it might not be so readily sequestered and might therefore diffuse more freely. Purely diffusion mechanisms have an advantage that molecules are delivered at low energetic cost to the growth cone as opposed to the much more energy consuming process whereby the axon must grow to certain molecular destinations. Thus diffusible mechanisms allow for early decision making in the choice of targets or the exclusion from defined areas.

REFERENCES

- Abercrombie, M. and Heaysman, J. (1954). Observations on the social behaviour of cells in tissue culture. *Experimental cell research* 6:293-306.
- Aigner, L. and Caroni, P. (1993). Deletion of a 43-KD growth-associated protein in primary sensory neurons leads to diminished formation and spreading of growth cones. *Journal of cell biology* 123:417-429.
- Aigner, L. and Caroni, P. (1995). Absence of persistent spreading, branching and adhesion in Gap-43-depleted growth cones. *Journal of cell biology* 128:647-660.
- Attardi, D. G. and Sperry, R.W. (1963). Preferential selection of central pathways by regenerating optic fibers. *Experimental neurology* 7:46-64.
- Baier, H. and Bonhoeffer, F. (1992). Axon guidance by gradients of a target derived component. *Science* 225:472-475.
- Bate, C. M. (1976). Pioneer neurones in an insect embryo. *Nature* 260:54-56.
- Bate, C. M. and Grunewald (1981). Embryogenesis of an insect nervous system II : A second class of neuron precursor cells and origin of intersegmental connectives. *Journal of embryology and experimental morphology* 61:317-330.
- Bedlack, R. S., Wei, M. D. and Loew, L. M. (1992). Localised membrane depolarisation and localized calcium influx during electric field-guided neurite growth. *Neuron* 9:393-403.
- Bentley, M. and Aguayo, A. (1982). Extensive elongation of axons from rat brain into peripheral nerve grafts. *Nature* 296:150-152.
- Berlot, J. and Goodman, C. S. (1984). Guidance of peripheral pioneer neurones in the grasshopper : Adhesive hierarchy on epithelial and neuronal surfaces. *Science* 223:493-496.
- Bertolotti, R., Rutishauser, U. and Edelman, G. M.(1980). A cell surface molecule involved in aggregation of embryonic liver cells. *Proceedings of the national academy of science U.S.A* 77:4831-4835.
- Bevilacqua, M.P., Butcher, E., Furie, B., Gallatin, M., Gimbrone, M., Harlan, J., Kishimoto, K., Lasky, L., McEver, R., Paulson, J., Seed, B., Siegelman, M., Springer, T., Stoolman, L., Tedder, T. M., Varki, A., Wagner, D., Weissman, I. and Zimmerman, G. (1991). Selectins: a family of adhesion receptors. *Cell* 67:233--237.

- Bixby, J. L. (1989). Protein kinase C is involved in laminin stimulation of neurite outgrowth. *Neuron* 3:287-297.
- Bixby, J. L., Grunewald, G. B. and Brookman, R. J. (1994). Calcium influx and neurite response to purified N-cadherin and laminin. *Journal of cell biology* 127:1461-1475.
- Bixby, J. L. and Jhabvala, P. (1990). Extracellular matrix molecules and adhesion molecules induce neurites through different mechanisms. *Journal of cell biology* 111: 2725-2732.
- Bolz, J., Novak, N. and Bonhoeffer, T. (1990). Formation of target-specific neuronal projections in organotypic slice cultures from rat visual cortex. *Nature* 346:359-362.
- Bonhoeffer, F. and Huf, J. (1982). *In vitro* experiments on axon guidance demonstrating an anterior-posterior gradient on the tectum. *EMBO J* 1:427-431.
- Bonhoeffer, F. and Gierer, A. (1984). How do retinal axons find their targets in the tectum ?. *Trends in neuroscience* 7:378-381.
- Bozyczko, D. and Horwitz, A. (1986). The participation of a putative cell surface receptor for laminin and fibronectin in peripheral neurite extension. *Journal of neuroscience* 6:1241-1252.
- Brantlow, C., Schmidt, M. F., Hassinger, T. D., Schwab, M. E. and Kater, S. B. (1993). Role of intracellular calcium in NI-35-evoked collapse of neuronal growth cones. *Science* 259:80-83.
- Brandtlow, C. E., Zachleder, T. and Schwab, M. (1990). Oligodendrocytes arrest neurite growth by contact inhibition. *Journal of neuroscience* 10:3937-3948.
- Bray, D. and Chapman, K. (1985). Analysis of microspike movements on the neuronal growth cone. *Journal of neuroscience* 5:3204-3213.
- Bray, D. (1979). Mechanical tension produced by nerve cells in tissue culture. *Journal of cell science* 37:391-410.
- Bray, D. (1984). Axonal growth in response to experimentally applied mechanical tension. *Developmental biology* 102:379-389.
- Bronner-Fraser, M. (1985). Alterations in neural crest migration by a monoclonal antibody that affects cell adhesion. *Journal of cell biology* 101:601-617.
- Bronner-Fraser, M. (1986). An antibody to a receptor for fibronectin and laminin

perturbs cranial neural crest development *in vivo*. *Developmental biology* 117:528-536.

Bronner-Fraser, M and Lallier, T. (1988). A monoclonal antibody against a laminin-heparan sulfate proteoglycan complex perturbs cranial neural crest migration *in vivo*. *Journal cell biology* 106:1321-1329.

Brown, M. C., Perry, V. H., Hunt, S. P. and Lapper, S. R. (1994). Further studies on motor and sensory nerve regeneration in mice with delayed Wallerian degeneration. *European journal of neuroscience* 6:420-428.

Buck, C. A., Shea, E., Duggan, K. and Horwitz, A. F. (1986). Integrin (the CSAT antigen): functionally requires oligomeric integrity. *Journal of cell biology* 103:2421-2428.

Burrige, K., Fath, K., Kelly, T., Nuckolls, N. and Tucker, C. (1988). Focal adhesions : Transmembrane junctions between the extracellular matrix and the cytoskeleton. *Annual review in cell biology* 4:487-525.

Cajal, R. Y. (1890). A quelle époque apparaissent les expansions des cellules nerveuses de la moelle épinière du poulet ? *Anatomischer Anzeiger* 21-22 : 609-613-631-639

Cajal, R. Y. (1920). *Degeneration and regeneration of the nervous system*. Tran. R. M. Kay. Oxford:Oxford University Press.

Carlot, A.L. and Lander, A. (1991). Relationship between normal migration and cell substratum adhesion: laminin and merosin promote olfactory neuronal migration but are antiadhesive. *Journal of cell biology* 115:779-794.

Caroni, P. and Schwab, M. E. (1988a). Two membrane protein fractions from rat central myelin with inhibitory properties for neurite growth and fibroblast spreading. *Journal of cell biology* 106:1281-1288.

Caroni, P. and Schwab, M. E. (1988b). Antibody against myelin-associated inhibitor of neurite growth neutralizes non permissive substrate properties of central nervous system white matter. *Neuron* 1:88-96.

Carter, S. B. (1965). Principle of cell motility : The direction of cell movement and cancer invasion. *Nature* 208:1183-1185.

- Chang, S., Rathjen, F.G., Raper, J. A. (1987). Extension of neurites on axons is impaired by antibodies against specific cell surface glycoproteins. *Journal of cell biology* 104:355-362.
- Chen, H. J, Nakamoto, M., Bergenann, A. D. and Flanagan, J. G. (1995). Complementary gradients in expression and binding of ELF-1 and MeK 4 in development of the topographic retinotectal projection map. *Cell* 82:371-381.
- Chung, S. H., Keating, M. J., Bliss, T. V. (1974). Functional synaptic relations during the development of the retinotectal projections in amphibians. *Proceedings of the Royal Society, London (Biol)* 5:449-459.
- Coggins, P. J. and Zwiers, H. (1989). Evidence for a single protein kinase C mediated phosphorylation site in rat brain protein B-50. *Journal of neurochemistry* 53:1895-1901.
- Cohan, C. S., Connor, S. A. and Kater, S.B. (1987). Electrically and chemically mediated increases in intracellular calcium in neuronal growth cones. *Journal of neuroscience* 7:3588-3599.
- Cohan, C. S. and Kater, S. K. (1986). Suppression of neurite elongation and growth cone motility by electrical activity. *Science* 232:1638-1640.
- Cohen, J., Burne, J.F., Winter, J. and Barlett, P. (1986). Retinal ganglion cells lose response to laminin with maturation. *Nature* 322:465-466.
- Colamarino S.A. and Tessier-Lavigne M. (1995). The axonal chemoattractant netrin-1 is also a chemorepellent for trochlear motor axons. *Cell* 81:621-629.
- Collins, F. (1980). Neurite outgrowth induced by the substrate associated material from nonneuronal cells. *Developmental biology* 79:247-252.
- Cox, E. C., Muller, B. and Bonhoeffer, F. (1990). Axon guidance in the chick visual system : posterior tectal membranes induce collapse of growth cones from temporal retina. *Neuron* 4:31-37.
- Culotti, J. G. (1994). Axon guidance mechanisms in *caenorhabditis elegans*. *Current opinion in genetic development* 4:587-595.
- Daniloff, J. K., Levi, G., Grumet, M., Rieger, F., and Edelman, G. M. (1986). Altered expression of neuronal cell adhesion molecules induced by nerve injury and

repair. *Journal of cell biology* 103:929-947.

Davenport, R. W. and Kater, S. P. (1992). Local increases in intracellular calcium elicit local filopodial responses in *Helisoma* neuronal growth cones. *Neuron* 9:405-416.

Davies, J. A., Cook, G. M. W., Stern, C. D. and Keynes, R. J. (1990). Isolation from chick somites of a glycoprotein fraction that causes collapse of dorsal root ganglion growth cones. *Neuron* 2:11-20.

Davies, A. M., Bandtlow, C., Heumann, R., Korsching, S., Rohrer, H. and Thoenen, H. (1987). Timing and site of nerve growth factor synthesis in developing skin in relation to innervation and expression of the receptor. *Nature* 326:353-358.

Devreotes, P. N. (1982). Chemotaxis. In the development of dictyostelium discoideum. W. F. Loomis (ed), New York : Academic. p117-168.

Doherty, P., Ashton, S. V., Moore, S. E. and Walsh, F. S. (1991). Morphoregulatory activities of NCAM and N-Cadherin can be accounted for by G protein-dependent activation of L- and N-type neuronal calcium channels. *Cell* 67:21-33.

Doherty, P., Rimon, G., Mann, D. A. and Walsh, F. S. (1992). Alternative splicing of the cytoplasmic domain of neural cell adhesion molecule alters its ability to act as a substrate for neurite outgrowth. *Journal of neurochemistry* 58:2334-2341.

Doherty, P. and Walsh, F. S. (1994). Signal transduction events underlying neurite outgrowth stimulated by cell adhesion molecules. *Current opinion in neurobiology* 4:49-55.

Drescher, U., Kremoser, C., Handwerker, C., Loschinger, J., Masaharu, N. and Bonhoeffer, F. (1995). *In vitro* guidance of retinal ganglion cell axons by RAGS, a 25KDa tectal protein related to ligands for Eph receptor tyrosine kinases. *Cell* 82:359-370.

Ebendal, T. and Jacobson, C. O. (1977). Tissue explants affecting extension and orientation of axons in cultured chick embryo ganglia. *Experimental cell research* 105:379-387.

Edelman, G. M. (1983). Cell adhesion molecules. *Science* 219:450-457.

Edelman, G. M. (1986). Cell adhesion molecules in the regulation of animal form and

tissue pattern. *Annual review of cell biology* 2:81-116.

Ehring, K., Leivo, I. Argraves, S. W., Ruoslahti, E., and Engvall, E. (1990). The tissue-specific basement membrane protein merosin is a laminin-like protein. *Proceedings of the national academy of science U.S.A* 87:3264-3268.

Ellis, L., Katz, F. and Pfenninger, K. H. (1985). Nerve growth cones isolated from fetal rat brain. II. cyclic adenosine 3:5-monophosphate (cAMP)-binding proteins and cAMP-dependent protein phosphorylation. *Journal of neuroscience* 5:1393-1401.

Elsdale, T. and Bard, J. (1972). Collagen substrata for studies in cell behaviour. *Journal of cell biology* 54:626-637.

Ernfors, P., Merlio, J. P. and Persson, H. (1992). Cells expressing mRNA for neurotrophins and their receptors during embryonic rat development. *European journal of neuroscience* 4:1140-1158.

Faissner, A. and Kruse, J. (1990). J1/tenascin is a repulsive substrate for central nervous system neurons. *Neuron* 5:627-637.

Fan, J. and Raper, J. A. (1995). Localized collapsing cues can steer growth cones without inducing their full collapse. *Neuron* 14:263-274.

Fan, J., Mansfield, S. G., Redmond, T., Gordon-Weeks, P. R., and Raper, J. A. (1993). The organisation of F-actin and microtubules in growth cones exposed to a brain-derived collapsing factor. *Journal of cell biology* 121:867-878.

Fawcett, J. W. and O'Leary, D. D. M. (1984). The role of electrical activity in the formation of topographic maps in the nervous system. *Trends in neuroscience*. 8:201-206.

Fitzgerald, M., Kwiat, G.C., Middleton, J. and Pini, A. (1993). Ventral spinal cord inhibition of neurite outgrowth from embryonic rat dorsal root ganglia. *Development* 117:1377-1384.

Fischer, G., Kunemund, V. and Schachner, M. (1986). Neurite outgrowth patterns in cerebellar microexplant cultures are affected by antibodies to cell surface glycoprotein L1. *Journal of neuroscience* 6:605-612.

Forscher, P. and Smith, S. J. (1988). Actions of cytochalasins on the organisation of actin filaments and microtubules in a neuronal growth cone. *Journal of cell biology* 107

:1505-1516.

Friendlander, D. R., Hoffman, S. and Edelman, G. M. (1988). Functional mapping of cytotactin : proteolytic fragments active in cell substrate adhesion. *Journal of cell biology* 107:2329-2340.

Gaze, R. M. and Sharma, S. C. (1970). Axial differences in the reinnervation of the goldfish optic tectum by regenerating optic nerve fibres. *Experimental brain research*. 10:171-181.

Gaze, R. M., Keating, M. J. and Chung, S. H. (1974). The evolution of the retinotectal map during development in *Xenopus*. *Proceedings of the Royal Society London (Biol)* 185:301-330.

Geng, J., Bevilacqua, M.P., Moore, K. L., McIntyre, T.M., Prescott, Kim, J. M., Bliss, G.A., Zimmerman, G.A. and McEver, R.P. (1990). Rapid neutrophil adhesion to activated endothelium mediated by GMP-140. *Nature* 343:757-760.

Gerisch, B., Fromm, A. and Wick, U. (1975). Control of cell-contact sites by cyclic-AMP pulses in differentiating *Dictyostelium* cells. *Nature* 255:547-549.

Gilbert, C. D. (1983). Microcircuitry of the visual cortex. *Annual review of neuroscience* 6:217-247.

Gilman, A. G. (1987). G proteins : transducers of receptor-generated signals. *Annual review of biochemistry* 56:615-649.

Girad, P. R., Wood, J., Freschi, J. E. and Kuo, J. F. (1988). Immunocytochemical localization of protein kinase C in developing brain tissue and in primary neuronal cultures. *Development biology* 126:98-107.

Goldberg, D. J. and Burmeister, D. W. (1986). Stages in axon formation. Observations of growth of *Aplysia* axons in culture using video-enhanced contrast-differential interference contrast microscopy. *Journal of cell biology*. 103:1921-1931.

Gordon-Weeks, P. R. (1991). Evidence for microtubule capture by filopodial actin filaments in growth cones. *NeuroReport* 2:573-576.

Grumet, M., Hoffman, S., Crossin, K. L. and Edelman, G. M. (1985). Cytotactin, an extracellular matrix protein of neural and non-neural tissues, that mediates glia-neuron interactions. *Proceedings of the national academy of science U. S. A* 82:8075-8079.

Gumbiner, B. M. (1993). Proteins associated with the cytoplasmic surface of adhesion molecules. *Neuron* 11:551-564.

Gundersen, R. W. and Barrett, J. N. (1979). Neuronal chemotaxis: Chick dorsal-root axons turn toward high concentrations of nerve growth factor. *Science* 206:1079-1080.

Gundersen, R. W. and Barrett, J. N. (1980). Characterisation of the turning response of dorsal-root neurites toward nerve growth factor. *Journal of cell biology* 87:546-554.

Gundersen, R.W. (1987). Response of sensory neurites and growth cones to patterned substrata of laminin and fibronectin *in vitro*. *Developmental biology* 121:423-431.

Guthrie, S. and Pini, A. (1995). Chemorepulsion of developing motor axons by the floor plate. *Neuron* 14:1117-1130.

Hammerback, V.A., Palm, S.L., Furcht, L.T. and Letourneau, P.C. (1985). Guidance of neurite outgrowth by pathways of substratum-adsorbed laminin. *Journal of neuroscience research* 13:213-222.

Harris, A. (1973). Behavior of cultured cells on substrata of variable adhesiveness. *Experimental cell research* 77:285-297.

Harrison, R. G. (1907). Observations on the living developing nerve fiber. *Anatomical record* 1:116-118.

Harrison, R. G. (1910). The outgrowth of the nerve fiber as a mode of protoplasmic movement. *Journal of experimental zoology* 9:787-848.

Hayashi, Y., Haimovich, B., Reszka, A., Boettiger, D., and Horwitz, A. (1990). Expression and function of chicken integrin *b*₁ subunit and its cytoplasmic domain mutants in mouse NIH 3T3 cells. *Journal of cell biology* 110:175-184.

Haydon, P. G., McCobb, D. P. and Kater, S. B. (1984). Serotonin selectively inhibits growth cone motility and synaptogenesis of specific identified neurons. *Science* 226:561-564.

Hedgecock, E. M., Culotti, J. G. and Hall, D. H. (1990). The *unc-5*, *unc-6*, and *unc-40* genes guide circumferential migrations of pioneer axons and mesodermal cells on the epidermis in *c.elegans*. *Neuron* 4:61-85.

Heffner, C. D., Lumsden, A. and O'leary, D. D. M. (1990). Target control of collateral extension and directional axon growth in the mammalian brain. *Science*

247:217-220.

Herzog, K. H., Bailey, K. and Barde, Y. A. (1994). Expression of the BDNF gene in the developing visual system of the chick. *Development* 120:1643-1649.

Hescheler, J., Rosenthal, W., Trautwein, W. and Schultz, G. (1987). The GTP-binding protein G_o , regulates neuronal calcium channels. *Nature* 325:445-447.

Hill, T. L. and Kirschner, M. W. (1982). Subunit treadmilling of microtubules and actin in the presence of cellular barriers: possible conversion of chemical free energy into mechanical work. *Proceedings of the national academy of science U.S.A* 79:490-494.

Hoffman, S, and Edleman, G. M.(1983). Kinetics of homophilic binding by embryonic and adult forms of NCAM molecule. *Proceedings of the national academy of science U.S.A* 80:5762-5766.

Hoyle, G. W., Mercer, E. H., Palmiter, R. D., and Brinster, R. L. (1993). Expression of NGF in sympathetic neurons leads to excessive axon outgrowth from ganglia but decreased terminal innervation within tissues. *Neuron* 10:1019-1034.

Hunter, D., Shah, V., Merlie, J., and Sanes, J. (1989). A laminin-like adhesive protein concentrated in the synaptic cleft of the neuromuscular junction. *Nature* 338:229-234.

Hughes, A. (1953). The growth of embryonic neurites. A study on cultures of chick neural tissues. *Journal of anatomy* 87:150-162.

Hyman, C. and Pfenninger, K. H. (1987). Intracellular regulators of neuronal sprouting : II phosphorylation reactions in isolated growth cones. *Journal of neuroscience* 7:4076-4083.

Hynes, R. (1987). Integrins: a family of cell surface receptors. *Cell* 48:549-554.

Hynes, R. (1986). Molecular biology of fibronectin. *Annual review of cell biology* 1:67-90.

Hynes, R. and Lander, A. (1992). Contact and adhesive specificities in the associations, migrations and targeting of cells and axons. *Cell* 68:303-322.

Igarash, M., Strittmatter, S. M., Vartanian, T. and Fishman, M. C. (1993). Mediation by G-proteins of signals that cause collapse of growth cones. *Science* 259:77-79.

Ivins, J. K., Raper, J. A. and Pittman, R. N. (1991). Intracellular calcium levels do not change during contact-mediated collapse of chick dorsal root ganglion growth cone structure. *Journal of neuroscience* 11:1597-1608.

Johnson, J. E., Barde, Y. A., Schwab, M. and Thoenen, H. (1986). Brain-derived neurotrophic factor supports the survival of cultured rat retinal ganglion cells. *Journal of neuroscience* 6:3031-3038.

Kapfhammer, J. and Raper, J. (1987a). Interactions between growth cones and neurites growing from different neural tissues in culture. *Journal of neuroscience* 7:1595-1600.

Kapfhammer, J. and Raper, J. (1987b). Collapse of growth cone structure on contact with specific neurites in culture. *Journal of neuroscience* 7:201-212.

Kater, S. B., Mattson, M., Cohan, C. S. and Connor, J. (1988). Calcium regulation of the neuronal growth cone. *Trends in neuroscience* 11:315-321.

Kater, S. B. and Mills, L. R. (1991). Regulation of growth cone behaviour by calcium. *Journal of neuroscience* 11:891-899.

Katz, M. J. and Lasek, R. J. (1979). Substrate pathways which guide growing axons in xenopus embryos. *Journal of comparative neurology* 183:817-832.

Kennedy, T.E., Serafini, T., de la Torre, J.R., Tessier-Lavigne, M. (1994). Netrins are diffusible chemotropic factors for commissural axons in the embryonic spinal cord. *Cell* 78:425-435.

Keynes, R. J. and Stern, C. D. (1984). Segmentation in the vertebrate nervous system. *Nature* 310:786-789.

Kintner, C. and Melton, D. (1987). Expression of *Xenopus* NCAM RNA is an early response of ectoderm to induction. *Development* 99:311-325.

Kolodkin, A.L., Matthes, D.J., and Goodman, C.S. (1993). The sempaphorin genes encode a family of transmembrane and secreted growth cone guidance molecules. *Cell* 75:1389-1399.

Kolodkin, A. L., Matthes, D. J., O'connor, T. P., Patel, N. H., Admon, A., Bentley, D. and Goodman, C. S. (1992). Fasciclin IV : sequence, expression, and function

during growth cone guidance in the grasshopper embryo. *Neuron* 9:831-845.

Krayanek, S. and Goldberg, S. (1981). Oriented extracellular channels of axonal guidance in the embryonic chick retina. *Developmental biology*. 84:41-50.

Krotoski, D.M. (1989). Distribution of putative cell surface receptor for fibronectin and laminin in the avian embryo. *Journal of cell biology* 103:1061-1071.

Laemmli, U. K. (1970). Cleavage of structural proteins during the assembly of the head of the bacteriophage T4. *Nature* 227:680-685.

Lallier, T. and Bronner-Fraser, M. (1991). Avian neural crest cell attachment to laminin, involvement of divalent cation dependent and independent integrins. *Development* 113:1069-1084.

Lamoureux, P., Buxbaum, R. E. and Heidemann, S. R. (1989). Direct evidence that growth cones pull. *Nature* 340:159-162.

Landmesser, L., Dahm, L., Tang, J. C. and Rutishauser, U. (1990). Polysialic acid as a regulator of intramuscular nerve branching during embryonic development. *Neuron* 4: 655-667.

Lander, A.D., Tomaselli, K.J., Carlof, A.L. and Reichardt, L.F. (1983). Studies on extracellular matrix components that promote neurite outgrowth. *Cold spring harbor symposium quantitative biology* 48:611-624.

Lander, A.D., Fujii, D.K. and Reichardt L.F. (1985). Purification of a factor that promotes neurite outgrowth: isolation of laminin and associated molecules. *Journal of cell biology* 101:898-913.

Lankford, K. L. and Letourneau, P. (1991). Roles of actin filaments and three second messenger systems in short term regulation of chick dorsal root ganglion neurite outgrowth. *Cell motility and cytoskeleton* 20:7-9.

Letourneau, P. C. (1975a). Possible roles for cell-to-substratum adhesion in neuronal morphogenesis. *Developmental biology* 44:77-91.

Letourneau, P. C. (1975b). Cell-to-substratum adhesion and guidance of axonal elongation. *Development biology* 44:92-101.

Letourneau, P. C. (1978). Chemotactic response of nerve fiber elongation to nerve growth factor. *Development biology* 66:183-196.

- Letourneau, P.C. (1981). Immunocytochemical evidence for co-localization in neurite growth cones of actin and myosin and their relationship to cell substratum adhesions. *Development biology* 85:113-122.
- Levi-Montalcini, R. and Angeletti, P. (1963). Essential role of the nerve growth factor in survival and maintenance of dissociated sensory or sympathetic embryonic nerve cells *in vitro*. *Development biology* 7:653-659.
- Liesi, P. (1985). Do neurons in the vertebrate CNS migrate on laminin. *EMBO J* 4:1163-1170.
- Lin, C. and Forscher, P. (1993). Cytoskeletal remodeling during growth cone-target interactions. *Journal of cell biology* 121:1369-1383.
- Lin, C. and Forscher, P. (1993). Cytoskeletal remodelling during growth cone-target interactions. *Journal of cell biology* 121:1369-1383.
- Lumsden, A.G.S. and Davies A. M. (1986). Chemotropic effect of specific target epithelium in development of the mammalian nervous system. *Nature* 323:538-539.
- Lumsden, A.G.S. and Davies, A.M. (1983). Earliest sensory nerve fibres are guided to peripheral targets by attractants other than nerve growth factor. *Nature* 306:786-788.
- Lund, R. D. and Bunt, A. H. (1976). Prenatal development of central optic pathways in albino rats. *Journal of comparative neurology* 165:247-264.
- Luo, Y., Raible, D. and Raper, J.A. (1993). Collapsin: A protein in brain that induces the collapse and paralysis of neuronal growth cones. *Cell* 75: 217-227.
- Luo, Y., Shepherd I., Li, M., Renzi, M. J., Chang, S. and Raper, J. A. (1995). A family of molecules related to collapsin in the embryonic chick nervous system. *Neuron* 14:1131-1140.
- Manness, P. F., Aubry, M., Shores, C. G., Frame, L. and Pfenninger, K. H. (1988). c-src gene product in developing rat brain is enriched in nerve growth cone members. *Proceedings of the national academy of science U.S.A* 85:5001-5005.
- Marsh, G. and Beams, H. W. (1946). *In vitro* control of growing chick nerve fibers by applied electric currents. *Journal of comparative physiology* 27:139-157.
- Marsh, L. and Letourneau, P. C. (1984). Growth of neurites without filopodia or lamellipodial activity in the presence of cytochalasin B. *Journal of cell biology* 99:

2041-2047.

Matthes, D. J., Sink, H., Kolodkin, A. L. and Goodman, C. S. (1995). Semaphorin II can function as a selective inhibitor of specific synaptic arborisations. *Cell* 81:631-639.

Mattson, M. P. and Kater, S. B. (1987). Calcium regulation of neurite elongation and growth cone motility. *Journal of neuroscience research* 7:4034-4043.

McCaig, C. D. (1989). Studies on the mechanics of embryonic frog nerve orientation in a small applied electric field. *Journal of cell science* 93:723-730.

McKenna, M.P. and Raper, J.A. (1988). Growth cone behaviour on gradients of substratum bound laminin. *Developmental biology* 130:232-236.

McKerracher L., David S., Jackson D.L., Kottis V., Dunn R.J., and Braun P.E. (1994). Identification of myelin-associated glycoprotein as a major myelin-derived inhibitor of neurite growth. *Neuron* 13:805-811.

Menesini-chen, M. G., Chen, J. S. and Levi-Montalcini, R. (1978). Sympathetic nerve fibers ingrowth in the central nervous system of neonatal rodent upon intracerebral NGF injections. *Archives in Italian biology* 116:53-84.

Messersmith, E.K., Leonardo, E.D., Shatz, C.J., Tessier-Lavigne, M., Goodman, C.S. and Kolodkin, A.L. (1995). Semaphorin III can function as a selective chemorepellent to pattern sensory projections in the spinal cord. *Neuron* 14:949-959.

Moriarty, T. M., Padrell, E., Carty, D. J., Omri, G. Landau, E. and Iyengar, R. (1990). G protein as a signal transducer in the pertussis toxin sensitive phosphatidylinositol pathway. *Nature* 343:79-81.

Moss, D. J., Fernyhough, P., Chapman, K., Baizer, L., Bray, D. and Allsopp, T. (1990). Chicken growth-associated protein Gap-43 is tightly bound to the actin-rich neuronal membrane skeleton. *Journal of neurochemistry* 54:729-736.

Mukhopadhyay, G., Doherty P., Walsh, F.S., Crocker, P.R., and Filbin, M.T. (1994). A novel role for myelin-associated glycoprotein as an inhibitor of axonal regeneration. *Neuron* 13:757-767.

Nardi, J. B. (1983). Neuronal pathfinding in developing wings of the moth *manduca sexta*. *Development biology* 95:163-174.

Nardi, J. B. and Kafatos, F. C. (1976a). Polarity and gradients in lepidopteran wing epidermis. I. Changes in graft polarity, form and cell density accompanying transpositions and reorientations. *Journal of embryology and experimental morphology* 36:469-487.

Nardi, J. B. and Kafatos, F. C. (1976b). Polarity and gradients in lepidopteran wing epidermis. II. The differential adhesiveness model : Gradient of a non-diffusible cell surface parameter. *Journal of embryology and experimental morphology* 36:489-512.

O'Connor, T. P. and Bentley, D. (1993). Accumulation of actin in subsets of pioneer growth cone filopodia in response to neural and epithelial guidance cues *in situ*. *Journal of cell biology* 123:935-948.

Okabe, S. and Hirokawa, N. (1991). Actin dynamics in growth cones. *Journal of neuroscience* 11:1918-1929.

O'Leary, D. D. M. and Terashima, T. (1988). Cortical axons branch to multiple subcortical targets by interstitial axon budding : Implications for target recognition and "waiting periods" *Neuron* 1:901-910.

Pesheva, P., Spiess, E. and Schachner, M. (1989). J1-160 and J1-180 are oligodendrocyte-secreted nonpermissive substrates for cell adhesion. *Journal of cell biology* 109:1765-1778.

Pierschbacher, M.D. and Ruoslahti, E. (1984). Cell attachment activity of fibronectin can be duplicated by small synthetic fragments of the molecule. *Nature* 309:30-33.

Pini, A. (1993). Chemorepulsion of axons in the developing mammalian central nervous system. *Science* 261:95-98.

Placezek, M., Tessier-Lavigne, M., Jessel, T. and Dodd, J. (1990). Orientation of commissural axons *in vitro* in response to a floor plate derived chemoattractant. *Development* 110:19-30.

Puschel, A. W., Adams, R. H. and Betz, H. (1995). Murine semaphorins D/collapsin is a member of a diverse gene family and creates domains inhibitory for axon extension. *Neuron* 14:941-948.

Quarles, R. H., Barbarash, G. R., Figlewicz, D. A., and Brady, R. O. (1983). Purification and partial characterization of the myelin associated glycoprotein from adult rat brain. *Biochim. Biophys. Acta.* 757:140-145.

Raper, J. and Kapfhammer, J. (1990). The enrichment of a neuronal growth cone collapsing activity from embryonic chick brain. *Neuron* 4:21-29.

Rathjen, F. and Schachner, M. (1984). Immunological and biochemical characterisation of a new neuronal cell surface component (L1 antigen) which is involved in cell adhesion. *EMBO J* 3:1-10.

Reichard, L. F. and Tomaselli, K. J. (1991). Extracellular matrix molecules and their receptors : Functions in neural development. *Annual review of neuroscience* 14:531-570.

Reichardt, L., Bixby, J. L., Hall, D. E., Ignatius, M. J., Neugebauer, K. M. and Tomaselli, K. J. (1989). Integrins and cell adhesion molecules: Neuronal receptors that regulate axon growth on extracellular matrices and cell surfaces. *Developmental neuroscience* 11:332-347.

Rexed, B. (1952). The cytoarchitectural organisation of the spinal cord in the cat. *Journal of comparative neurology* 96:415-495.

Riggott, N.J. and Moody, S.A. (1987). Distribution of laminin and fibronectin along peripheral trigeminal axon pathways in the developing chick. *Journal of comparative neurology* 258:580-596.

Rodriguez-Tebar, A., Jeffrey, P. L., Thoenen, H. and Barde, Y. A. (1989). The survival of chick retinal ganglion cells in response to brain-derived neurotropic factor depends on their embryonic age. *Development biology* 136:296-303.

Roth, S. and Marchase, R. B. (1976). An *in vitro* assay for retinotectal specificity. In *Neuronal recognition*, p 227-248. S. H. Barondes (ed). Plenum, NY.

Ruoslahti, E. and Pierschbacher, M.D. (1987). New perspectives in cell adhesion: RGD and integrins. *Science* 238:49-497.

Sabry, J. H., O'Connor, T. P., Toroian-Raymond, A., Kirschner, M. and Bentley, D. (1991). Microtubule behavior during guidance of pioneer growth cones *in situ*. *Journal*

of cell biology 115:381-395.

Saffell, J., Walsh, F. S. and Doherty, P. (1992). Direct activation of second messenger pathways mimics cell adhesion molecule-dependent neurite outgrowth. *Journal of cell biology* 118:663-670.

Sasaki, M., Kato, S, Kohno, K., Martin, G. R. and Yamada, K. (1987). Sequence of the cDNA encoding the laminin B1 chain reveals a multidomain protein containing cysteine-rich repeats. *Proceeding of the national academy of science U.S.A* 84:935-939.

Savio, T. and Schwab, M. E. (1990). Lesion corticospinal axons regenerate in myelin free rat spinal cord. *Proceeding of the national academy of science* 87:4130-4133.

Serafini T., Kennedy T.E., Galko M.J., Mirzayan C., Jessell T.M., and Tessier-Lavigne M. (1994). The netrins define a family of axon outgrowth-promoting proteins homologous to *C. elegans* UNC-6. *Cell* 78:409-424.

Schnell, L. and Schwab, M.E. (1990). Axonal regeneration in the rat spinal cord produced by an antibody against myelin associated glycoprotein from adult rat brain. *Nature* 343:269-272.

Schnell, L., Schneider, R., Kolbeck, R., Barde, Y. A. and Schwab, M. E. (1994). Neurotrophin-3 enhances sprouting of corticospinal tract during development and after adult spinal cord lesion. *Nature* 367:170-173.

Schuch, U. Lohse, M. J. and Schachner, N. (1989). Neural cell adhesion molecules influence second messenger systems. *Neuron* 3:13-20.

Schwab, M. E. and Thoenen, H. (1985). Dissociated neurons regenerate into sciatic but not optic nerve explants in culture irrespective of neurotrophic factors. *Journal of neuroscience* 5:2415-2423.

Silver, J. and Rutishauser, U. (1984). Guidance of optic axons *in vivo* by a preformed adhesive pathway on neuroepithelial endfeet. *Developmental Biology* 106:485-499.

Silver, J. and Sidman, R. L. (1980). A mechanism for guidance and topographic patterning of retinal ganglion cell axon. *Journal of comparative neurology* 189:101-111.

Singer, M., Norlander, R. and Egar, M. (1979). Axonal guidance during embryogenesis and regeneration in the spinal cord of the newt : The blueprint hypothesis of neuronal pathway patterning. *Journal of Comparative Neurology* 185:1-

22.

Skene, J. H. P., Jacobson, R. D., Snipes, G. J. McGuire, C. B., Norden, J. J. and Freeman, J. A. (1986). A protein induced during nerve growth (Gap-43) is a major component of growth cone membranes. *Science* 233:783-785.

Smith, J. C., Price, B. M. J., Van, L., Nimmen, K. and Huylebroeck, D. (1990). Identification of a potent *Xenopus* mesoderm-inducing factor as a homologue of activin A. *Nature* 345:729-731.

Snow, D. M., Watanabe, M., Letourneau, P. C. and Silver, J. (1991). A chondroitin sulfate proteoglycan may influence the direction of retinal ganglion cell outgrowth. *Development* 113:1473-1485.

Sperry, R. W. (1963). Chemoaffinity in the orderly growth of nerve fiber patterns and connection. *Proceedings of the national academy of science USA* 50:703-710.

Sperry, R. W. (1944). Optic nerve regeneration with return of vision in anurans. *Journal of neurophysiology* 7:57-69.

Spring, J., Beck, H., and Chiquet-Ehrismann, R. (1989). Two contrary functions of tenascin: Dissection of the active sites by recombinant tenascin fragments. *Cell* 59: 325-334.

Stahl, B., Muller, B., Boxberg, Y. V., Cox, E. and Bonhoeffer, F. (1990). Biochemical characterisation of a putative axonal guidance molecule of the chick visual system. *Neuron* 5:735-743.

Steinberg, M. S. (1970). Does differential adhesion govern self-assembly processes in histogenesis? Equilibrium configurations and the emergence of a hierarchy among populations of embryonic cells. *Journal of experimental zoology* 173:395-434.

Stoolman, L.M. (1989). Adhesion molecules controlling lymphocyte migration. *Cell* 60:45-52.

Strittmatter, S. M. Valenzuela, D., Kennedy, T. E., Neer, E. J. and Fishman, M. C. (1990). G_O is a major growth cone protein subject to regulation by GAP-43. *Nature* 344:836-841.

Strittmatter, S. M., Fankhauser, C., Huang, P. L., Mashimo, H. and Fishman, M. C. (1995). Neuronal pathfinding is abnormal in mice lacking the neuronal growth cone protein GAP-43. *Cell* 80:445-452.

Susuki, S., Sano, K. and Tanihara, H. (1991). Diversity of the cadherin family: evidence for eight new cadherins in nervous tissue. *Cell regulation* 2:261-270.

Takeichi, M. (1987). Cadherins : A molecular family essential for selective cell-cell adhesion and animal morphogenesis. *Trends in genetics* 3:213-217.

Takeichi, M. (1988). The cadherins : cell-cell adhesion molecules controlling animal morphogenesis. *Development* 102:639-655.

Takeichi, M., Hatta, K., Nose, A., Nagafuchi A. and Matsunaga, M. (1989). Cadherin-mediated specific cell adhesion and animal morphogenesis. In *Cellular basis of morphogenesis*. Wiley, Chichester (Ciba foundation symposium 144) 243-254.

Takeichi, M., Inuzuka, H., Shimamura, K., Fujimori, T. and Nagafuchi, A. (1990). Cadherin subclasses: differential expression and their roles in neural morphogenesis. *Cold Spring Harbor Symposium. Quantitative Biology*. 55:319-325.

Tamada A., Shirasaki, R., and Murakami F. (1995). Floor plate chemoattracts crossed axons and chemorepels uncrossed axons in the vertebrate brain. *Neuron* 14:1083-1093.

Tanaka, E. M. and Kirschner, M. W. (1991). Microtubule behaviour in the growth cones of living neurons during axon elongation. *Journal of cell biology* 115:345-363.

Tessier-Lavigne, M., Placzek, M., Lumsden, A. G. S., Dodd, J. and Jessel, T. (1988). Chemotropic guidance of developing axons in the mammalian central nervous system. *Nature* 336:775-778.

Tessier-Lavigne, M. and Placzek, M. (1991). Target attraction: Are developing axons guided by chemotropism. *Trends in neuroscience* 15:303-310.

Thanos, S., Bahr, M., Barde, Y. A. and Vanselow, J. (1989). Survival and axonal elongation of adult rat retinal ganglion cells. *European journal of neuroscience* 1:19-26.

Thiery, J. P., Brackenbury, R., Rutishauser, U. and Edelman, G. M. (1977). Adhesion among neural cells of the chick embryo. II. Purification and characterization of a cell molecule from neural retina. *Journal of biological chemistry* 252:6841-6845.

Thiery, J. P., Duband, J. L., Rutishauser, U. and Edelman, G. M. (1982). Cell adhesion molecules in early chick embryogenesis. *Proceeding of the national academy of science U.S.A* 79:6737-6741.

Timpl, R., Rohde, H., Robey, P. G., Rennard, S. I., Foidart, J. M. and Martin, G. R. (1979). Laminin-a glycoprotein from basement membranes. *Journal of biological chemistry* 254:9933-9937.

Tomaselli, K.J., Reichardt, L.F. and Bixby J.L. (1986). Distinct molecular interactions mediate neural process outgrowth on non-neuronal cell surfaces and extracellular matrices. *Journal of cell biology* 103:2659-2672.

Tucker, R. P. and Erickson, C. A. (1984). Morphology and behaviour of quail neural crest cells in artificial 3-dimensional extracellular matrices. *Development biology* 104:390-405.

Van der Geer, P., Hunter, T., and Lindberg, R. A. (1994). Receptor protein-tyrosine kinases and their signal transduction pathways. *Annual review of cell biology*. 10:251-327.

Van Dongen, A. M. J., Codina, J., Olate, J., Mattera, R., Joho, R., Birnbaumer, L. and Brown, A. M. (1988). Newly identified brain potassium channels gated by the guanine nucleotide binding protein G_o. *Science* 241:1433-1437.

Walsh, F. S. and Doherty, P. (1991). Structure and function of the gene for neural cell adhesion molecule. *Seminars neuroscience* 3:271-284.

Walter, J., Henke-fahle, S. and Bonhoeffer, F. (1987). Avoidance of posterior tectal membranes by temporal retinal axons. *Development* 101:909-913.

Wehrle, B. and Chiquet, M. (1990). Tenascin is accumulated along developing peripheral nerves and follows neurite outgrowth *in vitro*. *Development* 110:401-415.

Weiss, P. (1936). Selectivity controlling the central peripheral relations in the nervous system. *Biological review* 11:494-529.

Weiss, P. (1941). Nerve patterns : Mechanics of nerve growth. *Growth (suppl.5)* 163-203

Weiss, P. (1944). Further evidence against "neurotropism" in nerve regeneration. *Journal of experimental zoology* 95:233-257.

Williams, E., Doherty, P., Turner, G., Reid, P. A., Hemperly, J. J. and Walsh, F. S. (1992). Calcium influx into neurons can solely account for cell-contact dependent

- neurite outgrowth stimulated by transfected L1. *Journal of cell biology* 119:883-892.
- Willams, E., Furness, J., Walsh, F. S. and Doherty, P. (1994). Activation of the FGF receptor underlies neurite outgrowth stimulated by L1, N-CAM and N-cadherin. *Neuron* 13:583-594.
- Yamada, K. M., Spenner, B. S. and Wessells, N. K. (1970). Ultrastructure and function of growth cones and axons of cultured nerve cells. *Cell biology* 49:614-635.
- Yoon, M. G. (1971). Reorganisation of retinotectal projection following surgical operation on the optic tectum in goldfish. *Experimental neurology* 33:395-411.
- Zuber, M. X., Goodman, D. W., Karns, L. R. and Fishman, M. C. (1989). The Neuronal growth-associated protein GAP-43 induces filopodia in non-neuronal cells. *Science* 244:1193-1195.