

## Aberystwyth University

### *A novel chemical sensor with multiple all-solid-state electrodes and its application in freshwater environmental monitoring*

Zhou, Yifan; Mur, Luis; Edwards, Arwyn; Davies, John; Han, Jiwan; Qin, Huawei; Ye, Ying

*Published in:*

Water Science and Technology

*DOI:*

[10.2166/wst.2018.310](https://doi.org/10.2166/wst.2018.310)

*Publication date:*

2018

*Citation for published version (APA):*

Zhou, Y., Mur, L., Edwards, A., Davies, J., Han, J., Qin, H., & Ye, Y. (2018). A novel chemical sensor with multiple all-solid-state electrodes and its application in freshwater environmental monitoring. *Water Science and Technology*, 78(2), 432-440. <https://doi.org/10.2166/wst.2018.310>

#### **General rights**

Copyright and moral rights for the publications made accessible in the Aberystwyth Research Portal (the Institutional Repository) are retained by the authors and/or other copyright owners and it is a condition of accessing publications that users recognise and abide by the legal requirements associated with these rights.

- Users may download and print one copy of any publication from the Aberystwyth Research Portal for the purpose of private study or research.
- You may not further distribute the material or use it for any profit-making activity or commercial gain
- You may freely distribute the URL identifying the publication in the Aberystwyth Research Portal

#### **Take down policy**

If you believe that this document breaches copyright please contact us providing details, and we will remove access to the work immediately and investigate your claim.

tel: +44 1970 62 2400

email: [is@aber.ac.uk](mailto:is@aber.ac.uk)

1     **A novel chemical sensor with multiple all-solid-**  
2     **state electrodes and its application in freshwater**  
3             **environmental monitoring**

4             **A chemical sensor with multiple electrodes and its application**

5

6

7     Zhou, Y.<sup>1</sup>, Mur, L. A. J.<sup>2</sup>, Edwards, A.<sup>2</sup>, Davies, J.<sup>2</sup>, Han, J.<sup>2</sup>, \*Qin, H.<sup>3</sup>and Ye, Y<sup>1</sup>.

8

9     <sup>1</sup>Ocean College, Zhejiang University, Zhoushan, Zhejiang, China, 316021

10    <sup>2</sup>Aberystwyth University, Institute of Biological, Environmental and Rural Sciences,  
11    Aberystwyth, Wales, SY23 3DA, UK.

12    <sup>3</sup>Hangzhou Dianzi University: Xiasha Higher Education Zone, Hangzhou, Zhejiang, China,  
13    310018

14

15    \* communicating author

16

17

1 **Abstract**

2 Freshwater quality detection is important for pollution control. Three important  
3 components of water quality are pH, ammonia and dissolved H<sub>2</sub>S and there is an  
4 urgent need of a high-precision sensor for simultaneous and continuous  
5 measurement. In this study, all-solid-state electrodes of Eh, pH, NH<sub>4</sub><sup>+</sup> and S<sup>2-</sup> were  
6 manufactured and mounted to a wireless chemical sensor with multiple  
7 parameters. Calibration indicated that pH electrode had a Nernst response with  
8 slope of 53.174mV; NH<sub>4</sub><sup>+</sup> electrode had a detection limit of 10<sup>-5</sup>mol/L (Nernst  
9 response slope of 53.56mV between 10<sup>-1</sup>to 10<sup>-4</sup>mol/L). Ag/Ag<sub>2</sub>S has a detection  
10 limit of 10<sup>-7</sup>mol/L (Nernst response slope of 28.439mV). The sensor was  
11 cylindrical and small with low power consumption and low storage demand to  
12 achieve continuous *in-situ* monitoring for long periods. The sensor was tested for  
13 10 days in streams at Trawsgoed Dairy farm in Aberystwyth, UK. At the intensively  
14 farmed Trawsgoed, the concentration of NH<sub>4</sub><sup>+</sup> in the stream rose sharply after the  
15 application of slurry to adjacent fields. Further, the stream was overhung with  
16 extensive vegetation and exhibited changes in pH, which correlated with  
17 photosynthetic activity. Measurements of S<sup>2-</sup>were stable throughout the week. Our  
18 data demonstrates the applicability of our multiple electrode sensor.

19 **Key Word**

20 Multiple electrode sensor; water environment; in-situ monitoring; Ammonium

21

# 1 Introduction

2 Globally, agriculture is the largest user of fresh water but is also a source of contamination  
3 through chemical runoff. Within freshwater, pH, ammonia and dissolved H<sub>2</sub>S are  
4 three important indicators of quality. pH is an important measurement of water  
5 chemistry and reflects both characteristics of the underlying bedrock and the  
6 amount of plant growth and organic material. The latter reflects the release of  
7 CO<sub>2</sub> as a result of the decomposition of organic matter and also active respiration,  
8 both of which leads to the formation of carbonic acid (H<sub>2</sub>CO<sub>3</sub>). Plant and algal  
9 growth also reflects run-off of nitrogen (N)-fertilizers, whether synthetic or as  
10 biological wastes; leading to the eutrophication of water courses (Ip et al., 2004).  
11 These N inputs are reduced to free ammonia(Xu et al., 2008). Dissolved H<sub>2</sub>S can  
12 originate from various sources (coal-based power plants, natural-gas processing,  
13 refineries, smelter operation) and can be regarded as a major air pollutant  
14 entering the atmosphere and causing acid rain (Primavera et al., 1998).  
15 Continuous measurements of dissolved H<sub>2</sub>S in water is in need to monitor any  
16 accidental releases, particularly from industrial sources (Miloshova et al., 2003).  
17 Therefore, monitoring pH, dissolved H<sub>2</sub>S and ammonia; ideally continuously, is  
18 very important for the agricultural water environment, drinking water and fresh  
19 water. *In situ* is a particularly attractive target as some ions in water solution are  
20 unstable and easily change to other forms.

21 The traditional methods for ion measurement include ion chromatography (Rey  
22 et al., 1998), fluorometry, spectrophotometry (Goyal et al., 1988) and titration(He,  
23 2000). However these methods are time-consuming and cannot be use for  
24 continuous *in-situ* monitoring. Ion selective Electrodes (ISEs), that give a  
25 potentiometric signal that obeys the Nernst equation, are currently attracting  
26 considerable attention (Mikhelson, 2013). ISEs have a high selectivity to certain  
27 ion, and are able to detect low concentrations. Further, ISEs are applicable for *in-*



1 *situ* monitoring due to their quick response time(Michalska, 2012). The most  
2 widely used ISEs are glass electrodes (Gonçalves et al., 2011; Mikhelson, 2013),  
3 which contain an internal reference solution. However, these are difficult to  
4 miniaturize and are easy to be damage (Chen et al., 2007; Cheng et al., 2011). The  
5 development of all-solid-state electrodes represents a considerable recent  
6 improvement (Cattrall & Freiser, 1971; Mikhelson, 2013). They have a lower  
7 resistivity and smaller than glass electrodes and have eliminated the need for an  
8 internal reference solution. The high performance of all-solid-state electrodes  
9 makes it possible to integrate these other electrodes for long-term continuous *in-*  
10 *situ* monitoring in water environment.

11 In this study, we describe the construction of all-solid-state electrodes for Eh, pH,  
12  $\text{NH}_4^+$  and  $\text{S}^{2-}$ , mounted to a wireless chemical sensor with multiple parameters. We  
13 demonstrate the sensors efficacy in the continuous *in-situ* measuring of Eh, pH,  
14  $\text{NH}_4^+$  and  $\text{S}^{2-}$  in freshwater streams in agricultural active farm (Trawsgoed, UK;  
15  $52^{\circ}20' 38''$  N,  $3^{\circ}57' 4''$  W). Thus, extensive use of this sensor could allow the  
16 monitoring of agricultural runoff in varying environments.

## 17 **Methods**

### 18 **Electrode construction and sensor design**

#### 19 Ir/Ir(OH)<sub>x</sub>-pH electrode preparation and lab test

20 The Ir wires were ultrasonically cleaned in a HCl bath and then rinsed in deionized  
21 water. In three-electrode system of the CHI760D electrochemical workstation, the  
22 Ir electrode was used as the working electrode, the Ag/AgCl electrode as the  
23 reference electrode and the Pt electrode as the auxiliary electrode. Cyclic  
24 voltammetry (CV), with scanning in 5% LiOH solution (0.1 M), was used to form  
25 Ir electrode with a layer of Ir(OH)<sub>x</sub> film(Zhang et al., 2017).

1 pH buffer solutions of 4.00, 6.86, 9.18 were used to calibrate the Ir/Ir(OH)<sub>x</sub>-pH  
2 electrode. The pH electrode was calibrated using a CHI760D electrochemical  
3 workstation.

4

5 NH<sub>4</sub><sup>+</sup> electrode preparation and lab test

6 A Ag wire was polished with alumina powder and ultrasonically cleaned in a HCl  
7 bath. This was rinsed in deionized water and dried in open air. A nano-Ag layer  
8 was electroplated to Ag wire for better conductivity. The anode and the cathode  
9 of the electroplating system were all Ag wires. A solution of 0.1M AgNO<sub>3</sub> was used  
10 as the electrolyte.

11 The conductive polyaniline (PANI) layer was formed by the three-electrode  
12 system. Cyclic voltammetry (CV) method was used in 0.1M aniline hydrochloride.  
13 Then the wire was dipped in saturated solution of copolymer aniline(CPANI) and  
14 2,5-dimethoxyaniline as the second layer. Finally, Ammonium ionophore I (6.9%),  
15 Potassium tetrakis (4-chlorophenyl) borate (0.7%) and 2-Nitro phenyloctyl ether  
16 (92.4%) was dissolved in N,N-Dimethyl formamide (DMF) and the wire dipped  
17 into this solution to form the third layer(Huang et al., 2015).

18 A series of NH<sub>4</sub>Cl solution from 1×10<sup>-5</sup> to 1×10<sup>-1</sup> M were prepared. The NH<sub>4</sub>Cl solution  
19 consisted of 0.5349 g NH<sub>4</sub>Cl and made up to 100 mL in volumetric flask with deionized  
20 water to obtain a 1×10<sup>-1</sup> M NH<sub>4</sub>Cl solution. 1×10<sup>-2</sup> M to 1×10<sup>-5</sup> M NH<sub>4</sub>Cl solution were  
21 stepwise diluted by the 1×10<sup>-1</sup> M standard NH<sub>4</sub>Cl solution with deionized water. The  
22 NH<sub>4</sub><sup>+</sup> electrode was calibrated using a CHI760D electrochemical workstation.

23

24 Ag/Ag<sub>2</sub>S electrode preparation and laboratory testing

1 A 3 cm Ag wire was polished and electroplated with a nano-Ag layer using the  
2 same method as described in 2.2 and then immersed to the 0.1M Na<sub>2</sub>S solution for  
3 10 min. Ag<sub>2</sub>S formed the outmost layer of the electrode(Ding et al., 2015).

4 A series of Na<sub>2</sub>S solutions ranging from  $1 \times 10^{-7}$  to  $1 \times 10^{-1}$  M were prepared. To avoid S<sup>2-</sup>  
5 oxidation, a sulfur antioxidant buffer (SAOB) was prepared in place of deionized water  
6 when preparing the Na<sub>2</sub>S solution. Stocks of 1L of SAOB contained 80 g of NaOH, 35  
7 g of ascorbic acid (VC), 67 g of EDTA-2Na, and 35 g of NaCl. The Na<sub>2</sub>S solution  
8 consisted of 0.7804g Na<sub>2</sub>S and made up to 100 mL in volumetric flask with SAOB to  
9 obtain a  $1 \times 10^{-1}$  M Na<sub>2</sub>S solution.  $1 \times 10^{-2}$  M to  $1 \times 10^{-7}$  M Na<sub>2</sub>S solutions were stepwise  
10 diluted by the  $1 \times 10^{-1}$  M standard Na<sub>2</sub>S solution with SAOB. The Ag/Ag<sub>2</sub>S electrode was  
11 calibrated using a CHI760D electrochemical workstation.

12

13 Multiple-parameter sensor design

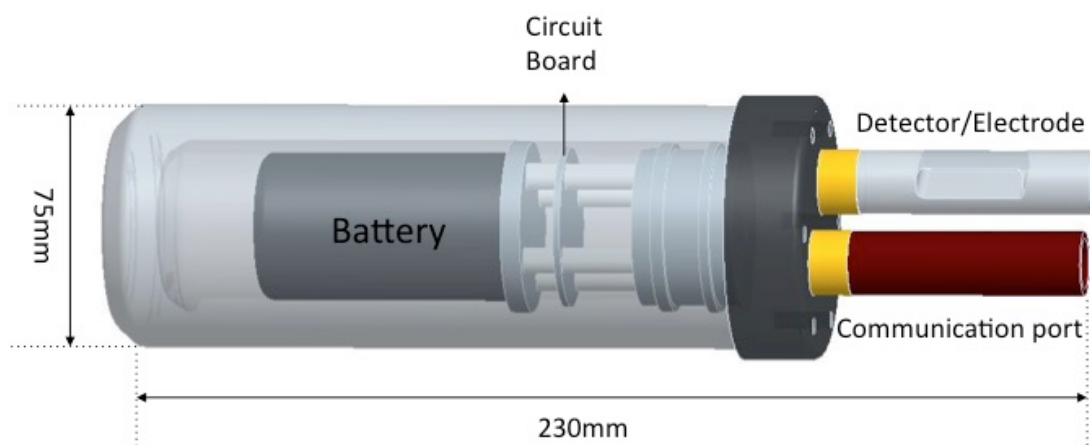

14

15

Figure 1 Structural Diagram of Chemical Sensor

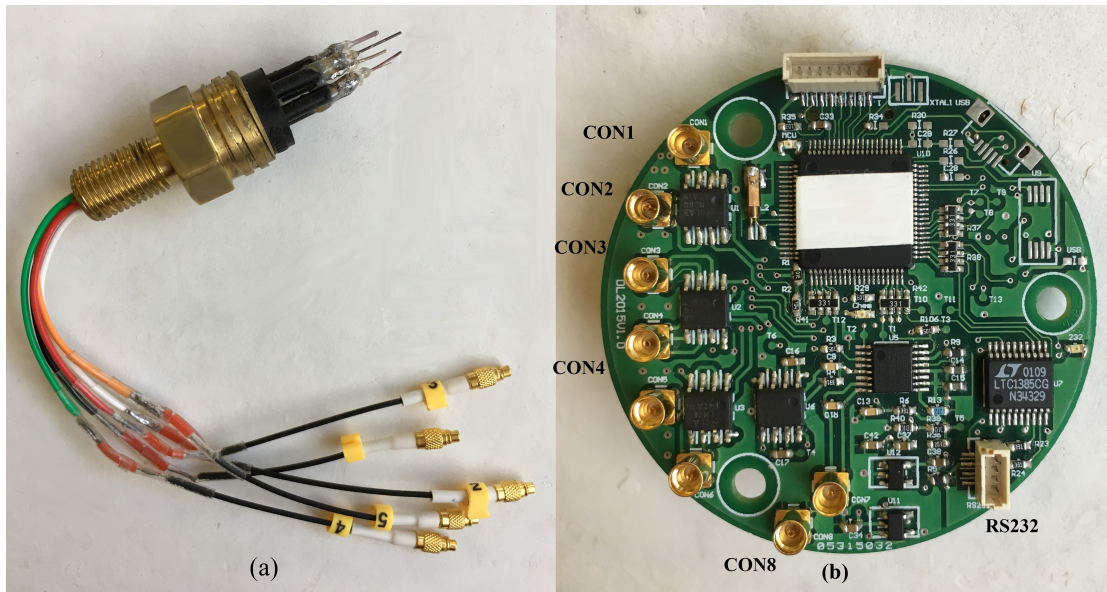
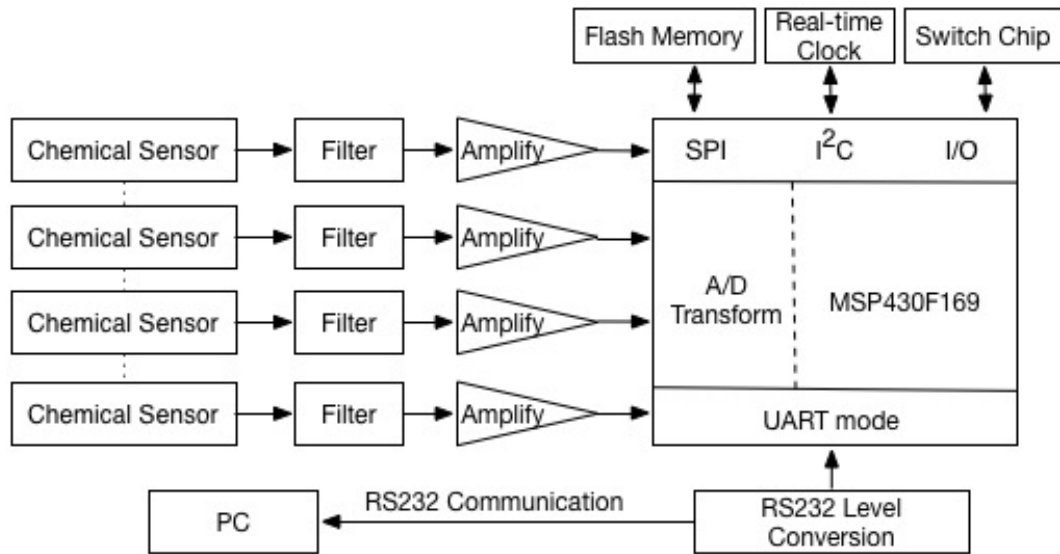

Figure 2 Structure Details (a) Detector part/Electrodes (b)Circuit Board Structure

Figure 1 shows the structural diagram of chemical sensor. The outer shape is a cylinder with a length of 230mm and 75mm in diameter. The outer covering is made up of 30CrMnSi, which is a compound metal which confers added strength to protect the sensor against environmental impacts. The sensor contains a communication port, a detector part outside and a circuit board and a battery. The pH electrode,  $\text{NH}_4^+$  electrode, Ag/Ag<sub>2</sub>S electrode, Eh electrode and Ag/AgCl reference electrode were integrated into the detector part (Figure 2 (a)). The Eh electrode was made of a platinum wire and Ag/AgCl reference electrode was prepared by melting method (Zhong & Yexiang, 1998). To better connect the electrode to the detector part, the platinum wire and Ir wire were connected to Ag wire by gas welding. The exposed metal parts, which connect electrode and electric wire, were wrapped individually by shrinkable tube and an epoxy resin layer to avoid corrosion and short circuiting.

When the sensor is in use and submerged in water, a semi-hollow cap covers the detector part. The semi-open design of the detector part not only guarantees full contact between electrodes and water but also prevent the chemical membrane being damaged by rapid rushing water and greatly avoid biofouling.



1

2

Figure 3 Working Principle of the data acquisition system

3

Figure 3 illustrates the working principle of the data acquisition system. First, the chemical sensors detect the chemical signals and convert chemical signals into electrical signals, which then go through the filter, are amplified into the main processor, and stored in a Flash memory function. The watertight connector may be linked to the host computer for real-time communication. The whole data collection can be controlled by the host computer's software. The built-in clock and switch chip of the processor were calibrated by the host computer software, which also initiates the sensor's work mode to collect signals. The multi-parameter sensor can then be disconnected from the host computer in the start the work mode of the processor and used for in-situ observations. At the end of the observation period, the multi-parameter sensor and the host computer can be reconnected to read the stored data through the watertight connector.

15

Figure 2 (b) shows the structure of the circuit board. Each electrode was connected to a certain port from 'CON1' to 'CON 4' with a reference electrode at the center, which was connected to 'CON 8'. 'RS232' is the communication interface, connecting to signal lines. According to the circuit board design, the real-time data can be stored in a Flash chip when carrying out fieldwork and retrieved later after connecting to software.

19

1 The frequency of data collecting can be set at a minimum of 1s or greater intervals.  
2 Therefore, the sensor can be used in multiple environments without constraints of  
3 distance as the sensor works and store data independently without connecting to a host  
4 computer. The two system mode, sleep mode and work mode, consume 1.0mA and  
5 3.5mA electric current respectively. The input impedance of the system is  $10^{13} \Omega$  (25°C),  
6 which guarantee long-term use with two AA Li batteries. The data is stored in a Flash  
7 chip with 128M bit storage capacity as internal storage. If measuring frequency is set  
8 as once per 1 minute, the storage can guarantee 2 years monitoring. When the storage  
9 is full, new data will cover old data automatically. Due to its lower power consumption  
10 and low storage demand, the sensor can achieve continuous in-situ monitoring for at  
11 least 6 months. The circuit board and the batteries are sealed in the cylinder made up of  
12 30CrMnSi, no harmful to the surrounding environment.

13 Life cycle of whole system is about 2 years, needs service to change electrodes and  
14 batteries every 6 months.

15 Polyaniline (PANI) and Silver nano particle, which are bacteriostatic are used for  
16 preparation of  $\text{NH}_4^+$  and  $\text{Ag}_2\text{S}$  electrodes respectively(Tian, 2010; Zongming Xiu,  
17 2012). The 0.25mm diameter Ir wire used for pH electrode is thinner and hard to be  
18 adhered. This avoid problem of biofouling in lifetime.

19

## 20 **Field trial locations**

21 A ten-day fieldwork was conducted between September 17- 26<sup>th</sup>September 2016 at  
22 Trawsgoed Farm, Aberystwyth, UK. Trawsgoed Farm is the location of a 350-cow  
23 commercial dairy herd. As such the farm produces a large volume of slurry from its  
24 livestock. Several ditches stretch across the farm and feeds into the River Ystwyth some  
25 28 km from its mouth. Given this potential for wide-ranging impact on local water  
26 quality, it is appropriate to engage in monitoring streams around this farm.



Figure 4 Sensor Position in Trawsgoed Farm

1  
2  
3  
4  
5  
6  
7  
8  
9  
10  
11  
12  
13

The multiple-parameter sensor, which can detect Eh, pH,  $\text{NH}_4^+$  and  $\text{S}^{2-}$ , was positioned in the ditch of the farm ( $52^\circ 20' 38''$  N,  $3^\circ 57' 4''$  W). The position has been indicated as red spot in Figure 4. The ditch was about 0.5m deep and 1.0m surrounded with green plants. During the field trial, slurry was applied by shallow injection into the farmland adjacent to this stream on the Sept 18<sup>th</sup> and Sept 19<sup>th</sup>. As an independent measure of pH, this was measured at a position close to sensor using a Thermo Scientific Orion, ROSS pH Electrode. pH was measured in around midday on Sep. 19<sup>th</sup>, 20<sup>th</sup>, 21<sup>st</sup>, 22<sup>nd</sup>, 23<sup>rd</sup>, 24<sup>th</sup>, 25<sup>th</sup>, 26<sup>th</sup>.

To understand the daily variation of chemical parameters, the sensor was set to collect data every 1 minute during the field trial. The sensor was taken back and connected to host computer to extract the stored data at the end of the each period

1 of fieldwork. The obtained potential value was converted to concentration value  
2 based on the calibration result. To reduce the effect of any abnormal data, the  
3 average of every half an hour was calculated based on the obtain 1 minute  
4 measurements.

5 To allow for the effect of temperature, *in situ* pH data was converted to 25°C pH  
6 using the following formula:

7 
$$\text{pH}_{25} = \text{pH}_{\text{in situ}} - 0.0151 \times (25 - T)$$

8 where T is temperature from Aberystwyth weather website("Past Weather in  
9 Aberystwyth, Wales, United Kingdom," 2016).

## 10 **Results and Discussion**

### 11 **Electrode Calibration**



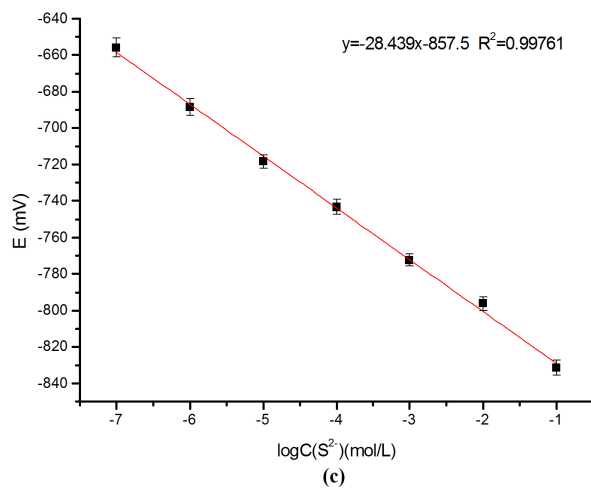
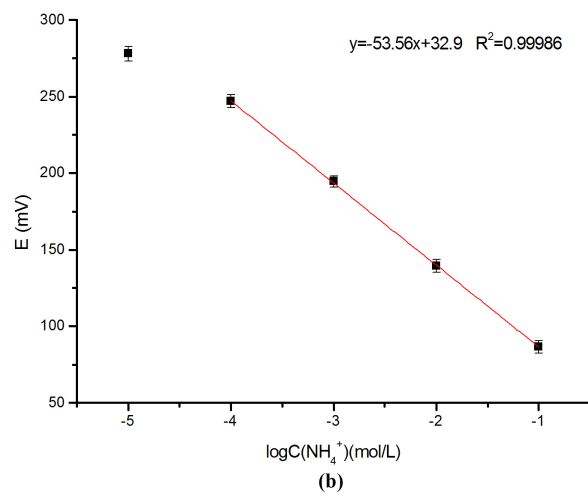
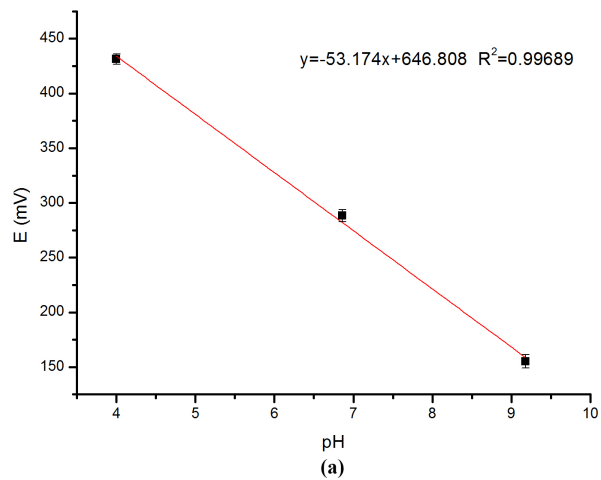

1

2 Figure 5 Potential-pH response of (a)  $\text{Ir}/\text{Ir}(\text{OH})_x$ -pH electrode (b)  $\text{NH}_4^+$  electrode (c)  $\text{Ag}/\text{Ag}_2\text{S}$  electrode

3 Figure 5 (a) shows the potential-pH response of the  $\text{Ir}/\text{Ir}(\text{OH})_x$ -pH electrode. The

1 slope of the fitting line is 53.174, close to the Nernst theoretical value. The  
 2 correlation coefficient at  $R^2 > 0.996$ , indicated good linearity when fitting the  
 3 calibration curve. Figure 5 (b) shows the calibration results of  $\text{NH}_4^+$  electrode in  
 4  $\text{NH}_4\text{Cl}$  solution from  $10^{-5}$  to  $10^{-1}\text{M}$ . The potential gradient from  $10^{-5}$  to  $10^{-4}$  was a  
 5 little smaller compared with others, the slope of the fitting line from  $10^{-4}$  to  $10^{-1}\text{M}$   
 6 was 53.56 with a coefficient  $R^2 > 0.998$ , which is also close to the Nernst theoretical  
 7 value. The  $\text{Ag}/\text{Ag}_2\text{S}$  electrode has high detection limit. Figure 5 (c) shows the  
 8 calibration results in  $\text{Na}_2\text{S}$  solution from  $10^{-7}$  to  $10^{-1}\text{M}$ . The fitting line was 28.439  
 9 with a coefficient  $R^2 > 0.997$ .

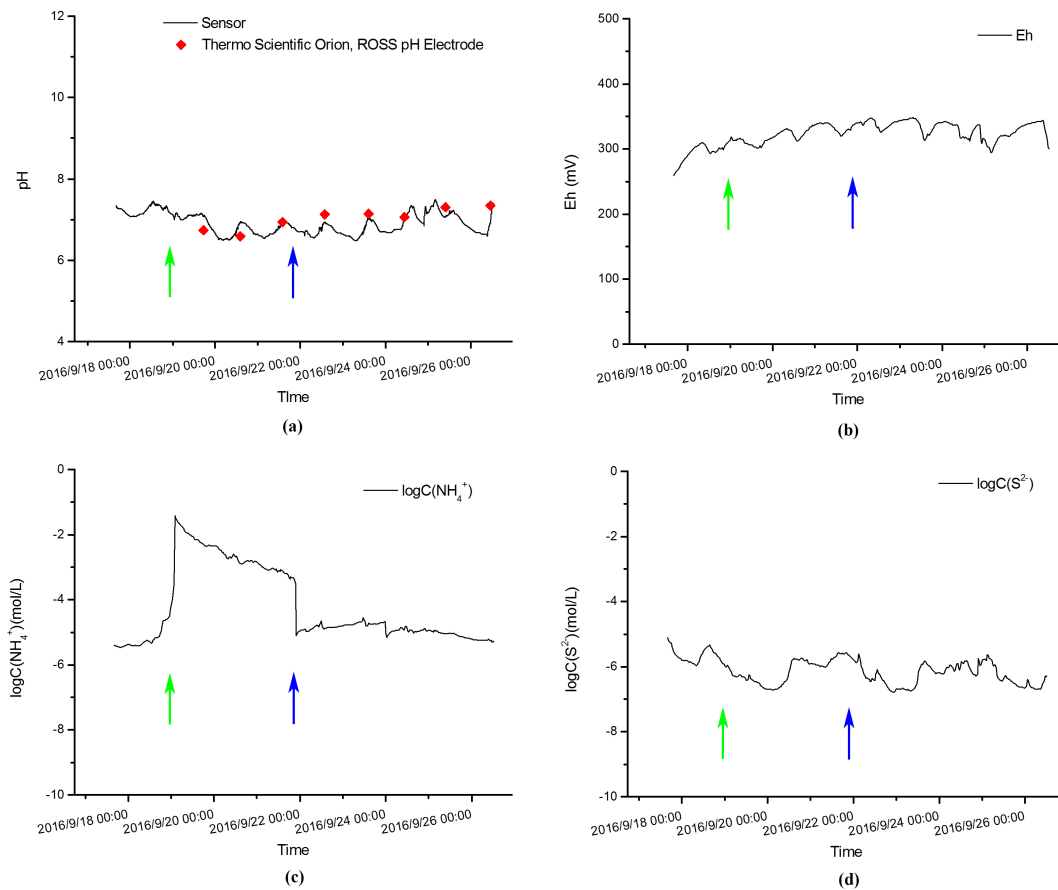

10

11 Figure 6 Concentration change between 2016/9/17 and 2016/9/26 in Trawsgoed (a) pH-time (b)  
 12 Eh(mV)-time (c)  $\log C(\text{NH}_4^+)$ (mol/L)-time (d)  $\log C(\text{S}^{2-})$ (mol/L)-time. The green arrow indicates when  
 13 slurry was applied to adjacent fields and the blue arrow a period of heavy rain.

14

15 **Measuring environmental pH value change**

1 As an initial indication of sensor performance, the pH detected by the sensor at  
 2 Trawsgoed farm was compared to that detected by a glass pH electrode with an  
 3 internal reference solution. The pH values for the measuring period ranged  
 4 between 6.5 and 7.4 (Figure 6 (a)). Table 1 compared the result of pH value  
 5 tested by pH probe and sensor the latter showed as red spots in Figure 4. The  
 6 average difference of pH value between pH probe and Sensor was 0.18, which  
 7 reveals the accuracy of the pH electrode of the sensor. In table 1, pH given by the  
 8 probe is in the range between 6.6 to 7.36; while that given by the sensor is between  
 9 6.89 to 7.20. It seems that the latter is more stable.

10  
 11

Table 1 Comparison of pH values obtained using the pH probe and Sensor

Time	Temperature (°C)	pH		Variation (%)
		pH probe <sup>1</sup>	Sensor <sup>2</sup>	
2016/09/19 17:33	16.0	6.75	7.08	4.89%
2016/09/20 14:00	18.0	6.60	6.94	5.15%
2016/09/21 13:50	18.0	6.95	6.89	0.86%
2016/09/22 13:44	16.0	7.14	6.94	2.8%
2016/09/23 14:40	17.6	7.16	7.09	0.98%
2016/09/24 10:44	17.7	7.07	7.08	0.14%
2016/09/25 10:00	13.0	7.32	7.07	3.42%
2016/09/26 11:52	13.9	7.36	7.20	2.17%

12 <sup>1</sup> pH value given by Thermo Scientific Orion, ROSS pH Electrode

13 <sup>2</sup> pH value given by the sensor

14

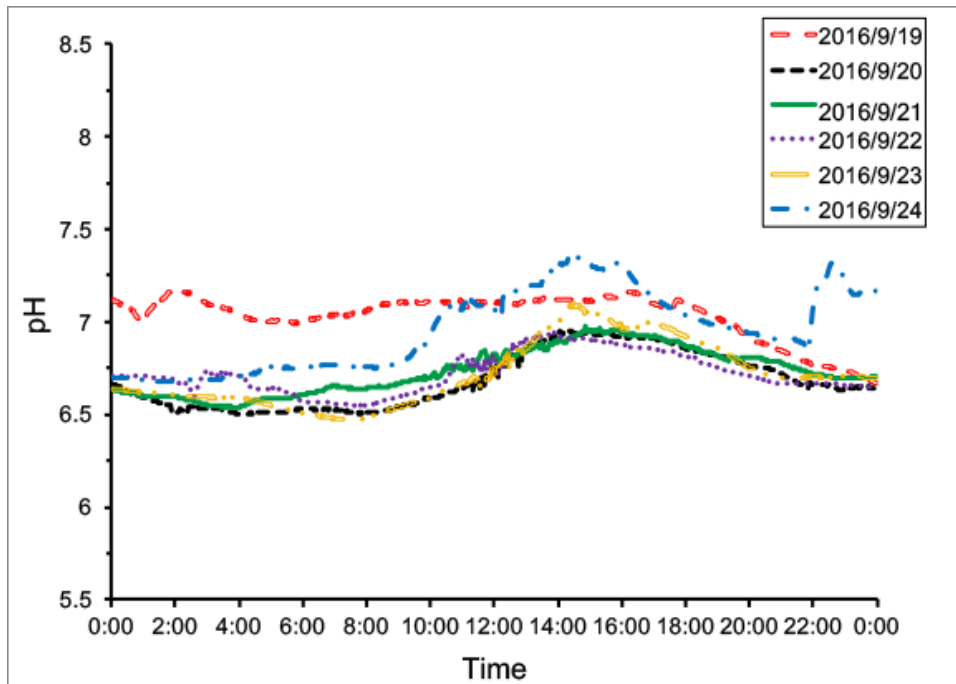

Figure 7 Changes in 24-hour pH value changes in Trawsgoed

Examining the sensor derived pH values over a diurnal cycle indicated a regular daytime rhythm (Figure 7). It decreased to the lowest value at around pH 6.5 at ~ 6:40 AM in the morning and increases to a peak at around 7.2 at 14:00 PM in the afternoon. Given that the sensor was located in an area of dense vegetation, this feature almost certainly reflected the shifting balance between respiration and photosynthesis. At night, plants absorb oxygen and produce carbon dioxide because of respiration to increase of  $H_2CO_3$  in water resulting in a decrease of pH. During daylight, plants absorb carbon dioxide and produce oxygen because of photosynthesis leading to a relative decline in  $H_2CO_3$  and increase in pH. The fact that this pattern was easily detected by the sensor is an indicator of its sensitivity in the detection of pH.

### Between pH-Eh.

Comparing Figure 6(a) and Figure 6 (b) shows how pH and Eh show contrasting trends; thus, Eh increases when pH decreases and decreases when pH rises. This

1 fits the negative correlation functional relationship between Eh and pH(Brookins,  
2 1988): $Eh=A-0.059pH$ , where A is a constant.

### 3 **NH<sub>4</sub><sup>+</sup> concentration change**

4 The concentration of NH<sub>4</sub><sup>+</sup>proved at Trawsgoed farm (Figure 6 (c)) proved to be  
5 stable at  $\sim 1.0 \times 10^{-5}M$  for the first two days of the measuring period. However,  
6 immediately after the injection of slurry into neighboring fields, the NH<sub>4</sub><sup>+</sup>  
7 concentration rose sharply to  $1.6 \times 10^{-2}M$  (Sep. 19<sup>th</sup>,2016). During the  
8 following days, this concentration appeared to be being diluted due to the  
9 continual flow of water in the area so that the NH<sub>4</sub><sup>+</sup> concentration fell progressively  
10 to  $3.9 \times 10^{-4} M$  by Sep. 21<sup>st</sup>. There was a rapidly decrease to  $1.6 \times 10^{-5}M$  which  
11 correlated with a rain shower in Sep. 21<sup>st</sup> evening which would have appeared to  
12 accelerate the dilution process. These results clearly indicate that the application  
13 of slurry increases the concentration of NH<sub>4</sub><sup>+</sup> in the stream and most likely in the  
14 Ystwyth River to which it is a tributary.

### 15 **4.5 S<sup>2-</sup> concentration change**

16 The concentration of S<sup>2-</sup> fluctuated slightly but average to  $\sim 1.0 \times 10^{-6} M$  (Figure 6  
17 (d)). This was quite a low concentration, which the application of slurry did not  
18 significantly change in the water.

19

## 20 **Conclusions**

21 An all-solid-state electrodes of Eh, pH, NH<sub>4</sub><sup>+</sup> and S<sup>2-</sup> was manufactured and  
22 mounted to a wireless chemical sensor with multiple parameters. Under  
23 laboratory conditions we demonstrated continuous and simultaneous  
24 measurement of Eh, pH, NH<sub>4</sub><sup>+</sup> and S<sup>2-</sup>.

1 The sensor was field tested in streams at Trawsgoed farm in Aberystwyth, UK. The  
2 result in Trawsgoed indicates that pH value exhibits regular daytime fluctuations  
3 due to plant metabolism. The average difference of pH value between a  
4 commercial pH probe and the constructed sensor was only 0.18. The trends of pH  
5 and Eh stay fitted with the known negative correlation functional relationship  
6 between Eh and pH. The concentration of  $\text{NH}_4^+$  rose sharply when slurry was  
7 applied to neighboring fields.

8 From above, the electrodes of sensor show high accuracy and sensitivity to certain  
9 ions. Regarding to the feature of small volume, less power consumption and low  
10 storage demand, the sensor will have a broad application in water environment  
11 detection.

12

### 13 **Acknowledgements**

14 This work was supported by Open Research Fund of Laboratory of Marine  
15 Ecosystem and Biochemistry, SOA (LMEB201701) and UK-China Joint Research  
16 and Innovation Partnership Fund (PhD Placement Programme). The authors  
17 would like to thank the staff at Trawsgoed Farm sites (Aberystwyth University) for  
18 their help during the measuring periods.

19

## 1 **References**

- 2 Brookins, D. G. 1988 *Eh-pH Diagrams for Geochemistry*. Berlin Heidelberg:  
3 Springer-Verlag.
- 4 Cattrall, R. W., & Freiser, H. 1971 Coated wire Ion Selective Electrodes. *Analytical*  
5 *Chemistry*, 43(13), 1905-1906.
- 6 Chen, D. C., Li, W. F., & Huang, J. Y. 2007 Preparation of a Tungsten Oxide pH  
7 Electrochemical Sensor Based on  
8 Solid Ag/AgCl Reference Electrode. *Chinese Journal of Sensors And Actuators*, 20(7),  
9 1483-1487.
- 10 Cheng, C., Tian, X., Guo, Y., Li, Y., Yuan, H., & Xiao, D. 2011 Large enhancement of  
11 sensitivity and a wider working range of glass pH electrode with amperometric  
12 and potentiometric responses. *Electrochimica Acta*, 56(27), 9883-9886.  
13 doi:10.1016/j.electacta.2011.08.065
- 14 Ding, Q., Pan, Y.-w., Huang, Y.-f., Chen, C.-T. A., & Ye, Y. 2015 The optimization of  
15 Ag/Ag<sub>2</sub>S electrode using carrier electroplating of nano silver particles and its  
16 preliminary application to offshore Kueishan Tao, Taiwan. *Continental Shelf*  
17 *Research*, 111, 262-267. doi:10.1016/j.csr.2015.08.018
- 18 Gonçalves, M. A., Gonzaga, F. B., Fraga, I. C. S., de Matos Ribeiro, C., Sobral, S. P.,  
19 Borges, P. P., & de Carvalho Rocha, W. F. 2011 Evaluation study of different glass  
20 electrodes by an interlaboratory comparison for determining the pH of fuel  
21 ethanol. *Sensors and Actuators B: Chemical*, 158(1), 327-332.  
22 doi:10.1016/j.snb.2011.06.029
- 23 Goyal, S. S., Rains, D. W., & Huffaker, R. C. 1988 Determination of Ammonium Ion  
24 by Fluorometry or Spectrophotometry after On-Line Derivatization with o-  
25 Phthalaldehyde. *Analytical Chemistry*, 60(2), 175-179.
- 26 He, Z. K., Fuhrmann, B., Spohn, U. 2000 Coulometric microflow titrations with  
27 chemiluminescent and amperometric equivalence point detection  
28 Bromimetric titration of low concentrations of hydrazine and ammonium.  
29 *Analytica Chimica Acta*, 409, 83-91.
- 30 Huang, Y., Li, J., Yin, T., Jia, J., Ding, Q., Zheng, H., . . . Ye, Y. 2015 A novel all-solid-state  
31 ammonium electrode with polyaniline and copolymer of aniline/2,5-  
32 dimethoxyaniline as transducers. *Journal of Electroanalytical Chemistry*, 741, 87-  
33 92. doi:10.1016/j.jelechem.2014.12.041
- 34 Ip, Y. K., Chew, S. F., Wilson, J. M., & Randall, D. J. 2004 Defences against ammonia  
35 toxicity in tropical air-breathing fishes exposed to high concentrations of  
36 environmental ammonia: a review. *J Comp Physiol B*, 174(7), 565-575.  
37 doi:10.1007/s00360-004-0445-1
- 38 Michalska, A. 2012 All-Solid-State Ion Selective and All-Solid-State Reference  
39 Electrodes. *Electroanalysis*, 24(6), 1253-1265. doi:10.1002/elan.201200059
- 40 Mikhelson, K. N. 2013 *Ion-Selective Electrodes* (Vol. 81): Lecture Notes in Chemistry.  
41 Miloshova, M., Baltés, D., & Bychkov, E. 2003 New chalcogenide glass chemical

1 sensors for S<sup>2-</sup> and dissolved H<sub>2</sub>S monitoring. *Water Science and Technology*, 47(2),  
2 135-140.

3 Past Weather in Aberystwyth, Wales, United Kingdom. (2016). Retrieved from  
4 <https://www.timeanddate.com/weather/uk/aberystwyth/historic>

5 Primavera, A., Trovarelli, A., Andreussi, P., & Dolcetti, G. 1998 The effect of water in  
6 the low-temperature catalytic oxidation of hydrogen sulfide to sulfur over  
7 activated carbon. *Applied Catalysis A*, 173, 185-192.

8 Rey, M. A., Pohl, C. A., Jagodzinski, J. J., Q. E., Kaiser, & Riviello, J. M. 1998 A new  
9 approach to dealing with high-to-low concentration ratios of sodium and  
10 ammonium ions in ion chromatography. *Journal of Chromatography A*, 804, 201-  
11 209.

12 Tian, J. 2010. *Theory Analysis and Experiment Research on the Anti-bacterial and*  
13 *Anti-adhesion Activities of Polyaniline* (Master of Engineering), Chongqing  
14 University, Chongqing, China.

15 Xu, F., Li, H. y., & Wei, X. d. 2008 Determination of Ammonium Ion in Water by Ion  
16 Chromatography. *Environment and Ecology in the Three Gorges*, 1(3), 22-27.  
17 doi:10.14068/j.ceia.2008.03.003

18 Zhang, X., Ye, Y., Kan, Y., Huang, Y., Jia, J., Zhao, Y., . . . Qin, H. 2017 A new electroplated  
19 Ir/Ir(OH)<sub>x</sub> pH electrode and its application in the coastal areas of Newport Harbor,  
20 California. *Acta Oceanologica Sinica*, 36(5), 99-104. doi:10.1007/s13131-017-  
21 1064-5

22 Zhong, X., & Yexiang, L. 1998 Reference electrode for electrochemical studies in  
23 fused chloride. *The Chinese Journal of Nonferrous Metals*, 8(4), 109-113.

24 Zongming Xiu, Q. Z., Hema L. Puppala, Hema L. Puppala, Hema L. Puppala. 2012  
25 Negligible Particle-Specific Antibacterial Activity of Silver Nanoparticles. *Nano*  
26 *Letters*, 12(12), 4271-4275.

27