

Aberystwyth University

Quantum control and information processing

Gough, John Edward; Belavkin, Viacheslav P.

Published in:

Quantum Information Processing

DOI:

[10.1007/s11128-012-0491-7](https://doi.org/10.1007/s11128-012-0491-7)

Publication date:

2013

Citation for published version (APA):

Gough, J. E., & Belavkin, V. P. (2013). Quantum control and information processing. *Quantum Information Processing*, 12(3), 1397-1415. <https://doi.org/10.1007/s11128-012-0491-7>

General rights

Copyright and moral rights for the publications made accessible in the Aberystwyth Research Portal (the Institutional Repository) are retained by the authors and/or other copyright owners and it is a condition of accessing publications that users recognise and abide by the legal requirements associated with these rights.

- Users may download and print one copy of any publication from the Aberystwyth Research Portal for the purpose of private study or research.
- You may not further distribute the material or use it for any profit-making activity or commercial gain
- You may freely distribute the URL identifying the publication in the Aberystwyth Research Portal

Take down policy

If you believe that this document breaches copyright please contact us providing details, and we will remove access to the work immediately and investigate your claim.

tel: +44 1970 62 2400
email: is@aber.ac.uk

Noname manuscript No.
(will be inserted by the editor)

Quantum Control and Information Processing

John E. Gough · Viacheslav P. Belavkin

Received: 1st July 2011 / Accepted: XXXX

Abstract We review the recent developments in quantum control and its contribution to quantum information processing.

Keywords quantum control, quantum filtering, quantum stochastic processes

“Information is physical is one of the key messages, and, on a fundamental level, it is quantum physical.”

A. Furusawa and P. van Loock, Quantum Teleportation and Entanglement, 2011

“Thinking of a dynamical system as a behavior, and of interconnection as variable sharing, gets the physics right”

J.C. Willems, IEEE Control Systems Magazine, December, 2007

“The development of general principles of quantum control theory is an essential task for a future quantum technology”

J.P. Dowling and G.J. Milburn, Proc. Roy. Soc. 2003

1 Introduction

Behind the technological advances of the Twentieth Century have been several key conceptual revolutions in engineering science. Control Theory deals with optimization of performance of fixed systems through connection to a controller: while originating in Maxwell’s analysis the dynamics of governors,

J.E. Gough
Institute for Mathematics and Physics, Aberystwyth University, SY23 3BZ, Wales, UK.
E-mail: jug@aber.ac.uk

V.P. Belavkin
School of Mathematical Physics, Nottingham University, UK.
E-mail: Viacheslav.Belavkin@nottingham.ac.uk

the mathematical theory has been systematically developed to tackle a wide range of dynamical systems and its success has been based on the fact that it provides a mathematical framework for tackling universal issues in engineering abstracted from the underlying physical models. The introduction of the field of cybernetics by Norbert Wiener, in particular, identified the central role played by feedback based on information not just in control engineering, but throughout the sciences. Information Theory was likewise developed by Shannon to quantify information, and thereby demonstrate fundamental limits on signal processing and on information storage. It too quickly outgrew its origins in electrical engineering, and Shannon's theory was immediately applicable to generic problems in communication, and indeed relevant to fundamental issues in physical modelling.

When we look back at the history of physics in the Twentieth Century, we see that the main revolution was quantum theory and that this theory underwent two significant developmental stages, in the opening and closing decades of the Century respectively. Whilst the development of the (closed) theory by Heisenberg, Born, Schrödinger, Dirac and von Neumann is well documented, the later stage of the development effectively occurred only in recent times as a result of quantum theorists catching up with the progress of other fields. The key concepts that have been extended to the quantum domain in this regard include information theory and communications, estimation and filtering, computation, error correction, open irreversible systems modelling, probability and stochastic processes, and of course control. Much of this later stage of development preceded the current possibilities realized experimentally.

The problems in each of these areas can be formulated as the problems of finding an optimal information processing when the quantum nature of physical devices carried out the information is taken into account. The most sophisticated among them include the dynamical problems of quantum system optimization in real time when the feedback control based on the causal output processes is allowed. This is precisely the domain of quantum feedback control as a means to realize quantum information processing. Quantum computing has been a holy grail of quantum technology, though one that is likely to lead to important spin offs. At the present time of writing, there are several competing suggestions as to what will be the most useful physical platform on which to develop quantum information processing, each with significant advantages and drawbacks. This is a rather peculiar phase in the history of quantum technology as we are a long way from identifying the "industry standard" quantum components that would likely appear in any future quantum communication or computation device. Time will of course tell, but it is difficult to make predictions on future practical directions. It has been recently understood that quantum computation is also falls within the domain of quantum control as a form of quantum information processing when the purpose is to find optimal gates for achieving the best quantum state with the result of a desirable computation from a given initial state containing the initial computational data.

The success of classical engineering lies in no small measure to the fact that underlying principles can be extracted and applied widely in a substrate neutral fashion. More prosaically, engineers usually apply general principles and algorithms that are valid for a large class of physical system. An example of where this has carried over into quantum technology is quantum circuit modelling which allows theorists to devise quantum computational algorithms wholly independently of the actually quantum hardware that might eventually be used. This leads us to systematic study of quantum control theory. Elements of classical control have of course been used in quantum experiments for a long time, however, increasingly sophisticated experiments require a more detailed analysis, even requiring an appropriate quantum description. By analogy with engineering classical systems, it seemed natural to try and develop a dedicated control theory for quantum systems which would ideally be of a universal character. This would of necessity take into account the features of the quantum world, of measurement and estimation of quantum systems, the feedback processing of quantum information, and the manipulation and actuation of quantum systems by their environment. Such an endeavour was begun in the 80's by one of the authors [5],[6],[7] on quantum filtering and feedback control in an algebraic setting unifying classical and quantum theories. However quantum information is physical and physicists do not like to think in terms of algebraic abstractions! Despite the allure of a conceptual framework of general theories of quantum information and of quantum control, much of the key work by the current contenders has been inevitably based on the specifics of particular physical setups. Nevertheless, the development of general quantum control principles will necessarily inform future quantum technologies. In this introduction to the subject, we shall emphasize the universal principles in physical examples. To some extent this an ongoing program is still speculative as the current state of physical quantum control is strikingly dissimilar to its classical counterpart: one major anomaly is the fact that modern classical control deals almost exclusively with feedback system, whereas this features in only a relatively small fraction of theoretical work on quantum control, and even rarer in experiment. However, we would argue that this is only a temporary situation, and that the future development of the field will see the powerful insights of classical control theory emerging again in the quantum setting.

2 Quantum Control

Following standard engineering terminology, we refer to the designated system which we aim to control as the plant, and the system used to alter the dynamics of the plant as the controller. The combined plant and controller form either an open loop or closed loop control system depending on whether or not the controller utilizes feedback about the plant's state.

The open loop quantum control theory is principally concerned with Hamiltonian controls, generically implemented through a controlled Hamiltonian of

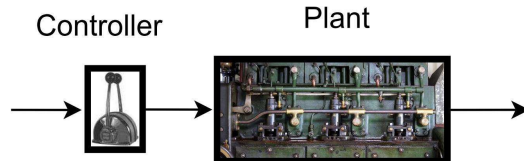

Fig. 1 Open loop control: the controller actuates the plant based on a predetermined input independent of the actual state of the plant.

the form

$$H(t) = H_0 + \sum_{j=1}^n H_j u_j(t) \quad (1)$$

with H_0, H_1, \dots, H_n fixed self-adjoint operators and u_1, \dots, u_n the predetermined control functions, or policies. There are various definitions of controllability - that is, the extent to which one may steer one state to another using appropriate choices of control policies. This is naturally a bilinear control problem and the characterization inevitably involves examining the Lie algebra generated by the skew-adjoint operators $-iH_\alpha$ with commutator as Lie bracket [17].

In the closed loop situation, the feedback may be entirely dynamical (that is, the plant and controller form a single dynamical system and the controller with the two influencing each other through direct interaction). We refer to this as *coherent control*. Alternatively the feedback may be entirely information theoretic insofar as the controller gains information about the plant due to measurement of the plant. This is *measurement based control*.

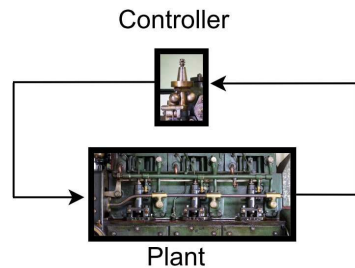

Fig. 2 Closed loop (coherent) control: the controller actuates the plant using information it obtains through interaction with the plant.

Normally this distinction is not made classically, however it is fundamental in quantum control due to the non-trivial effect of the measurement process.

The simplest implementation of coherent control is to consider the plant and controller as an isolated system with Hamiltonian

$$H = H_P \otimes I_C + I_P \otimes H_C + V_{PC} \quad (2)$$

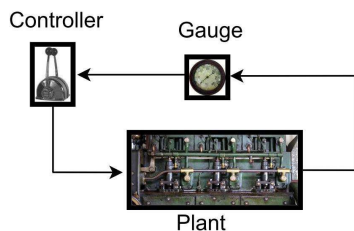

Fig. 3 Closed loop (measurement-based) control: the controller actuates the plant using information it obtains through measurement of the plant.

where V_{PC} gives the nontrivial coupling of the plant and controller. This set up initially proposed by Seth Lloyd [45], and it is important to note that both plant and controller are quantized.

It is however more advantageous to consider the coupling between the plant and controller to be mediated by fields, [63]. Again we should aim for a fully quantum model. In the standard bilinear model (1), this would mean replacing the policies u_j by quantum input processes which act as carriers for the signals - or more exactly as carriers of the influence of dynamical operators between the plant and controller. This essentially means that we have an open systems model. To build up a tractable mathematical model it is best to take the overall model to be Markovian.

2.1 Markov Models

Our restriction to Markovian models is not just for mathematical convenience, as they in fact turn out to offer extremely good approximation to quantum optical models. It is natural to focus on photonics as being arguably the most natural choice for developing quantum information processing, see for instance [51].

A single Markov component is parameterized by a triple (S, L, H) consisting of:

- the **System Hamiltonian** H ;
- **Coupling operators** $L = [L_j]$ between the system and the field;
- **Scattering operators** $S = [S_{jk}]$, unitary.

The input-output component is sketched in figure 2.1.

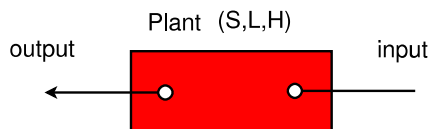

Fig. 4 Input-Output device with system parameterized by (S, L, H) .

In the case of a single input and output, we associate the unitary adapted quantum stochastic evolution

$$dU_t = (S - I)U_t d\Lambda(t) + LU_t dB(t)^\dagger - L^\dagger S U_t dB(t) - \left(\frac{1}{2}L^\dagger L + iH\right)U_t dt,$$

where $B^\dagger(t)$, $B(t)$ and $\Lambda(t)$ are the fundamental processes of creation, annihilation and conservation introduced by Hudson and Parthasarathy [34]. The non-vanishing products of Itô differentials are [34]

$$\begin{aligned} dBdB^\dagger &= dt, \quad dBd\Lambda = dB, \\ d\Lambda dB^\dagger &= dB^\dagger, \quad d\Lambda d\Lambda = d\Lambda. \end{aligned}$$

The state dynamics then corresponds to the associated Heisenberg equations of motion for $j_t(X) = U_t^\dagger(X \otimes 1)U_t$

$$\begin{aligned} dj_t(X) &= j_t(S^\dagger X S - X)d\Lambda(t) + j_t(S^\dagger[X, L])dB(t)^\dagger \\ &\quad + j_t([L^\dagger, X]S)dB(t) + j_t(\mathcal{L}X)dt \end{aligned}$$

where the Lindblad superoperator is

$$\mathcal{L}X = \frac{1}{2}[L^\dagger, X]L + \frac{1}{2}L^\dagger[X, L] - i[X, H].$$

The output field is then defined to be $B_{\text{out}}(t) = U_t^\dagger(1 \otimes B(t))U_t$ and from the quantum Itô calculus we have [34]

$$dB_{\text{out}}(t) = j_t(S)dB(t) + j_t(L)dt. \quad (3)$$

The pair of equations (3) and (3) are then the quantum mechanical analogues of the system dynamical equation and then output equation respectively.

We may readily extend the above to the multi-channel input/output case:

$$B = \begin{bmatrix} B_1 \\ \vdots \\ B_n \end{bmatrix}, \quad S = \begin{bmatrix} S_{11} & \cdots & S_{1n} \\ \vdots & \ddots & \vdots \\ S_{n1} & \cdots & S_{nn} \end{bmatrix}, \quad L = \begin{bmatrix} L_1 \\ \vdots \\ L_n \end{bmatrix}$$

The special case where $L = 0$ and $H = 0$ corresponds to a beam splitter, for example, with $n = 2$

$$\begin{bmatrix} B_1^{\text{out}} \\ B_2^{\text{out}} \end{bmatrix} = \begin{bmatrix} S_{11} & S_{12} \\ S_{21} & S_{22} \end{bmatrix} \begin{bmatrix} B_1 \\ B_2 \end{bmatrix}.$$

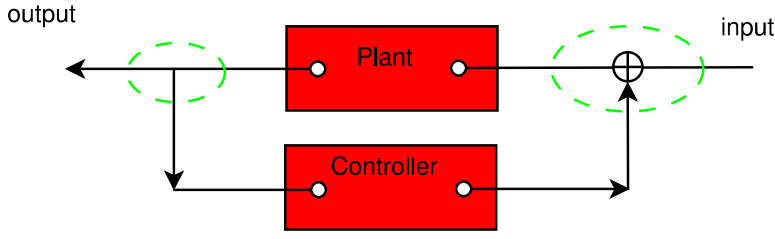

Fig. 5 classical feedback diagram: the junctions circled are not implementable in the quantum setting as they correspond to copying of information. Instead, they must be replaced by unitary junctions such as a beam splitter.

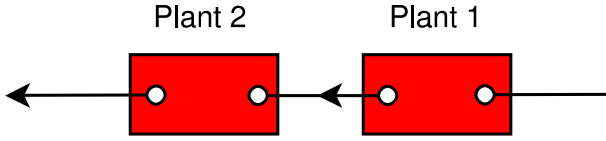

Fig. 6 Two systems in cascade.

2.2 Networks

The diagram in figure 5 below illustrates the classical feedback set up found in standard engineering texts.

The simplest form of a network consists of two cascaded systems as shown in figure 6. The $S = I$ case was initially studied by Carmichael [16] and Gardiner [23], and we treat the general case now.

In the limit of instantaneous feedforward we have

$$dB_{\text{out}}^{(2)} = S_2 dB_{\text{in}}^{(2)} + L_2 dt = S_2 (S_1 dB_{\text{in}}^{(1)} + L_1 dt) + L_2 dt = S_2 S_1 B_{\text{in}}^{(1)} + (S_2 L_1 + L_2) dt$$

The cascaded system in the *instantaneous feedforward* limit is in fact equivalent to the single component [27]

$$(S_2, L_2, H_2) \triangleleft (S_1, L_1, H_1) = (S_2 S_1, L_2 + S_2 L_1, H_1 + H_2 + \text{Im} \{ L_2^\dagger S_2 L_1 \}) .$$

which is referred to as the *Series Product* of the two models [27].

2.2.1 Bilinear Hamiltonians

The following construction, based on an idea of Wiseman and Milburn [63], shows how the series product gives rise to bilinear Hamiltonians of the form (1) generically [29]

$$(I, u(t), 0) \triangleleft (-I, 0, 0) \triangleleft (I, L, 0) \triangleleft (-I, 0, 0) \triangleleft (I, -u(t), 0) \triangleleft (I, L, 0) = (I, 0, H(t))$$

where

$$H(t) = \text{Im}\{L^\dagger u(t)\} = \frac{1}{2i}L^\dagger u(t) - \frac{1}{2i}Lu(t)^*.$$

2.2.2 Beamsplitter Feedback

We illustrate briefly the role of beamsplitter feedback. This is a special case of the more general problem of feedback reduction described in [28]. Here we consider a simple network consisting of a beamsplitter $S = \begin{bmatrix} S_{11} & S_{12} \\ S_{21} & S_{22} \end{bmatrix}$, and an in-loop component $(S_0, L_0, 0)$:

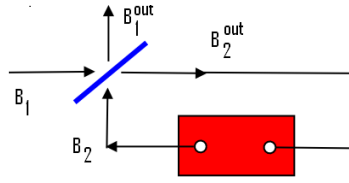

Fig. 7 Component in a feedback loop constructed using a beam splitter.

Again assuming the instantaneous feedback limit, we have

$$\begin{aligned} dB_2 &= S_0 dB_2^{\text{out}} + L_0 dt = S_0(S_{21} dB_1 + S_{22} dB_2) + L_0 dt \\ \Rightarrow dB_1^{\text{out}} &= S_{11} dB_1 + S_{12} dB_2 \equiv \hat{S}_0 dB_1 + \hat{L}_0 dt \end{aligned}$$

where

$$\hat{S}_0 = S_{11} + S_{12}(I - S_0 S_{22})^{-1} S_0 S_{21}, \quad \hat{L}_0 = S_{12}(I - S_{22})^{-1} S_0 L_0.$$

This leads to an equivalent component $(\hat{S}_0, \hat{L}_0, \hat{H}_0)$. The form of \hat{H}_0 is given in [28].

3 Direct Coupling Measurement Control

We start with an example introduced by Wiseman and Milburn [63]. This is a double-pass of a quantum light field through a plant and can be modelled as the following series product:

- 1st pass - (I, L, H_0)
- 2nd pass - corresponding to $U(t + dt, t) = \exp\{-iFdJ(t)\}$.

Here the detector measures a component $J(t)$ of the output field from the first pass (either a quadrature or the photon number count) which is then fed in a second time as a direct proportional Hamiltonian term: this was the original interpretation of Wiseman and Milburn. Formally $J(t)$ is singular so we interpret as generating a stochastic unitary process U as outlined above.

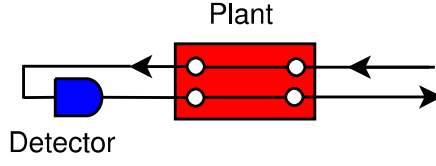

Fig. 8 Direct measurement feedback scheme of Wiseman and Milburn.

The cases of homodyne and photon counting may be treated separately:

Homodyne detection, $J(t) = B(t) + B(t)^\dagger$, $(dJ)^2 = dt$, 2nd pass is $(I, -iF, 0)$. The closed loop model is

$$(I, -iF, 0) \triangleleft (I, L, H_0) = \left(I, L - iF, H_0 + \frac{1}{2} (FL + L^\dagger F) \right);$$

Photon counting, $J(t) = A_t$, $(dJ)^2 = dJ$, 2nd pass is $(S = e^{-iF}, 0, 0)$. The closed loop model is

$$(S, 0, 0) \triangleleft (I, L, H_0) = (S, SL, H_0).$$

3.1 Quantum Filtering

Classically, filtering is the problem of obtaining a best causal estimate of a hidden signal given partial observations. The problem may involve noise in both the dynamics of the system generating the signal, and in the process of observation itself. The original problem tackled by Wiener [60] and Kolmogorov [44] in linear stationary setting was to try and filter out background stationary noise added onto a given stationary signal. The next step was made by Stratonovich who showed that the dynamical state vector of a noisy conditionally Markovian system could be estimated recursively from noisy observations, and this recurrence could be finitely solved at least for linear Markovian systems with additive Gaussian noise as it was done in the linear setting also by Kalman. The general theory of nonlinear filtering was subsequently developed in time continuous setting by Stratonovich, Kallianpur, Striebel, Zakai, and others. This all was extended in the end of 80's by Belavkin to the quantum conditionally Markov setting in a series of papers [6],[7],[8],[10].

3.1.1 The Classical Filtering Problem

We consider a noisy dynamical system with random state X_t , where we make indirect partial observations. This we assume to be described by a pair of stochastic differential equations:

$$\text{Unobserved system state } dX_t = v(X_t) dt + dW_X;$$

$$\text{Observation process } dY_t = h(X_t) dt + dW_Y.$$

We also assume that the row $W_t^\top = (W_X^\top, W_Y^\top)$ is a multi-dimensional Wiener process and that $\dim W_t = \dim X_t + \dim Y_t$, and that

$$dW_t dW_t^\top = \Sigma dt = \begin{bmatrix} \Sigma_{XX} & \Sigma_{XY} \\ \Sigma_{YX} & \Sigma_{YY} \end{bmatrix} dt$$

with Σ invertible. It follows that (X_t) is a diffusion process with generator $\mathcal{L} = v^i \partial_i + \frac{1}{2} \Sigma_{XX}^{ij} \partial_{ij}^2$.

The goal is to obtain the least squares estimate for a given function $f(X_t)$ of the state based on the causal observations Y_s , for $0 \leq s \leq t$, and this is the conditional expectation of $f(X_t)$ with respect to the σ -algebra of subsets \mathcal{F}_t^Y generated by these observations:

$$\pi_t(f) = \mathbb{E} \left[f(X_t) | \mathcal{F}_t^Y \right].$$

In particular, a tractable differential equation for $\pi_t(f)$ is desirable. One convenient formal (though may no means necessary) approach is to adopt a path integral formalism: the marginal distribution for (X_t) , $dX_t = v(X_t) dt + dW_X$ is

$$\rho_X(x, t) = \int_{C_0^x[0, t]} e^{-\int_0^t \mathcal{L}_X(x, \dot{x}) \mathcal{D}\mathbf{x}},$$

where the ‘‘Lagrangian’’ is $\mathcal{L}_X(x, \dot{x}) = \frac{1}{2} [\dot{x} - v(x)]^\top \Sigma_{XX}^{-1} [\dot{x} - v(x)] + \frac{1}{2} \nabla v(x)$.

The joint distribution of the state observation pair is then

$$\begin{aligned} \rho_{XY}(x, y, t) &= \int_{C_0^x[0, t] \times C_0^y[0, t]} e^{-\int_0^t \mathcal{L}(x, \dot{x}; y, \dot{y}) \mathcal{D}\mathbf{x} \mathcal{D}\mathbf{y}}, \\ \mathcal{L}(x, \dot{x}, \dot{y}) &= \frac{1}{2} [\dot{x} - v(x), \dot{y} - h(x)]^\top \Sigma^{-1} \begin{bmatrix} \dot{x} - v(x) \\ \dot{y} - h(x) \end{bmatrix} + \frac{1}{2} \nabla v(x) \\ &= \mathcal{L}_X(x, \dot{x}) + \frac{1}{2} \dot{y}^\top \Sigma_{YY}^{-1} \dot{y} - h(x)^\top \Sigma_{YY}^{-1} \dot{y} + \frac{1}{2} h(x)^\top \Sigma_{YY}^{-1} h(x) \end{aligned}$$

We may therefore write the Kallianpur-Striebel relation

$$\pi_t(f) = \left. \frac{\int_{C_0^x[0, t]} f(x_t) L_t(\mathbf{x}|\mathbf{y}) e^{-\int_0^t \mathcal{L}_X(x, \dot{x}) \mathcal{D}\mathbf{x}}}{\int_{C_0^x[0, t]} L_t(\mathbf{x}|\mathbf{y}) e^{-\int_0^t \mathcal{L}_X(x, \dot{x}) \mathcal{D}\mathbf{x}}} \right|_{\mathbf{y}=Y(\omega)} = \frac{\varpi_t(f)}{\varpi_t(1)}$$

where $\varpi_t(f)(\omega) = \int_{C_0^x[0, t]} f(x_t) L_t(\mathbf{x}|Y(\omega)) e^{-\int_0^t \mathcal{L}_X(x, \dot{x}) \mathcal{D}\mathbf{x}}$, and we have the Kallianpur-Striebel likelihood

$$L_t(\mathbf{x}|\mathbf{y}) = \exp \int_0^t \left\{ h(x)^\top \Sigma_{YY}^{-1} dy - \frac{1}{2} h(x)^\top \Sigma_{YY}^{-1} h(x) dt \right\}.$$

This formula may rigorously be deduced through the standard techniques of integration with respect to the Wiener measure for Brownian motion.

Using the Kallianpur-Striebel relation one may readily derive Stratonovich-Kushner nonlinear filter equation

$$d\pi_t(f) = \pi_t(\mathcal{L}f) dt + \left[\pi_t(fh^\top) - \pi_t(f)\pi_t(h^\top) + \pi_t\left((\nabla f)^\top \Sigma_{XY}\right) \right] \Sigma_{YY}^{-1} d\tilde{Y}_t,$$

where \tilde{Y}_t are the innovations: $d\tilde{Y}_t = dY_t - \pi_t(h) dt$, from Zakai linear stochastic equation

$$d\varpi_t(f) = \varpi_t(\mathcal{L}f) dt + \varpi_t\left(fh^\top + (\nabla f)^\top \Sigma_{XY}\right) \Sigma_{YY}^{-1} dY_t$$

for the posterior state ϖ_t normalized to the probability density $\varpi_t(1)$ of the passed output process $Y^t = (Y_r)_{r \leq t}$ for the initial condition $\varpi_0 = \pi_0$.

3.1.2 Quantum causal estimation

In a given experiment, we may consistently measure only a commuting set of observables. Let us denote the von Neumann algebra generated by the measured observables up to time t as \mathcal{M}^t - this will be an increasing commutative algebra. The noncommutative von Neumann algebra of all observables on a Hilbert space will be denoted as \mathcal{A} , and we may ask when is it possible to estimate an observable $X \in \mathcal{A}$ from the measured data at a particular time t . In principle, if X does not commute with measurement observables then it cannot be given a joint probability distribution with these observables, and it does not make sense statistically to talk about an estimate for X based on the past measurements. We therefore restrict the set of observables we may estimate and control from \mathcal{A} at a given t down to the subalgebra \mathcal{A}_t of just the observables that are compatible with the measurements obtained up to time t . Mathematically this means that we may estimate an observable $X \in \mathcal{A}$ if and only if it belongs to the commutant $\mathcal{A}_t = \{X \in \mathcal{A} : [X, Y(r)] = 0 \text{ for all } r \leq t\}$ of the increasing set $Y^t = \{Y(r) : r \leq t\}$ generating \mathcal{M}^t , which is equivalent to the condition $\mathcal{M}^t = \mathcal{A}'_t$ including $\mathcal{M}^t \subseteq \mathcal{A}_t$. Typically the set of observables Y^t is not complete for a finite t , so the commutative algebra \mathcal{M}^t is not maximal, having the strictly bigger commutant $\mathcal{A}_t \supset \mathcal{M}^t$ in which there are plenty of noncommutative observables including all interesting future Heisenberg observables which can be causally estimated on the measurement data at each t .

Thus, we have arrived to the first fundamental Causality Principle of quantum feedback control which was formulated by Belavkin [6],[12] in the form of Quantum Nondemolition Principle: *The controllable by estimation observables $X(t)$ must commute with all the compatible actual observables Y^t up to the time t : $[X(t), Y(r)] = 0$ for all $r \leq t$.* This puts all the feedback control theory into the paradigm of Eventum Mechanics (EM) as a quantum theory of an open system extended to include an interaction with the environment (quantum noise) but restricted to only the causal controllable algebras of interest \mathcal{A}_t containing at the center the classical output algebras \mathcal{M}^t . In other

words, EM is a semi-quantum mechanics of open controlled quantum systems enhanced by the observable events of the classical output processes $Y(t)$ which must be causal in the sense of compatibility with the future observables $X(t') \in \mathcal{A}_{t'} \subseteq \mathcal{A}_t$, $t' \geq t$. (See more on this by Belavkin in the present volume.) Note time asymmetry of this quantum causality condition, without this asymmetry there is no nontrivial feedback controlled quantum models: a purely quantum controlled system with the Heisenberg observables $X(t)$ commuting with all, not only the past output observables $Y(t)$ cannot interact with any classical system described by all $Y(t)$.

The error of an estimator $\hat{X} \in \mathcal{M}^t$ for a single observable $X \in \mathcal{A}_t$ is given as $\mathbb{E} \left[(\hat{X} - X)^2 \right]$ and the optimal estimator is the conditional expectation

$$\hat{X} = \mathbb{E}[X|\mathcal{M}]. \quad (4)$$

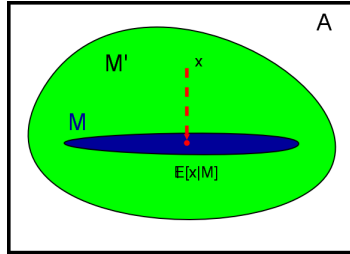

Fig. 9 Conditional expectation of observable $X \in \mathcal{M}'$ into the measurement algebra \mathcal{M} . Note that the measurement compatible algebra \mathcal{M}' is not commutative. The conditional expectation is projective onto the measurement algebra \mathcal{M} .

Note that unlike the classical case the conditional expectation in quantum probability may not exist for arbitrary subalgebra $\mathcal{M}^t \subseteq \mathcal{A}$, however, in the paradigm of EM $\mathbb{E}[\cdot|\mathcal{M}]$ is well-defined so long as its domain is restricted to the reduced subalgebra $\mathcal{A}_t = \mathcal{M}'$ of observables compatible with the measurement algebra \mathcal{M}^t . In fact, for given Hermitian $X \in \mathcal{M}'$, the algebra generated by X and the elements of \mathcal{M} is commutative, so in a sense we are just doing ordinary classical conditioning. However, the set of measurement compatible observables \mathcal{M}' typically is itself a non-commutative algebra, and the construction of optimal estimates is not classical already for two canonical variables $X = (Q, P)$.

3.1.3 Quantum Filtering

We now recall the problem of quantum filtering as the causal estimation of a quantum open Markovian system. Here we measure an observable $Y(t)$ of the output field. Our aim is to estimate causally any observable X of the system at time t , that is $j_t(X) = U_t^*(X \otimes I)U_t$, from the observations up to time t .

Even for the much wider class of conditionally Markov problems discussed by Belavkin in this volume we have the non-demolition causality property

$$[j_s(X), Y(t)] = 0,$$

for all $s \geq t$. This implies that the causal estimation is well-posed since all observables of the system at time t are then compatible with the measured observables up to that time. That is, the measurement output algebra \mathcal{Y}^t as the commutative algebra generated by the observations $Y(s)$, $0 \leq s \leq t$ is contained in the commutant $\{j_s(X) : s \geq t\}'$ for any X at each time t .

The least square estimate of the $j_t(X)$ is then the conditional expectation

$$\pi_t(X) = \mathbb{E}[j_t(X) | \mathcal{Y}_t]$$

which satisfies the nonlinear quantum filtering equation first derived by Belavkin for diffusive and counting observations in [7],[8].

In the case of the standard diffusive measurement, the Belavkin quantum filter is given by

$$d\pi_t(X) = \pi_t(\mathcal{L}X)dt + \{\pi_t(XL + L^*X) - \pi_t(L + L^*)\pi_t(X)\} \\ \times [dY(t) - \pi_t(L + L^*)dt],$$

and in the case of the standard counting measurement the Belavkin equation can be written as

$$d\pi_t(X) = \pi_t(\mathcal{L}X)dt + \left\{ \frac{\pi_t(L^*XL)}{\pi_t(L^*L)} - \pi_t(X) \right\} [dY(t) - \pi_t(L^*L)dt].$$

Using a Kallianpur-Striebel relation $\pi_t(X) = \varpi_t(X)/\varpi_t(1)$ the first equations was also obtained in [4] from the Belavkin diffusive master equation

$$\varpi_t(X) = \varpi_t(\mathcal{L}X)dt + \varpi_t(XL + L^\dagger X) dY(t)$$

which is a quantum analog of the linear Zakai equation. Similarly in the standard counting measurement case one can start with the counting linear master equation [4]

$$d\varpi_t(X) = \varpi_t(\mathcal{L}X)dt + \{\varpi_t(L^*XL) - \varpi_t(X)\} dY(t).$$

It is of course entirely equivalent to give the corresponding conditioned state ϱ_t such that

$$d\pi_t(X) = \text{tr}\{\varrho_t X\},$$

for all observables X of the plant. The dynamical equation for ϱ is readily derived and is the usual stochastic master equation exhibited in the physics literature.

For the rigorous derivation of the general conditionally Markov quantum linear and nonlinear filtering equations see [8],[9–11]. After the solving of quantum filtering problem one deals only with the classical stochastic equations driven by $Y(t)$. Quantum feedback control problem can be tackled then along the usual lines of the classical stochastic control theory by filtering-control separation theorem as it is presented by Belavkin in this volume.

3.2 Filtering in Nonclassical States

The previous examples dealt with an input which was in the vacuum state, and much of the theory extends in an analogous manner to the case of a Gaussian field [9]. However, there has been considerable interest recently in non-classical field states, specifically, states corresponding to a single photon [59, 47, 48, 57] (or more generally Fock states) and superpositions of coherent states. The former can now be generated on demand using state of the art experimental techniques, while the latter correspond to so-called cat states.

The filtering problem for these non-classical states turns out to be tractable, see the contribution of Gough, James and Nurdin in this volume, where one employs an ancilla to extend the filter in an appropriate manner. The role of the ancilla may often be easily understood as a preparation device which takes the vacuum input and feeds out the non-classical field into the system of interest.

4 Measurement-Based Control

We now wish to address the issue of control of a quantum system (plant) based on a nondemolition continual measurement. As a control problem, we have to specify all the necessary details before we can attempt a solution, these are:

- the description of the plant including any additional noise if open;
- the description of the measurement apparatus, what is measured, how much the readout is to be passed onto the controller and what additional observational noise is present;
- what type of actuation the controller may apply to the system;
- the control objective!

The last point turns out to be crucial. Classical control theory utilizes feedback to a specified end, and history has taught us that the blind use of feedback tends to lead to instability and system failure. To have a properly defined control problem we must specify a prescribed cost to measure performance. Typically this cost will be random (this is necessarily the case here as the measurement readout is random) so we may for instance seek to minimize the average cost. The control problem is then to search over all possible controllers to find the optimal controller - that is the physical system which continuously processes the measurement readout, and actuates the system so that the cost is minimized. Without a control objective there can be no control problem!

In figure 10 below we sketch a cartoon of plant governed by a controller. We say that the separation principle applies if the optimal controller can be decomposed into a state estimator which produces an optimal state for the system based on the measurement readout up to a given time and an actuator which applies a given control policy to actuate the system based on the optimal state computed by the state estimator. The design problem for the controller

is then greatly simplified by the fact that we decompose the problem into two separate parts. The average cost problem is known to satisfy the separation principle (see [13], and the contribution of Belavkin to this volume).

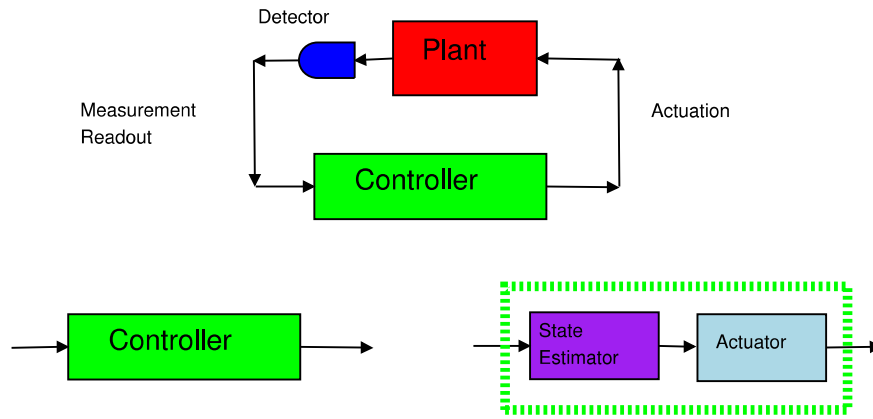

Fig. 10 The separation principle: the optimal controller can be considered as a state estimator and an actuator.

Measurement-based feedback control has been applied to the generation and stabilization of number states for photons [20,55] by the French group headed by S. Harouche and J.-M. Raimond. In particular, the theoretical issues surrounding stability and design considerations have been done by mainly by M. Mirrahimi and P. Rouchon [49, 1, 2].

While there has been considerable discussion on the estimation problem, especially given its relevance to quantum measurement and the foundations of quantum theory, the remaining part of the control problem has attracted much less attention and we would like to devote some additional space to it here. When the objective is to minimize an average cost, say a weighted time average of the expectation of an observable of a prescribed time interval, then the state estimator is then any machine capable of computing the filtered state ϱ_t that is the solution to the appropriate stochastic master equation. However, this is not always the case. We could alternatively have a cost which penalizes realizations where the performance cost is too high. One such problem is the risk sensitive cost which has been solved in the quantum case by Matthew James [35]. Here there is a separation principle, but the optimal state depends on the risk sensitivity parameter as well as the measurement readout.

From the purely operational point of view, quantum theory tells us how to compute probabilities for physical events. When handled properly, this fits into the overall operational approach that engineers adopt. However, while the optimal estimate of the state of the system at a particular time obviously depends on the measurement setup and readout, this is only half the story: it also depends on what your control objective is, and how you need to use the estimated state do steer the system in an optimal manner.

Measurement-based quantum control problems are in some sense more involved than just the traditional quantum measurement problem. Already conventional control is introducing unexpected foundational issues as now our best estimate of the plant may also depend on what the controller is trying to achieve. Essentially the controller has to be part of the model, just as much as the measurement apparatus, and we need to keep in mind that the whole control system is designed to optimize prescribed performance criteria.

It is worth stressing that the operational approach to quantum theory fits seamlessly with standard conventional engineering operational procedures. With this in mind, we propose the following version of Mermin's famous maxim for quantum feedback control, figure 11.

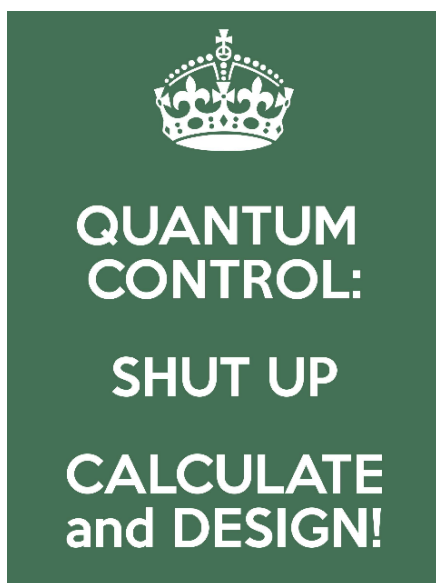

Fig. 11 The operational view of quantum feedback control.

5 Coherent Feedback Control

The main drawback of measurement-based control is that one is limited by the time taken to process the classical information coming from the measurement readout by a computer. Typically we must interface between the quantum plant and the macroscopic controller. While simple applications of quantum Kalman filtering have been done in real time with the variance computation done off-line, the implementation of more computationally intensive controllers is problematic. To achieve the high-performance criteria required in quantum information processing, it will be necessary to look beyond classical

measurement-based controllers and consider the fast, nanoscale devices instead. This takes us into the realm of quantum coherent feedback control. The quantum feedback network theory which we have outlined above is naturally suited to describing nanophotonic control systems driven by continuous-wave laser input fields.

General conditions for stability, passivity and L^2 gain for general quantum systems have been given by James and Gough [36] in a framework that extends the Willems' approach to control engineering. Mathematically, one works with operators now replacing state functions. Linear models arise for systems with canonical coordinates for which the triple (S, L, H) leads to a linear system of Heisenberg-Langevin equations and input/output relations: this happens when H is quadratic, L is linear, and S is independent of the canonical coordinates. In this case the performance specification becomes tractable and one may generalize some of the known results for classical linear systems for LQG problems and H^∞ control, see the surveys [19, 65] for more details. While the robust control problem turns out to be tractable in the quantum case, unfortunately the optimal LQG controller need not necessarily be physically realizable as a quantum input-system-output model, see [50] and [37].

Physical applications have been proposed by the MabuchiLab group [38, 56] and these include continuous-time quantum error correction schemes employing nanophotonic circuits to implement coherent-feedback, rather than measurement-based control. More recently, they have developed a hardware description language to implement the series product, concatenation, and feedback reduction operations introduced earlier [58]. This allows for the construction of arbitrary quantum optical networks modelled within the Markov assumption. The opportunity to design and synthesize quantum control components will hopefully be made greatly more powerful by these techniques.

From an engineering perspective, quantum control theory is slowly starting to resemble its classical counterpart. While the eventual quantum hardware and information processing methods will only emerge over the next decade or so, we can be encouraged that the principles of quantum engineering control are now being to take a definite shape.

Acknowledgement

The authors wish to thank Matthew James, Hendra Nurdin for several useful discussions on quantum control directions.

References

1. H. AMINI, M. MIRRAHIMI, P. ROUCHON, *On stability of continuous-time quantum-filters*, arXiv:1103.2706
2. ———, *Design of Strict Control-Lyapunov Functions for Quantum Systems with QND Measurements*, arXiv:1103.1365
3. A. BARCHIELLI, *Continual measurements in quantum mechanics*, Summer School on Quantum Open Systems 2003.

4. A. BARCHIELLI, V.P. BELAVKIN, *Measurements continuous in time and a posteriori states in quantum mechanics*, J. Phys. A: Math. Gen., 24 (1991), pp. 1495–1514.
5. V.P. BELAVKIN, *On the theory of controlling observable quantum systems*, Automatica and Remote Control **44**(2), 178–188 (1983)
6. ———, *Non-demolition measurement and control in quantum dynamical systems*, In: A. Blaquiere (ed.) Proc of C I S M Seminar on Information Complexity and Control in Quantum Physics, Udine 1985., pp. 311–329. Springer–Verlag, Wien–New York (1987)
7. ———, *Non-demolition measurements, nonlinear filtering and dynamic programming of quantum stochastic processes*, In: A. Blaquiere (ed.) Proc of Bellmann Continuum Workshop ‘Modelling and Control of Systems’, Sophia–Antipolis 1988, *Lecture notes in Control and Inform Sciences*, vol. 121, pp. 245–265. Springer–Verlag, Berlin–Heidelberg (1988)
8. ———, *Stochastic equations of quantum filtering*, In: B. et al. (ed.) Prob. Theory and Math. Statistics, vol. 1, pp. 91–109. ”Mokslas”, Vilnius (1990)
9. ———, *Quantum continual measurements and a posteriori collapse on the CCR*, Commun. Math. Phys., 146 (1992), pp. 611–635.
10. ———, *Quantum stochastic calculus and quantum nonlinear filtering*, J. Multivariate Analysis, 42 (1992), pp. 171–201.
11. ———, *Quantum diffusion, measurement, and filtering*, Theory Probab. Appl., 38 (1994), pp. 573–585.
12. ———, *Nondemolition principle of quantum measurement theory*, Foundation of Physics **24**(5), 685–714 (1994)
13. L. BOUTEN AND R. VAN HANDEL, *On the separation principle of quantum control*, in Proceedings of the 2006 QPIC Symposium, M. Guta, ed., World Scientific, math-ph/0511021 2006.
14. L. BOUTEN, R. VAN HANDEL, AND M. JAMES, *An introduction to quantum filtering*, SIAM J. Control and Optimization, 46 (2007), pp. 2199–2241.
15. R. BROCKETT, C. RANGAN AND A. M. BLOCH, *Controllability of Infinite Dimensional Quantum Systems*, Proceedings of Conference on Decision and Control, Hawaii, (2004).
16. H.J. CARMICHAEL, *Quantum trajectory theory for cascaded open systems*, Phys. Rev. Lett., **70**(15):2273–2276, (1993)
17. D. D’ALESSANDRO, *Introduction to Quantum Control and Dynamics*, 2008 Chapman and Hall
18. H. CARMICHAEL, *An Open Systems Approach to Quantum Optics*, Springer, Berlin, 1993.
19. D. DONG, I.R. PETERSEN, *Quantum control theory and applications: A survey*, arXiv:0910.2350v3 [quant-ph] 10 Jan 2011
20. I. DOTSENKO, M. MIRRAHIMI, M. BRUNE, S. HAROCHE, J.-M. RAIMOND, P. ROUCHON, *Quantum feedback by discrete quantum nondemolition measurements: Towards on-demand generation of photon-number states*, Phys. Rev. A 80, 013805 (2009).
21. J.P. DOWLING AND G.J. MILBURN, *Quantum technology: the second quantum revolution*, Phil Trans Roy. Soc. London (2003)
22. A. FURUSAWA AND P. VAN LOECK, *Quantum teleportation and Entanglement*, 2011, Wiley-VCH Verlag, Weinheim
23. C.W. GARDINER, *Driving a quantum system with the output field from another driven quantum system*. Phys. Rev. Lett., **70**(15):2269–2272, 1993.
24. C. GARDINER AND M. COLLETT, *Input and output in damped quantum systems: Quantum stochastic differential equations and the master equation*, Phys. Rev. A, 31 (1985), pp. 3761–3774.
25. C. GARDINER AND P. ZOLLER, *Quantum Noise*, Springer, Berlin, 2000.
26. N. Gisin, G. Ribordy, W. Tittel, and H. Zbinden, *Quantum cryptography*, Reviews of Modern Physics, 74 (2002), p. 145.
27. J.E. GOUGH, M.R. JAMES, *The Series Product and Its Application to Quantum Feed-forward and Feedback Networks* IEEE Transactions on Automatic Control, 2009.
28. J.E. GOUGH, M.R. JAMES, *Quantum Feedback Networks: Hamiltonian Formulation* Commun. Math. Phys., 1109–1132, Volume 287, Number 3 / May, 2009.
29. J.E. GOUGH, *Construction of bilinear control Hamiltonians using the series product and quantum feedback* Phys. Rev. A 78, 052311 (2008)

30. J.E. GOUGH, M.R. JAMES, AND H.I. NURDIN, *Quantum master equation and filter for systems driven by fields in a single photon state*. submitted to IEEE Conference on Decision and Control, 2011.
31. R. VAN HANDEL, J. STOCKTON, AND H. MABUCHI, *Feedback control of quantum state reduction*, IEEE Trans. Automatic Control, 50 (2005), pp. 768–780.
32. A. HOLEVO, *Quantum stochastic calculus*, J. Soviet Math., 56 (1991), pp. 2609–2624.
33. G.M. HUANG, T.J. TARN AND J.W. CLARK, *On the controllability of quantum-mechanical systems*, J. Math. Phys. 24, 2608-2618 (1983).
34. R. HUDSON AND K. PARTHASARATHY, *Quantum Ito's formula and stochastic evolutions*, Commun. Math. Phys., 93 (1984), pp. 301–323.
35. M.R. JAMES, *Risk-sensitive optimal control of quantum systems*, Phys. Rev. A 69, 032108 (2004)
36. M.R. JAMES, J.E. GOUGH, *Quantum dissipative systems and feedback control design by interconnection*, IEEE Trans. Automat. Control, 2010, 55(8):1806-1821
37. M.R. JAMES, H.I. NURDIN AND I.R. PETERSEN, H^∞ Control of Linear Quantum Stochastic Systems, IEEE Trans. Automat. Contr. 53 , 1787 (2008).
38. J. KERCKHOFF, D. S. PAVLICHIN, H. CHALABI AND H. MABUCHI, *Design of nanophotonic circuits for autonomous subsystem quantum error correction* arXiv:1102.3143v1 [quant-ph] 15 Feb 2011
39. N. KHANEJA, S.J. GLASER AND R.W. BROCKETT, *Sub-Riemannian geometry and optimal control of three spin systems*, Physical Review A, 65, 032301 (2002).
40. N. KHANEJA, S. J. GLASER, *Efficient transfer of coherence through Ising Spin chains*, Physical Review A, 66, 060301(R) (2002).
41. T. REISS, N. KHANEJA AND S.J. GLASER, *Time-Optimal Coherence-Order-Selective Transfer of In-Phase Coherence in Heteronuclear IS Spin Systems*, Journal of Magnetic Resonance, 154, 192-195 (2002).
42. N. KHANEJA, R.W. BROCKETT AND S.J. GLASER, *Time Optimal Control of Spin Systems*, Physical Review A, 63, 032308 (2001).
43. E. KNILL, R. LAFLAMME, AND G. MILBURN, *A scheme for efficient quantum computation with linear optics*, Nature, 409 (2001), pp. 46–52.
44. A.N. KOLMOGOROV, *Interpolation and Extrapolation of Stationary Random Sequences*, Bull. de l'Academie des sciences de U. S. S. R., Ser. Math., Vol. 5, 1941, pp. 3-14.
45. S. LLOYD, Phys. Rev. A 62, 02210 (2000).
46. H. MABUCHI AND N. KHANEJA, *Principles and applications of control in quantum systems*, Int. J. Robust Nonlinear Control 15, 647-667, (2005).
47. X. MAITRE, E. HAGLEY, G. NOGUES, C. WUNDERLICH, P. GOY, M. BRUNE, J. RAIMOND, AND S. HAROCHE, *Quantum memory with a single photon in a cavity*, Phys. Rev. Lett., 79 (1997), pp. 769–772.
48. G.J. MILBURN, *Coherent control of single photon states*, Eur. Phys. J. Special Topics, 159 (2008), pp. 113–117.
49. M. MIRRAHIMI, I. DOTSENKO, P. ROUCHON, *Feedback generation of quantum Fock states by discrete QND measures* IEEE Conference on Decision and Control, pp: 1451-1456, 2009
50. H.I. NURDIN, M.R. JAMES AND I.R. PETERSEN, *Coherent Quantum LQG Control*, Automatica 45 , 1837 (2009).
51. J.L. O'BRIEN, A. FURUSAWA, J. VUČKOVIĆ, *Photonic quantum technologies*, Nature Photonics, 3, 687 (2009)
52. K.R. PARTHASARATHY, *An Introduction to Quantum Stochastic Calculus*, Birkhauser, Berlin, 1992.
53. A.P. PEIRCE, M.A. DAHLEH AND H. RABITZ, *Optimal-control of quantum-mechanical systems - existence, numerical approximation, and applications,* Phys. Rev. A 37, 4950-4964 (1988).
54. H. RABITZ, R. DE VIVIE-RIEDLE, M. MOTZKUS AND K. KOMPA, *Chemistry - whither the future of controlling quantum phenomena?*, Science 288, 824-828 (2000).
55. C. SAYRIN, I. DOTSENKO, X. ZHOU, B. PEAUDECERF, T. RYBARCZYK, S. GLEYZES, P. ROUCHON, M. MIRRAHIMI, H. AMINI, M. BRUNE, J.-M. RAIMOND, S. HAROCHE, *Real-time quantum feedback prepares and stabilizes photon number states*, Nature **477**, 73-77 (1 september 2011)

56. G. SARMA, R. HAMERLY, N. TEZAK, D.S. PAVLICHIN, AND H. MABUCHI, *Transformation of quantum photonic circuit models by term rewriting*, arXiv:1206.1104v1 [quant-ph] 6 Jun 2012
57. J.F. SHERSON, C. WEITENBERG, M. ENDRES, M. CHENEAU, I. BLOCH, S. KUHR, *Single-Atom Resolved Fluorescence Imaging of an Atomic Mott Insulator*, Nature **467**, 68 (2010)
58. N. TEZAK, A. NIEDERBERGER, D.S. PAVLICHIN, G. SARMA AND H. MABUCHI, *Specification of photonic circuits using Quantum Hardware Description Language*, 2012 Preprint arXiv:1111.3081
59. J. VOLZ, M. WEBER, D. SCHLENK, W. ROSENFELD, J. VRANA, K. SAUCKE, C. KURT-SIEFER, AND H. WEINFURTER, *Observation of entanglement of a single photon with a trapped atom*, Phys. Rev. Lett., 96 (2006), p. 030404.
60. N. WIENER, *Extrapolation, Interpolation and Smoothing of Stationary Time Series*, John Wiley & Sons, Inc., New York, 1949.
61. J.C. WILLEMS, *The behavioral approach to open and interconnected systems*, IEEE Control Systems Magazine, December 2007
62. H. WISEMAN AND G. MILBURN, *Quantum theory of field-quadrature measurements*, Phys. Rev. A, 47 (1993), pp. 642–663.
63. H. M. WISEMAN AND G. J. MILBURN, *All-optical versus electro-optical quantum-limited feedback*. Phys. Rev. A, 49(5):4110-4125, (1994)
64. H. WISEMAN AND G. MILBURN, *Quantum Measurement and Control*, Cambridge University Press, Cambridge, UK, 2010.
65. G. ZHANG, M.R. JAMES, *Quantum Feedback Networks and Control: A Brief Survey*, arXiv:1201.6020v2 [quant-ph] 26 Feb 2012