



This is a repository copy of *Where are mines located in sub-Saharan Africa and how have they expanded overtime?*.

White Rose Research Online URL for this paper:  
<https://eprints.whiterose.ac.uk/162691/>

Version: Accepted Version

---

**Article:**

Ahmed, A.I., Bryant, R.G. [orcid.org/0000-0001-7943-4781](https://orcid.org/0000-0001-7943-4781) and Edwards, D.P. (2020) *Where are mines located in sub-Saharan Africa and how have they expanded overtime?* Land Degradation & Development. ISSN 1085-3278

<https://doi.org/10.1002/ldr.3706>

---

This is the peer reviewed version of the following article: Ahmed, A.I., Bryant, R.G. and Edwards, D.P. (2020), *Where are mines located in sub-Saharan Africa and how have they expanded overtime?*. Land Degrad Dev., which has been published in final form at <https://doi.org/10.1002/ldr.3706>. This article may be used for non-commercial purposes in accordance with Wiley Terms and Conditions for Use of Self-Archived Versions.

**Reuse**

Items deposited in White Rose Research Online are protected by copyright, with all rights reserved unless indicated otherwise. They may be downloaded and/or printed for private study, or other acts as permitted by national copyright laws. The publisher or other rights holders may allow further reproduction and re-use of the full text version. This is indicated by the licence information on the White Rose Research Online record for the item.

**Takedown**

If you consider content in White Rose Research Online to be in breach of UK law, please notify us by emailing [eprints@whiterose.ac.uk](mailto:eprints@whiterose.ac.uk) including the URL of the record and the reason for the withdrawal request.



[eprints@whiterose.ac.uk](mailto:eprints@whiterose.ac.uk)  
<https://eprints.whiterose.ac.uk/>

Full Title:

# Where are mines located in sub-Saharan Africa and how have they expanded overtime?

Short Title:

**Where are mines located in sub-Saharan Africa**

Authors:

**Abdulkareem I. Ahmed<sup>1\*</sup>, Robert G. Bryant<sup>2</sup>, David P. Edwards<sup>1</sup>**

<sup>1</sup>Department of Animal and Plant Sciences, University of Sheffield, Sheffield, S10 2TN, UK.

<sup>2</sup>Department of Geography, University of Sheffield, Sheffield, S10 2TN, UK

\*Corresponding author. E-mail address: [aiahmed2@sheffield.ac.uk](mailto:aiahmed2@sheffield.ac.uk)  
Tel. +447710222084

## Abstract

Mining is a multi-billion-dollar industry spanning major to artisanal and small-scale mines, with diverse local to regional socio-economic and environmental impacts. Sub-Saharan Africa (SSA) has large deposits of minerals, which has made it a global epicentre for investors in the extractive industries. Here, we identified and mapped 469 company-owned and community-managed mines across SSA, most of which are formal, to explore their distribution and areal extents and understand the potential threats they pose to conservation. The dominant eight commodities in SSA are gold, copper, iron, limestone, uranium, diamond, bauxite and petroleum, making up 405 mines and occupying 85% of the 3,055 km<sup>2</sup> total areal extent. Mining significantly expanded between 2000 and 2018, with 260 (58%)

This article has been accepted for publication and undergone full peer review but has not been through the copyediting, typesetting, pagination and proofreading process which may lead to differences between this version and the Version of Record. Please cite this article as doi: 10.1002/ldr.3706

Accepted Article

new mines created and major expansion of many older mines. Hotspots of mining activity are apparent in the copper-belt of the Democratic Republic of Congo and Zambia, Ghana, and the Niger-delta region of Nigeria. These mining ‘hotspots’ are distributed in close proximity to regions of high carbon stocks and value to biodiversity conservation, with the areal extent of mines more than doubling between 2000 and 2018 to 1192 km<sup>2</sup> within 10 km of a protected area, suggesting susceptibility to deforestation and other environmental consequences. The identification of mines and their changing spatial extent is imperative for monitoring future encroachments in SSA and to conservation and habitat recovery. Furthermore, Africa needs to introduce sustainable mineral development policies to safeguard and protect its forests, especially reducing the frequency of protected area downgrading, downsizing and degazettement (PADDD) events.

*Keywords: Mining locations, sub-Saharan Africa, ecological zones, protected areas, biodiversity conservation.*

## 1.1 INTRODUCTION

Mining is an important industry globally with diverse economic and environmental impacts (Werner et al., 2019). As a multibillion-dollar industry (Janneh & Ping, 2011) in sub-Saharan Africa (SSA), mining is a key source of employment and income for governments of most countries in the region. Mineral resources such as metals (including precious commodities [e.g. gold and PGM] and industrial commodities [e.g. copper, bauxite, tin and iron-ore]), gemstones, limestone, and many other industrial minerals [e.g. manganese and uranium; Taylor et al., 2009], can be found in large quantities and good quality within the tropical

region of SSA, making it among the world's major mineral producers (USGS,2018; Kinnaird et al., 2016). In addition, the region has high occurrence of petroleum resources.

The global demand for mineral and petroleum resources is increasing (Hammarstrom et al., 2006), attracting the major mining players to SSA where they invest heavily and develop infrastructure (Janneh & Ping 2011; Edwards et al., 2014). This investment has led to an unprecedented upsurge in mining activities in SSA. For instance, Chinese investments in African mining grew from \$15 billion to \$150 billion between 2000 and 2012 (CDF, 2016; Platform, 2016), while Canada, Australia, Brazil and others have also increased their investments within the last 20 years by an additional \$50 billion in over 600 mining projects in Africa (Edwards et al., 2014; Weng et al., 2013; Woods and Lane, 2015).

Under conditions of good governance, these huge investments are often laudable from a socio-economic perspective (but not if they cause the 'resource curse'), generating much needed development in poverty-afflicted areas. Provided conservation outcomes are incorporated in mining plans, as seen in parts of the Brazilian Amazon (Sonter et al., 2017), the coexistence of mining and biodiversity is also achievable with strict conservation regulations (Sonter, et al., 2018). Regional development can also reduce threats to biodiversity from over-hunting and habitat degradation (e.g. for wood fuel) for subsistence-use. However, with weaker governance, planning and regulation, or benefits that do not flow to the most marginalised in society, mines pose great threats to biodiversity conservation in the tropical regions of Africa (Edwards et al. 2014; Sonter et al., 2018).

In sub-Saharan Africa, artisanal and small-scale mining (ASM) occurs profusely, in part because of the high poverty rate of the region. In many cases, ASM operates in very inaccessible locations within the forest (Durán, Rauch, & Gaston, 2013). Nonetheless, mineral extraction is not counted as a major driver of deforestation (Sonter et al., 2017; Alvarez-Berrios and Mitchell Aide, 2015), because the footprint of both major and ASM mines occupy areas perceived as small when compared to other drivers of deforestation, yet the associated local-regional infrastructural and economic development attracts other activities whose potential impacts are far more widespread and insidious, especially agricultural expansion and hunting for trade (Kissinger et al., 2012; Ferretti-Gallon & Busch, 2014). The need to conserve forests and protected areas from mining by monitoring encroachments and its associated activities is imperative. A key necessity therefore is to thoroughly inventory known existing mining locations, with emphasis on their proximity to forests, watersheds and protected landscapes.

Previous studies have enumerated the occurrences of minerals on the continent (Durán et al., 2013; Edwards et al., 2014). For instance, Edwards et al. (2014) identified over 4,000 mineral occurrences in the Congo region, although most of such occurrences will not represent a mineable deposit. Much less is known about the present-day distribution of active mines, with very few geodatabases (e.g. MMSD Nigeria, USGS, globalforestwatch.org and Africaopendata.org) with comprehensive data about mining locations and dynamics. The lack of both coordination of numerous field datasets and, in turn, their use to interpret the full impacts of mining are some of the challenges to studying the secondary impacts of mining, such as deforestation and population immigration (Chatham House, 2015).

Some past studies on mining-induced deforestation in Africa were conducted at the national level (e.g. DRC, (Schure et al., 2011); Nigeria, (Merem et al., 2017)), others were commodity specific (e.g. gold, (Klubi et al., 2018)). Furthermore, a review of previous baseline surveys on ASM in some African countries (Heemskerk et al., 2004) showed a lack of reckonable data on the size and location of mines. The need for spatially accurate digital maps of the location and size of active and abandoned mines is principal, as part of enhanced measures for monitoring forest encroachment.

Key to quantifying the potential impacts of mines on environmental conservation is to understand whether their distribution overlaps with important habitats and protected areas. In the Peruvian Amazon, for example, gold mines were expanding at a rate of 21.7 km<sup>2</sup> per annum before 2008, but this suddenly rose to 61.5 km<sup>2</sup> per annum after the 2008 global economic crisis (Asner et al., 2013) with ~155 km<sup>2</sup> of forest lost to mining between 2003 and 2009 (Swenson et al., 2011). More broadly, across the Neotropics ~1680 km<sup>2</sup> of forest was lost to gold mining sites from 2001 to 2013 (Alvarez-Berrios & Mitchell Aide, 2015), while between 2001 and 2014, districts in India that produced coal, iron and limestone lost about 448 km<sup>2</sup> more forest cover. However, Ranjan (2019) showed that not all mineral extractions caused deforestation in India with, for instance, some of the districts that produced dolomite and manganese recording an increase in the forest area or an insignificant reduction.

Protected and unprotected forests are susceptible to expansion of mines in regions with high concentrations of mineral occurrences (Edwards et al., 2014), with vulnerability particularly high in countries with weak law enforcement and corrupt practices in mineral licensing. For instance, Golden Kroner et al. (2019) showed that over 3700 events of protected area

downgrading, downsizing, and degazettement (PADDD) were recorded globally between 1892 and 2018 (70% occurred between 2008 and 2018), of which resource extraction and development was responsible for 62% of events with known causes ( $n=3015$ ). Within SSA, the Democratic Republic of Congo permitted mineral extraction by enacting 41 PADDD events between 1960 and 2018 (Golden Kroner et al., 2019). Such PADDD events, among other factors, have led to forest cover loss in the DRC (Butsic et al., 2015) and elsewhere in SSA (Edwards et al., 2014).

In this study, we addressed the critical information gap about the spatial location and distribution of mines across SSA, and in turn identified the hotspots of mining and their proximity to areas of high biodiversity value. We used recently acquired high-resolution imageries (World Imagery ESRI, et.al, 2019. for 2009 to 2019) to delineate and measure the areal extents of individual mines to show their current sizes. We deduced additional information about each mapped mine (including name of mine, commodity, operator, date of creation, among others) using the recorded names of settlements in close proximity to the mine by searching a range of other sources (see Table 1). We used these data to address the following questions: (Q1) Where are mining hotspots in SSA? (Q2) What minerals are they extracting and how have these mines expanded overtime? (Q3) How close are these mines to forests and protected areas?

## **1.2 METHODS**

### **1.2.1 Description of Study Area and Workflow**

The study covers the tropical forest and woodland savannah regions of sub-Saharan Africa, comprising 37 countries as defined by the Food and Agricultural Organization (FAO, 2016). The study region (Figure 1a) covers an area of 20.25 million km<sup>2</sup>, which is ~67% of the entire African continent and has an estimated population of over 1 billion people (World Bank, 2018). Ecologically, there are four main lowland ecological zones (ecozones) in the region (Figure 1b): tropical rainforest (TRF), tropical moist deciduous forest (TMDF), tropical dry forest (TDF), and tropical shrublands (TSL) at the transition zones into the Sahara to the north and the Kalahari to the south. In addition to lowland ecozones, there is also the tropical montane system (TMS) with high elevations and mixed vegetation mostly found in Ethiopia, Kenya, Rwanda, Burundi, DRC, Cameroon and Nigeria (FAO, 2012).

To address our research questions, we drew up a workflow (Figure 2) on how to move from the input to processing and output stages. We also had a loop for backward movement for quality control (QC) and validation. We had three final outputs: (i) database for the spatial location of mines in Sub-Saharan Africa [MLD\_SAF]; (ii) database of quality controlled and validated mines for sub-Saharan Africa with additional attributes [MDB\_SAF\_QC]; and (iii) database of proximity of mines to PAs and regions of conservation value for pre and post year 2000 [MDB\_PD\_pre\_2000 and post 2000]. We also had one preliminary output: Mine database for sub-Saharan Africa [MDB\_SAF\_prelim].

### **1.2.2 Mine Locations: Secondary Input Data, Quality Control**

The input data used for the study (Figure 2) were derived from various sources (Table 1) in a range of file formats. As a consequence of the acquisition approaches used in each case,



Accepted Article

these data often exhibited: (i) omissions (e.g. several mines in Africa were missing entirely); (ii) incomplete statistics (e.g. type of mineral mined and dates open/closed); (iii) unreliable location data (e.g. unclear mine locations and names); and (iv) some mineral occurrences were also listed as mines. As a result, detailed quality checks were undertaken on all mine locations, thus data listed in Table 1 (from ML1 to ML6) were cleaned and subsequently standardised into a format for use elsewhere (e.g. Excel, ArcMap and R). Quality checks were carried out thoroughly on the data to check for errors in the data such as repetitions, inaccurate and unmatched locations, and incorrect spellings.

We checked by searching the internet, especially the websites of mine operators and other relevant stakeholders in the mining industry, to verify the names of the mines and commodities mined. At the end of the QC process, we rejected the irrelevant and redundant entries, and some of the locations were mineral occurrences that are not yet operational (e.g. data labelled ML1 in Table 1). The resulting output from was a database [MLD\_SAF]; (see stage A in Figure 2). We used the above output to derive associated point shapefiles which encompassed the following attributes: the commodity mined, the mine operator, the year established and the geo-location.

### **1.2.3 Mapping of mine locations: Digitizing polygons for each mine footprint**

The input data for stage B (see figure 2) were: (i) the [MLD\_SAF] database; (ii) 100 km x 100 km sample grids; and (iii) high resolution World Imagery base map – which are ESRI-derived satellite data (Figure 2). We undertook the digitization of the areal extent of mines using ESRI-derived high-resolution World Imagery (World Imagery ESRI, et.al, 2019).

Accepted Article

These data comprise satellite imagery with spatial resolutions ranging from 0.3 m (e.g. IKONOS) to 15 m (e.g. SPOT) and dates of acquisition from 2009 to 2019 (World Imagery ESRI, et.al, 2019). Application of automated mapping of mines is conceivable in smaller regions where mining locations are known with the aid of computerised classification approaches, such as the use of Support Vector Machine (SVM: e.g. Isidro et al., 2017). However, the use of these and similar methods over large areas is not straightforward, and an entirely automated method for identifying mining locations with high accuracy is yet to be established (Goparaju et al., 2017; Lobo et al. 2018). Thus, considering of the size of the study area and the difficulty of adopting reliable automated processes using available data, we chose to adopt a more systematic manual encoding method. This was specifically designed to avoid misclassification of mining locations where land uses with similar spectral values (such as airstrips, roads, construction sites and areas cleared for agriculture) were apparent (Isidro et.al., 2017).

The basis of our approach is similar to that used by Swenson et.al (2011), whereby we derived the exact spatial locations of mines and their actual areal extents across SSA. For this study, we developed the Swenson et.al (2011) approach further to allow mine digitizing to take place at a consistent scale of 1:5000 to reduce known errors associated with excessive overshooting of polygons and to create a reliable baseline inventory of mines polygon. We devised a sample grid of 100 x 100 km covering the entire study region to facilitate this (see Figure 2a).

We manually encoded the grids as follows:

- Accepted Article
- (a) We used the spatial locations of mines derived from [MLD\_SAF] as the starting reference for the manual mine encoding method. From this, we digitized the mines systematically in and eastward direction by moving from western sub-Saharan Africa (e.g. Senegal), to eastern countries (e.g. Somalia) through the central parts of the tropical African region and down to the southern-most countries (e.g. Mozambique).
  - (b) We systematically scanned and surveyed the grid squares for (i) both existing and new mine occurrence, and (ii) to check/validate all mine locations flagged in [MLD\_SAF].
  - (c) Grid squares were categorised as either (MY) symbolizing the mapped quadrats and mine found within the quadrat, or (MN) mapped but no mine found within the quadrat. At this stage, all mines were digitized as polygons and attribute data was generated in each case
  - (d) This method yielded an additional 134 mines not initially listed on our [MLD\_SAF] database. To accommodate these, live updates to the core mining database took place. For these sites, we used the Google Earth coordinates to investigate if they were mining sites. Where we obtained positive evidence (e.g. infrastructure, equipment, proximal settlements, rapid land-use change), we added these to the known mine location database and tagged them accordingly.
  - (e) Upon digitizing all the polygons, the resulting output was the [MDB\_SAF\_prelim] database, created with various attribute fields specifically, coordinates (dd), size (km<sup>2</sup>), year opened/closed, type of mineral mined method of mining and status (active/abandoned) for easy analysis and access to current information (see Figure 2).

#### 1.2.4 Validation and cross-checking of mine location polygons, and heat maps

At this stage, we validated, and cross checked the [MDB\_SAF\_prelim] data using other readily available high-resolution remote sensing data spanning multiple years. The process involved direct intercomparing of mine location footprints from our [MLD\_SAF] database with available resources in Google Earth (data spanning 1972 to present); we used these data as they are the best available collection of cloud free, multi-temporal, high spatial resolution remote sensing imagery. At this stage, we also checked for additional information about each mapped mine and updated their individual records (including name of mine, commodity, the operator and other relevant attributes) by searching available resources exhaustively using the recorded names of settlements in close proximity the defined mine footprint as the principal search-term. We also used this process to update any missing information apparent in our [MDB\_SAF\_prelim] database; especially dates of mine establishment and closure, and the present operational status of the mines. We acknowledge that our database may exclude some smaller (e.g. footprint < 10 m<sup>2</sup>) and informal mines that are not visible on the imagery, and for which information was unavailable on the internet or state records.

Using this approach, the digitized polygons of the mines were themselves validated manually via Google Earth to cross-check for any changes in the size of the polygons depicting their extent resulting from likely mine expansion/contraction over time; as some of the ESRI World Imagery scenes for some mine locations were either older or coarser in resolution than the Google Earth scenes and vice versa, large mines within same vicinity were also identified and labelled accordingly. At the end of stage C, the [MDB\_SAF\_QC] database includes

additional attributes: such as area, commodity, time/date, precise location, and mine operator (see Figure 2).

Finally, we imported the polygons of the mining locations into ArcMap and converted them to point shapefiles, before using the density tool in the spatial analyst to generate a kernel density map (heat map) with a radius of 185 km from each point, this was classified into seven classes with an interval of five points. This output denotes the spatial concentration of mines in the study area and clearly reveals the regions with high and low mine density.

### **1.2.5 Estimating mine proximity to forests and protected areas**

Input data for this part of the workflow (stage **D**; **Figure 2**) included (i) [MDB\_SAF\_QC], (ii) data from FAO eco-zones, and (iii) data from WDPA (see Figure 2; Table 1). We carried out a Proximity analysis on these data to ascertain how close the mine footprints identified in [MDB\_SAF\_QC] were to key protected areas and regions of conservation interest within the region. We did the analysis using two time slices that allowed analysis for: (i) mines created before the year 2000, and (ii) mines created post-2000. We had to do this to check for apparent risk from recent mining activities – i.e. whether there are new mines (post-2000) created significantly closer to PAs than older (pre-2000) mines.

Overall, we did the proximity analysis using the following approach:

- (a) We initially cleaned the world database of protected areas (WDPA; IUCN, 2016) to remove any non-relevant or redundant data - i.e. those PAs whose status includes, 'not reported', 'proposed' and 'recommended', plus others that were not within the study area. Overall, (as per Durán et al., 2013) we utilized only those PA polygons that are

Accepted Article

directly relevant to the study. In addition, we added the dataset of the Ecological Zones of Africa (FAO, 2012) to the workflow to operate as a guide for the identification of both forest and non-forest zones. The FAO ecozones global classification is based on the Koppen-Trewartha climate system in combination with natural vegetation characteristics.

- (b) The three thematic layers (SAF\_MDB\_QC, FAO\_Eco-zones and WDPA) were input into the *near tool* of the proximity analysis toolset (ESRI ArcGIS 10.6) to calculate the nearest distance (in a range from 0 to 100 km) from the boundaries of the mines to the nearest PAs within specified ecozones.
- (c) We used the above process to create buffers as concentric zones from the mines, based on the distance from mines to PAs and habitats of conservation interest. Based upon Duran et al. (2013), we ascribed four key vulnerability categories to the zones as follows: (i) *red zone* for mines that are at the distance of (0<10km) to the boundaries of the PAs; (ii) *amber zone* for mines that are at a distance of (>10<20km) to the PAs; (iii) *brown zone* for mines that are at a distance of (>20<30km); (iv) *grey zone* for mines that are at a distance of (>30<40km); and (v) *green zone* for mines that are at a distance of (>40<100km) to the PAs. The colours assigned to the zones provide some guide as to the level of vulnerability of forest/protected areas in that zone to mining-induced deforestation. The outer limit of 100 km distance from PAs was chosen because it was assumed that the secondary effect of mining (e.g. infrastructure development) might not be properly ascertained at distances of above 100 km; except in a few exceptional cases where mines are to be linked to the ports

for export of commodities through the construction of hundreds of kilometres of roads and rails (e.g. Simandou in Guinea and Mbalam in Cameroon). Though if properly managed both could co-exist together. We defined the output data from stage **D** of the workflow as [MDB\_PD\_Pre2000 and MDB\_PD\_Post2000] database (Figure 2).

- (d) In addition to the proximity data, we extracted series of attributes, including the type of commodity mined, year of establishment, and other statistics (e.g. size of the polygons according to commodity mined).

## 1.3 RESULTS

### 1.3.1 Where are the mines located?

We mapped 469 mines in our study area, of which 134 (29%) mines were not present in other readily accessible databases to the conservation community. We identified the hotspots of mining in the DRC, Nigeria and Ghana, with other concentrations of mines in Guinea, Zambia and Zimbabwe (Figure 3a). These six countries accounted for 52% of the mines mapped in SSA. The least mined locations were Malawi, Djibouti and Guinea Bissau with only five mines in combination. A total of 322 mines are located within the two important ecozones where most of Africa's intact habitats are situated: the TRF and the TMDF having 42% and 32% of mines, respectively (Figure 3b). Additionally, the TDF ecozone, which is also an important ecozone in conservation based on its canopy cover and tree species, had 68 mines where gold is the main commodity.

The TSL ecozone may be the least important ecozone in terms of habitat and ecosystem conservation, because of the sparse tree cover, a large expanse of savanna and grassland and a lack of endemic species. This ecozone had only 33 mines. The TMS ecozone had the least number of mines (27), most of which were mines for limestone, uranium and phosphate, which is potentially positive given the high endemism in these montane regions.

### **1.3.2 What minerals are they extracting and how have the mines expanded overtime?**

We mapped 26 minerals in total, occupying a land area of about 3,055 km<sup>2</sup> (Figure 4a). The top six by number included the low bulk-high value commodities gold (25%) and diamond (10%), the high bulk-low value commodities copper (13%), limestone (10%) and iron (7%), and petroleum (12%), making a total of 377 mines. These six commodities accounted for 75% of the total areal extent of mines mapped. Our results showed that commodities with the least number of mines in the SSA are lithium, tantalum and iron-pyrite, which each had only 1-3 mines. Gold is the most mined commodity, with the highest number of mining sites (127) spread across the region (Figure 4a) and occupying a land area of about 32% (998 km<sup>2</sup>) of the total areal extent of mines mapped in SSA. Mining of important minerals such as bauxite, iron-ore, coal, gemstones, cobalt and tantalum is ongoing in large quantities too in the study area among others.

Two hundred and sixty (58%) of the mines in the study area began operation between the year 2000 and 2018 (Figure 4b). Within this time period, copper and limestone had 35 and 25 new mining locations, respectively, while iron-ore and diamond had 27 new locations each. Furthermore, with the use of historic data from Google Earth, we discovered that most of the



existing mines for high-value commodities (e.g. gold, and diamond) created pre-1980 have expanded remarkably during the period under review (2000-2018). For example, the Tarkwa gold mine in Ghana, which used to be less than 3 km<sup>2</sup> in areal extent in the 1980's, has expanded to over 30 km<sup>2</sup>, and the Thsibwe diamond mine in the DRC, which used to be 0.5 km<sup>2</sup> in the 1980's, had become over 4 km<sup>2</sup>. Overall, there was a total expansion of 1892 km<sup>2</sup> in the areal extent of mines in SSA in the period under review, with gold having the largest expansion by area with an additional 770 km<sup>2</sup> in land area.

We found that in total the DRC had the highest number of mines (63), while Zambia had the largest areal extent representing 13.2% (403 km<sup>2</sup>) of the total area mined in SSA. Many new extractive projects came on board in the period under review. Some of the notable new ones were: uranium (e.g. Niger; Dasa Mine 2017) and limestone (e.g. Zimbabwe; Dangote – Ndola 2015 and Nigeria; Obu/Okpella 2017), as well as petroleum and gas explorations in six new locations (e.g. South Sudan had four new projects; Palouge 2003 and Thar-Jath 2002).

### **1.3.3 How close are the mines to forests and protected areas?**

Over time, a consistently large proportion of the reported mining activity occurs in close proximity to PAs (Figure 5abc). Indeed, there was a substantial increase in mining area since the year 2000 in each category of buffer zones, especially in the red zone (0<10km from PAs; Figure 5ab). This shows that the red zone remains a constant focus for mining activities (Figure 5c), with the areal extent of mines having more than doubled from 498 km<sup>2</sup> pre-2000 to 1192 km<sup>2</sup> for those created post 2000, with a corresponding 250% increase in total number of mines. For instance, gold mining extent had expanded from 44 km<sup>2</sup> to 233 km<sup>2</sup> in the red

zone. The occurrence of mineral commodities mined in the red zone have also significantly increased in number in the period under review, most prominently: copper (from 13 to 29 mines), diamond (from 15 to 27 mines), gold (which rose from 15 to 48 mines) and iron-ore (from 7 to 27 mines). In the amber zone, there was a substantial increase in the number of mines from 33 in 2000 to 67 by 2018, resulting in an increase in areal extent by 250% in the zone (Figure 5b).

The brown zone is considered as the transition zone between the areas with high vulnerability and the areas of low vulnerability to mining-induced deforestation and habitat degradation. We found an increase of 19 new mining locations in this zone, with the grey and green zones having a total of 44 and 147 mining locations, respectively, in all the phases of the analysis (pre and post-2000; Figure 5a). Generally, from the post 2000-era analysis, we discovered a 270% increase in the number of mining locations (Figure 5b), translating to about expansion in the areal extent of mines in the study area by 1892 km<sup>2</sup>.

#### **1.4 DISCUSSION**

Our results have established that mining sites are in most parts of sub-Saharan Africa, regardless of the ecological region. However, the proximity of mines to areas of high environmental value suggests that they pose significant threats to forest and ecosystem conservation in SSA, especially considering the rapid rates of expansion of existing mines and the creation of new ones. Over 200 major mines and numerous ASMs became operational within the last 20 years in the study region, with high potential of an associated increase in mining-induced deforestation and degradation in SSA. Economically, these are

great employment opportunities for people in the region, but they could have negative ecological consequences in the long run if not properly managed. This study fills a core need for an accurate database of mining hotspots (Figures 3 & 4), enabling the continuous monitoring of identified mining hotspots that can help to reduce deforestation caused by mine encroachment.

#### **1.4.1 Mine expansion**

Our findings revealed the establishment of 58% of mines in the study area between the year 2000 and 2018 (figure 5) and most of those established pre-2000 had expanded significantly. This development is attributable to the growth in mineral demand and as a direct manifestation of the recent huge investments in the mining sector of Africa (Janneh & Ping, 2011; Edwards et al., 2014; Woods & Lane, 2015). Incidentally, the last two decades were the era when the global economy rose from about \$33 trillion to over \$80 trillion (*World Development Indicators*, 2018), and coincidentally the period when Africa's forests were depleted by over 450,000 km<sup>2</sup> (FAO, 2016), with mining identified as one driver of deforestation.

In the Neotropics, gold mining has expanded rapidly into new regions between 2001 and 2013, with 1,680 km<sup>2</sup> of forest lost to the new mines created (Alvarez-Berrios & Mitchell Aide, 2015), with existing Huepetuhe, Delta-1 and Guacamayo gold mines in south-western Peru expanding by over 5,000 km<sup>2</sup> between 1999 and 2012 (Asner et al., 2013). In sub-Saharan Africa, such great rates of expansion are most likely to occur in the future, especially after exhausting deposits elsewhere on the globe.

The areal extent of most mines for commodities such as gold, copper, iron-ore, diamond and uranium are larger than 10 km<sup>2</sup>, including all structures within the mining sites (see also: Durán et al., 2013; Swenson et al., 2011; Alvarez-Berrios & Mitchell Aide, 2015). However, these classes of mines are also likely to have attracted the expansion and creation of new settlements around them, in addition to the artisanal and small-scale mining activities thriving around their vicinities, which remain an unquantified major potential negative consequence for the environment (Spittaels & Hilgert, 2013). Poor dwellers in such settlements are likely to hunt for food and extract large quantities of fuelwood, extirpating wildlife and resulting in local deforestation or degradation.

The dispersion of ASM and the informal mining activities around the region. Their mostly far-smaller areal extent (Asner et al., 2013; Hund et al., 2013; Heemskerk et al., 2004) means that measuring the size of these mines (and indeed locating them) using optical satellite imagery is often not feasible (e.g. Landsat; Nigeria-SAT & SENTINEL), especially when working at a large area with the presence of tree canopies around the mines (Asner et al., 2013). The exceptions may be those cases where the concentration of ASMs are within one vicinity, creating a large aggregate areal extent. For examples, the Banankoro diamond mine in Guinea and the Asankrangwa belt mines in Ghana, which stretches down the entire length of the Ofin river, making it the largest ASM gold mine in SSA.

#### **1.4.2 Conservation impacts**

Many mines were located close to areas of conservation concern. This finding mirrors those of Edwards et al. (2014) who found 964 mineral occurrences inside or within a distance of 10

km of the protected areas of Central Africa and of Duran et al. (2013) who found that, globally, 482 mines for metals (bauxite, copper, iron and zinc) are within or at a distance of up to 10 km from protected areas. However, our study represents a major advance, in that it deals with mines and not occurrences, and covers most of SSA rather than solely the Congo Basin (as per Edwards et al., 2014). This study has also identified 200 more mines than Duran et al. (2013) in the study region, who were only able to study four mineral types and focused on designated protected areas. In addition, they were unable to detect impacts in the west and central Africa regions where we identify a concentration of mines with proximity to areas of concern, both PAs and forests more generally.

Mines have advanced towards areas of conservation interest overtime: of particular concern are mines within the green buffer zone in countries including Nigeria, Angola and the DRC where the Chinese and others are increasingly investing in gold, copper, limestone and gemstones (e.g. Schure, et al., 2011; Edwards et al., 2014; Executive Research Associates (Pty) Ltd, 2009). These may represent substantial upcoming threats because of the ongoing prospecting and exploration for minerals in nearby locations that are more proximate to areas of conservation concern. This is likely to attract more infrastructure development and bring in ASM miners.

There is a dearth of strong laws in the region and lack of commitment from governments of most countries in SSA on the need to maintain and protect PAs (Edwards et al., 2014). For instance, the DRC government granted mining concessions in locations that overlapped with important protected areas in the region; in 2018, it proposed to enact PADDD to downsize two of its important PAs (Virunga and Salonga National Parks) by about 4,000 km<sup>2</sup> to enable

mineral extraction in the area (Qin et al., 2019). The encroachment of mining and its related activities within or near to PAs can significantly negatively affect the capacity of PAs to perform their core conservational functions (Dudley, 2010), with changes in habitat close to PAs having direct influence on the ecosystem within PAs (Laurance et al., 2012). Furthermore, in most cases, new mines require new infrastructures which leads to linear clearing of forests, the effect of which can be enormous (Laurance et al., 2009). In tropical Africa, for instance, hunting of animals in primary forest has increased in close proximity to roads and is driving the most endangered species towards extinction (Laurance et al., 2009) at the same time as impacting tree seed dispersal and recruitment (Terborgh et al., 2008).

Despite these risks, there are also potential benefits from mining, and thus our distance bands and associated risk scores need not scale with potential impacts. Regardless of distance from a mine, with good planning and enforcement, areas of conservation importance could co-exist and even benefit if mining can support enhanced local protection. In some instances, mining operations have effectively created conservation zones and offset some of their negative impacts. For example, the Mbalam iron-ore mine adjacent to the Dja World Heritage site in Cameroon includes biodiversity set-asides to protect rare forest mammals, while the arid Sperrgebiet hotspot of biodiversity in southwest Namibia was completely off-limits to local resource extractors because of claims on alluvial diamond deposits (Edwards et al. 2014).

More broadly, positive environmental outcomes over the long term may be expected under growing economic development and associated advances in governance and societal SGD, which reduce large-scale, low intensity pressure on natural systems driven by subsistence and poverty (Sayer *et al.* 2012a; Sonter et al. 2018). Thus, while an economic and governance

transition period will likely generate initial conservation losses within some impoverished SSA forest landscapes, mining may equally represent a core pathway for longer-term delivery of environmental SDGs. The key questions, therefore, are whether this transition occurs in a sufficiently rapid timescale so as to prevent species extinctions in SSA, and whether it does so in a manner that avoids the resource-curse, in which mining encourages corruption and weakens national governance to undermine both social and environmental goals (Smith *et al.* 2003; Edwards *et al.* 2014).

## 1.5 CONCLUSION

We identified and mapped 469 mines across SSA to explore their distribution and areal extents, and to then understand the potential threats that they pose to conservation. Hotspots of mining activity are near regions of high carbon stocks and high value to biodiversity conservation, suggesting susceptibility to deforestation and other negative environmental consequences. Without effort by conservationists, policymakers, and international funders of mining to bring renewed rigour to environmental standards, there is significant danger that mining in SSA will result in major conservation losses, at least in the short-term, both within and outside of PAs. We need a much more robust approach particularly to the increasing frequency of PADD events to make way for mining.

## **REFERENCES**

- Alvarez-Berrios, N. L., & Mitchell Aide, T. (2015). Global demand for gold is another threat for tropical forests. *Environmental Research Letters*, 10(1), 14006. <https://doi.org/10.1088/1748-9326/10/1/014006>
- Asner, G. P., Llactayo, W., Tupayachi, R., & Luna, E. R. (2013). Elevated rates of gold mining in the Amazon revealed through high-resolution monitoring. *Proceedings of the National Academy of Sciences*, 110(46), 18454–18459. <https://doi.org/10.1073/pnas.1318271110>
- Butsic, V., Baumann, M., Shortland, A., Walker, S., & Kuemmerle, T. (2015). Conservation and conflict in the Democratic Republic of Congo: The impacts of warfare, mining, and protected areas on deforestation. *Biological Conservation*, 191, 266–273. <https://doi.org/10.1016/j.biocon.2015.06.037>
- Chatham House. (2015). *The Impact of Mining on Forests: Information Needs for Effective Policy Responses*. 44(0), 1–10. Retrieved February 16, 2019 from [https://www.chathamhouse.org/sites/default/files/events/special/Mining\\_workshop\\_summary\\_final.pdf](https://www.chathamhouse.org/sites/default/files/events/special/Mining_workshop_summary_final.pdf)
- Chinese mining investments in Africa increased by \$140 billion last year - Commodity Discovery Fund. (2016). Retrieved March 11, 2019, from <https://www.cdfund.com/en/chinese-mining-investments-in-africa-increased-by-140-billion-last-year/>
- Dudley, N. (2010). *Guidelines for applying protected area management categories*. Guidelines for applying protected area management categories. <https://doi.org/10.2305/iucn.ch.2008.paps.2.en>
- Durán, A. P., Rauch, J., & Gaston, K. J. (2013). Global spatial coincidence between protected areas and metal mining activities. *Biological Conservation*, 160, 272–278. <https://doi.org/10.1016/j.biocon.2013.02.003>
- Edwards, D. P., Sloan, S., Weng, L., Dirks, P., Sayer, J., & Laurance, W. F. (2014). Mining and the African Environment, 7(June), 302–311. <https://doi.org/10.1111/conl.12076>
- ESRI, DigitalGlobe, GeoEye, Earthstar Geographics, CNES/Airbus DS, USDA, USGS, AeroGRID, IGN, and the GIS User Community (2019). (Imagery, basemaps, and land cover) Assessed April 2018, from; [http://goto.arcgisonline.com/maps/World\\_Imagery](http://goto.arcgisonline.com/maps/World_Imagery).
- Executive Research Associates (Pty) Ltd. (2009). *China in Africa: A Strategic Overview*. 1–104. Retrieved March 12, 2019, from; [https://www.ide.go.jp/library/English/Data/Africa\\_file/Manualreport/pdf/china\\_all.pdf](https://www.ide.go.jp/library/English/Data/Africa_file/Manualreport/pdf/china_all.pdf)
- FAO. (2012). *Global ecological zones for FAO forest reporting: 2010 Update Forest resources Assessment Working Paper 179*, UN Food and Agriculture Organization, Rome.
- FAO. (2016). *Global Forest Resources Assessment 2015*. UN Food and Agriculture Organization, Rome. ([www.fao.org/forest-resources-assessment](http://www.fao.org/forest-resources-assessment)).

This article has been accepted for publication and undergone full peer review but has not been through the copyediting, typesetting, pagination and proofreading process which may lead to differences between this version and the Version of Record. Please cite this article as doi: 10.1002/ldr.3706



- Ferretti Gallon, K and Jonah Busch. 2014. "What Drives Deforestation and What Stops It? A Meta-Analysis of Spatially Explicit Econometric Studies." CGD Working Paper 361. Washington, DC: Center for Global Development.  
<http://www.cgdev.org/publication/what-drives-deforestation-and-what-stops-it-meta-analysis-spatially-explicit-econometric>
- Golden Kroner, R. E., Qin, S., Cook, C. N., Krithivasan, R., Pack, S. M., Bonilla, O. D., Mascia, M. B. (2019). The uncertain future of protected lands and waters. *Science*, 364(6443), 881–886. <https://doi.org/10.1126/science.aau5525>
- Goparaju, L., Prasad, P.R.C. and Ahmad, F., 2017. Geospatial technology perspectives for mining vis-a-vis sustainable forest ecosystems. *Present Environment and Sustainable Development*, 11(1), pp.219-238.
- Hammarstrom, J. M., Briskey, J. A., Schulz, K. J., Peters, S. G., & Bawiec, W. J. (2006). Applications of a global mineral-resource assessment for addressing issues of sustainable mineral resource development. 7th International Conference on Acid Rock Drainage 2006, ICARD - Also Serves as the 23rd Annual Meetings of the American Society of Mining and Reclamation, 1, 703–720.  
<https://doi.org/10.21000/JASMR06020703>
- Heemskerk, M., Drechsler, B., Noetstaller, R., & Hruschka, F. (2004). Program for improvements to the profiling of artisanal and small-scale mining activities in Africa and the implementation of baseline surveys. (March), 1–160. Retrieved from  
<http://documents.worldbank.org/curated/en/2004/03/10166916/program-improvements-profiling-artisanal-small-scale-mining-activities-africa-implementation-baseline-surveys>
- Isidro, C. M., McIntyre, N., Lechner, A. M., & Callow, I. (2017). Applicability of earth observation for identifying small-scale mining footprints in a wet tropical region. *Remote Sensing*, 9(9). <https://doi.org/10.3390/rs9090945>
- Janneh, A. & Ping, J. (2011). Minerals and Africa's Development: The International Study Group Report on Africa's Mineral Regimes. 210. Retrieved from  
[http://www.africaminingvision.org/amv\\_resources/AMV/ISG\\_Report\\_eng.pdf](http://www.africaminingvision.org/amv_resources/AMV/ISG_Report_eng.pdf)
- Kinnaird, J. A., Nex, P. A. M., & Milani, L. (2016). Tin in Africa. *Episodes*, 39(2), 361.  
<https://doi.org/10.18814/epiiugs/2016/v39i2/95783>
- Kirsten Hund, Carole Megevand, Reed, E. W. R. (2013). Deforestation Trends in the Congo Basin Mining Deforestation Trends in the Congo Basin. World Bank, (April).
- Kissinger, G., M. Herold, V. De Sy. Drivers of Deforestation and Forest Degradation: A Synthesis Report for REDD+ Policymakers. Lexeme Consulting, Vancouver Canada, August 2012.
- Klubi, E., Abril, J. M., Nyarko, E., & Delgado, A. (2018). Impact of gold-mining activity on trace elements enrichment in the West African estuaries: The case of Pra and Ankobra rivers with the Volta estuary (Ghana) as the reference. *Journal of Geochemical Exploration*, 190(February), 229–244. <https://doi.org/10.1016/j.gexplo.2018.03.014>
- Laurance, W. F., Goosem, M., & Laurance, S. G. W. (2009). Impacts of roads and linear clearings on tropical forests, (September), 659–669.  
<https://doi.org/10.1016/j.tree.2009.06.009>
- Laurance, W. F., Carolina Useche, D., Rendeiro, J., Kalka, M., Bradshaw, C. J. A., Sloan, S.

- P., Zamzani, F. (2012). Averting biodiversity collapse in tropical forest protected areas. *Nature*, 489(7415), 290–293. <https://doi.org/10.1038/nature11318>
- Lobo, F. de L., Souza-Filho, P. W. M., Novo, E. M. L. de M., Carlos, F. M., & Barbosa, C. C. F. (2018). Mapping mining areas in the Brazilian amazon using MSI/Sentinel-2 imagery (2017). *Remote Sensing*, 10(8). <https://doi.org/10.3390/rs10081178>
- Merem, E. C., Twumasi, Y., Wesley, J., Isokpehi, P., Shenge, M., Fageir, S., ... Nwagboso, E. (2017). Assessing the Ecological Effects of Mining in West Africa: The Case of Nigeria. *International Journal of Mining Engineering and Mineral Processing*, 6(1), 1–19 <https://doi.org/10.5923/j.mining.20170601.01>
- Platform, G. L. (2016). Chinese investment in Africa' s forests — scale, trends and future policies, (October,2016).
- Qin, S., Golden Kroner, R. E., Cook, C., Tesfaw, A. T., Braybrook, R., Rodriguez, C. M., Mascia, M. B. (2019). Protected area downgrading, downsizing, and degazettement as a threat to iconic protected areas. *Conservation Biology*, *cobi.13365*. <https://doi.org/10.1111/cobi.13365>
- Ranjan, R. (2019). Assessing the impact of mining on deforestation in India. *Resources Policy*, 60, 23–35. <https://doi.org/10.1016/j.resourpol.2018.11.022>
- Sayer, J., Endamana, D., Ruiz-Perez, M., *et al.* (2012a). Global financial crisis impacts forest conservation in Cameroon. *Int. Forest Rev.* 14, 90-98.
- Schure, J., Ingram, V., Chupezi, J., & Ndikumagenge, C. (2011). Is the god of diamonds alone? The role of institutions in artisanal mining in forest landscapes, Congo Basin. *Resources Policy*, 36(4), 363–371. <https://doi.org/10.1016/j.resourpol.2011.09.002>
- Smith, R.J., Muir, R., Walpole, M., *et al.* (2003). Governance and the loss of biodiversity. *Nature* 426, 67-70.
- Sonter, L.J., Moran, C.J., Barrett, D.J. and Soares-Filho, B.S., 2014. Processes of land use change in mining regions. *Journal of Cleaner Production*, 84, pp.494-501.
- Sonter, L.J, Herrera, D., Barrett, D., Galford, G., Moran, C., & Soares-Filho, B. (2017). Mining drives extensive deforestation in the Brazilian Amazon. *Nat Commun*, 8, 1013. <https://doi.org/10.1038/s41467-017-00557-w>
- Sonter, L. J., Ali, S. H., & Watson, J. E. M. (2018). Mining and biodiversity: key issues and research needs in conservation science. *Proceedings of the Royal Society B* 285: 20181926. <http://dx.doi.org/10.1098/rspb.2018.1926>
- Spittaels, S., & Hilgert, F. (2013). Analysis of the interactive map of artisanal mining areas in Eastern DR Congo, (May), 1–14.
- Sub-Saharan Africa | Data. (2018). Retrieved February 23, 2019, from <https://data.worldbank.org/region/sub-saharan-africa>
- Swenson, J. J., Carter, C. E., Domec, J. C., & Delgado, C. I. (2011). Gold mining in the peruvian amazon: Global prices, deforestation, and mercury imports. *PLoS ONE*, 6(4). <https://doi.org/10.1371/journal.pone.0018875>
- Taylor, C.D., Schulz, K.J., Doebrich, J.L., Orris, G.J., Denning, P.D., and Kirschbaum, M.J., 2009, *Geology and nonfuel mineral deposits of Africa and the Middle East*: U.S.

Geological Survey Open-File Report 2005–1294-E, 246 p.

Terborgh, J., Nuñez-Iturri, G., Pitman, N. C. A., Valverde, F. H. C., Alvarez, P., Swamy, V., Paine, C. E. T. (2008). Tree recruitment in an empty forest. *Ecology*, 89(6), 1757–1768. Retrieved from <http://www.ncbi.nlm.nih.gov/pubmed/18589539>

U.S. Geological Survey, 2018, Mineral commodity summaries 2018: U.S. Geological Survey, 200 p., <https://doi.org/10.3133/70194932>

Weng, L., Boedihartono, A. K., Dirks, P. H. G. M., Dixon, J., Lubis, M. I., & Sayer, J. A. (2013). Mineral industries, growth corridors and agricultural development in Africa. *Global Food Security*, 2(3), 195–202. <https://doi.org/10.1016/j.gfs.2013.07.003>

Werner, T. T., Bebbington, A., & Gregory, G. (2019). Assessing impacts of mining: Recent contributions from GIS and remote sensing. *Extractive Industries and Society*, 6(3), 993–1012. <https://doi.org/10.1016/j.exis.2019.06.011>

Woods, J., & Lane, A. (2015). State of Mining in Africa: In the spotlight, 1–16.

World Development Indicators | Databank. (2018). Retrieved February 22, 2019, from <https://databank.worldbank.org/data/reports.aspx?source=2&Topic=3#>

(a)



(b)

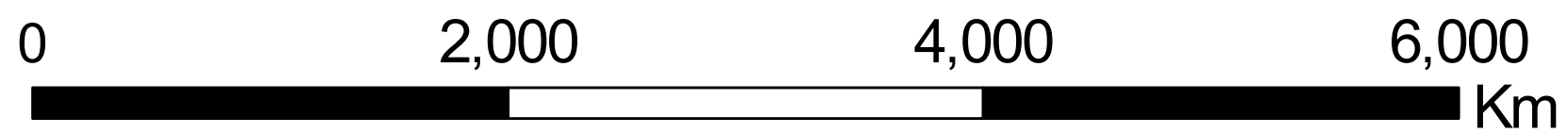
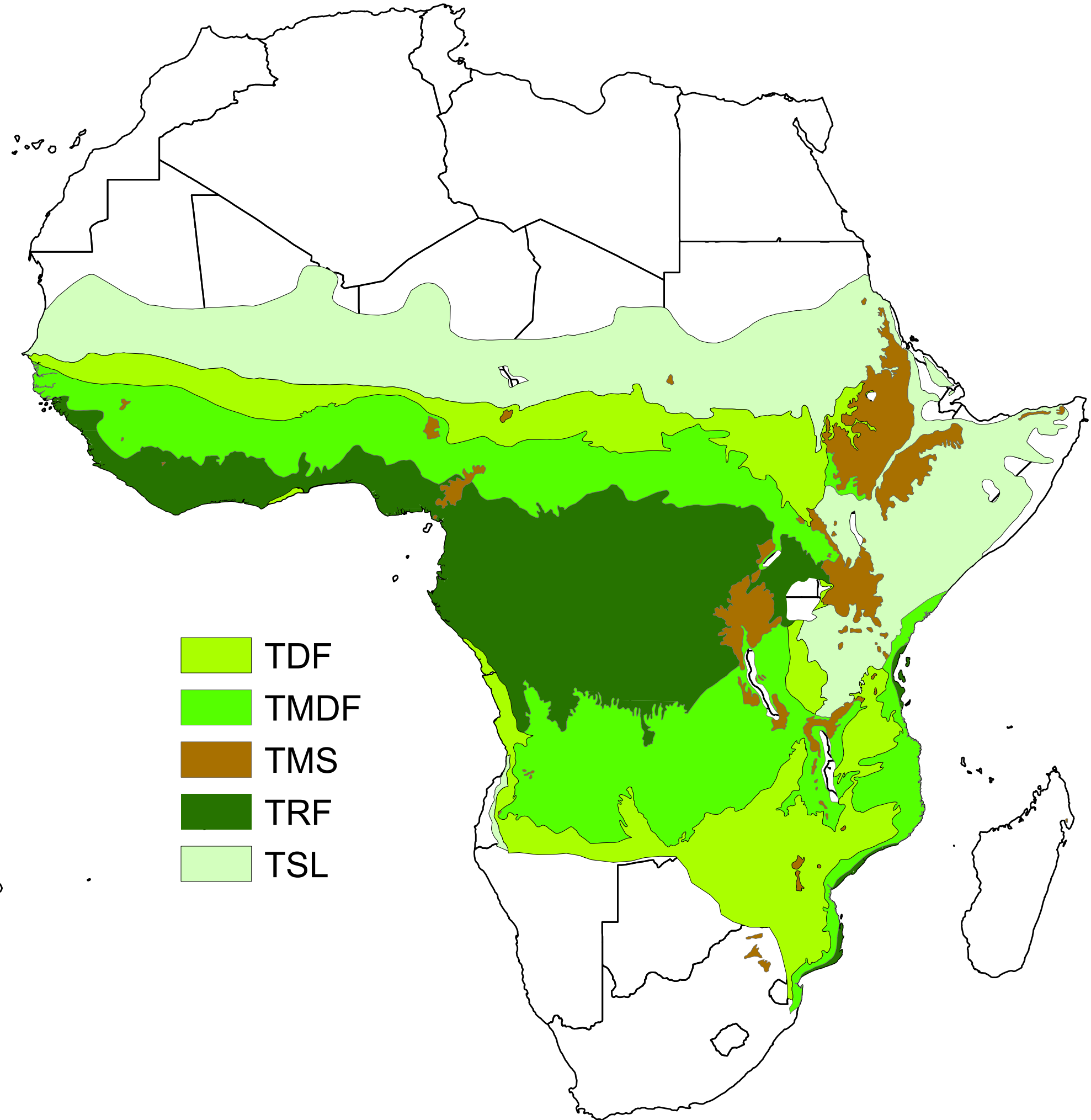

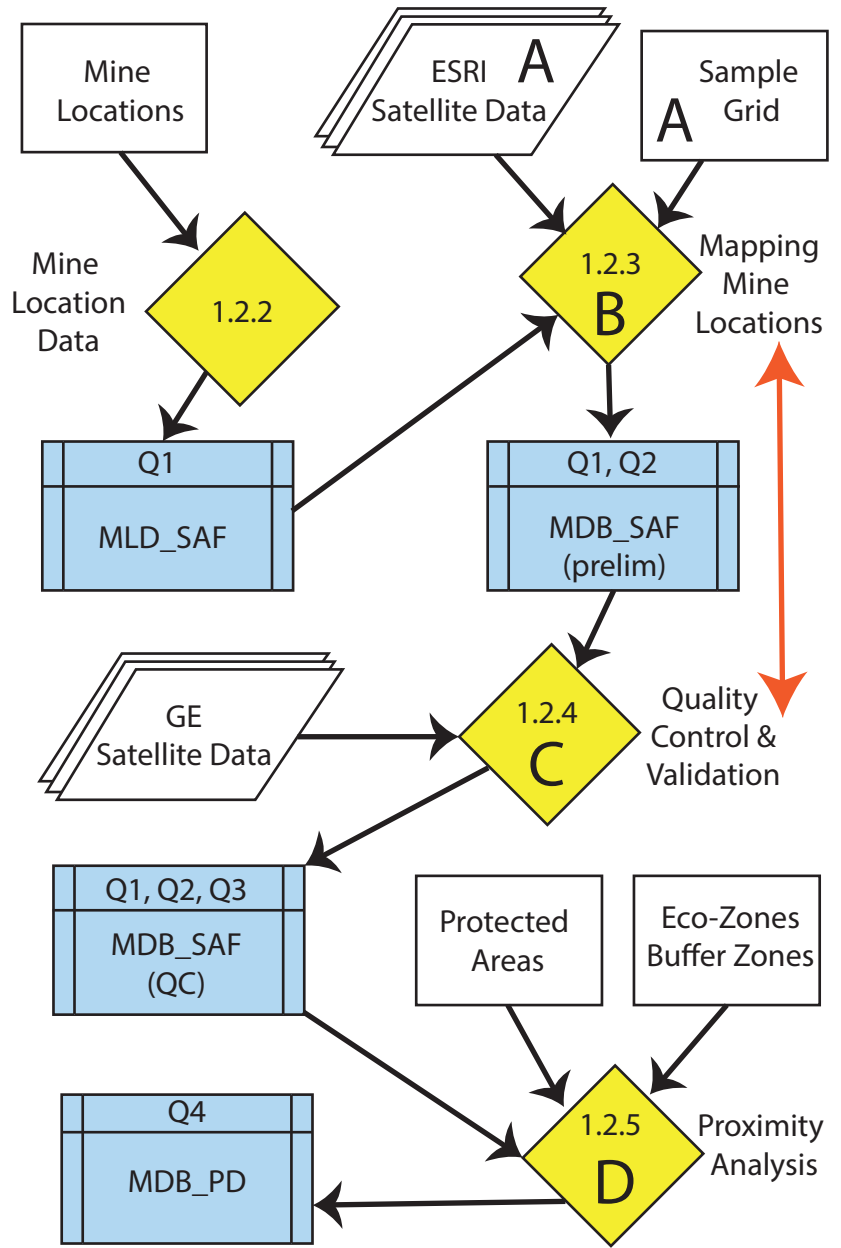
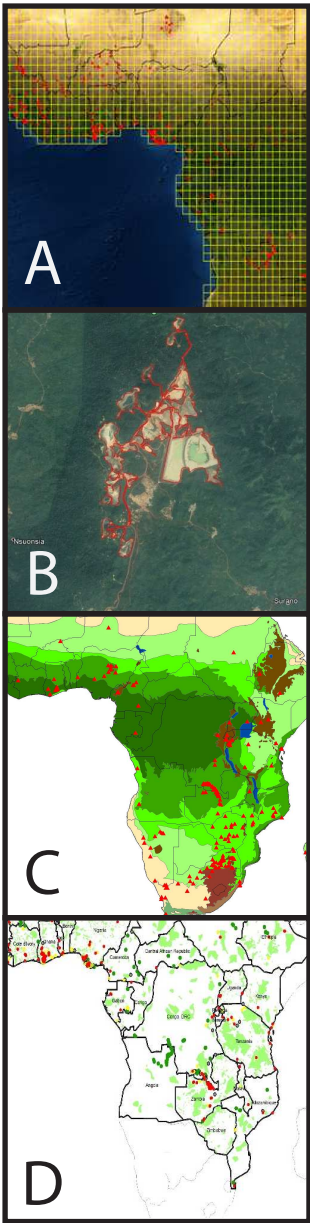



**(a)**

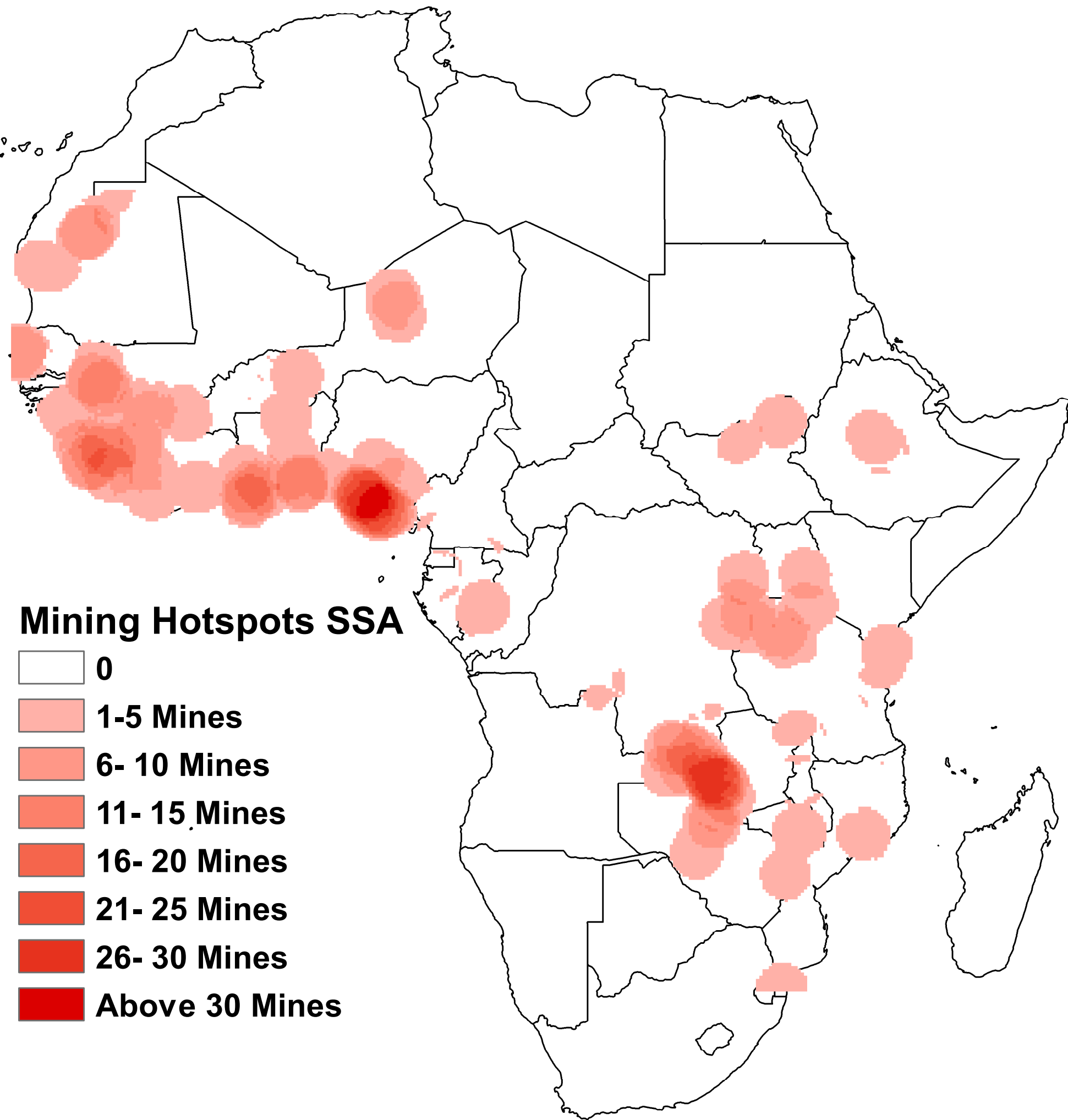

**(b)**

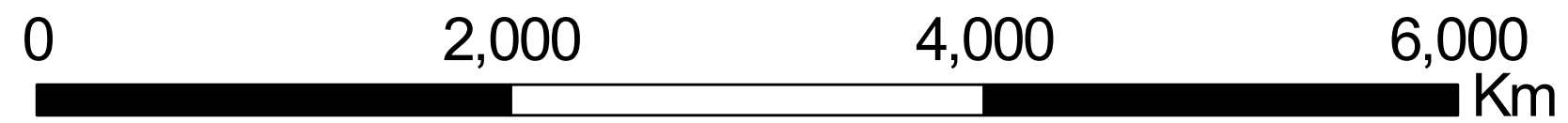
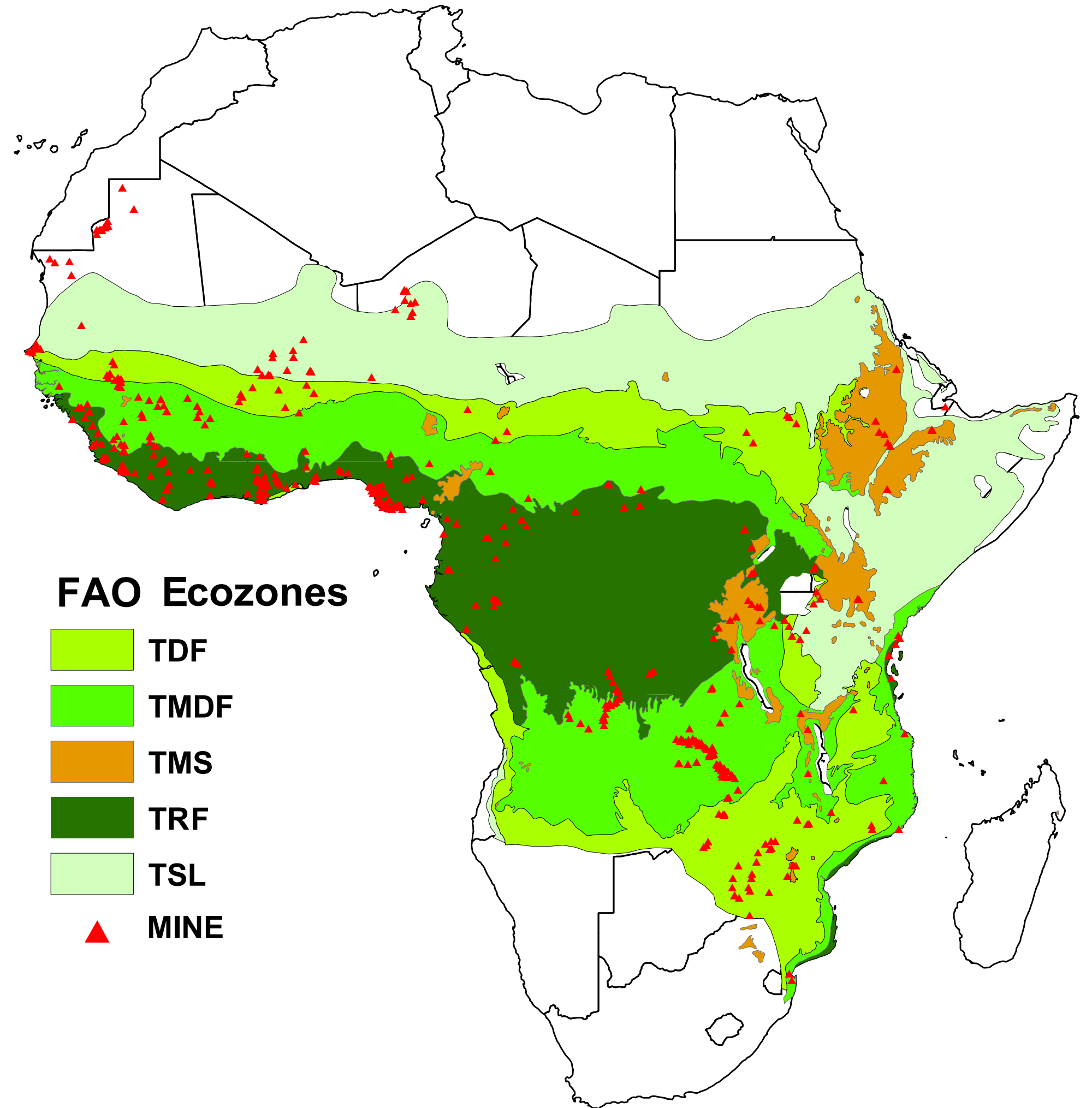

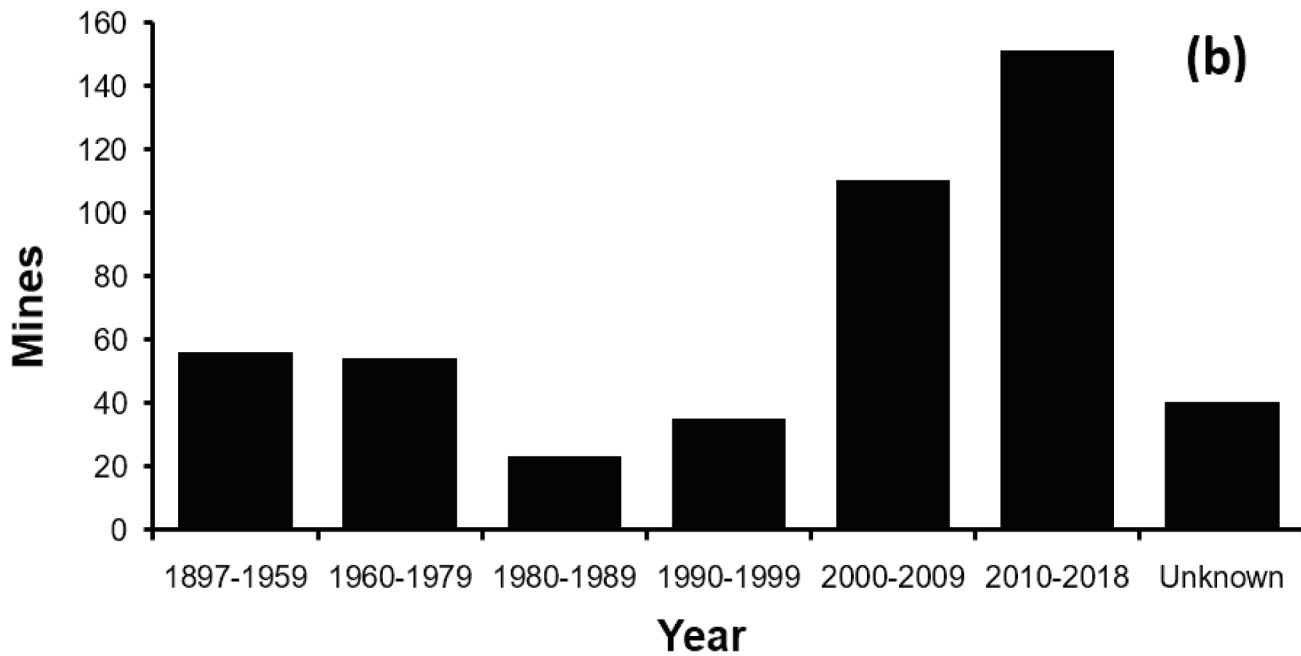
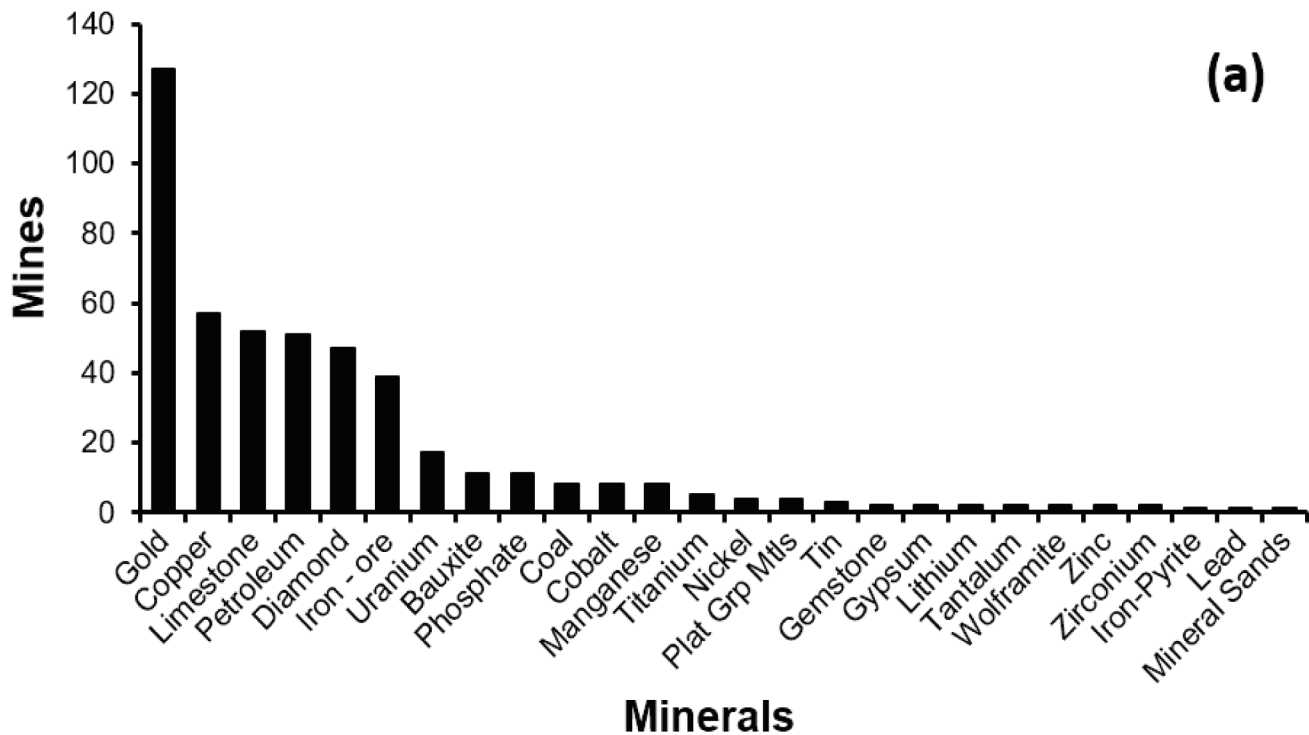

(a)

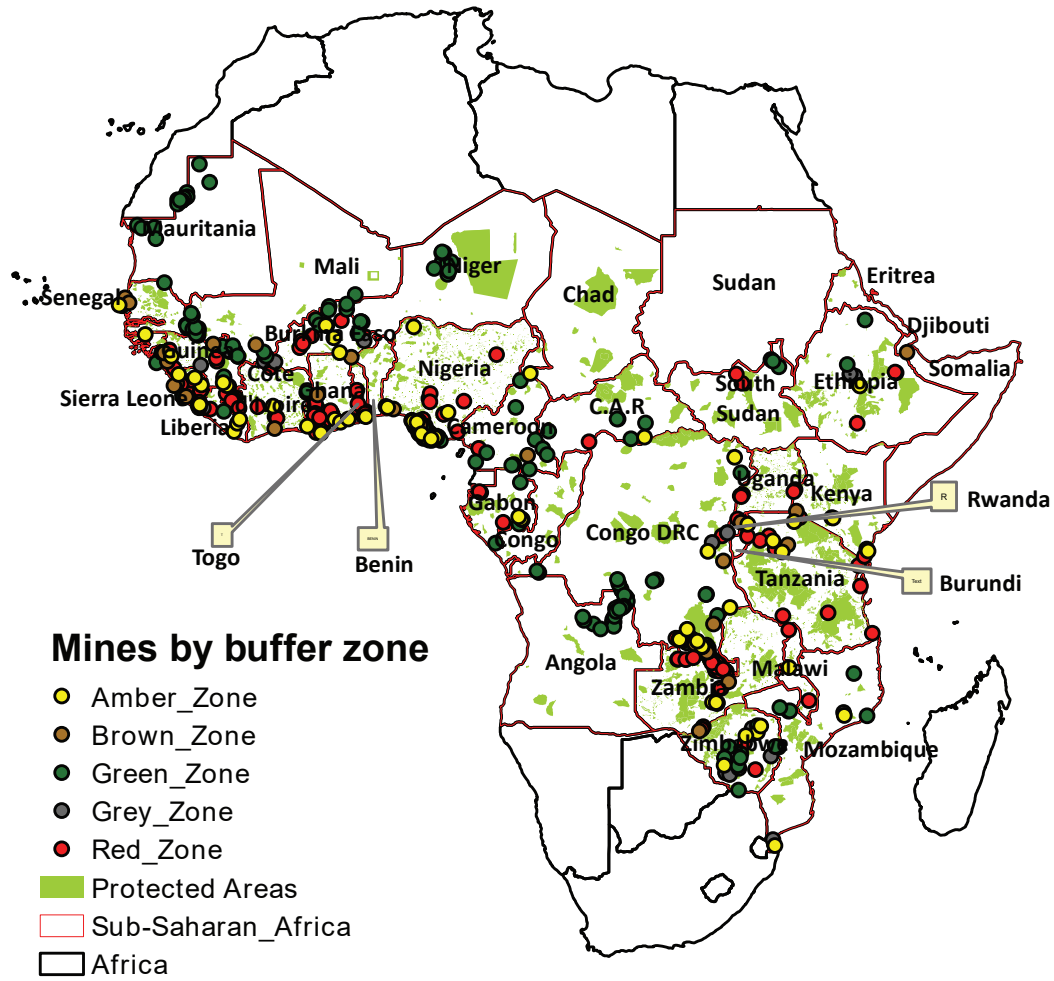

(b)

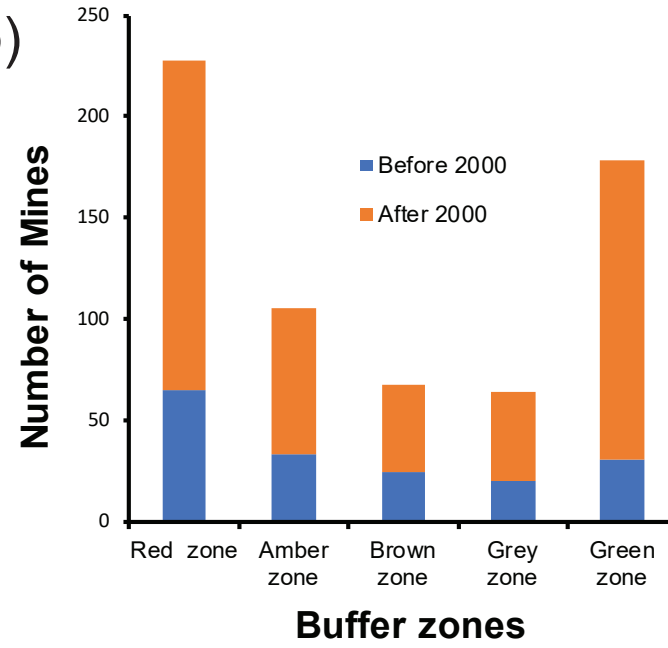

(c)

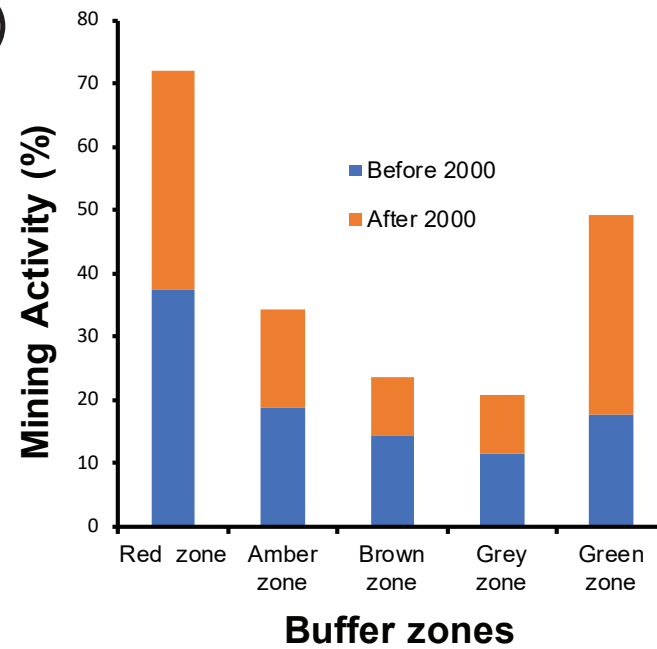



**Table 1.** List of data sources used in the workflow outlined in Figure 2 [ML = Used in the determination of mine locations MLD\_SAF and compilation of the mine database MDB\_SAF\_prelim; QC = used as part of the quality control and checking procedures required to generate MDB\_SAF\_QC ]

<b>Use</b>	<b>Source</b>	<b>Data Type</b>	<b>Years</b>
ML1	USGS	Mineral facilities operators	2006 to 2010
ML2	MMSD-Nigeria	Mines in Nigeria	Up to 2017
QC	British Geological survey	Mineral deposits	Up to 2018
QC	ESRI	High resolution imageries	2009 to 2019
ML3	Mining-atlas.com	List of mines	Up to 2018
ML4	OpenAFRICA.com	List of mines	Up to 2016
ML5	IndustryAbout.com	List and coordinates of mines	Up to 2018
ML6	Mindat.org	location of mineral deposits	Up to 2017
QC	Global Forest Watch	Cadastre of mine fields	Up to 2017
QC	Google Earth	High and medium resolution imageries	Availability (online)