

Utah State University

DigitalCommons@USU

All Graduate Theses and Dissertations

Graduate Studies

5-2014

Comparison of Selected Differential Producing, Ultrasonic, and Magnetic Flow Meters

Johnny B. Prettyman
Utah State University

Follow this and additional works at: <https://digitalcommons.usu.edu/etd>



Part of the [Civil and Environmental Engineering Commons](#)

Recommended Citation

Prettyman, Johnny B., "Comparison of Selected Differential Producing, Ultrasonic, and Magnetic Flow Meters" (2014). *All Graduate Theses and Dissertations*. 3873.

<https://digitalcommons.usu.edu/etd/3873>

This Thesis is brought to you for free and open access by the Graduate Studies at DigitalCommons@USU. It has been accepted for inclusion in All Graduate Theses and Dissertations by an authorized administrator of DigitalCommons@USU. For more information, please contact digitalcommons@usu.edu.



COMPARISON OF SELECTED DIFFERENTIAL PRODUCING,
ULTRASONIC, AND MAGNETIC FLOW METERS

by

Johnny B. Prettyman

A thesis submitted in partial fulfillment
of the requirements for the degree

of

MASTER OF SCIENCE

in

Civil and Environmental Engineering

Approved:

Michael C. Johnson
Major Professor

Steven L. Barfuss
Committee Member

Joseph A. Caliendo
Committee Member

Mark R. McLellan
Vice President for Research and
Dean of the School of Graduate Studies

UTAH STATE UNIVERSITY
Logan, Utah

2014

Copyright © Johnny B. Prettyman 2014

All Rights Reserved

ABSTRACT

Comparison of Selected Differential Producing, Ultrasonic, and Magnetic Flow Meters

by

Johnny B. Prettyman, Master of Science

Utah State University, 2014

Major Professor: Dr. Michael C. Johnson
Department: Civil and Environment Engineering

Flow meters are used to measure flow accurately. There are many different flow meters and it is necessary to know which will function best for specific situations. The flow meters in this research include three types of Venturi meters, a wedge meter, a V-cone meter, an electromagnetic flow meter and an ultrasonic flow meter. The performance of meters for this study is based on discharge coefficient (C_d) over a range of Reynolds numbers (Re), head loss across each flow meter, life, and cost of meter. The range of the testing is from Reynolds Numbers ranging from 4,000 to 1,200,000 with corresponding discharge coefficients (ratio of actual flow to indicated flow) and head loss observed for each flow meter. Based on our measurements, each flow meter can be categorized for the performance over the range of Re , head loss, life, and cost. This will assist in selecting a flow meter to best fit buyer's needs.

(73 pages)

PUBLIC ABSTRACT

Comparison of Selected Differential Producing, Ultrasonic, and Magnetic Flow Meters

Johnny B. Prettyman

Flow meters are used to measure flow accurately. There are many different flow meters and it is necessary to know which will function best for specific situations. A wide variety of flow meters were selected for the study to assist in showing that each flow meter has its tradeoffs. The selected meters include: three types of Venturi meters, a wedge meter, a V-cone meter, an electromagnetic flow meter, and an ultrasonic flow meter. The characteristics researched in this study are discharge coefficient (C_d) over a range of Reynolds numbers (Re), head loss across each flow meter, life, and cost of meter. Each meter was tested over a wide range of Re to find the corresponding C_d and head loss. The life and cost of each meter were researched and estimated based on the flow meter companies and local distributor's findings. With the findings, the tradeoffs are illustrated and will assist buyers in selecting a flow meter that will best fit their needs. While there are more flow meters available than was tested, the current study can direct buyers in a correct process of selecting meters for all situations.

ACKNOWLEDGMENTS

This project was a great learning experience and was not possible without great teachers, colleagues, family, and friends. I have had the privilege to work at the Utah Water Research Laboratory for six years and have had the best learning experience one could ask for. I could not have done this project anywhere else and have such a hands-on experience with every aspect of the project. I am grateful for the financial support and for all of my colleagues there.

I would like to thank my major professor, Dr. Michael Johnson, for hiring me without any experience whatsoever and giving me the opportunity to learn hydraulics first hand. He introduced me into hydraulics, guided me, and gave me the best work experience for an engineering student. I give thanks to Zac Sharp for teaching me everything about the Utah Water Lab, from calibrations to constructing models. He also helped with this project, giving advice and scheduling the meters for data collection. I would also like to thank my committee members, Joe Caliendo and Steve Barfuss, for their willingness and help in this project.

Most of all, I would like to thank my wife, Tasha. She was such a great support and was always encouraging the whole way. She was either pregnant or taking care of our little Aspen during the entire project. Her love kept me inspired and helped me work diligently. I hope my daughter can grow up to be just like her. We love you Aspen!

Johnny Brett Prettyman

CONTENTS

| | Page |
|-------------------------------------|------|
| ABSTRACT..... | iii |
| PUBLIC ABSTRACT | iiv |
| ACKNOWLEDGMENTS | v |
| LIST OF TABLES | viii |
| LIST OF FIGURES | x |
| NOTATIONS..... | xi |
| CHAPTER | |
| I. INTRODUCTION | 1 |
| II. LITERATURE REVIEW | 5 |
| C _d Performance | 5 |
| Head Loss..... | 9 |
| Lifetime of Meters | 10 |
| Cost of Meters..... | 12 |
| III. PERFORMANCE OF METERS | 13 |
| Theoretical Background..... | 13 |
| Experimental Procedure..... | 15 |
| Results..... | 17 |
| C _d results | 17 |
| Head Loss..... | 29 |
| Uncertainties | 32 |
| IV. DISCUSSION..... | 33 |
| Comparisons of C _d | 33 |
| Head loss | 36 |
| Meter Life | 37 |
| Cost of Meters..... | 37 |

| | |
|----------------------|----|
| Ranking Meters | 39 |
| V. CONCLUSION | 43 |
| REFERENCES | 45 |
| APPENDIX | 47 |

LIST OF TABLES

| Table | Page |
|--|------|
| 1. Uncertainties Table | 32 |
| 2. Life Cycle Cost Analysis | 38 |
| 3. Energy Costs | 39 |
| 4. Discharge Coefficient Rankings | 41 |
| 5. Head Loss Rankings | 41 |
| 6. Cost Rankings (with pumping costs) | 42 |
| 7. Cost Rankings (without pumping costs) | 42 |
| 8. Pros vs. Cons..... | 42 |
| 9. Wedge Meter Data High Re..... | 48 |
| 10. Wedge Meter Data Low Re | 49 |
| 11. Data for V-cone Meter High Re..... | 50 |
| 12. Data for V-cone Meter Low Re | 51 |
| 13. Data for. Classical Venturi Meter High Re..... | 52 |
| 14. Data for Classical Venturi Meter Low Re | 53 |
| 15. Data for Halmi Venturi Meter High Re | 54 |
| 16. Data for Halmi Venturi Meter Low Re..... | 55 |
| 17. Data for HBX Venturi Meter High Re..... | 56 |
| 18. Data for HBX Venturi Meter Low Re | 57 |
| 19. Data for Magnetic Meter High Re | 58 |
| 20. Data for Magnetic Meter Low Re..... | 59 |

| | |
|--|----|
| 21. Data for Ultrasonic Meter High Re..... | 60 |
| 22. Data for Ultrasonic Meter Low Re | 61 |

LIST OF FIGURES

| Figure | Page |
|---|------|
| 1. Differential flow meters | 3 |
| 2. Experimental setup..... | 16 |
| 3. Wedge meter discharge coefficients | 18 |
| 4. V-Cone meter discharge coefficients..... | 19 |
| 5. Classical Venturi discharge coefficients..... | 20 |
| 6. Halmi Venturi discharge coefficients | 21 |
| 7. HBX Venturi discharge coefficients..... | 22 |
| 8. Magnetic meter discharge coefficients | 23 |
| 9. Fuji Ultrasonic meter discharge coefficients | 24 |
| 10. Wedge flow meter installation..... | 26 |
| 11. V-cone flow meter installation..... | 26 |
| 12. Halmi Venturi meter installation. | 27 |
| 13. Classical Venturi meter installation..... | 27 |
| 14. Magnetic flow meter installation. | 28 |
| 15. HBX Venturi meter installation..... | 28 |
| 16. Ultrasonic flow meter installation..... | 29 |
| 17. Comparison of all meters head loss | 30 |

NOTATIONS

| | |
|------------|--|
| ΔH | = Differential Head |
| C_d | = Discharge Coefficient |
| CFD | = Computational Fluid Dynamics |
| cP | = Centipoise |
| d | = Bore of differential producer |
| D | = Pipe diameter |
| d_e | = Equivalent bore of differential producer |
| ft | = Feet |
| g | = Gravimetric constant |
| H | = Wedge Segment height |
| H/D | = Wedge apex height/Pipe Diameter |
| m | = meter |
| mm | = millimeter |
| p | = static pressure |
| Q | = volumetric flow rate |
| Re | = Reynolds Number |
| s | = second |
| V | = Average Velocity |
| z | = pipe axial direction |
| Z/D | = Wedge Height/Pipe Diameter |
| β | = beta ratio |

γ = specific weight of fluid

ν = Kinematic Viscosity

π = pi term

CHAPTER I

INTRODUCTION

In many applications, the processes are based on the precise measurement of the fluid flow rate associated with the process. Examples are petroleum, water/wastewater supply and management, nuclear power generation, and hydropower generation. In these applications it is essential to have accurate and precise flow measurement or serious problems related to performance could occur. Potential problems include loss of profit, damage to systems, or potential danger to the public. There are many flow meters that can accurately measure flow, but there is not one flow meter that will work for all situations requiring flow measurement or fit every budget. For such cases, it is necessary to determine which flow meter is the most appropriate for each application.

The meters being used for this study have been provided by Primary Flow Signal, McCrometer, Siemens, and Fuji. There are seven total meters: three different types of Venturi meters (Classical, Halmi, and HBX), a single wedge meter, a single V-cone meter, a single ultrasonic meter, and a single electromagnetic (magnetic) meter. Each meter will be assessed and then can be assigned to situations in which the meter will best perform.

The flow meters tested consist of three different metering technologies which are ultrasonic, magnetic, and differential pressure. The ultrasonic meter was provided by Fuji. Ultrasonic flow meters function by sending ultrasonic wave pulses from the upstream sensor of the meter to the downstream sensor. The time difference the pulse

takes to travel between sensors is caused by flow velocity and thus the flow can be calculated (Fuji Electric Co. 2013).

The magnetic flow meter was provided by Siemens. The magnetic flow meter is “based on Faradays law of electromagnetic induction according to which the sensor converts the flow into an electrical voltage proportional to the velocity of the flow” (Siemens A/S 2010). The magnetic and ultrasonic flowmeters used a coefficient (C) which is the ratio of indicated flow rate to actual flow.

The differential meters include three Venturi’s (Classical, Halmi, and HBX), a wedge flow meter provided by Primary Flow Signal Inc. (PFS), and a V-cone provided by McCrometer. There is a constriction of area to create a differential pressure in all differential flow meters. These meters use the differential pressure across high and low pressure taps to infer the flow rate based on Bernoulli’s theorem and the conservation of mass. The Classical and Halmi Venturi flow meters are constricted by reducing the diameter of the pipe in a conical shape. The HBX Venturi meter has an immediate change of diameter. The wedge flow meter constriction is a wedge placed in the meter. The V-cone has a cone placed in the flow area and forces the water to flow around it. All of these constrictions cause a differential pressure and thus flow can be inferred by using a pressure transducer. See Fig. 1 to see the drawings of all the differential meters. All of the differential meters for this research have similar beta ratios (β), this being the ratio of diameter at the constriction to the pipe diameter. Beta ratios will be discussed in further detail.

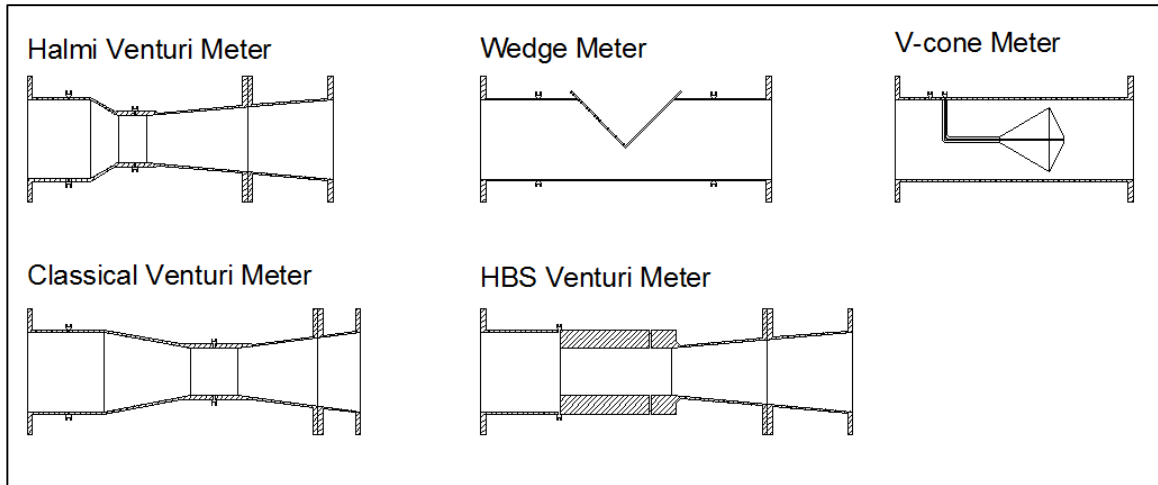

Fig. 1. Differential flow meters

Differential producing meters require a coefficient to infer correct flow rate, known as a discharge coefficient (C_d). C_d is the ratio of actual flow rate to theoretical flow rate. Meters generally have a predictable C_d at high Reynolds Numbers (Re), but at lower Re the C_d has not been well documented. Re is the ratio of inertial forces to viscous forces and decreases as velocity decreases or viscosity increases. Re is a useful ratio in the fact that the Re is the same for all fluids and the C_d corresponds. To achieve low Re in this study, the velocity was decreased and the corresponding C_d 's were calculated. The total range of the C_d is important to know for measuring low flows or leaks. Processes, such as oil, require low Re measurements and it is essential to know how the meter will perform under the range of conditions into which it will be installed.

$$Re = \frac{DV}{\nu} \quad (1)$$

where V = average velocity of the fluid, ft/sec or m/sec

ν = kinematic viscosity of the fluid, ft²/s or m²/s

D = Inner diameter of pipe

Flow through differential producing meters results in a differential pressure to infer flow. To create that differential, head loss will occur. In selecting a meter it is important to know the head loss associated with it. Each meter is different and needs to be tested to know the precise loss. Loss will add costs if pumps are needed to overcome lost energy in the pipe line.

The applicability of meters is not only on metering performance, but lifetime and associated costs of the meter and maintenance. Each meter type has different useful lifetimes and costs. Depending upon the needs of buyers, different meters can be used. The meters in the study will have the lifetime and associated costs determined.

The primary objective of this thesis were as follows:

- 1) Perform laboratory experiments to find C_d over a range covering low to high Reynolds numbers for flow meters.
- 2) Perform laboratory experiments to find head losses for flow meters.
- 3) Research lifetime of flow meters.
- 4) Research costs of meters and associated operation costs.

The paper will continue by presenting a literature review of previous research done on the subject, continuing research, and current practices. The results of the current research will be examined, followed by the discussion of the results. The paper will then end with the conclusion and further research necessary.

CHAPTER II

LITERATURE REVIEW

C_d Performance

Little physical research has been done at low Re for differential pressure flow meters. This is due to difficulties with measuring such low flow. However, much computational fluid dynamics (CFD) research has been done at low Re, and has proved to show good results compared to experimental physical research.

PFS reports that the wedge meter is +/- 0.50% of coefficient accuracy, with the repeatability of +/- 0.20%. For wedge meters < 1", the coefficient accuracy is +/- 0.75%. The wedge is accurate for lower Re and is constant over a wide operation range (Primary Flow Signal 2012b).

The wedge flow meter has shown excellent C_d performance at low Re. Yoon, Sung, and Lee researched C_d versus Re for varying sizes of wedges at 90 degrees. The Re range of the experiments was 12,000 to over 380,000. They found that at each wedge size the calibrated C_d was different but was approximately +/- 0.50% over the whole range of Re, with each data point having a repeatability of +/- 0.50% (Yoon et al. 2007).

Buhidma and Pal researched different concentrations of two-phase oil-in-water emulsions at low Re for a wedge flow meters. They found that water performs approximately the same as any concentration of two-phase oil-in-water for calibration purposes and that the size and shape of the wedge affect C_d. The experiment included 4 different wedges. Two of the meters had an identical wedge angle of 60 degrees, with

different Z/D ratios of 0.3 and 0.5, where Z is the height of the wedge and D is the diameter of inside pipe. The other two meters had an angle of 90 degrees and Z/D ratios of 0.3 and 0.5. The results show that the C_d is constant over a wide range of Re , which was approximately $500 < Re < 100,000$. The data was within $\pm 5\%$ repeatability over the range. With the different Z/D ratios and wedge angles, the C_d changed slightly but did not affect the consistency (Buhidma and Pal 1996).

Banchor et al. (1996) performed CFD on two different wedge meters with wedge angles of 60 and 90 degrees with increasing wedge heights and changing vertices. The initial ratio of H/D in the meters were 0.5, where H is the height above the wedge and D is the diameter of the inside pipe. To show that the CFD was functioning, comparisons were made between the experimental and the CFD's C_d 's. The CFD produced C_d 's that were approximately the same as the estimated for a wedge angle of 60 degrees. Banchor et al. CFD produced an Average C_d of 0.793 ± 0.006 for the 60 degree angle. The CFD produced an average C_d of 0.908 ± 0.022 for the 90 degree wedge. Once the CFD was functioning, the height and vertex of the wedge was changed. It was found that as the H/D ratio increased the C_d increased. The optimal vertex configuration was a rounded vertex with a 3mm diameter. With this configuration, the optimal C_d was found. The range of the Re was 3,000 to 218,000 (Banchhor et al. 2002).

Hollingshead did research using CFD on wedge flow meters with different wedge sizes. He found that the wedge flow meters had a constant C_d from Re 500 to 50,000,000 with a variance of 1% over that range. After Re of 500, the C_d value drops abruptly (Hollingshead 2011).

McCrometer reports that the V-cone meter is +/- 0.5% of actual flow with +/- 0.1% repeatability over a turndown ratio of 10:1. The meter will produce linear C_d for $Re \geq 8,000$. The percentages are subject to certain fluids and Re and may require special calibrations to have these values (McCrometer Inc. 2014).

Singh, Seshadri, and Gawhade studied the performance of the V-cone flow meter. They found that for the range $1,250 < Re < 218,000$ the average C_d value to be 0.7256 for the 0.64 beta ratio. The other 0.77 beta ratio had a range of $1,500 < Re < 254,000$ and an average C_d 0.7315. Both data were collected under undisturbed flow. The variation over the range is +/- 0.5%. In their research, the V-cone meter was placed in different locations of the pipe. The locations being 5, 10, 15 diameters of pipe inner diameter downstream of a valve. The research shows that performance at meters placement at 10 diameters or greater produced similar results to undisturbed flow (Singh et al. 2006).

Hollingshead used CFD for three different beta ratios for a V-cone flow meter. Hollingshead found that the V-cone's C_d ranged from approximately 0.75-0.80 from Re 2,000-1,000,000 respectively for the beta ratio of 0.6611. For Reynolds numbers less than 2,000, the C_d dropped significantly. The other beta ratio's had similar patterns, with slightly lower C_d (Hollingshead 2011).

ASME code indicated that the C_d for a Classical Venturi meter is constant for $200,000 < Re < 6,000,000$. ASME reports +/- 1.00% of actual reading and PFS states the actual reading can improve to 0.25% or better based on the hydraulic calibration (Primary Flow Signal 2009). The Halmi Venturi has a constant C_d above Re of 75,000 with +/- 0.50% of actual reading and +/- 0.25% of actual reading or better based on calibration of

the meter (Primary Flow Signal 2012a). The HBX meter provides 0.25% accuracy after a laboratory calibration. The HBX meter has a consistent C_d from $Re \geq 6,000$ (Primary Flow Signal 2013).

The Venturi has been shown to perform well at the higher Re and drops off on the lower Re . Hollingshead showed that C_d ranged from 0.921-0.975 for Re 1,000-50,000,000 respectively. Below 1,000 Re , the C_d drops off severely. The meter has a constant discharge from approximately $Re > 100,000$ (Hollingshead 2011).

Miller et al. studied the influence of viscosity on flow meters C_d , specifically Venturi meters. They ran tests where the viscosity varied from 3-300 cP with Re ranging from $400 < Re < 24,000$. They found that at varying viscosities the accuracy of the C_d was 2-4% when $Re > 500$. Miller et al. was able to create Equation 1 to predict the C_d . The equation produced excellent results for higher Re but has two times the error at low Re (Miller et al. 2009).

$$C_d = B + A \cdot \log(Re) \quad (1)$$

Stobie et al. (2007) researched the effect of erosion in a Venturi meter and low Re C_d measurements. The Re was based on the throat diameter instead of the inlet pipe diameter. Additionally, a CFD model was done to compare experiment results. The research was done to investigate the change in the C_d after the Venturi meter underwent erosion. Stobie et al. first collected the standard C_d 's before introducing erosion, the range of Re was 80 to 100,000. From Re 80 to 10,000 an oil was used and from 10,000 to 100,000 water was used. The results of the data show a hump at Re of 4,000 in the C_d . The data matched closely to previous research at about Re of 1,050. From $50,000 < Re <$

100,000, the C_d ranges from 0.970 to 0.977 respectively. Stobie et al. (2007) data agreed with previous research conducted by R. Pal (Pal, 1993), Atkinson et al. (2000), Benedict and Wyler (Benedict and Wyler 1974), and Miller (1996). The hump was not found in previous research, but Benedict indicated that this can occur in the transition zone from laminar to turbulent flow (Benedict and Wyler 1974). The CFD results produced a similar result. To test erosion, a test rig was set up with three Venturi meters installed. An oil/sand slurry was ran through the Venturi meters. The erosion experiments were split into three periods. After each period, the meters were removed and tested in water to observe C_d changes. No serious erosion had occurred with the oil/sand slurry. The three meters then underwent a water/sand slurry test. This test only had one run that ran for 242 hours at similar conditions to the oil/sand slurry. The water/sand slurry caused serious erosion on the Venturi meter and caused a 1% shift in the C_d (Stobie et al. 2007).

The literature for magnetic and ultrasonic flow meters operating at small Re contains little information that is publicly available. Siemens states that magnetic meters have good accuracy at low flow to measure leaks. The optimum range is 3ft/s to 10ft/s and the accuracy in that range is +/- 0.20% (Siemens A/S 2010). The Fuji ultrasonic specifications says that the accuracy of the meter is 1.0% of flow rate with a minimum flow rate of 0.3m/s (Fuji Electric Co. 2013).

Head Loss

Little research has been done for head loss for the differential pressure meters. Miller developed equations for Venturi, Lo-loss tubes, Nozzles, Orifices, Annubars, Pitot,

and Target flow meters. The Venturi equation provides the head loss based on β and differential pressure for $Re > 6,000$ (Miller 1996).

The providers of the meters have made statements as to how much loss the meter creates. The Classical Venturi meters have a head loss of 5% to 20% of the differential pressure depending upon the beta ratio and the recovery cone geometry (Primary Flow Signal 2009) and the Halmi Venturi is reported to be 3% and greater (Primary Flow Signal 2012a). The HBX Venturi head loss is reported to be modest between the Halmi Venturi and an orifice plate (Primary Flow Signal 2013). The McCrometer website says that the head loss is low and is dependent upon the differential pressure and the beta ratio (McCrometer Inc. 2014). The magnetic and ultrasonic meters do have head loss because of the additional pipe added to the system. The ultrasonic may not introduce any if attached directly to the system. In this study the ultrasonic was attached to an added pipe. The loss of these meters is minimal compared to the differential producers because there is no intrusive components.

Lifetime of Meters

Concerning the lifetime of the meters, the providers and local sales representatives of the meters were contacted and information was collected. The wedge meter lifetime expectancy is 20 to 40 years. The lifetime is closely connected to the material selected because of the harsh types of media applications that the wedge is typically used for. There are wedge meters that are still in service that are 30 years old, have been inspected, and put back into service (Bruce Briggs, personal communication, April 1, 2014).

The lifetime expectancy for the Venturi meters is 75 to 100 years depending upon the material selection. There are thousands of Venturi meters in use around the world that are 50 to 125 years old and still provide exceptional performance. The Venturi meters have a natural self-cleaning action, where acceleration occurs between the inlet and throat. This acceleration can prevent and remove buildup on the meter (Bruce Briggs, personal communication, April 1, 2014). The UWRL tested a cast iron Venturi meter that was over 90 years old. It had a near pristine bronze throat, however the inlet coating had severe coating damage. Even with the poor inlet conditions, the meter was within 2% of the stated discharge coefficient. Repairing the liner would return the meter to near new condition.

The lifetime of the V-cone meter is 15-20 years, potentially longer. This is only based on how long the meters have been in the field thus far, since the V-cone has only been in production for 20 years. The lifetime of the meter may be longer but has yet to be seen (Mike Stone, personal communication, May 8, 2014).

The differential pressure meters do not have a direct output reading, a separate device is required to read differential pressure. Rosemount differential pressure transmitters were used in this study. Rosemount reported that the differential pressure transmitters have a lifetime of 15 years (Andrew Cureton, personal communication, July 1, 2014).

The average life for the Fuji Ultrasonic meter in continuous use is 5 to 6 years. The Ultrasonic meter electronics can affect the average lifetime. Under proper conditions, the battery can last up to 10 years and the LCD screen normally last 5 to 10

years. These values are typical results and do not include how the performance of the meter changes over its lifetime (Ryan Glanville, personal communication, April 22, 2014).

The lifetime of the Siemens magnetic meter is approximately 10 years for the tube and 5 years for the transmitter. The transmitter is 5 years because of the electronics which can degrade more quickly. The life can increase or decrease dependent upon the application of the meter (Susan Harper, personal communication, May 14, 2014).

Cost of Meters

The cost of each meter was found by contacting the providers and local distributors. The costs are as follows:

- 12” Wedge Meter - \$4,000
- 12” Halmi Venturi Meter - \$5,000
- 12” HBX Meter - \$6,000
- 12” Classical Venturi Meter - \$5,700
- 12” V-Cone – \$4,000-\$5,000
- Fuji Ultrasonic Strap-on Meter - \$6,550
- 12” Siemens Magnetic Meter - \$5,100
- Pressure Transmitter - \$1400

CHAPTER III
PERFORMANCE OF METERS

Theoretical Background

The use of Bernoulli's Theorem coupled with continuity is used to infer flow for differential pressure meters, where point one is at the high tap and point two is at the low tap located on the meter. Using the conservation of mass, the Bernoulli's Theorem can be used to solve for volumetric flow rates. Equations 2 and 3 show the Bernoulli's theorem and conservation of mass, respectively.

$$\frac{V_1^2}{2g} + \frac{p_1}{\gamma} + z_1 = \frac{V_2^2}{2g} + \frac{p_2}{\gamma} + z_2 \quad (2)$$

$$Q_{cfs} = A_1V_1 = A_2V_2 \quad (3)$$

where V_1 and V_2 = Average Velocity, ft/sec or m/sec

Q = volumetric flow rate, ft³/sec or m³/sec

g = gravimetric constant, ft/sec² or m/sec²

A_1 and A_2 = the area of the inlet of the meter and the area at the throat based on the inner diameter respectively, ft² or m²

p_1 and p_2 = pressure at the high tap and low tap respectively, lbs/in² or N/m²

γ = unit weight, lbs/ft³ or N/m³

z_1 and z_2 = elevation the centerline of the meter, ft or m

Equation 2 simplifies to Equation 6 to solve for Q based on the differential pressure between the high and low taps.

$$\Delta H = \frac{p_1}{\gamma} - \frac{p_2}{\gamma} + z_1 - z_2 \quad (4)$$

$$\beta = \frac{D_2}{D_1} \quad (5)$$

$$Q = \frac{\pi}{4} D_2^2 \frac{\sqrt{\Delta H 2g}}{\sqrt{(1 - \beta^4)}} C_d \quad (6)$$

where D_1 and D_2 = diameter at the inlet and throat of the meter respectively, ft or m

C_d = discharge coefficient

β = beta ratio

The average velocity is found by Equation 8.

$$V = \frac{Q}{A} \quad (8)$$

$$Area = A = \frac{\pi}{4} D^2 \quad (9)$$

The equation for the β of each meter differs. For the Venturi meters, β is calculated the same as Equation 4 with D_2 being the diameter of the throat, and D_1 being the diameter of the inlet of the meter. For the wedge meter and the V-cone, Equation 10 and Equation 11 to calculate β respectively (Miller 1996).

$$\beta_{wedge} = \frac{d_e}{D} = \left(\frac{1}{\pi} \left\{ \arccos \left[1 - \frac{2H}{D} \right] - 2 \left[1 - \frac{2H}{D} \right] \left(\frac{H}{D} - \left[\frac{H}{D} \right]^2 \right)^{\frac{1}{2}} \right\} \right)^{\frac{1}{2}} \quad (10)$$

where D = inner diameter of pipe, ft or m

H = Segment height, ft or m

d_e = equivalent diameter

$$\beta_{v-cone} = \frac{d_e}{D} = \sqrt{1 - \frac{d^2}{D^2}} \quad (11)$$

where d = diameter of the V-cone, ft or m

Experimental Procedure

To calculate the C_d and head loss of each meter, a 12-inch pipeline was built at the Utah Water Research Laboratory (UWRL). The pipeline was 12-inch standard wall, with over 20 diameters of upstream pipe and over 10 diameters of downstream pipe. Water was discharged into a certified weight tank which was used to calculate the flow. Water was the medium for the tests and was supplied by a reservoir just east of the UWRL. The reservoir supplies approximately 35 feet of head. Some tests were also done with a constant level tank which supplies approximately 12 feet of head.

To calculate the head loss across the meters, pressure transmitters were used with a range of 0-25, 0-250, and 0-1000 inches of H_2O . The transmitters were attached to taps located two and six diameters upstream (high) and downstream (low), respectively, of the meter.

The differential pressure across the meters was measured using pressure transmitters attached to the high and low taps located on the differential pressure meters. The range of the transmitters were 0-2.5, 0-25, 0-250, and 0-1000 inches H_2O . Flow was calculated for each run by collecting water in the weight tank and taking the elapsed time of the run with a stop watch. This allows precise measurements of flow and differential pressure. The C_d was calculated by Equation 12 for Venturi meters, this is found by the



Fig. 2. Experimental setup

manipulating of Equation 6 to solve for C_d . The V-cone and wedge meters use Equation 12, but substitutes $D_1^2 \beta^2$ and d_e^2 , for D_2^2 , respectively. The magnetic meter output flow in hertz and the ultrasonic meter output flow in milliamps. The C for the magnetic meter and the ultrasonic was calculated by Equation 13 (Miller 1996).

$$C_d = \frac{Q\sqrt{(1-\beta^4)}}{\frac{\pi}{4}D_2^2\sqrt{\Delta H}} \quad (12)$$

$$C = \frac{Q_{indicated}}{Q_{actual}} \quad (13)$$

where $Q_{indicated}$ = flow inferred by the magnetic or ultrasonic flow meter, ft^3/s or m^3/s

Q_{actual} = flow calculated from weight and time.

The range of the testing is from 4,000 to 1,200,000 Re.

Results

The results are presented in graphical form as C_d vs. Re and Head Loss vs. Flow. Graphs will have current and previous research results shown in the same graph to better compare.

Cd results

The three Venturi meters provided by PFS were the Classical Venturi, the Halmi Venturi and the HBX Venturi. The meters had a value of $\beta=0.6044$, 0.6024 , and 0.6024 respectively. The Halmi Venturi has smooth transition at the reduction to the throat, the Classical Venturi has a sharp, and the HBX has a sudden reduction. The wedge meter provided by PFS has a $\beta=0.5940$. The segment height of the wedge meter was 4.590 inches. The V-cone provided by McCrometer has a $\beta=0.5960$.

The general trend is that meters approach a constant C_d (or C for the magnetic and ultrasonic meters) when $Re > 100,000$. Below this, the meters perform differently as can be seen in Figs. 3 - 9. All the results will be compared to the constant C_d for each specific meter.

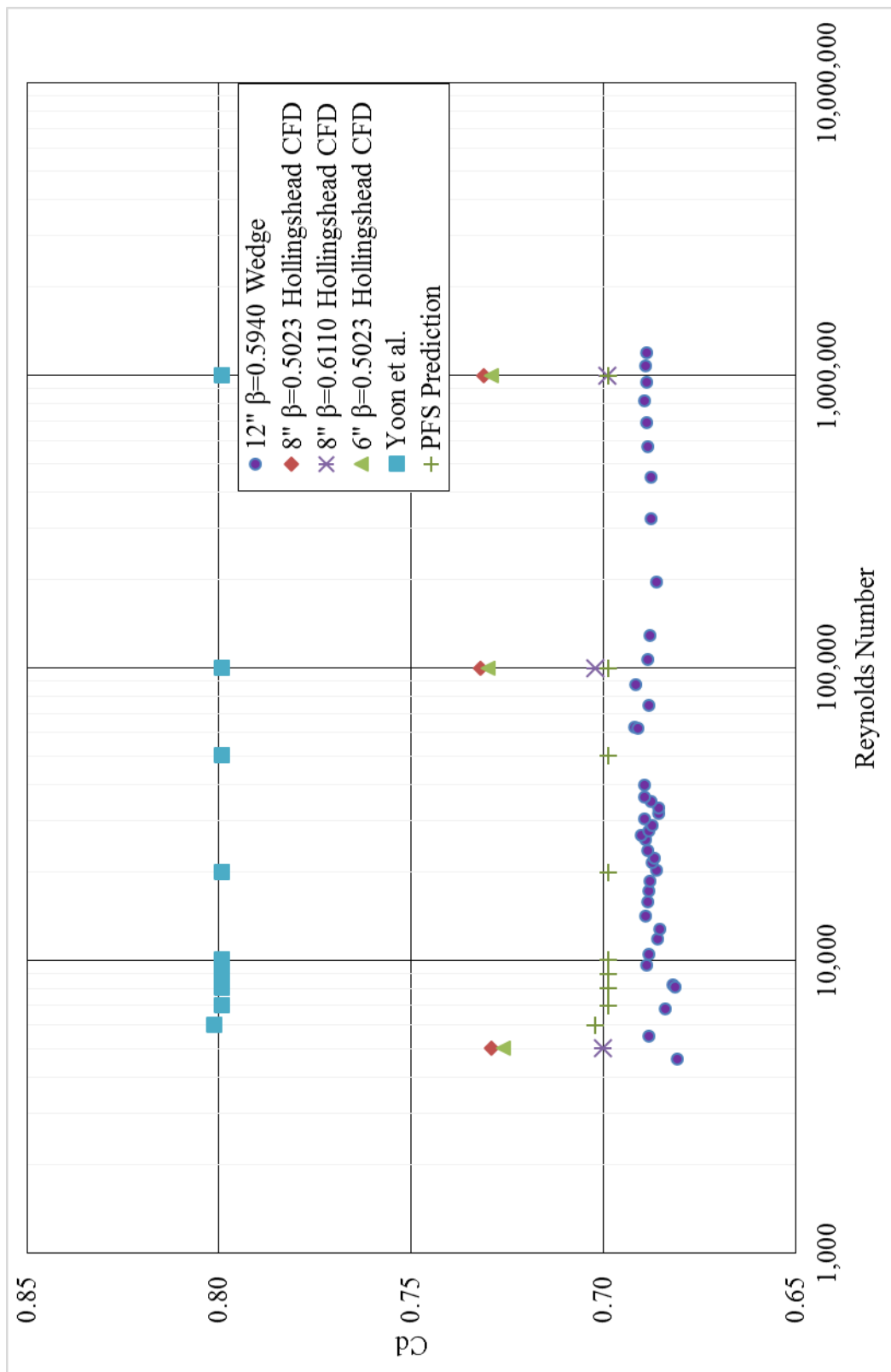

Fig. 3. Wedge meter discharge coefficients

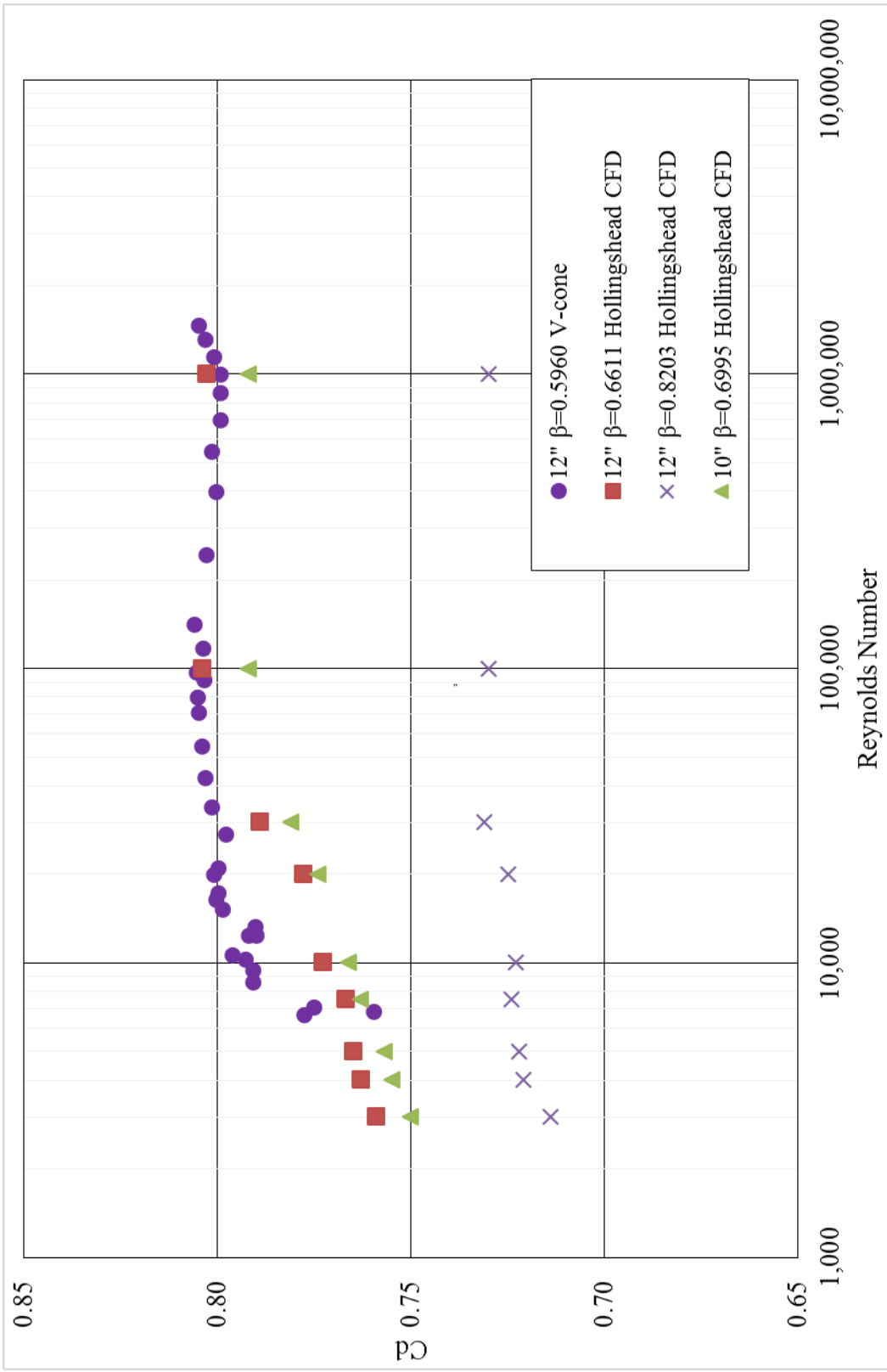

Fig. 4. V-Cone meter discharge coefficients

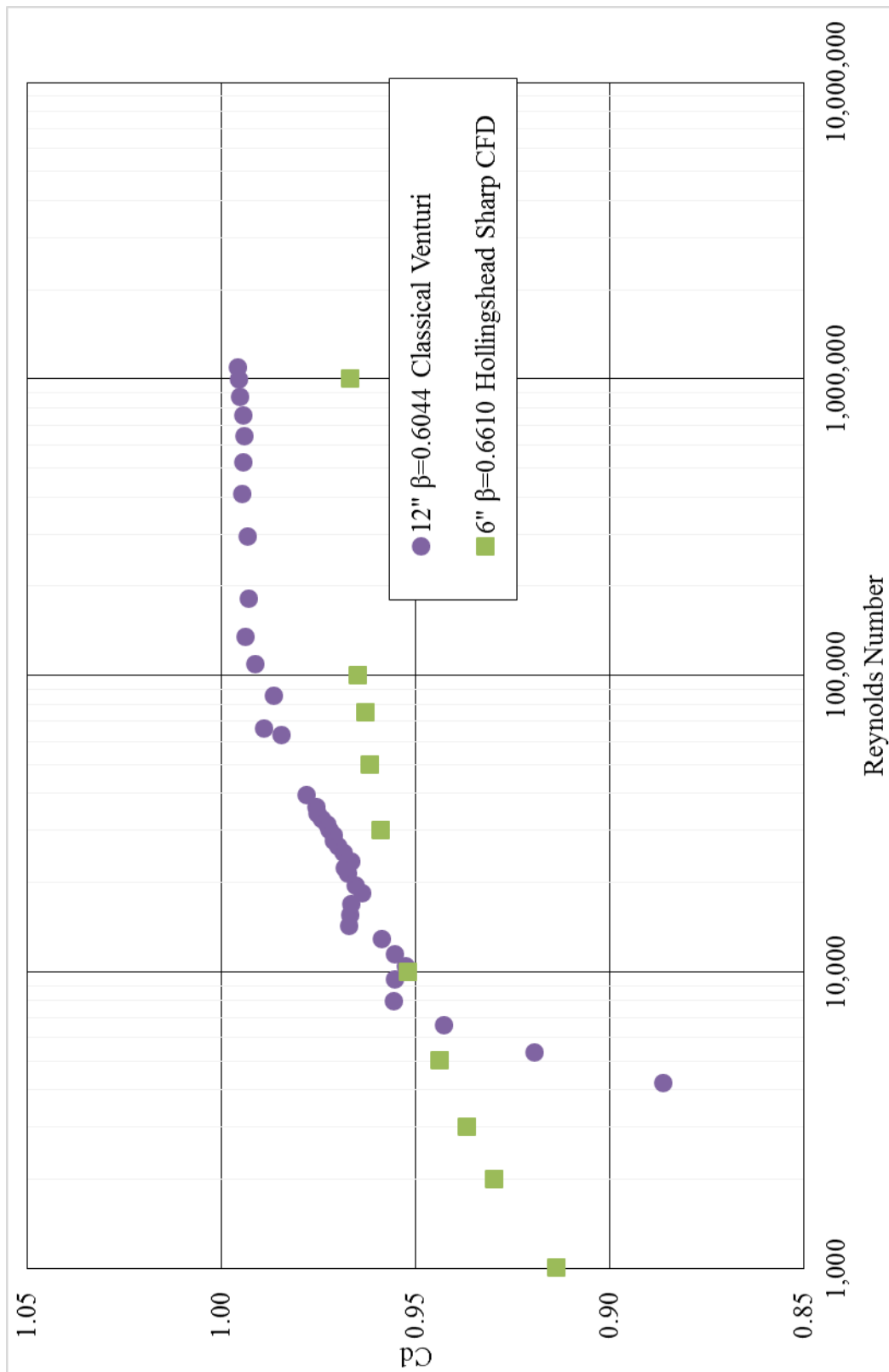

Fig. 5. Classical Venturi discharge coefficients

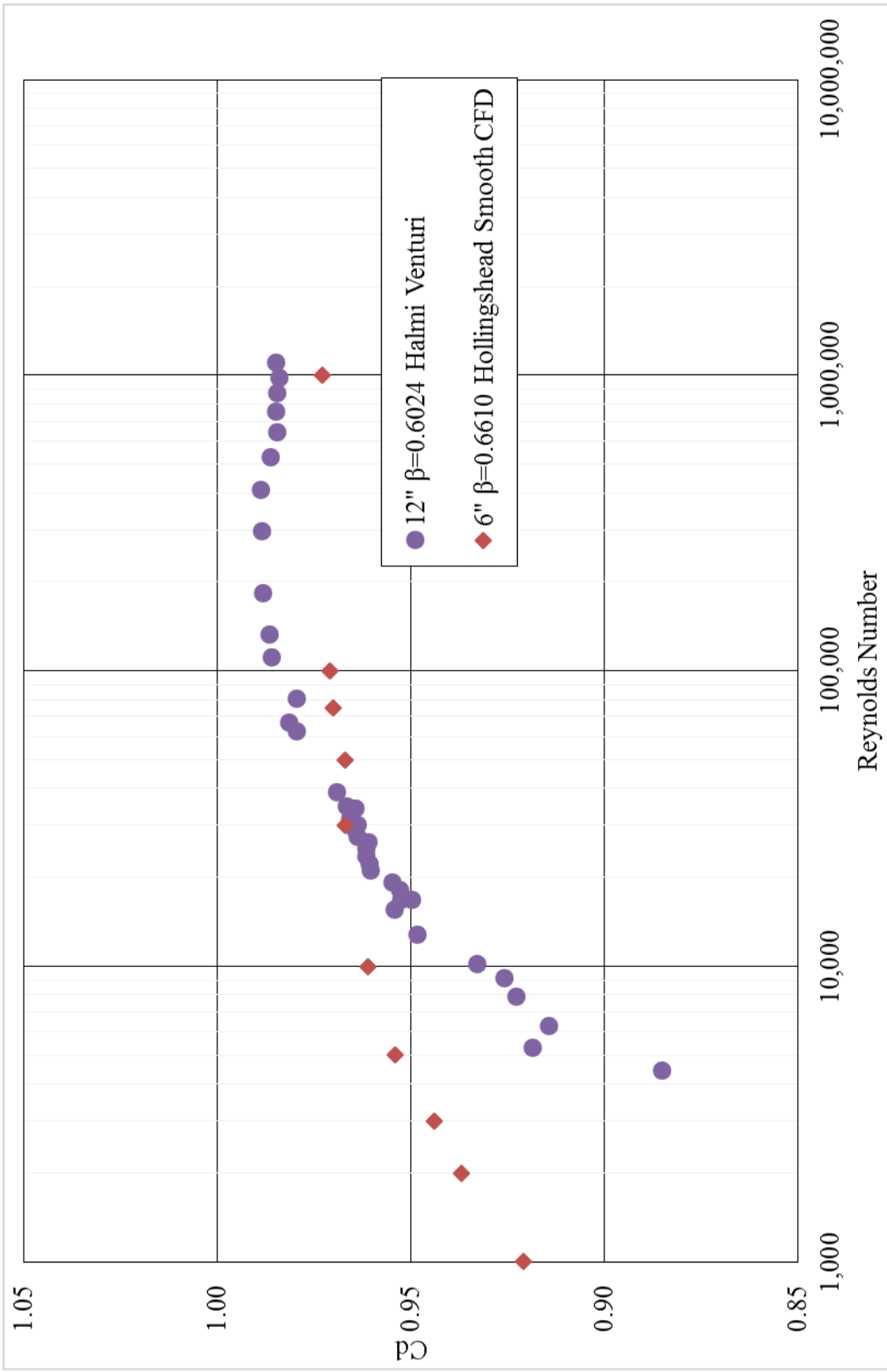

Fig. 6. Halmi Venturi discharge coefficients

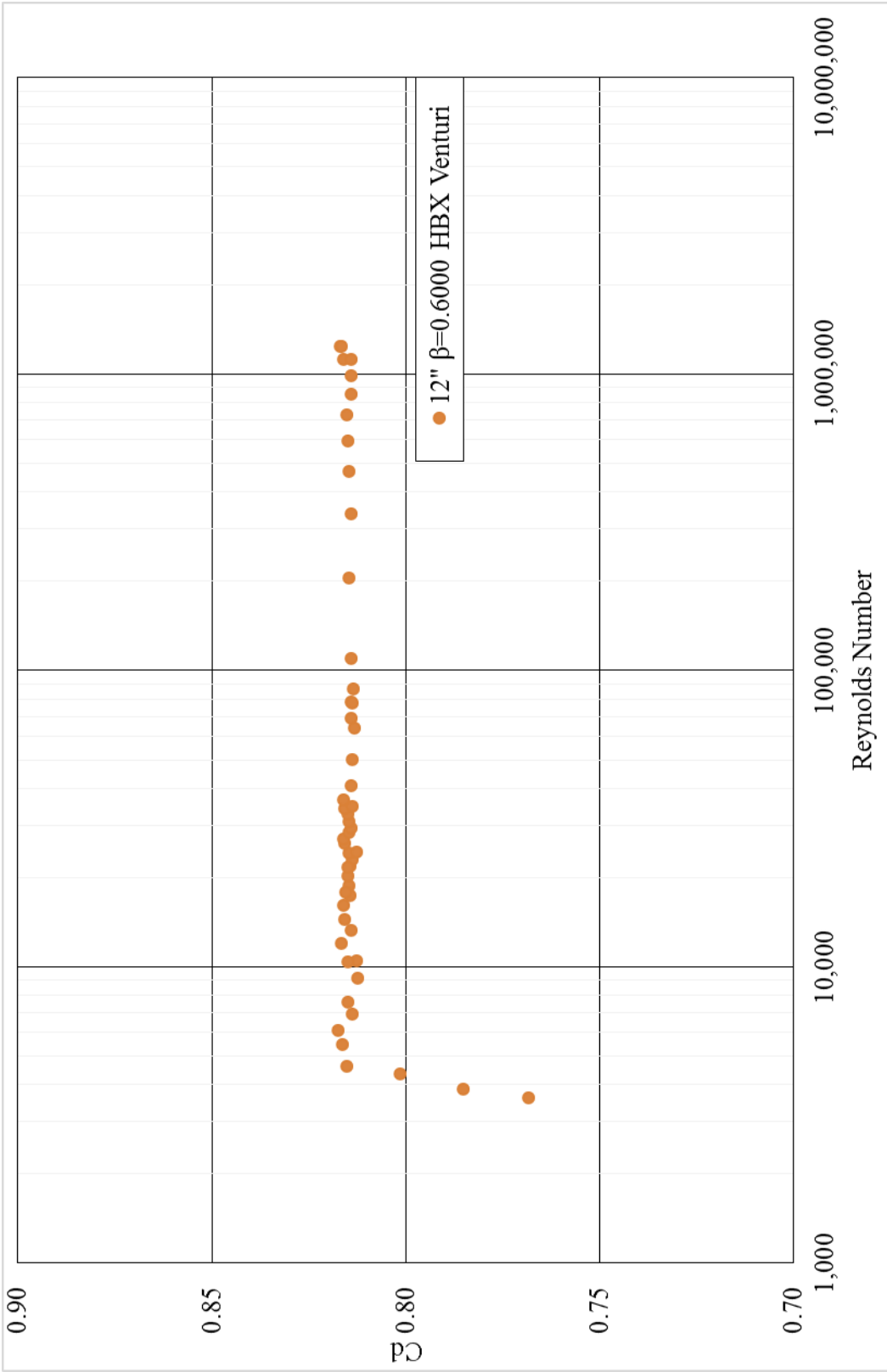

Fig. 7. HBX Venturi discharge coefficients

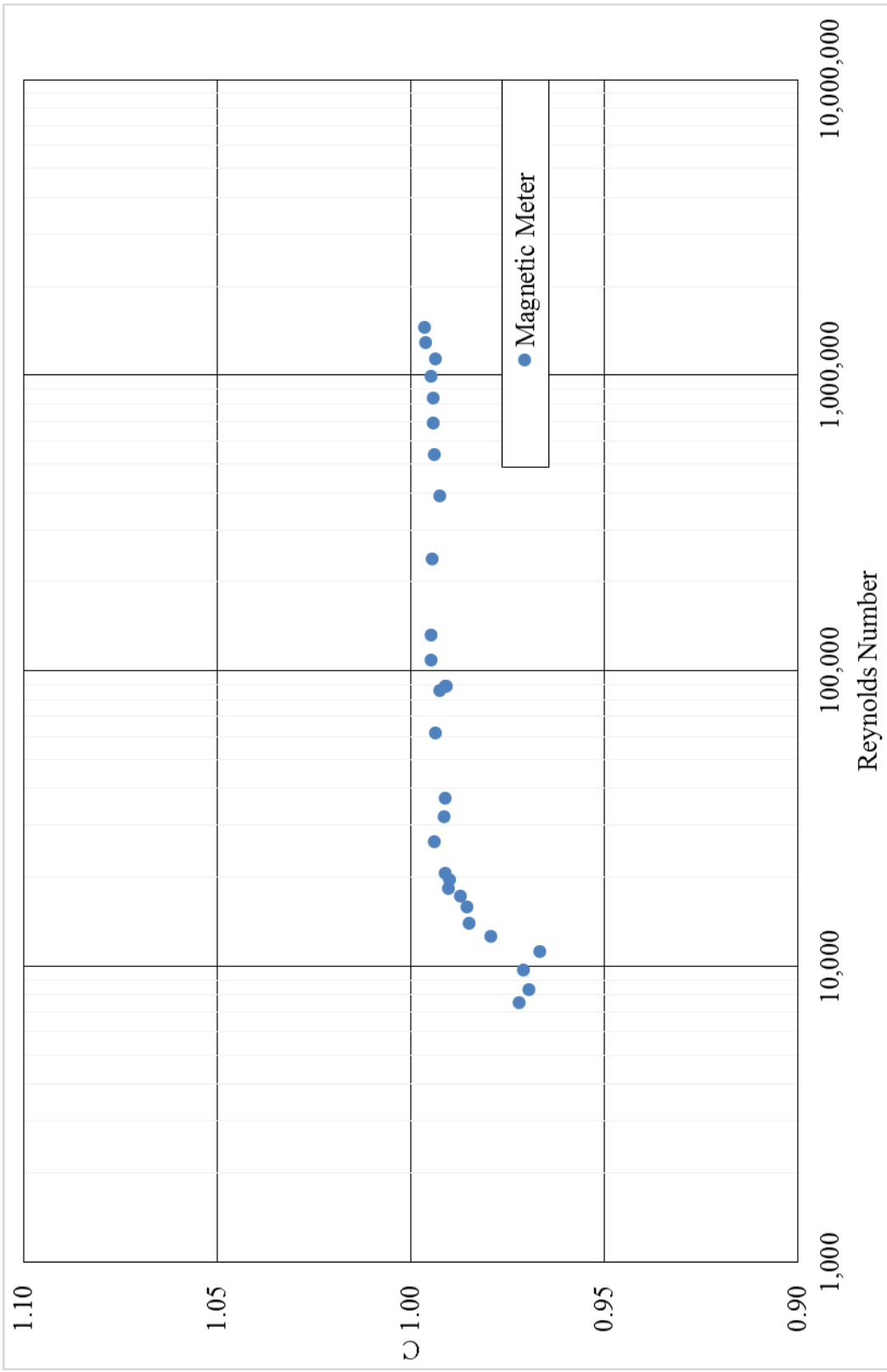

Fig. 8. Magnetic meter discharge coefficients

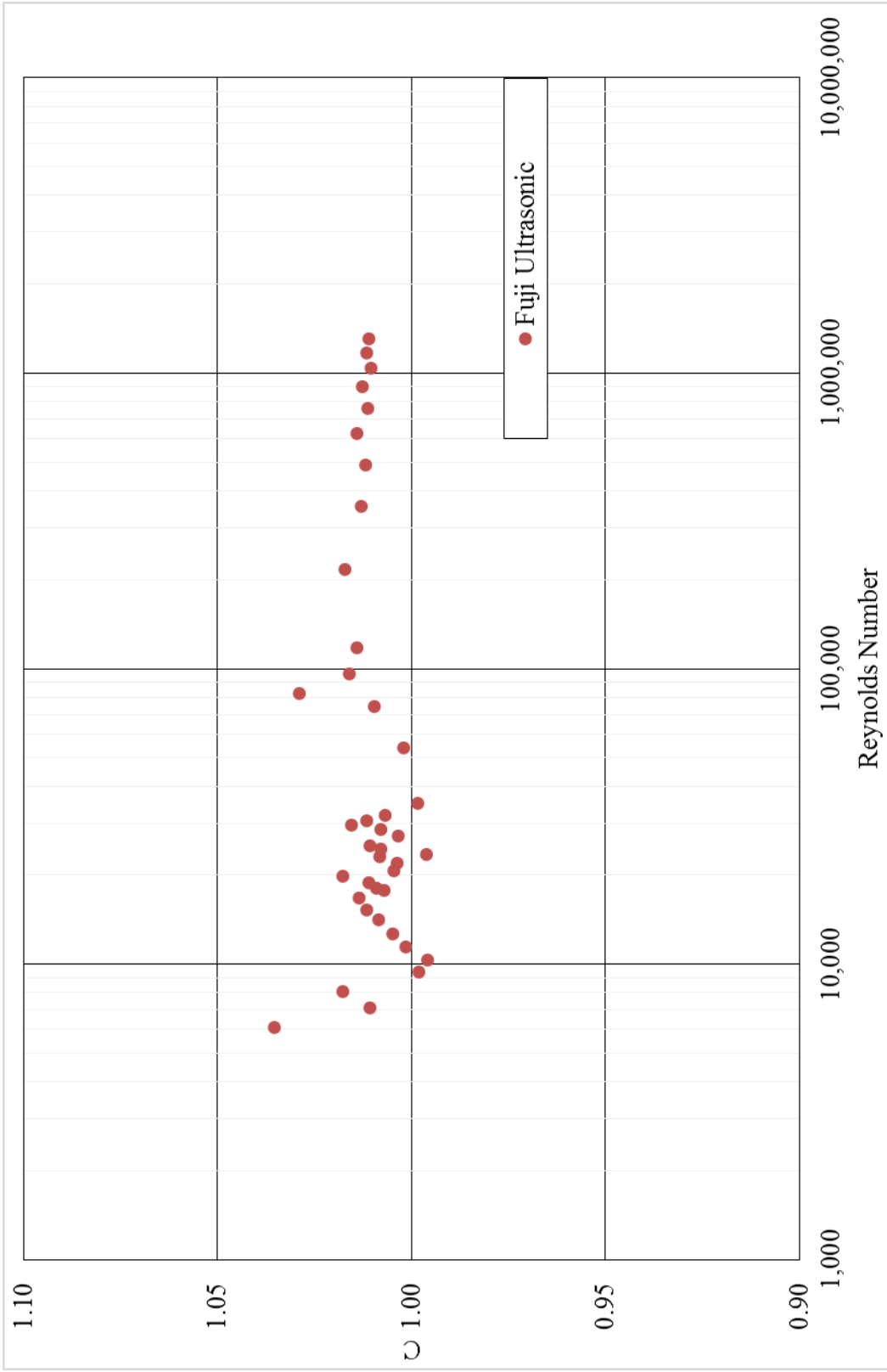

Fig. 9. Fuji Ultrasonic meter discharge coefficients

The wedge C_d average is consistent for $Re > 4,600$, but has more scatter at lower Re . The wedge meter had an average C_d of $0.6876 \pm 1.02\%$ over the entire range of the experiment. The average C_d from $Re > 100,000$ was $0.6882 \pm 0.29\%$.

The V-cone meter had an average C_d of $0.8008 \pm 0.50\%$ for $Re > 100,000$. The turndown of 10:1 for $50,000 < Re < 500,000$ is 0.47% . Any turndowns below this are greater than 0.50% variance. From $10,000 < Re < 100,000$, the C_d drops from 0.7908 to 0.8008 and $Re < 10,000$ the C_d drops significantly.

The Classical Venturi follows the $0.99 C_d$ as describe by ASME for Re ranging from $200,000$ to $6,000,000$ with a C_d of 0.9948 . The average C_d is $0.9942 \pm 0.29\%$ for $Re > 100,000$. The C_d then gradually drops off between $10,000 < Re < 100,000$. Below Re of $10,000$ the C_d drops off significantly.

The Halmi Venturi meter has a C_d of $0.9862 \pm 0.27\%$ for $Re > 100,000$. The C_d then follows a pattern similar to the Classical Venturi as it slowly decreases from $100,000 > Re > 10,000$. The Halmi has a steeper decline in C_d compared to the Classical Venturi.

The HBX Venturi meter has an average C_d of $0.8143 \pm 0.23\%$ for $Re > 100,000$. The meter has an average C_d of $0.8141 \pm 0.33\%$ from $Re > 4,600$. For $Re < 4,600$ the C_d drops quickly.

The Magnetic meter had an average C of $0.9945 \pm 0.20\%$ over the range of velocities greater than 1.40ft/s ($Re > 100,000$). The C is constant until approximately 0.25ft/s ($Re = 19,000$) with a variance of 0.34% , below this the C drops.



Fig. 10. Wedge flow meter installation.

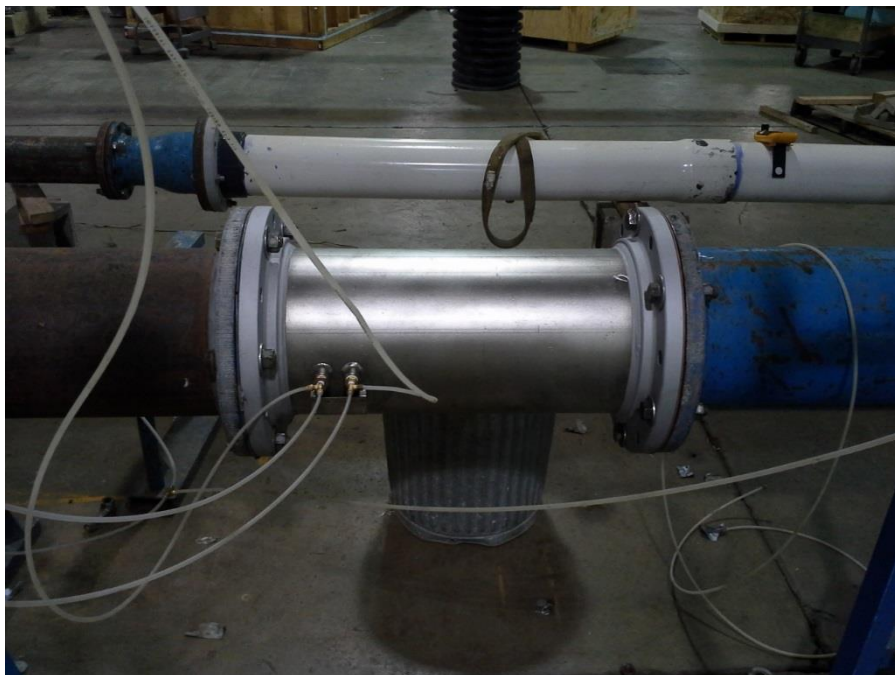

Fig. 11. V-cone flow meter installation



Fig. 13. Classical Venturi meter installation.



Fig. 12. Halmi Venturi meter installation.

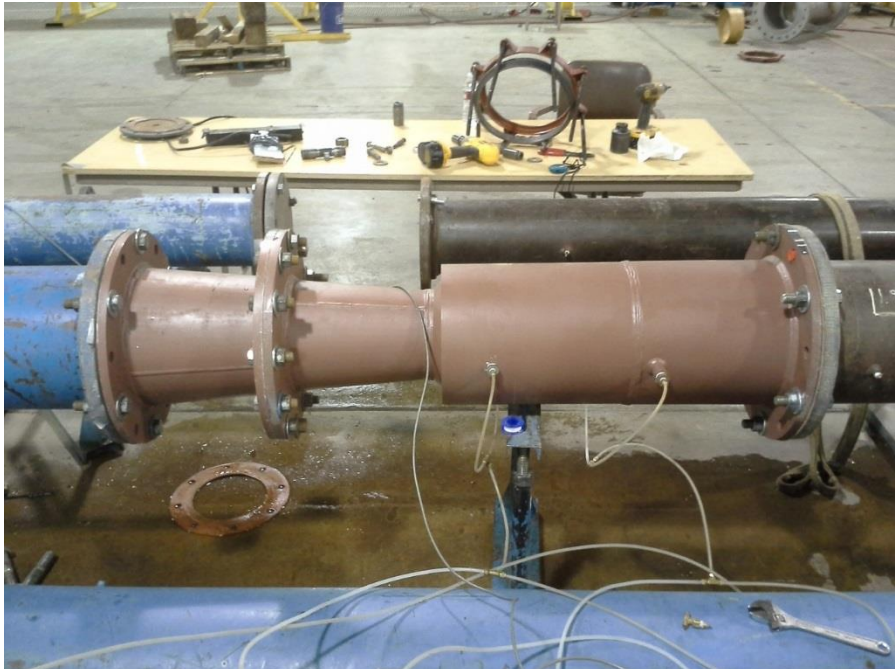

Fig. 15. HBX Venturi meter installation



Fig. 14. Magnetic flow meter installation.



Fig. 16. Ultrasonic flow meter installation.

The Fuji Ultrasonic had an average C of 1.0100 +/- 2.50% over the entire range of the test. The average C is 1.0127 from velocities greater than 1.42ft/s ($Re > 100,000$) +/- 0.43%. The velocities less than 1.42ft/s ($Re < 100,000$) has a much higher deviation, as the velocity increases, the deviation improves.

Head Loss

The head losses for each meter are presented in charts. The losses generally follow an exponential growth as the Re increases. The ratio of head loss to differential pressure however will reach a consistent number as the Re increases. At the lower Re, the ratio increases as the Re decreases and this will be shown in the results. Fig. 17 shows the results.

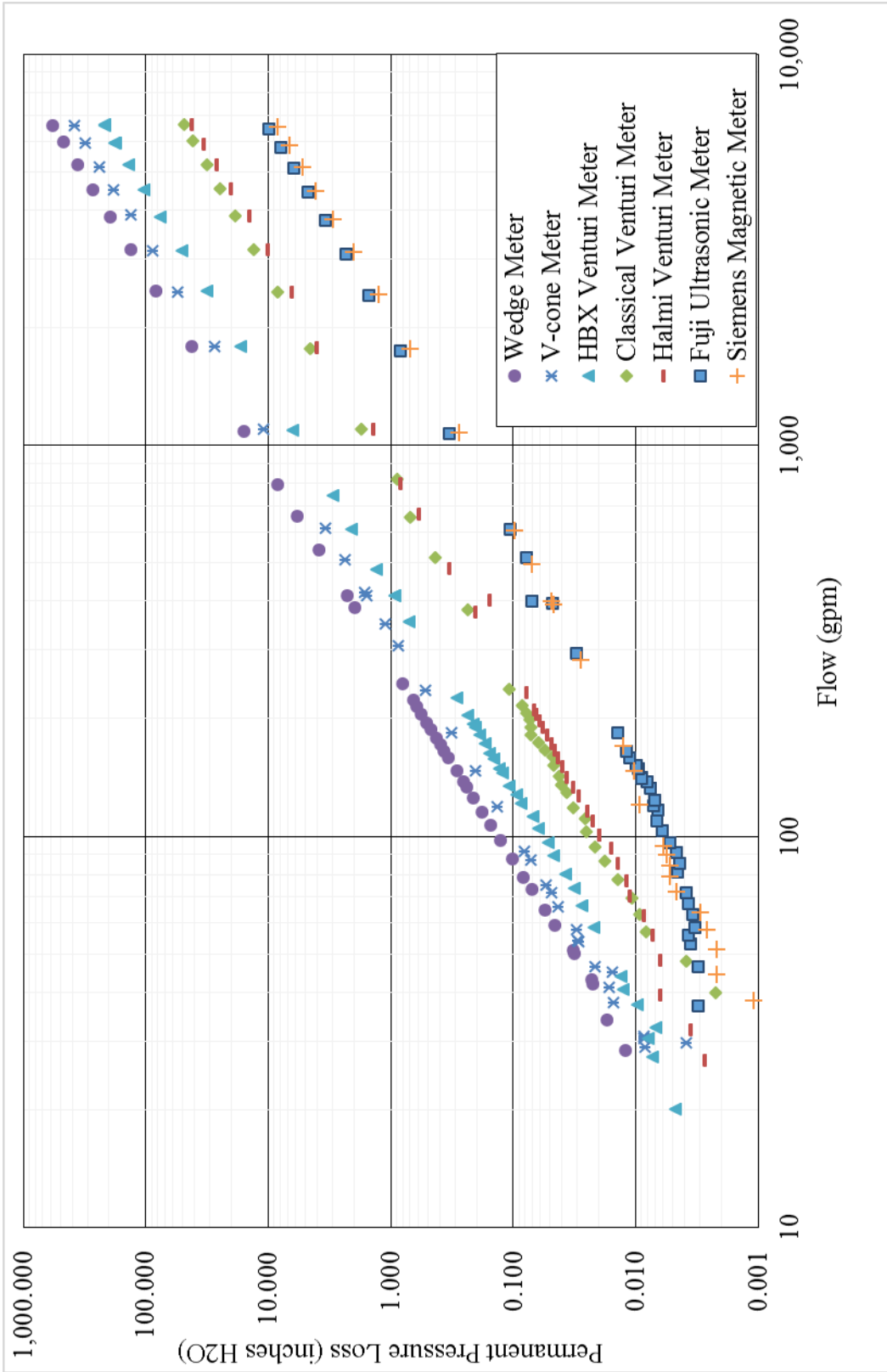

Fig. 17. Comparison of all meters Head Loss

The wedge meter had a head loss ranging from 0.01-573.75 inches of H₂O over a flow range of 28.37-6578.91 gallons per minute. The head loss averaged 59.26% +/- 0.71% of the meters differential across indicating taps and as high as 66% of the differential at the lowest flow.

The V-cone meter had a head loss ranging from 0.086-386.8 inches of H₂O over a flow range of 30.82-6557.87 gallons per minute. The head loss averaged 57.33% +/- 1.81% of the meters differential across indicating taps and was constant over the entire flow range.

The Classical Venturi meter had a head loss ranging from 0.013-49.25 inches of H₂O over a flow range of 39.76-6619.66 gallons per minute. The head loss averaged 13.23% +/- 2.88% of the meters differential across indicating taps. The lower flows produced a higher head loss.

The Halmi Venturi meter had a head loss ranging from 0.006-42.13 inches H₂O over a flow range of 37.89-6617.50 gallons per minute. The head loss averaged 10.53% +/- 2.43% of the meters differential across indicating taps. The Halmi follow a similar pattern to the Classical Venturi for low flows.

The HBX meter had a head loss ranging from 0.008-216.25 inches H₂O over a flow range of 30.45-6593.75 gallons per minute. The head loss averaged 34.10% +/- 2.57% of the meters differential across indicating taps. For lower flow rate, the ratio increases as the flow rate decreases, up to as much as 68.47%.

The Magnetic meter has an 11.9660 inch inner diameter. The head loss across the meter is minimal. The Magnetic meter had a head loss ranging from 0.0002-8.48 inches

H₂O over a flow range of 34.39-6535.38 gallons per minute. There is no ratio of head loss to differential pressure in this situation because it is not an intrusive meter.

The ultrasonic meter was strapped onto a 3-foot piece of standard 12-inch pipe. The head loss across the meter is minimal. The 3-foot pipe piece had a head loss ranging from 0.0031-9.89 inches of H₂O over the flow range of 31.58-6535.71 gallons per minute. The head loss across the pipe piece is minimal and similar to that of the Magnetic meter. There is no ratio of head loss to differential pressure in this situation because it is not an intrusive meter.

Uncertainties

The UWRL performs calibrations at 95% confidence interval according to ASME PTC 19.1-2005. Uncertainties for the discharge coefficients are listed for each meter in Table 1. Table 1 is split into two parts showing the uncertainties where all meters C_d is constant. The uncertainties increase as Re decreases.

Table 1. Uncertainties Table

| Meter | Uncertainties | Uncertainties |
|-------------------|---------------|---------------|
| | Re>100000 | Max |
| Wedge | 0.19% | 0.74% |
| V-cone | 0.19% | 0.30% |
| Classical Venturi | 0.20% | 0.72% |
| Halmi Venturi | 0.19% | 0.77% |
| HBX | 0.18% | 0.84% |
| Seimens Magnetic | 0.12% | 0.78% |
| Fuji Ultrasonic | 0.42% | 1.44% |

CHAPTER IV

DISCUSSION

Comparisons of C_d

The current research is applicable only for meters of the same geometry. The C_d (or C for magnetic and ultrasonic meters) will not transfer to other meters with different geometry, each meter needs to be calibrated and tested to find the correct C_d or C .

Equations and CFD have been made to predict C_d for meters and their different geometries. These can be comparable, but a physical calibration ensures true C_d values.

The wedge meter had a consistent C_d over the entire range. This matches Hollingshead, Yoon et al., Buhidma, and the PFS C_d reported prediction. The PFS prediction was 0.6987, which is 1.61% higher than the average C_d the wedge tested. PFS states that it is difficult to accurately predict the C_d . The closest beta ratio to the wedge meter tested was Hollingshead's wedge with beta ratio of 0.611. The 0.611 wedge C_d is 1.76% higher than the average C_d of the wedge tested. Yoon et al. found that at an H/D of 0.4 the C_d was 0.797. The wedge being tested was found to have an H/D of 0.3834 but had an average C_d of 0.6876. The difference in C_d could be due to vertex geometry. Banchhor found for an H/D of 0.4 a C_d of 0.6780 which matches closely to this study. Buhidma et al. research showed a C_d of 0.8 for Z/D ratio of 0.5. The meter currently being research has a Z/D of 0.6166. Buhidma et al. showed that when the Z/D ratio increases the C_d decreases and which would have a C_d approximate to current research.

McCrometer had a prediction for the meter of 0.8143. This is 1.60% higher than the average C_d for the tested V-cone. The V-Cone C_d for $Re \geq 8,000$ is not within +/-

0.50% as described by McCrometer. Its accuracy for this range is +/- 1.45%.turn down ratio 10:1, for $100,000 < Re < 1,000,000$ and $50,000 < Re < 500,000$ is within +/- 0.50%. The V-cone followed the same pattern as Hollingshead's. The V-cone with the 0.6611 beta ratio matches the current V-cone within 0.25% percent above Re of 100,000. Singh et al. had an average of 0.7256 over the range of testing for a beta ratio of 0.64. The Singh data stayed relatively constant the entire range, whereas the current study drops off at the lower end of the range. This could be caused by the geometry of the V-cone or the placement of the taps. Not all V-cone have the same tap orientation as the V-cone used in this study.

The Classical Venturi has a predicted C_d value of 0.9950 for $200,000 < Re < 6,000,000$. The results show an average C_d value of 0.9948 for the same range. The Classical Venturi meter approximately matches the prediction. The C_d is +/- 0.25% in the $200,000 < Re < 6,000,000$ range which matches the ASME standard. The Classical Venturi compared to Hollingshead differs by approximately 2.5% at the higher end. The drop off in Hollingshead data occurs at Re of 10,000, and the current research drops off at Re of 100,000. This could be due to the different beta ratios, but the shape of the C_d curve appears similar.

The Halmi Venturi's predicted C_d is 0.990. The results show that the Halmi Venturi had an average C_d value of 0.9862 for $Re > 100,000$. The C_d curve is similar to the Classical Venturi and has a constant C_d +/- 0.61% from $Re > 75,000$ and is within +/- 0.25% for $Re > 110,000$. This is close to what PFS reports. The drop off occurs approximately at Re of 100,000, but the Halmi meter has slightly lower C_d 's. Both the

Classical and Venturi match Miller et al. C_d curve but are shifted up. This shift could be due to different beta ratios as Miller et al. did not specify the beta ratio of the meter for their experiment. The research done by Stobie et al. data matches well with the Classical and Halmi Venturi meters when using the Re for the throat diameter until the hump which does not exist in current research.

The HBX Venturi meter is different from the Classical and Halmi Venturi by geometry. The HBX is a sudden contraction and this causes the lower C_d values, whereas the Classical and Halmi are gradual contractions that produce higher C_d values. The HBX C_d curve matches the constant C_d for $Re > 6,000$ as described by PFS and is actually constant for Re as low as 4,600. The accuracy of the meter is $\pm 0.33\%$ for $Re > 6,000$, this is very close to the $\pm 0.25\%$ PFS reports. The HBX Venturi cannot be compared to Hollingsheads, Miller et al., and Stobie et al. because of the differences in geometry.

The Siemens magnetic meter fits the specifications provided by the manufacture. The accuracy of the meter is $\pm 0.14\%$ for the range of 3ft/s to 10ft/s ($230,000 < Re < 800,000$). The accuracy is within the specifications for the range of velocity greater than 1.4ft/s ($Re > 100,000$) for the testing at $\pm 0.20\%$. The C is constant until approximately 0.24ft/s (Re of 20,000) with an accuracy of $\pm 0.29\%$. When velocity is < 0.24 ft/s ($Re < 20,000$), the accuracy of the magnetic meter drops off. The Magnetic meter when calibrated can be adjusted to have a C of 1.0000, but as found from the factory with no correction factor input into the meter the C will not be 1.0000.

The Fuji ultrasonic mag has a C accuracy +/- 1.01% for velocities greater than 1.42ft/s ($Re > 90,000$). For velocities less than 1.42ft/s ($Re < 90,000$) the accuracy of the meter has a maximum deviation +/- 2.50%. Fuji reports that the meter is +/- 1.00% accurate for velocities greater than 0.3m/s. The results show for velocities greater than 0.9843ft/s (which is 0.3m/s) the accuracy of the ultrasonic is +/- 1.48%. The data would fit the manufactures specifications if a high data point was removed at 1.17ft/s ($Re = 82,335$) where the accuracy would improve to +/- 0.43%.

Head Loss

The head loss occurs in every differential pressure meter. It is important to know how much loss will occur with each meter. The head losses found in this research only works for the meters with same geometry and shape. For large beta ratios the head loss decreases and increases for smaller ratios. All the differential producing meters in this research have a beta ratio at approximately 0.60, but the losses differ greatly from one to another because of the shapes. This is attributed to the intrusiveness of the differential producers. The wedge and V-cone are directly in the flow path which creates more losses, whereas the Classical and Halmi Venturi meters have a smooth transition that has less loss. The HBX is higher than the Classical and Halmi because of its sudden contraction.

The comparison of the differential meters shows that the wedge and V-cone meters have the highest head losses. The Classical and Halmi Venturi meters were approximately the same. Miller's prediction for the 7° exit cone, which is close to the Classical Venturi meter, shows similar results to data taken. The HBX is higher than the

Classical and Halmi meters. The Magnetic and Ultrasonic meters are virtually as if no pipe were in line. Fig. 17 shows the comparison of the different meters on a logarithmic chart.

Meter Life

The life of any meter depends upon the components used for construction. The Magnetic and Ultrasonic meters lives are based on the electronic components. The life of the electronics determines the accuracy and how long it will fully function. The fluid being measured will have an effect on the life of the Magnetic meter because of the necessary contact to infer flow rates. The medium will not affect the lifetime of the Ultrasonic meters because the meter is strapped on the outside of the pipe and never comes in contact with medium. The life of any of the differential producing meters is dependent upon the medium in the system. There are no electronic components to affect their life however they do require differential pressure transmitters for flow indication. The differential meters life can be widely different depending upon what material was used to construct the meter.

Cost of Meters

The cost of the meter is important in the selection of the meter for budgets. The cost can increase depending upon what medium is being measured and size of the system. The more harsh, abrasive, and viscous mediums will require a meter that is built to sustain the medium, this will increase the cost of the meter, and may affect the lifetime of the meter.

To better view the importance of cost for a system, an example for a pipeline which is expected to be in use for 100 years is set up. A simple life cycle cost analysis was done for each meter based on the average lifetime of the meters. The lifetime of the system will be 100 years as described with a 10% simple interest rate. Equation 15 calculates the Annual Cost.

$$Annual\ Cost = \frac{initial\ cost * i}{(1 + i)^n - 1} \quad (15)$$

where n = Years of useful life

i = Interest rate.

Table 2 shows the results of the life cycle cost analysis. This is assumes that all meters are used constantly and that each differential producing meter includes the initial cost of pressure transmitters. Service and maintenance costs are not included.

Table 2. Life Cycle Cost Analysis

| Meter | Average Life (Years) | Initial Cost (\$) | Annual Cost (\$) |
|-------------------|-------------------------|-------------------------|------------------------|
| Wedge | 30 | \$ 5,400.00 | \$ 80.83 |
| V-cone | 15 | \$ 5,900.00 | \$ 232.29 |
| Classical Venturi | 75-100 | \$ 7,100.00 | \$ 55.57 |
| Halmi Venturi | 75-100 | \$ 6,400.00 | \$ 55.51 |
| HBX Venturi | 75-100 | \$ 7,400.00 | \$ 55.59 |
| Siemens Magnetic | 10 | \$ 5,100.00 | \$ 458.63 |
| Fuji Ultrasonic | 5 | \$ 6,550.00 | \$ 1,973.54 |

In addition to the cost of the meter, the head loss can cost money if a higher head is required and pumps are being used. The use of Equations 13 and 14 calculates the cost of the pressure loss through the differential meter (Miller 1996).

The results are shown for a similar point for all meters in Table 3. The estimates are based on 8460 operating hours per year and the cost per kWh is 0.10\$.

$$hp = \frac{h_l q_{gpm}}{47500\eta} \quad (13)$$

$$Energy\ Cost \left(\frac{\$}{year} \right) = 0.746hp(operating\ hours/year) \left(\frac{\$}{kWh} \right) \quad (12)$$

where hp = Horsepower

h_l = head loss, inches

q_{gpm} = Flow in gallon per minute, gpm.

Table 3. Energy Costs

| Meter | hl | Gpm | Hp | Energy Cost |
|-------------------|--------|---------|-------|-------------|
| Wedge | 192.08 | 3800.00 | 19.21 | \$ 12,552 |
| V-cone | 131.70 | 3800.00 | 13.17 | \$ 8,606 |
| HBX Venturi | 70.37 | 3800.00 | 7.04 | \$ 4,599 |
| Classical Venturi | 18.77 | 3800.00 | 1.88 | \$ 1,226 |
| Halmi Venturi | 13.40 | 3800.00 | 1.34 | \$ 876 |
| Seimens Magnetic | 3.01 | 3800.00 | 0.30 | \$ 197 |
| Fuji Ultrasonic | 3.39 | 3800.00 | 0.34 | \$ 222 |

Ranking Meters

The selection of the meter in this study is based on four aspects: C_d or C performance, head loss, life, and cost of meters. The meters are ranked against each other based on the results. The results found in this study do not apply to any different size or geometry of the meters. Table 4 through 7 rank the meters according to accuracy, head loss, and costs. The head loss rankings are based on fig. 17. Tables 6 and 7 show the costs rankings if pumping costs were concerned or not, respectively, if head loss was

not a concern the price ranking would be based on life of the meter. If head loss was concerned, the cost of the meter is directly tied to the pumping costs. These costs are based on a 100 year life, a flow rate of 3800 gpm, interest rate of 10%, and \$0.01 per kWhr.

Using our analysis and rankings, a buyer could find a meter that would best fit his/her needs. A buyer can create a pro vs. con for each meter and decide which would fit the situation. An example situation: a pipeline system needs a meter to infer precise flow with minimal head loss for higher flow rates. The budget is minimal and the expected life of the system is 50 years. The meters are between the Ultrasonic, Magnetic, Classical Venturi, and Halmi Venturi meter. Table 8 shows the pros vs cons for this example. Based on these pros vs. cons, a buyer would choose one of the Venturis for precise flow, low head loss, low price, and long life. The Magnetic meter would be the next best choice, followed by the Ultrasonic meter. Both Magnetic and Ultrasonic meters have low head loss, however, they both have shorter lifetimes than Venturi meters. The Ultrasonic is also more expensive and has poor accuracy for the situation.

This same method can be used for assist a buyer in purchasing a meter. Other considerations can be included as well as other characteristics that may need to be addressed such as available pipeline system space, the capability of the meter to infer precise flow for different types of fluids, or meter durability.

Table 4. Discharge Coefficient Rankings

| Rank | Meter | Constant Discharge Coefficient at Reynolds Numbers | | | | | |
|------|-------------------|---|------|-------|-------|-------|--------|
| | | <5000 | 5000 | 10000 | 20000 | 50000 | 100000 |
| 1 | HBX | | X | X | X | X | X |
| 2 | Wedge | | | X | X | X | X |
| 3 | V-Cone | | | | X | X | X |
| 4 | Seimens Magnetic | | | | X | X | X |
| 5 | Halmi Venturi | | | | | | X |
| 6 | Classical Venturi | | | | | | X |
| 7 | Fuji Ultrasonic | | | | | | X |

Table 5. Head Loss Rankings

| Rank | Meter |
|------|-------------------|
| 1 | Seimens Magnetic |
| 2 | Fuji Ultrasonic |
| 3 | Halmi Venturi |
| 4 | Classical Venturi |
| 5 | HBX Venturi |
| 6 | V-Cone |
| 7 | Wedge |

Table 6. Cost Rankings (with pumping costs)

| Rank | Meter | Energy Cost (\$) | Annual Cost (\$) | Total Cost (\$) |
|------|-------------------|------------------|------------------|-----------------|
| 1 | Seimens Magnetic | \$196.79 | \$458.63 | \$655.42 |
| 2 | Halmi Venturi | \$876.00 | \$55.51 | \$931.51 |
| 3 | Classical Venturi | \$1,226.48 | \$55.57 | \$1,282.05 |
| 4 | Fuji Ultrasonic | \$221.78 | \$1,973.54 | \$2,195.32 |
| 5 | HBX Venturi | \$4,598.56 | \$55.59 | \$4,654.15 |
| 6 | V-Cone | \$8,606.29 | \$232.29 | \$8,838.58 |
| 7 | Wedge | \$12,552.48 | \$80.83 | \$12,633.31 |

Table 7. Cost Rankings (without pumping costs)

| Rank | Meter | Energy Cost (\$) | Annual Cost (\$) | Total Cost (\$) |
|------|-------------------|------------------|------------------|-----------------|
| 1 | Halmi Venturi | \$0.00 | \$55.51 | \$55.51 |
| 2 | Classical Venturi | \$0.00 | \$55.57 | \$55.57 |
| 3 | HBX Venturi | \$0.00 | \$55.59 | \$55.59 |
| 4 | Wedge | \$0.00 | \$80.83 | \$80.83 |
| 5 | V-Cone | \$0.00 | \$232.29 | \$232.29 |
| 6 | Seimens Magnetic | \$0.00 | \$458.63 | \$458.63 |
| 7 | Fuji Ultrasonic | \$0.00 | \$1,973.54 | \$1,973.54 |

Table 8. Pros vs. Cons

| Meter | Pros | Cons |
|-------------------|--|--|
| Seimens Magnetic | Accuracy +/- 0.5 C for Re>20000, no permanent pressure loss, low cost, and little additional pipe length. | Short Lifetime and can be expensive if parts need replaced |
| Fuji Ultrasonic | Optimal for no loss introduced into the system, no additional pipe length, and is accurate +/- 1.00 for Re>100000. | Short lifetime and expensive for constant use. |
| Halmi Venturi | Excellent Cd accuracy +/- 0.27% for Re>100000, low cost, and long lifetime. | Has permanent pressure loss and additional pipe length. |
| Classical Venturi | Excellent Cd accuracy +/- 0.29% for Re>100000, low cost, and long lifetime. | Has permanent pressure loss and additional pipe length. |

CHAPTER V

CONCLUSION

This study specifically studied 12-inch meters with a beta ratio of approximately 0.60 for the differential producing meters. The data will not repeat for meters of different sizes or different beta ratios. The C_d (or C for magnetic or ultrasonic meters) and head loss would need to be calculated for each meter.

The meters each have different unique C_d and curves especially at low Re . The results provide where the C_d drops significantly and how accurate the meters are over a wide range of Re . The curves from previous research show that for the same meter with different geometry the shape will be similar but will shift dependent upon geometry. More research needs to be completed using different beta ratios to better compare the shape of curves and observe relationships of geometry to C_d performance. Another area of interest for further research is test the meters with a different medium with a higher viscosity, compare with water, and test at lower Re .

The head loss is directly related to the intrusiveness of the meter. The highest losses have immediate reduction or a geometry directly in the flow path and the low loss meters have a gradual reduction. The wedge, V-cone, and HBX meters have the highest losses and the Classical and Halmi Venturis are low. The Magnetic and Ultrasonic meters have no head loss because they are not differential pressure meters. An area of further research is to measure the head loss of different beta ratios and geometries of meters to better understand the relationship of the beta ratio and geometry to head losses.

The lifetime and cost of the meters can vary depending upon the fluid and how the flow is inferred. The life of differential meters is longer because the flow is inferred by the geometry of the meter. The electrical meters have shorter life due to the electronic components. If the fluid is harsh and corrosive, the material of the meter resistant to the medium and can be more expensive. Harsh fluids will also shorten the life of the meter by causing erosion which in turn will negatively affect the flow meters accuracy.

It is important to know the meter's accuracy, how long the meter will last, and the cost to select a suitable meter for a given situation. No situation will be the same and not all meters will function optimally for each application. With the results found in the study, a buyer can look at the accuracy of the C_d and head loss over the large range of Re , life, and cost of the meter and be able to select a meter that will best fit their needs.

REFERENCES

- Atkinson, D. I., Berard, M., and Ségéral, G. (2000). "Qualification of a nonintrusive multiphase flow meter in viscous flow." *SPE An. Tech. Conf. and Exhib.*, SPE, Dallas TX.
- Banchor, P.K., Singh, S.N., Seshardri, V., and Gandhi, B.K. (2002). "Performance characteristics of wedge flowmeter using CFD." *J.Comp. FlDy.*, 11(3), 279-284.
- Buhidma, Abdullah, and Pal, Rajinder. (1996). "Flow Measurement of two-phase oil-in-water emulsions using wedge meters and segmental orifice meters." *J. Chem. Eng.*, 63, 59-64.
- Benedict, R. P., and Wyler, J.S. (1974). "A generalized discharge coefficient for differential pressure type fluid meters." *ASME J. Eng. for Pwr.*, 96 (A), 440-448.
- Fuji Electric Co. (2013). "Fuji Ultrasonic flowmeter series." Fuji, Tokyo, Japan. <<http://www.fujielectric.com/products/instruments/library/catalog/box/doc/21A1-E-0008.pdf>> (Mar. 3, 2014).
- Hollingshead, Colter L. (2011). "Discharge coefficient performance of venturi, standard concentric orifice plate, V-cone, and wedge flow meters at small reynolds numbers." M.S. thesis, Utah State University, Logan, UT.
- McCrometer Inc. (2014). V-Cone Flow Meter, McCrometer, Hemmit, California, <http://www.mccrometer.com/products/product_vccone.asp> (Mar. 7, 2014).
- Miller, G., Pinguet, B., Theuveny, B., and Mosknes, P. (2009). "The influence of liquid viscosity on multiphase flow meters." TUV NEL, Glasgow, United Kingdom. <http://www.tekna.no/ikbViewer/Content/778329/14_Miller%20HV_Multiphase.pdf> (Feb. 16, 2010).
- Miller, R. W. (1996). *Flow measurement engineering handbook*, third ed. McGraw-Hill Companies, Inc., Boston, MA.
- Pal, R. (1993). "Flow of oil-in-water emulsions through orifice and Venturi meters." *Ind. Eng. and Chem. Res.*, 32, 1212-1217.
- Primary Flow Signal, (2009). "PFS-CV", Primary Flow Signal, Warwick RI. <http://primaryflowsignal.com/images/stories/ProductsPDFs/pfs_cv_asme_fabricated_pressure_vessel.pdf> (Apr. 19, 2014).

- Primary Flow Signal. (2012a). "HVT-FV Fabricated Venturi Pressure Vessel." Primary Flow Signal, Warwick, RI.
<http://primaryflowsignal.com/images/stories/ProductsPDFs/pfs_cv_asme_fabricated_pressure_vessel.pdf> (Mar. 9, 2014).
- Primary Flow Signal. (2012b). "Wedge Type Flow Meter." Primary Flow Signal, Warwick, RI. <<http://primaryflowsignal.com/products/wedge-type-flow-elements/technical-materials>> (Mar.12, 2014).
- Primary Flow Signal. (2013). "HBX-1 Halmi-Briggs." Primary Flow Signal, Warwick, RI.
<http://primaryflowsignal.com/images/stories/ProductsPDFs/pfs_data_hbx1.pdf> (May 5, 2014).
- Siemens A/S. (2010). "Which cost efficient flowmeters are both reliable and tailored to your needs?" Siemens A/S, Munich, Germany.
<<https://www.automation.siemens.com/mcms/infocenter/dokumentcenter/sc/pi/Documentsu20Brochures/E20001-A450-P710-V2-7600.pdf>> (Mar. 2, 2014)
- Singh, S., Seshadri, V., Singh, R., and Gawhade, R. (2006). "Effect of upstream flow disturbances on the performance characteristics of a V-cone flow meter." *J. Flow Meas. Instr.*, 17(5), 291-297.
- Stobie, G. S., Svedeman, S., and Zanker, K. (2007). "Erosion in a Venturi meter with laminar and turbulent flow and low Reynolds Number discharge coefficient measurements." Oslo, Norway, 2007.
- Yoon, J., Sung, N., and Lee, C. 2007. "Discharge coefficient equation of a segmental wedge flow meter." *J. Prcs. Mech. Eng.*, 222(E), 79-83.

APPENDIX

Table 9. Wedge Meter Data High Re

Date 12/10/2013
 Pipe Diameter 11.9725 in
 Meter Bore 7.112 in
 Beta ratio 0.6053
 Temperature 43.2 F°
 Density 1.94 lb/ft³
 Gravity 32.17 ft/s²

| Run No. | Flow | Meter Diff. | Re | C | Error and Uncertainty | | Vel. | Meter Loss | |
|---------|----------|----------------------------------|-----------|--------|-----------------------|----------|----------|----------------------------------|-----------------------------|
| | Flow gpm | $\Delta H 1$ in H ₂ O | Re # | C | deviation % | Uncer. % | Vel. fps | $\Delta H 2$ in H ₂ O | $\Delta H 2 / \Delta H 1$ % |
| 1 | 413.07 | 3.84 | 74,634 | 0.6881 | -0.01% | 0.18% | 1.17 | 2.29 | 60% |
| 2 | 1084.98 | 26.63 | 196,036 | 0.6862 | -0.29% | 0.19% | 3.08 | 15.97 | 60% |
| 3 | 1786.73 | 71.94 | 322,830 | 0.6875 | -0.11% | 0.12% | 5.07 | 42.53 | 59% |
| 4 | 2484.89 | 139.13 | 448,973 | 0.6875 | -0.10% | 0.13% | 7.05 | 82.31 | 59% |
| 5 | 3160.03 | 224.44 | 570,960 | 0.6884 | 0.02% | 0.11% | 8.96 | 132.75 | 59% |
| 6 | 3822.96 | 328.13 | 690,738 | 0.6887 | 0.08% | 0.14% | 10.84 | 194.38 | 59% |
| 7 | 4511.05 | 456.25 | 815,063 | 0.6892 | 0.15% | 0.12% | 12.80 | 270.31 | 59% |
| 8 | 5217.83 | 611.25 | 942,766 | 0.6887 | 0.08% | 0.11% | 14.80 | 361.56 | 59% |
| 9 | 5964.16 | 798.13 | 1,077,614 | 0.6890 | 0.11% | 0.11% | 16.92 | 472.19 | 59% |
| 10 | 6578.91 | 971.88 | 1,188,688 | 0.6887 | 0.07% | 0.10% | 18.66 | 573.75 | 59% |

Table 10. Wedge Meter Data Low Re

Date 12/10/2013
 Pipe Diameter 11.9725 in
 Meter Bore 7.112 in
 Beta ratio 0.6053
 Temperature 37.0 F°
 Density 1.94 lb/ft³
 Gravity 32.17 ft/s²

| Run No. | Flow | Meter Diff. | Re | C | Error and Uncertainty | | Vel. | Meter Loss | |
|---------|-------------|-------------------------------------|---------|--------|-----------------------|----------|-------------|-------------------------------------|--------------------------------|
| | Flow gpm | $\Delta H 1$ in H ₂ O | Re # | C | deviation % | Uncer. % | Vel. fps | $\Delta H 2$ in H ₂ O | $\Delta H 2 / \Delta H 1$ % |
| 1 | 28.37 | 0.02 | 4,599 | 0.6806 | -0.99% | 0.74% | 0.080 | 0.01 | 66% |
| 2 | 33.91 | 0.03 | 5,498 | 0.6881 | 0.09% | 0.73% | 0.096 | 0.02 | 66% |
| 3 | 41.98 | 0.04 | 6,806 | 0.6839 | -0.51% | 0.61% | 0.119 | 0.02 | 56% |
| 4 | 49.99 | 0.06 | 8,104 | 0.6814 | -0.88% | 0.49% | 0.142 | 0.03 | 56% |
| 5 | 50.96 | 0.06 | 8,262 | 0.6818 | -0.82% | 0.49% | 0.145 | 0.03 | 55% |
| 6 | 59.25 | 0.08 | 9,606 | 0.6888 | 0.20% | 0.44% | 0.168 | 0.05 | 58% |
| 7 | 64.92 | 0.09 | 10,524 | 0.6880 | 0.08% | 0.39% | 0.184 | 0.06 | 58% |
| 8 | 73.18 | 0.12 | 11,864 | 0.6858 | -0.23% | 0.37% | 0.208 | 0.07 | 59% |
| 9 | 78.56 | 0.14 | 12,736 | 0.6852 | -0.33% | 0.34% | 0.223 | 0.08 | 59% |
| 10 | 87.37 | 0.17 | 14,164 | 0.6890 | 0.23% | 0.31% | 0.248 | 0.10 | 60% |
| 11 | 97.37 | 0.21 | 15,786 | 0.6883 | 0.16% | 0.29% | 0.276 | 0.13 | 60% |
| 12 | 106.44 | 0.25 | 17,255 | 0.6883 | 0.12% | 0.26% | 0.302 | 0.15 | 60% |
| 13 | 115.33 | 0.30 | 18,698 | 0.6879 | 0.07% | 0.24% | 0.327 | 0.18 | 60% |
| 14 | 125.39 | 0.36 | 20,329 | 0.6862 | -0.18% | 0.23% | 0.356 | 0.21 | 60% |
| 15 | 133.25 | 0.40 | 21,603 | 0.6873 | -0.02% | 0.21% | 0.378 | 0.24 | 60% |
| 16 | 137.94 | 0.43 | 22,362 | 0.6867 | -0.11% | 0.21% | 0.391 | 0.26 | 60% |
| 17 | 146.71 | 0.48 | 23,785 | 0.6884 | 0.14% | 0.23% | 0.416 | 0.29 | 60% |
| 18 | 158.90 | 0.57 | 25,760 | 0.6891 | 0.24% | 0.23% | 0.451 | 0.34 | 60% |
| 19 | 165.53 | 0.61 | 26,835 | 0.6902 | 0.41% | 0.22% | 0.470 | 0.37 | 60% |
| 20 | 171.31 | 0.66 | 27,773 | 0.6882 | 0.10% | 0.21% | 0.486 | 0.40 | 60% |
| 21 | 178.22 | 0.72 | 28,893 | 0.6872 | -0.03% | 0.20% | 0.506 | 0.43 | 60% |
| 22 | 187.43 | 0.79 | 30,386 | 0.6893 | 0.27% | 0.19% | 0.532 | 0.47 | 60% |
| 23 | 195.10 | 0.86 | 31,629 | 0.6856 | -0.27% | 0.18% | 0.553 | 0.51 | 60% |
| 24 | 205.18 | 0.95 | 33,264 | 0.6856 | -0.26% | 0.18% | 0.582 | 0.57 | 60% |
| 25 | 214.84 | 1.04 | 34,830 | 0.6875 | 0.01% | 0.17% | 0.609 | 0.62 | 59% |
| 26 | 222.31 | 1.11 | 36,041 | 0.6894 | 0.28% | 0.17% | 0.631 | 0.66 | 59% |
| 27 | 244.76 | 1.34 | 39,680 | 0.6894 | 0.28% | 0.16% | 0.694 | 0.80 | 60% |
| 28 | 381.89 | 3.25 | 61,912 | 0.6910 | 0.51% | 0.20% | 1.083 | N/A | N/A |
| 29 | 385.10 | 3.30 | 62,433 | 0.6918 | 0.64% | 0.20% | 1.092 | 1.98 | 60% |
| 30 | 540.57 | 6.51 | 87,637 | 0.6916 | 0.61% | 0.14% | 1.533 | 3.88 | 60% |
| 31 | 658.67 | 9.75 | 106,784 | 0.6884 | 0.14% | 0.13% | 1.869 | 5.78 | 59% |
| 32 | 794.33 | 14.20 | 128,777 | 0.6878 | 0.06% | 0.13% | 2.253 | 8.43 | 59% |

Table 11. Data for V-cone Meter High Re

Date 8/8/2013
 Pipe Diameter 12.095 in
 Meter Bore 9.712 in
 Beta ratio 0.596
 Temperature 56.4 F°
 Density 1.939 lb/ft³
 Gravity 32.17 ft/s²

| Run No. | Flow | Meter Diff. | Re | C | Error and Uncertainty | | Vel. | Meter Loss | |
|---------|----------|----------------------------------|-----------|--------|-----------------------|----------|----------|----------------------------------|-----------------------------|
| | Flow gpm | $\Delta H 1$ in H ₂ O | Re Number | C | deviation % | Uncer. % | Vel. fps | $\Delta H 2$ in H ₂ O | $\Delta H 2 / \Delta H 1$ % |
| 1 | 412.6 | 2.66 | 91,104 | 0.8034 | 0.24% | 0.21% | 1.17 | 1.5625 | 59% |
| 2 | 1097.9 | 18.83 | 242,413 | 0.8030 | 0.19% | 0.19% | 3.11 | 10.9531 | 58% |
| 3 | 1785.0 | 50.10 | 394,120 | 0.8003 | -0.15% | 0.19% | 5.06 | 27.8125 | 56% |
| 4 | 2457.7 | 94.70 | 542,650 | 0.8015 | 0.00% | 0.16% | 6.97 | 54.9375 | 58% |
| 5 | 3139.7 | 155.40 | 693,245 | 0.7993 | -0.28% | 0.15% | 8.91 | 87.9375 | 57% |
| 6 | 3873.6 | 236.60 | 855,278 | 0.7992 | -0.29% | 0.16% | 10.99 | 132.6563 | 56% |
| 7 | 4496.6 | 318.75 | 992,847 | 0.7993 | -0.28% | 0.19% | 12.76 | 182.6563 | 57% |
| 8 | 5149.9 | 416.25 | 1,137,088 | 0.8010 | -0.06% | 0.17% | 14.61 | 239.5313 | 58% |
| 9 | 5911.8 | 545.63 | 1,305,316 | 0.8032 | 0.21% | 0.16% | 16.77 | 315.0000 | 58% |
| 10 | 6557.9 | 668.75 | 1,447,968 | 0.8047 | 0.41% | 0.16% | 18.60 | 386.8750 | 58% |

Table 12. Data for V-cone Meter Low Re

Date 8/9/2013
 Pipe Diameter 12.10 in
 Meter Bore 9.712 in
 Beta ratio 0.596
 Temperature 58.6 F°
 Density 1.939 lb/ft³
 Gravity 32.17 ft/s²

| Run No. | Flow | Meter Diff. | Re | C | Error and Uncertainty | | Vel. | Meter Loss | |
|---------|-------------|-------------------------------------|--------------|--------|-----------------------|----------|-------------|-------------------------------------|---------------------------------|
| | Flow gpm | ΔH 1 in H ₂ O | Re Number | C | deviation % | Uncer. % | Vel. fps | ΔH 2 in H ₂ O | ΔH 2/ ΔH 1 % |
| 1 | 29.0 | 0.01 | 6,605 | 0.7776 | -2.22% | 0.30% | 0.082 | 0.0084 | 59% |
| 2 | 29.7 | 0.02 | 6,772 | 0.7597 | -4.47% | 0.28% | 0.084 | N/A | N/A |
| 3 | 30.8 | 0.02 | 7,031 | 0.7750 | -2.55% | 0.28% | 0.087 | 0.0086 | 53% |
| 4 | 37.5 | 0.02 | 8,564 | 0.7908 | -0.56% | 0.22% | 0.106 | 0.0154 | 67% |
| 5 | 41.1 | 0.03 | 9,373 | 0.7908 | -0.55% | 0.20% | 0.117 | 0.0166 | 60% |
| 6 | 44.8 | 0.03 | 10,231 | 0.7928 | -0.30% | 0.19% | 0.127 | 0.0156 | 48% |
| 7 | 46.3 | 0.03 | 10,572 | 0.7960 | 0.10% | 0.18% | 0.131 | 0.0214 | 62% |
| 8 | 53.8 | 0.05 | 12,276 | 0.7920 | -0.41% | 0.17% | 0.153 | 0.0291 | 62% |
| 9 | 54.1 | 0.05 | 12,352 | 0.7901 | -0.64% | 0.17% | 0.154 | 0.0301 | 63% |
| 10 | 57.8 | 0.05 | 13,185 | 0.7902 | -0.63% | 0.16% | 0.164 | 0.0308 | 56% |
| 11 | 66.1 | 0.07 | 15,080 | 0.7986 | 0.42% | 0.16% | 0.188 | 0.0433 | 62% |
| 12 | 71.6 | 0.08 | 16,343 | 0.8004 | 0.65% | 0.16% | 0.203 | 0.0489 | 60% |
| 13 | 75.0 | 0.09 | 17,114 | 0.7997 | 0.57% | 0.16% | 0.213 | 0.0547 | 61% |
| 14 | 87.2 | 0.12 | 19,888 | 0.8009 | 0.72% | 0.22% | 0.247 | 0.0723 | 60% |
| 15 | 91.5 | 0.13 | 20,879 | 0.7997 | 0.56% | 0.21% | 0.260 | 0.0810 | 60% |
| 16 | 119.3 | 0.23 | 27,227 | 0.7978 | 0.32% | 0.17% | 0.339 | 0.1359 | 59% |
| 17 | 147.1 | 0.34 | 33,551 | 0.8014 | 0.77% | 0.16% | 0.417 | 0.2044 | 59% |
| 18 | 184.4 | 0.54 | 42,080 | 0.8030 | 0.98% | 0.20% | 0.523 | 0.3197 | 59% |
| 19 | 236.5 | 0.89 | 53,966 | 0.8039 | 1.09% | 0.17% | 0.671 | 0.5213 | 59% |
| 20 | 307.2 | 1.49 | 70,090 | 0.8049 | 1.21% | 0.16% | 0.872 | 0.8738 | 59% |
| 21 | 348.2 | 1.92 | 79,446 | 0.8051 | 1.24% | 0.22% | 0.988 | 1.1175 | 58% |
| 22 | 420.8 | 2.80 | 96,003 | 0.8053 | 1.26% | 0.18% | 1.194 | 1.6263 | 58% |
| 23 | 509.7 | 4.12 | 116,276 | 0.8038 | 1.08% | 0.17% | 1.446 | 2.3800 | 58% |
| 24 | 614.6 | 5.95 | 140,212 | 0.8061 | 1.36% | 0.16% | 1.743 | 3.4500 | 58% |

Table 13. Data for. Classical Venturi Meter High Re

Date 1/3/2014
 Pipe Diameter 11.978 in
 Meter Bore 7.2395 in
 Beta ratio 0.6044
 Temperature 38.0 F°
 Density 1.941 lb/ft³
 Gravity 32.17 ft/s²

| Run No. | Flow | Meter Diff. | Re | C | Error and Uncertainty | | Vel. | Meter Loss | |
|---------|----------|----------------------------------|-----------|--------|-----------------------|----------|----------|----------------------------------|-----------------------------|
| | Flow gpm | $\Delta H 1$ in H ₂ O | Re Number | C | deviation % | Uncer. % | Vel. fps | $\Delta H 2$ in H ₂ O | $\Delta H 2 / \Delta H 1$ % |
| 1 | 400.83 | 1.61 | 66,128 | 0.9891 | -0.50% | 0.19% | 1.14 | 0.15 | 10% |
| 2 | 1096.45 | 11.97 | 180,889 | 0.9931 | -0.10% | 0.20% | 3.11 | 1.73 | 14% |
| 3 | 1769.41 | 31.16 | 291,913 | 0.9933 | -0.08% | 0.13% | 5.02 | 4.53 | 15% |
| 4 | 2462.51 | 60.16 | 406,258 | 0.9949 | 0.08% | 0.17% | 6.99 | 8.47 | 14% |
| 5 | 3164.23 | 99.38 | 522,027 | 0.9946 | 0.06% | 0.13% | 8.98 | 13.16 | 13% |
| 6 | 3851.58 | 147.34 | 635,423 | 0.9942 | 0.02% | 0.12% | 10.93 | 18.78 | 13% |
| 7 | 4540.36 | 204.69 | 749,056 | 0.9944 | 0.04% | 0.11% | 12.88 | 25.00 | 12% |
| 8 | 5232.02 | 271.25 | 863,165 | 0.9954 | 0.14% | 0.16% | 14.84 | 32.06 | 12% |
| 9 | 6007.09 | 357.50 | 991,032 | 0.9955 | 0.15% | 0.14% | 17.04 | 41.13 | 12% |
| 10 | 6619.66 | 433.75 | 1,092,092 | 0.9959 | 0.19% | 0.12% | 18.78 | 49.25 | 11% |

Table 14. Data for Classical Venturi Meter Low Re

Date 1/3/2014
 Pipe Diameter 11.978 in
 Meter Bore 7.2395 in
 Beta ratio 0.6044
 Temperature 38.0 F°
 Density 1.941 lb/ft³
 Gravity 32.17 ft/s²

| Run No. | Flow | Meter Diff. | Re | C | Error and Uncertainty | | Vel. | Meter Loss | |
|---------|-------------|-------------------------------------|--------------|--------|-----------------------|----------|-------------|-------------------------------------|----------------------------|
| | Flow gpm | ΔH 1 in H ₂ O | Re Number | C | deviation % | Uncer. % | Vel. fps | ΔH 2 in H ₂ O | $\Delta H2/\Delta H1$ % |
| 1 | 25.49 | 0.01 | 4,204 | 0.8864 | -8.21% | 0.72% | 0.072 | N/A | N/A |
| 2 | 32.13 | 0.01 | 5,301 | 0.9195 | -4.78% | 0.62% | 0.091 | N/A | N/A |
| 3 | 39.76 | 0.02 | 6,560 | 0.9429 | -2.36% | 0.63% | 0.113 | 0.0133 | 75% |
| 4 | 48.01 | 0.03 | 7,921 | 0.9557 | -1.03% | 0.48% | 0.136 | 0.0149 | 59% |
| 5 | 56.84 | 0.04 | 9,378 | 0.9555 | -1.05% | 0.44% | 0.161 | 0.0194 | 55% |
| 6 | 63.22 | 0.04 | 10,429 | 0.9527 | -1.34% | 0.42% | 0.179 | 0.0204 | 46% |
| 7 | 69.27 | 0.05 | 11,428 | 0.9556 | -1.05% | 0.36% | 0.197 | 0.0219 | 42% |
| 8 | 77.57 | 0.07 | 12,797 | 0.9588 | -0.71% | 0.33% | 0.220 | 0.0252 | 39% |
| 9 | 86.53 | 0.08 | 14,276 | 0.9672 | 0.16% | 0.30% | 0.245 | 0.0289 | 36% |
| 10 | 94.08 | 0.09 | 15,520 | 0.9671 | 0.14% | 0.29% | 0.267 | 0.0326 | 35% |
| 11 | 102.49 | 0.11 | 16,909 | 0.9667 | 0.10% | 0.31% | 0.291 | 0.0366 | 33% |
| 12 | 111.06 | 0.13 | 18,323 | 0.9639 | -0.19% | 0.27% | 0.315 | 0.0373 | 28% |
| 13 | 118.25 | 0.15 | 19,509 | 0.9655 | -0.01% | 0.26% | 0.335 | 0.0328 | 22% |
| 14 | 129.28 | 0.18 | 21,327 | 0.9676 | 0.20% | 0.24% | 0.367 | 0.0368 | 21% |
| 15 | 135.06 | 0.19 | 22,281 | 0.9685 | 0.29% | 0.23% | 0.383 | 0.0404 | 21% |
| 16 | 142.51 | 0.22 | 23,510 | 0.9667 | 0.10% | 0.22% | 0.404 | 0.0425 | 20% |
| 17 | 151.49 | 0.24 | 24,992 | 0.9687 | 0.31% | 0.20% | 0.430 | 0.0472 | 19% |
| 18 | 159.38 | 0.27 | 26,294 | 0.9701 | 0.45% | 0.20% | 0.452 | 0.0478 | 18% |
| 19 | 166.34 | 0.29 | 27,442 | 0.9711 | 0.56% | 0.19% | 0.472 | 0.0549 | 19% |
| 20 | 173.46 | 0.32 | 28,617 | 0.9710 | 0.56% | 0.18% | 0.492 | 0.0631 | 20% |
| 21 | 181.53 | 0.35 | 29,948 | 0.9724 | 0.69% | 0.17% | 0.515 | 0.0715 | 21% |
| 22 | 190.23 | 0.38 | 31,384 | 0.9729 | 0.74% | 0.18% | 0.540 | 0.0726 | 19% |
| 23 | 198.37 | 0.41 | 32,726 | 0.9742 | 0.88% | 0.17% | 0.563 | 0.0743 | 18% |
| 24 | 206.67 | 0.45 | 34,095 | 0.9753 | 0.99% | 0.17% | 0.586 | 0.0784 | 18% |
| 25 | 216.49 | 0.49 | 35,716 | 0.9757 | 1.04% | 0.21% | 0.614 | 0.0846 | 17% |
| 26 | 238.13 | 0.59 | 39,286 | 0.9783 | 1.31% | 0.19% | 0.676 | 0.1078 | 18% |
| 27 | 379.21 | 1.48 | 62,561 | 0.9847 | 1.97% | 0.14% | 1.076 | 0.2334 | 16% |
| 28 | 516.78 | 2.69 | 85,257 | 0.9866 | 3.00% | 0.17% | 1.466 | 0.4319 | 16% |
| 29 | 656.03 | 4.30 | 108,231 | 0.9913 | 3.49% | 0.14% | 1.861 | 0.6925 | 16% |
| 30 | 816.76 | 6.63 | 134,747 | 0.9938 | 3.76% | 0.17% | 2.317 | 0.8888 | 13% |

Table 15. Data for Halmi Venturi Meter High Re

| | |
|---------------|--------------------------|
| Date | 1/3/2014 |
| Pipe Diameter | 11.95 in |
| Meter Bore | 7.1985 in |
| Beta ratio | 0.6024 |
| Temperature | 38 F° |
| Density | 1.941 lb/ft ³ |
| Gravity | 32.17 ft/s ² |

| Run No. | Flow | Meter Diff. | Re | C | Error and Uncertainty | | Vel. | Meter Loss | |
|---------|----------|----------------------------------|-----------|--------|-----------------------|----------|----------|----------------------------------|---------------------------|
| | Flow gpm | ΔH 1 in H ₂ O | Re Number | C | deviation % | Uncer. % | Vel. fps | ΔH 2 in H ₂ O | $\Delta H_2/\Delta H_1$ % |
| 1 | 402.63 | 1.69 | 66,580 | 0.9815 | -0.43% | 0.30% | 1.14 | 0.16 | 9% |
| 2 | 1098.60 | 12.44 | 181,669 | 0.9883 | 0.26% | 0.19% | 3.12 | 1.41 | 11% |
| 3 | 1780.92 | 32.66 | 294,499 | 0.9887 | 0.30% | 0.13% | 5.05 | 4.00 | 12% |
| 4 | 2461.07 | 62.34 | 406,972 | 0.9888 | 0.32% | 0.17% | 6.98 | 6.39 | 10% |
| 5 | 3169.27 | 103.91 | 524,082 | 0.9864 | 0.07% | 0.13% | 8.99 | 10.14 | 10% |
| 6 | 3864.52 | 155.00 | 639,052 | 0.9848 | -0.10% | 0.11% | 10.96 | 14.36 | 9% |
| 7 | 4523.83 | 212.34 | 748,077 | 0.9849 | -0.08% | 0.11% | 12.83 | 20.19 | 10% |
| 8 | 5228.43 | 283.75 | 864,593 | 0.9847 | -0.10% | 0.15% | 14.83 | 26.44 | 9% |
| 9 | 5896.36 | 361.25 | 975,044 | 0.9842 | -0.15% | 0.13% | 16.73 | 33.63 | 9% |
| 10 | 6617.50 | 454.38 | 1,094,295 | 0.9849 | -0.08% | 0.12% | 18.77 | 42.13 | 9% |

Table 16. Data for Halmi Venturi Meter Low Re

| | |
|---------------|--------------------------|
| Date | 1/3/2014 |
| Pipe Diameter | 11.95 in |
| Meter Bore | 7.1985 in |
| Beta ratio | 0.6024 |
| Temperature | 38.0 F° |
| Density | 1.941 lb/ft ³ |
| Gravity | 32.17 ft/s ² |

| Run No. | Flow | Meter Diff. | Re | C | Error and Uncertainty | | Vel. | Meter Loss | |
|---------|-------------|-------------------------------------|--------------|--------|-----------------------|----------|-------------|-------------------------------------|--------------------------------|
| | Flow gpm | $\Delta H 1$ in H ₂ O | Re Number | C | deviation % | Uncer. % | Vel. fps | $\Delta H 2$ in H ₂ O | $\Delta H 2 / \Delta H 1$ % |
| 1 | 26.80 | 0.01 | 4,431 | 0.8852 | -7.32% | 0.66% | 0.076 | 0.003 | 29% |
| 2 | 31.95 | 0.01 | 5,283 | 0.9186 | -3.82% | 0.77% | 0.091 | 0.004 | 29% |
| 3 | 37.89 | 0.02 | 6,265 | 0.9144 | -4.27% | 0.68% | 0.107 | 0.006 | 36% |
| 4 | 47.42 | 0.03 | 7,841 | 0.9230 | -3.37% | 0.54% | 0.135 | 0.006 | 23% |
| 5 | 54.84 | 0.04 | 9,069 | 0.9261 | -3.04% | 0.47% | 0.156 | 0.007 | 20% |
| 6 | 61.36 | 0.04 | 10,146 | 0.9329 | -2.33% | 0.42% | 0.174 | N/A | N/A |
| 7 | 76.87 | 0.07 | 12,711 | 0.9485 | -0.70% | 0.35% | 0.218 | N/A | N/A |
| 8 | 93.89 | 0.10 | 15,527 | 0.9544 | -0.07% | 0.29% | 0.266 | N/A | N/A |
| 9 | 100.74 | 0.11 | 16,658 | 0.9527 | -0.26% | 0.30% | 0.286 | 0.020 | 17% |
| 10 | 100.85 | 0.12 | 16,677 | 0.9499 | -0.55% | 0.31% | 0.286 | 0.020 | 17% |
| 11 | 109.23 | 0.13 | 18,062 | 0.9530 | -0.22% | 0.27% | 0.310 | 0.023 | 17% |
| 12 | 116.11 | 0.15 | 19,201 | 0.9549 | -0.02% | 0.27% | 0.329 | 0.025 | 17% |
| 13 | 127.29 | 0.18 | 21,050 | 0.9604 | 0.56% | 0.23% | 0.361 | 0.030 | 16% |
| 14 | 133.72 | 0.20 | 22,112 | 0.9608 | 0.60% | 0.23% | 0.379 | 0.033 | 16% |
| 15 | 141.93 | 0.22 | 23,471 | 0.9617 | 0.69% | 0.22% | 0.403 | 0.036 | 16% |
| 16 | 150.70 | 0.25 | 24,920 | 0.9616 | 0.67% | 0.19% | 0.427 | 0.040 | 16% |
| 17 | 158.84 | 0.28 | 26,266 | 0.9612 | 0.63% | 0.20% | 0.451 | 0.043 | 16% |
| 18 | 165.65 | 0.30 | 27,392 | 0.9638 | 0.90% | 0.20% | 0.470 | 0.046 | 15% |
| 19 | 173.04 | 0.33 | 28,615 | 0.9644 | 0.97% | 0.19% | 0.491 | 0.049 | 15% |
| 20 | 181.22 | 0.36 | 29,967 | 0.9639 | 0.92% | 0.18% | 0.514 | 0.053 | 15% |
| 21 | 189.77 | 0.40 | 31,381 | 0.9657 | 1.11% | 0.18% | 0.538 | 0.057 | 15% |
| 22 | 197.46 | 0.43 | 32,653 | 0.9656 | 1.09% | 0.17% | 0.560 | 0.061 | 14% |
| 23 | 205.36 | 0.46 | 33,959 | 0.9645 | 0.98% | 0.17% | 0.583 | 0.065 | 14% |
| 24 | 209.92 | 0.48 | 34,713 | 0.9666 | 1.20% | 0.21% | 0.596 | 0.067 | 14% |
| 25 | 233.29 | 0.59 | 38,578 | 0.9693 | 1.49% | 0.19% | 0.662 | 0.078 | 13% |
| 26 | 374.14 | 1.49 | 61,868 | 0.9795 | 2.55% | 0.14% | 1.061 | 0.206 | 14% |
| 27 | 485.17 | 2.47 | 80,229 | 0.9796 | 3.40% | 0.18% | 1.376 | 0.333 | 13% |
| 28 | 666.66 | 4.60 | 110,241 | 0.9861 | 4.08% | 0.13% | 1.891 | 0.596 | 13% |
| 29 | 798.87 | 6.60 | 132,104 | 0.9865 | 4.13% | 0.18% | 2.266 | 0.834 | 13% |

Table 17. Data for HBX Venturi Meter High Re

Date 1/3/2014
 Pipe Diameter 11.9495 in
 Meter Bore 7.1985 in
 Beta ratio 0.6024
 Temperature 45.9 F°
 Density 1.94 lb/ft³
 Gravity 32.17 ft/s²

| Run No. | Flow | Meter Diff. | Re | C | Error and Uncertainty | | Vel. | Meter Loss | |
|---------|----------|----------------------------------|-----------|--------|-----------------------|----------|----------|----------------------------------|-----------------------------|
| | Flow gpm | $\Delta H 1$ in H ₂ O | Re Number | C | deviation % | Uncer. % | Vel. fps | $\Delta H 2$ in H ₂ O | $\Delta H 2 / \Delta H 1$ % |
| 1 | 412.38 | 2.59 | 78,120 | 0.8133 | 0.00% | 0.20% | 1.17 | 0.92 | 36% |
| 2 | 413.41 | 2.60 | 78,315 | 0.8134 | 0.01% | 0.30% | 1.17 | 0.93 | 36% |
| 3 | 1090.81 | 18.08 | 206,639 | 0.8140 | 0.08% | 0.18% | 3.09 | 6.30 | 35% |
| 4 | 1791.89 | 48.83 | 339,449 | 0.8135 | 0.03% | 0.12% | 5.08 | 16.77 | 34% |
| 5 | 2480.74 | 93.44 | 469,944 | 0.8142 | 0.10% | 0.14% | 7.04 | 31.88 | 34% |
| 6 | 3153.78 | 150.94 | 597,442 | 0.8144 | 0.13% | 0.12% | 8.95 | 51.25 | 34% |
| 7 | 3844.79 | 224.22 | 728,345 | 0.8146 | 0.15% | 0.11% | 10.91 | 76.06 | 34% |
| 8 | 4514.95 | 310.00 | 855,298 | 0.8135 | 0.02% | 0.15% | 12.81 | 104.69 | 34% |
| 9 | 5218.91 | 414.38 | 988,653 | 0.8133 | 0.00% | 0.13% | 14.80 | 139.38 | 34% |
| 10 | 5930.78 | 532.50 | 1,123,506 | 0.8153 | 0.25% | 0.12% | 16.82 | 176.88 | 33% |
| 11 | 5937.25 | 536.25 | 1,124,732 | 0.8134 | 0.01% | 0.12% | 16.84 | 180.16 | 34% |
| 12 | 6588.71 | 656.25 | 1,248,144 | 0.8159 | 0.32% | 0.11% | 18.69 | 215.94 | 33% |
| 13 | 6593.75 | 656.88 | 1,249,097 | 0.8162 | 0.35% | 0.11% | 18.71 | 216.25 | 33% |

Table 18. Data for HBX Venturi Meter Low Re

Date 1/3/2014
 Pipe Diameter 11.9495 in
 Meter Bore 7.1985 in
 Beta ratio 0.6024
 Temperature 45.9 F°
 Density 1.94 lb/ft³
 Gravity 32.17 ft/s²

| Run No. | Flow | Meter Diff. | Re | C | Error and Uncertainty | | Vel. | Meter Loss | |
|---------|-------------|-------------------------------------|--------------|--------|-----------------------|----------|-------------|-------------------------------------|--------------------------------|
| | Flow gpm | $\Delta H 1$ in H ₂ O | Re Number | C | deviation % | Uncer. % | Vel. fps | $\Delta H 2$ in H ₂ O | $\Delta H 2 / \Delta H 1$ % |
| 1 | 19.99 | 0.007 | 3,614 | 0.7678 | -5.39% | 0.86% | 0.06 | 0.005 | 68% |
| 2 | 21.42 | 0.008 | 3,872 | 0.7847 | -3.31% | 0.84% | 0.06 | N/A | N/A |
| 3 | 24.08 | 0.009 | 4,352 | 0.8008 | -1.32% | 0.80% | 0.07 | N/A | N/A |
| 4 | 25.70 | 0.010 | 4,645 | 0.8145 | 0.37% | 0.77% | 0.07 | N/A | N/A |
| 5 | 30.45 | 0.014 | 5,503 | 0.8159 | 0.54% | 0.76% | 0.09 | 0.008 | 55% |
| 6 | 33.96 | 0.018 | 6,138 | 0.8168 | 0.65% | 0.69% | 0.10 | N/A | N/A |
| 7 | 38.56 | 0.023 | 6,968 | 0.8131 | 0.20% | 0.62% | 0.11 | N/A | N/A |
| 8 | 42.22 | 0.028 | 7,631 | 0.8143 | 0.35% | 0.57% | 0.12 | N/A | N/A |
| 9 | 50.99 | 0.040 | 9,216 | 0.8117 | 0.02% | 0.50% | 0.14 | N/A | N/A |
| 10 | 57.88 | 0.052 | 10,460 | 0.8142 | 0.33% | 0.44% | 0.16 | N/A | N/A |
| 11 | 58.27 | 0.053 | 10,531 | 0.8120 | 0.06% | 0.42% | 0.17 | 0.022 | 42% |
| 12 | 66.48 | 0.068 | 12,014 | 0.8161 | 0.57% | 0.38% | 0.19 | 0.027 | 40% |
| 13 | 73.60 | 0.084 | 13,301 | 0.8134 | 0.23% | 0.34% | 0.21 | 0.032 | 38% |
| 14 | 80.08 | 0.099 | 14,473 | 0.8151 | 0.44% | 0.37% | 0.23 | 0.038 | 38% |
| 15 | 89.46 | 0.123 | 16,168 | 0.8154 | 0.48% | 0.32% | 0.25 | 0.047 | 38% |
| 16 | 96.36 | 0.143 | 17,415 | 0.8138 | 0.28% | 0.29% | 0.27 | 0.052 | 37% |
| 17 | 104.63 | 0.169 | 18,910 | 0.8139 | 0.30% | 0.28% | 0.30 | 0.063 | 37% |
| 18 | 112.32 | 0.195 | 20,299 | 0.8142 | 0.33% | 0.26% | 0.32 | 0.070 | 36% |
| 19 | 120.95 | 0.226 | 21,859 | 0.8138 | 0.29% | 0.24% | 0.34 | 0.087 | 38% |
| 20 | 127.45 | 0.251 | 23,032 | 0.8132 | 0.21% | 0.23% | 0.36 | 0.095 | 38% |
| 21 | 134.76 | 0.280 | 24,354 | 0.8141 | 0.32% | 0.23% | 0.38 | 0.108 | 38% |
| 22 | 144.73 | 0.323 | 26,155 | 0.8151 | 0.44% | 0.21% | 0.41 | 0.122 | 38% |
| 23 | 149.40 | 0.343 | 27,000 | 0.8154 | 0.48% | 0.21% | 0.42 | 0.130 | 38% |
| 24 | 157.47 | 0.383 | 28,459 | 0.8140 | 0.31% | 0.20% | 0.45 | 0.146 | 38% |
| 25 | 163.33 | 0.413 | 29,518 | 0.8134 | 0.23% | 0.17% | 0.46 | 0.155 | 38% |
| 26 | 172.25 | 0.458 | 31,130 | 0.8140 | 0.30% | 0.19% | 0.49 | 0.172 | 37% |
| 27 | 181.36 | 0.508 | 32,777 | 0.8142 | 0.34% | 0.22% | 0.51 | 0.188 | 37% |
| 28 | 189.44 | 0.553 | 34,236 | 0.8151 | 0.45% | 0.21% | 0.54 | 0.204 | 37% |
| 29 | 193.40 | 0.579 | 34,952 | 0.8131 | 0.20% | 0.20% | 0.55 | 0.213 | 37% |
| 30 | 203.34 | 0.636 | 36,748 | 0.8153 | 0.47% | 0.19% | 0.58 | 0.234 | 37% |
| 31 | 226.10 | 0.790 | 40,862 | 0.8136 | 0.26% | 0.17% | 0.64 | 0.289 | 37% |
| 32 | 354.29 | 1.944 | 64,029 | 0.8128 | 0.16% | 0.22% | 1.01 | 0.716 | 37% |
| 33 | 480.51 | 3.575 | 86,838 | 0.8128 | 0.16% | 0.15% | 1.36 | 1.313 | 37% |
| 34 | 608.30 | 5.719 | 109,933 | 0.8136 | 0.25% | 0.13% | 1.73 | 2.097 | 37% |

Table 19. Data for Magnetic Meter High Re

| | |
|---------------|--------------------------|
| Date | 9/18/2013 |
| Pipe Diameter | 12.00 in |
| Meter Bore | N/A in |
| Beta ratio | N/A |
| Temperature | 56 F° |
| Density | 1.939 lb/ft ³ |
| Gravity | 32.17 ft/s ² |

| Run No. | Actual Flow | Ind. Flow | Re | C | Error and Uncertainty | | Vel. | Meter Loss | |
|---------|-------------|-----------|-----------|--------|-----------------------|----------|----------|----------------------------------|-----------------------------|
| | Flow gpm | Flow gpm | Re Number | C | deviation % | Uncer. % | Vel. fps | $\Delta H 2$ in H ₂ O | $\Delta H 2 / \Delta H 1$ % |
| 1 | 399.00 | 402.72 | 88,264 | 0.9908 | -0.31% | 0.28% | 1.13 | 0.0491 | N/A |
| 2 | 400.77 | 404.32 | 88,655 | 0.9912 | -0.27% | 0.27% | 1.14 | N/A | N/A |
| 3 | 1077.00 | 1082.93 | 238,245 | 0.9945 | 0.07% | 0.12% | 3.06 | 0.2750 | N/A |
| 4 | 1761.90 | 1775.20 | 389,754 | 0.9925 | -0.14% | 0.09% | 5.00 | 0.6913 | N/A |
| 5 | 2432.42 | 2447.20 | 538,079 | 0.9940 | 0.01% | 0.08% | 6.90 | 1.2625 | N/A |
| 6 | 3119.49 | 3137.60 | 690,066 | 0.9942 | 0.04% | 0.07% | 8.85 | 2.0125 | N/A |
| 7 | 3796.48 | 3818.40 | 839,824 | 0.9943 | 0.04% | 0.07% | 10.77 | 2.9563 | N/A |
| 8 | 4477.78 | 4500.80 | 990,537 | 0.9949 | 0.10% | 0.07% | 12.70 | 4.0938 | N/A |
| 9 | 5139.67 | 5172.80 | 1,136,953 | 0.9936 | -0.03% | 0.07% | 14.58 | 5.2813 | N/A |
| 10 | 5834.65 | 5856.80 | 1,290,690 | 0.9962 | 0.24% | 0.07% | 16.55 | 6.7813 | N/A |
| 11 | 6535.38 | 6559.20 | 1,445,701 | 0.9964 | 0.25% | 0.07% | 18.54 | 8.4875 | N/A |

Table 20. Data for Magnetic Meter Low Re

Date 9/13/2013
 Pipe Diameter 12.00 in
 Meter Bore N/A in
 Beta ratio N/A
 Temperature 43.1 F°
 Density 1.94 lb/ft³
 Gravity 32.17 ft/s²

| Run No. | Actual Flow | Ind. Flow | Re | C | Error and Uncertainty | | Vel. | Meter Loss | |
|---------|-------------|-----------|-----------|--------|-----------------------|----------|----------|---------------------|-----------------------------|
| | Flow gpm | Flow gpm | Re Number | C | deviation % | Uncer. % | Vel. fps | $\Delta H 2$ in H2O | $\Delta H 2 / \Delta H 1$ % |
| 1 | 34.39 | 35.38 | 7,517 | 0.9720 | -1.37% | 0.78% | 0.10 | N/A | N/A |
| 2 | 38.11 | 39.31 | 8,330 | 0.9695 | -1.62% | 0.76% | 0.11 | 0.0011 | N/A |
| 3 | 44.30 | 45.63 | 9,682 | 0.9709 | -1.49% | 0.68% | 0.13 | 0.0022 | N/A |
| 4 | 51.35 | 53.12 | 11,223 | 0.9667 | -1.91% | 0.59% | 0.15 | 0.0022 | N/A |
| 5 | 57.66 | 58.88 | 12,601 | 0.9793 | -0.64% | 0.45% | 0.16 | 0.0027 | N/A |
| 6 | 63.83 | 64.80 | 13,949 | 0.9850 | -0.06% | 0.40% | 0.18 | 0.0030 | N/A |
| 7 | 72.36 | 73.42 | 15,814 | 0.9855 | 0.00% | 0.42% | 0.21 | 0.0047 | N/A |
| 8 | 78.76 | 79.78 | 17,214 | 0.9872 | 0.17% | 0.37% | 0.22 | 0.0053 | N/A |
| 9 | 83.99 | 84.81 | 18,357 | 0.9904 | 0.49% | 0.34% | 0.24 | 0.0053 | N/A |
| 10 | 89.83 | 90.74 | 19,632 | 0.9899 | 0.45% | 0.32% | 0.25 | 0.0056 | N/A |
| 11 | 94.55 | 95.40 | 20,664 | 0.9911 | 0.57% | 0.30% | 0.27 | 0.0059 | N/A |
| 12 | 120.53 | 121.27 | 26,342 | 0.9939 | 0.85% | 0.29% | 0.34 | 0.0094 | N/A |
| 13 | 146.76 | 148.04 | 32,074 | 0.9913 | 0.59% | 0.23% | 0.42 | 0.0103 | N/A |
| 14 | 169.93 | 171.44 | 37,139 | 0.9912 | 0.57% | 0.20% | 0.48 | 0.0128 | N/A |
| 15 | 281.81 | 283.60 | 61,590 | 0.9937 | 0.83% | 0.17% | 0.80 | 0.0280 | N/A |
| 16 | 391.60 | 394.56 | 85,586 | 0.9925 | 0.71% | 0.12% | 1.11 | 0.0472 | N/A |
| 17 | 497.46 | 500.08 | 108,720 | 0.9948 | 0.94% | 0.11% | 1.41 | 0.0706 | N/A |
| 18 | 605.88 | 609.12 | 132,417 | 0.9947 | 0.93% | 0.10% | 1.72 | 0.0975 | N/A |

Table 21. Data for Ultrasonic Meter High Re

| | |
|---------------|-------------------------|
| Date | 9/26/2013 |
| Pipe Diameter | 12.00 in |
| Meter Bore | N/A in |
| Beta ratio | N/A |
| Temperature | 49.5 F° |
| Density | 1.94 lb/ft ³ |
| Gravity | 32.17 ft/s ² |

| Run No. | Actual Flow | Ind. Flow | Re | C | Error and Uncertainty | | Vel. | Meter Loss | |
|---------|-------------|-----------|-----------|--------|-----------------------|----------|----------|---------------------|-----------------------------|
| | Flow gpm | Flow gpm | Re Number | C | deviation % | Uncer. % | Vel. fps | $\Delta H 2$ in H2O | $\Delta H 2 / \Delta H 1$ % |
| 1 | 411.72 | 400.13 | 82,335 | 1.0290 | 1.46% | 1.10% | 1.17 | 0.0702 | N/A |
| 2 | 1086.65 | 1068.38 | 217,308 | 1.0171 | 0.29% | 0.42% | 3.08 | 0.3313 | N/A |
| 3 | 1767.69 | 1744.88 | 353,503 | 1.0131 | -0.11% | 0.27% | 5.01 | 0.8288 | N/A |
| 4 | 2445.86 | 2417.25 | 489,123 | 1.0118 | -0.23% | 0.20% | 6.94 | 1.5063 | N/A |
| 5 | 3129.06 | 3085.50 | 625,749 | 1.0141 | -0.01% | 0.16% | 8.88 | 2.3250 | N/A |
| 6 | 3808.66 | 3766.13 | 761,657 | 1.0113 | -0.29% | 0.14% | 10.80 | 3.3938 | N/A |
| 7 | 4502.65 | 4446.75 | 900,441 | 1.0126 | -0.16% | 0.12% | 12.77 | 4.7313 | N/A |
| 8 | 5172.90 | 5119.13 | 1,034,478 | 1.0105 | -0.37% | 0.11% | 14.67 | 6.2125 | N/A |
| 9 | 5858.26 | 5791.50 | 1,171,536 | 1.0115 | -0.26% | 0.10% | 16.62 | 7.9875 | N/A |
| 10 | 6535.71 | 6463.88 | 1,307,012 | 1.0111 | -0.31% | 0.10% | 18.54 | 9.8906 | N/A |

Table 22. Data for Ultrasonic Meter Low Re

Date 10/4/2013
 Pipe Diameter 12.00 in
 Meter Bore N/A in
 Beta ratio N/A
 Temperature 47.1 F°
 Density 1.94 lb/ft³
 Gravity 32.17 ft/s²

| Run No. | Actual Flow | Ind. Flow | Re | C | Error and Uncertainty | | Vel. | Meter Loss | |
|---------|-------------|-----------|-----------|--------|-----------------------|----------|----------|----------------------------------|---------------------------|
| | Flow gpm | Flow gpm | Re Number | C | deviation % | Uncer. % | Vel. fps | ΔH_2 in H ₂ O | $\Delta H_2/\Delta H_1$ % |
| 1 | 31.58 | 30.50 | 6,074 | 1.0353 | 2.64% | 1.44% | 0.09 | 0.0031 | N/A |
| 2 | 36.99 | 36.60 | 7,116 | 1.0107 | 0.20% | 1.29% | 0.10 | 0.0031 | N/A |
| 3 | 41.91 | 41.18 | 8,062 | 1.0178 | 0.91% | 1.15% | 0.12 | 0.0036 | N/A |
| 4 | 48.71 | 48.80 | 9,370 | 0.9981 | -1.05% | 0.97% | 0.14 | 0.0038 | N/A |
| 5 | 53.54 | 53.76 | 10,299 | 0.9959 | -1.27% | 0.88% | 0.15 | 0.0034 | N/A |
| 6 | 59.56 | 59.48 | 11,458 | 1.0015 | -0.71% | 0.79% | 0.17 | 0.0038 | N/A |
| 7 | 65.89 | 65.58 | 12,674 | 1.0047 | -0.39% | 0.72% | 0.19 | 0.0039 | N/A |
| 8 | 73.06 | 72.44 | 14,054 | 1.0086 | -0.01% | 0.66% | 0.21 | 0.0045 | N/A |
| 9 | 79.07 | 78.16 | 15,210 | 1.0116 | 0.29% | 0.61% | 0.22 | 0.0044 | N/A |
| 10 | 86.56 | 85.40 | 16,651 | 1.0136 | 0.48% | 0.56% | 0.25 | 0.0047 | N/A |
| 11 | 92.54 | 91.88 | 17,801 | 1.0071 | -0.15% | 0.52% | 0.26 | 0.0053 | N/A |
| 12 | 93.48 | 92.64 | 17,983 | 1.0090 | 0.04% | 0.52% | 0.27 | N/A | N/A |
| 13 | 97.52 | 96.46 | 18,759 | 1.0110 | 0.23% | 0.49% | 0.28 | 0.0061 | N/A |
| 14 | 102.83 | 101.03 | 19,781 | 1.0178 | 0.91% | 0.47% | 0.29 | 0.0067 | N/A |
| 15 | 107.24 | 106.75 | 20,629 | 1.0046 | -0.41% | 0.45% | 0.30 | 0.0066 | N/A |
| 16 | 114.05 | 113.61 | 21,940 | 1.0039 | -0.47% | 0.42% | 0.32 | 0.0072 | N/A |
| 17 | 119.93 | 118.95 | 23,071 | 1.0082 | -0.04% | 0.40% | 0.34 | N/A | N/A |
| 18 | 121.53 | 122.00 | 23,379 | 0.9962 | -1.24% | 0.40% | 0.34 | 0.0070 | N/A |
| 19 | 127.58 | 126.58 | 24,542 | 1.0079 | -0.07% | 0.38% | 0.36 | 0.0077 | N/A |
| 20 | 130.65 | 129.24 | 25,133 | 1.0109 | 0.22% | 0.37% | 0.37 | 0.0081 | N/A |
| 21 | 140.77 | 140.30 | 27,080 | 1.0034 | -0.52% | 0.34% | 0.40 | 0.0089 | N/A |
| 22 | 148.70 | 147.54 | 28,605 | 1.0078 | -0.08% | 0.33% | 0.42 | 0.0091 | N/A |
| 23 | 152.91 | 150.59 | 29,415 | 1.0154 | 0.67% | 0.32% | 0.43 | 0.0095 | N/A |
| 24 | 159.27 | 157.46 | 30,639 | 1.0115 | 0.28% | 0.31% | 0.45 | 0.0100 | N/A |
| 25 | 165.82 | 164.70 | 31,897 | 1.0068 | -0.19% | 0.30% | 0.47 | 0.0113 | N/A |
| 26 | 181.21 | 181.48 | 34,859 | 0.9985 | -1.00% | 0.27% | 0.51 | 0.0119 | N/A |
| 27 | 280.44 | 279.84 | 53,948 | 1.0022 | -0.65% | 0.19% | 0.80 | 0.0141 | N/A |
| 28 | 387.98 | 384.30 | 74,634 | 1.0096 | 0.09% | 0.15% | 1.10 | 0.0303 | N/A |
| 29 | 499.28 | 491.43 | 96,045 | 1.0160 | 0.72% | 0.12% | 1.42 | 0.0781 | N/A |
| 30 | 613.49 | 605.04 | 118,016 | 1.0140 | 0.53% | 0.12% | 1.74 | 0.1067 | N/A |