

SSC01-VIIIb-2

Nihon University CubeSat Program

Yasuyuki Miyazaki*, Hiroshi Isobe **, Tsuyoshi Kodama **,
Michiharu Uchiki **, and Shunsuke Hinuma**

Department of Aerospace Engineering, College of Science and Technology,
Nihon University, JAPAN

* : lecturer, ** : graduate student

7-24-1 Narashinodai, Funabashi, Chiba 274-8501, JAPAN

phone : 81-47-469-5430

e-mail : miyazaki@forth.aero.cst.nihon-u.ac.jp

Abstract

The CubeSat program is now proceeding in Japan and U.S. academic institutions and radio groups. CubeSat is a 10cm cubed, 1kg weighted micro-satellite. The first launch of CubeSats is scheduled in May 2002. The second launch will be realized in autumn 2002 or later. Subsequent launch is also planned. Nihon University is going to join the second launch. Our program consists of two phases. At the first phase, we are developing a CubeSat for the second launch opportunity. The purpose of the first phase is that the students learn the whole process of the micro satellite development and operation. At the second phase, we intend to challenge some engineering mission. We have been studying on a mission of deploying an inflatable structure model. In this paper we show the latest status of the first phase of our program , and the plan for the second phase.

Introduction

The CubeSat program is now proceeding in Japan and U.S. academic institutions and radio groups. CubeSat is a 10cm cubed, 1kg weighted micro-satellite. The first launch of CubeSats is scheduled in May 2002. The second launch is scheduled in autumn 2002 or later. The CubeSats are going to be launched by Russian DNEPR rocket, and deployed into the space from the carrier named P-POD developed by California Polytechnic State University. Now two universities in Japan are developing CubeSats for the first launch, i.e. University of Tokyo and Tokyo Institute of Technology. We, Nihon University team members are developing a CubeSat for the second launch opportunity.

There are few chances in Japan that students take part in the space development with the national institutions or companies. And the practical education of space engineering is one of the important problems for the universities in Japan. Therefore the CubeSat project is one of the best opportunities for the education of space engineering, and is the first challenge for Japanese college students to develop the satellite by their hands.

In this paper, we present the latest status of the development of the CubeSat, and show the future plan of the CubeSat mission.

Scenarios of our program

At present, the students in Nihon University have no experience of developing micro satellites. They have

just experienced the development of can-sized satellite model (Cansat) for the ground experiment (Figure 1).

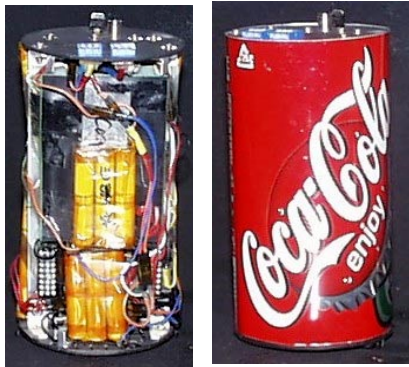

Figure 1. Cansat inside and outside view

Through the development and the operation of the Cansats, they have learned

- importance of the management of the ,
- difficulties in the development of a reliable system in the limited period ,
- fun of completing the project.

However, it is still a quite hard task for them to achieve the real micro satellite mission. So, our program consists of the following two phases. The students will get the experience of space development through these two phases.

At the first phase of the program, the students will develop the CubeSat for the second launch planned in autumn 2002 or later. The students will do the design, manufacture, tests, ground operations, and the managements, so that they will learn the whole process of the micro satellite mission. The purpose of this phase is just the education of micro satellite technology to the students. We will achieve our purpose if the students get the ability to develop the micro satellite which works well in space, and to operate the micro satellites.

At the second phase, the students will develop CubeSats for the launch in several years later. They will carry out some engineering mission that will be concerned with the topics they will research in their laboratories. We will achieve our purpose if the students get the good research result through the CubeSat mission.

In the following sections, we show the outline of these two phases

The First Phase

The requirements for the CubeSats are as follows.

- The weight is less than 1kg.
- The structure is made of A7075.
- The CubeSat has 10cm-cubed shape, and has four columns at its each edge.
- Three CubeSats are packed in series into the P-POD, and deployed from the P-POD by some spring mechanism on orbit. Figure 2 illustrates the deployment.
- The power is turned off at the launch time, and on after the CubeSat is deployed from the P-POD.

The CubeSat is so small that the requirement for the electric power generation is critical, and the mission is restricted to those of low power consumption (The total electric power generation by the solar panels is less than 1.5W).

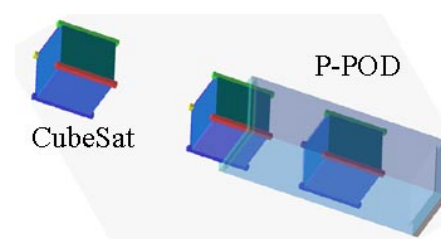

Figure2. Deployment of the CubeSats from P-POD

As mentioned above, the objectives of our first

CubeSat mission is to confirm that the CubeSat works well on orbit. The mission is as follows.

- the tracking of the CubeSat by amateur radio ground station.
- the control of the downlink schedule by the uplink data to the ground station.
- the transmitting of the telemetry command.
- attitude estimation of the CubeSat by using thermal sensors and a geomagnetic sensor.

Thus the mission is very simple and basic, but this is our first challenge of the micro satellite mission, and we believe this experience will lead the second phase, i.e. more advanced mission.

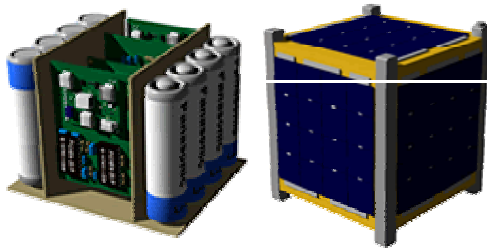

Figure 3. CubeSat inside and outside view images

Figure 3 illustrates our CubeSat at the present design. The solar panels are attached on each outside surface. Kill switches are located at the top of the columns. The lithium-ion batteries are located in two lines at both sides, and the circuit board and the sensors are located between the batteries. Figure 4 shows the system block diagram of the CubeSat. The electric power saving system including the monitoring of the battery charge is installed because the amount of the power generation by the solar cell is small.

Table 1 shows the characteristics of the onboard equipment that are already selected. The current development status of our CubeSat is as follows; (1) A 50mm x 50mm x 12mm (or larger) sized small transmitter and the receiver is now under development with JRC (Japan Radio Corporation). Its

design is already finished, and the manufacturing will start as soon as the frequency will be assigned for our CubeSat. (2) OBC and the sensor system is designed and partially tested, (3) the function test including the environmental test is scheduled from the summer 2001, (4) the communication test is scheduled in winter 2001-2002, (5) the power subsystem using silicon solar cell and lithium ion battery is under design. The PDR of our CubeSat is scheduled in autumn 2001 at our college.

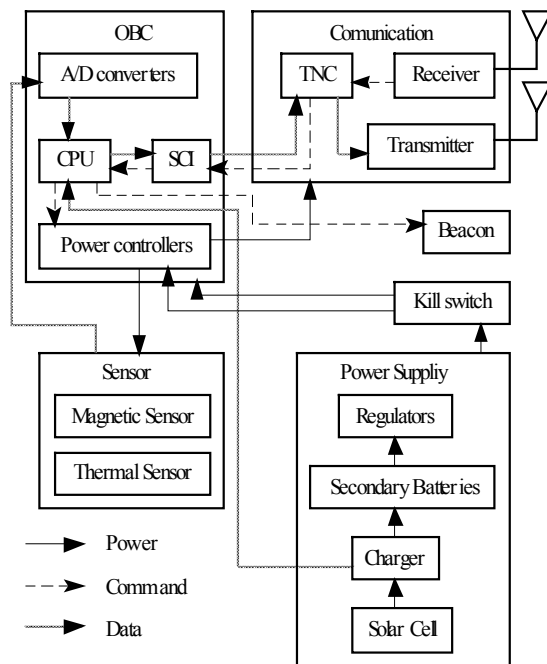

Figure 4. System Block

Table 1. Onboard Equipment

CPU	PIC16F877 (Microchip)
Transceiver	Power: 300mW
Thermal sensor	Range: -40 ~ +400C
	Resolution: 0.15C
Magnetic sensor	Range: ±6gauss
	Resolution: 85μgauss
Li-ion Battery	Nominal Voltage 3.7V
	Typical Capacity 1.8Ah
Silicon solar cell	Efficiency: 16.5%

We are unskilled in the micro satellite design so that many modifications may be necessary. We would like to refine the design taking account of the results of the first launch.

The second phase

We intend to challenge some engineering mission at the second phase after we will learn the development method of the CubeSat at the first phase. Our laboratory has been studying on the dynamics of deployable space structures, and we are under the feasibility study on the deployment experiment of inflatable structures for the future CubeSat mission.

There has been a lot of attention recently on the subject of space inflatable structures.¹ Inflatable structures consist of flexible tubes, membranes and so on. Almost of them are made of flexible thin films (e.g. Polymer, Kapton, teflon). Inflatable structure inflates by injected gas pressure, and deploys to specific shapes. It obtains stiffness by injected gas pressure. As space is micro gravity environment, it can get enough stiffness. Some of the most important characteristics of inflatable structures are followings; (1) they have very light weight compared with rigid ones. (2) Inflatable structures can be folded in a small volume. (3) Inflatable structures can product for less money than mechanical system. (4) It is possible to produce inflatable structures to various shapes including curved surface. (5) Deployment method of inflatable structures is very simple. Thus inflatable structures in many important ways are the ideal deployable structure for use in space. However, there are several problems remained unsolved, i.e. (1) rigidization method on orbit, (2) avoidance of the gas leak under vacuum environment, (3) estimation of the deployment motion under vacuum and micro-gravity environment, and so on. As for third problem, it is very difficult to perform the experiment on ground because it is not easy to simulate the micro-gravity environment and the vacuum environment simultaneously. Therefore, it is important to get the experimental data on orbit.

The CubeSat is so mall that the mission may be as simple as possible. Deployment mechanism of inflatable structures is quite simple. It is just to inject the gas into the bag-like membrane. So we think this mission will have sufficient feasibility if we will develop a small valve of the gas tank that functions under high vacuum environment with low electric power.

The purpose of the mission is to observe the deployment motion of an inflatable structure and measure the change of the internal pressure, and to compare them with numerical results. As the inflatable structure, we are under consideration on the following three types; (1) one long tube crushed to small volume before the launch, (2) zigzag shaped tube (Figure 5), and (3) thin membrane supported by four tubes that are connected at the center of the membrane (Figure 6). Figure 5 and 6 illustrates the deployment motion under micro-gravity and vacuum environment that is calculated by using nonlinear finite element method.² We would like to compare such numerical results with experimental results on orbit.

We have already performed micro-gravity experiments using the drop-shaft type facilities JAMIC (Japan Micro Gravity Center). Figure 7 shows the photograph of the tube shape during the gas injection. The corresponding numerical results are also shown below the photograph. Figure 8 shows the transition of the lateral coordinate of the top of the tube, and Figure 9 shows the longitudinal coordinates. Both the experimental and numerical data are shown in these figures. These results show the validity of the numerical analysis. However, this experiment is performed in atmosphere. The aerodynamic drag acts on the membrane on the ground and it disturb the

motion of the membrane. On the other hand, there is little disturbance in space. So the result may differ from that in space. In fact, it is reported that the dynamic behavior of membrane in space is different from that on the ground.



Figure 5. Zigzag shaped tube

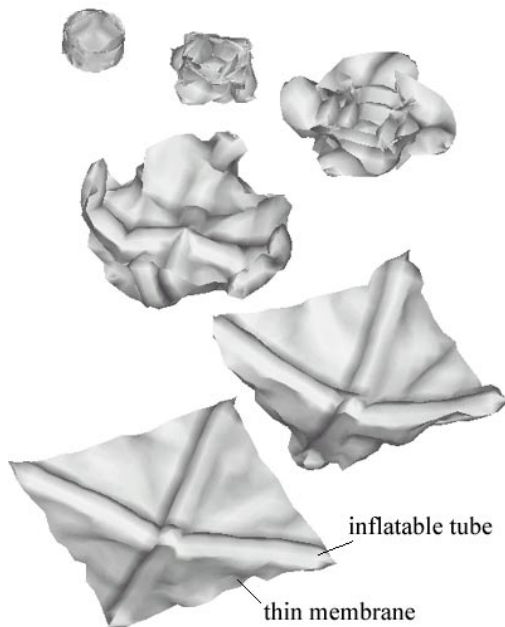

Figure 6. Membrane supported by four tubes

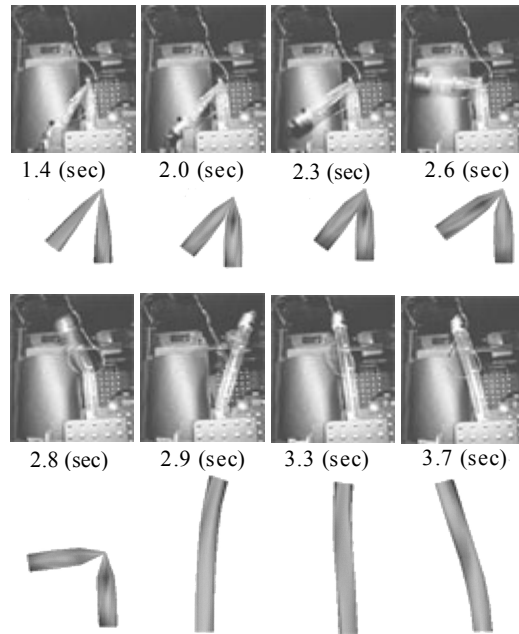

Figure 7. Deployment of a tube under micro-gravity

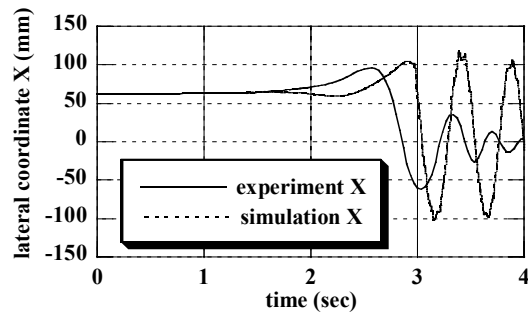

Figure 8. Tip coordinate (lateral direction)

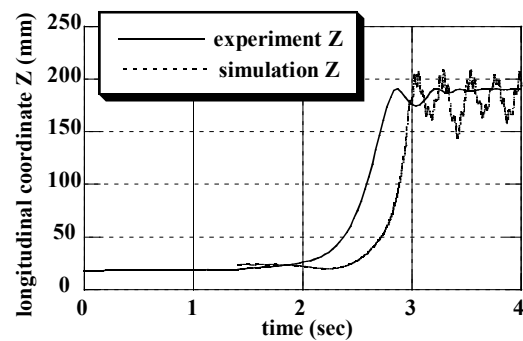

Figure 9. Tip coordinate (longitudinal direction)

Concluding remarks

It is a tough task for the students to develop a reliable micro satellite with given weight, size, and shape by their hands. But they are enjoying this challenge. The CubeSat project is one of the best programs to educate the process of the space development to the students. For the students who study on space engineering, it is a great pleasure to estimate their research through the space experiment.

Off course it is very interesting subject not only for the students but also for the college staff to propose significant mission under the severe requirements for the CubeSat. We hope that there increase the opportunities that the students develop satellites by their hand in Japan with the CubeSat project as a start.

Acknowledgement

We thank Prof. Twiggs (Stanford University) for giving us the chance to joint the CubeSat project,. We also thank Prof. Nakasuka (University of Tokyo), Prof. Matunaga (Tokyo Institute of Technology), and their students for giving us valuable suggestion and information on the development of micro satellite.

This work is supported in part by the grant of the Promotion and Mutual Aid Corporation for Private Schools in Japan.

References

1. Michael C. Rou, "Development and Application of Space Inflatable Structures", Proceedings of the 22nd International Symposium on Space Technology and Science, Morioka, Japan, June 2000. [for a proceedings paper]
2. T. Mizuno, Y. Miyazaki, and Y. Nakamura, "Deployment Analysis of Inflatable Tube", Proceedings of the 22nd International Symposium on Space Technology and Science,

Morioka, Japan, June 2000. [for a proceedings paper]