

Utah State University

DigitalCommons@USU

---

Aspen Bibliography

Aspen Research

---

1972

## Computer Simulation of Douglas-Fir Tree and Stand Growth

James D. Arney

Follow this and additional works at: [https://digitalcommons.usu.edu/aspen\\_bib](https://digitalcommons.usu.edu/aspen_bib)



Part of the [Forest Sciences Commons](#)

---

### Recommended Citation

Arney, James D. Computer simulation of Douglas-fir tree and stand growth. 1972. Pacific Forest Research Centre, Canadian Forestry Service, Internal Report BC-27. Victoria, British Columbia

This Thesis/Dissertation is brought to you for free and open access by the Aspen Research at DigitalCommons@USU. It has been accepted for inclusion in Aspen Bibliography by an authorized administrator of DigitalCommons@USU. For more information, please contact [digitalcommons@usu.edu](mailto:digitalcommons@usu.edu).



COMPUTER SIMULATION OF DOULGAS-FIR TREE AND STAND GROWTH

A Thesis submitted to  
Oregon State University  
for the degree of  
Doctor of Philosophy

by

James D. Arney

Work on this thesis was done while the author was  
Instructor, School of Forestry at Oregon State University

PACIFIC FOREST RESEARCH CENTRE  
CANADIAN FORESTRY SERVICE  
VICTORIA, BRITISH COLUMBIA

INTERNAL REPORT BC-27

DEPARTMENT OF THE ENVIRONMENT

JANUARY, 1972

## A C K N O W L E D G E M E N T S

The author would like to express his appreciation to the many persons who gave assistance during the course of this study. He is indebted to his major professor, Dr. David Paine, for assistance and review of the manuscript. He would also like to thank Mr. Dave Bruce and Dr. Robert Curtis for their critical reviews. Appreciation is expressed to Dr. John Bell, Dr. Robert Strand, Dr. Jim Lin, and Dr. John Beuter for their encouragement and support throughout this study and to the Canadian Forestry Service for assisting in final preparation and review of the manuscript. Data supplied by Mr. Alan Berg, Dr. Don Reukema, and Dr. Robert Strand are also gratefully acknowledged.

The financial assistance was supplied for all computer related expenses by the OSU Computer Center. Without this assistance the study could not have been completed.

## TABLE OF CONTENTS

	Page No.
I. Introduction . . . . .	1
Objectives of the Study . . . . .	2
Background . . . . .	3
Previous Stand Model Development . . . . .	6
II. Evaluation of Assumptions and Components . . . . .	8
Site . . . . .	8
Height . . . . .	9
Stem Diameter . . . . .	11
Crown Widths . . . . .	13
Intertree Competition . . . . .	16
Tolerance Limits . . . . .	21
III. Building the Model . . . . .	24
General Approach . . . . .	24
Specific Model Design . . . . .	28
Reducing Height Growth by Suppression . . . . .	28
Suppressing Diameter Increment . . . . .	30
Suppressing Crown Increment . . . . .	31
Mortality . . . . .	35
Volume Growth Response . . . . .	36
IV. Results . . . . .	38
Individual Tree Simulator . . . . .	38
Stand Simulator . . . . .	44
V. Discussion . . . . .	61
Limitations . . . . .	62
Applications . . . . .	63
VI. Summary and Conclusions . . . . .	66
Bibliography . . . . .	68
Appendices	
I. Crown Area Overlap . . . . .	70
II. Sampling for an Index of Tolerance . . . . .	72
III. Flow Chart of Program . . . . .	75
IV. Comparison of CCF to Competition Quotient (Gerrard) . . . . .	79

LIST OF TABLES

<u>Table</u>		<u>Page</u>
1	Distribution of sample trees for open-grown crown diameter and stem diameter by site index and age.	11
2	Data from average tree simulation, age 60 years, site 135 (King).	45
3	Description of sample plots.	47

## LIST OF FIGURES

<u>Figure</u>		<u>Page</u>
1	Height as a function of age and site.	10
2	Diameter outside bark as a function of length to tip and age for open-grown trees.	14
3	Relationship between crown width and DBH for open-grown Douglas-fir.	15
4	Crown Competition Quotient between trees.	18
5	Crown Competition Quotient at each whorl in stand-grown trees.	19
6	Crown Competition Factor as a function of crown width and number of trees per acre.	20
7	CCQ as an index of tolerance as affected by total height.	23
8	Height reduction rates for suppressed trees.	29
9	DOB increment reduction as a function of CCQ.	32
10	Crown increment reduction for suppressed whorls.	34
11	Simulated stem profile at 60 years showing 5 year increments from average tree simulation of 40 trees per acre.	39
12	Simulated stem profile at 60 years showing 5 year increments. Initially 681 trees per acre.	40
13	Simulated stem profile at 60 years showing 5 year increments. Initially 681 trees per acre, thinned at 20 years.	41
14	Simulated stem profile at 60 years showing 5 year increments. Initially 681 trees per acre, thinned at 20 and 40 years.	42
15	Plot A. - Hoskins control plot	48

<u>Figure</u>		<u>Page</u>
16	Plot B. - Hoskins thinning plot	49
17	Plot C. - Hoskins thinning plot	50
18	Plot D. - Clackamas control plot	52
19	Plot E. - Black Rock control plot	54
20	Plot F. - Wind River 8 x 8 foot spacing	55
21	Plot G. - Wind River 12 x 12 foot spacing	57
22	Plot F. - Wind River 8 x 8 foot spacing	59
23	Plot A. - Hoskins control plot	60

# COMPUTER SIMULATION OF DOUGLAS-FIR TREE AND STAND GROWTH

## INTRODUCTION

As demand on the Douglas-fir resource becomes more intense and diversified, foresters are striving to maximize growth and yield for each acre of commercial forest land. Maximum yield requires that each stand be maintained at some near optimum growing condition throughout its rotation. To find and maintain these levels, more specific information is needed about growth characteristics of individual trees at various levels of competition, spacing, site and age. Long-term field studies now in progress will eventually give us the information needed; but even if a field study had been started 20 years ago, it will be many more years before the end results are known. More disappointing is the realization that the particular treatments applied in these long-term studies may not result in finding the optimum growth and yield possible for the site and age of the stand. Because of this problem, foresters are applying an array of treatments in hope of finding the optimum conditions they desire.

With the advent of the computer, the forester has been able to consider alternative methods of predicting optimum management schedules for growth and yield of forest stands. Through computer simulation techniques it is possible to duplicate the functions of growth documented in literature from past and present field studies. The forester can then make inferences about the results of any number of years of growth under the constraints imposed. As is readily apparent, many more alternatives may be attempted and refined management schedules may be introduced as predicted growth is observed, and appropriate adjustments can be made in the simulator.



### Objectives of the Study

This study attempts to go beyond the development of traditional yield tables which directly predict net growth in board or cubic feet. Instead, the development of each component of volume growth (height growth, diameter growth, crown growth, mortality, and stems per acre) is predicted, based on previous conditions and treatments which may have altered the final component values. Volume increases are predicted at later stages from these primary components. The object is to build a model in which the effect of the history of development of each component may be evaluated in terms of stand-volume and growth-distribution among trees and portions of trees.

The objectives of this study were to quantify basic components of tree and stand growth, to develop models of these components whereby the combined responses may be used to predict volume growth, and to provide a basis for predicting stand-volume growth response from one period to another, taking into consideration stand condition and treatment for previous periods.

These objectives may be reached through quantitative representation of height, crown diameter and stem diameter increments combined in a working individual tree model. This model will predict annual height increments and annual crown and stem increments down the entire bole of a simulated tree as a function of present tree size and an index of surrounding competition. All trees in a simulated stand will grow three dimensionally, with the same tree model as a computer program subroutine for their individual development. The burden of stand dynamics is placed on the development of individual trees; an objective hitherto unattempted in most stand simulators.

### Background

Tree boles taper toward the tip of the tree, but the rate of decrease in diameter with increase in height above ground may be variable because of varying thickness of the annual sheath of new wood. Although the controlling physiological processes are not fully known, Farrar (1961) and Larson (1963) have concluded that the variation is correlated with crown size and crown position on the bole. Trees with long vigorous crowns produce strongly tapering stems with a rather high proportion of earlywood to latewood. As the crown recedes, from stand closure or artificial pruning, the stem becomes more cylindrical and the proportion of earlywood to latewood decreases. Lateral branches nearest the top of the tree are the most vigorous and contribute the greatest quantity of auxin to the main stem. In the lower-most branches of stand-grown trees, the cambial stimulus fails to reach the branch base or it may be visibly expressed only in the form of latewood. Stem analyses have shown that the maximum radial growth occurs in the general vicinity of live crown base (Duff and Nolan, 1953; Reukema, 1961). Therefore, the maximum ring width may be found low on the bole of long-crowned trees and a gradual upward shift parallels crown recession. Within an individual tree the increment of the lower bole is relatively less stable and reflects seasonal changes in weather and environment far more readily than the bole of the active crown. Three general cases of stem form in the branch-free bole have been recognized (Larson, 1963):

- 1) Trees with strongly developed crowns, such as those growing free or in small openings in the stand, show a

downward increase in both area increment and radial increment.

- 2) Stand-grown trees with side development hindered, but not overtopped, show approximately equal area growth but decreasing radial growth downward.
- 3) Stand-grown trees overtopped and with small crowns relative to their bole length show a downward decrease in both measurements.

Stem form is a composite reflection of both stand density and crown class. These factors control stem form so consistently that the degree of taper can be regulated by stand management. However, quantitative expression of stand density in an accurate, useful fashion has long puzzled forest mensurationists. Total basal area per acre has been the most popular index of stand density, with many modifications of basal area, average diameter, and numbers of trees per acre tried over the years. Similarity of many of these measures has been discussed by Curtis (1970). In the development of individual tree models, an index of density or competition around a tree is essential. The most obvious approach has been to quantify some area around the tree as a function of the relative size of the competing tree and then describe the encroachment of surrounding trees into this area as a competition index.

Krajicek (1961) introduced a crown competition measure which he called Crown Competition Factor (CCF). Based on measurements of diameter outside bark (DOB) at breast height (DBH) throughout a stand, CCF is the sum of predicted open-grown crown areas, accumulated for

all stem diameters and divided by 435.6. This yields a continuous index of stocking and crowding from an open-grown tree condition ( $CCF \leq 100$ ) to a dense stagnated stand ( $CCF = 350 - 500$ ). Hypothetically, an acre fully stocked with open-growing trees and crowns just touching would have an index equal to 100.

Gerrard (1967) independently developed an individual tree competition index for white oak which he called Competition Quotient. He tried various ratios of competing areas to stem diameter in an attempt to predict response of diameter growth to release by thinning. His lack of success was most likely due to the small potential for response the 300-year-old stand was capable of achieving. The competing area, equal to the open-grown crown of trees, appeared to be a reasonable base from which to work. Bella (1969) developed an index based on open-grown crown width similar to Gerrard's, with the exception that a weighting factor was applied to the size of the competitor's crown area.

Opie (1968) developed a competing basal area index for predicting growth of Eucalyptus in Australia, which he called the zone count method. He tested various basal area factors (BAF's). The field method for zone count does not seem to be as useful because additional competition estimates are made at a distance from the subject tree which brings in unrelated competitors.

Most of the above-mentioned competition indexes are based on a competitive area around the subject tree related to the area of the open-grown crown for the particular stem diameter. An index of competition, as applied above, is the accumulated area overlap of all competitor areas of neighboring trees expressed as a percentage of the

subject tree competing area. Independence of this index from age and site index has contributed to its popularity for growth prediction. Gerrard stated that area overlap is a better predictor of periodic increment than Spurr's point density (1962), Staebler's linear overlap (1951), or Newnham's percent of circumference overlap (1966).

#### Previous Stand Model Developments

A number of successful stand models have been produced (Clutter, 1963; Newnham, 1964; Lee, 1967; Leary, 1968; Myers, 1968). Of particular interest are stand models that incorporate measures of competition for each tree (Lin, 1969; Mitchell, 1969; Bella, 1970). Lin selected one tree in each quadrant around the subject tree that made the largest angle of incidence with the subject tree. A value was assigned to each of these four competitors, dependent on its size and distance from the subject tree. Growing Space Index (GSI) was the summation of the values. Diameter growth at breast height was then predicted as a function of GSI, change in GSI, age, site index and present diameter breast height.

Mitchell simulated the irregular crown expansion across a horizontal plane for each tree in a stand at five-year intervals. This allowed neighboring trees to compete individually for available growing space. Diameter breast height could then be predicted as a function of crown width, age and site index for dominant and codominant trees.

From estimated open-grown crown areas of competing trees, as if they were open-grown, Bella accumulated the crown-area overlap with the subject tree. Each competitor was weighted by relative size. Tree basal area and diameter breast height were then predicted as a function of Competitive Influence-zone Overlap (CIO), which is the summation of

the weighted crown-area overlap ratios for each competitor.

As discussed by Lee, these models do not lend themselves to statistical tests of precision. The most frequently used approach has been one of comparing estimated values, such as volume over all ages simulated against a record of volume measurements on field plots. Plotted residuals of actual minus simulated values were used to observe consistency and accuracy of the model over time. Mitchell's study is an example of this for trees per acre, crown width, crown length and bole diameter. The definitions of success as used above refers to this type of residual analysis. Stand models predict values that yield a horizontal band of homogeneous variance of residuals of various growth parameters over the range of years simulated. A horizontal band of residuals indicates no abnormality in the model. More confidence can be assigned as the band becomes narrower through refined models. Mitchell was able to reduce this band for crown width to within three percent of actual values.

## EVALUATION OF ASSUMPTIONS AND COMPONENTS

Each component of the model used in this study is based on carefully chosen field measurements or accurate and complete presentations from available literature. A determined effort was made to ensure that each component of the model was biologically sound in relationship to the others and uniquely descriptive of some growth or death factor acting on individual trees.

### Site

A primary feature of a growth model is some index of the productivity potential for a given combination of available nutrients, light, water and temperature. The most appropriate present index is the observed height growth of dominant or codominant trees of similar species for a given period of years.

This index of site quality not only varies among measured trees in a stand, but also can vary among stand densities (Reukema, 1970). Tree-site index variation is a combination of spatial distribution, time of establishment, variation in soil nutrient availability, and genetic height-growth differences. The total heights at the end of a given period of years in a stand are far from equal. If height growth is uniform among trees, the stand often stagnates and few dominants are found.

In a stand model, individual tree expression of site quality should be distributed around a mean similar to that found in nature.

### Height

A very useful and precise predicting equation for the height growth of Douglas-fir was prepared by King (1966). Height at any age is predicted by using an index of site obtained from an average of the ten largest DBH trees from a sample of 50 (Figure 1.). It incorporates three simple linear equations to yield coefficients for height at any age given an index of site. The equations are:

$$B_1 = -0.954038 + 0.109757 \left[ 2500 / (\text{site} - 4.5) \right]$$

$$B_2 = 0.0558178 + 0.00792236 \left[ 2500 / (\text{site} - 4.5) \right]$$

$$B_3 = -0.000733819 + 0.000197693 \left[ 2500 / (\text{site} - 4.5) \right]$$

The predicting equation for height from age takes the form:

$$H = \frac{(\text{Age})^2}{B_1 + B_2 (\text{Age}) + B_3 (\text{Age})^2} + 4.5$$

This equation predicts total height for 20 percent of young-growth Douglas-fir of largest DBH with a standard error of approximately four feet at 50 years for a site II. The first difference of this formula with respect to age is used in the model to predict annual height increment. It has the following form:

$$\Delta H = \frac{(\text{Age})^2}{B_1 + B_2 (\text{Age}) + B_3 (\text{Age})^2} - \frac{(\text{Age}-1)^2}{B_1 + B_2 (\text{Age}-1) + B_3 (\text{Age}-1)^2}$$

This allows a given tree to grow in height for a given age even though, as a result of other factors, the total height may be somewhat different for the accrued age. Figure 1 illustrates the sigmoid form of the height curves.



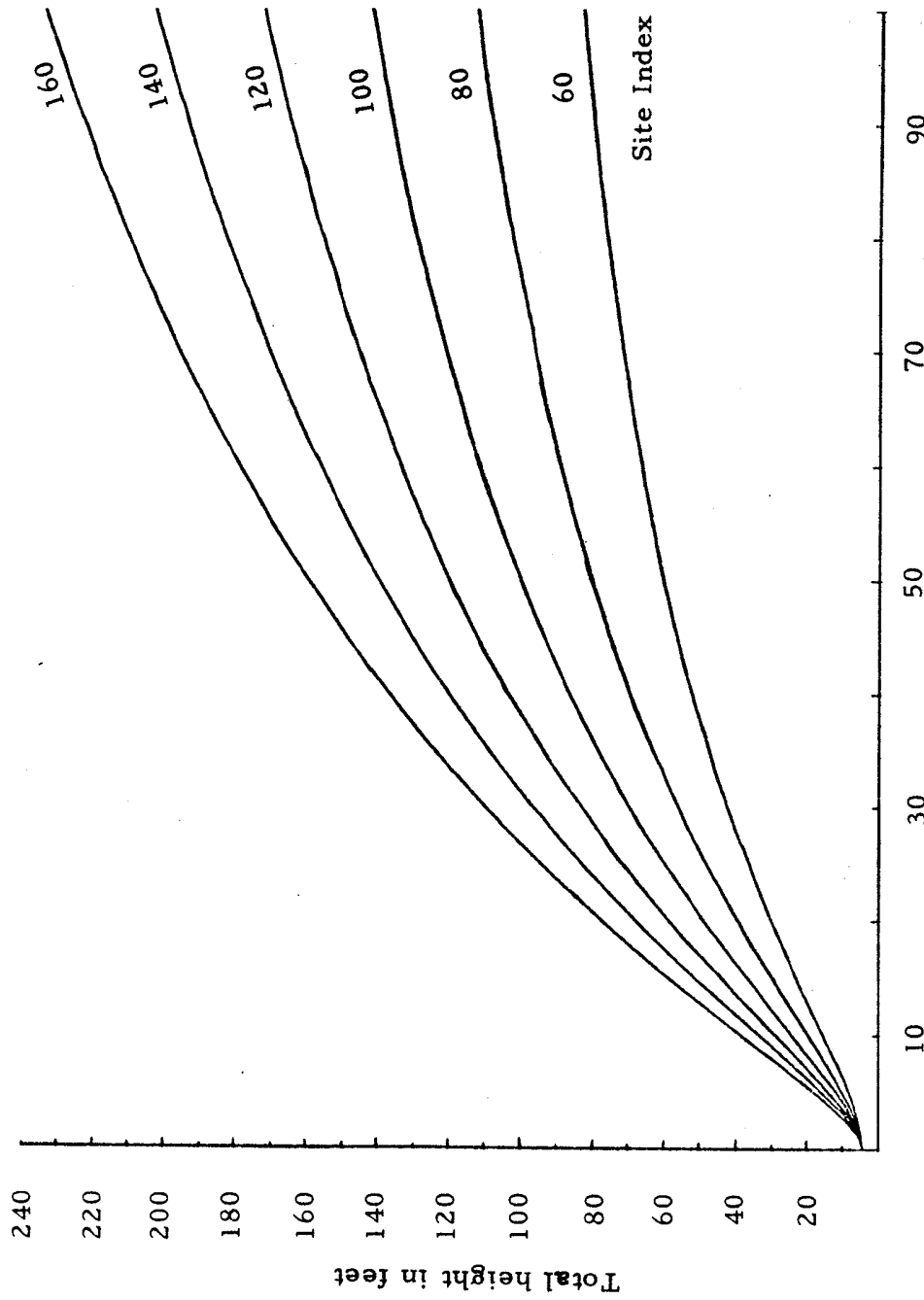

Figure 1. Height as a function of age and site. (from King, 1966)

Stem Diameter

Since no comprehensive analysis of diameter growth at all points on the stem is available in the literature an independent study was carried out expanding on recent work by Paine <sup>1/</sup>. Crown width, stem diameter at breast height, age and total height had been recorded on 173 open-grown trees in western Oregon. The data were collected over sites and ages described in Table 1.

Table 1. Distribution of sample trees for open-grown crown diameter and stem diameter by site index and age at breast height.

Age	Site Class					Total
	I	II	III	IV	V	
1 - 10	6	3	14	6	16	45
11 - 20	4	15	30	23	7	78
21 - 30	2	3	17	7	2	32
31 - 40	1	2	7	4	2	16
41 - 50			1	1		2
Total	<u>13</u>	<u>23</u>	<u>69</u>	<u>41</u>	<u>27</u>	<u>173</u>

A preliminary regression model was fitted by the method of least squares. The form of the equation for prediction of diameter outside bark (DOB) at DBH on open-grown trees is:

$$\text{DOB} = -1.2996 + 0.1963 (\text{Age}_D) + 0.2800 (L)$$

where  $\text{Age}_D$  = stem age at DOB measurement point

L = length in feet from tip of tree to DOB measurement point

This equation has a 2.3-inch standard deviation and 0.956 multiple

---

<sup>1/</sup> Paine, David P. 1968-1971. Personal contact and joint effort in part of analysis.

correlation coefficient for 173 observations. It is not defined for less than two years' breast height age or less than four-foot stem length.

Sixty-four additional measurements of diameter outside bark, made at higher points in open-grown trees were plotted over estimates from the above equation. These upper-stem measurements demonstrate the validity of the first hypothesis used in this model, that in open-grown Douglas-fir, DOB at any height is a function of length above and age at the DOB measurement point. Points plotted less than 45-foot stem length from tree tip represent measurements taken from points 2 to 17 years old. The remaining nine points ranged in age at height of measurement from 22 to 38 years. For this initial study the comparison plots were in generally dense, young stands where the majority of the upper stem measurements were made on whorls less than 20 years of age. More data should be gathered on open-grown trees to confirm this basis.

To predict diameter increment in the tree model, the first difference of the above equation was applied. The  $\Delta \text{Age}_D$  will always be unity as long as the tree model makes annual increments. It may, therefore, be handled as a constant. The revised increment equation becomes:

$$\Delta \text{DOB} = 0.1963 + 0.2800 (\Delta L)$$

where  $\Delta \text{DOB}$  = annual increment in DOB

$\Delta L$  = current annual increment in stem length

This equation was used to predict diameter increments at all ages of live whorls after the first year. Diameter growth the first year was arbitrarily set at 0.16 inches. Figure 2 serves to demonstrate the validity of the hypothesis used in this model that DOB is a function of length and age at any whorl in open-grown Douglas-fir.

#### Crown Widths

The next step, after predicting DOB for open-grown trees, was a prediction equation for open-grown crown width. Based on data originally collected by Paine, an equation was fitted for predicting open-grown crown width independent of site index or tree age. Measurements of crown width were taken at the point of maximum natural spread of the crown. This point was near or slightly below breast height for all but the smallest trees. Small trees, just over 4.5 feet, had maximum crown widths within 2 feet of ground level. Two measurements, taken at right angles, were averaged for a single entry of crown width for each tree. A tree may possibly have zero diameter at breast height and over four feet of measured crown width at the widest point of the crown. The equation for predicting open-grown crown width (CW) is:

$$CW = 4.5685 + 2.0360 (DOB) - 0.0191 (DOB)^2$$

This equation has a standard deviation of 2.6 feet and a multiple correlation coefficient of .97. The regression and observations are plotted in Figure 3.

An assumption about the growth of open-grown trees was made in order to apply the above equation to crown width at any point along their stems. The assumption is that open-grown crown width is a function of stem DOB alone. In the presence of DOB, it is not dependent

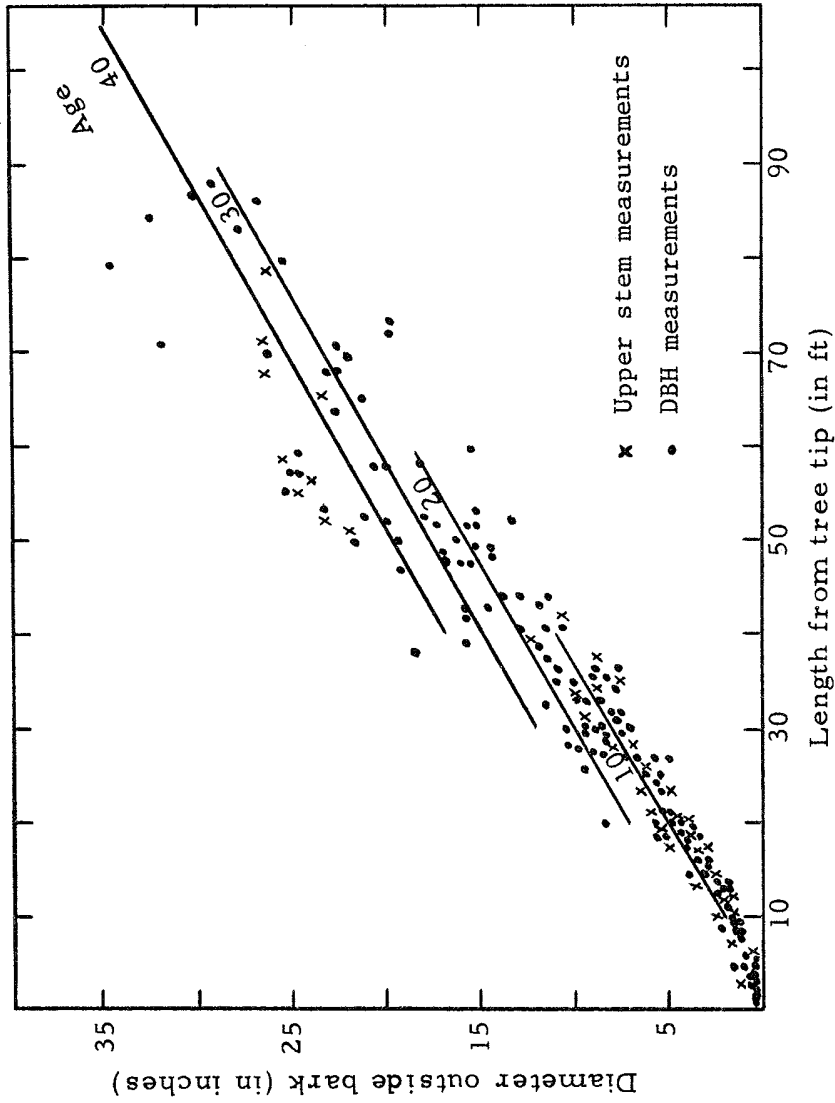

Figure 2. Diameter outside bark as a function of length to tip and age for open-grown trees.

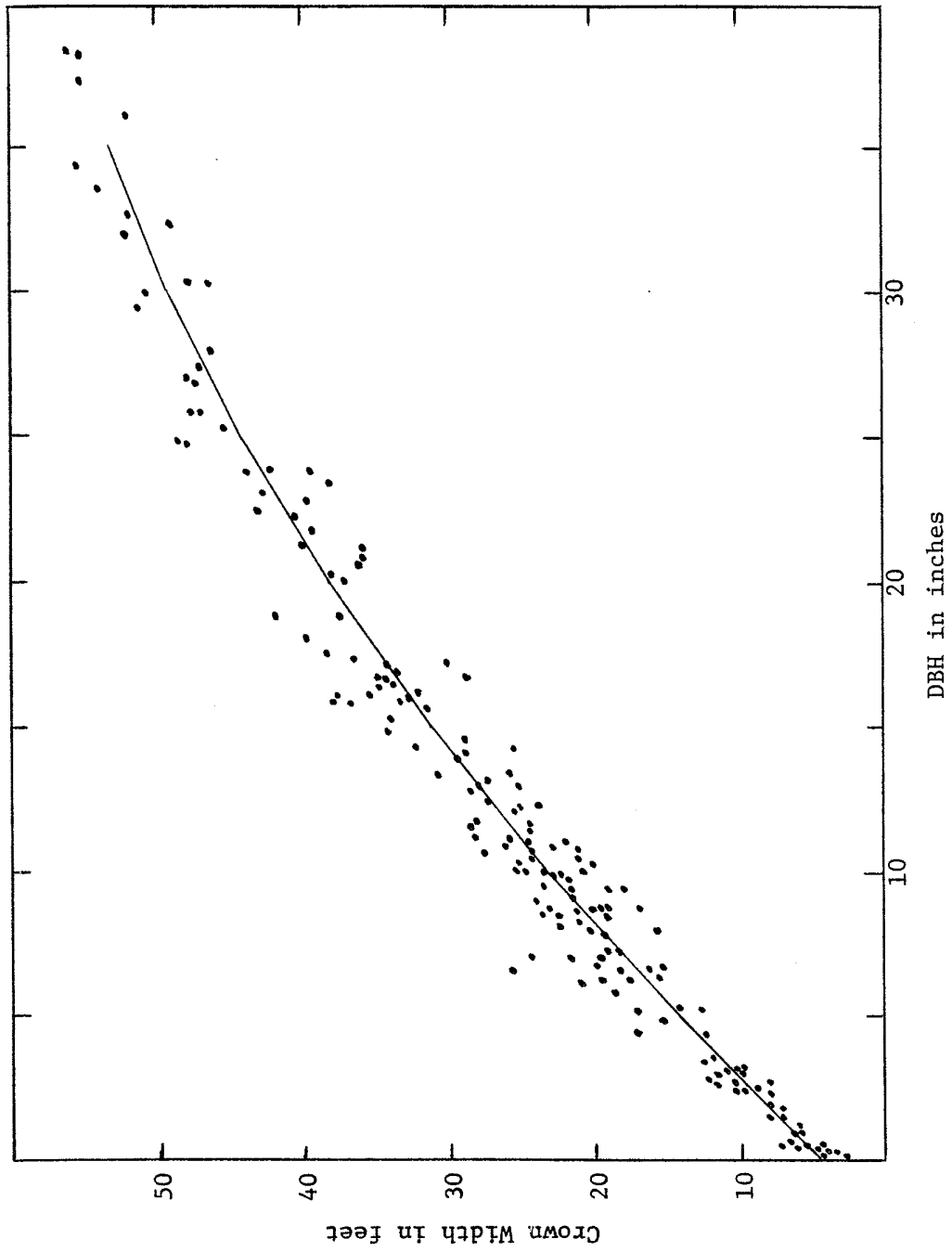

Figure 3. Relationship between Crown Width and DBH for open-grown Douglas-fir.

on height above ground, total age of the tree, or index of site quality. This assumption is based on results of a stepwise multiple linear regression of CW on DOB, age at DOB, total length to tip of trees from DOB, an index of site for each tree, and various transformations of each. Only DOB and  $(DOB)^2$  were selected as variables which contributed significantly to reducing the variance about the mean crown width. Age and height would have reduced the variance significantly in the absence of DOB and  $(DOB)^2$ .

The first difference of the above equation was used to predict crown increment for various DOB's on open-grown trees. Crown growth at DBH the first year was arbitrarily set at 2 feet. Increments of open-grown crown width for subsequent years were estimated from:

$$\Delta CW = 2.036 (\Delta DOB) - .0191 \left[ (DOB_i)^2 - (DOB_{i-1})^2 \right]$$

#### Intertree Competition

Crown Competition Factor (Krajicek et al., 1961), appears to be an adequate index of competition for generally uniform, even-aged stands. It is not dependent on age or site and is biologically meaningful in its interpretation (Dahms, 1966; Vezina, 1963).

$$CCF = \frac{100 \sum_{j=1}^n A_j}{43560 B}$$

where  $A_j$  = assumed open-grown square foot crown areas of  $j^{\text{th}}$  tree of specified DBH  
 $= \frac{\pi (CW)^2}{4}$

B = number of acres in the sample

Gerrard's Competition Quotient (CQ) is similar to CCF, except that it is defined for individual trees and the area ratio is not based on open-grown widths (Appendix IV). To apply an index of competition to each whorl in a tree, a new index based on CCF and CQ was developed. Competition between whorls is expressed as:

$$CCQ = \frac{100 (\sum a_i + A)}{A}$$

where

CCQ = Crown Competition Quotient (Figure 4)

$a_i$  = area in square feet of open-grown crown overlap with the  $i$ th competitor whorl

A = estimated open-grown crown area of subject tree

Crown Competition Quotient yields index values similar to CCF. An index equal to 100 describes a whorl on a tree in which no other tree has a crown overlap with that whorl. Proceeding downward whorl by whorl from the top of a tree, a point is eventually reached where crowns just touch. By definition in this model, intertree competition begins at this point. The index increases as the horizontal plane, where the index is applied, descends to DBH (Figure 5). Derivation of equations for determining crown-area overlap is shown in Appendix I. Figure 6 helps to visualize the effect of crown-width increment for a given number of trees per acre on the change in CCQ index on an acre basis (CCF). In uniform stands with over 600 stems per acre, a small increment crown width produces a significant rise in the competition index. Such a description demonstrates the importance of mortality, allocating more growing space to residual trees.

When calculating CCQ for different whorls up the tree, the



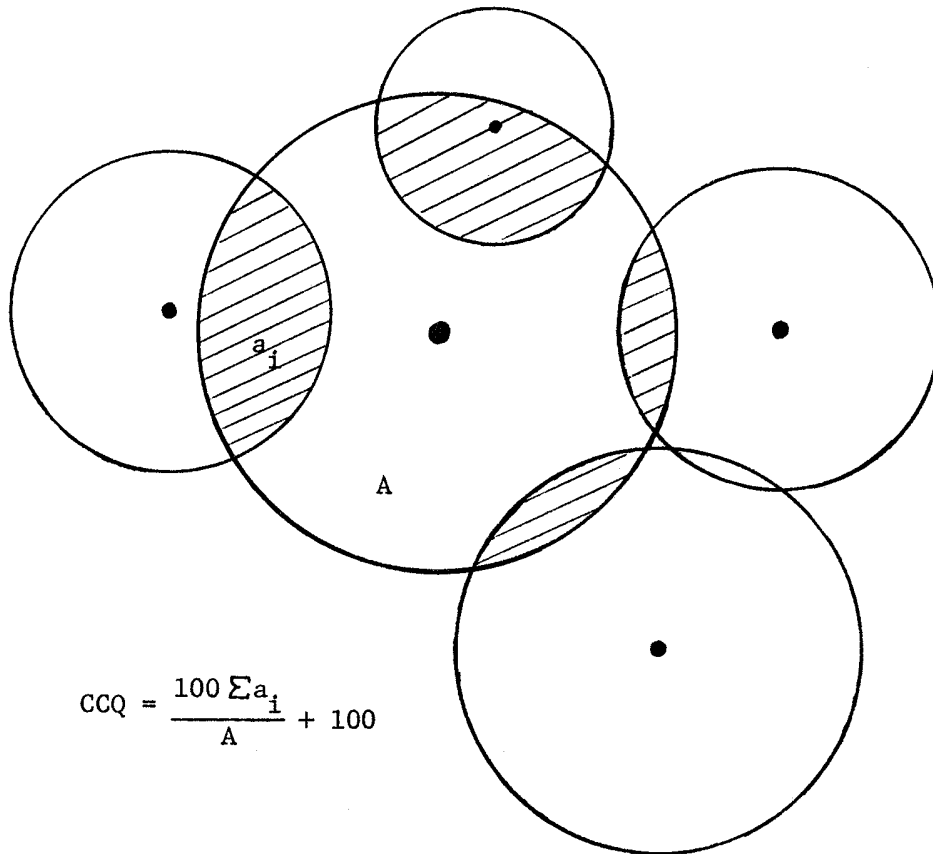

Figure 4. Crown Competition Quotient between trees.

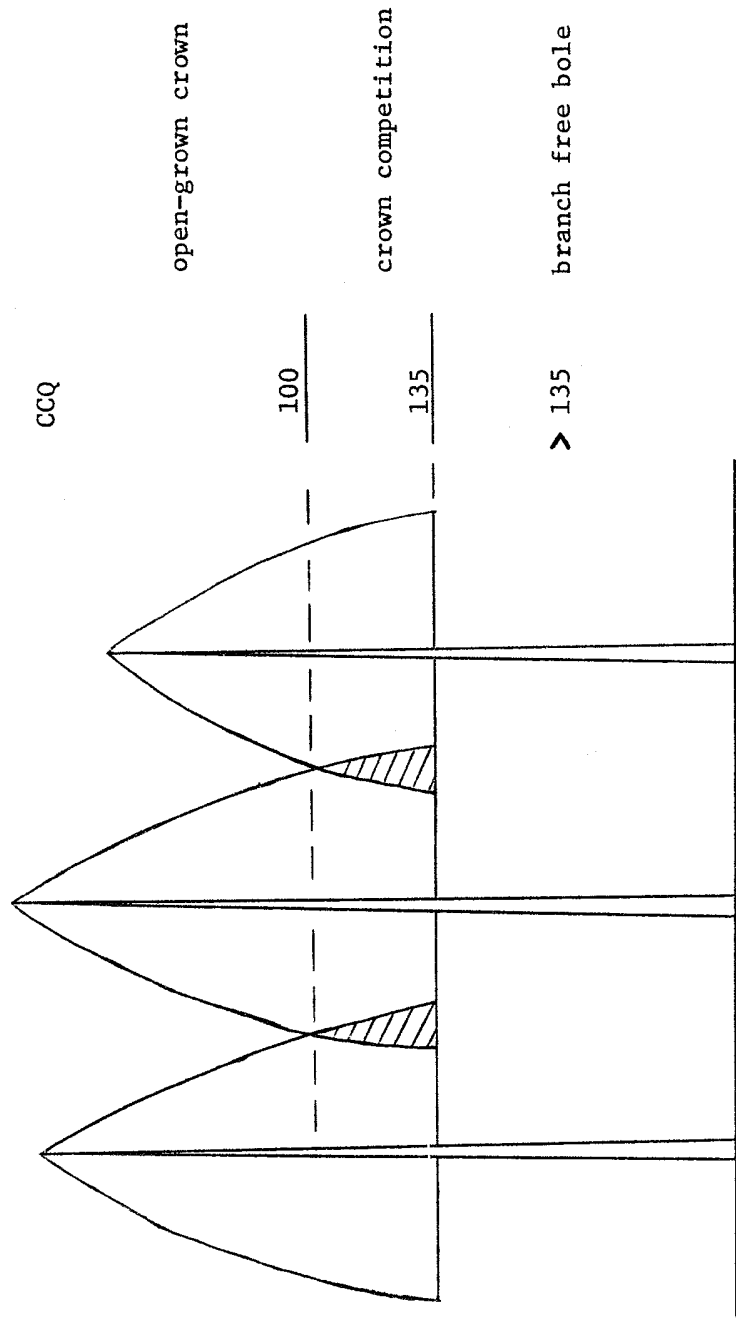

Figure 5. Crown Competition Quotient at each whorl in stand-grown trees.

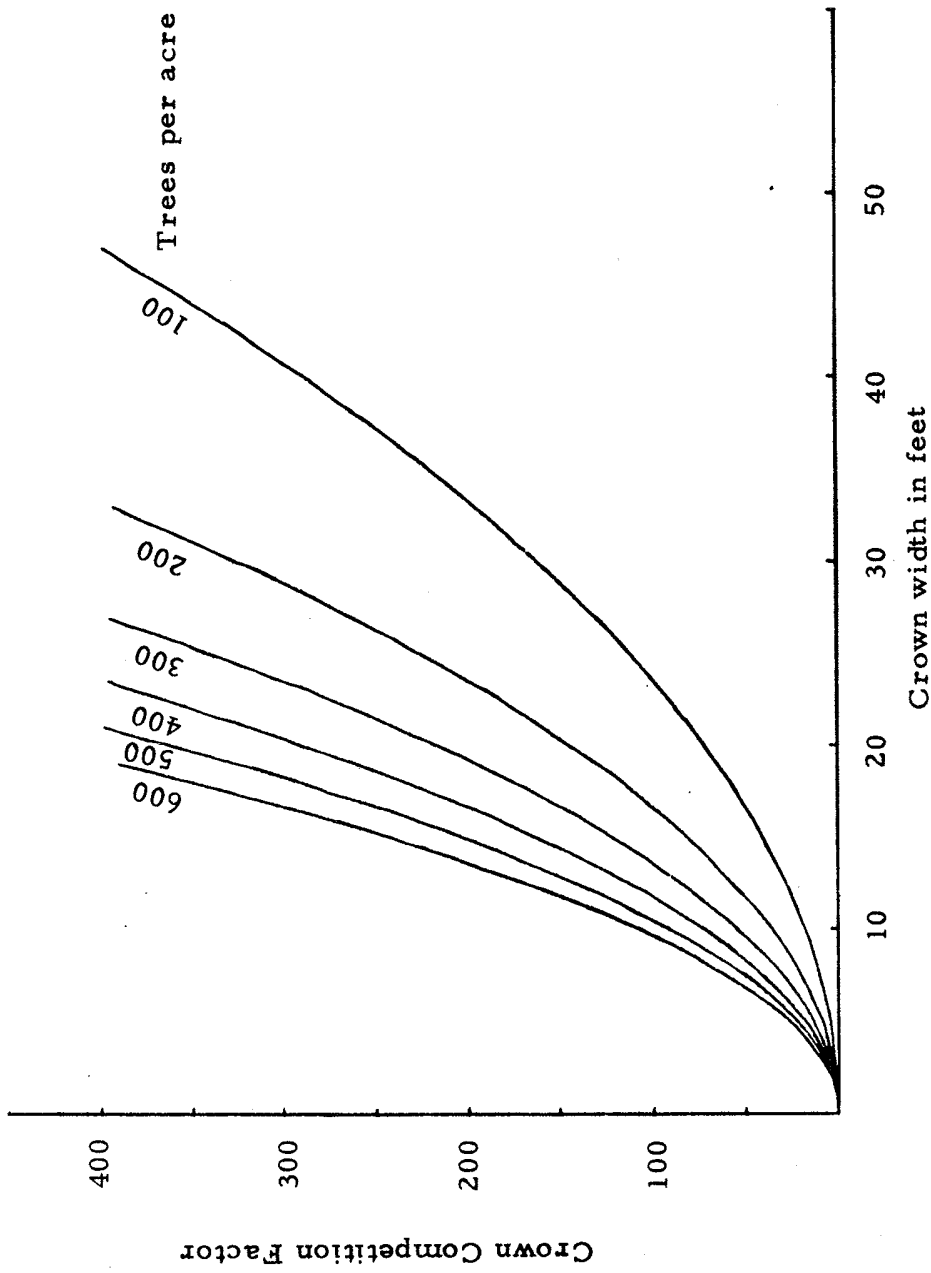

Figure 6. Crown Competition Factor as a function of crown width and number of trees per acre.

fact that whorls of a given age occur at different heights in different trees is taken into account. Competing whorls in competitor trees at equal or slightly higher elevations than the subject whorl are measured without regard to age.

#### Tolerance Limits

The crown base is usually found at some point immediately below the point at which intercrown competition begins in Douglas-fir. If not, the stand has had some recent history of disturbance or it is not uniformly closed and sunlight is penetrating deep into the canopy through some large opening. The third hypothesis used in this model is that a limit exists beyond which death of a whorl can be predicted based on the CCQ index at that whorl.

An independent study was made to characterize an index of tolerance as some level of the Crown Competition Quotient described above. Appendix II shows the derivation of the equations and the field procedure.

As discussed in the introduction, stem form is a reflection of stand density and relative position of the tree in the stand. Maximum radial increment is found at or near crown base. It is necessary for this model to define the height to crown base so that a limit may be set for maximum radial increment laid down along the clear bole of the tree. The height to crown base for a given age, site and stand density is dependent on the tolerance of the species. Measurement of CCQ at crown base will yield an estimate of the maximum competition at which a whorl can function for a given species. This index should be consistent for all undisturbed stands of Douglas-fir where growth has been

limited, due solely to competition.

Nineteen points measured in uniform undisturbed Douglas-fir stands throughout western Oregon defined a CCQ at crown base consistently near a value of 135 (Figure 7). Some correlation with total height was noted. For stands taller than about 70 feet, few trees in the stand will be found with live crowns extending much below the horizontal level where CCQ equals 135.

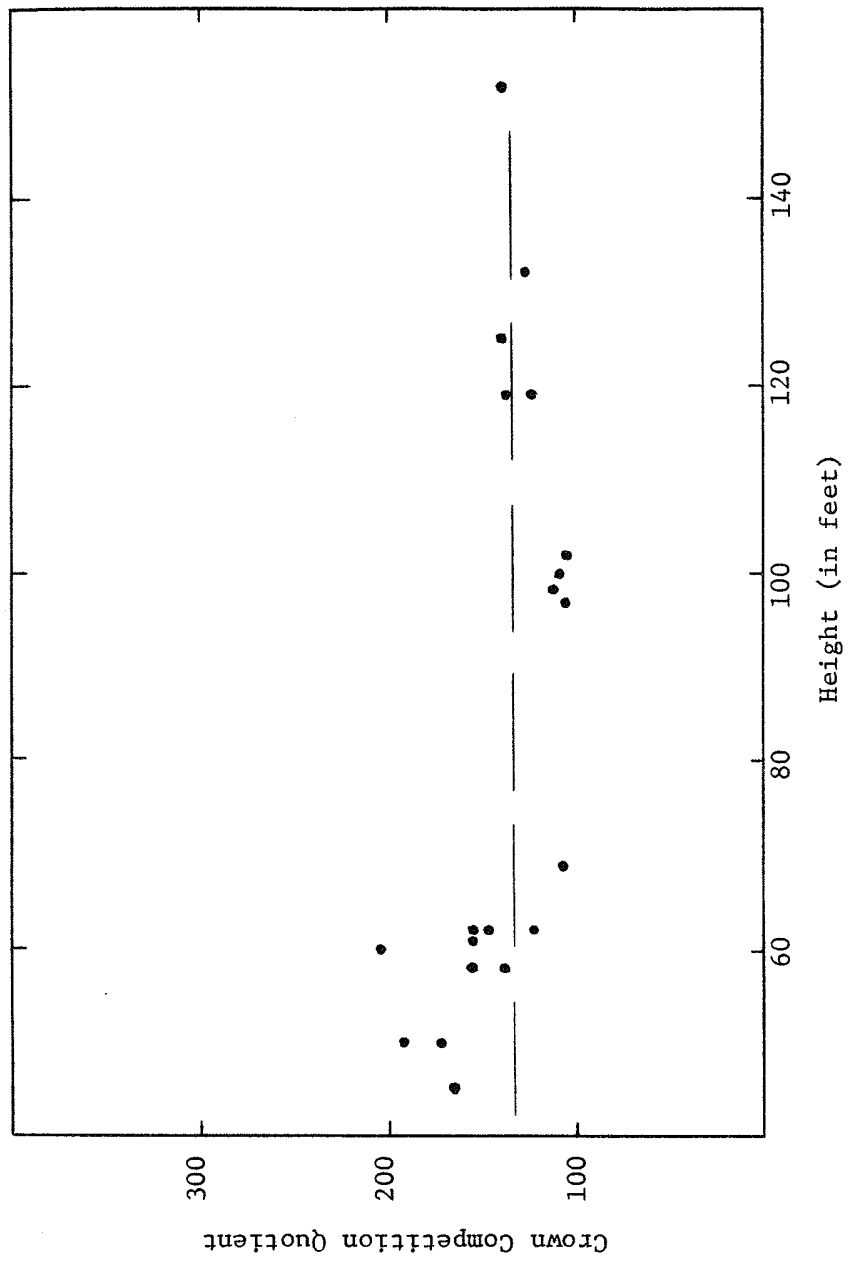

Figure 7. Tolerance as affected by total height.

## BUILDING THE MODEL

### General Approach

The procedure for this study is to model the growth of each individual tree in relation to its competitors. The growth of the bole and crown at each whorl down the entire length of the tree is simulated in the model each year. The resulting volume growth is a function of age, site and crown competition index. It is possible for the forester to observe the effect of these constraints on the form and on density of the wood laid down along the bole.

Only one tree species has been modeled in order to determine if the approach is feasible. Later, other species can be tested. Site is an input variable since it is the most consistent indicator of dominant or open-grown height growth. Age provides a measure of time and potential growth rates. Tree size and spacing determine when competition is important in the growth of a tree on a given site. No attempt has been made to describe the variation in growth that occurs due to genetic variability, multiple species composition or climatic fluctuation.

A new and logical extension of the crown width-DBH relationship discussed earlier will be tested in this study. The proposed hypothesis is that open-grown crown widths at any point on the open-grown stem may be expressed as a function of the diameter outside bark (DOB) at that point. If this is the case, simulation of open-grown trees should not be difficult.

The most formidable problem in simulating the growth of a

stand-grown tree is finding a biologically sound function that predicts the death of a whorl and crown base recession up the bole. The second hypothesis that was tested is that a limit for death of a whorl can be predicted from site, age, and an index of competition at that whorl.

As the crown width-DOB relationship was extended to include any point in the crown of open-grown trees, the competition indices will also be applied to each whorl in the stand-grown trees. Crown Competition Quotient measured on a horizontal plane high in the crowns of stand-grown trees will yield an index equal to 100 (no competition). As the horizontal plane is lowered, the index increases until it reaches a maximum at DBH. Measurements of DOB at crown base in stand-grown trees should yield an index of competition that represents the maximum competition a particular whorl can endure before dying.

Although trees grow simultaneously in nature each year, they do not do so in a simulator. As a first attempt to overcome this problem, each tree, in turn, received increments of stem and crown based on the previous year's dimensions of surrounding trees. After all trees in the simulator were assigned components of growth, the increments were accumulated on each tree. This resulted in excessive expense to complete one run on the computer.

The second attempt at predicting simultaneous tree increments consisted of increasing dimensional arrays to handle yearly height, stem diameter and crown diameter for up to 30 trees for 80 years. A separate dimensioned array stores temporary yearly increments of stem diameter and crown diameter for 30 trees for as many as 80 yearly nodes. However, the core capacity of the CDC 3300 was exceeded by this approach,



and the 2 by 80 by 30 array was discarded in favor of incrementing each tree sequentially during the growth cycle.

The first trees in sequential incrementing always have a slight advantage over those incremented later. Adverse effects of this constraint are minimized when, as in this simulator, the order of sequential incrementing is initially randomized. The result is a variance in size of trees not unlike that produced from genetic variation among individual trees in a stand.

Trees along the borders of the plot compete with those from the opposite border. Trees near the plot corners compete with those from opposite corners. This is slightly more complex to apply in the model than the more simply used "mirror effect". Mirror images of trees near the border of the plot tend to suppress all trees along the borders.

The model simulates the growth of each tree in turn on an annual basis. Randomization of the tree input list prohibits all trees in one corner of the plot from growing first. Unless restricted by a marginal crown size, the height is incremented at the beginning of each year. This provides a basis for predicting maximum stem increment and crown-width increment for the first whorl down from the top. Crown increment at each whorl is reduced by a function of the proximity and size of competitor whorls of equal or slightly greater height. Stem increment is reduced as competition increases on the whorl. This procedure continues for each whorl down the bole until such crown competition occurs that the whorl can no longer survive. From this point, the stem-area increment at each node below the live crown is equal to the stem-area increment at the last live whorl. This procedure is

followed on each tree in the model until all trees have completed one year's growth.

This model is peculiar in that increments occur annually, and at every whorl on every tree. Each tree is incremented in total height, stem diameter and crown width at the maximum expectation for the site and age and constraints of surrounding competition. Initial individual tree input consists of site index, number of years required to reach 4.5 feet in height, and two dimensional coordinates from a stem map. The coordinates may be from any source--field plot, random number generator or predesigned spacing. The model simulates up to 30 individual trees on any size of square plot predesignated by an input parameter.

This model is based on the hypothesis that maximum growth of height and stem diameter for Douglas-fir on a specified site results when no constraints on crown growth are imposed. Any constraint on the natural expansion of the crown causes a reduction in stem radial increment. Constraints equal to, or greater than the tolerance level set for crown competition cause the whorl to die and crown base moves up the bole one whorl. Reductions in live crown length cause a reduction in height increment. To simulate reduction of radial increment downward from crown base, as described by Larson (1963), area increments equal to increment at crown base are imposed. As area increment is applied to larger circumferences, radial increment becomes small. No attempt was made to simulate butt flare. A three-dimensional matrix in the computer keeps data on height, crown width and stem area for up to 80 continuous years for each of a maximum of 30 trees.

To derive a stable and reliable model for individual tree

development, some schedule for crown and stem increment suppression from open-grown conditions had to be generated. Based on seven plots, described later in Table 3, essential equations and coefficients were generated by repeated iterations of the simulation. A particular equation was modified only after the best coefficients failed to yield good results. Consistent prediction of a tree component over time and stand development was favored over a close prediction at one or two points. Over 100 iterations and associated analyses were necessary to arrive at the functions and equations on the following pages.

### Specific Model Design

#### Reducing Height Growth by Suppression

Height growth generally is unaffected by density unless the live-crown length is severely reduced. Little evidence is found in the literature describing the rate at which height growth declines as the live crown loses its status in the canopy. Height growth has been considered a good index of site quality because of its relative independence of stand density. As a tree loses its position in the crown canopy, and live-crown length becomes much less than 30% of total height, growth rate appears to be very sensitive to per cent live crown. For a first approximation from a threshold of 30%, height growth was reduced linearly to zero as live-crown length went to zero. As a general model, a negative exponential equation characterized height increment drop-off quite well (Figure 8). Coefficients were determined from repeated simulation attempts for actual stands. The form of the equation is:

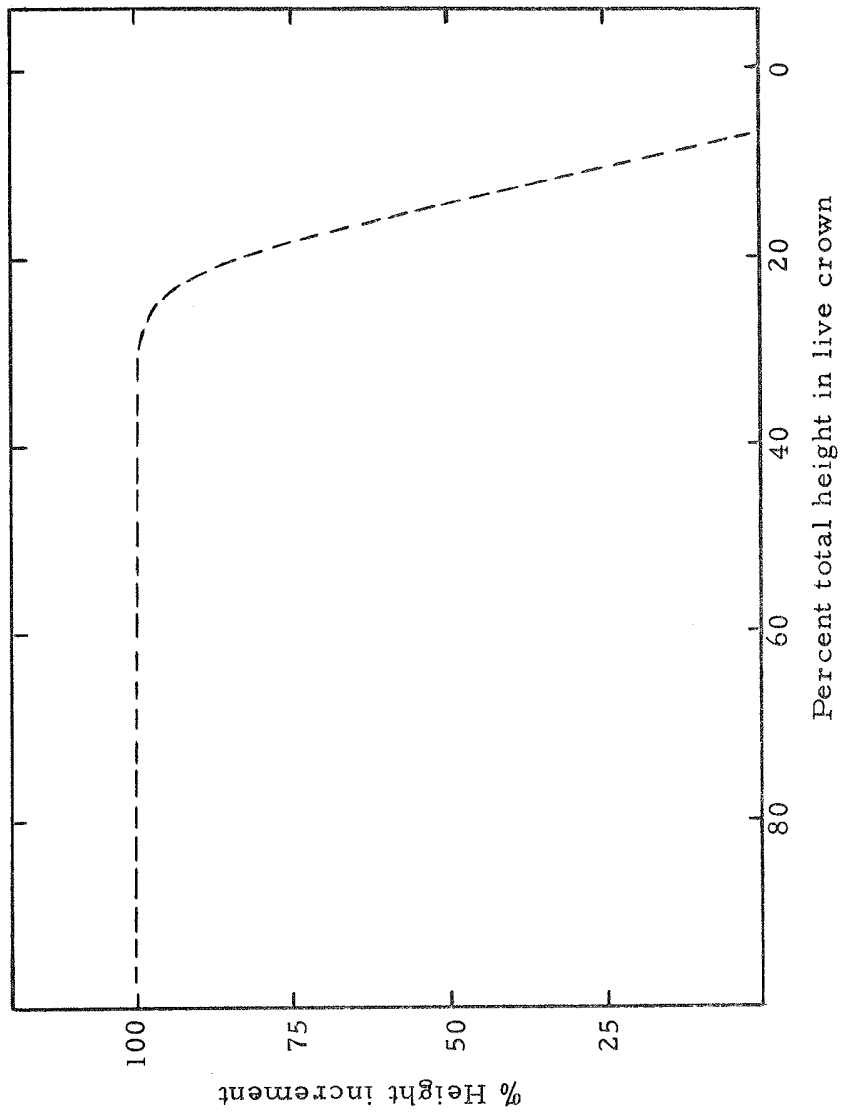

Figure 8. Height reduction rates for suppressed trees.

$$\Delta H = \Delta H_m \left[ 1 - e^{-200(CL)^3} \right]$$

where  $\Delta H$  = predicted annual height increment

$\Delta H_m$  = maximum annual height increment for given site index and age

CL = proportion of total height in live crown.

This relationship between height increment and live-crown length is a key constraint on the maximum stem-diameter increment and crown-width increment predicted at every whorl in each current year's growth. When height increment is reduced, predictions of stem increment are also reduced which, consequently, retards the maximum increment of crown width in the model.

#### Suppressing Diameter Increment

Each year growth begins at the top of the tree with height increment. Diameter growth and crown growth at each whorl are calculated after appropriate reductions are made for competition. Since the lower-most whorls contribute little, if any, stimulus to stem increment, some reduction in growth capacity may be appropriate as competition approaches the tolerance index limit. After considering published research on growth potentials near crown base (Larsen, 1962), a simple linear reduction equation was applied as a first approximation. The inferred reduction equation was of the form:

$$\Delta DOB = \Delta DOB_m \left[ 0.8 + .2(TOL - CCQ)/(TOL - 100) \right]$$

where

$\Delta DOB$  = diameter increment under competition

$\Delta DOB_m$  = maximum possible diameter increment for current year.

TOL = tolerance limit for whorls to remain alive

CCQ = crown competition quotient of current  
crown interaction

As Figure 9 shows, diameter growth is reduced by only a small proportion in addition to reduction because of a short live-crown length. Restricted live crown lengths reduce height growth which reduce diameter growth. Little growth stimuli originates from the lower-most live branches and, in fact, some researchers have stated that dying branches may have a negative effect.

After repeated attempts at simulating volume increment, the above equation was discarded because it consistently produced stems almost cylindrical in form. To attain a more realistic stem form, the following equation was adopted:

$$\Delta \text{DOB} = \Delta \text{DOB}_m \left[ .3 + .7 e^{-2.3(1 - \text{GPC})} \right]$$

where

$$\text{GPC} = (\text{TOL} - \text{CCQ}) / (\text{TOL} - 100)$$

.3 = asymptote representing the minimum residual  
proportion of diameter increment when CCQ  
equals TOL

2.3 = reduction rate coefficient applied to relative  
crown competition.

The form of equations and associated coefficients were derived from trial and error modifications on the tree model during iterative simulation attempts of actual data (Figure 9).

#### Suppressing Crown Increment

As the tips of whorls come into competition with one another, the amount and quality of light is severely reduced. Growth of the

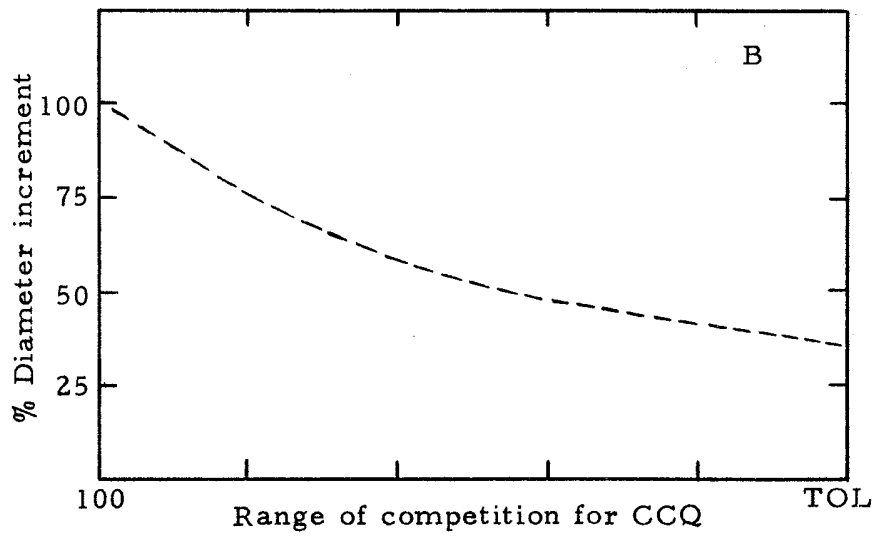
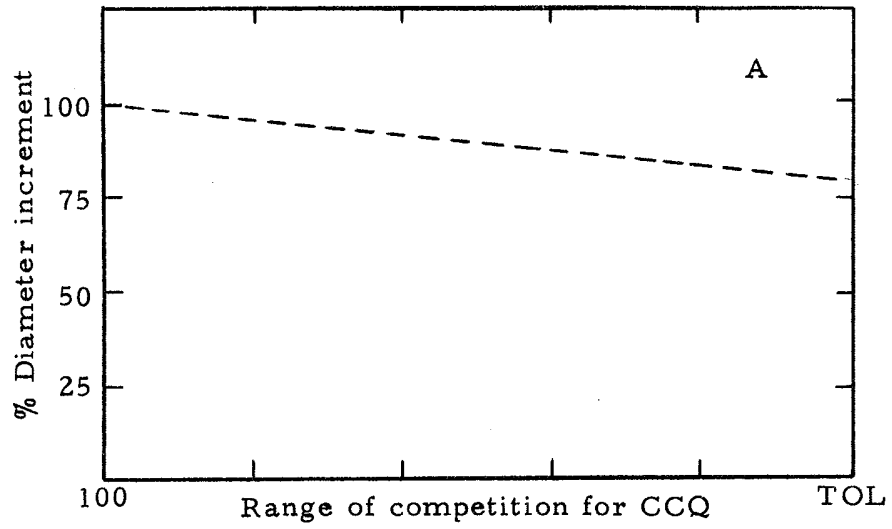

Figure 9. DOB increment reduction as a function of CCQ.  
A: initial approximation; B: final approximation.

whorl drops off due to this competition and, in taller stands, because of physical abrasion of lateral buds in neighboring trees. No previous work has quantitatively described the form of relationship between competition and crown increment. Most researchers have tended to classify crown shapes as essentially parabolic when faced with this problem (Curtis and Reukema, 1970). A linear crown reduction factor similar to the diameter reduction equation was initially applied. It proved to be in error when compared with documented stand growth.

Simulations incorporating a linear crown reduction factor produced trees with very short conical crowns. This caused the simulated bole of dominant trees to have very little taper and slow-growth rates. Stand average diameters were underestimated by approximately 30 percent, and the estimated number of trees per acre after 25 years was underestimated by 20 percent. A non-linear form of the crown suppression equation was substituted and gave good results, resulting in longer crowns of parabolic form similar to those described by previous workers. The nonlinear crown increment reduction model assumed the form:

$$\Delta CW = (\Delta CW_m) e^{-5.6(1-GPC)}$$

where

$\Delta CW$  = crown-width increment under competition

$\Delta CW_m$  = maximum possible crown increment for current  
year

This equation predicts a rapid drop-off in increment as competition begins and a slow approach to zero growth under extreme competition indices (Figure 10). Since accrued diameter at given ages high in the tree are smaller, using this equation, annual crown increment is reduced which, in turn, reduces intertree competition, allowing a higher number of



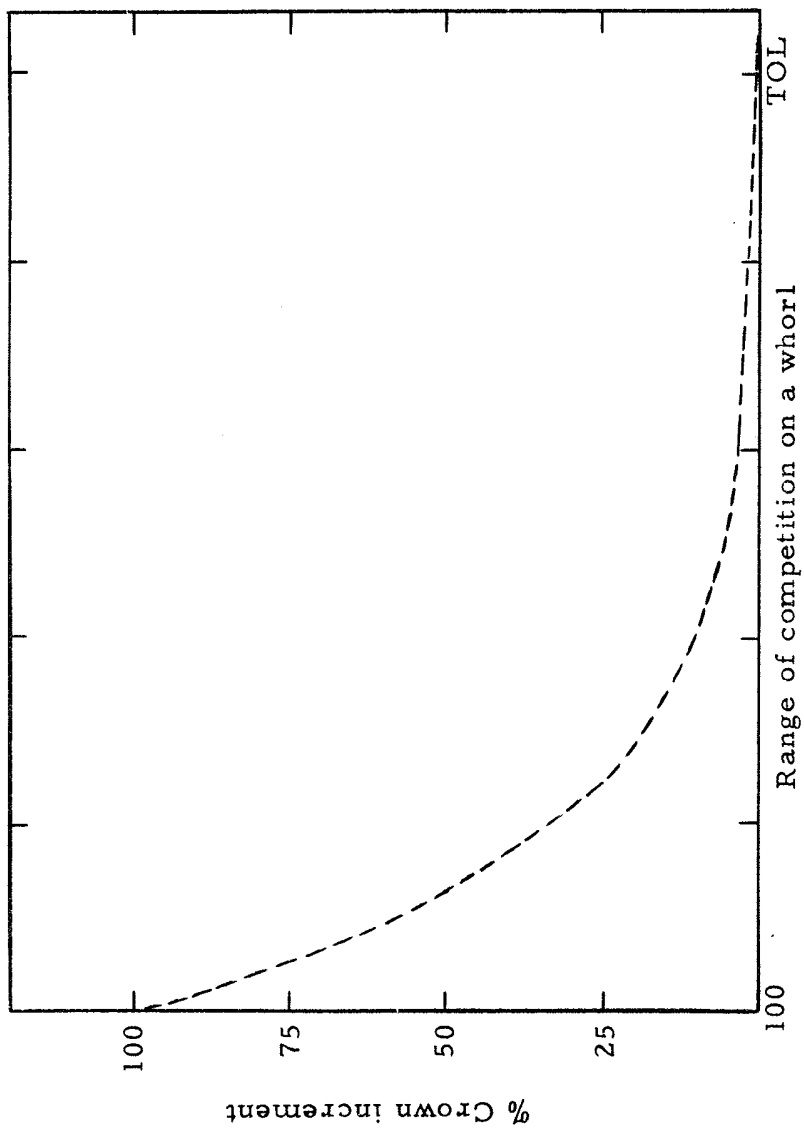

Figure 10. Crown increment reduction for suppressed whorls.

trees per acre to survive to any given stand age. As before, coefficients for this regression model were derived from repeated simulation attempts of actual data. Growth of seven plots (described later) were simulated once each for each adjustment of coefficients for regression models of height, stem diameter, and crown-diameter reduction.

### Mortality

Criteria for death have been one of the major concerns in developing a realistic mathematical model of a dynamic forest stand. The longevity of suppressed trees has a direct effect on the potential diameter and volume of associated dominant and codominant trees in a stand. If mortality occurs too slowly, stagnation becomes a problem and the growth of all trees in the stand is reduced. In extreme cases of suppression, increased growing space may fail to produce positive increases in stem increments. Thus mortality schedules early in the life of a stand can have critical effects throughout the stand development.

Mortality at a high rate causes the number of trees to be reduced too rapidly, and residual trees maintain excessively long, overdeveloped crowns.

Height increment remains near the maximum for a given site and stand age over most of the range of competitive levels of tree growth in a stand. If this were not the case, height increment would exhibit a significantly larger correlation with stand density. In development of this tree model, a threshold was defined where stand density begins to effect height growth. As discussed earlier, that threshold is approximately 30 percent of the total height of the tree in live crown.

As an arbitrary mortality level, 5 percent or more of the total height in live crown was deemed sufficient in the model to carry on minimum plant functions of transpiration and respiration. Trees with crown lengths less than 5 percent total height were killed. This is an assumption of the model and does not necessarily occur in the field. This approach was used in six of seven simulations.

Some basis for mortality attributable to the individual tree is preferable. However, in lieu of adequately performing individual tree mortality schedules, some stand schedule may suffice. A likely candidate is the maximum Crown Competition Factor that has been observed in normal stands. The simulation model could easily monitor development of CCF over time. The probability of death increases with density and poorer competitive position. The smallest trees in the stand were deleted first under this criteria for mortality in the model.

#### Volume Growth Response

Basal area increment has been one basis for judging success or failure of various thinning schedules, in spite of demonstrations that there is no direct proportion between basal area increment and volume increment. Other than total height growth, which is basically independent of stand densities (Wiedemann, 1932) usually tested, DBH has been the most frequently measured point on a tree. With the increased use of dendrometers (both optical and recording) and intensive observation at additional points high on the stem, growth is being observed along the entire length of the stem. The entire bole of the tree responds to growing conditions. The maximum diameter growth occurs at or near crown base and in some trees under marginal growing conditions,

a year's increment measured at crown base may never appear at DBH (Larson, 1963). Other changes in form that may have occurred further up the bole of the tree have gone unrecorded. In some instances, thinning schedules that produced no significant response at DBH could have produced interesting responses in bole increment high in the tree.

In the model described here, simulated diameter increment is recorded at each whorl along the entire bole of the tree. It is a simple matter in the model to sum volumes of conic frusta for each internode over the entire length. In this way the simulation should characterize the growth that occurs over the entire bole of each tree. This will, in turn, yield the most sensitive measure of volume response to treatment, since it is the individual tree that responds.

In summary, this individual tree model uses empirical relationships of crown and bole diameter measurements from open-grown Douglas-fir. Bole diameter growth is limited by current height growth which is limited by the proportion of total height in live crown. Bole diameter growth is further limited by an index of neighboring tree competition and relative position of crown base. Crown diameter increment is limited by current bole increment at the same whorl and thus constrained by all factors acting on bole growth. The tree model accumulates annual increments providing a tree profile at any given time. This profile is compared to a mortality limit and used to calculate volume growth and yield.

## RESULTS

Individual Tree Simulator

The individual tree simulator produces output for a stand of uniform trees at a uniform spacing. To assure stability of the model, it was compared with similar parameters for a number of stand densities, sites and ages. Verification of a complex model such as this becomes very difficult when basic parameters such as site index, mortality schedules and initial live stems per acre are correlated with other "independent" variables (i.e., trees per acre), ill-defined or undocumented in past or current research.

In spite of gaps in basic knowledge of the mechanism of Douglas-fir growth under extremes of stand density, certain basic sensitivity tests were made. Most foresters are familiar with open-grown versus stand-grown tree forms, as well as the variations in growth resulting from thinnings. The sensitivity and stability of this model were tested by observing profiles of simulated trees grown in the open, in dense stands, and under intensive thinning.

Four individual tree simulations were run for site 135 (King) to a maximum age of 60 years. The first was essentially open-grown at 40 stems per acre. The following three were identical, with 681 stems per acre, except that the third and fourth were thinned to 300 stems at 20 years. The fourth received an additional thinning to 100 stems at 40 years. Profiles of the residual tree from each of these four simulated stands may be observed in Figures 11, 12, 13 and 14.

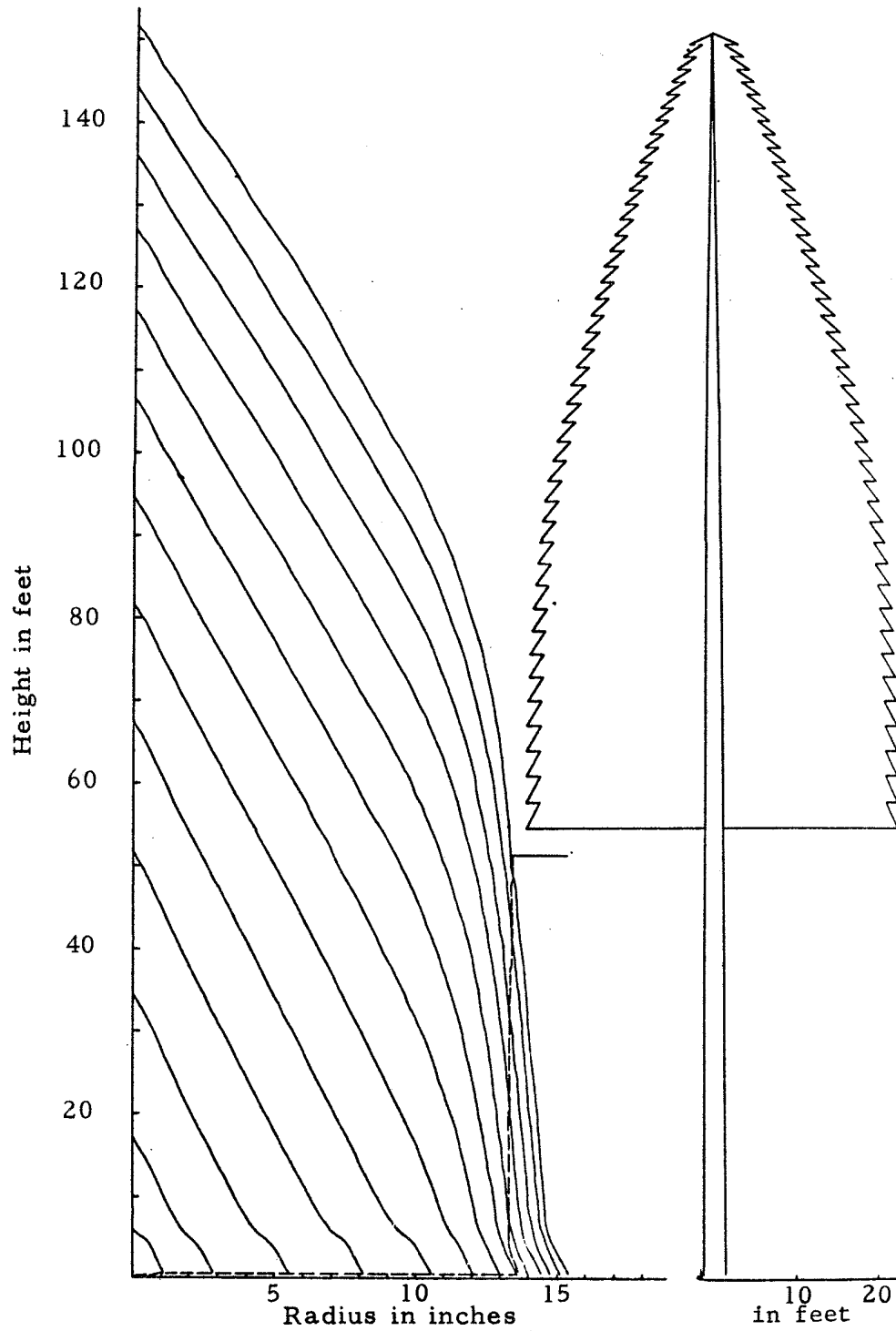

Figure 11. Simulated stem profile at 60 years showing 5 year increments from average tree simulation of 40 trees per acre.

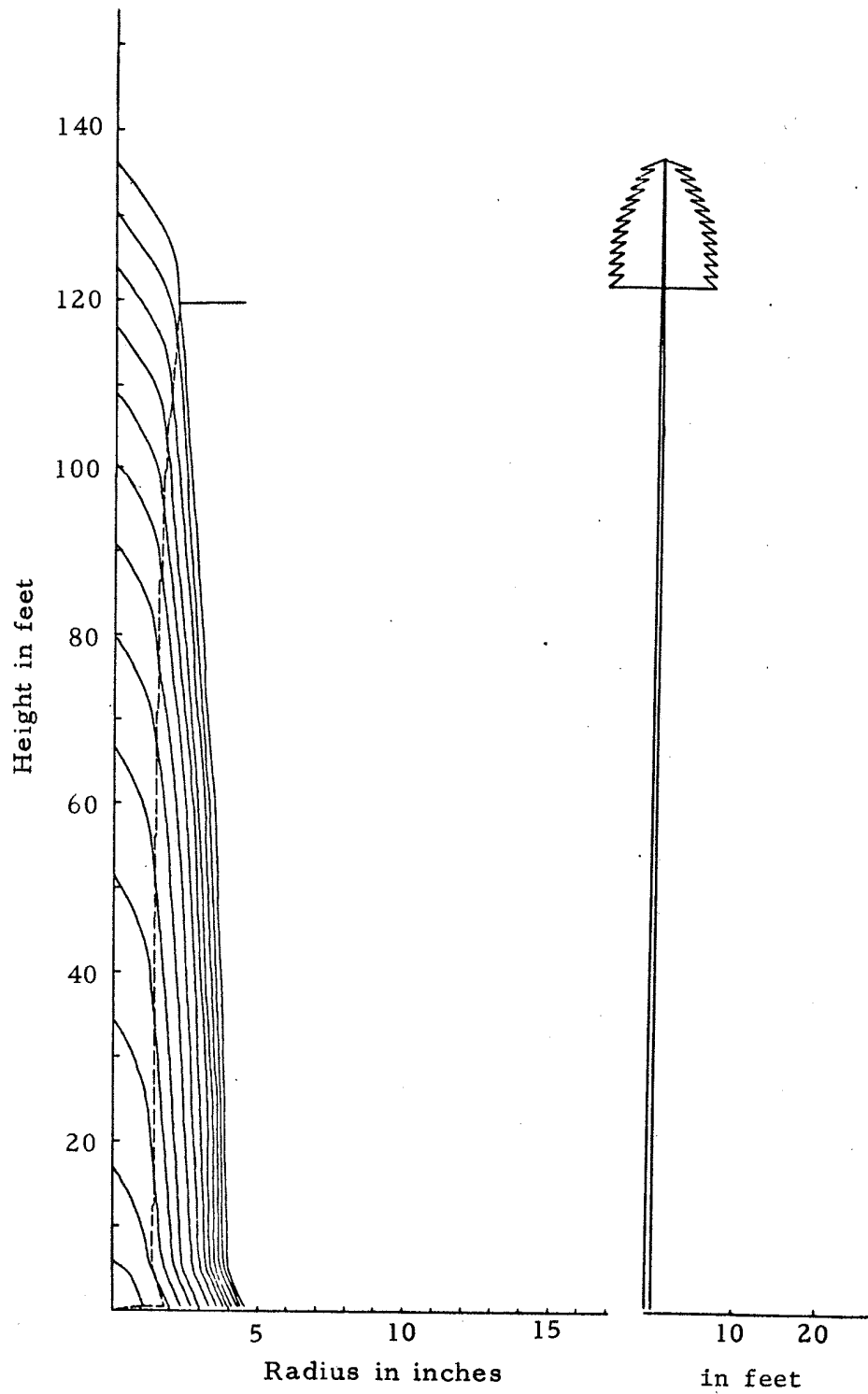

Figure 12. Simulated stem profile at 60 years showing 5 year increments. Initially 681 trees per acre.

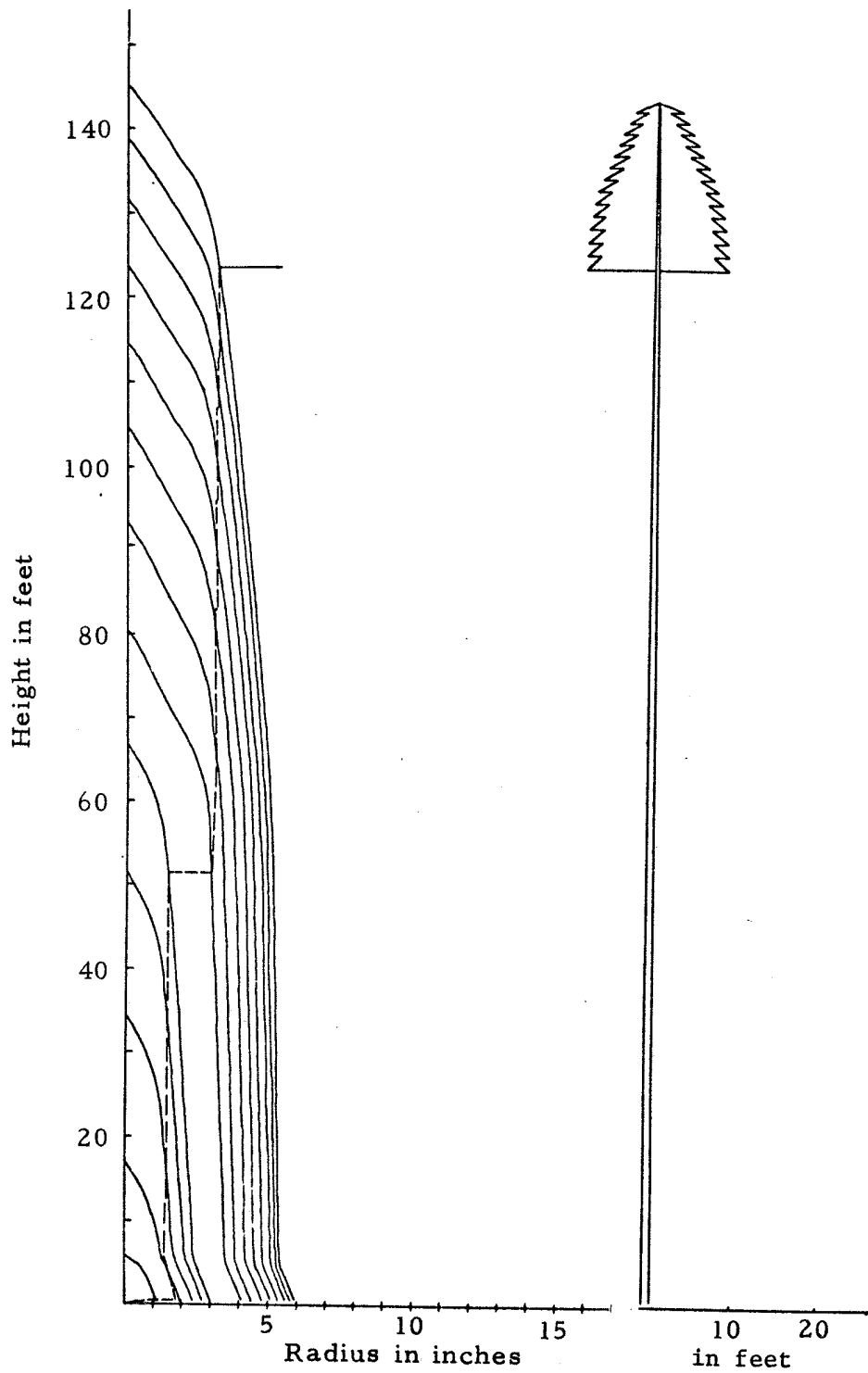

Figure 13. Simulated stem profile at 60 years showing 5 year increments. Initially 681 trees per acre, thinned at 20 years.



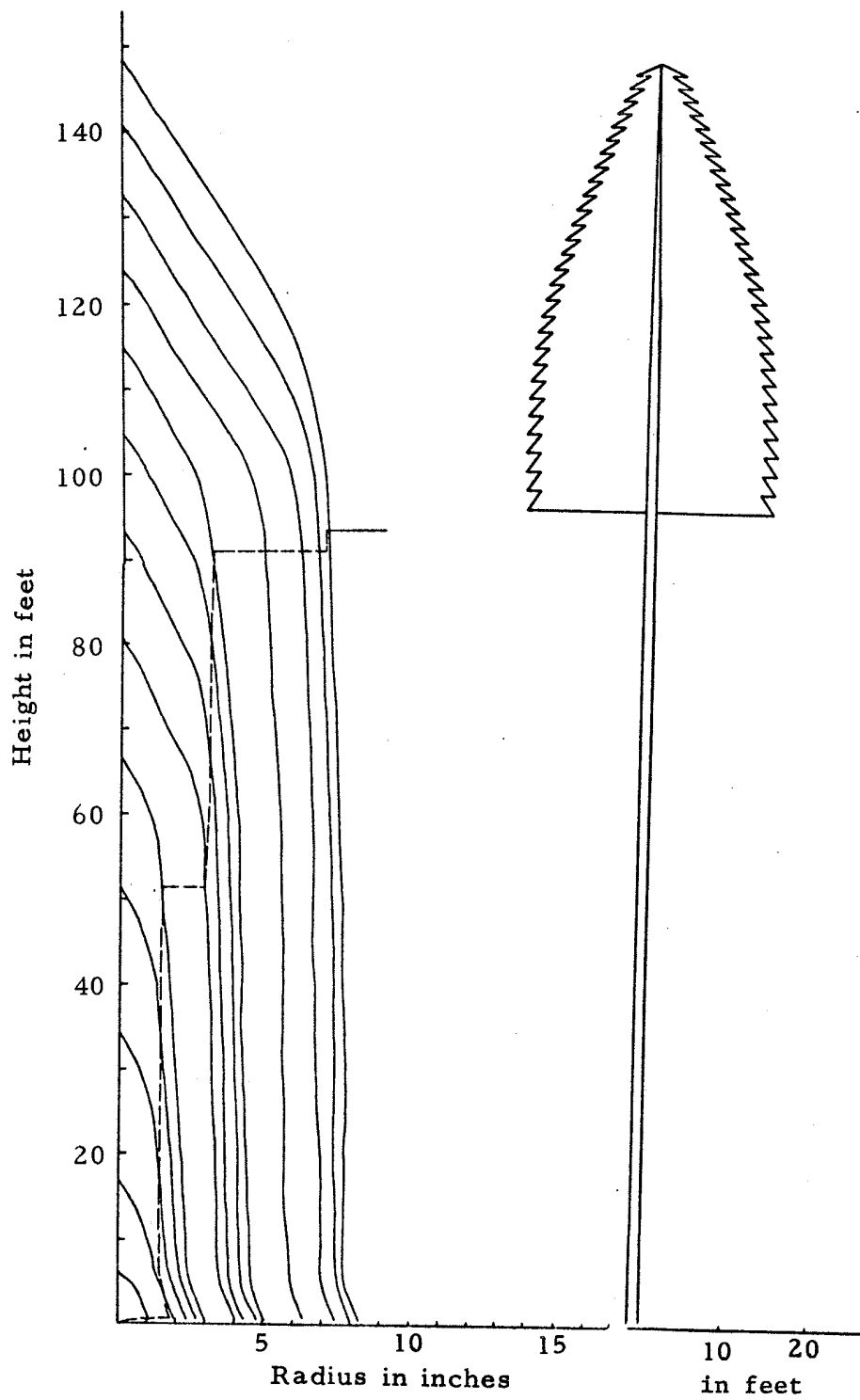

Figure 14. Simulated stem profile at 60 years showing 5 year increments. Initially 681 trees per acre, thinned at 20 and 40 years.

Even at 40 stems, the open-grown simulation came into inter-tree competition, resulting in recession of the crown base. The plot of crown-base position over time in Figures 12, 13 and 14, definitely demonstrates the type of reaction one would expect for these levels of site, age and density. The thinning at 20 years was moderate and the short-term increase in radial increment, until competing crowns again overlap, is the kind of effect one would anticipate by such methods. Although exact tree dimensions as a result of intensive management practices are not known, previous studies confirm the general trend of stem form in the last simulation as compared to the unthinned dense stand.

Most previous simulations of tree growth, based on models, yield results only for conditions similar to those of the stand upon which the model was based. Little effort has been expended to predict stem-form development. In most cases, volume growth has been a simple function of height and basal area. The reason individual tree models have not been attempted is presumably that tree growth is immensely complex. This model demonstrates that characterizing a developing stand is not as complex as we once thought and that it can be broken down into detailed components of growth and development. Component based models provide a framework in which precise quantitative relationships can be used to characterize the processes of stand development. Present stand models give precise volume-growth estimates for unmanaged stands and those managed stands for which the models were designed. Volume-growth estimates from stand models are little better than estimates from yield tables. The real value of a model is

in predicting yields from stands managed in ways yet undocumented in actual stands. What is required is an individual tree model that is stable enough to simulate a suppressed tree in an unmanaged stand on one computer run, and a residual crop tree in a repeatedly thinned and fertilized stand on the next. No modification of input should be required between these two runs other than management criteria on the stand. A tree model could be stable enough to be used this way.

In addition to stability of the model under a variety of treatments, it must, to have utility in management decisions, be sensitive to the environmental conditions imposed to the extent that reasonably accurate responses in height, form, diameter, crown dimensions and volume may be observed. Only from a sensitive model will such information as wood quality and density become available for stand management decisions. Alternative management schedules can be evaluated based on the amount and kind of wood produced, such as variability and number of growth rings per inch.

Other comparisons may be made as interest dictates by reading Table 2. The model is sensitive to environmental conditions imposed, yet stable enough to reflect these changes over a wide range of conditions.

#### Stand Simulator

It is possible to simulate any stand condition, but coefficients acting on the various parameters have in many cases only been approximated. Only by chance would the model accurately describe a particular stand without further testing and parameter refinement. As individual relationships are understood, more exact and compre-

Table 2. Data from average tree simulation, age 60 years, site 135 (King). (volume in cubic feet)

	DBH	Height	TPA	Volume	Thinned	Mortality	Total
Open-grown (40 TPA)	29.5	150	40	11,017	--	--	11,017
Unmanaged stand (681 TPA)	8.1	136	472	9,372	--	3,000	12,372
Thinned at 20 yrs. (681 TPA)	10.8	145	300	12,594	1,285	--	13,879
Thinned at 20 and 40 yrs. (681 TPA)	15.5	146	100	9,721	6,035	--	15,756

hensive field data can be collected to stabilize them. In this study, seven plots from four localities were modeled. Five of the plots are from western Oregon and two are from Washington. None of the Oregon plots were established early enough in the stand history to obtain the initial number of live stems per acre.

Plots A, B and C (Table 3) represent part of a Levels of Growing Stock study established by the Oregon State Forest Research Laboratory in 1963 (Williamson and Staebler, 1971). The stand, predominately Douglas-fir, was uniformly stocked with approximately 1,700 stems per acre. Plot A (Figure 15), in this paper, is the average of three 1/5-acre plots, and B and C are averages of six plots each. Plots B and C (Figures 16 and 17) received calibration thinnings at initial plot installation, leaving 345 and 332 trees per acre, respectively. Three years after the calibration thinning, plot B was reduced to approximately 325 trees per acre and plot C to approximately 211 trees per acre.

Because of the limitations on the number of trees (30) that can be handled by the simulator, a square plot 25 feet on a side with 29 randomly distributed trees simulates 2021 trees per acre. Based on 1,700 trees at 20 years, slightly over 2,000 trees would be required at 8 years, when the stand averages 4.5 feet in height.

Since the simulator is being compared with the average of a number of replications, a random distribution of stems offers the least difficulty for comparison tests. It also interjects an essentially wide range of growth potentials among trees in the model.

Various minimum limits of per cent of total height in live

Table 3. Description of sample plots.

	Plot						
	A	B	C	D	E	F	G
Location	Hoskins	Hoskins	Hoskins	Clackamas	Black Rock	Wind River	Wind River
Treatment	Control	Thinning	Thinning	Control	Control	8 x 8	12 x 12
Site Index (King)	116	116	116	92	113	80	98
Initial TPA	(2020) <sup>1</sup>	(2020)	(2020)	(2200)	(440)	681	303
Data span (yrs.)	20-27	20-27	20-27	25-35	47-54	29-43	29-43
Present TPA	1272	325	211	1244	266	520	265
Present DBH (inches)	5.7	8.8	9.3	5.0	12.2	6.9	9.8
Present age (yrs.)	27	27	27	40	61	48	48
Stand establishment(yr.)	1943	1943	1943	1930	1909	1922	1922
Elevation (ft.)	1000	1000	1000	1450	1200	1350	1350

<sup>1</sup> Figures in parentheses are assumed initial number of trees per acre.

A, B, C: located approximately 22 miles west of Corvallis, Oregon near Hoskins, Oregon.

D: located 10 miles east of Mollala, north of the North Fork of the Mollala River.

E: located at Black Rock approximately 5 miles west of Falls City, Oregon.

F, G: located at Wind River, near Carson, Washington.

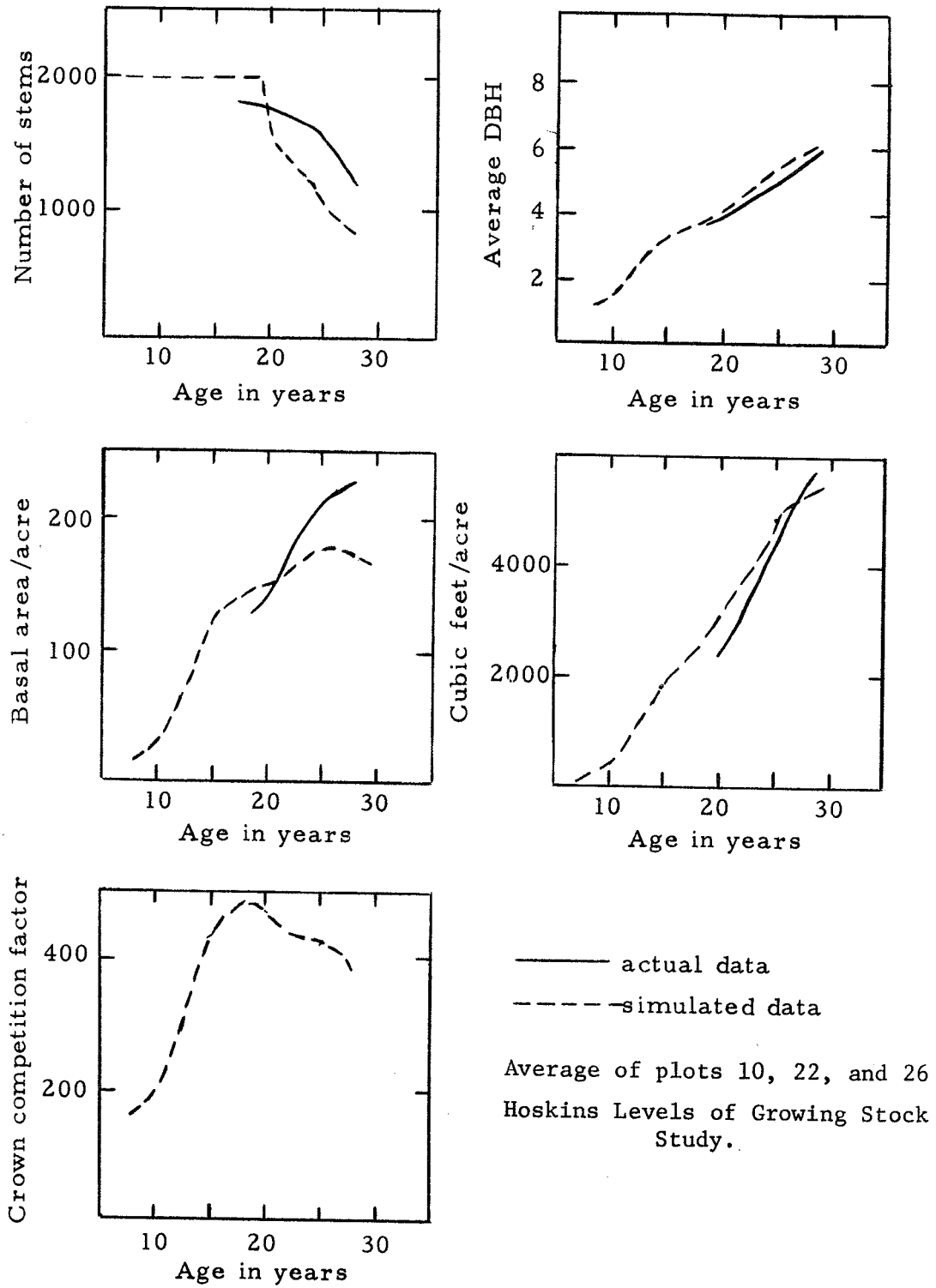

Figure 15. Plot A.

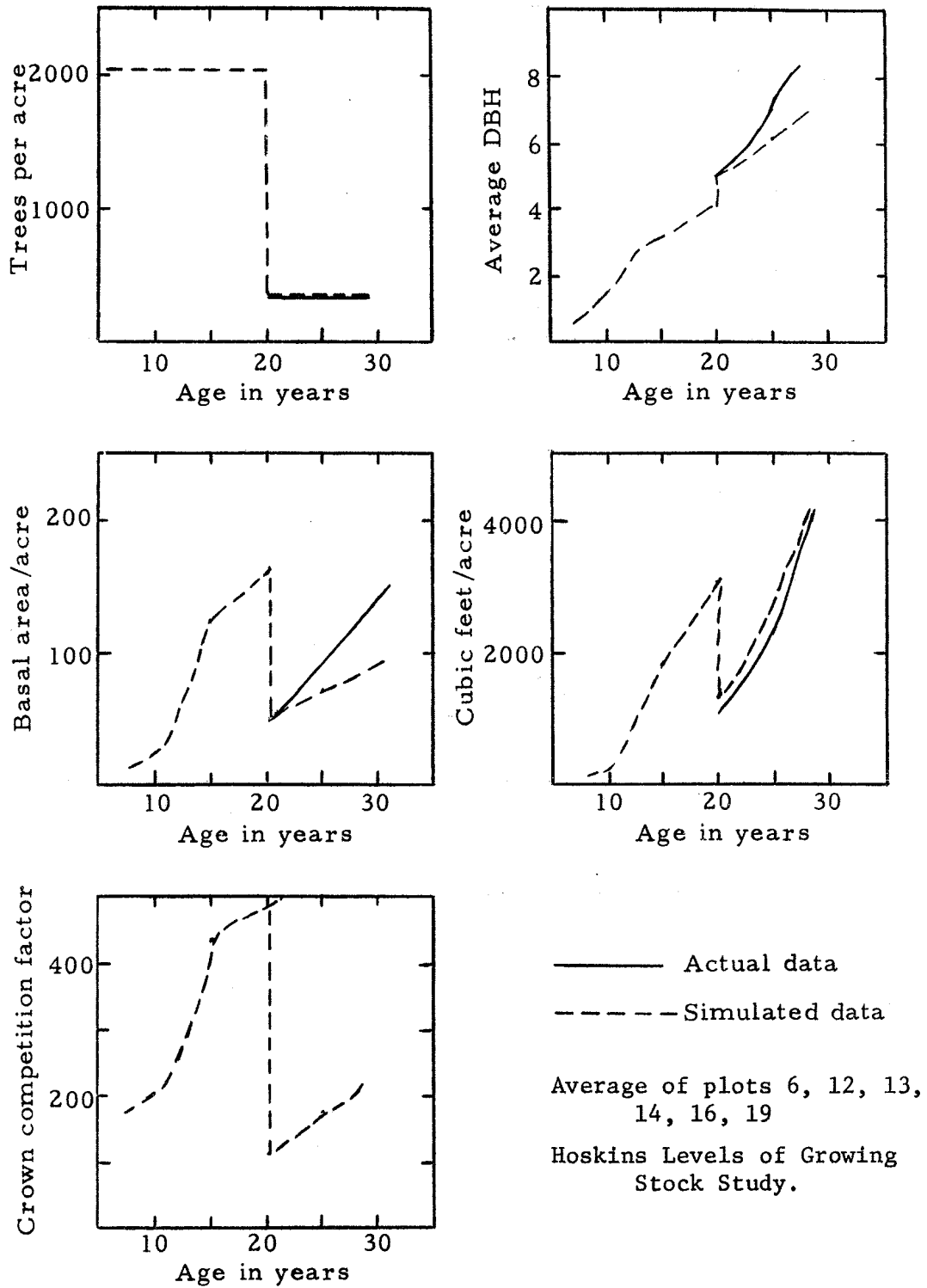

Figure 16. Plot B.



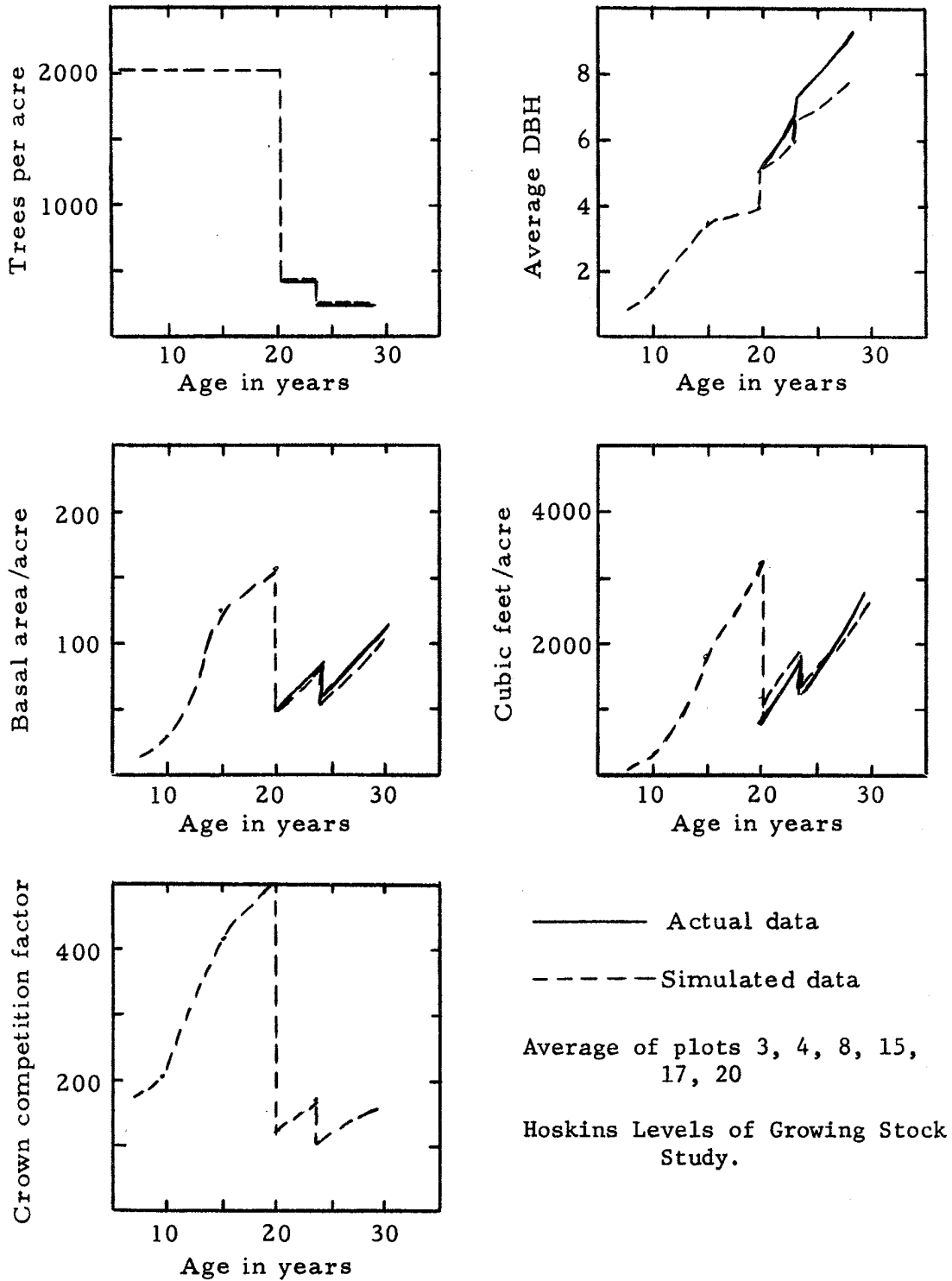

Figure 17. Plot C.

crown were attempted as a criterion for mortality of individual trees in the model. Values over 5 per cent produced excessive mortality early in the life of all stands simulated.

As seen in Figure 15, in which a mortality constraint of 4 per cent of total height in live crown was applied, the stand is allowed to develop for 19 years before any mortality occurs. At this late date the crowns of many trees in the stand have been overly suppressed. The result is an over-kill from the 19th to 21st year, before the stand again reaches some sort of stability.

Even though the average DBH of plot A maintains close agreement with actual data, mortality has reduced the residual stems per acre so severely that simulated basal area lags far behind by the 25th year.

Although the evidence is not sufficient to adjust coefficients, post-thinning volume growth on plot B suggests radial increment on upper boles much accelerated over DBH growth. Without more complete upper-stem radial increment data, it is difficult to determine if this is an error in the model, or evidence of field estimated volume not accounting for form change with thinning. Field-volume estimates are based on a height-diameter access volume table used locally by the School of Forestry.

Figure 18 represents a comparison of simulated and actual data from a thinning and fertilization study by Crown Zellerbach near Mollala. Referred to as Plot D in this paper, the plot is one of the unthinned controls for their study. To determine a reasonable site index over the period of data collection, an index representative of

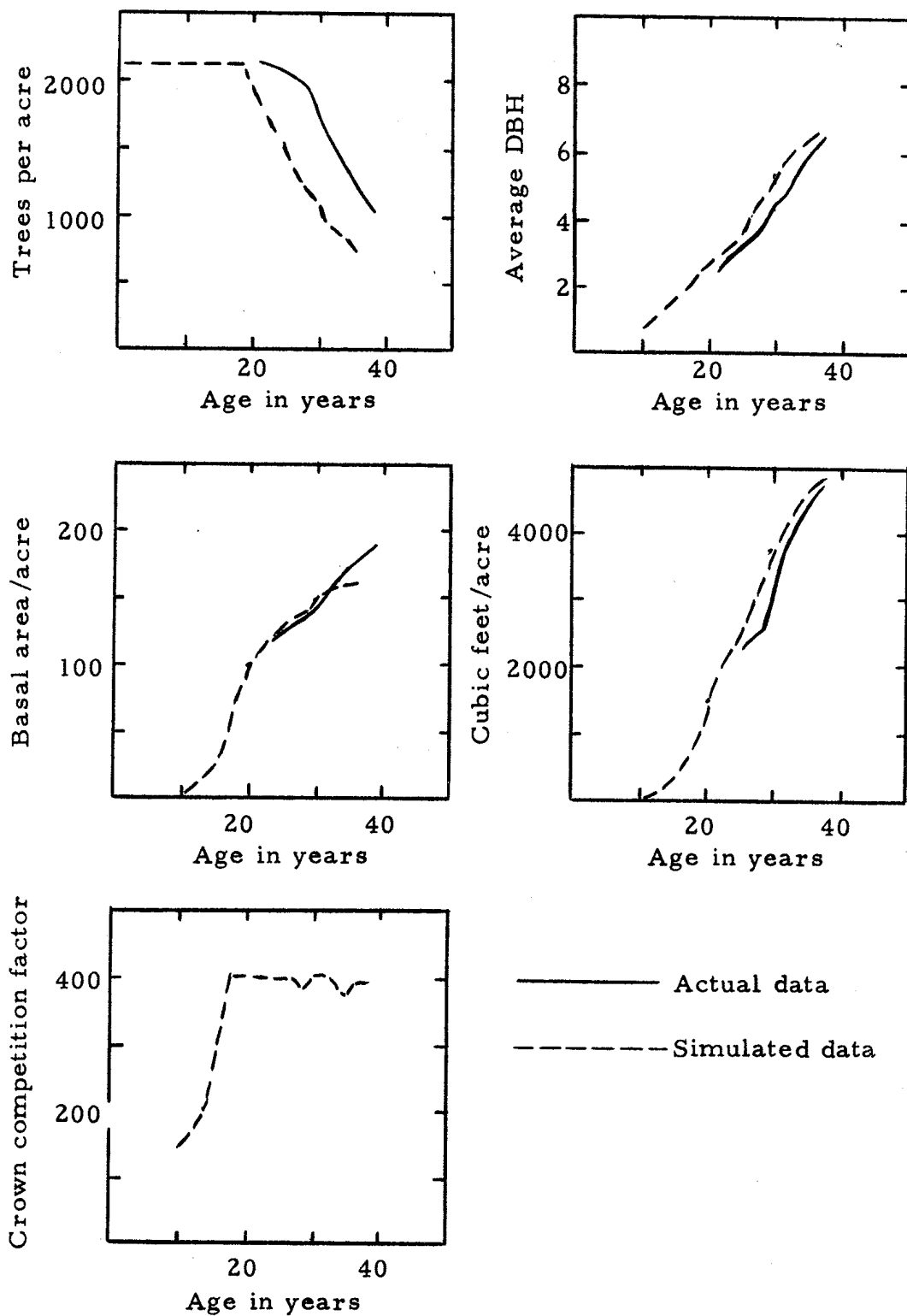

Figure 18. Plot D. Crown Zellerbach Control Plant.

actual heights recorded in the field was applied, rather than the index listed by Crown Zellerbach. This method yields a site index of 92 based on 10 years to reach DBH height.

The simulation was based on 29 trees in a 24-foot square plot representing 2,193 trees per acre. Mortality was modified to include a primary schedule limiting the maximum CCF at 400, and a secondary schedule limiting minimum per cent live-crown length at 2 per cent. As stated previously, live-crown length in this model has no relationship to field conditions.

The results are acceptable. Diameter breast height, total basal area and total cubic foot volume all perform well. Mortality occurs at a similar rate to actual records. Trees in the model, however, are apparently too intolerant of one another, accounting for the premature initiation of mortality at 19 years. This may be handled by adjusting the maximum CCF limit upward, thereby allowing all trees to remain alive until 20 or 22 years. However, there is no justifiable reason to expect all trees in a stand to remain alive for 20-plus years. The difficulty, therefore, lies within the tolerance constraints of the individual trees in the model. The mortality schedule will have to be revised before modifications are made in functions of other components.

The Black Rock data represents a complex problem for individual tree simulation models. The data chosen for simulation comparison are from Black Rock Plot 12, a control plot one-acre in size. The stand was already 47 years of age when studies were initiated. There is no information about the initial number of stems per acre nor about

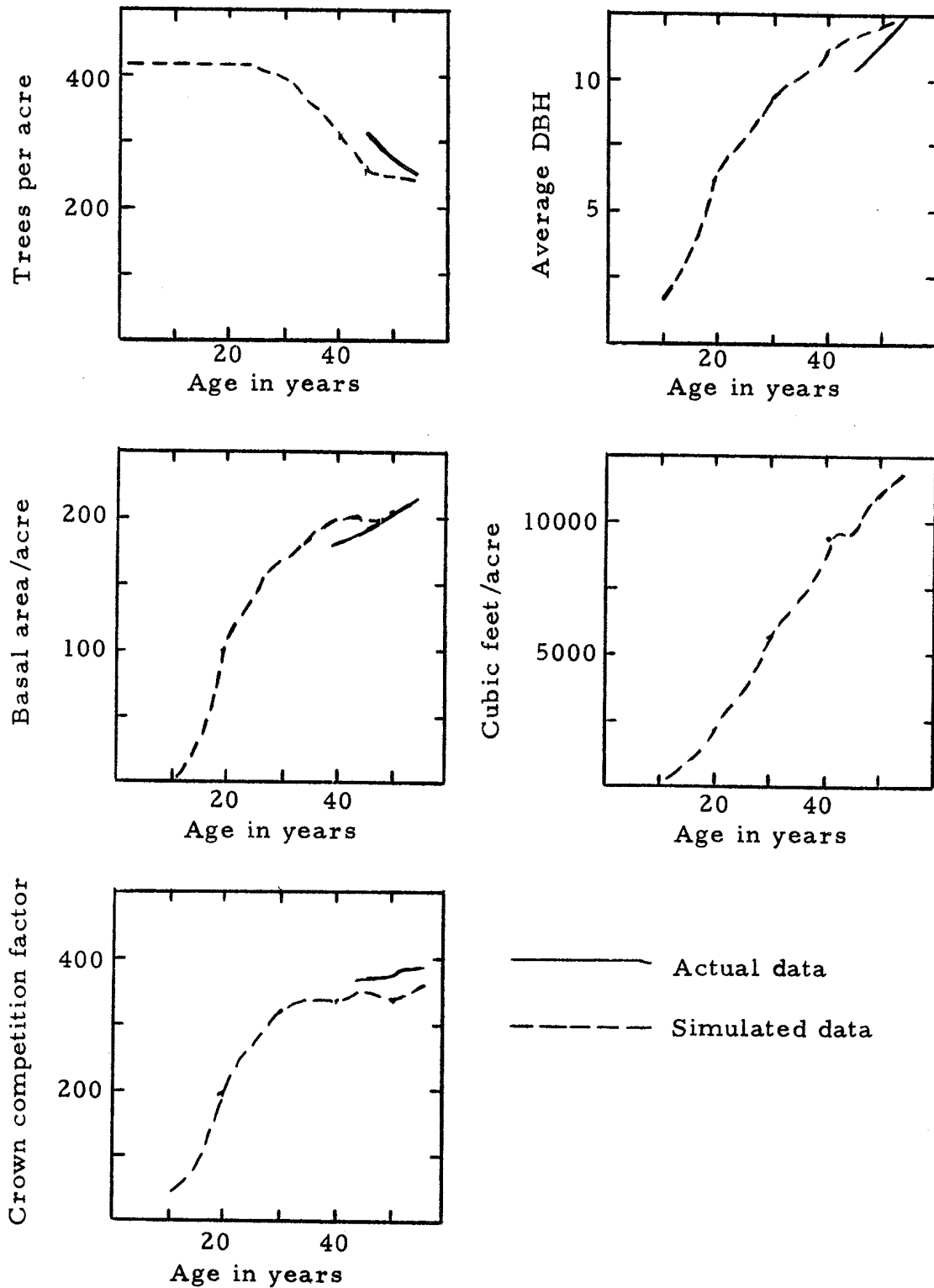

Figure 19. Plot E. Black Rock Control Plot 12.

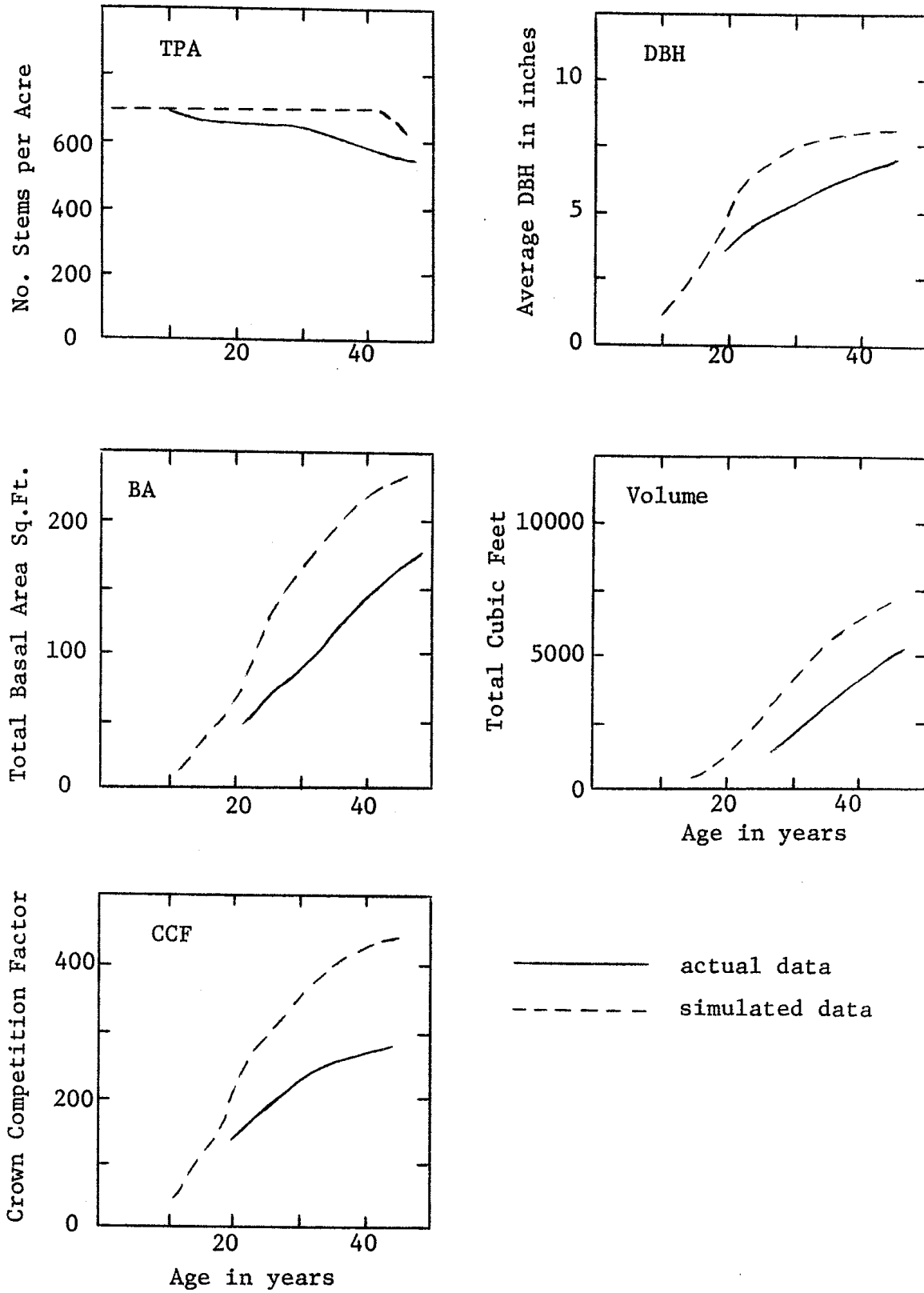
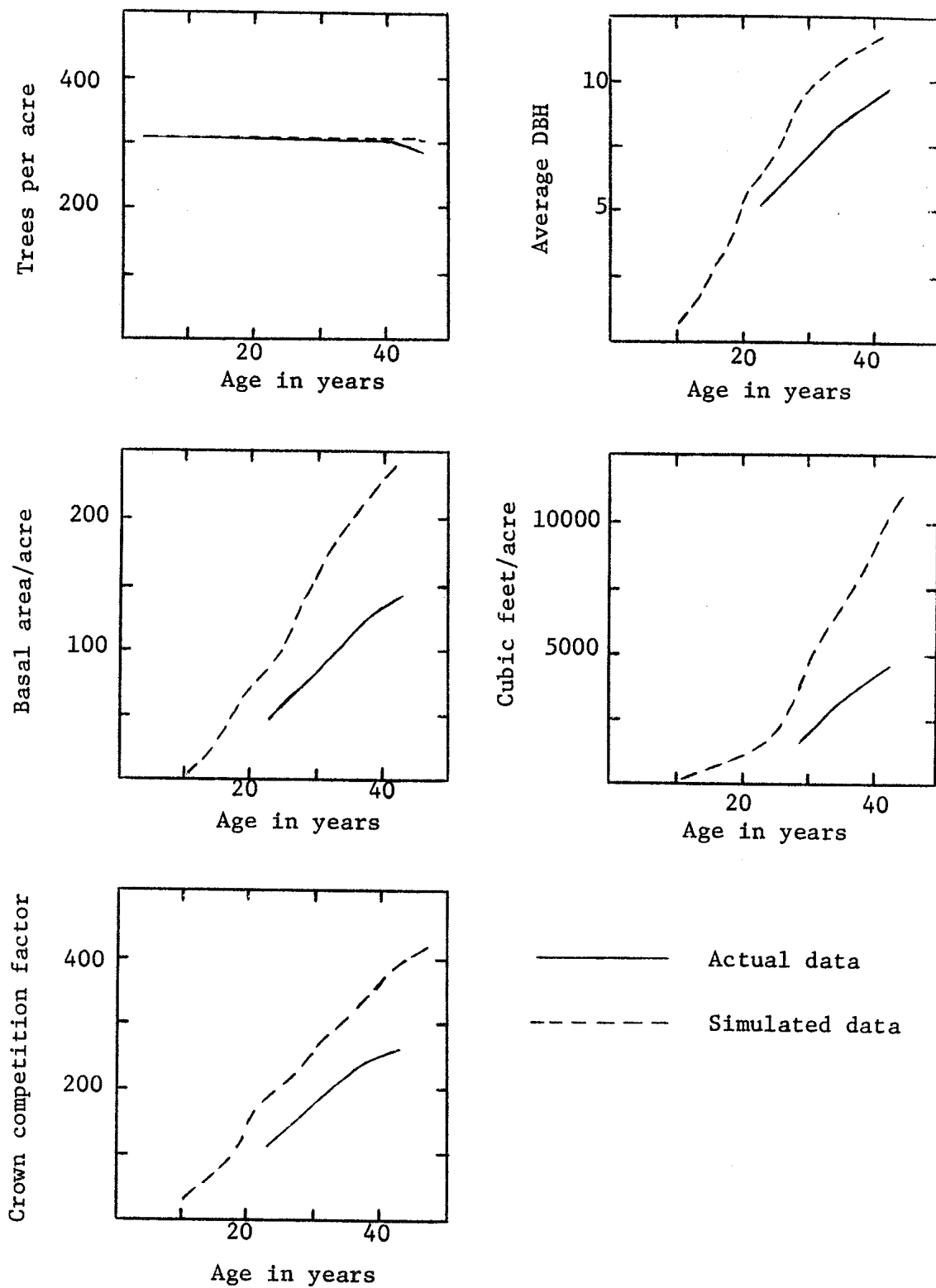

Figure 20. Plot F. Wind River 8x8 foot spacing trial.

intermediate stocking levels prior to 47 years. Only through iterative runs of the simulator, adjusting for initial stems per acre, is it possible to produce a stand 47 years old with the same characteristics of size, number, and potential for future growth. This is possible only if the simulator has been tested previously for accuracy throughout the younger age classes. Figure 19 demonstrates that 436 stems per acre was much too few. Diameter increment started at a high rate and reached comparable size to actual DBH's 11 years ahead of schedule. The problem of intolerance discussed on the previous stand simulation is also expressed here. Mortality is described by the 4% crown-length minimum as before. However, the CCF levels out just under 340, while mortality continues. CCF, calculated on the actual stand from 47-54 years, showed a definite leveling effect near CCF equal to 360. The simulated stand was not able to reach higher CCF levels because of the intolerance problem.

The final two plots, F and G (Figures 20 and 21), are simulations of spacing tests where the initial number of stems are known exactly. However, these two plots were established on very low-site quality land. Site index was apparently highly dependent on stand density. The site index estimate input to the model has to be adjusted for each spacing by comparing actual height growth with expected height growth for various sites. Diameter increment predicted by the simulator was much too high for these low sites. A great deal of the discrepancy in diameter growth was due to insufficient mortality. As reported by Reukema (1970), 61% of all mortality over the last 20 years of growth was attributed to storm damage (breakage, bending, windthrow)



Figures 21. Plot G. Wind River 12x12 foot spacing trial.



and only 7% to normal suppression. Mortality in the model occurred only through normal suppression. No trees were lost to mortality during the second 20 years in the model, while 73 trees died in the 8 x 8 spacing permanent plot. Only three of these were attributed to suppression mortality.

These last two permanent plots were chosen because of their wide spacing and uniform distribution. The initial number of stems is known and all trees are the same age. Except for the extreme site conditions and abnormal mortality conditions, these plots serve as a source of data representing the entire life of a stand. In spite of exact knowledge about the uniformity of age and spacing of individual trees, the simulated stand produced much less variation in tree sizes at 40 years than that which actually occurred. Genetic and microsite variation appear to be the only other probable sources of this expressed variation in height and diameter.

Plots A and F were also simulated using actual mortality as input for the stand model. The smallest trees were mortality in the simulator. These simulations (Figures 22 and 23) demonstrate the accuracy for growth prediction of the combined functions of the model. The simulator produced consistently precise estimates as demonstrated by comparisons of actual minus predicted values over time. Plot F was simulated yielding residual differences of DBH values averaging less than 5% of actual values over a 20-year period. These comparisons serve as evidence of the versatility of the model for simulating naturally established stands or uniformly spaced plantations.

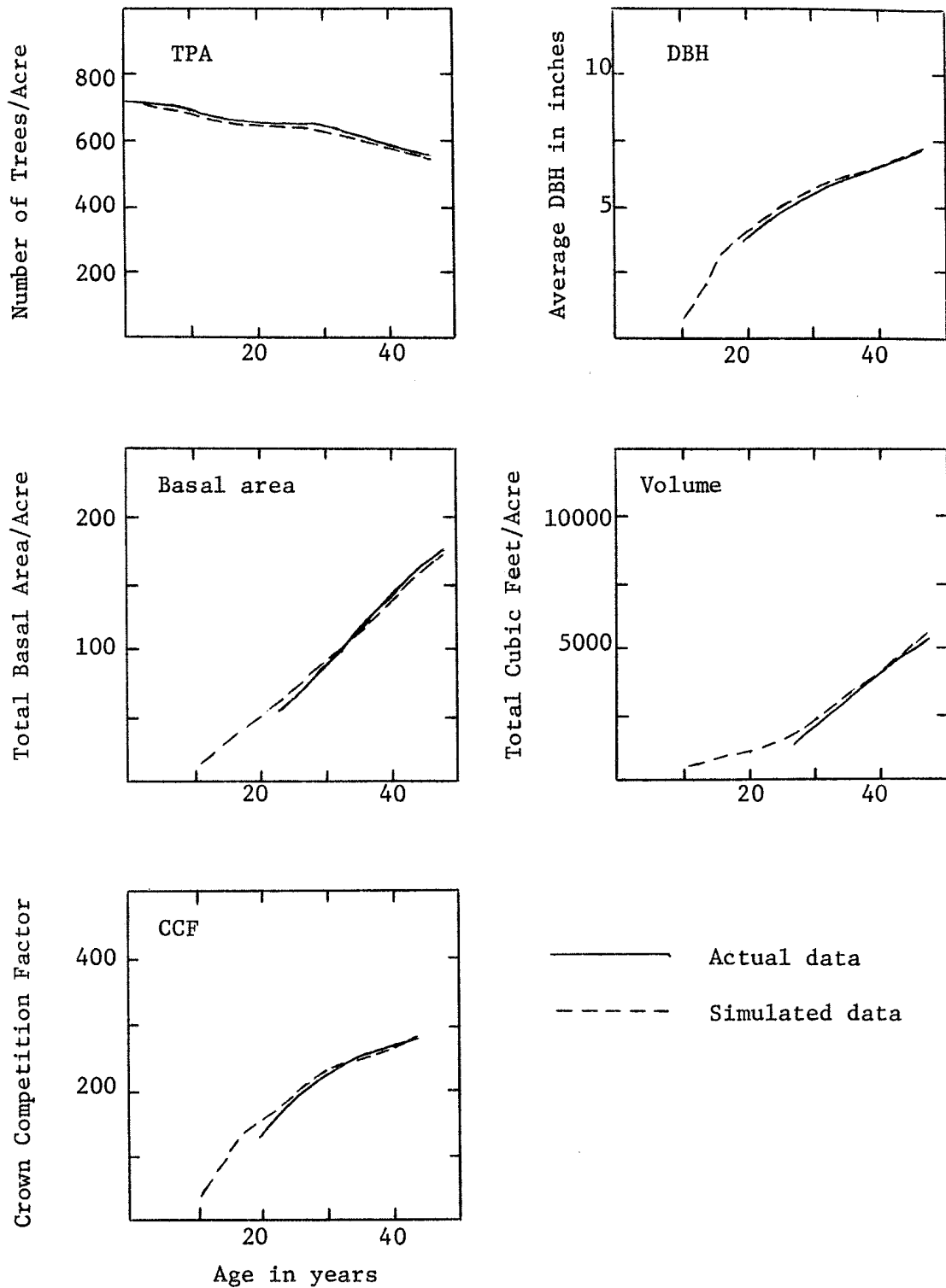

Figure 22. Plot F. Wind River 8x8 foot spacing trial.

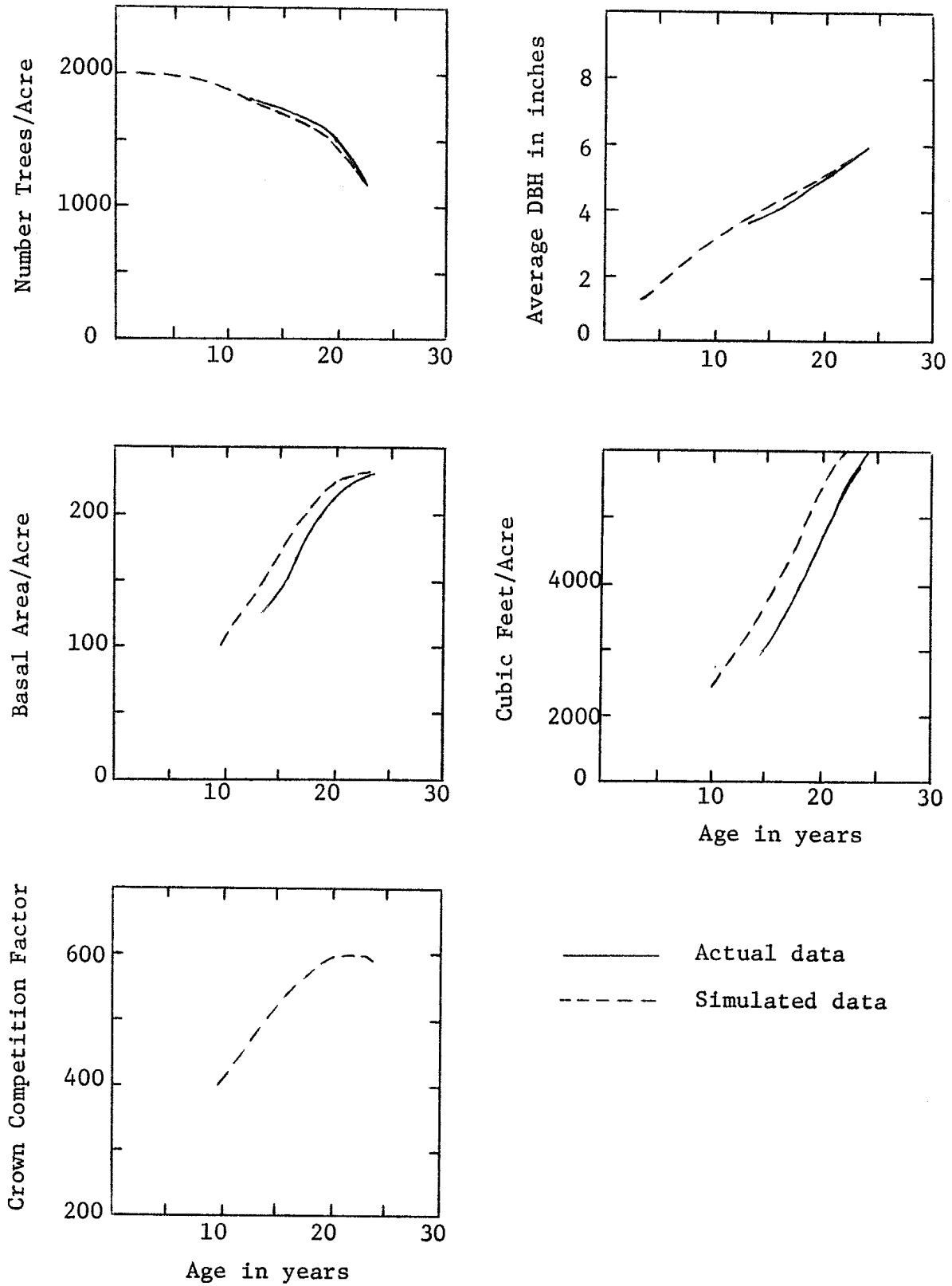

Figure 23. Plot A. Hoskins LOGS - Control.

## DISCUSSION

After more than 100 simulation runs on the computer, some interesting stand relationships became apparent. Repeated simulations of the Wind River spacing trials demonstrate that the effect of variation of site index and initial-age-to-reach DBH between trees is similar to random spacing in their effect on tree growth. When all trees in the model had identical height growth and age at DBH, the stand tended toward stagnation. This is understandable when one realizes that the model assumes a perfectly flat forest floor with uniform light input. Each tree is no larger or no smaller than the next. All trees uniformly become suppressed and die within a two- or three-year period. Only sequential incrementing is responsible for some trees lasting an additional year or two.

Intertree variation on the Wind River spacing trials was supplied by distributing height growth on approximately half of the trees above and below the mean. A deviation of two units of site index for height prediction appeared to have similar results to a one-year deviation in initial age for young stands. As the stands develop further the relationships change, with characteristics somewhat peculiar to each condition.

Further study may reveal that uniformly spaced stands require more frequent thinnings to maintain a high level of growth.

Interesting effects on potential response of stand-grown trees have been observed when coefficients regulating crown expansions are altered. When crown increment is constrained, competition does not build up as rapidly resulting in longer crowns. This changes the form

of the tree, reduces mortality, and increases potential radial increment responses due to thinning.

Stem form is directly affected by competition on successive whorls down from the tip of the tree. This empirical relationship has a direct effect on volume and is easily manipulated by the user.

To simulate the growth of a stand, described in this paper, for 60 years the cost is approximately \$10, including all output and a plot of one tree-profile.

#### Limitations

The most frustrating limitation in growth prediction is the instability of site index. Since site is the expressed height growth for dominant trees under generally normal stand conditions, any management scheme that significantly alters these "normal" conditions alters the basic potential height growth for the stand.

Since the accrued dimensions of each tree at the end of each year influence the processes during subsequent years, it is not generally possible to initiate the simulation at intermediate points in the development of the stand. To initiate a simulation from some intermediate time would require extensive stem analysis data for stem form on each tree.

As the computer program is presently structured, mortality occurs only through suppression. A list of all live trees is updated annually in the simulation. A small modification would allow mortality to enter as a result of windthrow, insect or fungal attack, or some other limiting constraint.

The most controlling factor on stem radial increment is the

estimate of competition endured by each whorl. The rate of increment damping with an approach of competition toward the tolerance limit was prescribed without prior knowledge. Further investigation may reveal more applicable functions. Until basic information is collected to prove otherwise, the simple relationship described in this paper can yield usable results.

#### Applications

Estimating individual tree growth and yield and aggregating to stands is thought to be the best approach to projecting growth in stands composed of a number of ages and quality classes with widely differing growth rates. This program was carefully written to ensure that each tree was entirely autonomous. Each tree has a file showing the number of years that each tree will wait to reach 4.5 feet in height. A second list contains the maximum expressible site index for each tree. Varying these two files makes it possible to study the effect of site variation and time of establishment on stand dynamics.

These characteristics give the tree physiologist and the silviculturist a very powerful tool to study intertree dynamics in natural and managed stands. With a small modification, it is possible to alter site index over time. Effects of fertilization may be predicted with this modification. The average site index may be increased for a short period and reduced back to its original level similar to fertilizer application.

Growth and yield for any spacing and management schedule may be tested. North and east coordinates may be input directly from field plots along with exact number of years to reach DBH height.

Log grade and quality yields may be predicted. Every diameter at every node is recorded along with length between nodes. Plotter outputs or data outputs may be used to measure number of rings per inch along any portion of the stem. Position of crown base over time, in conjunction with final stem diameters, may be used to estimate volume in clear veneer produced by a management schedule of interest. A similar model can be structured from this basic approach to handle two or more species, uneven-aged stands, or sloping or uneven topography.

Successful individual tree models of this nature can be useful tools in many aspects of forest research, education, and management. Stand management tables can be produced giving the forester a basis by which a stand can be managed to maintain maximum increment under a range of stand conditions. Models of this type not only predict yield of cubic feet, basal area, stems per acre, quality class and form, but also point out which characteristics of the stand are most important to measure and control. The next step in developing this model would be growth predictions for various combinations of site, age and competition level. The forester needs only to apply a point sample technique to determine the present competitive level of a stand. Given site index and stand age it would be possible to estimate growth rates over the next period. The forester can compare predicted growth for various thinning and fertilization schedules in conjunction with economic guidelines. Inputs of this nature to decision-making fulfill many of the needs that "normal" yield tables, stand tables, and various classifications of growth, stocking and stand conditions have attempted to meet in the past.

The tree model may be used to simulate tree and stand dynamics to clarify and expand classroom training in silviculture, mensuration, timber management and forest valuations. It would provide input to timber supply studies, determination of allowable cut and sustained yield predictions.



## SUMMARY AND CONCLUSIONS

An individual tree model was designed and programmed in FORTRAN IV for Douglas-fir on a CDC 3300 electronic computer. It is based on measurements of height, stem diameter and crown diameter of open-grown Douglas-fir over all sites and ages. Through iterative simulations of documented permanent field plots and intensive analysis of observed growth relations from cited literature, a number of inferences were successfully made that describe constraints on most aspects of tree growth under stand conditions.

A limited budget of \$1500 for computer related expenses made it possible to build and test the model to the degree described in this paper. Much better results are possible with broader data bases and more intensive simulation trials.

The use of Crown Competition Quotient as an index of crown tolerance shows stable characteristics for Douglas-fir throughout many stand conditions. Development of this tolerance index thus far was only preliminary, but results justify a much more intensive investigation throughout the Douglas-fir region. Field estimates of this index should be taken from all ages, sites and stand densities. A good measure of age and site index, in addition to measurements for tolerance index and total height, are necessary at each sample point. Regressions of tolerance index should be attempted on age, site index, total height of site tree, height of 100 largest trees per acre, height of total stand, or other similar stand characteristics that may have an influence.

This model can be used to define maximum expected growth rates for each combination of age class, site index and stand competition level. An example of one possible approach is detailed here. Through repeated simulations, volume-growth rates and yields for ten competitive levels of CCF from 100 to 300 may be recorded for 5-year intervals and 6 intervals of site. An 80-year maximum age should be sufficient. This will result in growth and yield curves as functions of CCF for 96 combinations of age and site index. The forester can apply the tolerance index sampling technique at DBH height to obtain an estimate of CCF in a particular stand he wishes to manage. With an estimate of site index and age he may read the appropriate curve and obtain an estimate of current growth and yield, as well as evaluate consequences of thinnings to various lower levels of CCF.

The model provides a sound, simple approach for prediction of growth and yield in a highly complex dynamic forest stand. Much more effort is required to describe the functional relationships as they truly exist. Relationships developed and discussed in this paper, such as measuring tolerance in the field, have opened new avenues of investigation. It is hoped that they will provide insight for other researchers in ways yet undiscovered by this author.

## BIBLIOGRAPHY

- Bella, I. E. 1969. Competitive influence-zone overlap: a competition model for individual trees. *Bi-Monthly Research Notes*. Vol. 25 (3): 23-24.
- \_\_\_\_\_. 1970. Simulation of growth, yield and management of aspen. Ph.D. thesis. Faculty of Forestry, University of British Columbia. 190 pp.
- Clutter, Jerome L. 1963. Compatible growth and yield models for loblolly pine. *Forest Science* 9(3): 354-371.
- Curtis, Robert O. 1970. Stand density measures: an interpretation. *Forest Science* 16(4): 403-414.
- Curtis, Robert O. and Donald L. Reukema. 1970. Crown development and site estimates in a Douglas-fir plantation spacing test. *Forest Science* 16(3): 287-301.
- Dahms, Walter G. 1966. Relationship of lodgepole pine volume increment to Crown Competition Factor, basal area, and site index. *Forest Science* 12(1): 74-82.
- Duff, G. H. and N. J. Nolan. 1953. Growth and morphogenesis in the Canadian forest species. I. The controls of cambial and apical activity in red pine. *Canadian Journal of Botany* 31: 471-513.
- Farrar, J.L. 1961. Longitudinal variation in the thickness of the annual ring. *Forest Chronical* 37: 323-349.
- Gerrard, Douglas J. 1967. Competition quotient: an index of the competitive stress affecting individual forest trees. Ph.D. thesis, Michigan State University. 64 pp.
- King, James E. 1966. Site index curves for Douglas-fir in the Pacific Northwest. Weyerhaeuser Forestry Paper No. 8. Forestry Research Center, Centralia, Washington. 49 pp.
- Krajicek, J. E., K. A. Brinkman and S. F. Gingrich. 1961. Crown competition--a measure of density. *Forest Science* 7(1): 35 - 42.
- Larson, P. R. 1962. Auxin gradients and the regulation of cambial activity. *In: Tree growth*. edited by T.T. Kozlowski. Ronald Press Co. pp. 97-118.
- \_\_\_\_\_. 1963. Stem form development of forest trees. *Forest Science Monograph* 5. 42 pp.

- Leary, Rolfe Albert. 1968. A multi-dimensional model of even-aged forest growth. Ph.D. thesis. Purdue University.
- Lee, Yam (Jim). 1967. Stand models for lodgepole pine and limits to their application. U.B.C. Faculty of Forestry. Ph.D. thesis. 332 pp.
- Lin, Jim. 1969. Growing spacing index and stand simulation of young western hemlock in Oregon. Ph.D. thesis, Duke University School of Forestry. 182 pp.
- Mitchell, K. J. 1969. Simulation of the growth of even-aged stands of white spruce. School of Forestry, Yale University, New Haven, Connecticut. Bulletin No. 75. 48 pp.
- Myers, Clifford A. 1968. Simulating the management of even-aged timber stands. USDA Forest Service Res. Paper RM-42, Rocky Mountain Forest and Range Expt. Sta. (Revised 1969).
- Newnham, R. M. 1964. The development of a stand model for Douglas-fir. Ph.D. thesis, University of British Columbia. 201 pp.
- Paille, G. 1970. Description and prediction of mortality in some coastal Douglas-fir stands. Ph.D. thesis. U.B.C. Faculty of Forestry. 300 pp.
- Opie, Jack E. 1968. Predictability of individual tree growth using various definitions of competing basal area. Forest Science 14(3): 314-323.
- Reukema, Donald L. 1961. Crown development and its effect on stem growth of six Douglas-firs. Journal of Forestry 59: 370-371.
- \_\_\_\_\_. 1970. Forty-year development of Douglas-fir stands planted at various spacings. USDA Forest Service Res. Paper PNW-100, Pacific Northwest Forest and Range Expt. Sta. 21pp.
- Spurr, Steven H. 1962. A measure of point density. Forest Science 8: 85 - 96.
- Staebler, G. R. 1951. Growth and spacing in an even-aged stand of Douglas-fir. Unpublished M.F. thesis, University of Michigan.
- Vezina, P. E. 1963. More about the Crown Competition Factor. Forestry Chronicle. 39(3): 313-317.
- Wiedemann, E. 1932. Die Rotbuche, 1931. Mitt. aus Forstwirtschaft und Forstwissenschaft, III (96-285).

## APPENDICES

APPENDIX I  
CROWN AREA OVERLAP

Formulas for determining crown area overlap between two competing tree crowns where:

- d = distance, in feet, between two competing tree centers
- $r_1$  = radius, in feet, of the larger crown
- $r_2$  = radius, in feet, of the smaller crown
- $\theta$  = angle of incidence of the two crowns measured from the larger crown
- $x_1 = (r_1^2 - r_2^2 + d^2) / 2d$
- $x_2 = d - x_1$

The derivation of the overlap formula is as follows for conditions where d is greater than  $x_1$ : (as in Gerrard, 1967)

$$\text{Area ABD} = x_1 \sqrt{r_1^2 - x_1^2}$$

$$\text{Area ABCD} = r_1^2 \cos^{-1}(x_1/r_1)$$

$$\text{Area BCD} = r_1^2 \cos^{-1}(x_1/r_1) - x_1 \sqrt{r_1^2 - x_1^2}$$

$$\text{Area of Overlap} = r_1^2 \cos^{-1}(x_1/r_1) + r_2^2 \cos^{-1}(x_2/r_2) - d \sqrt{r_1^2 - x_1^2}$$

Since the computer handles sine more efficiently than cosine, the following transformation is applied:

$$r_i^2 \cos^{-1}(x_i/r_i) = \pi r_i^2 / 2 - r_i^2 \sin^{-1}(x_i/r_i)$$

Therefore:

$$\begin{aligned} \text{Area of Overlap} = & \frac{\pi}{2} (r_1^2 + r_2^2) - [d \sqrt{r_1^2 - x_1^2} + r_1^2 \sin^{-1}(x_1/r_1) \\ & + r_2^2 \sin^{-1}(x_2/r_2)] \end{aligned}$$

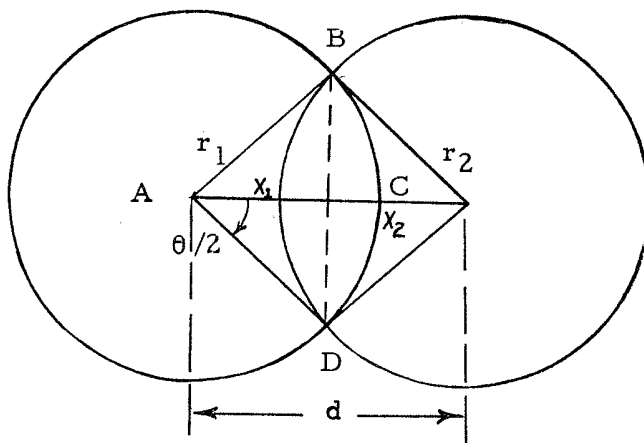

In cases where  $x_1$  is greater than  $d$  the equation changes to the form:

$$\text{Area of Overlap} = \frac{\pi}{2} (r_2^2 + r_1^2) + r_2^2 \sin^{-1}(x_2/r_2) - r_1^2 \sin^{-1}(x_1/r_1) \\ + x_2 \sqrt{r_2^2 - x_2^2} - x_1 \sqrt{r_1^2 - x_1^2}$$

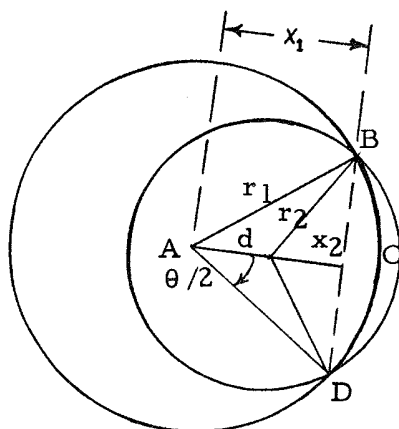

## APPENDIX II

## SAMPLING FOR AN INDEX OF TOLERANCE

Commercial tree species have long been characterized according to their relative tolerance to reduction in light quality and quantity. Various levels of tolerance, however, have never been related to an unbiased measurement scheme. Since it was necessary in this study to rely on a sound basis for tolerance, a new measurement system was devised.

In the description of intertree competition, Crown Competition Quotient (CCQ) as defined is equal to 100 when the crowns of neighboring trees do not touch. As crowns overlap, competition becomes more severe and eventually exceeds the tolerance limit for Douglas-fir. In uniform undisturbed stands, it has been commonly observed that the base of the live crowns form a horizontal plane through the forest. Upon investigation, estimates of competition at crown base could be made by measuring the stem diameters at crown base of all trees on a large plot. Potential crown widths were calculated and an estimate of competition derived. Since the number of trees within a unit area is necessary to measure competition, the plot must be large to increase the number of trees relative to the number with crowns extending beyond the plot boundary.

A sampling system such as described above is tedious and time-consuming. A single estimate of competition requires measuring 50-100 diameters on a plot at least 1/5 acre in size. An alternative sampling system was created to reduce the number of trees to be measured and to do away with crowns extending outside plot boundaries. A sample with probability proportional to stem area at crown base will accomplish



these objectives. The estimator for Crown Competition Quotient is:

$$\hat{T}_y = \sum y_i / P_i$$

where

$$y_i = \frac{\pi D_i^2 (100)}{4(43560)}, \text{ maximum crown area of the } i\text{th tree as a per cent of one acre}$$

$D_i$  = Maximum crown diameter as a function of stem diameter on the  $i$ th tree at crown base

$$P_i = \frac{x_i \text{CSC}^2\left(\frac{\theta}{2}\right)}{43560}, \text{ inclusion probability of the } i\text{th tree in the sample}$$

$x_i$  = stem area, in square feet, of the  $i$ th tree at crown base

$\theta$  = horizontal angle of predetermined size which defines the size of the imaginary circle for a given sized tree

Therefore,

$$\begin{aligned} \hat{T}_y &= \sum \frac{y_i 43560}{x_i \text{CSC}^2\left(\frac{\theta}{2}\right)} \\ &= F \sum y_i / x_i \end{aligned}$$

where

$$F = \frac{43560}{\text{CSC}^2\left(\frac{\theta}{2}\right)}, \text{ basal area factor}$$

Given that  $n$  samples are taken in a stand the estimator takes the form

$$\hat{T}_y = \frac{F}{n} \sum_{j=1}^n \left[ \sum_{i=1}^n y_{ij} / x_{ij} \right]$$

In applying the theory to measuring competition at crown base in stands, a dominant or co-dominant tree was arbitrarily chosen in a homogeneous, undisturbed portion of the stand. This tree con-

stituted the sample point and in effect competition was measured for this tree by the sample. A 10-basal area factor was used because it approximated an imaginary circle about equal to the maximum crown width for the sampled stem diameter. A McClure mirror caliper was used to measure stem diameter at crown base for all possible competitors, including the central tree. The McClure caliper was most efficient for this sample because most diameters are small and the horizontal range from the measurement point need not be known. Stem diameter was input into a table of limiting distances to determine which trees were in the sample. Horizontal distances among trees were then measured on the ground. Height and age were also measured on a dominant tree within or near the sample. Site index was subsequently determined for input into an analysis to test for interaction between Crown Competition Quotient and site, age and height.

## APPENDIX III

## FLOW CHART OF PROGRAM

## Program Stand

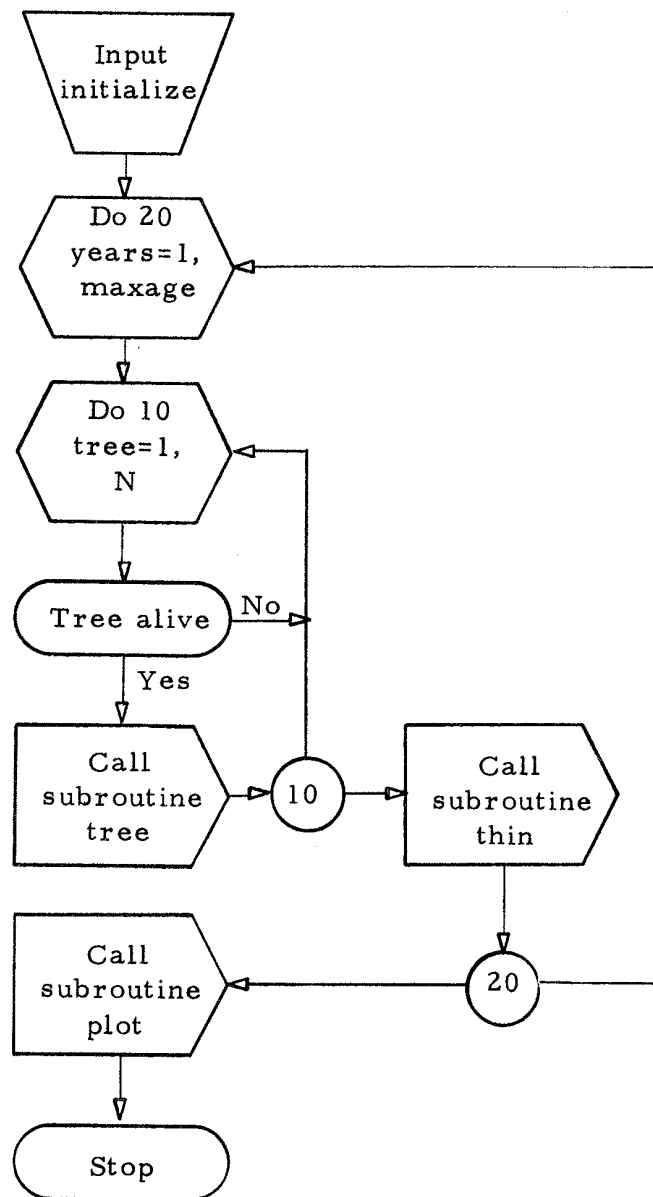

## Subroutine Tree

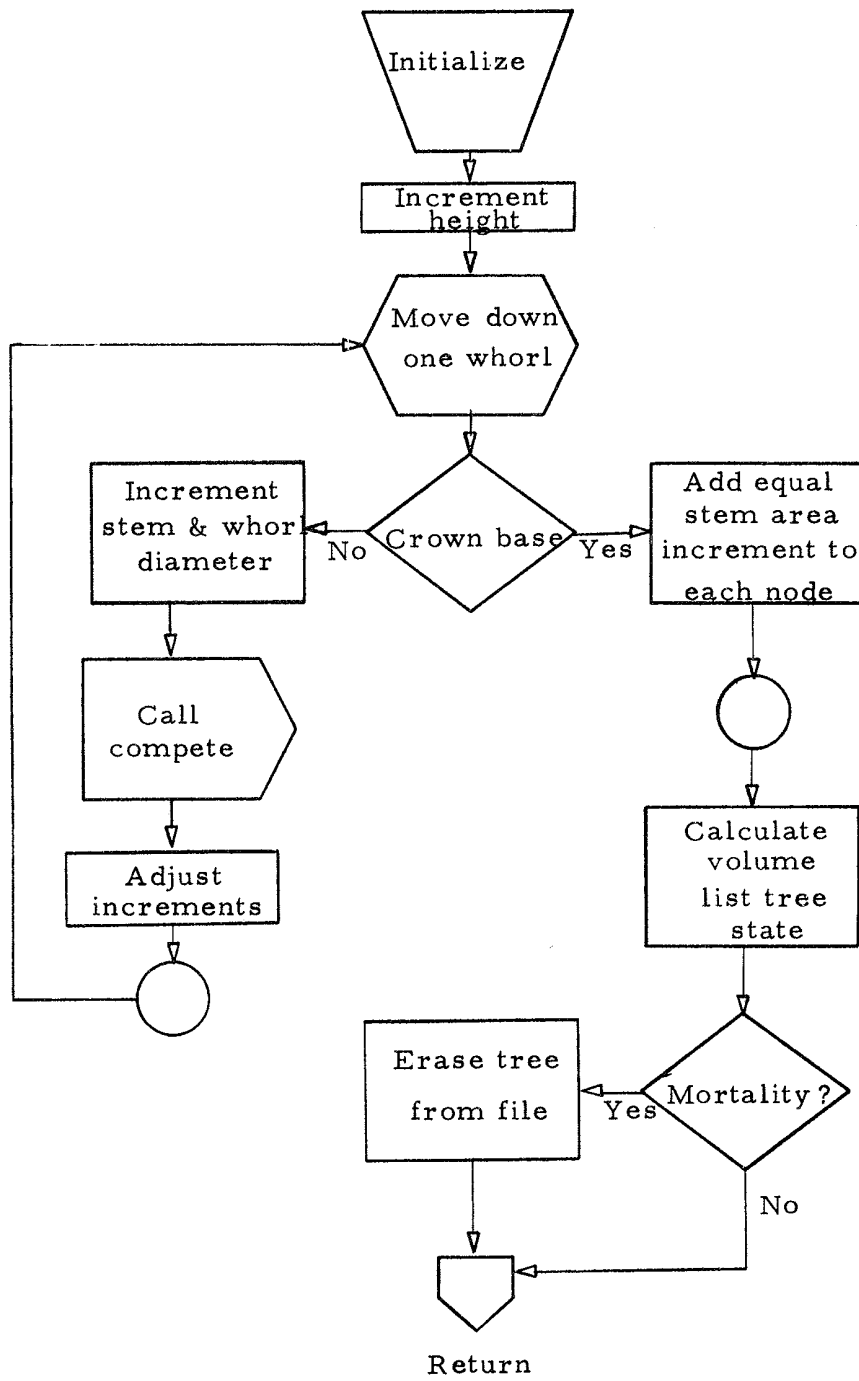

## Subroutine Compete

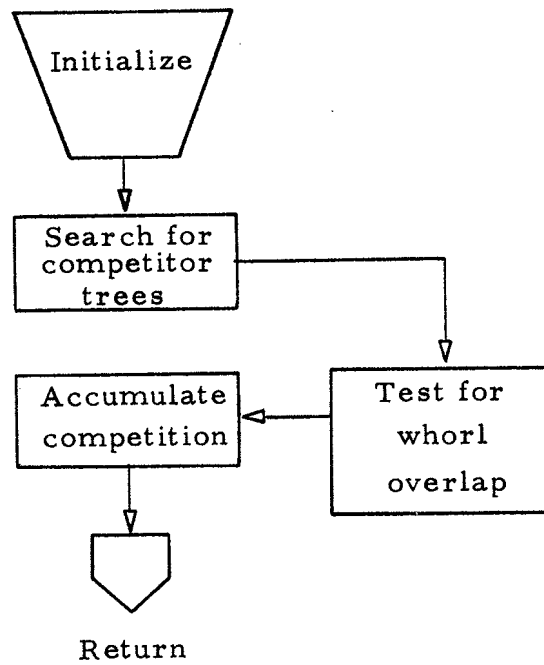

## Subroutine Plott

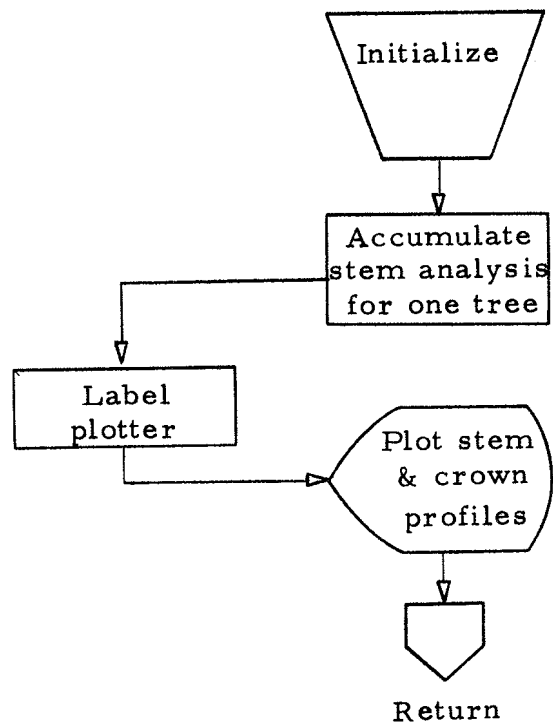

## Subroutine Thin

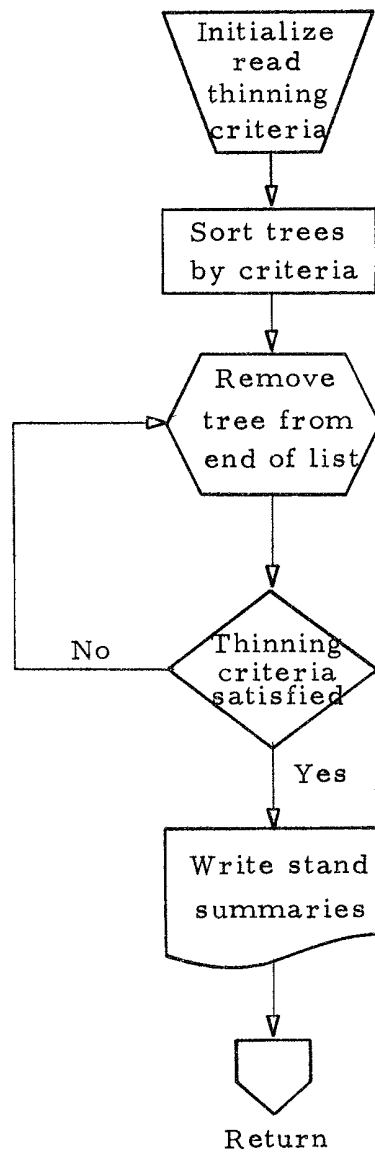

## APPENDIX IV

## COMPARISON OF CCF TO COMPETITION QUOTIENT (GERRARD)

$$CCF = \frac{100 \sum_{j=1}^n A_j}{43560 B} \qquad CQ = \frac{\sum_{i=1}^k a_{ij}}{A_j}$$

where

$A_j$  = estimated open-grown crown area of the jth tree of specified  
DOB

$B$  = number of acres in the sample.

Gerrard's ratio is based on assumed open-grown crown area for specified DOB's. This comparison assumes closed stands.

$$\begin{aligned} CCF &= \frac{100}{43560 B} \sum_{j=1}^n (A_j - \sum_{i=1}^k a_{ij} + \sum_{i=1}^k a_{ij}) \\ &= \frac{100}{43560 B} \sum_{j=1}^n (A_j - \sum_{i=1}^k a_{ij}) + \frac{100 \sum_{j=1}^n \sum_{i=1}^k a_{ij}}{43560 B} \\ &= 100 + 100 \sum_{j=1}^n \frac{\sum_{i=1}^k a_{ij}}{43560 B} \end{aligned}$$

where

$a_{ij}$  = estimated open-grown crown area overlap by the ith  
competitor on the jth tree

$\frac{\sum_{j=1}^n \sum_{i=1}^k a_{ij}}{43560 B}$  = Competition Quotient on a per acre basis for assumed  
open-grown crown area of each tree

where

$B = \frac{A_j}{43560}$ , proportion of one acre occupied by the jth tree

$n = 1$

Therefore:

$$\hat{CCF} = 100 + 100(CQ) \text{ for } CCF > 100$$