

Utah State University

DigitalCommons@USU

---

Reports

Utah Water Research Laboratory

---

January 1976

## Application of a Hydrologic Model to the Planning and Design of Storm Drainage Systems for Urban Areas

George B. Shih

Eugene K. Israelsen

Robert N. Parnell, Jr.

J. Paul Riley

Follow this and additional works at: [https://digitalcommons.usu.edu/water\\_rep](https://digitalcommons.usu.edu/water_rep)



Part of the [Civil and Environmental Engineering Commons](#), and the [Water Resource Management Commons](#)

---

### Recommended Citation

Shih, George B.; Israelsen, Eugene K.; Parnell, Jr., Robert N.; and Riley, J. Paul, "Application of a Hydrologic Model to the Planning and Design of Storm Drainage Systems for Urban Areas" (1976). *Reports*. Paper 106.

[https://digitalcommons.usu.edu/water\\_rep/106](https://digitalcommons.usu.edu/water_rep/106)

This Report is brought to you for free and open access by the Utah Water Research Laboratory at DigitalCommons@USU. It has been accepted for inclusion in Reports by an authorized administrator of DigitalCommons@USU. For more information, please contact [digitalcommons@usu.edu](mailto:digitalcommons@usu.edu).



**APPLICATION OF A HYDROLOGIC MODEL TO THE  
PLANNING AND DESIGN OF STORM DRAINAGE  
SYSTEMS FOR URBAN AREAS**

by

**George B. Shih  
Eugene K. Israelsen  
Robert N. Parnell, Jr.  
J. Paul Riley**

**The work reported by this project completion report was supported in part with funds  
provided by the Department of the Interior, Office of Water Research and  
Technology under P. L. 88-379, Project Number B-048-Utah,  
Agreement Number 14-31-0001-3341, Investigation Period  
July 1, 1970 to June 30, 1972**

**Utah Water Research Laboratory  
College of Engineering  
Utah State University  
Logan, Utah 84322**

**May 1976**

**PRWG86-1**



## ABSTRACT

A generally applicable hybrid computer program is developed to simulate runoff from urban watersheds, and is applied to represent the outflow hydrographs of three urban watersheds located within Salt Lake County, Utah. The gaged outflow of the watersheds provided a means for comparing the observed and the simulated final outflow hydrographs.

Each of the three watersheds was subdivided into spatial units or subzones, and the outflow hydrographs for each subzone were obtained by abstracting interception, infiltration, and depression storage from the rainfall hyetograph of each subzone. The resulting hydrograph outflow of each subzone then was routed to the Jordan River, the final outflow point of the three watersheds. The final hydrographs of the three watersheds were combined and compared with the gaged flow.

The unique features of this model are its ability to (1) accept a wide range of input hyetographs, (2) accommodate variable loss rates, (3) combine subzone hydrographs, and (4) combine watershed hydrographs into a single runoff function. In addition to numerical output, graphs can be plotted for visual inspection. This characteristic enables designers and planners to use the model to examine quickly both the physical and economic impacts of various possible input conditions and management alternatives.

An economic analysis follows the hydrologic study. Areas subject to flooding within the study watersheds were mapped and measured in accordance with peak discharge rates. Flood damages per unit area are estimated as a function of degree of urbanization. Projected population growth within the area is used as a basis for estimating the rate of urbanization over the next 100 years. From this relationship and functions of peak flow versus frequency, damage versus frequency curves are proposed for various levels of urbanization, and thus for various points in time within a planning horizon of 100 years. The utility of the procedure (which depends heavily upon the hydrologic model) for design and planning purposes is demonstrated through an example of a benefit-cost analysis which is applied to a proposed flood control structure within a portion of the study area.

The study emphasizes that reliable planning and management solutions from the modeling approach depend heavily upon the availability of adequate and accurate field data. For this reason, "barometer" urban hydrology watersheds situated at strategic locations throughout the nation would provide invaluable information for the broad application of this procedure. In addition, it is considered that future work also should emphasize the expansion of the model to include the economic dimension, and ultimately various aspects of the social dimension.

Shih, George B., Eugene K. Israelsen, Robert N. Parnell, Jr., and J. Paul Riley. Application of a hydrologic model to the planning and design of storm drainage systems for urban areas. Research Project Technical Completion Report to the Office of Water Research and Technology, Department of the Interior, Washington, D. C.

**KEYWORDS**--hydrologic model/flood model/economic model/water structure design/water resources planning and management.

## ACKNOWLEDGMENTS

This publication represents the final report of a project which was supported in part with funds provided by the Office of Water Research and Technology of the United States Department of the Interior as authorized under the Water Resources Research Act of 1964, Public Law 88-379. The work was accomplished by personnel of the Utah Water Research Laboratory in accordance with a research proposal which was submitted to the Office of Water Research and Technology through the Utah Center for Water Resources Research at Utah State University. The University is the institution designated to administer the programs of the Office of Water Research and Technology in Utah.

The authors express gratitude to all others who contributed to the success of this study. Special thanks are extended to Mr. Lee J. McQuivey of the U.S. Corps of Engineers, and personnel from the Salt Lake City, Salt Lake County, and the U.S. Geological Survey for direction and assistance in assembling the data required to perform this study. Gratitude is also expressed to Dr. Jay C. Andersen, Dr. Trevor C. Hughes, and Dr. Jim Mulder for their careful and constructive review of the manuscript. Their comments contributed much to the content of the report.

George B. Shih  
Eugene K. Israelsen  
Robert N. Parnell, Jr.  
J. Paul Riley

## TABLE OF CONTENTS

Chapter		Page
I	INTRODUCTION . . . . .	1
	Brief Description of the Study Objectives and Procedures . . . . .	1
	Objectives . . . . .	1
	Procedures . . . . .	1
	Organization of the Report . . . . .	2
II	THE HYDROLOGIC MODEL . . . . .	5
	The Conceptual Model of the Urban Hydrologic System . . . . .	5
	The hydrologic balance . . . . .	5
	Time and spatial resolution . . . . .	8
	System Processes . . . . .	8
	Precipitation . . . . .	8
	Surface water inflows . . . . .	8
	Interception . . . . .	10
	Infiltration . . . . .	10
	Surface depression storage . . . . .	10
	Hydrograph of rainfall excess . . . . .	11
	Overland-channel routing . . . . .	11
	Channel routing . . . . .	12
	Derivation of lag time . . . . .	12
III	THE STUDY AREA . . . . .	15
	Location of the Study Area . . . . .	15
	Physical Characteristics of the Study Area . . . . .	15
	Topography . . . . .	15
	Geology . . . . .	15
	Degree of urbanization within the study area . . . . .	19
	Hydrologic Characteristics of the Study Area . . . . .	24
	Climate . . . . .	24
	Flood characteristics . . . . .	24
	Drainage conditions . . . . .	26
	Instrumentation . . . . .	26
IV	THE COMPUTER MODEL OF THE HYDROLOGIC SYSTEM. . . . .	31
	Digital Programs . . . . .	31
	Program WATMOD . . . . .	31

**TABLE OF CONTENTS (Continued)**

<b>Chapter</b>		<b>Page</b>
	Analog Program . . . . .	34
	Precipitation . . . . .	34
	Interception . . . . .	34
	Infiltration . . . . .	34
	Depression storage . . . . .	34
	Overland-channel routing . . . . .	34
	Channel flow routing . . . . .	34
	The outflow hydrograph . . . . .	34
	Time scaling . . . . .	36
	Amplitude scaling . . . . .	38
V	APPLICATION OF THE HYDROLOGIC MODEL TO THE URBAN WATERSHED . . . . .	41
	Model Verification . . . . .	41
VI	ECONOMIC ANALYSIS . . . . .	49
	Population Projection . . . . .	49
	Per Capita Income Projection . . . . .	49
	Area Flooded versus Stream Discharge . . . . .	49
	Rate of Urbanization . . . . .	50
	Projection of Flood Damage as a Function of Time . . . . .	51
	An Application Example . . . . .	56
VII	SUMMARY AND CONCLUSIONS . . . . .	65
	REFERENCES . . . . .	67
	APPENDIX A	
	Digital Computer Program "URBPARG" for Calculating the Percent Impervious Area, $C_f$ , and the Characteristic Impervious Length Factor, $L_f$ . Sample Output for the Mill Creek and the Big Cotton- wood Urban Watersheds Within Salt Lake County, Utah, also is Given . . . . .	71
	APPENDIX B	
	Digital Computer Program "WATMOD" with Subroutine "ANALOG" for Preparing the Input Data (Precipitation and Stream Inflow), Calculating Coefficients for Evaluating Watershed Zones, and Controlling the Analog Computer. Subroutine "Print" also is Included. . . . .	73

## LIST OF FIGURES

Figure		Page
1.1	Hypothetical curves for typical flood frequency protection and damage relationships . . . . .	3
1.2	A three-dimensional plot of Figure 1.1(d) showing flood damages as a function of design period and degree of urbanization . . . . .	4
2.1	Schematic representation for obtaining runoff hydrograph . . . . .	6
2.2	Schematic flow diagram of the hydrologic system . . . . .	7
2.3	Schematic diagram of an urban subwatershed model . . . . .	9
2.4	Schematic flow chart for obtaining hydrograph of rainfall excess . . . . .	11
3.1	The watershed within Salt Lake County, Utah . . . . .	16
3.2	The urbanized study area . . . . .	17
3.3	The general topography of the study area . . . . .	18
3.4	Dividing the watersheds into subzones. . . . .	20
3.5	Typical urban residential block showing the pervious and the impervious areas . . . . .	21
3.6	A sample of dividing subzones into smaller spatial units . . . . .	22
3.7	Sketch illustrating the characteristic impervious length, $L_f$ , for a given watershed or subzone . . . . .	23
3.8	Isolines of annual and summer precipitation on the east bench area of Salt Lake County (after Kaliser, 1973) . . . . .	26
3.9	A typical distribution of runoff from snowmelt and convective storms for small watersheds . . . . .	27
3.10	Hydrologic instrumentation and the Thiessen polygons for precipitation analysis within the study area . . . . .	29
4.1	Flow diagram of the WATMOD program . . . . .	32
4.2	Flow diagram of WATMOD subroutine program analog . . . . .	33
4.3	Schematic diagram of the analog computer program . . . . .	35
4.4	Analog circuit for generating the expression for interception rate . . . . .	36
4.5	Analog circuit for generating the expression for infiltration rate . . . . .	36
4.6	Analog circuit for generating the expression for inflow rate into depression storage . . . . .	37



## LIST OF FIGURES (Continued)

Figure		Page
4.7	Analog circuit for obtaining the subwatershed outflow hydrograph $t_R$ is the time of rise of storm drain inlet time . . . . .	37
4.8	Analog circuit for channel routing . . . . .	37
4.9	Analog circuit for scaling the final outflow and total volume of outflow . . . . .	38
5.1	Isohyetal lines for the event of May 22-23, 1968 . . . . .	42
5.2	A comparison between observed and computed outflow hydrographs from the study area in the Jordan River for the storm event of May 23, 1968 . . . . .	44
5.3	Peak discharge rate for Mill Creek as a function of return frequency at different levels of urbanization . . . . .	45
5.4	Peak discharge rate for Big Cottonwood Creek as a function of return frequency at different levels of urbanization . . . . .	46
5.5	Peak discharge rate for Little Cottonwood Creek as a function of return frequency at different levels of urbanization . . . . .	47
6.1	Population projection for Salt Lake County . . . . .	50
6.2	Per capita income projection for the Salt Lake City area . . . . .	51
6.3	Relationships between discharge rates and flooded area for various streams within the study area . . . . .	52
6.4	Relationship between population density and percentage urbanization for the Chicago area (from Hydrocomp International (1971)) . . . . .	53
6.5	Projected urbanization as a function of time for the study area . . . . .	54
6.6	Estimated flood damages per unit area as a function of urbanization level . . . . .	55
6.7a	Projected flood damages as a function of event frequency for various levels of urbanization (or time horizon) from Big Cottonwood Creek . . . . .	57
6.7b	Estimated average annual flood damages as a function of time from Big Cottonwood Creek . . . . .	57
6.8a	Projected flood damages as a function of event frequency for various levels of urbanization (or time horizon) from Little Cottonwood Creek . . . . .	58

### LIST OF FIGURES (Continued)

Figure		Page
6.8b	Estimated average annual flood damages as a function of time from Little Cottonwood Creek . . . . .	58
6.9a	Projected flood damages as a function of event frequency for various levels of urbanization (or time horizon) from Mill Creek . . . . .	59
6.9b	Estimated average annual flood damages as a function of time from Mill Creek . . . . .	59
6.10	Peak discharge rate for Big Cottonwood Creek as a function of return frequency at different levels of urbanization and as modified by the impounding reservoir . . . . .	60
6.11a	Projected flood damages as a function of event frequency for various levels of urbanization (or time horizon) from Big Cottonwood Creek flows as modified by an impounding reservoir . . . . .	62
6.11b	Estimated average annual flood damages as a function of time for modified and unmodified flows from Big Cottonwood Creek . . . . .	62
6.12	Estimated average annual flood damage reduction as a function of time from the impoundment reservoir on Big Cottonwood Creek . . . . .	63

### LIST OF TABLES

Table		Page
3.1	Physical characteristics for the Mill Creek, Big Cottonwood Creek, and Little Cottonwood Creek drainages. . . . .	24
3.2	Characteristics of the main drainage channels of Mill, Big Cottonwood, and Little Cottonwood Creeks within the study area . . . . .	28
4.1	Summary of the attenuators (pot) settings on the analog computer . . . . .	39
5.1	A comparison of precipitation and computed runoff rates corresponding to rainfall events of specific frequencies within the study area . . . . .	48
6.1	Benefit-cost calculations for a proposed runoff impounding reservoir on Big Cottonwood Creek . . . . .	63



## CHAPTER I

### INTRODUCTION

With the growth of population throughout the world effective urban planning and management are becoming increasingly necessary. Demographers predict a population of 320 million persons within the United States by the year 2000, and more than 90 percent of this total is expected to reside in urban areas which occupy only a few percent of the total national geographic area (ASCE Urban Hydrology Research Council, 1968). Urban development is accompanied by an associated property damage potential from flooding conditions. In 1966 the American Public Works Association (APWA) estimated that flood damage to both real and personal property within urban areas of the United States exceeds \$1 billion per year. No doubt this figure has risen since that time. For this reason, the need to consider hydrologic problems is well recognized by today's urban planners. APWA (1966) estimates of expenditures before the year 2000 for storm drainage facilities to serve the rapidly-expanding urban population exceed \$25 billion. Because drainage structures are costly to install and maintain, economics have motivated the search for improved methods of hydrologic analysis and more efficient procedures for the design and operation of urban drainage systems.

An urban watershed may be defined as a catchment area in which the natural stream channels are supplemented with or replaced by a system of artificial drainage works, including paved gutters and storm sewers. Although it is difficult to describe the usual urban drainage system in quantitative terms, a systematic approach to the hydrologic problems associated with a particular urban watershed requires some form of descriptive quantification. An effective approach involves the development of an adequate mathematical description of the various hydrologic processes and a practical method of incorporating the mathematical equations into a model which simulates the physical system. In this study a model of this nature is applied to a particular drainage area in Salt Lake County, and the model is used to examine the effects of urban development on the runoff characteristics from the area.

### Brief Description of the Study Objectives and Procedures

#### Objectives

The general objective of this study is to propose and demonstrate a general and useful technique which can be readily applied by municipal engineers and decision-makers for the planning and design of urban storm drainage systems. The utility of the technique is demonstrated for a specific site, and some sample design curves are presented. Design criteria are not included as part of this report; rather, emphasis is placed on the development of a suitable and generally applicable methodology.

The specific or procedural objectives of this study are as follows:

1. To apply an existing urban hydrology model to a specific study area, and to use this model to generate runoff rates from the study area corresponding to storm events of known frequencies and various levels of urbanization. The model reported by Narayana et al. (1969) and Evelyn et al. (1970) is used in this study.
2. To develop a procedure for relating the dependent economics or risk evaluation parameters to the basic or independent variables, such as flood magnitude, flood frequency, and site conditions, including degree of urbanization.
3. To propose a procedure based on the results of the second objective above which will permit the selection of a design criteria that will minimize the costs of the associated risk and non-risk factors for various levels of urbanization.

#### Procedures

The following is a brief description of the general procedures that were envisioned for this study. However, because of the difficulty which was encountered in obtaining reliable estimates of damage (risk) costs

and construction (non-risk) costs, some simplification of this procedure was necessary in its actual application to the study area. In the steps which follow, reference is made to Figure 1.1.

1. The urban hydrologic system of the study area is modeled. Although the model has been reported by Evelyn et al. (1970), for the sake of completeness, it is again described briefly in Chapter II of this report.

2. The hydrologic model, then, is used to generate outflow rates from the study area for storm events of known frequencies and for various degrees of urbanization. From these data, discharge versus frequency relationships are developed for specific points in the drainage channels (Figure 1.1(a)).

3. From the available records, functions are developed which relate streamflow discharge to flooded area (Figure 1.1(b)).

4. The economic dimension is introduced by developing damage curves based upon flooded area, and thus upon streamflow rate (from Figure 1.1(b)). These curves relate the level of protection (or design return period) to average annual damage costs (risk costs) and to costs associated with the flood control structures (non-risk costs). For risk costs, these relations also might be constructed to reflect in the third dimension, the influence of the degree of urbanization (Figure 1.1(c)). For a particular frequency of design flood, damages or risk costs usually increase with increasing levels of urbanization.

5. The "streamflow rate" scale on Figure 1.1(c) is changed to "flood frequency" by applying Figure 1.1(a) to obtain Figure 1.1(d). This figure indicates risk costs as a function of flood frequency for different degrees of protection (non-risk costs) and

various levels of urbanization. A three-dimensional plot of Figure 1.1(d) is shown by Figure 1.2.

6. The functions illustrated as Figure 1.1(d) are differentiated to produce those of Figure 1.1(e). On the basis of the marginal theory of economics, the most efficient storm system design in terms of economic considerations occurs at that design frequency for which the incremental non-risk cost is equal to the incremental risk cost. This point is illustrated by Figure 1.1(f) as being that at which two curves cross (the curves of this figure are the derivatives of those of Figure 1.1(e)). Thus, depending upon the degree of urbanization, a series of points are shown at which the marginal benefit-cost ratio is equal to unity, and from this series of points a relationship similar to that illustrated by Figure 1.1(g) can be developed. It is possible for planners and designers to use a curve of this nature as a basis for selecting a design return period for any particular level of urbanization within the study area.

## Organization of the Report

The report is organized into seven chapters. A brief review of urban watershed modeling studies is given in this chapter. Chapter II gives the development of the hydrologic model, and Chapter III illustrates the watershed study area. Computer programming is discussed in Chapter IV. Application of the model to the watersheds is the subject of Chapter V, which also presents plots to illustrate the effects of urbanization on flood flows of particular frequencies. Chapter VI is concerned with the economic analysis and includes a specific example of the application of the technique to a portion of the study area. Finally, Chapter VII contains the summary and recommendations of this study.

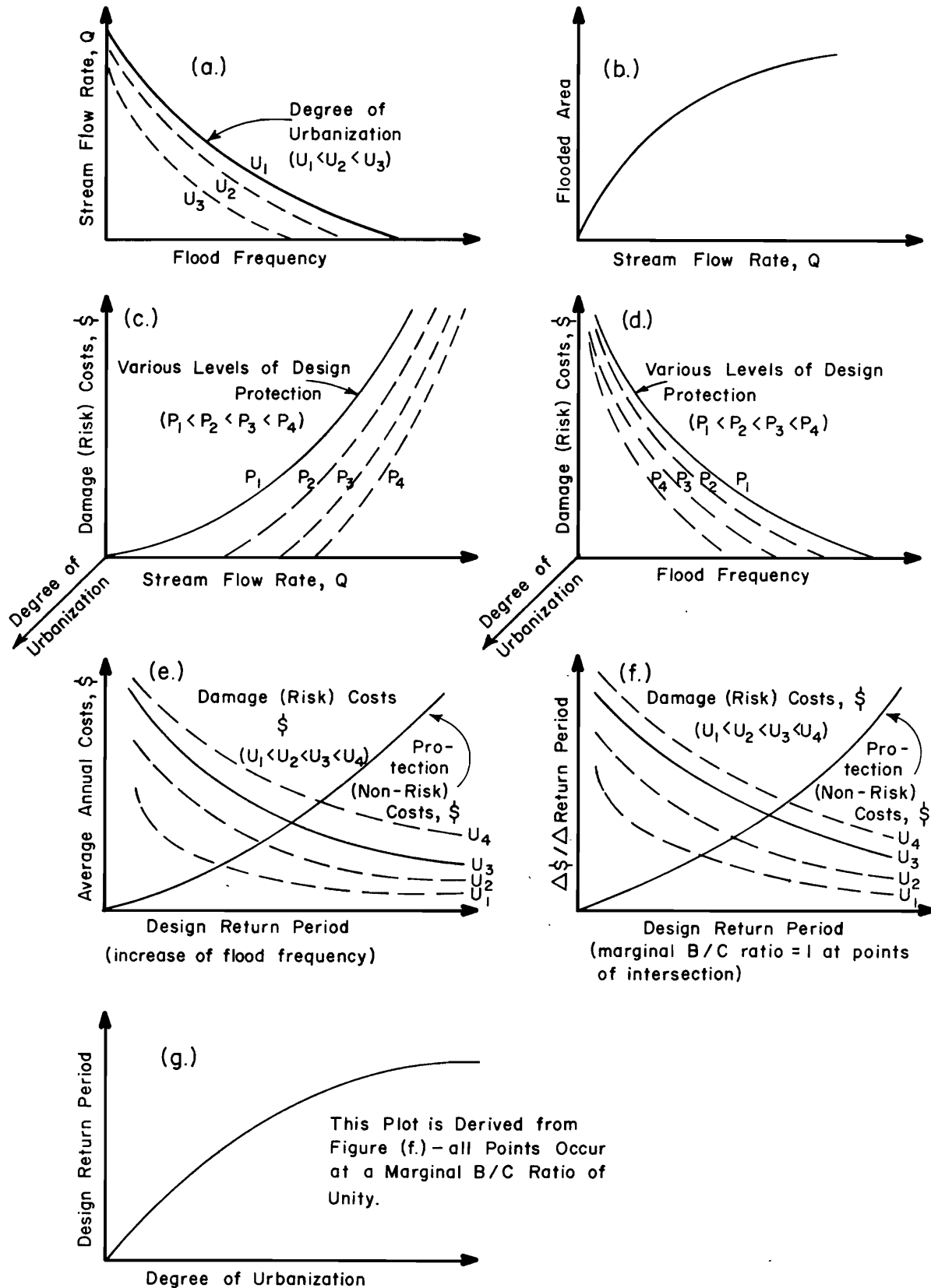

Figure 1.1. Hypothetical curves for typical flood frequency protection and damage relationships.

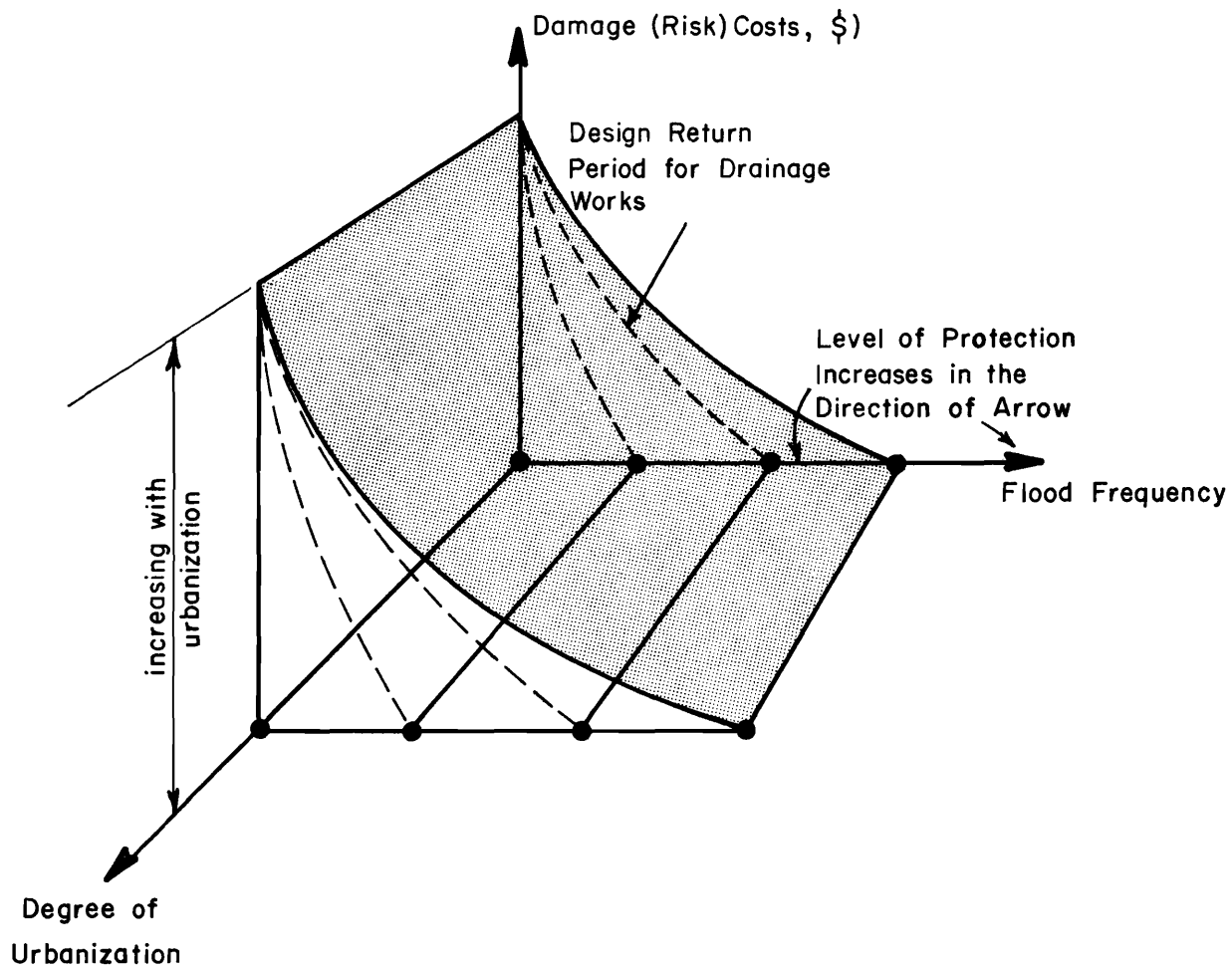

Figure 1.2. A three-dimensional plot of Figure 1.1(d) showing flood damages as a function of design period and degree of urbanization.

## CHAPTER II

### THE HYDROLOGIC MODEL

A primary objective of effective watershed management is to provide optimum benefits to mankind under a range of land use patterns. For example, it is frequently necessary to manage a municipal watershed so as to integrate many of the requirements of a modern community such as residential housing, business locations, water supply, sewage disposal, and recreation. Land uses in an urban area become drastically different from those of natural conditions. Thus, the watershed manager is faced with the need to predict system responses under various possible use alternatives. One approach to this problem is to apply the technique of computer simulation, whereby a quantitative mathematical model is developed for predicting the behavior of the system. In the study reported here, a computer model is used to simulate the hydrologic responses of an urban watershed, emphasizing the measurable variables related to the effects of urbanization. The model represents the interrelated processes of the system by functions which describe the different components of physical phenomena on the watershed. Thus, the model is a useful tool for the creative manipulation of the system, and it also facilitates appraisals of proposed changes within the corresponding prototype.

#### The Conceptual Model of the Urban Hydrologic System

The hydrologic model utilized in this study is a modified version of that developed in earlier studies involving the computer simulation of urban watersheds (Narayana et al., 1969, and Evelyn et al., 1970). The basis of the hydrologic model is a fundamental and logical mathematical representation of the various hydrologic processes and routing functions. These physical processes are not specific to any particular geography, but rather are applicable to any hydrologic unit, including the subbasins located within the Salt Lake County study area.

The outflow hydrograph is computed in the model by chronologically deducting from precipitation and streamflow input functions losses due to interception, infiltration, and depression storage and then routing the remainder through surface and channel storages

(Figure 2.1). Testing and verification of the basic mathematical model is done by using observed rainfall and runoff data from instrumented runoff areas. In the verification process coefficients representing interception, depression storage, and infiltration are determined by the trial and error process on the computer such that the outflow hydrograph predicted by the model is nearly identical to the corresponding measured hydrograph from the prototype. Relationships between these coefficients and various urbanization characteristics or parameters, such as percent impervious cover, are established. These relationships can be applied in predicting the effects of future urban development. A schematic flow diagram of a typical hydrologic system is shown by Figure 2.2. Because of the short time increment involved in urban runoff events, it usually is necessary to be concerned only with the surface runoff component of the system. For this reason, processes concerned with groundwater storage and movement and evapotranspiration are not included in the hydrologic model of this study. Those transfer processes and storage locations included within the model are shown within the dotted line of Figure 2.2.

Experimental and analytical results are used whenever possible to assist in establishing and testing some of the mathematical relationships included within the model. Average values of hydrologic quantities needed for operation of the hydrologic model are estimated in one of three ways: (1) from available data; (2) by statistical correlation techniques; and (3) through calibration of the model itself.

#### The hydrologic balance

A dynamic system consists of three basic components, namely, the medium or media acted upon, a set of constraints, and an energy supply or driving force. In a hydrologic system, water in any one of its three physical states is the medium of interest. The constraints are applied by the physical nature of the hydrologic basin, and the driving forces are supplied by direct solar energy, gravity, and capillary potential fields. The various functions and operations of the different parts of the system are interrelated by the concepts of continuity of mass and momentum. Unless relatively high velocities are encountered, such as in channel flow,



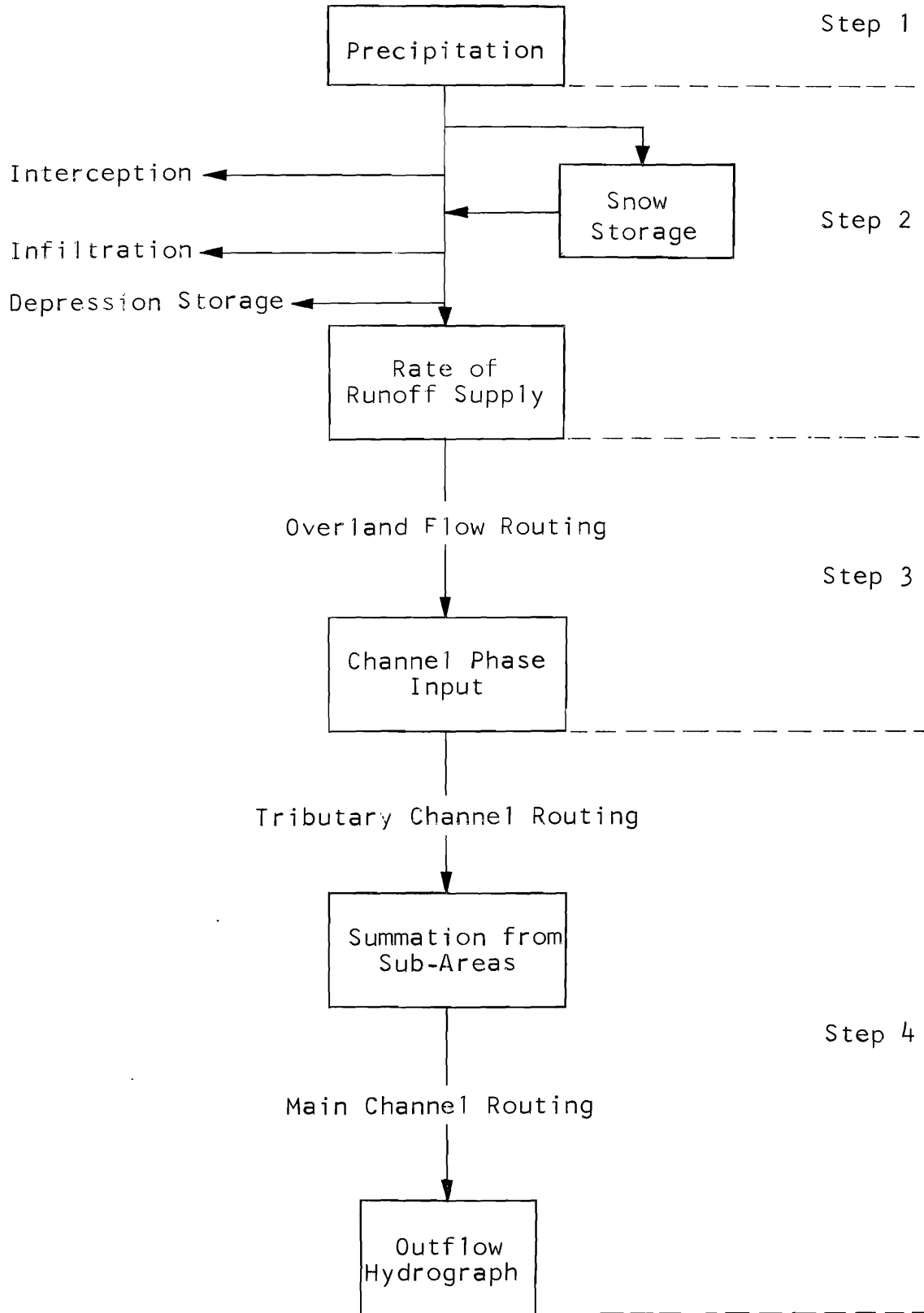

Figure 2.1. Schematic representation for obtaining runoff hydrograph.

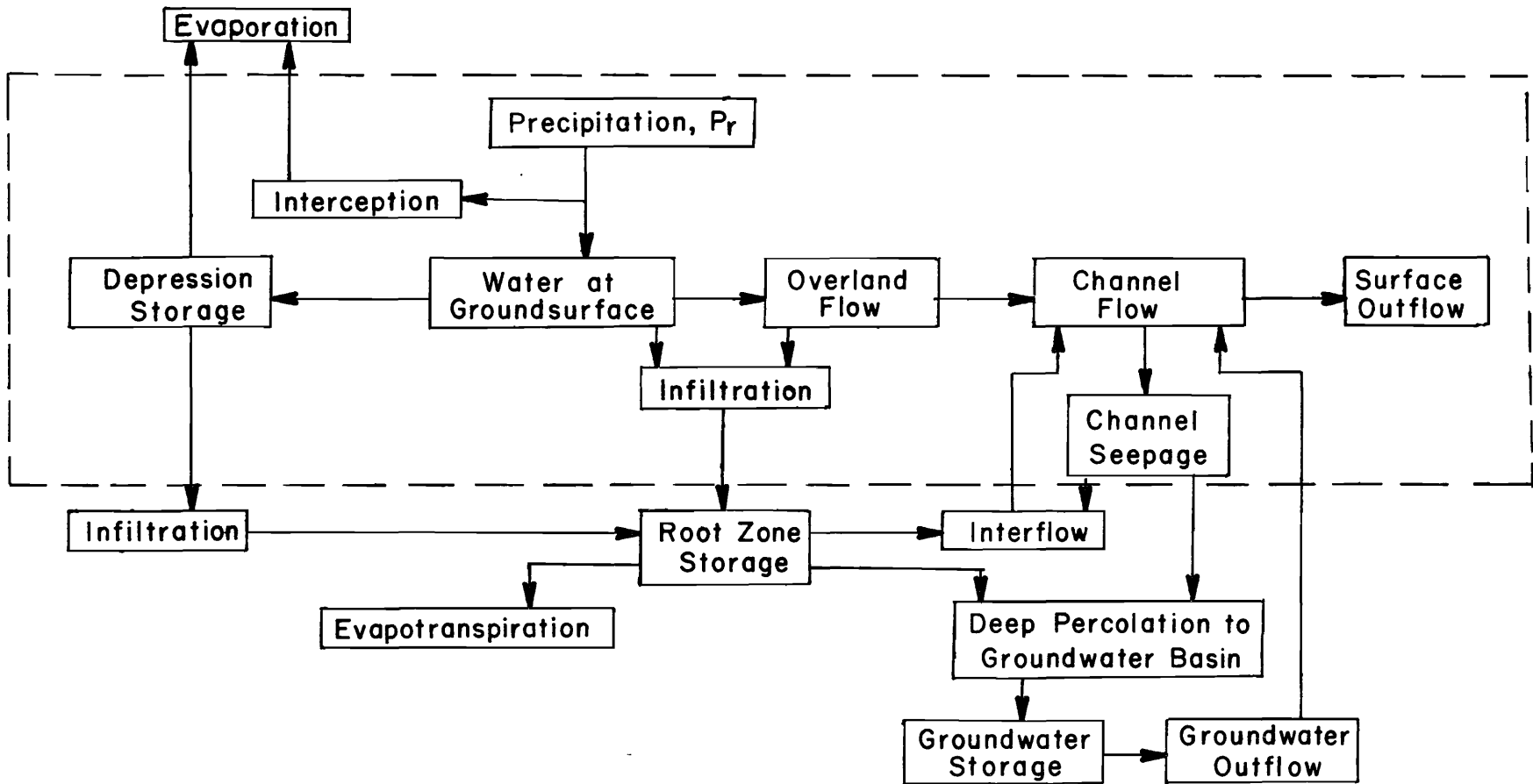

Figure 2.2. Schematic flow diagram of the hydrologic system.

the effects of momentum are negligible, and the continuity of mass becomes the only link between the various processes within the system.

Continuity of mass is expressed by the general equation:

$$\text{Input} = \text{Output} \pm \text{Change in storage} \quad (2.1)$$

A hydrologic balance is the application of this equation to achieve an accounting of physical or hydrologic measurements within a particular unit. Through this means and application of appropriate translation or routing functions, it is possible to predict the movement of water within a system in terms of its occurrence in space and time.

The concept of the hydrologic balance is pictured by the block diagram in Figure 2.2. The inputs to the system are precipitation and surface and groundwater inflow, while the output quantity is divided among surface outflow, groundwater outflow, and evapotranspiration. As water passes through this system, storage changes occur in the land surface, in the soil moisture zone, in the groundwater zone, and in the stream channels. These changes occur rapidly in surface locations and more slowly in the subsurface zones.

### Time and spatial resolution

Practical data limitations and problem constraints require that increments of time and space be considered during model design. Data, such as temperature and precipitation readings, are usually available as point measurements in terms of time and space; and integration of both dimensions is usually accomplished by the method of finite increments. For example, it is common practice to divide a drainage area into a number of units or subwatersheds and to develop average values of system parameters and physiographic characteristics for each unit. A schematic diagram which illustrates subwatersheds within a drainage basin is shown by Figure 2.3. A parameter model composed of spatial subunits of this nature frequently is referred to as a distributed parameter model.

The complexity of a model designed to represent a hydrologic system largely depends upon the magnitude of the time and spatial increments utilized in the model. In particular, when large increments are applied, the scale magnitude is such that the effects of phenomena which change over relatively small increments of space and time are insignificant. For instance, on a monthly time increment, interception rates and changing snowpack temperatures are neglected. In addition, the time increment chosen might coincide with the period of cyclic changes in certain hydrologic phenomena. In this event net changes in

these phenomena during the time interval are usually negligible. For example, on an annual basis, storage changes within a hydrologic system are often insignificant, whereas on a monthly basis, the magnitude of these changes are frequently appreciable and need to be considered. As time and spatial increments decrease, improved definition of the hydrologic processes is required. No longer can short-term transient effects or appreciable variations in space be neglected, and the mathematical model, therefore, becomes increasingly more complex with an accompanying increase in the requirements of computer capacity and capability.

For the urban hydrology model of this study, a 30-minute time increment and small space units (zones) were adopted (Figure 3.4). Selection of the zones was based on hydrologic boundaries and points of data availability within the area. It is considered that the model resolution adopted (in terms of time and space) is adequate to permit examination, by means of the model, of many problems pertaining to the management of the area.

## System Processes

### Precipitation

The basic inflow or input of water into any hydrologic system originates as a form of precipitation. The initial step, then, in watershed modeling is to determine representative storm hyetographs by collecting precipitation data for the catchment area under investigation. By applying an appropriate spatial integration technique, such as the isohyetal method or the Thiessen weighting procedure, the areal distribution of precipitation is estimated on the basis of point data from a gage network. The Thiessen network was applied in this study (Figure 3.10), and the input hyetographs for individual storm events were determined by the computer program in Appendix B. Since precipitation associated with major flood events in the Salt Lake Valley occurs in the form of rain, the snow accumulation and melt processes are not included in the model.

### Surface water inflows

Streamflow is defined as that portion of the precipitation which appears in streams and rivers as the net or residual flow collected from a drainage area. In many watershed simulation studies only a portion of the total drainage area is included within the boundary being considered by the model. In these cases, surface or streamflow inputs to the modeled area are either measured or estimated by a correlation procedure, and thus comprise basic input functions to the hydrologic model.

- ⎓⎓⎓⎓ Watershed boundary
- Subzone boundary
- · · · — Main stream channel
- $Q_{01} = Q_{i1}$
- $Q_{02} = Q_{i2}$
- $Q_{00}$  = mountain watershed

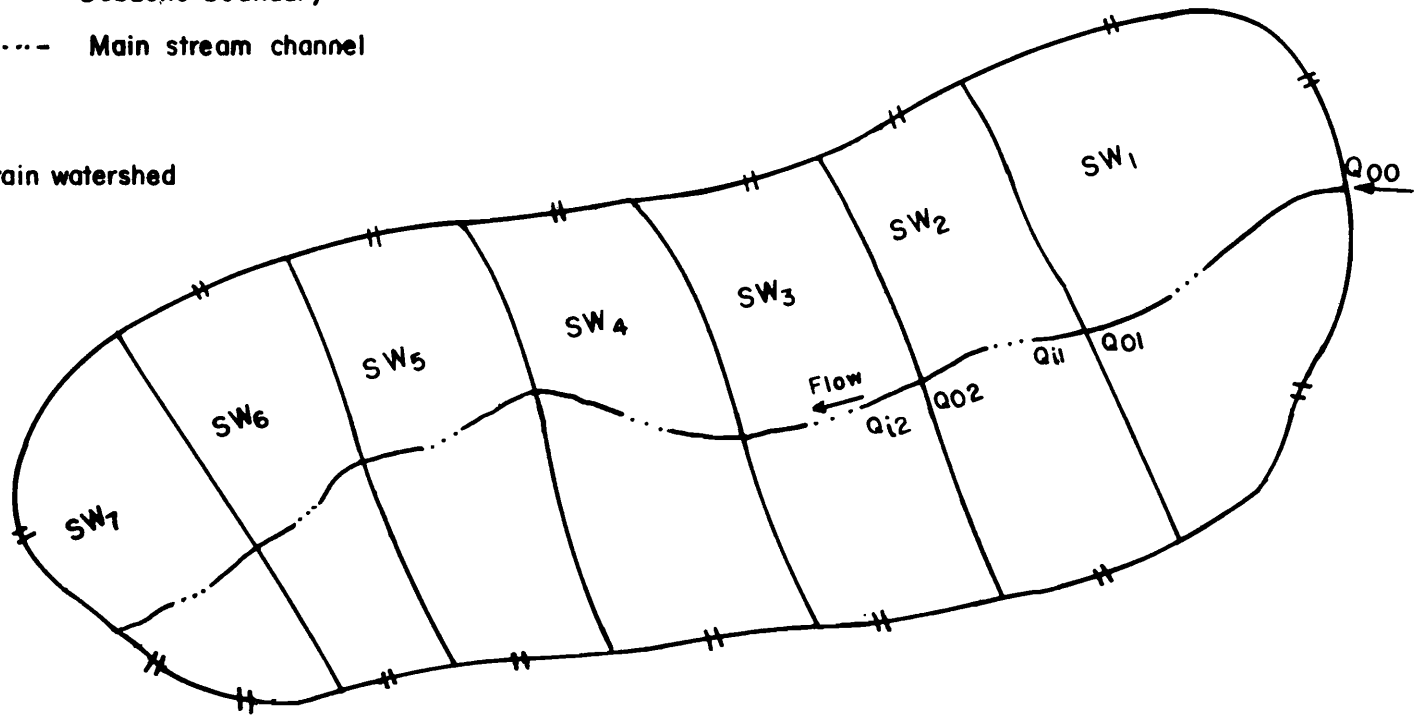

6

Figure 2.3. Schematic diagram of an urban subwatershed model.

**Interception**

Rainfall excess is calculated by subtracting losses, such as interception, from precipitation reaching the ground or vegetative cover. The rate of interception is assumed to reduce exponentially with an increase in interception storage, and can be expressed as follows:

$$i_{cc} = i e^{-P/S_I} \dots \dots \dots (2.2)$$

in which

- $i_{cc}$  = capacity rate of inflow into interception storage
- $i$  = rate of precipitation
- $P$  = cumulative precipitation
- $S_I$  = volume of interception storage capacity expressed as an average depth over the catchment area

The actual interception rate,  $i_{ca}$ , is defined by the following expressions:

$$i_{ca} = i, \text{ for } i \leq i_{cc} \dots \dots \dots (2.3)$$

and

$$i_{ca} = i_{cc}, \text{ for } i > i_{cc}$$

The effective precipitation rate,  $i_e$  (that which occurs after interception is satisfied) is expressed by the following equations:

$$i_e = 0, \quad \text{for } i \leq i_{cc} \dots \dots \dots (2.4)$$

$$i_e = i (1 - e^{-P/S_I}), \quad \text{for } i > i_{cc}$$

Most of the moisture accumulated in interception storage is lost through evaporation. However, for short duration storms, this evaporation loss does not form a significant mechanism in the runoff process.

**Infiltration**

Infiltration loss is represented in the model as a function of time in accordance with the form proposed by Horton and used by Narayana et al. (1969).

$$f = f_c + (f_o - f_c) e^{-k_f t} \dots \dots \dots (2.5)$$

in which

- $f$  = instantaneous capacity rate of infiltration

- $t$  = time measured from the beginning of the infiltration curve
- $f_c$  = constant rate at which  $f$  is approached asymptotically with time
- $f_o$  = initial rate at  $t = 0$
- $k_f$  = positive coefficient depending upon the soil characteristics

The actual rate of infiltration,  $f_a$ , is bounded by the rate of water supply,  $i_e$ , and the capacity infiltration rate as given by Equation 2.5. Thus,

$$f_a = i_e, \text{ for } i_e \leq f$$

and

$$f_a = f, \text{ for } i_e > f$$

$\dots \dots \dots (2.6)$

As indicated by Figure 2.4 the actual infiltration rate,  $f_a$ , curve follows the hydrograph of effective precipitation,  $i_e$ , as long as this rate is less than the infiltration rate capacity curve. When the rainfall rate exceeds this capacity, infiltration rate is equal to the state of the capacity function,  $f$ . The infiltration capacity rate which prevails at the beginning of a runoff event is dependent upon the prevailing soil moisture status. Usually this rate, designated as  $f_{t1}$ , is less than the maximum of the capacity rate curve.

**Surface depression storage**

The capacity rate of inflow into depression storage is expressed by the following equation:

$$\sigma_c = i_2 e^{-(P_1 - F)/S_d} \dots \dots \dots (2.7)$$

in which

- $i_2 = (i_1 - f)$  = net rate of precipitation after satisfying interception and infiltration
- $P_1$  = accumulated rainfall having satisfied interception storage
- $F$  = accumulated infiltration loss
- $S_d$  = total volume of available depression storage (expressed as mean depth over the entire catchment area)
- $\sigma_c$  = capacity rate of inflow into depression storage

The actual rate of inflow into depression storage,  $\sigma_a$ , at any time is expressed in accordance with limiting conditions as follows:

$$\sigma_a = i_2, \text{ for } i_2 \leq \sigma_c$$

and

$$\sigma_c = \sigma_c, \text{ for } i_2 > \sigma_c \quad \dots \dots (2.8) \quad \text{in which}$$

**Hydrograph of rainfall excess**

The hydrograph of rainfall excess is computed by chronologically deducting the losses due to interception, infiltration, and depression storage from the hydrograph of precipitation in compatible, finite, time increments. A schematic flow diagram of this procedure in accordance with the various equations developed to this point is presented in Figure 2.4. These equations, when programmed on a computer, predict a hydrograph of rainfall excess.

**Overland-channel routing**

Narayana et al. (1969) adopted the linear procedure of "storage routing" wherein the storage effects (overland and channel components) of the catchment area are accounted for by the characteristic time of the catchment area.

The general continuity equation for any linear storage system is given as follows:

$$P_e - Q = \frac{dSt}{dt} \quad \dots \dots (2.9)$$

- $P_e$  = rainfall excess rate
- $Q$  = runoff rate
- $St$  = catchment area storage (overland and channel components)

Catchment area storage is considered as being directly proportional to the outflow rate. Thus,

$$St = t_R Q \quad \dots \dots (2.10)$$

in which

$t_R$  = a proportionality factor approximated by the hydrograph rise time

Using the equation derived by Espey et al. (1965), for 30-minute unit hydrographs of urban watersheds, the rise time is expressed as a function of the channel length and the mean slope of the catchment area. Hence,

$$P_e - Q = t_R \frac{dQ}{dt} \quad \dots \dots (2.11)$$

The runoff rate,  $Q$ , at the outlet of a single catchment area is obtained by solving the differential Equation 2.11.

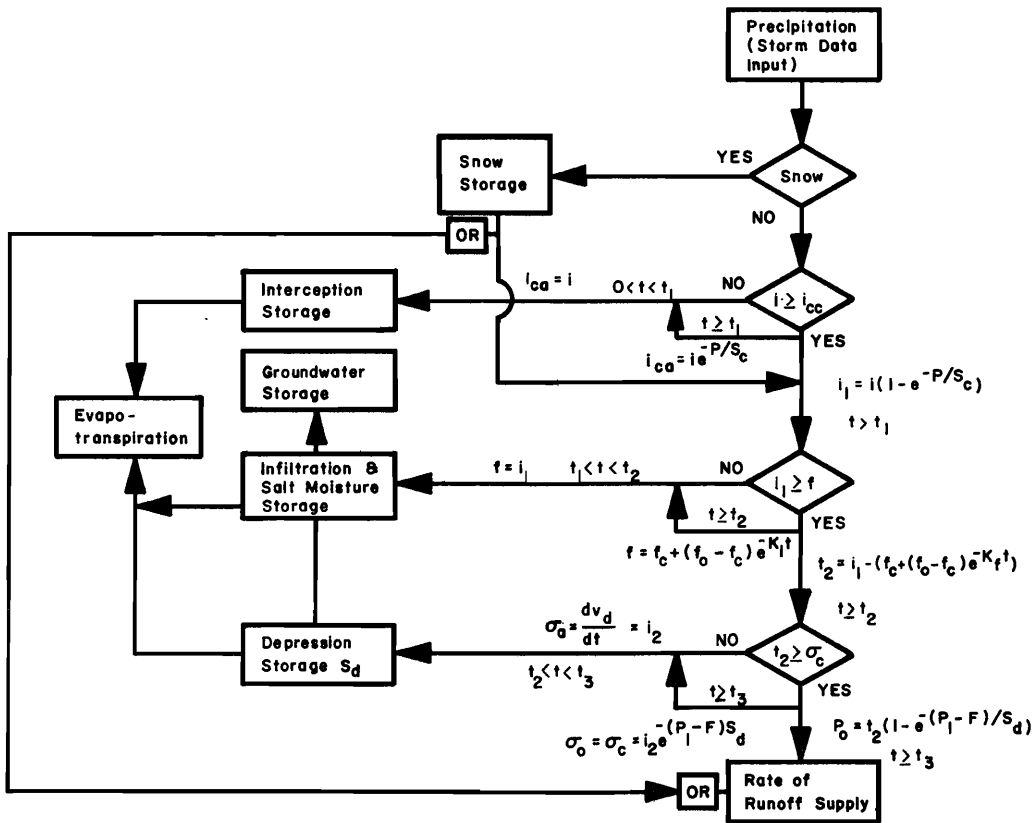

Figure 2.4. Schematic flow chart for obtaining hydrograph of rainfall excess.

**Channel routing**

The outflow hydrographs at the discharge points of each subzone within a drainage area are produced by applying the urban watershed model for each subzone. The computed discharge function for a particular zone is then combined with the computed outflow from the adjacent downstream zone, and the routing procedure is followed until the discharge hydrograph at the outlet of the watershed is developed. A channel routing technique was devised by Evelyn et al. (1970) to combine the discharge of each adjacent subzone to produce the final hydrograph of the entire basin. The method is based on the assumption that the channel or storm drain is a linear storage reservoir. Hence,

$$Q_i - Q_o = \frac{dSc}{dt} \dots \dots \dots (2.12)$$

and

$$Sc = T_L Q_o \dots \dots \dots (2.13)$$

in which

- $Q_i$  = rate of inflow into the upstream section of channel, in this instance the upstream section, which coincides with the upstream boundary between subzones
- $Q_o$  = rate of outflow from the downstream section of channel which coincides with the boundary between the two adjacent downstream subzones
- $S_c$  = instantaneous volume of channel storage
- $T_L$  = proportionality factor between  $S$  and  $Q_o$  which represents the time lag of water flowing between upstream and downstream channel sections

By substituting Equation 2.13 into Equation 2.12 the following routing equation is produced.

$$Q_i - Q_o = T_L \frac{dQ_o}{dt} \dots \dots \dots (2.14)$$

**Derivation of lag time**

The use of a linear storage system analogy for channel routing in the hydrologic model necessitated the derivation of an expression for the characteristic lag time,  $T_L$ , in Equation 2.14. This lag time is associated with the time required for flow to move through a channel of length,  $L$ . In order to simplify the analysis, a rectangular channel cross-section was assumed throughout the watershed. Appropriate parameters of diameter and depth of flow can be substituted for a particular storm drainage system. If  $b$  is assumed to represent channel width and  $y$  the depth of flow, the cross-sectional area of flow,  $A$ , is given by

$$A = b y \dots \dots \dots (2.15)$$

and the wetted perimeter,  $p$ , is

$$p = b + 2y \approx b \dots \dots \dots (2.16)$$

Manning's open channel flow equation is

$$Q = VA = 1.49 \frac{AR^{2/3} S^{1/2}}{n} \dots \dots (2.17)$$

in which

- $Q$  = discharge in cfs
- $S$  = channel slope in ft/ft
- $n$  = Manning's roughness coefficient
- $R$  = hydraulic radius =  $A/P$
- $R^{2/3} = (A^{2/3}) / (P^{2/3}) \approx y^{2/3}$

Therefore,

$$Q = 1.49 \frac{(b y) y^{2/3} S^{1/2}}{n} = 1.49 \frac{bS^{1/2}}{n} (y^{5/3}) \dots \dots (2.18)$$

Solving for  $y$  as function of  $Q$ ,

$$y = f(Q) = \left( \frac{n}{1.49 bS^{1/2}} \right)^{3/5} Q^{3/5} = KQ^{3/5} \dots \dots \dots (2.19)$$

in which

$$K = \left( \frac{n}{1.49 bS^{1/2}} \right)^{3/5} \dots \dots \dots (2.20)$$

The following derivation leads to an expression for  $T_L$  as a function of instantaneous discharge, a quantity readily obtained from the computer program.

$$T_L = \frac{\text{distance}}{\text{velocity}} = L \frac{A}{Q} \frac{Lby}{Q} \dots (2.21)$$

Substituting Equation 2.19 into Equation 2.21 yields

$$T_L = \frac{L bKQ^{3/5}}{Q} = L bKQ^{-2/5} \dots (2.22)$$

An expression for lag time,  $T_L$ , (Equation 2.22) is given in terms of readily obtained channel parameters or storm drain design parameters. Dividing Equation 2.22 by 60 gives  $T_L$  in minutes.

Assuming a linear distribution of inflow into the channel or the storm drain system along its length, then a reasonable expression for  $Q$  added within a subzone is given by the following

$$Q = \frac{Q_i + Q_o}{2} \dots \dots \dots (2.23)$$

Narayana et al. (1969) did not use a lag time concept in their study because a single watershed area was assumed and routing of upstream outflow through downstream subzones was not required. The Evelyn et al. (1970) study utilized a subzone approach and a lag time parameter. This parameter was reduced to a constant, based on subzone characteristics and a variable related to peak discharge rates from individual storm events. The discharge for each subzone was determined by assuming that the outflow for each subzone was proportional to the area drained. The lag time parameter for each subwatershed therefore was

expressed in terms of the peak discharge at the outflow point of the last or most downstream subzone. The lag time parameter used by Evelyn et al. (1970) gave satisfactory results. This lag time parameter, in essence, gave an attenuation effect to the outflow hydrographs and increased the recession time. The time of the peak discharge was not shifted, however.

In the study reported here rates for each subzone discharge are determined and used to calculate the lag time parameter for the corresponding subzone. The lag time parameter is applied to calculate the shift in unit time periods due to channel routing effects. This unit time shift is found by dividing the lag time parameter into the time scale and then rounding to the nearest integer. The routing of the upstream hydrograph through the adjacent lower subzone channel is then delayed as calculated to yield a lateral shift for time of peak discharge. This process is followed for each subzone until the outflow hydrograph is computed for the entire watershed area.





## CHAPTER III

### THE STUDY AREA

#### Location of the Study Area

The basic approach adopted for this study is the development of a general method of analysis based upon fundamental relationships and concepts, and which will be applicable to a wide variety of problems dealing with urban drainage. However, in order to provide a basis for developing a conceptual model and for subsequent model development and testing, a specific study site was selected. This area is within the Salt Lake Valley and is a part of the rapidly developing metropolitan area of Salt Lake County, which includes Salt Lake City and several other suburban communities. Because of rapid urban growth within this region, the problem of flood drainage and its amelioration is of increasing concern to city and county officials.

The Salt Lake Valley, which is part of the Great Basin, is "U" shaped and is bordered on three sides by mountains and by the Great Salt Lake on the north. The valley, which is about 15 miles wide (east and west) and 25 miles long, is bisected by the Jordan River which flows northward and discharges into the Great Salt Lake. The average elevation of the valley floor is approximately 4,000 feet above mean sea level. In a hydrologic sense, the Wasatch Mountain Range which borders the eastern side of the valley is especially important because these mountains provide a large portion of the water supplies for the valley below. Several small streams run westward from mountain canyons into the valley and discharge into the Jordan River. The Wasatch Mountains, with peaks up to 11,000 feet above sea level, rise abruptly to a height of nearly 6,500 feet above the valley floor. Because of this height, much of the precipitation which falls on watersheds within the range is produced by the orographic lifting of air masses which are moving in an easterly direction. The valley floor is considered to be semiarid with an average of about 15 inches of rainfall per year.

The area selected for this study is limited to a part of the eastern side of the valley as outlined by Figure 3.1. The area is bordered on the west by the Jordan River, on the east by the Wasatch Mountains, on the north by the heavily urbanized Mill Creek drainage, and on the south by the less urbanized but developing Little Cottonwood Creek watershed. Altogether,

the area contains about half of the eastern section of the Salt Lake Valley.

As indicated by Figures 3.1 and 3.2, the three streams within the study area are tributaries to the Jordan River. The urban portions of Mill, Little Cottonwood, and Big Cottonwood Creek drainages contain approximately 14.8, 10.0, and 23.3 square miles, respectively, and extend from the foot of the Wasatch Mountains to the Jordan River. The hydrologic model, which is discussed in the preceding chapter, was applied to this entire area. Urbanization is predominately residential in nature with a few areas of light industrial and commercial development.

#### Physical Characteristics of the Study Area

##### Topography

The general topography of the study area is shown by Figure 3.3. Approximate average elevations range from 4200 feet at the Jordan River to 4800 feet along the Wasatch Boulevard on the east. Thus, surface runoff moves rapidly from the Wasatch Mountains toward the Jordan River. The fast runoff from the steep slopes near the mountains tends to accumulate in ditches, curbs, and gutters on the flatter areas near the Jordan River, and this effect needs to be avoided in the design of drainage structures.

##### Geology

In the area where the steep slopes of the mountains merge with the upper planes of the valley, rocks and gravel are overlain with sand and soil. Vegetation is of the scrub oak variety mixed with some grasses. Because of its high gravel and sand content the infiltration capacity of the soil is generally high. For the same reason the soil is susceptible to erosion so that high velocity flows of storm water tend to form channels and gullies. This condition is further aggravated by grading, trenching, or other movement of the soil during construction of buildings and roads. At lower elevations within the study area (nearer the Jordan River) the soil is heavier and more compact. In these areas although average infiltration rates are less, so also are surface runoff rates, so that erosion hazards

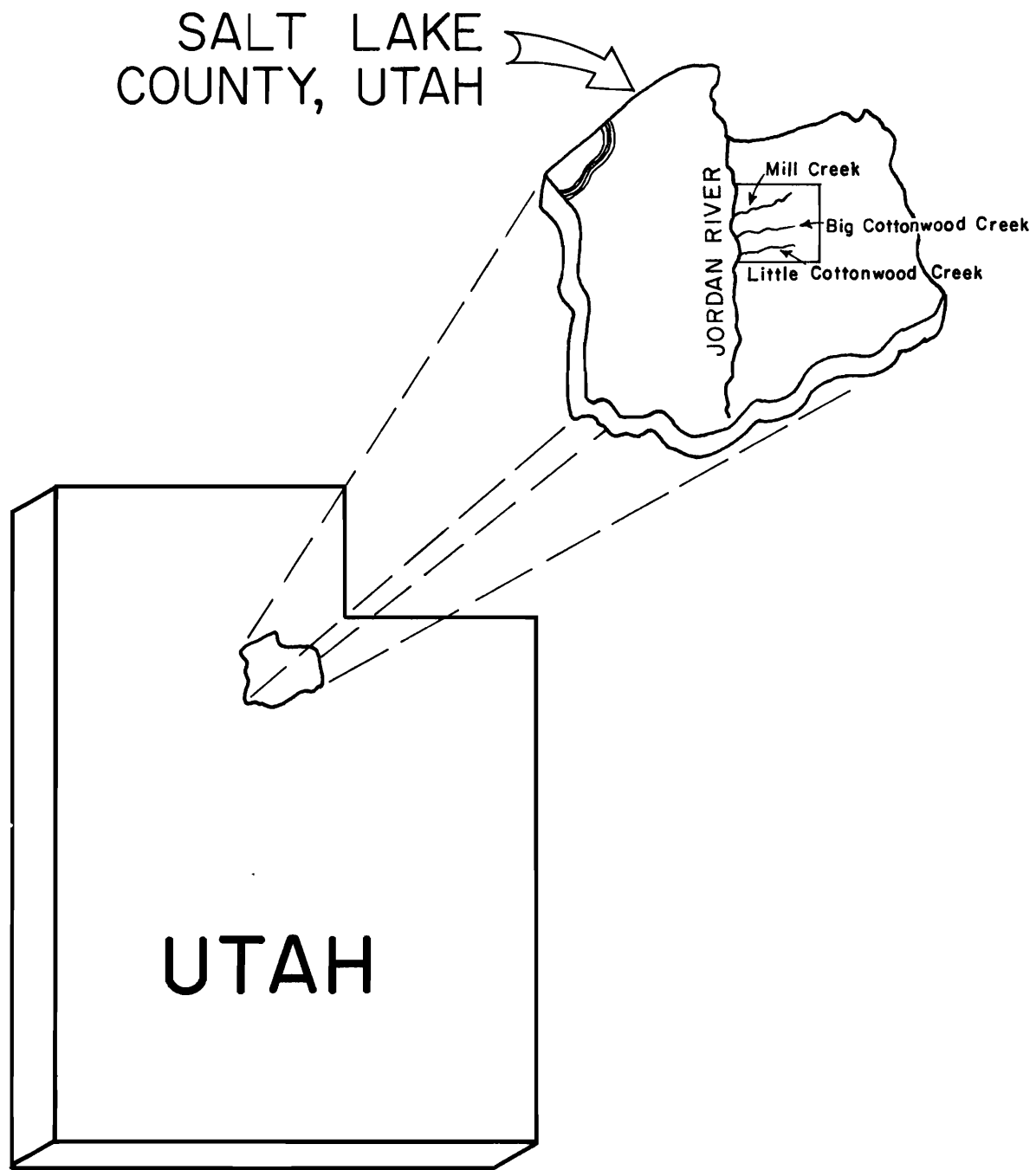

Figure 3.1. The watershed within Salt Lake County, Utah.

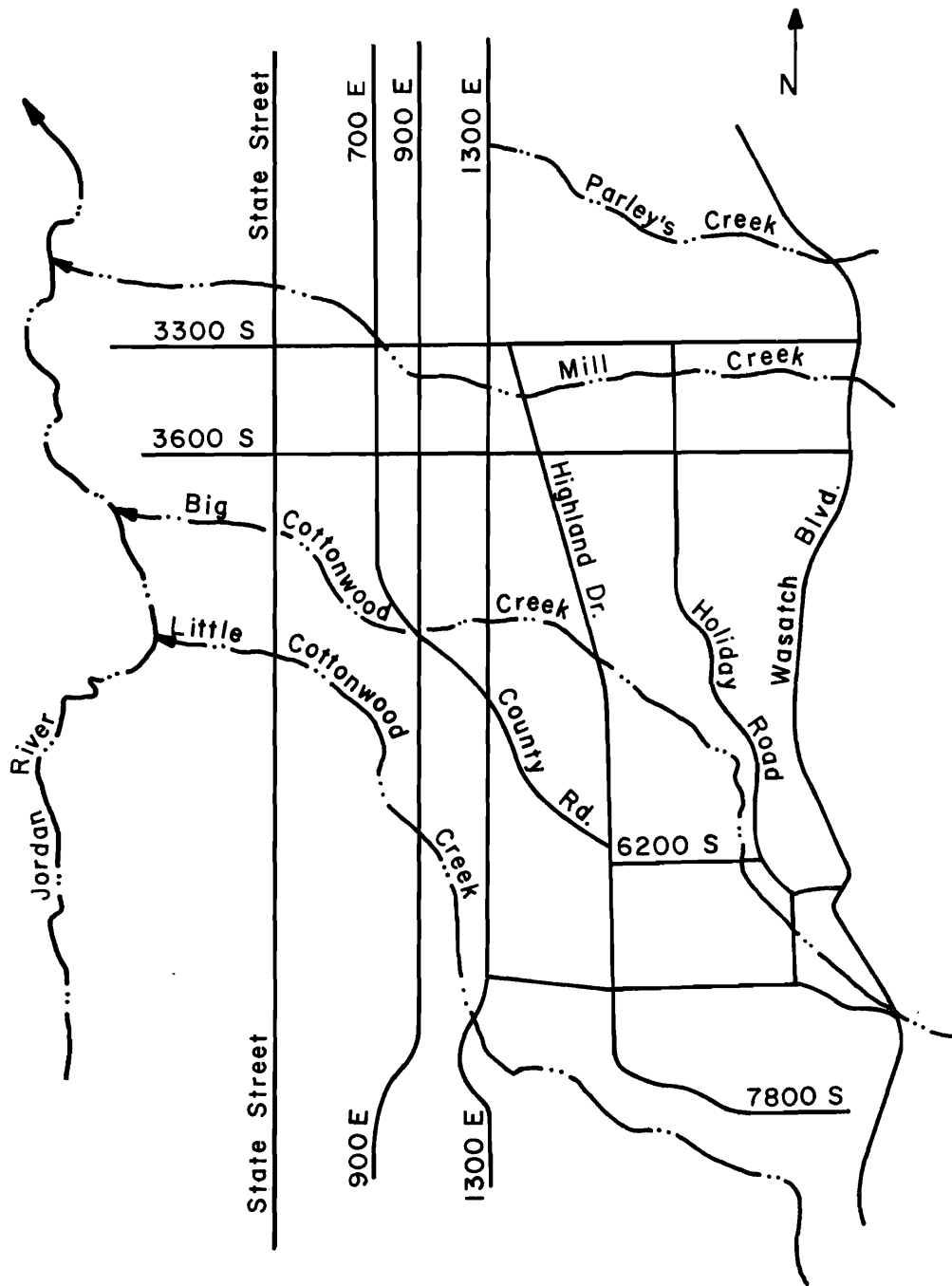

Figure 3.2. The urbanized study area.

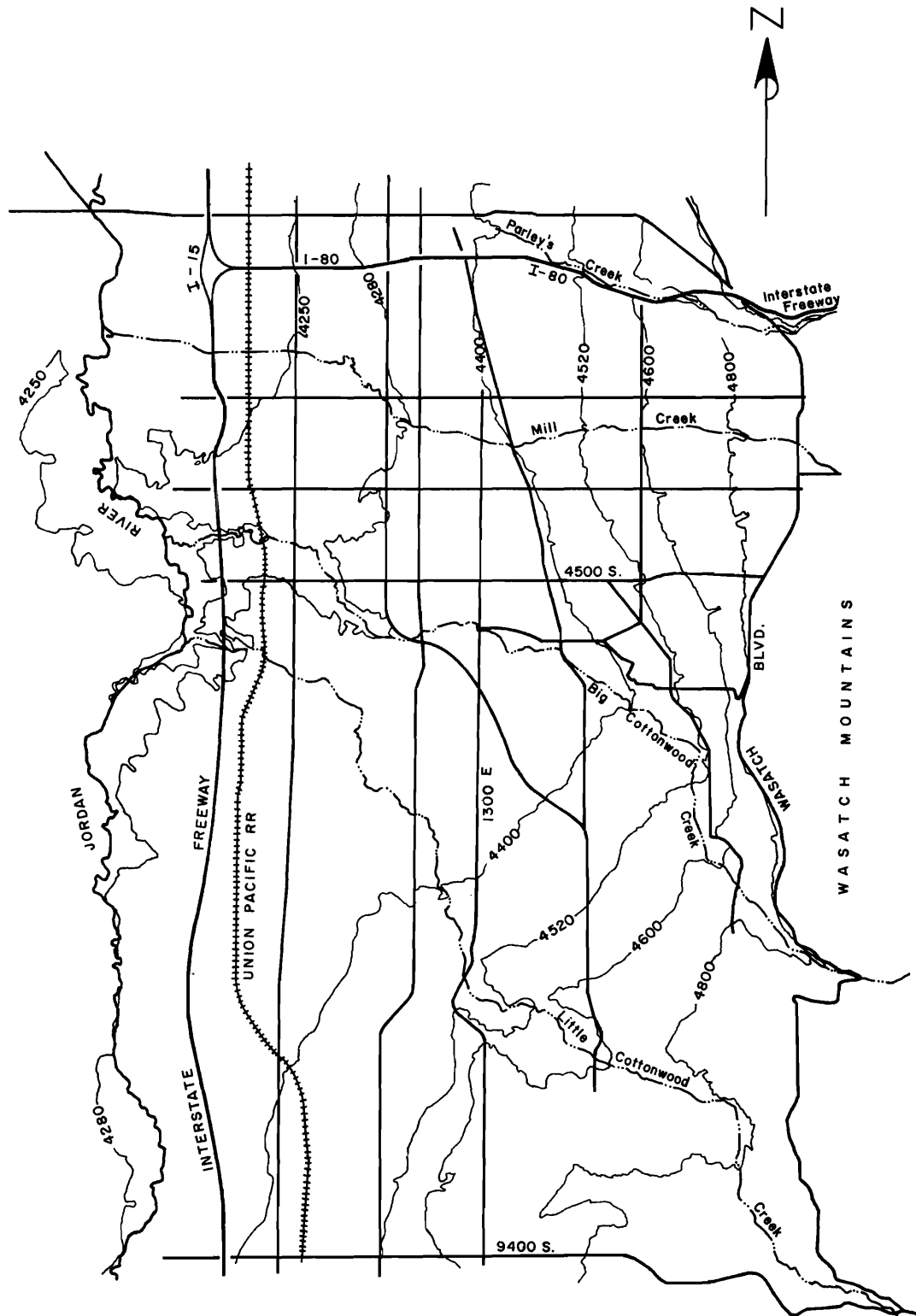

Figure 3.3. The general topography of the study area.

are reduced. Here also there is a tendency for water to pond in surface depressions rather than to enter the soil by infiltration.

### Degree of urbanization within the study area

A difficult task in urban watershed modeling is to select those urban parameters which are readily determined and yet accurately reflect the changes in the runoff hydrograph characteristics due to urbanization. Since changes in the system response characteristics are predicted on the basis of urban parameters, it is necessary that these parameters realistically represent urban conditions and be accurately evaluated. As proposed by Narayana et al. (1969), the percentage impervious cover,  $C_f$ , and the characteristic impervious length factor,  $L_f$ , were used in this study as the urban parameters. The values of these parameters are based on physical conditions existing on the watershed at any time, and can be estimated from aerial photos.

**Computation of urban parameters.** The initial step in evaluating the urban parameters involves the determination of the size of the spatial unit adopted for the model. Narayana et al. (1969) chose the entire watershed as the primary catchment unit. Evelyn et al. (1970) found that the synthesis of outflow hydrographs at selected locations within a basin dictated that a smaller subwatershed or subzone be chosen as the primary catchment unit. The outflows from the subzones are routed and combined to determine the outflow hydrograph at any specified point. An even smaller unit of spatial area would be the urban block. This unit would permit the synthesis of specific inlet hydrographs for storm drain and gutter design under various assumed degrees of urbanization.

Evelyn et al. (1970) proposed the following procedure for evaluating the urban parameters, and this procedure was adopted for this study.

I. Divide the watershed into a number of subzones as illustrated by Figure 3.4.

A. Factors which influence the number of subzones and their boundaries are:

1. Natural topography and street configurations.
2. Location of rainfall and streamflow gages.
3. Objectives of the study, for example, different boundaries might be chosen for investigations involving (a) storm characteristics, (b) land use, and (c) the design of flood control structures.
4. Locations and densities of diversions.

B. The concept of the subwatershed model requires that all outflow from a subzone be de-

finied and preferably be at a single point. The condition of a single outflow point is not essential but it simplifies model development.

II. Determine the impervious cover of roads, buildings, parking lots, and sidewalks. The use of large aerial photographs (in the present study, aerial photos with a scale of 1" = 400' were used) greatly reduces the work involved in that minimal enlargement and tracing of details are necessary. The personnel gathering data can work directly on the aerial photographs, delineating boundaries, subzones, and units within subzones by means of wax pencils of various colors which can be erased if necessary. Although the areal extent of roads, buildings, parking lots, and sidewalks are estimated separately for each unit considered, the important parameter is the total impervious area. However, the additional work necessary for differentiating between various types of impervious cover often is worthwhile. The separation can provide the researcher or designer with increased insight into the system performance by permitting him to examine the effects of a particular kind of impervious cover on the runoff characteristics of the watershed. In addition, information on various kinds of impervious cover often is needed if other subsequent studies are undertaken, such as an economic analysis. The following procedure is suggested for determining average values of various kinds of impervious cover within a study area.

A. Choose a number of residential blocks so as to include within the sample a representative of each type of block within the watershed.

1. For each block chosen, carefully measure the precise amount of each type of impervious cover. The total area of the block is considered to be the area enclosed within lines joining the midpoints of the intersections of adjacent roadways (see the dotted enclosure of Figure 3.5). It is suggested that linear measurements normally be made with a scale and a rotometer. For large maps or aerial photographs the planimeter also is useful.

2. For each block calculate the percentage impervious area for each individual type of surface.

3. Average the results of all the blocks to obtain a mean impervious area for residential houses. Garage roofs, driveways, and home sidewalks are counted as residential houses. In this study the average area of impervious cover associated with a single residential house was determined by a statistical analysis on the blocks sampled to be approximately 2400 square feet.

4. In the same manner average values are estimated for the widths of residential streets and thoroughfares. Freeways and

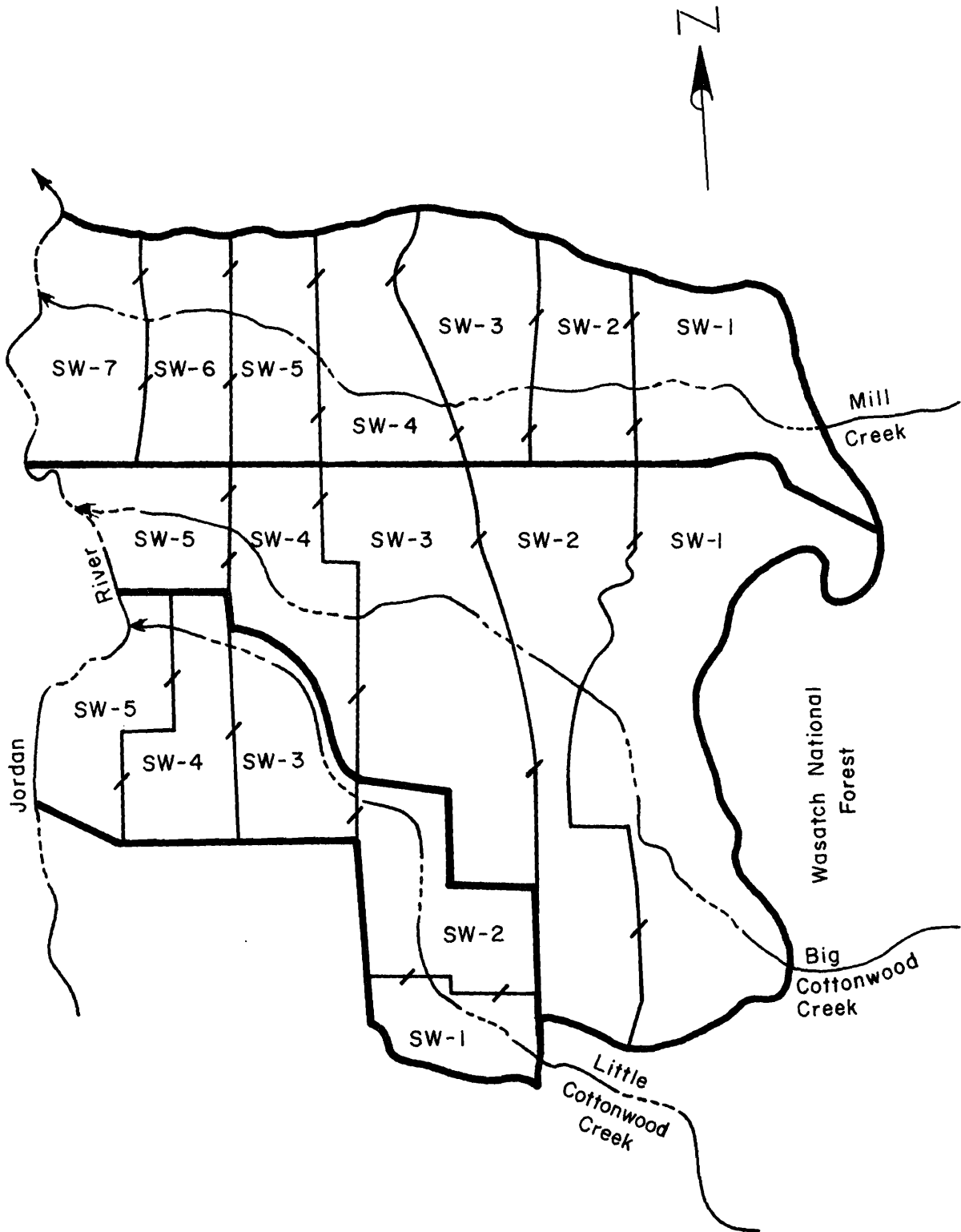

— Watershed Boundary  
 — Subzone Boundary

Figure 3.4. Dividing the watersheds into subzones.

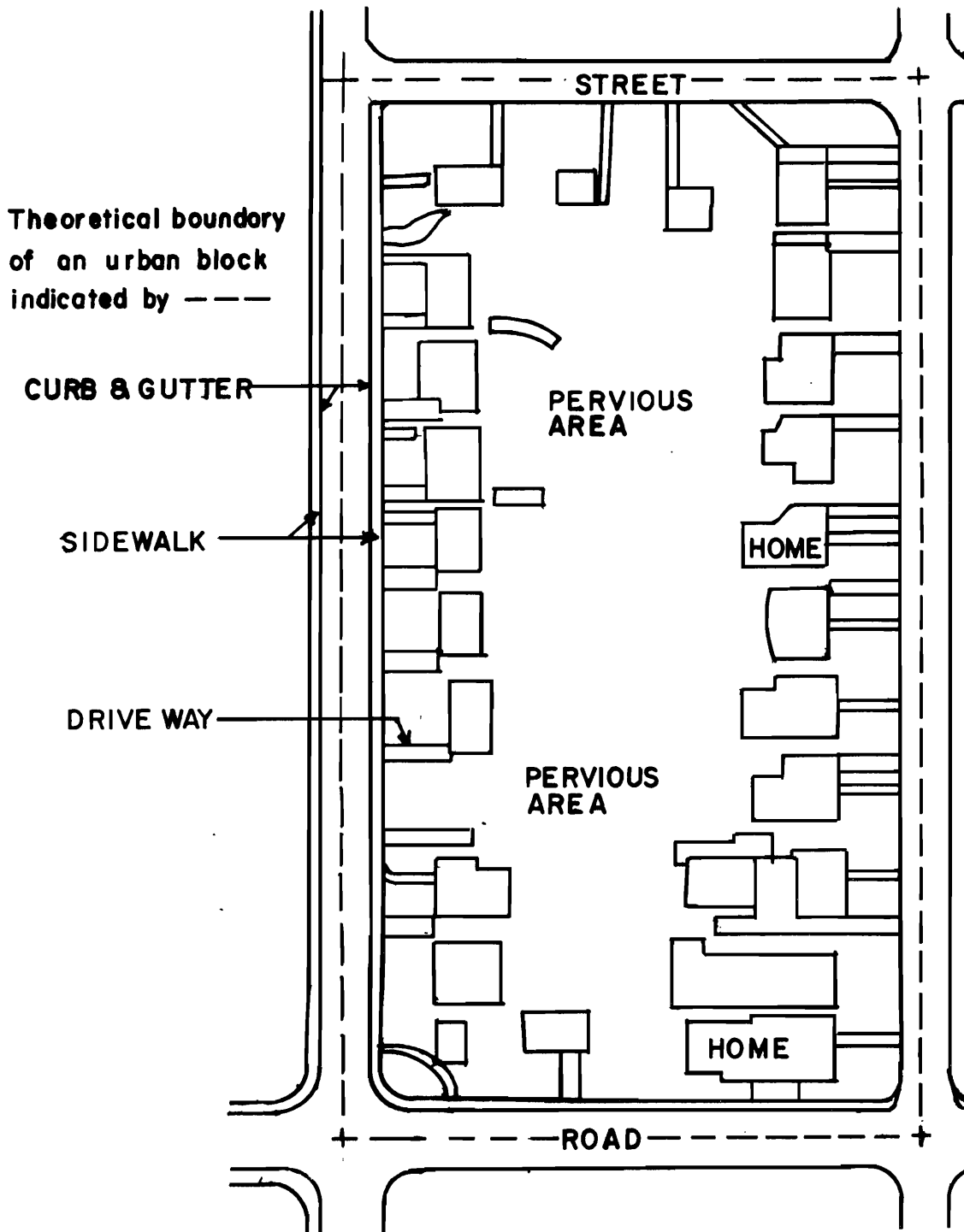

Figure 3.5. Typical urban residential block showing the pervious and the impervious areas.



main highways are considered on an individual basis.

B. Divide the study area into units based on the following criteria (Figure 3.6).

1. That the amount of impervious cover and its distribution are nearly homogenous within the unit.

2. That the geometric center of the unit can be found from visual inspection. The geometric center is the point from which all runoff from the unit might be considered to originate.

C. Analyze each unit within the basin to determine the percentage impervious cover.

1. Using a rotometer, estimate the total length of all roads within a unit. This length

multiplied by the average road width previously determined equals the area of roadways.

2. Parking lot areas are estimated either by directly measuring their dimensions or by using a planimeter.

3. The dwelling area is determined by counting the number of residential homes and multiplying this total by the average impervious area for a single residential home as previously estimated. To this total for dwelling is added individual estimates for larger structures, such as industrial plants, hospitals, and churches.

4. The impervious cover for sidewalks is obtained by a measurement of dimensions. In general sidewalk length can be measured simultaneously with street lengths.

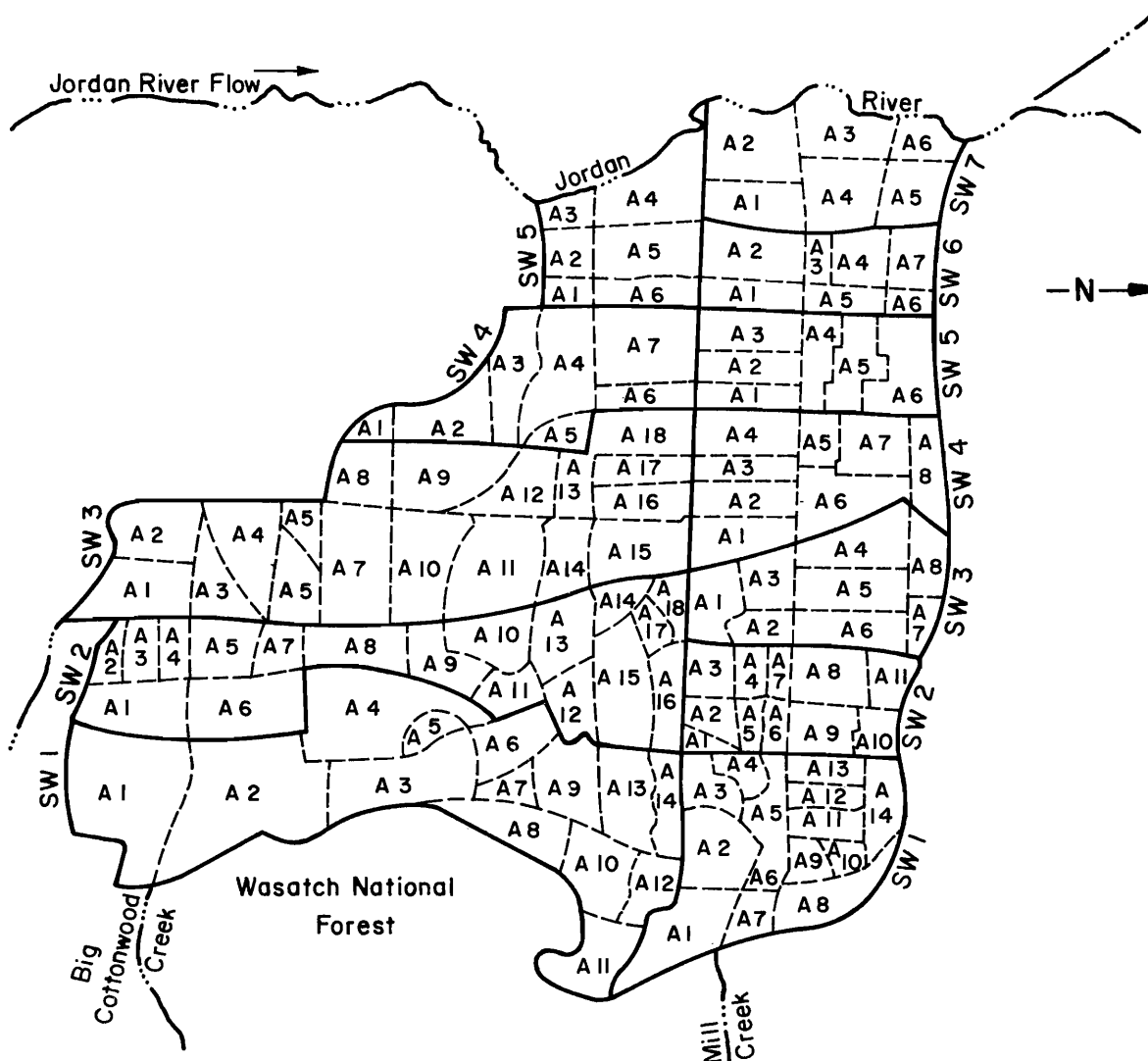

Figure 3.6. A sample of dividing subzones into smaller spatial units.

III. The characteristic impervious length factor is estimated by the following equation (reference is made to Figure 3.7).

$$L_f = \frac{L_m}{L}$$

in which

$L$  = the maximum flow path length within a subzone

$$L_m = \frac{\sum a_i l_i}{\sum a_i}$$

in which

$a_i$  = the impervious area of the  $i^{\text{th}}$  unit

The paths of drainage usually can be predicted from the conjunctive use of contour and street maps. Quad sheets published by the U.S. Geological Survey in general are adequate for this purpose. In this study only a few field observations of flow at street corners were needed.

**Summary of calculated urban parameters.** The previous discussion has attempted to describe the general method used for determining, for a specific study area, the two urban parameters of percentage impervious cover and characteristic impervious length factor. The values of these parameters for the specific urban area of this study are summarized in this section. A sample of the data needed for this determination is shown by Table 3.1. Most of these data were taken from aerial photographs dated 1975. The raw data were input to a computer program (Appendix B) to provide estimates of

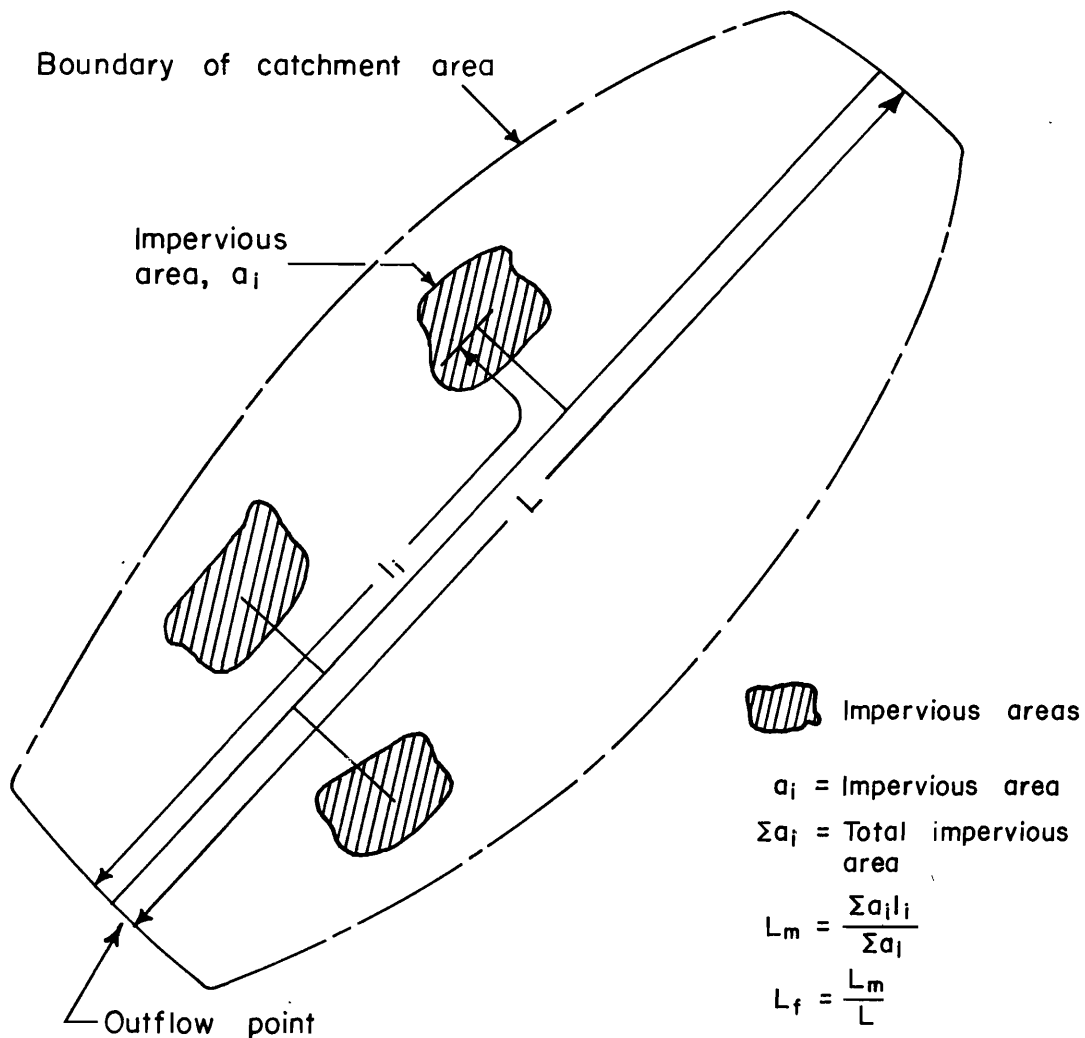

Figure 3.7. Sketch illustrating the characteristic impervious length,  $L_f$ , for a given watershed or subzone.

Table 3.1. Physical characteristics for the Mill Creek, Big Cottonwood Creek, and Little Cottonwood Creek drainages.

Sub-zone (Fig. 3.4)	Area <sub>2</sub> (miles <sup>2</sup> )	Length of channel within subzone d (feet)	Slopes ft/ft*	Percent impervious area C <sub>f</sub>	Characteristic impervious length factor L <sub>f</sub>	Interception S <sub>i</sub> (In)	Depression storage S <sub>b</sub> (In)	Minimum infiltration rate F <sub>o</sub> (In/Hr)	Maximum infiltration rate F <sub>c</sub> (In/Hr)	Hydrograph rise time t <sub>R</sub> (min)
Little Cottonwood Creek										
SW <sub>1</sub>	1.88	8200	.0250	.058	.745	.27	.24	.73	.22	8.1
SW <sub>2</sub>	1.94	3900	.0141	.120	.535	.25	.21	.71	.22	8.4
SW <sub>3</sub>	2.21	11800	.0067	.183	.668	.24	.23	.68	.19	9.5
SW <sub>4</sub>	2.41	3800	.0053	.197	.556	.24	.22	.68	.20	10.4
SW <sub>5</sub>	1.51	2000	.0050	.048	.667	.27	.22	.71	.21	6.5
	9.95		.0172							
Big Cottonwood Creek										
SW <sub>1</sub>	6.86	9800	.0586	.118	.623	.26	.22	.71	.21	29.7
SW <sub>2</sub>	5.37	13800	.0036	.167	.489	.24	.20	.79	.21	25.4
SW <sub>3</sub>	7.29	8800	.0057	.117	.438	.25	.19	.72	.22	31.6
SW <sub>4</sub>	2.61	9600	.0052	.154	.401	.24	.19	.70	.21	11.3
SW <sub>5</sub>	1.18	8600	.0020	.320	.669	.22	.24	.62	.16	5.1
	23.31		.0150							
Mill Creek										
SW <sub>1</sub>	2.20	9200	.0370	.262	.477	.22	.21	.65	.18	9.5
SW <sub>2</sub>	1.95	5600	.0228	.220	.552	.23	.22	.67	.19	8.4
SW <sub>3</sub>	1.94	4400	.0284	.271	.629	.23	.23	.64	.17	8.4
SW <sub>4</sub>	2.49	5400	.0250	.026	.690	.28	.23	.75	.23	10.8
SW <sub>5</sub>	2.02	7400	.0018	.250	.682	.23	.24	.5	.18	8.7
SW <sub>6</sub>	1.70	4400	.0043	.273	.638	.23	.23	.64	.17	7.3
SW <sub>7</sub>	2.53	6000	.0017	.093	.706	.26	.23	.72	.22	10.9
	14.83		.0172							

\* Average values for the watershed channel width = 30 feet  
Manning's "n" assumed to equal 0.037.

(1) the total impervious cover by categories, (2) the characteristic impervious length factor, and (3) the percent impervious cover. The estimates for items (2) and (3) are summarized by Table 3.1.

The figure of 2400 square feet of impervious area for an average urban dwelling was derived by subjectively sampling 21 residential blocks in two urban watersheds. Aerial photographs were used for drawing the samples. For each block, mean areas were calculated for the driveway and for the dwelling. On the basis of these individual block estimates corresponding areas were calculated for the entire study area. For an average urban dwelling unit a mean residence area of 1833.2 square feet and a mean driveway area of 553.6 square feet, or a total of 2486.8 square feet were obtained. Confidence limits of 95 percent yielded values for the residence between 1716.0 square feet and 1949.4 square feet, and for the driveway between 476.6 square feet and 630 square feet. The upper and lower values associated with these limits are 2193.5 square feet and 2580.0 square feet, respectively. As already indicated, impervious areas associated with large buildings, parking lots, and roadways were estimated by direct scaling from aerial photographs.

### Hydrologic Characteristics of the Study Area

As already indicated, the urbanized portions of Mill, Big, and Little Cottonwood Creeks watershed lie within Salt Lake County, Utah (Figure 3.1), and this was the study area selected for this project. This area was selected because of its proximity to Utah State University and because not infrequently it is subject to storm runoff which exceeds the existing capacity of the storm drainage system and which, therefore, produces flood damages. Most of the climatologic, hydrologic, and geologic data pertaining to the area are published in the form of annual reports or are in the files of public offices and, therefore, were available for this study. In addition, air photographs taken in June and July of 1965 were obtained from the U. S. Department of Agriculture.

### Climate

**Precipitation.** All runoff from a watershed area originates as some form of precipitation, and precipitation patterns, frequently modified by snow storage, to a very large degree affect flooding conditions. The influence of the Wasatch Mountain Range on the general precipitation pattern throughout the easterly portion of Salt Lake County is shown by Figure 3.8. (U. S. Weather Bureau, 1962; Kaliser, 1973). As suggested by this figure, more than two-thirds of the total average

annual precipitation along the Wasatch Front occurs during the winter months, mostly in the form of snow. Winter storms are mostly orographic in nature in that the cooling process which induces precipitation is caused by the lifting of the air currents as they pass from west to east over the mountain front. In summer moist air reaches Salt Lake City from both the Gulf of Mexico and the Pacific Ocean. At this time of year the uneven heating of the ground surface is a common cause of vertical lifting, leading to high intensity convective storms of short durations and of small aerial extent. Because the thunder or "cloudburst" type of storm is common in the mountains during the summer months, the Wasatch Range has a less significant influence on the precipitation patterns of the summer than that of the winter. The Weather Bureau (National Weather Service) has maintained continuous precipitation records at Salt Lake City for more than 85 years.

**Temperatures.** The warming temperatures of spring induce new leaf and vegetative growth. The warm summer temperatures cause high potential rates of water use by plants, so that water supplies which are stored in the soil from the snowmelt period or from a summer rain are rapidly depleted. The cooling autumn temperatures again produce significant changes in the hydrologic environment. Changes in the general patterns of mass air movement alter precipitation characteristics, leaves fall, and evapotranspiration rates on a watershed decrease markedly. Thus, air temperatures and the changing seasons have a significant influence on the performance characteristics of a hydrologic system.

Surface air temperatures in the Salt Lake area are subject to a wide range of seasonal fluctuation, which may vary from an average January temperature of 28°F to a July average of 77°F. The low and high temperatures of record at Salt Lake City are -20°F and 105°F, respectively. The normal growing season is the seven month period of April through October. Like precipitation, air temperatures are strongly influenced by topography, with temperatures generally decreasing with altitude in the Wasatch Range.

### Flood characteristics

In the past, runoff from the mountain slopes has caused only minor flooding problems during the snowmelt period within the study area. Although melting snows usually produce large runoff volumes, in most seasons the melting is gradual and disastrous peak flows do not occur. The type of flood caused by convective storms or cloudburst rainfall is the main concern of this study. This kind of storm event usually lasts less than three hours, but occurs in a small area with a high intensity.

According to analyses by the Corps of Engineers (1969), "rapid melting of the mountain snowpack pro-

duces a large volume of water over a long period of time, but with smaller peak flows than cloudburst floods." However, because total runoff volumes generated by convective storms in general are relatively low, peak flows of flood proportions usually occur near areas of incidence of the rainfall. As cited by Caldwell, Richards and Sorensen, Inc. (1966), one of the factors which control the rate of runoff at any point is the total tributary area to that point. Thus, high runoff rates from thunderstorms usually are associated with small runoff producing areas. As these flows move

downstream in larger watersheds, peak flows are reduced by storage effects, so that for a stream such as Mill Creek all of the major flows have been the result of snowmelt conditions. Sufficient records on small watersheds along the Wasatch Front in Salt Lake County are not available to permit a quantitative analysis of the comparative effects of thunderstorm and snowmelt runoff for small source areas. On the basis of hydrologic experience from other areas where similar runoff producing conditions exist, a runoff versus frequency curve of the kind illustrated by Figure 3.9 might be

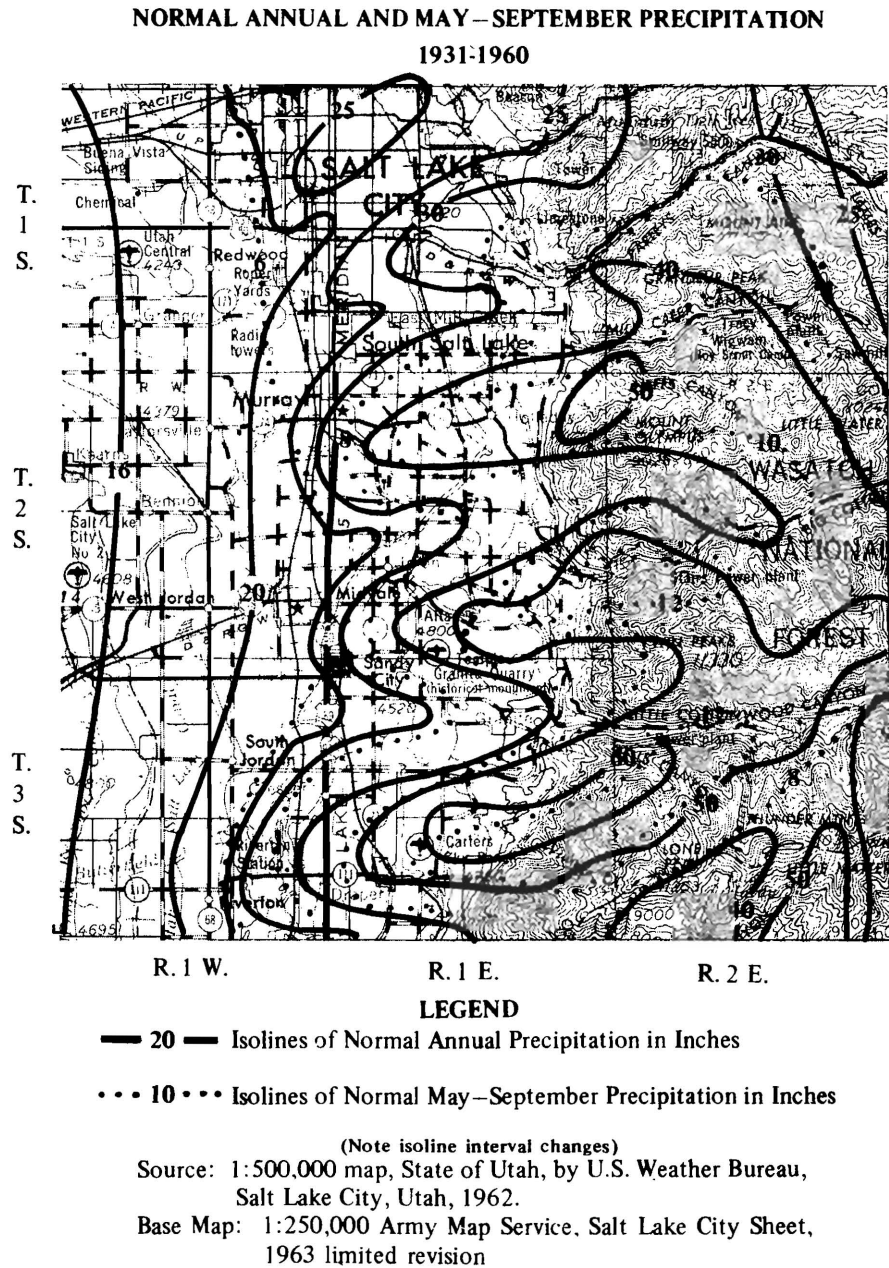

Figure 3.8. Isolines of annual and summer precipitation on the east bench area of Salt Lake County (after Kaliser, 1973).

expected for the drainage areas above the study area. The curve suggests that for small watersheds, flows of high frequency (return periods of 10 years or less, for example) snowmelt usually is the source of the water. However, for flows of lower frequencies, thunderstorms tend to predominate as the source of the runoff.

Because of the high intensity and short duration characteristics of convective storms, it is normal for only a relatively small portion of the total rainfall to enter the ground surface at the point of incidence. Thus, surface runoff rates usually are high and flooding conditions are common at the storm site and at downstream locations. Because it tends to decrease both infiltration rates and resistance to surface flows, urbanization usually increases surface runoff potential. These effects on the hydrologic system, coupled with the greatly increased damage opportunities, make the flood protection of urban areas in mountainous regions (particularly those which are subject to thunderstorm activity) a matter of prime concern for municipal planners and engineers.

#### Drainage conditions

All surface runoff which is generated within the watersheds flows to the Jordan River in either natural

or man-made water courses including existing curbs and gutters. An important influence on the courses followed by surface runoff is man-made barriers or obstructions, particularly railroad and highway embankments. In many cases culverts are not provided which have adequate capacity and ponds are formed. In other cases surface runoff flows are conveyed along the embankments to culverts at central locations, so that natural drainage patterns are altered. Streets with their accompanying curb and gutter also profoundly influence drainage patterns. Other man-made channels within the study area which affect surface drainage are irrigation channels and storm sewers. Characteristics of the main natural drainage channels within the study area are shown by Table 3.2. This table refers to subzones into which the watersheds were divided, and these subzones are shown by Figure 3.4.

#### Instrumentation

The basic hydrologic network for the study area consists of nine precipitation stations and eight stream gaging stations as shown by Figure 3.10. Two stream gages are situated on Mill Creek, two are on Big Cottonwood Creek, one is on Little Cottonwood Creek, and three are on the Jordan River. Of the nine precipitation gages, only one is of a recording type. Two non-recording precipitation stations are situated within the

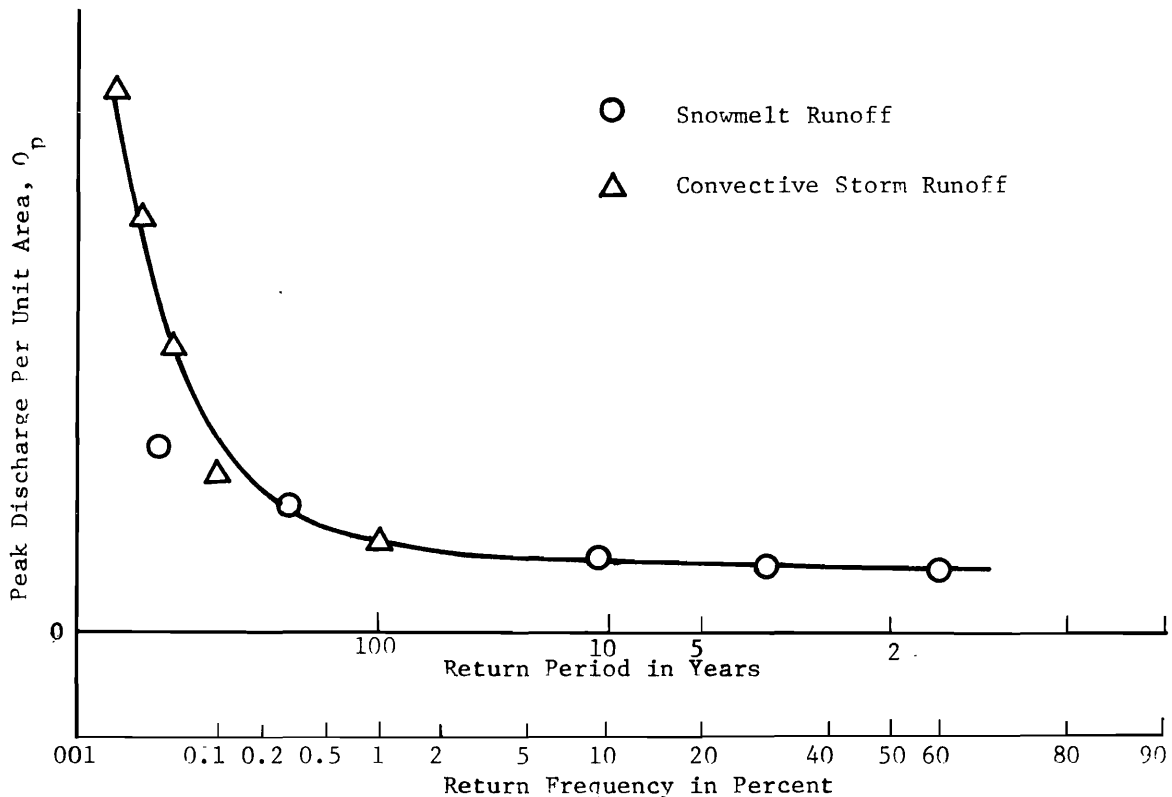

Figure 3.9. A typical distribution of runoff from snowmelt and convective storms for small watersheds.

Mill Creek watershed, two are in the Big Cottonwood Creek drainage, and two are on Little Cottonwood Creek. The single recording precipitation station (W-9) is situated

on Cottonwood Creek. In the Thiessen network analysis used in this study (Figure 3.10), data from precipitation stations such as W-38 are applied to the three watersheds.

**Table 3.2. Characteristics of the main drainage channels of Mill, Big Cottonwood, and Little Cottonwood Creeks within the study area.**

Sub-zone (see Fig. 3.4)	Area (miles <sup>2</sup> )	Length of Channel Within Subzone d (feet)	Width <sup>a</sup> b (feet)	Slopes ft/ft <sup>a</sup>	Manning's n <sup>a</sup>
<b>Mill Creek</b>					
SW <sub>1</sub>	2.20	9200	30	0.0370	0.037
SW <sub>2</sub>	1.95	5600	30	0.0228	0.037
SW <sub>3</sub>	1.94	4400	30	0.0284	0.037
SW <sub>4</sub>	2.49	7400	30	0.0250	0.037
SW <sub>5</sub>	2.02	5400	30	0.0018	0.037
SW <sub>6</sub>	1.70	4400	30	0.0043	0.037
SW <sub>7</sub>	2.53	6000	30	0.0017	0.037
	<u>14.83</u>				
<b>Big Cottonwood Creek</b>					
SW <sub>1</sub>	6.86	9800	30	0.0586	0.037
SW <sub>2</sub>	5.37	3800	30	0.0036	0.037
SW <sub>3</sub>	7.29	8800	30	0.0057	0.037
SW <sub>4</sub>	2.61	9600	30	0.0052	0.037
SW <sub>5</sub>	1.18	8600	30	0.0020	0.037
	<u>23.31</u>				
<b>Little Cottonwood Creek</b>					
SW <sub>1</sub>	1.88	8200	30	0.0250	0.037
SW <sub>2</sub>	1.94	3900	30	0.0141	0.037
SW <sub>3</sub>	2.21	11800	30	0.0067	0.037
SW <sub>4</sub>	2.41	3800	30	0.0053	0.037
SW <sub>5</sub>	1.51	2000	30	0.0050	0.037
	<u>9.95</u>				

<sup>a</sup> Average values for the subzones.

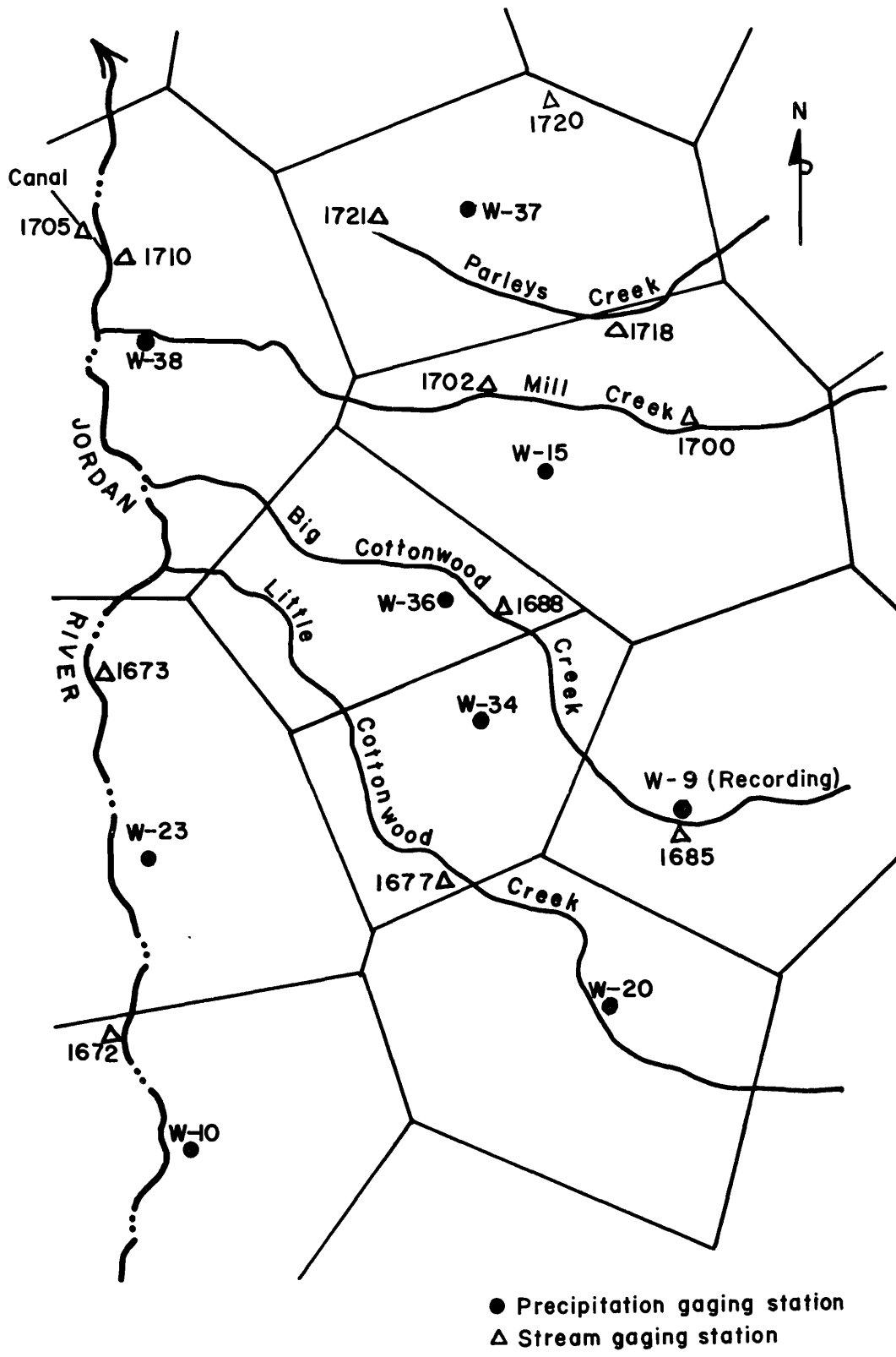

Figure 3.10. Hydrologic instrumentation and the Thiessen polygons for precipitation analysis within the study area.





## CHAPTER IV

### THE COMPUTER MODEL OF THE HYDROLOGIC SYSTEM

A computer model of the hydrologic system is produced by programming the mathematical relationships and logic functions of the hydrologic model as described in Chapter II. The model does not directly simulate the real physical system, but is analogous to the prototype, because both systems are described by the same mathematical relationships. A mathematical function which describes a basic process, such as evapotranspiration, is applicable to many different hydrologic systems. The simulation program developed for the computer incorporate general equations of the various basic processes which occur within the system. The computer model, therefore, is free of the geometric restrictions which are encountered in simulation by means of network analyzers and physical models. The model is applied to a particular prototype system by establishing through a verification procedure, appropriate coefficient values for the equations required by the system.

For this study a simulation model of the urban hydrologic system was programmed on the hybrid computer. The digital portion of the model was coded in FORTRAN IV (EAI subset), and the analog portion was programmed for the EAI 580 computer. Because an analog computer operates within specific voltage limits, in this case  $\pm 10$  volts, it was necessary to scale the analog component of the model such that these limits were not exceeded. The basic data were input to the digital computer, which processed and controlled the operation of the hydrologic mass balance model programmed on the analog component of the hybrid computer. Values of input and output data were printed as stipulated in the program by the online printer as the simulation proceeded. Graphical output at various points within the model was obtained by connecting the x-y plotter to the appropriate terminals on the analog patch-board. The various processes within the model that were programmed on each component of the hybrid computer are discussed in the following sections.

#### Digital Programs

The first program is used for calculating the urban input parameters,  $C_f$  and  $L_f$ , and is called URBP

(Urban Parameters). The WATMOD (Watershed Model) program calculates the values needed by the analog computer, controls the analog computer, and prints both input and output data.

#### Program WATMOD

This program (Figures 4.1 and 4.2) is given in Appendix B. It calculates the precipitation inputs in equal time intervals from precipitation given in non-equal time increments and also calculates precipitation distribution from non-recording precipitation stations based on the total storm precipitation and the time distribution from a recording precipitation station.

The equal time interval precipitation is then used in a Thiessen network analysis to determine the areal distribution of rainfall over the watershed. This becomes the precipitation input to the analog computer.

Calibrated watershed coefficients, which are used by the analog model, are calculated by the subroutine ANALOG of the WATMOD program (Figure 4.2) utilizing regression equations based on the two urban parameters  $C_f$  and  $L_f$ . These watershed coefficients are then scaled for magnitude and transferred to the analog computer where the corresponding attenuators (pots) are automatically set.

The digital computer, before transferring the precipitation to the analog, checks a logic voltage from the analog which in essence acts as an internal time clock to insure proper input timing. This logic voltage comes in high and low square waves at one second intervals of time. The logic voltage is checked and when proper, the digital computer sends to the analog one value of equal interval precipitation per second. This precipitation is then used by the analog computer to calculate the runoff from the watershed.

After the analog computer has made the calculations, the values are transferred to and stored in the memory of the digital computer. In the meantime, another second of time will have elapsed and the digital computer, after checking the logic voltage, will send to the analog another precipitation value.

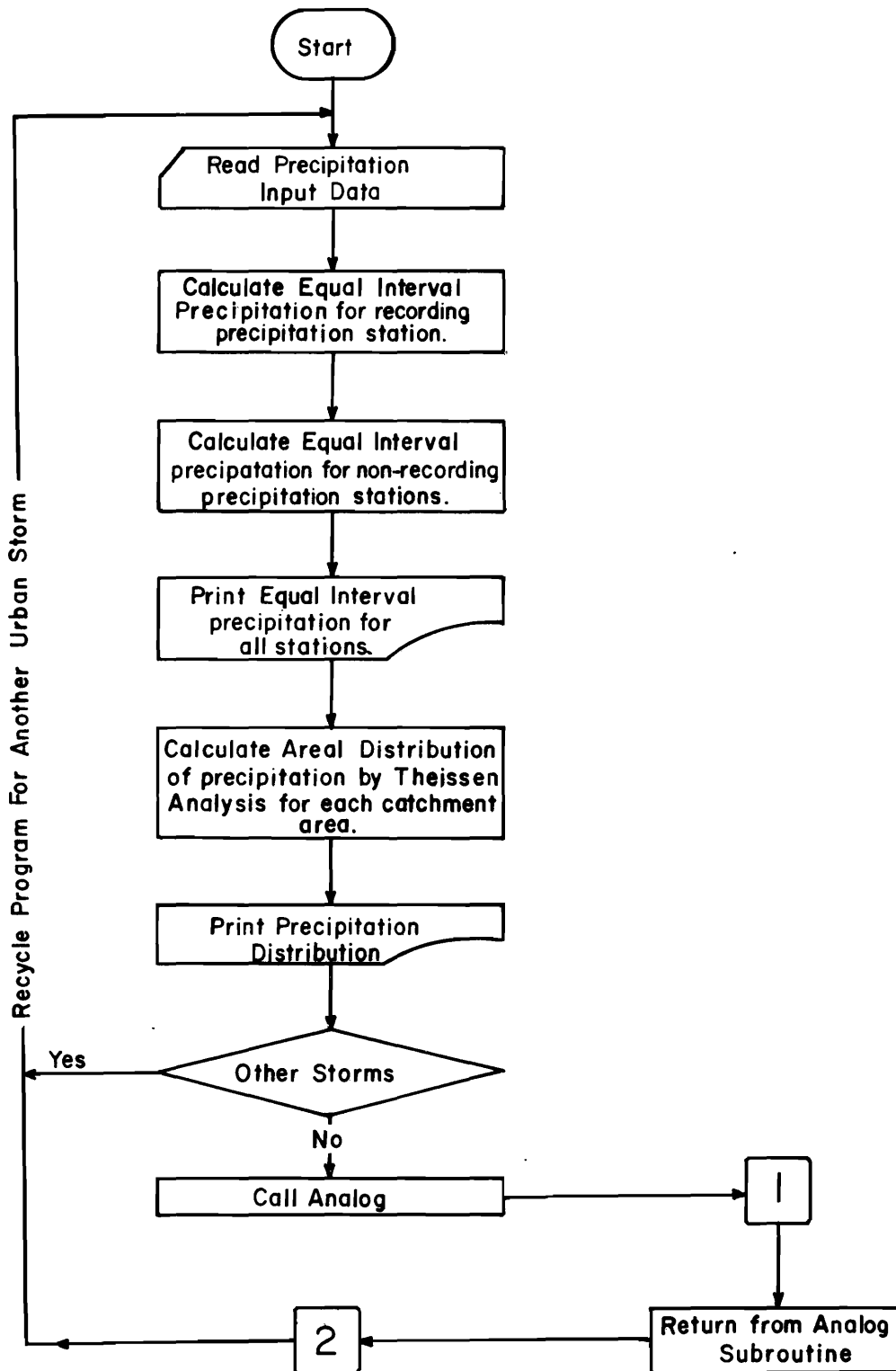

Figure 4.1. Flow diagram of the WATMOD program.

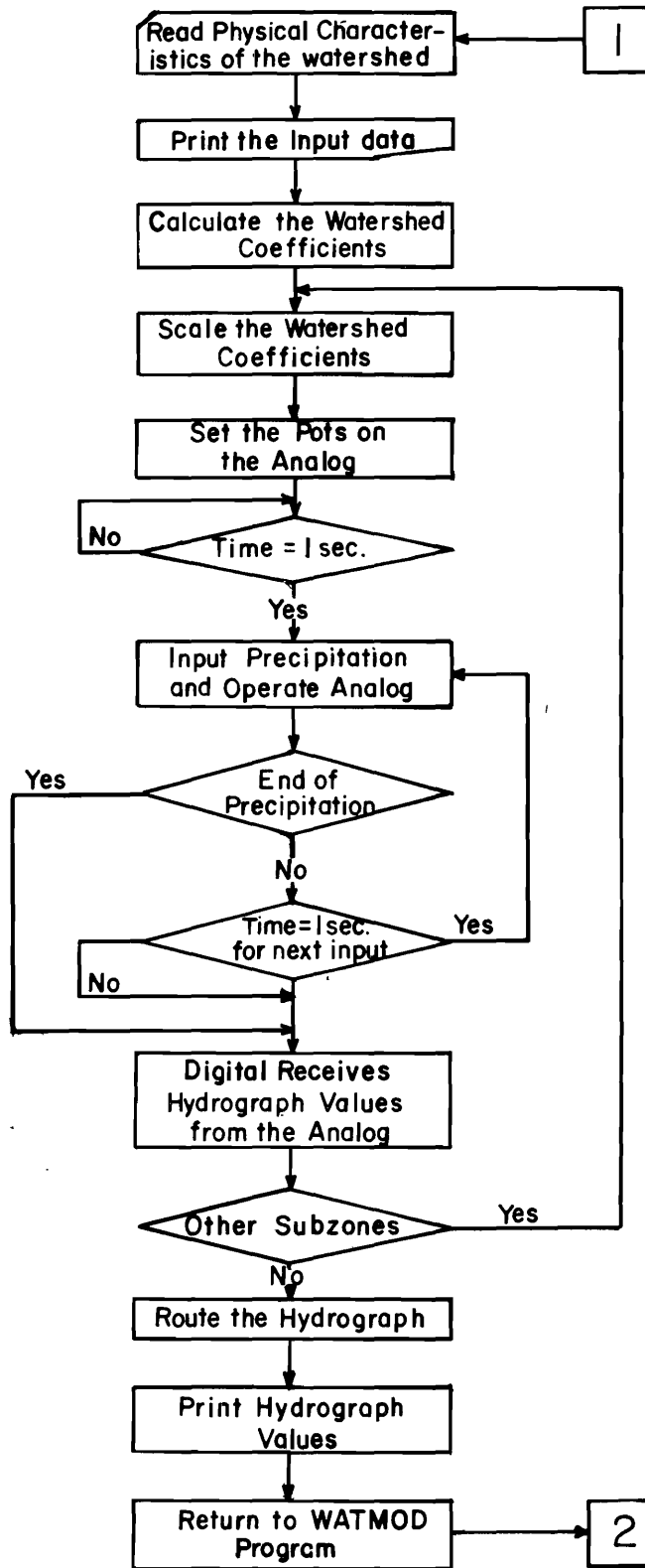

Figure 4.2. Flow diagram of WATMOD subroutine program analog.

The iterative cycle is completed for each catchment area, and the runoff is routed to the outflow point. Each catchment area has this iterative operation performed and the resulting runoff is summed and the volume of flow calculated. By the use of an x-y plotter, a visual hydrograph can be drawn.

### **Analog Program**

The EAI 580 analog computer was used in this study as part of the hybrid system. The iterative capability of the hybrid computer allows various combinations of input parameters to be readily tried, and parameter effects to be visually displayed. Thus, the effects on the outflow of combinations of urban parameters and precipitation can be observed. This can be a great aid in design and economic studies.

Programming the analog computer consists of properly inter-connecting a system of electrical components to simulate linear and nonlinear mathematical equations. The basic mathematical operations which the analog computer can be programmed to perform are: integration multiplication, division, and summation. The proper interconnections of components permit a wide range of mathematical equations to be simulated. Synthesis of the mathematical equations describing the urban watershed on the analog computer is referred to as the analog model.

The analog computer program, illustrated in Figure 4.3, represents the mathematical simulation of the runoff process for the study watersheds within Salt Lake County, Utah. The basic program is discussed as follows.

### **Precipitation**

The precipitation that has occurred during a particular storm or precipitation generated by a random process (stochastic precipitation) is the input variable for a given set of urban conditions.

The input for each period was determined from precipitation records and calculated in equal intervals as previously described by the digital computer program in Appendix A.

The precipitation was subsequently scaled for input into the analog model by dividing the inch/time by the appropriate scaling factor of 1 inch equal to 1 machine unit. This assumed that the precipitation input would not exceed the computer capability and values less than 1 would be the input. This precipitation then had losses subtracted from it to arrive at excess precipitation.

### **Interception**

The expression for capacity rate of inflow into interception storage is given by Equations 2.2 and 2.3. A comparator and a switch after amplifier 08 assures the conditions given by limiting passage of a positive voltage. Referring to Figure 4.4, this circuit generates the desired result at summing amplifier 08 when the proper antecedent value is set.

The initial condition on integrator 00 can be set to either -1 to represent a dry watershed or to 0 to represent a recent storm which has satisfied the interception storage. Potentiometer 01 was introduced between a -1 source and the initial condition on integrator 00 which enables any intermediate value of capacity interception rate to properly represent various antecedent conditions.

### **Infiltration**

The infiltration capacity rate is given by Equation 2.5 along with the conditions defined by Equation 2.6 and assured by a comparator and a switch after amplifier 09 as represented by Figure 4.5. The output of summation amplifier 09 is  $f$ , the desired results of Equation 2.5.

### **Depression storage**

The rate of inflow into depression storage is given by Equation 2.7 along with conditions defined by Equation 2.8. The analog program for these expressions is given by Figure 4.6. This circuit is similar to Figure 4.4 since Equations 2.7 and 2.2 are similar.

### **Overland-channel routing**

The expression that governs the routing of rainfall excess as given by Evelyn et al. (1970) is Equation 2.11.

The circuit diagram to solve for  $dQ/dt$  in Equation 2.11 is shown by Figure 4.7. Potentiometer 17 is equal to the area of the respective subwatershed divided by the total area of the watershed. If the catchment area being modeled is an entire watershed, then the potentiometer is set at 1.0, as was done by Narayana et al. (1969).

### **Channel flow routing**

The expression developed for channel flow routing, Equation 2.14 is solved by the analog circuit in Figure 4.8.

### **The outflow hydrograph**

The graphical representation of precipitation excess with respect to time is called a hydrograph. By

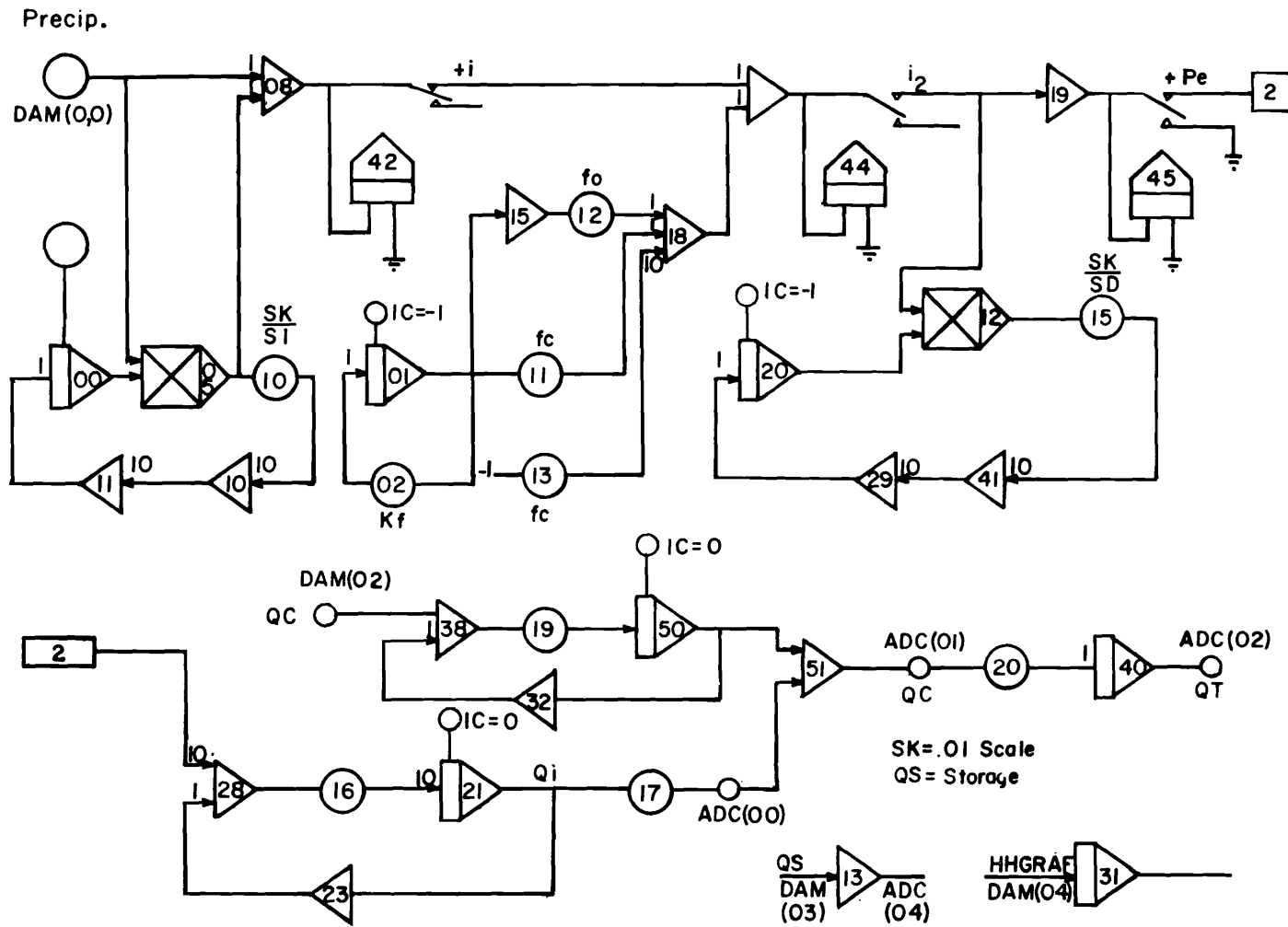

Figure 4.3. Schematic diagram of the analog computer program.

connecting an x-y plotter to the output of the analog circuit, various combinations of hydrographs are possible. By connecting the y terminal of the plotter to the output of amplifier 21, and the x terminal to a time reference, the hydrograph of an individual subzone is obtained. By connecting the y terminal to the output of amplifier 51, the total outflow of the current subzone plus the routed effect of all upstream subzones is obtained. The output of amplifier 40 will yield the total volume of flow (Figure 4.9).

The graphical representation of rainfall called a hyetograph is obtained by connecting the y terminal to the upper input of amplifier 28 and the x terminal to a time reference. Precipitation excess is plotted from the input of amplifier 28 (Figure 4.3).

**Time scaling**

The time scale of 1 second of computer time equal to 30-minutes of physical time reflects the choice made

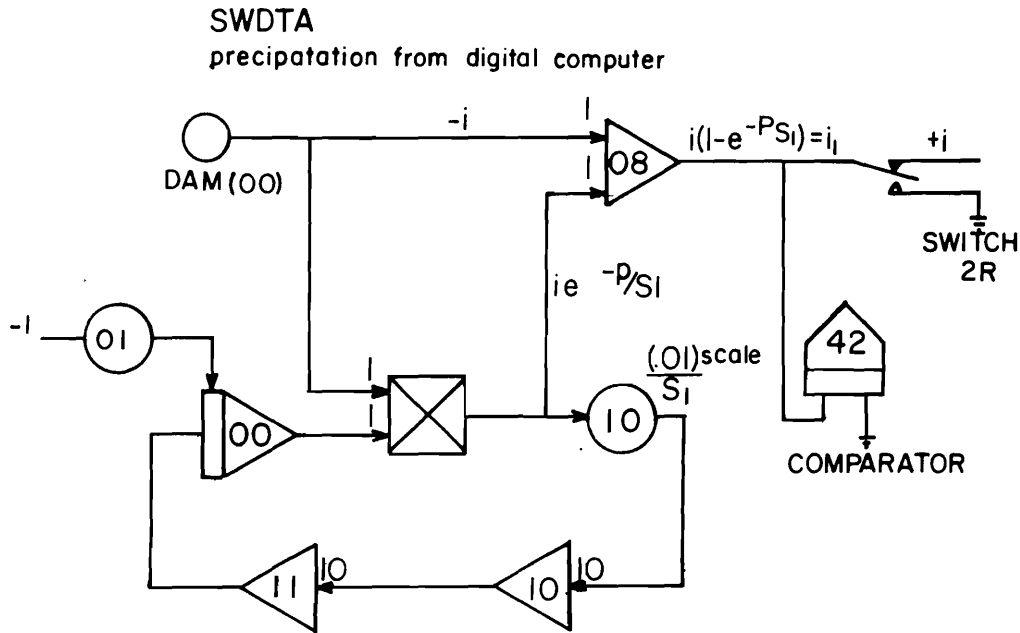

Figure 4.4. Analog circuit for generating the expression for interception rate.

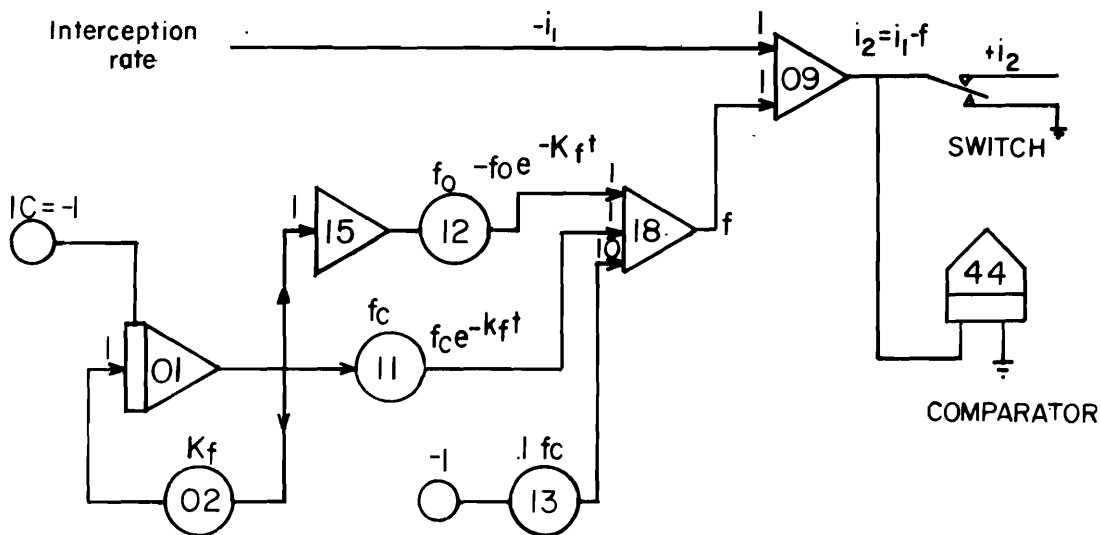

Figure 4.5. Analog circuit for generating the expression for infiltration rate.

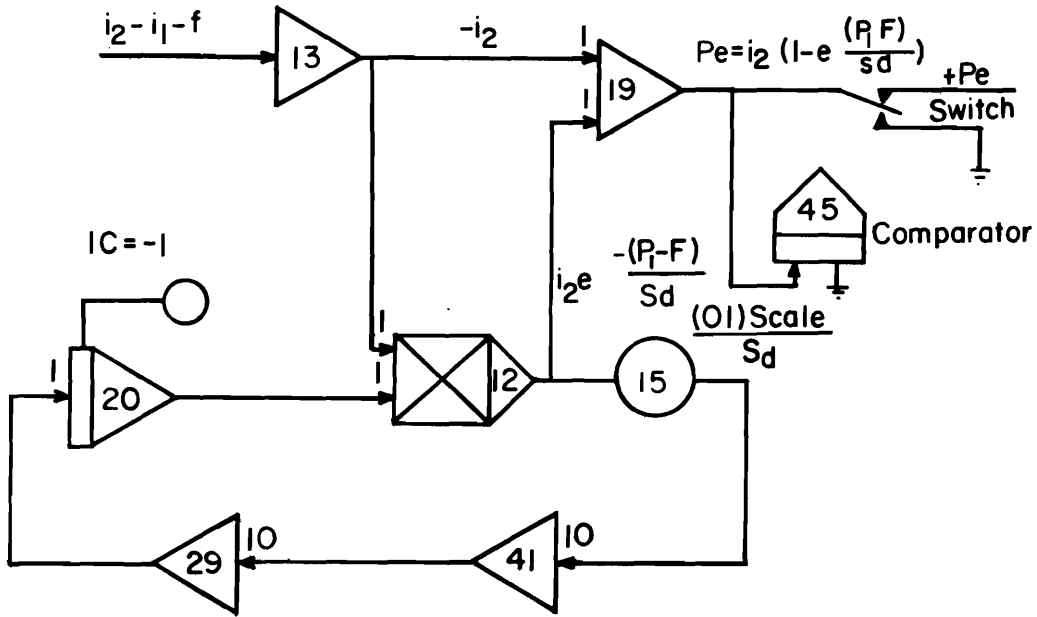

Figure 4.6. Analog circuit for generating the expression for inflow rate into depression storage.

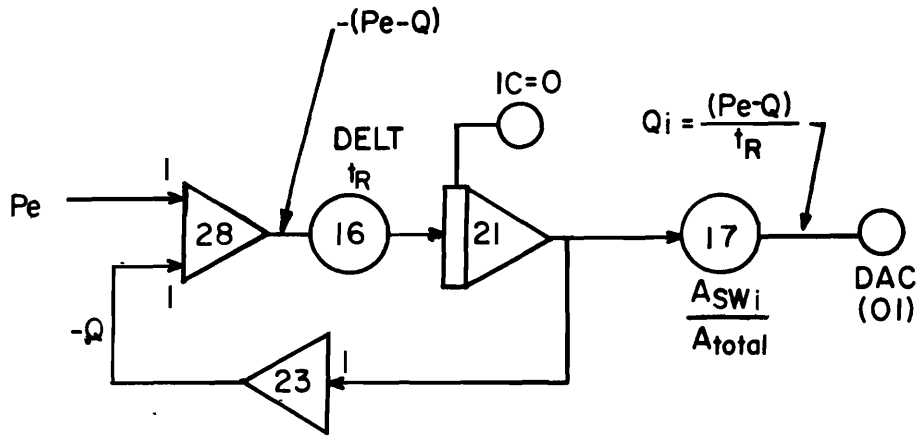

Figure 4.7. Analog circuit for obtaining the subwatershed outflow hydrograph  $t_R$  is the time of rise of storm drain inlet time.

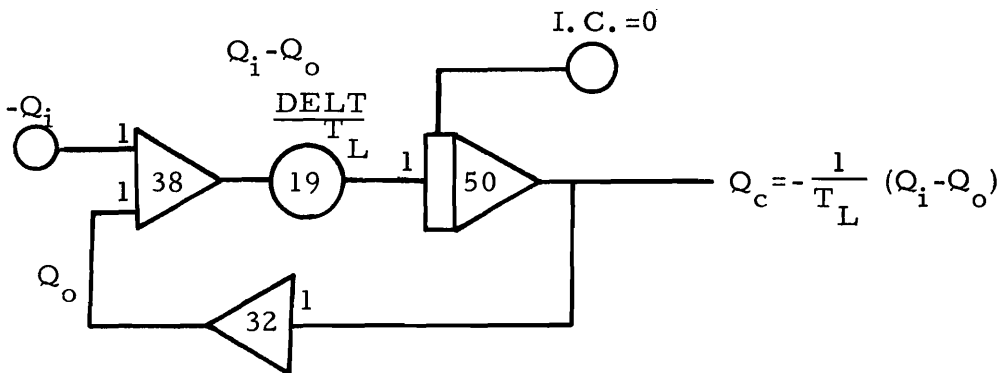

Figure 4.8. Analog circuit for channel routing.



by Narayana et al. (1969) and Evelyn et al. (1970). The statistical equations for the unit hydrograph characteristics were developed for 30-minute durations by Narayana et al. (1969) and Espey et al. (1965), and this time of 30-minute periods permits the direct use of the Narayana et al. (1969) watershed coefficients and the rise time of Espey et al. (1965) as the characteristic time in routing precipitation excess. This time scale of 1 second equal to 30-minutes of real time works quite well with the present inputs and the analog computer.

### Amplitude scaling

The choice of a proper amplitude scale factor for a problem is as important as the choice of time scale. Ideally, a problem should be scaled to keep the output voltage as high as possible without exceeding the maximum voltage range of the computer ( $\pm 1$  machine unit =  $\pm 10$  volts) or allowing the output voltage to drop into the "noise" range.

Richardson (1971) estimated return periods for short-duration precipitation in Utah and found that for a return period of 100 years and a duration of 30 minutes the recording gage at Cottonwood Weir would show 0.89 inch of precipitation. Since this was less than 1.00 inch per 30 minutes, a scale factor of 1.0

was used, and the actual storm values from the recorded data were used. In the event that 1 hour intervals are used, the scale factor should be increased to about 1.13, since for 1 hour duration and a return period of 100 years, Richardson (1971) obtained a precipitation value of 1.13 inches/hour.

The watershed coefficients for surface depression storage and interception storage were scaled, since their units were also in inches. The scale factor used was identical to the precipitation scale factor. The watershed coefficients for time of rise and lag time were not magnitude scaled but were time scaled since their units were in minutes. To convert minutes to 30-minute intervals, the coefficients were divided into the time unit of DELT of the digital program. This general procedure will allow variable time to be used without changing the program, and thus allow the time interval to be changed as needed. For example, a 15 minute time interval might be appropriate for storm sewer system design.

Table 4.1 summarizes the potentiometer settings used in the watershed model. The "pot number" refers to the potentiometer number used in Figures 4.3 through 4.9.

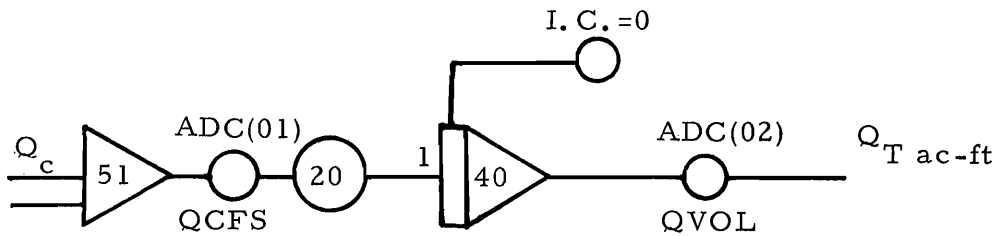

Figure 4.9. Analog circuit for scaling the final outflow and total volume of outflow.

**Table 4.1. Summary of the attenuators (pot) settings on the analog computer.**

Program Section	Pot Number	Variable	Units	Remarks
Interception	01 <sup>a</sup>		Constant	Antecedent soil condition (0 to 1.0) (.01) SCALE/S <sub>I</sub>
	10	S <sub>I</sub>	Inches	
Infiltration	02 <sup>a</sup>	K <sub>f</sub>	Constant	Assumed equal to 0.5 F <sub>c</sub> / SCALE x DELT/60 F <sub>o</sub> /SCALE x DELT/60 F <sub>c</sub> /SCALE x DELT/60 x .10
	11	f <sub>c</sub>	In/hr	
	12	f <sub>o</sub>	In/hr	
	13	f <sub>c</sub>	In/hr	
Depression storage	15	S <sub>d</sub>	Inches	(.01) SCALE/S <sub>d</sub>
Subwatershed out-flow hydrograph	16	t <sub>R</sub>	Minutes	DELTA/t <sub>R</sub>
	17	APOT	Constant	Subzone area/watershed area
Channel routing	19	T <sub>L</sub>	Minutes	DELTA/T <sub>L</sub>
Total volume of the outflow	20		Constant	

DELTA = time interval

SCALE = scaling value to keep pot settings less than 1.0000

<sup>a</sup>Pots are not set automatically by the WATMOD program, but are hand set for each run.



## CHAPTER V

### APPLICATION OF THE HYDROLOGIC MODEL TO THE URBAN WATERSHED

#### Model Verification

The urban hydrologic model discussed in the previous chapter is applied to a particular watershed through a verification procedure whereby the values of certain model parameters are established for a particular prototype system. Verification of a simulation model is performed in two steps, namely calibration, or parameter identification, and testing of the model. Data from the prototype system are required in both phases of the verification process. Model calibration involves adjustment of the variable model parameters until a close fit is achieved between observed and computed output functions. It therefore follows that the accuracy of predictions from the model cannot exceed that provided by the historical data from the prototype system.

In order to provide for the realistic representation of high flow conditions by the hydrologic model, a time increment of one half an hour was adopted. However, the basic precipitation data available are daily totals from non-recording gages and data from recording gages which are published in the form of "Hourly Precipitation Data" by the U.S. Department of Commerce. The daily information from the non-recording gages was then distributed in time on the same basis as the observed data from the recording gages. This procedure is based on the assumption that the time distribution of precipitation is the same at the gaged and the corresponding ungaged locations. It is recognized that this situation might not occur, especially in the case of convective storms.

The computed 30-minute precipitation at each gage location is then spatially distributed in accordance with the Thiessen network of Figure 3.10. For illustrative purposes Figure 5.1 shows isohyetal lines and the precipitation station totals for a single storm event. This procedure of spatially distributing point precipitation measurements is generally regarded as being the most accurate, but it is also the most difficult to implement in a computer. In the case of this study some isohyetal charts for specific events were developed and significant differences were not de-

tected between the spatial distributions of precipitation through the isohyetal and the Thiessen weighting methods. Because it is readily implemented on the computer the Thiessen technique was adopted for this study.

Evaluation of the model parameters can follow any desired pattern, whether it be random or specified. In this study each unknown system coefficient is assigned an initial value, an upper and lower bounds, and the number of increments to cover the range between the assigned bounds. The first selected variable is varied through the specified range while all other variables remain at their initial value. The values of the objective function (measure of error) for each value of the variable are printed, and the value which produces the minimum is stored. After completion of the runs for the first variable, the variable is reset to the initial value and the second variable is taken through the same procedure. After all coefficients have been varied, the set of values which produced each local minimum becomes the new set of initial values and the procedure is repeated. The process is continued until a reasonable correspondence is achieved between computed and observed outflows.

It should be noted that the choice of the variable vector for each phase is based on the judgment and experience of the programmer. However, selection of all variable vectors following the first choice is tempered by the experience gained during the first phase and subsequent phases of the procedure. Thus, model verification effectively uses all previous experience, including that gained during the verification procedure.

Calibration of the model of this study was based on prototype data from three storms. Model output was compared to measured output by computing the sum of the squared deviations, which became the objective function for the pattern search procedure described previously. The three storms required in excess

of 36 solutions of the simultaneous system of equations in terms of water quantities as a function of time. Each of the three storms gave varying values for the five variable parameters. The final value of each parameter was selected objectively to provide the closest agreement between predicted and observed hydrographs for the three storms. These hydrographs represented the out-flow functions from the total drainage area, comprising the three watersheds included in this study.

In order to determine the watershed parameter values for varying degrees of urbanization it was necessary to establish equations for each parameter based upon the urbanization characteristics. These equations are of the form:

$$S_I = a + bC_f + cL_f \dots \dots \dots (5.1)$$

The coefficients a, b, and c are determined for each watershed parameter using the equations determined for each of the three storms. For example, the equations for the parameter  $S_I$  are:

$$S_{I_1} = a - bC_f + cL_f \dots \dots \dots (5.2)$$

$$S_{I_2} = a - bC_f + cL_f \dots \dots \dots "$$

$$S_{I_3} = a - bC_f + cL_f \dots \dots \dots "$$

The values of the coefficients a, b, and c are determined by solving the three Equations 5.2 corresponding to the value of the interception storage capacity,  $S_I$ , as determined for each of the three storm events being used for calibration purposes. Similarly, a set of three equations is derived and solved for three other watershed parameters, namely, the depression storage capacity,  $S_d$ , the initial infiltration rate,  $f_o$ , and the equilibrium infiltration capacity rate,  $f_c$ . Each of these watershed parameters are thus expressed as a function of the two urban parameters, percentage impervious cover,  $C_f$ , and characteristic impervious length factor,  $L_f$ . For particular values of the urban parameters (which characterize the degree of urbanization), values of  $S_I$ ,  $S_d$ ,

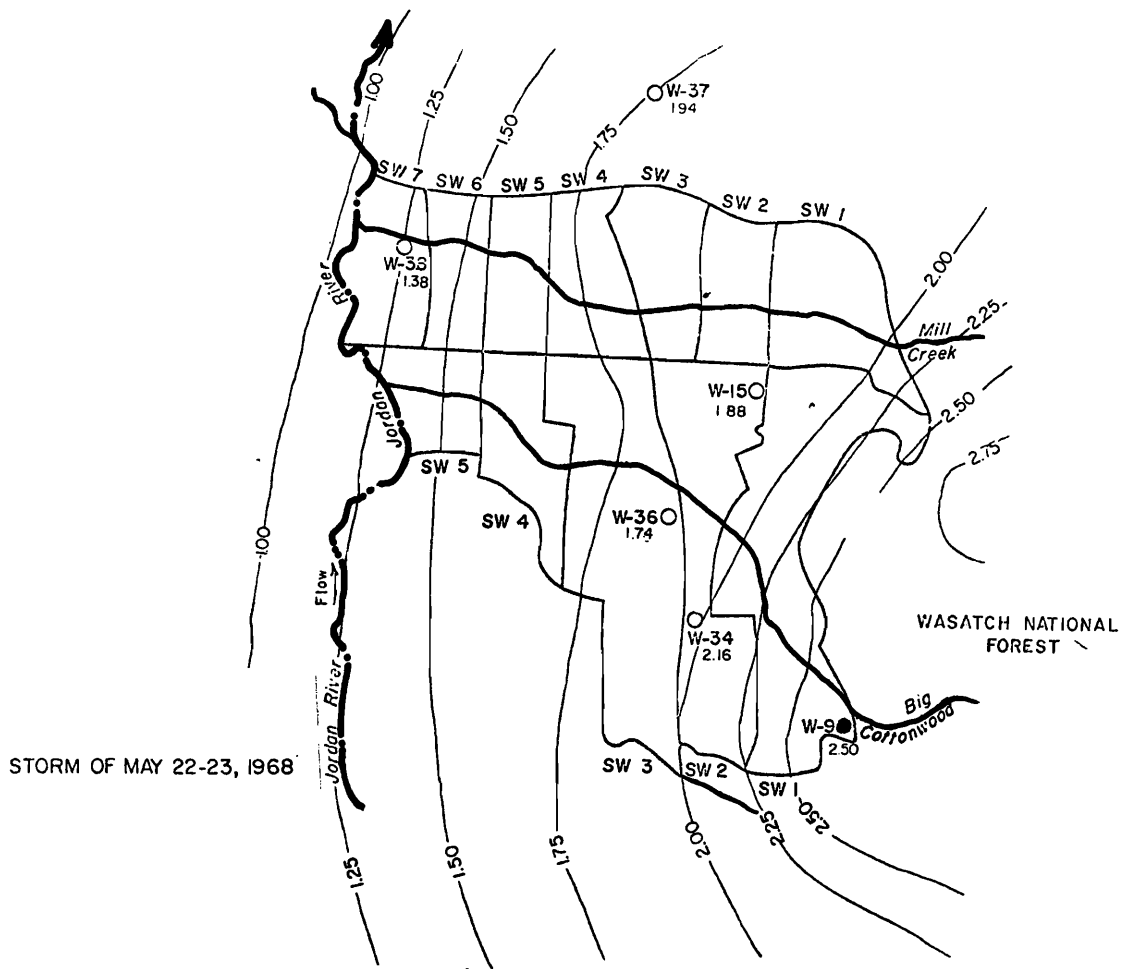

Figure 5.1. Isohyetal lines for the event of May 22-23, 1968.

$f_o$ , and  $f_c$  are calculated from the relationships described above (Equation 5.2, for example), and these values are substituted into the appropriate location in the hydrologic model discussed in Chapter II. A fifth watershed parameter, the hydrograph rise time,  $t_r$ , is estimated as a function of the drainage area.

The five equations thus established for the total drainage area included within this study (Figure 3.4), namely the Mill, Big Cottonwood, and Little Cottonwood Creeks combined, are as follows:

$$S_I = 0.272 - 0.203C_f + 0.022 L_f \quad (5.3)$$

$$f_o = 0.793 - 0.451 C_f - 0.040 L_f \quad (5.4)$$

$$S_d = 0.113 + 0.072 C_f + 0.168 L_f \quad (5.5)$$

$$f_c = 0.277 - 0.247 C_f - 0.048 L_f \quad (5.6)$$

$$t_r = 0.144 A \quad (5.7)$$

A similar procedure was used to determine the equations for the three individual watersheds. A major problem, however, was the lack of individual storm runoff hydrographs for each watershed area. The available runoff records on the Jordan River, of course, integrate the runoff from the three areas of concern in this study. Thus, it was necessary to devise a procedure for separating the total hydrograph into components which could be reasonably assumed to apply to the three drainage areas of interest.

The parameters which were developed as described above for the entire area were used to calculate a single runoff hydrograph for two of the watersheds, for example, Big and Little Cottonwood Creeks, for one of the three storms. This hydrograph was then subtracted from the total hydrograph to isolate the hydrograph for Mill Creek for the chosen storm (say, storm number one). Now, by applying the model and force-fitting the hydrograph, a set of watershed parameters was determined for Mill Creek for storm number one. Using the total watershed parameters for Big Cottonwood Creek and those just determined for Mill Creek, a combined hydrograph for these two watersheds was computed. By subtracting this hydrograph from the total hydrograph, the Little Cottonwood Creek hydrograph was isolated. A force-fit of this hydrograph on the model produced the watershed parameters for the Little Cottonwood Creek. Finally, using the Mill Creek and the Little Cottonwood Creek parameters for the respective areas, a

combined hydrograph was calculated and subtracted from the total watershed hydrograph. The resulting hydrograph was assumed to be the Big Cottonwood Creek hydrograph. A force-fit on the model of the Big Cottonwood Creek hydrograph resulted in determination of the watershed parameters for that sub-watershed. In this way, a set of parameters was established for each watershed for the first storm. This procedure was repeated for the second and third storms, except that the order of subbasin selection was altered to prevent a consistent bias.

The above procedure was followed to estimate individual runoff hydrographs for three storms corresponding to each of the three watersheds within the study area. For each runoff event, the values of the watershed parameters  $S_I$ ,  $S_d$ ,  $f_o$ , and  $f_c$  were determined from the model calibration procedure. The sets of equations of the form given by Equation 5.2 then were solved for each parameter, and thus the coefficients a, b, and c were evaluated to produce equations for each of the three watersheds similar to those of Equations 5.3 through 5.6. A fourth storm event was used to test the equations thus determined. Figure 5.2 gives a comparison of the observed and computed total discharge rates on the Jordan River at stations 1705 and 1710 for the storm of May 23, 1968. The inflow rate to the study area in Mill Creek at this time (station 1700) was negligible and was not included in the calculations.

Obviously, the results leave room for improvement, but would have been better had the individual watershed outputs been gaged. In spite of data deficiencies, the method does provide flood peak estimates for the watersheds at various levels of urbanization.

Establishment of the equations for the watershed coefficients specified the model under all conditions of urbanization. These data and the input data for the desired return periods are used in the model to create graphs of the peak discharge resulting from specified degrees of urbanization for a range of return frequencies as shown in Figures 5.3, 5.4, and 5.5. These graphs are later used to determine flood damages. The predicted runoff rates from the watersheds for the precipitation events of various return periods are shown in Table 5.1. These runoff data result from predicted storm events, not from historical data, and represent the application of the model to the individual watersheds and to the entire drainage area as a whole.

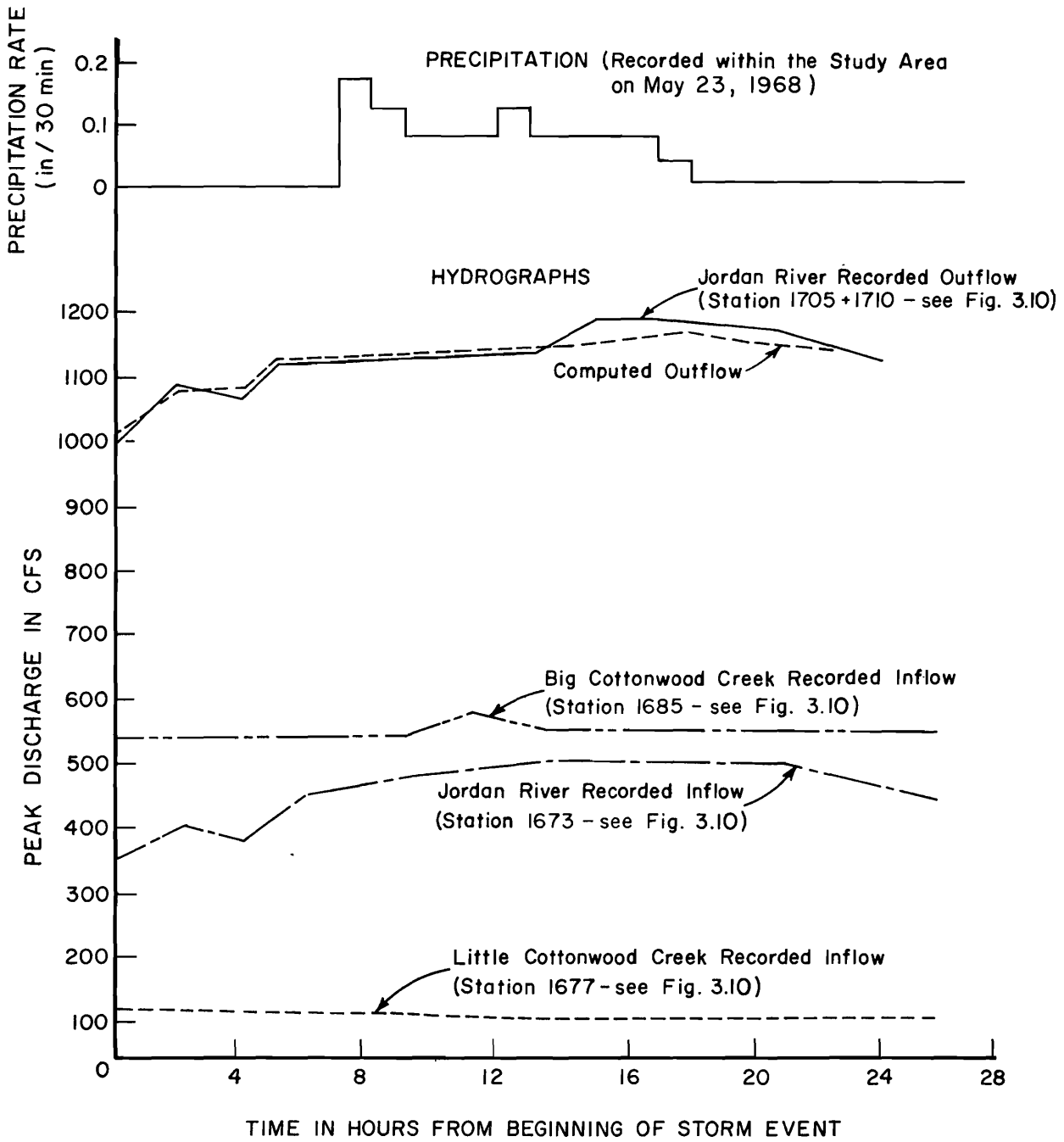

Figure 5.2. A comparison between observed and computed outflow hydrographs from the study area in the Jordan River for the storm event of May 23, 1968.

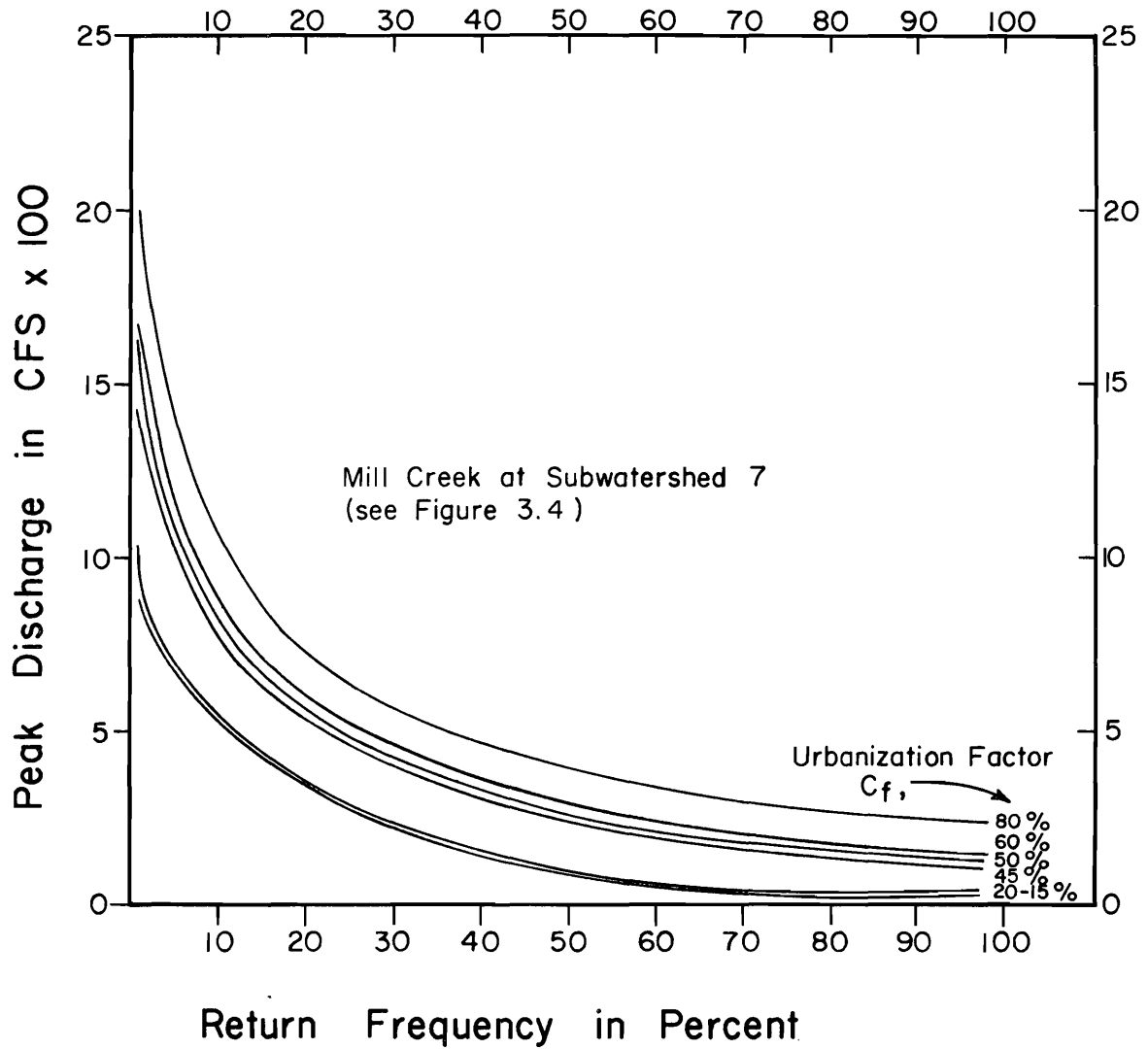

Figure 5.3. Peak discharge rate for Mill Creek as a function of return frequency at different levels of urbanization.



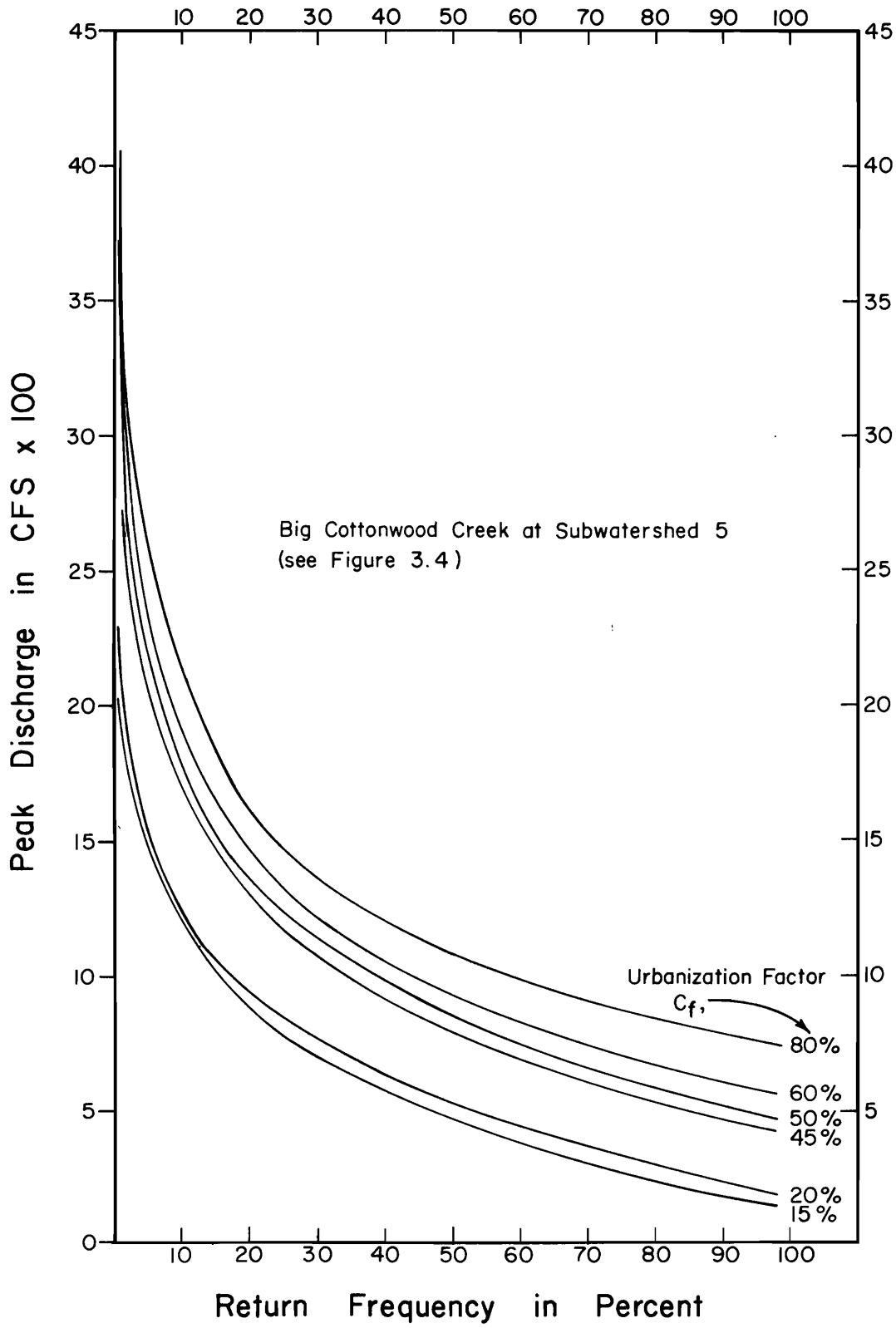

Figure 5.4. Peak discharge rate for Big Cottonwood Creek as a function of return frequency at different levels of urbanization.

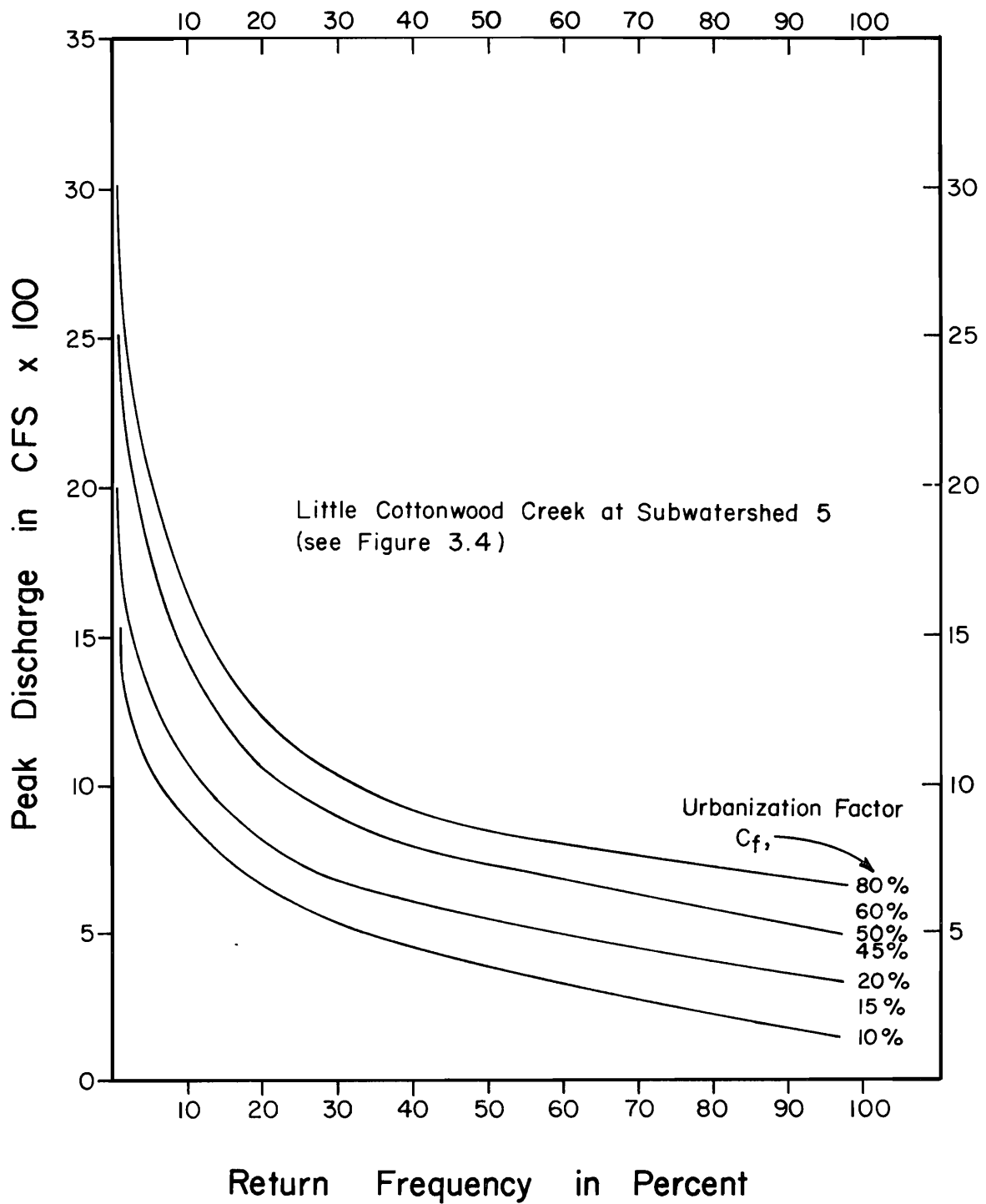

Figure 5.5. Peak discharge rate for Little Cottonwood Creek as a function of return frequency at different levels of urbanization.

**Table 5.1. A comparison of precipitation and computed runoff rates corresponding to rainfall events of specific frequencies within the study area.**

**A. Precipitation in inches**

Precipitation Return Period	Duration of Precipitation Event									
	30 min.		1 hr.		2 hr.		3 hr.		6 hr.	
	High	Low	High	Low	High	Low	High	Low	High	Low
2 years	.41	.37	.52	.45	.62	.51	.72	.60	.96	.72
5 years	.60	.47	.70	.59	.76	.74	.88	.84	1.23	.95
10 years	.75	.48	.72	.61	.90	.79	.97	.94	1.40	1.26
25 years	.85	.55	1.00	.69	1.10	.92	1.17	1.13	1.67	1.38
50 years	1.00	.60	1.15	.76	1.24	1.02	1.26	1.26	1.88	1.48
100 years	1.15	.64	1.30	.81	1.40	1.10	1.44	1.38	2.08	1.66

**B. Discharge in cubic feet per second (cfs)**

Runoff Return Period	Stream and Station Number (see Figure 3.10)									
	Jordan River 1673		Little Cotton- wood Creek 1677		Big Cotton- wood Creek 1685		Mill Creek 1700		Jordan River 1705 & 1710	
	High	Low	High	Low	High	Low	High	Low	High	Low
2 years	900	800	100	50	200	80	50	20	900	600
5 years	1300	900	400	150	600	150	100	50	1300	1200
10 years	1700	1000	700	200	900	250	200	80	1700	1700
25 years	2100	1300	1000	350	1200	600	300	150	2500	2100
50 years	2400	1500	1200	900	1400	1100	500	300	2800	2400
100 years	2700	1800	2500	1400	3000	1500	1400	600	3400	2800

## CHAPTER VI

### ECONOMIC ANALYSIS

A form of economic analysis which is applied to many projects is the benefit/cost ratio. Through this analysis the ratio is determined of the estimated benefits to the estimated costs of a particular project. For the project to be considered viable in an economic sense, it has been necessary for this ratio to exceed one, and for this reason this value traditionally has been an important implementation criterion. The same logic applied to flood control measures (both structural and non-structural) would dictate against implementation of the measures if the estimated average annual costs were to exceed the average annual damages in the absence of the project. In this analysis both average annual cost and damage estimates are adjusted to account for expected operating and maintenance charges and for anticipated future developments within the protected area during the assumed life of the project. This analysis might indicate, for example, that the least expensive action might be to simply repair the flood damage until subsequent development causes the average annual flood damage to exceed the average annual costs of the needed flood control measures. Perhaps a more sound solution would be a phased flood prevention program under which annual costs would increase concurrently with additional benefits resulting from increased development.

Flood protection can be provided by many kinds of structures and procedures, and thus for a given level of protection, costs will vary widely depending upon the plan adopted. Benefits too will vary depending upon the flood frequency to which protection is provided and the values and vulnerability of the property being protected. Thus, for each particular project an economic analysis is needed in which the many variables involved are considered. For each project, however, the optimal point in economic terms is reached when the additional average annual costs of protection are equal to the additional average annual flood protection benefits, or damage saved. As indicated above, both costs and benefits are adjusted to account for anticipated changes during the assumed life of the project. For illustrative purposes, this chapter includes a specific example involving a particular project configuration. However, ultimate decisions on the degree of protection to provide any area are, of course, the responsibility of the appropriate decision-maker. The analysis procedure presented here is

suggested as a means of providing additional information for the decision-maker to assist him in his vital role.

For this project the economic analysis was accomplished by estimating the trend of economic growth on the urban watersheds within the study area, correlating economic growth of the area with increased urbanization, and projecting the flood damages resulting from increased urbanization for the desired return frequency of a runoff producing event. Whenever possible, data from previous studies were used.

#### Population Projection

The problem of projecting the total population of an area with respect to time is subject to many difficulties. In this case, population projections were based on trends published by the Corps of Engineers (1969), Wasatch Front Regional Council and the Salt Lake County Planning Commission (Hachman, 1975). From these sources the graph of Figure 6.1 was developed and used to predict the population growth in the study area for a 100 year period, using 1975 as the base year.

#### Per Capita Income Projection

Income projections are based on assumed economic trends which, like population trends, are subject to many unforeseen factors or conditions. For this reason, income projections too pose problems of reliability. The projection which was applied in this study is shown by Figure 6.2. It might be noted that at the higher per capita income levels a correspondingly smaller portion of the income is spent on durable goods which are subject to damage. This tendency was incorporated into the plot of Figure 6.2. The data used to compile this curve were derived from the Office of Business Economics and its predictions for the Salt Lake City area (1968).

#### Area Flooded versus Stream Discharge

The curve relating flooded area to the stream discharge was constructed from data available from the Corps of Engineers (1969), and from data extracted

from areal photographs. For each stream, the flooded area at a given flow is almost independent of the degree of urbanization, except for hydraulic structures erected during the urbanization process. For this study it was assumed that areas flooded by a given discharge were equal for rural and urban conditions. However, flood damages vary greatly between rural and urban conditions. Figure 6.3 shows the flooded area on each drainage for storms producing the indicated flow rates. For each stream, the model was used to estimate peak discharge rates corresponding to storms of particular return periods. These peak flow rates then were related to flooding events of a particular aerial extent on areas having specified degrees of urbanization.

### Rate of Urbanization

The development of a relationship between time and degree of urbanization for the study area was based on some qualitative observations and compari-

sons of known data. Based on estimated population trends (Figure 6.1), it is considered that the population of Salt Lake County will increase by about three times in the next 100 years. The population of the study area, being close to Salt Lake City, probably will increase at a somewhat faster rate. The urbanization level, in terms of impervious cover,  $C_f$ , of the study area at the present time is about 15 percent. Data from the Chicago area are shown by Figure 6.4 which is a plot of population density versus percentage urbanization. From this plot population figures corresponding to 10 percent and 60 percent of urbanization are, respectively, 10,000 and 40,000 people per square mile, or a population increase of about four times the original. Because of the expected future stabilization of the national population, the Salt Lake City area likely will not become as crowded as the Chicago area. However, these data observations did provide some points of reference and trends for the shaping of a similar kind of s-curve for the study area, and this curve is shown by Figure 6.5.

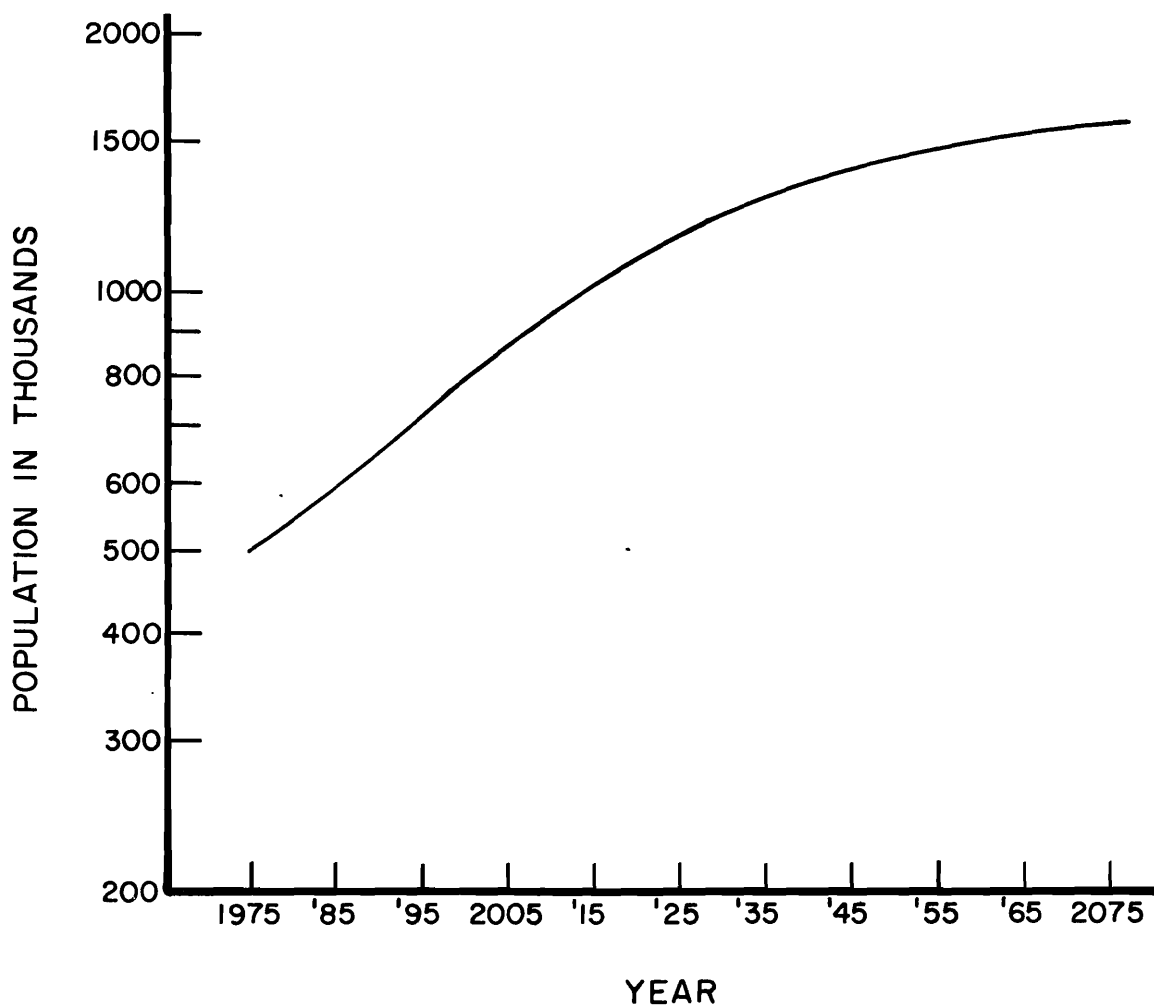

Figure 6.1. Population projection for Salt Lake County.

### Projection of Flood Damage as a Function of Time

The first step in estimating potential flood damages within the study area is to utilize the discharge-frequency relationships at different stages of urbanization which are obtained from the hydrologic model, and which are shown in Figures 5.3, 5.4, and 5.5. First, a particular degree of urbanization is selected. For the selected degree of urbanization, a peak flow rate corresponding to a known frequency for a particular stream is obtained either directly from the hydrologic model or from plots developed by operating the model over a range of conditions (Figures 5.3, 5.4, and 5.5). For example, for Big Cottonwood Creek at a degree of urbanization of 20 percent and a return frequency of 30 per-

cent, the estimated peak discharge rate is approximately 750 cfs (Figure 5.4). Figure 6.3 provides an estimate of the extent of flooding which would result on the urbanized area of the Big Cottonwood Creek watershed from a flow of this magnitude.

The resulting damages in monetary units are obtained from the relationship of Figure 6.6 which indicates the estimated damages as a function of degree of urbanization. Figure 6.6 is based on 1975 prices and economic conditions, and, if estimates were required to reflect conditions at any particular time in the future, some adjustment of this curve would be necessary in terms of future trends (either assumed or known).

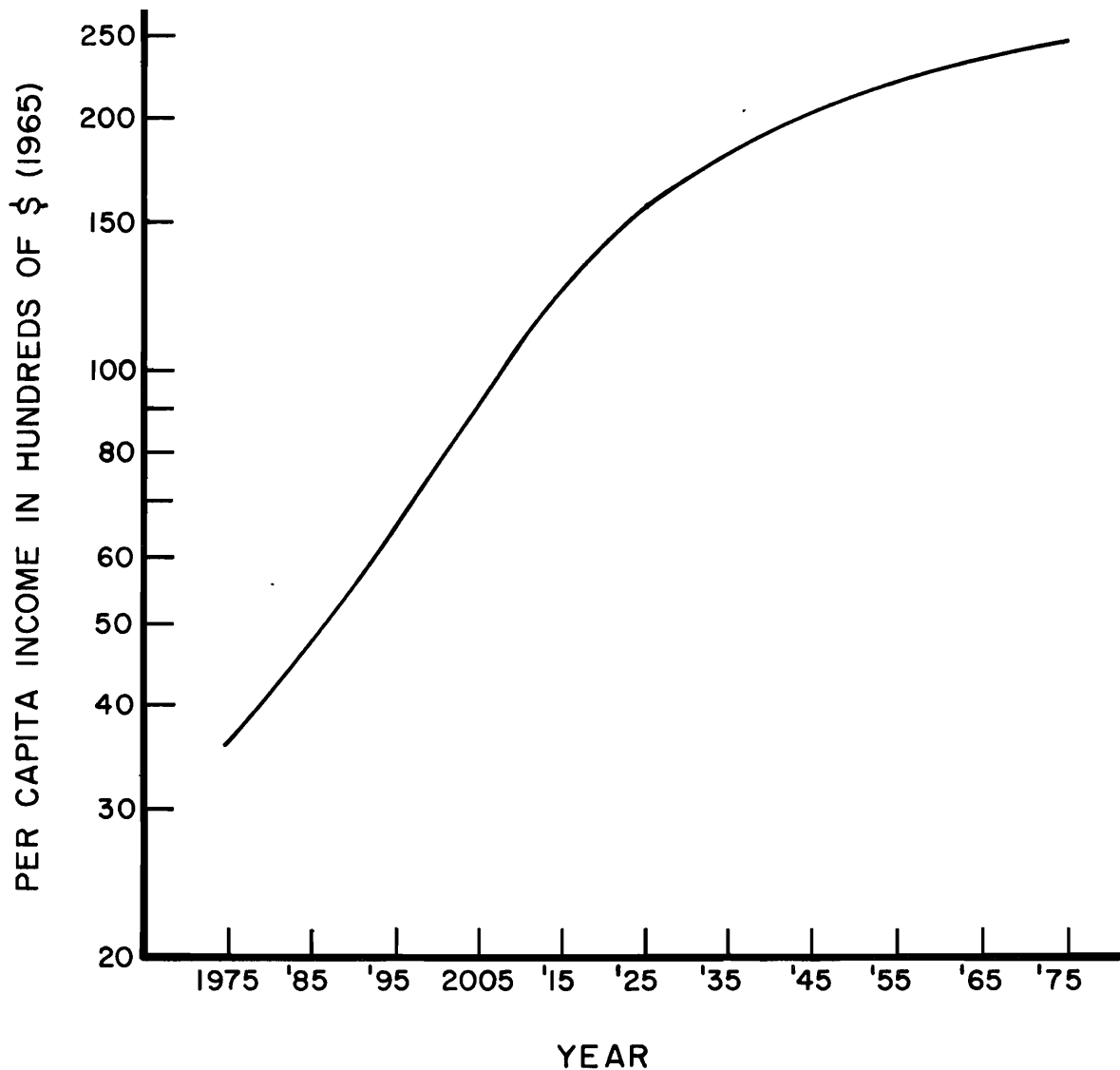

Figure 6.2. Per capita income projection for the Salt Lake City area.

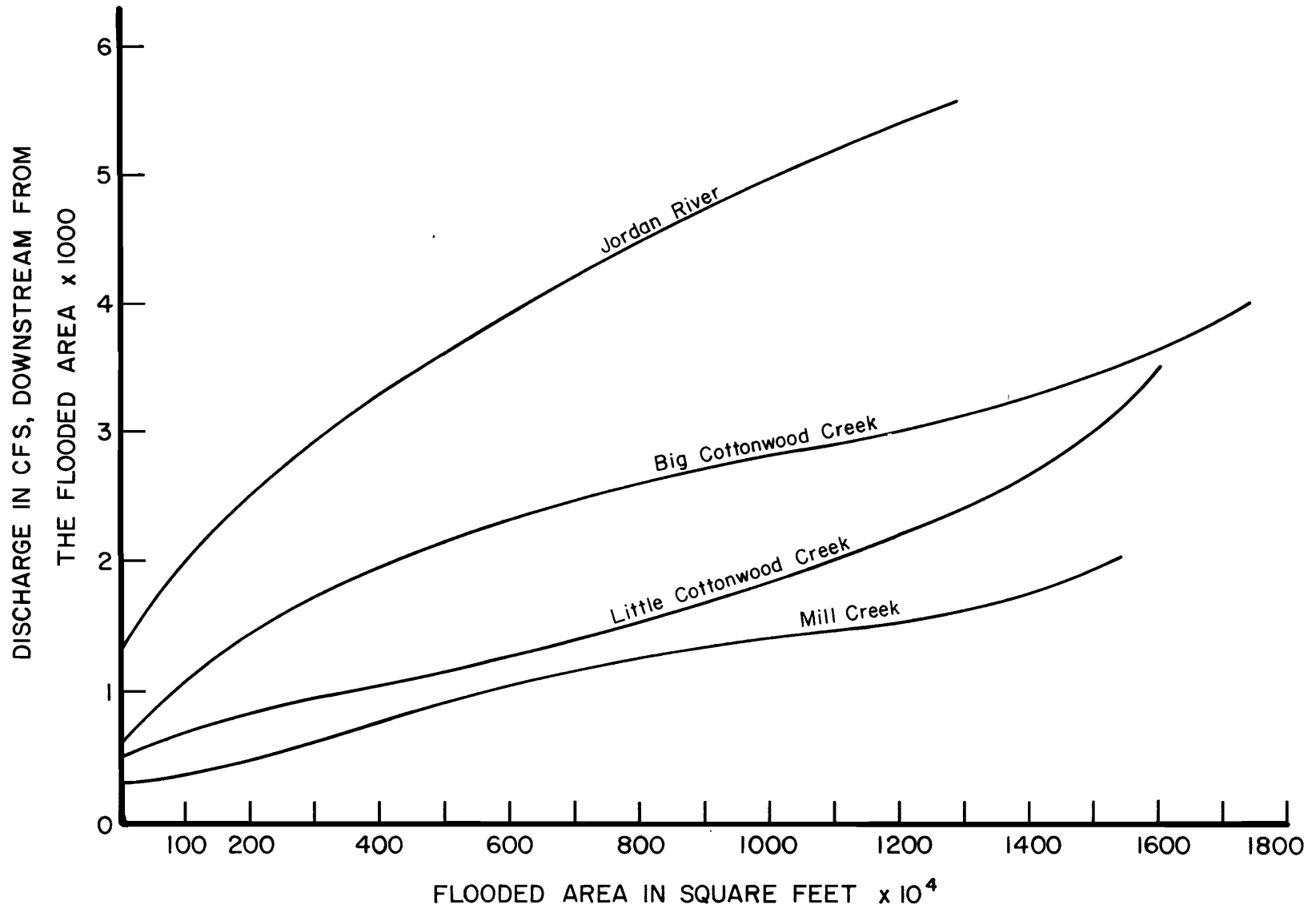

Figure 6.3. Relationships between discharge rates and flooded area for various streams within the study area.

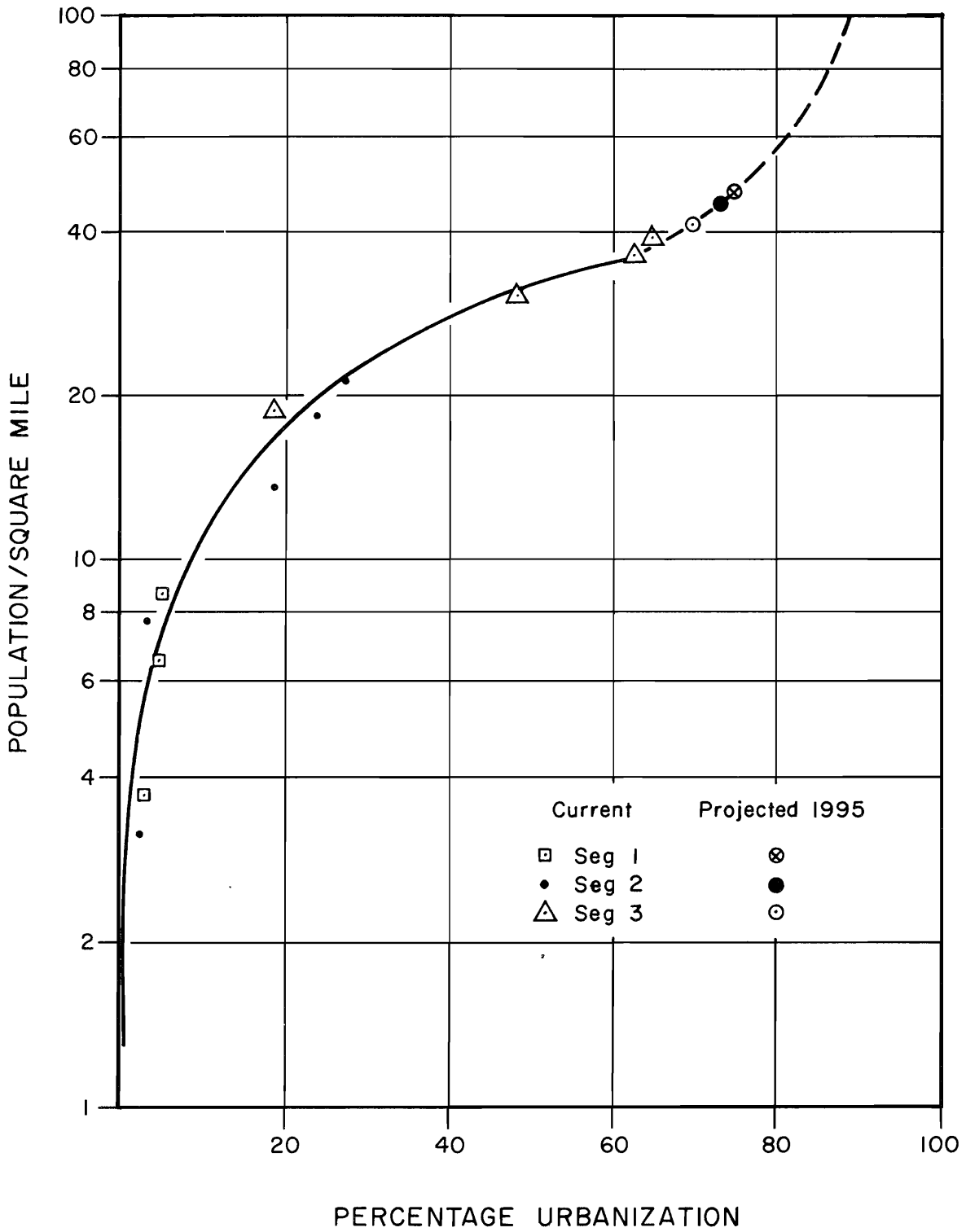

Figure 6.4. Relationship between population density and percentage urbanization for the Chicago area (from Hydrocomp International (1971)).



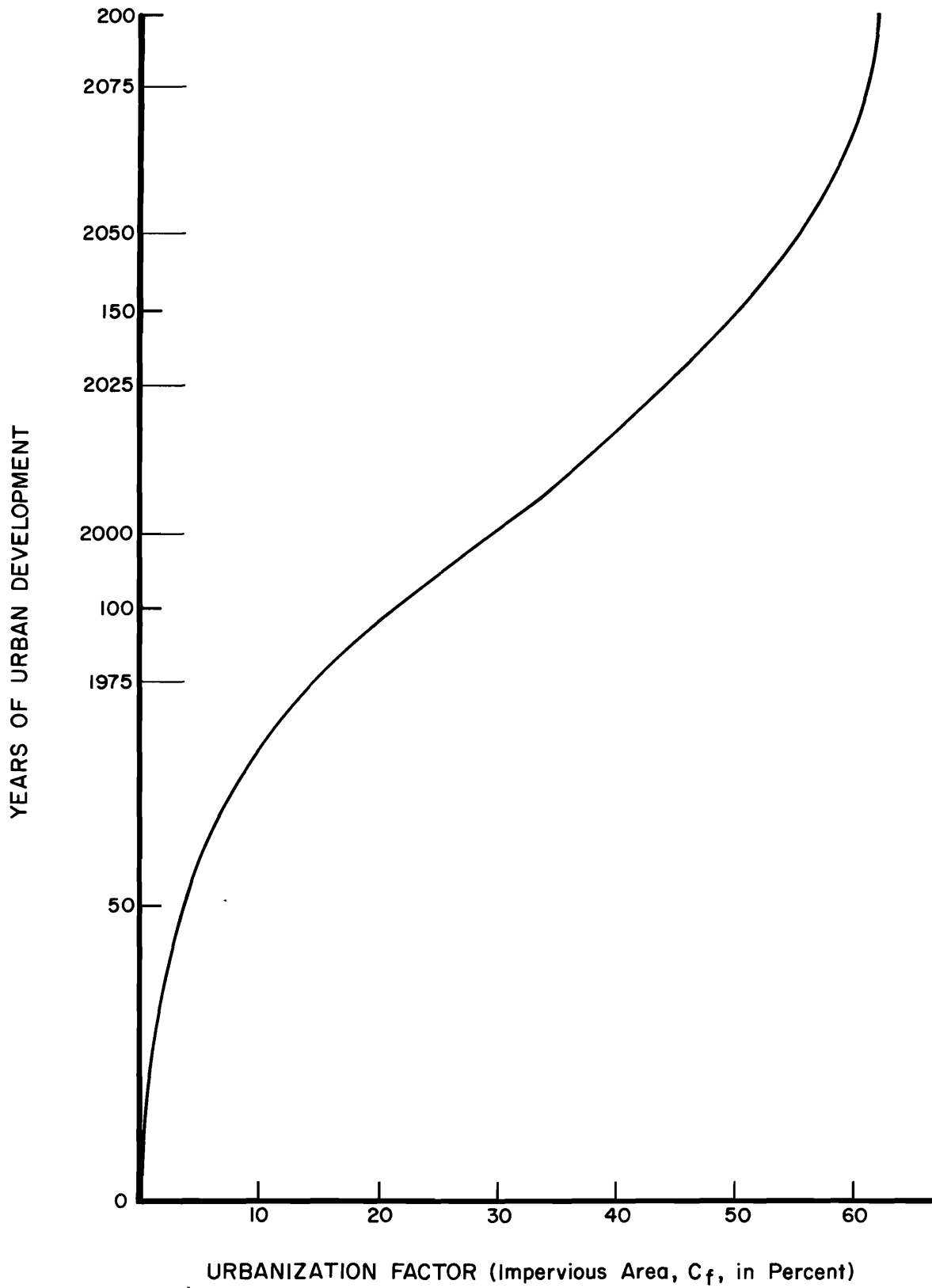

Figure 6.5. Projected urbanization as a function of time for the study area.

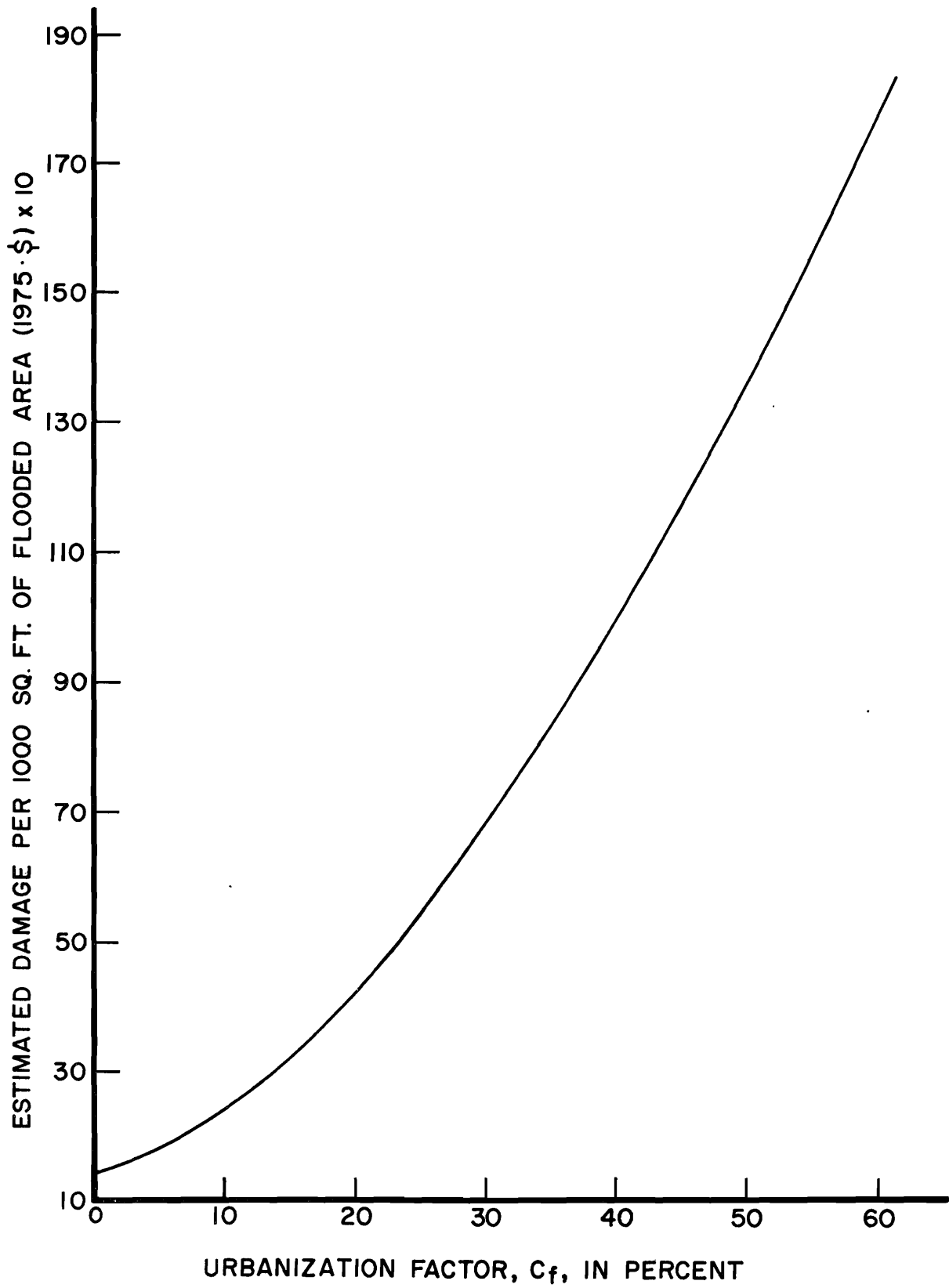

Figure 6.6. Estimated flood damages per unit area as a function of urbanization level.

The above procedure is repeated for runoff events of various frequencies, and in this way a frequency versus damage curve is developed for the watershed corresponding to a particular degree of urbanization. The lower plot of Figure 6.7(a) is a frequency-damage curve for Big Cottonwood Creek at a degree of urbanization of about 15 percent (present conditions). A summation of the area beneath this curve provides an estimate of the average annual damages resulting from all floods within the urbanizing area of the watershed at the assumed level of urban development. In this case, the estimated average annual flood damage on the Big Cottonwood Creek portion of the study area at a degree of urbanization of 15 percent is \$0.10 million.

Similar curves were derived for projected degrees of urbanization of 45 and 60 percent and these also are shown in Figure 6.7(a). The average annual damage corresponding to each degree of urbanization is estimated by summing the area beneath the appropriate curve. As indicated by Figure 6.5, degree of urbanization represents a time trend. Thus, degrees of urbanization of 45 and 60 percent within the study area correspond to time horizons of 50 to 100 years, respectively. Figure 6.7(b) is derived from Figure 6.7(a), and is a plot of average annual damage as a function of time. It is noted that the damage estimates shown by these figures do not reflect changes which would result from the adoption of flood control measures, both structural and non-structural. However, the curve of Figure 6.7(b) does provide an economic basis for evaluating proposed flood control measures. Using the same procedures, similar plots of flood damage estimates as a function of time were developed for the remaining two watershed areas included in this study, namely Little Cottonwood and Mill Creeks. These curves are shown by Figures 6.8 and 6.9, respectively.

### An Application Example

The following material is intended to illustrate the application of the procedure discussed in the foregoing portions of this chapter. It is emphasized that the procedures utilize standard and well recognized methods of economic analysis. The procedure does, however, depend upon discharge-frequency information for various levels of urban development as provided by a computer model of the urban hydrologic system (Figure 5.4, for example). From the flood flow corresponding to a particular degree of urbanization and frequency of event as given by Figure 5.4, the flooded area is estimated from Figure 6.3. The resulting damage is given by Figure 6.6, thus providing a point for a damage versus event frequency plot at a particular level of urbanization. It is emphasized that the steps outlined above and the information provided by Figures 6.3 and 6.6 also could be incorporated into

the computer model, thus enabling the entire analysis to be performed by a comprehensive version of the model.

In the example which follows an evaluation is made of a proposed impounding reservoir to regulate the flow of Big Cottonwood Creek. The design of the reservoir includes the following criteria:

Peak inflow rate--2,500 cfs	
Peak outflow rate--600 cfs	
Storage capacity--90 ac-ft.	
Construction costs	\$240,000
Sprinkler system & landscaping	60,000
Right-of-way costs	<u>227,000</u>
 Total costs	 <u>\$527,000</u>

Assumptions made for the purposes of this example are:

1. Snowmelt floods do not occur simultaneously with local cloudburst rain storms.
2. The reservoir is constructed for flood control only and will be operated optimally for that purpose; that is, the reservoir will be assumed to be empty at the beginning of each flood event and the reservoir will be operated to minimize the peak of the downstream hydrograph.
3. Benefits other than flood peak reduction are not considered.
4. The life of the structure is assumed to be 100 years.
5. Annual operation and maintenance costs are \$10,000.

The following steps were followed in the analysis:

1. Modification of the flow-frequency curves. The hydrologic model was modified in accordance with the above assumptions and reservoir characteristics. The model then was used to generate information for a new set of flow-frequency curves which reflect the effects of the proposed impounding reservoir (Figure 6.10). The effects of the reservoir are shown by comparing Figures 5.4 and 6.10. For example, again referring to an urbanization of 20 percent and a return frequency of 30 percent, the unmodified peak discharge is 750 cfs (Figure 5.4), whereas the corresponding modified discharge rate is 675 cfs (Figure 6.10).

2. Constructing damage - frequency plots. These plots are similar to those of Figure 6.7(a) except that

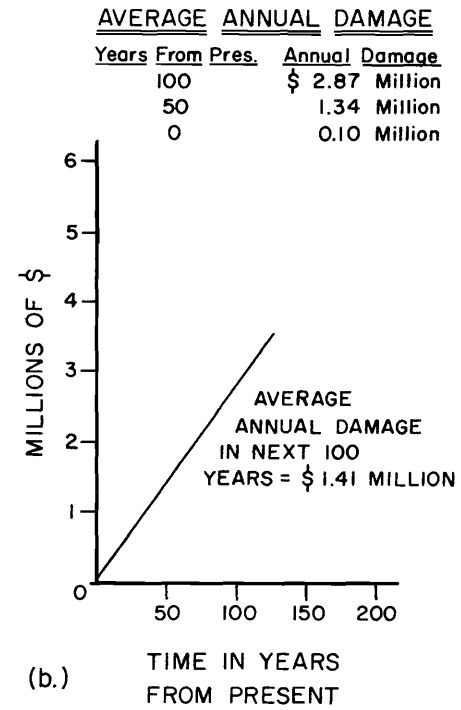
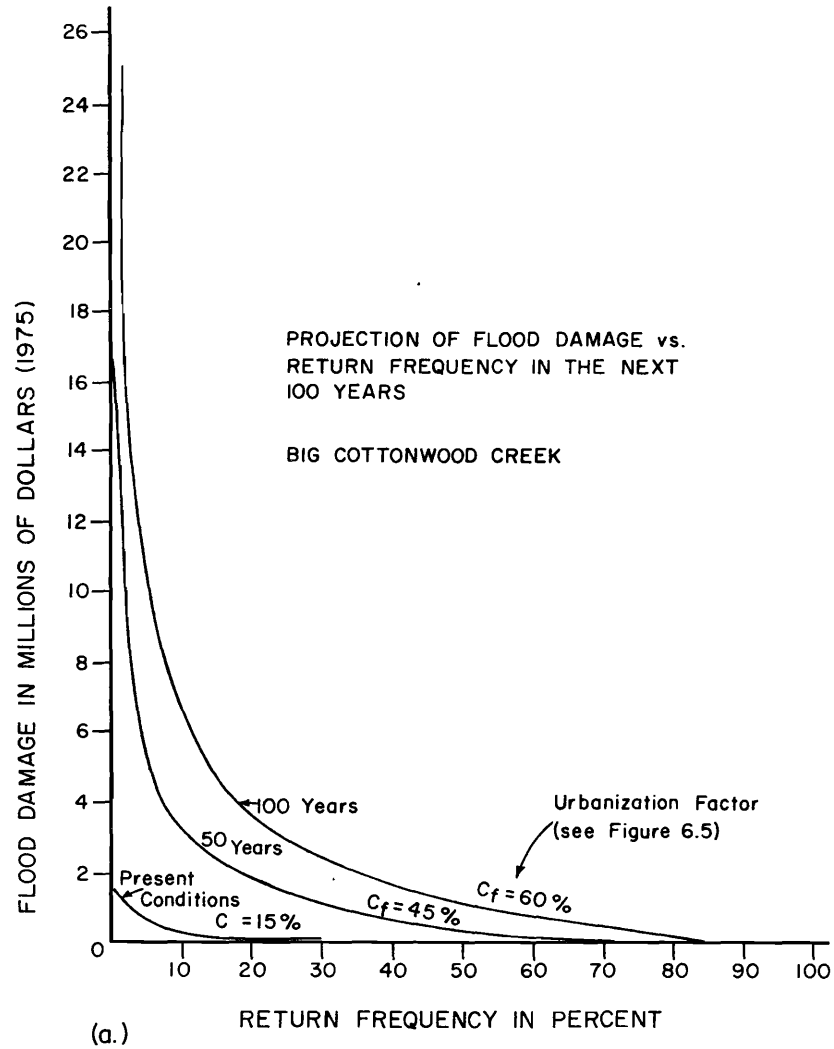

Figure 6.7a. Projected flood damages as a function of event frequency for various levels of urbanization (or time horizon) from Big Cottonwood Creek.

Figure 6.7b. Estimated average annual flood damages as a function of time from Big Cottonwood Creek.

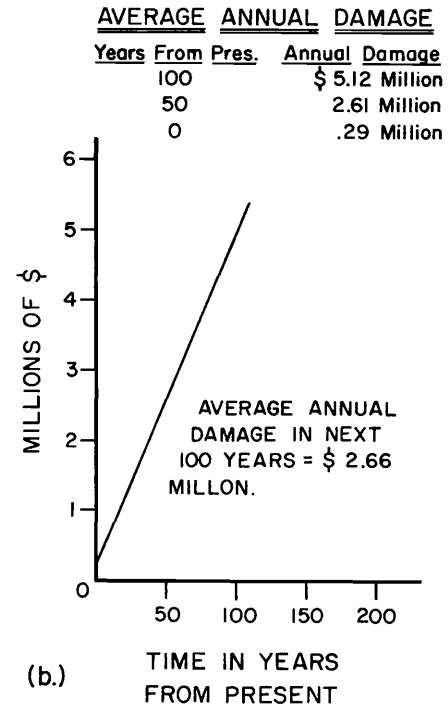
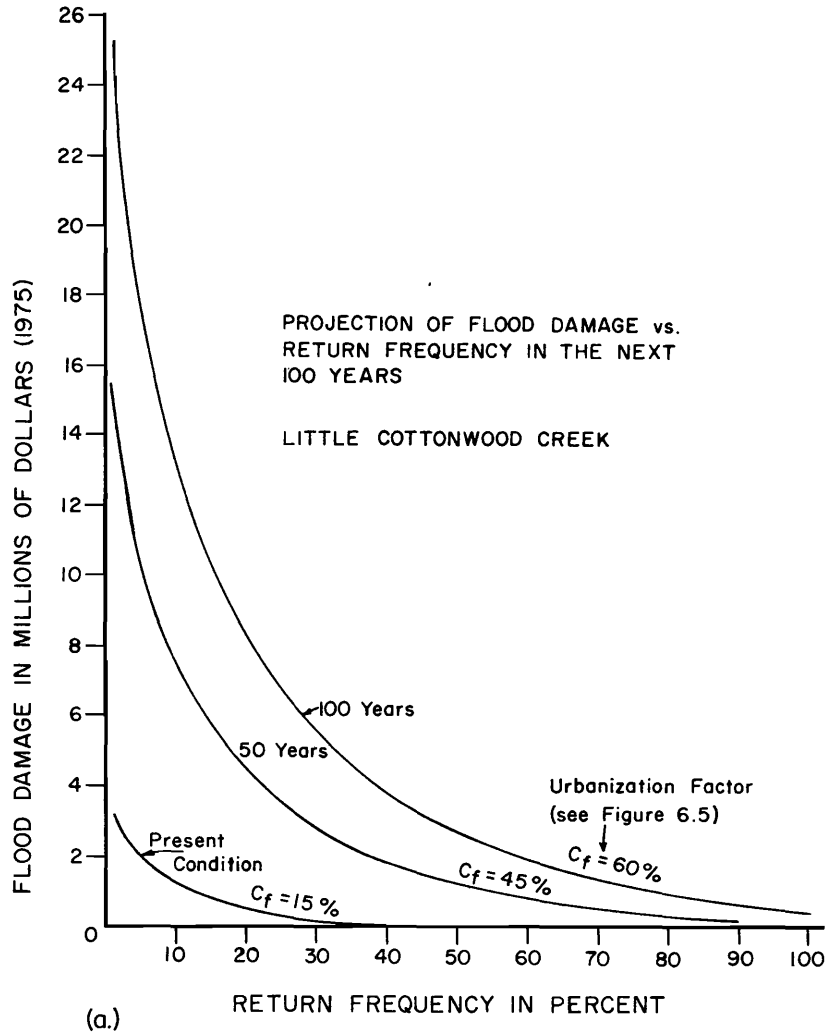

Figure 6.8a. Projected flood damages as a function of event frequency for various levels of urbanization (or time horizon) from Little Cottonwood Creek.

Figure 6.8b. Estimated average annual flood damages as a function of time from Little Cottonwood Creek.

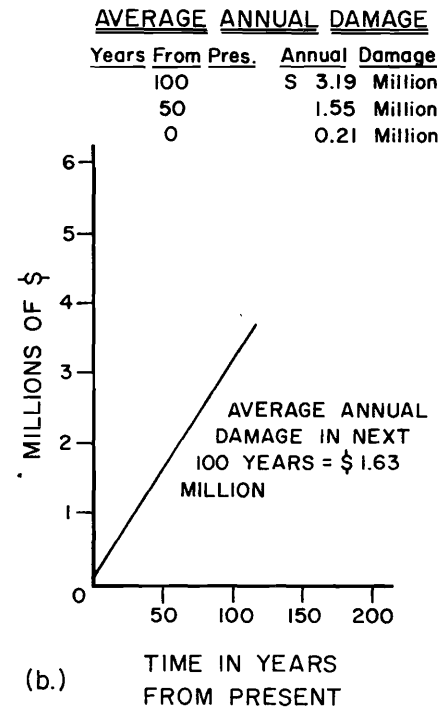
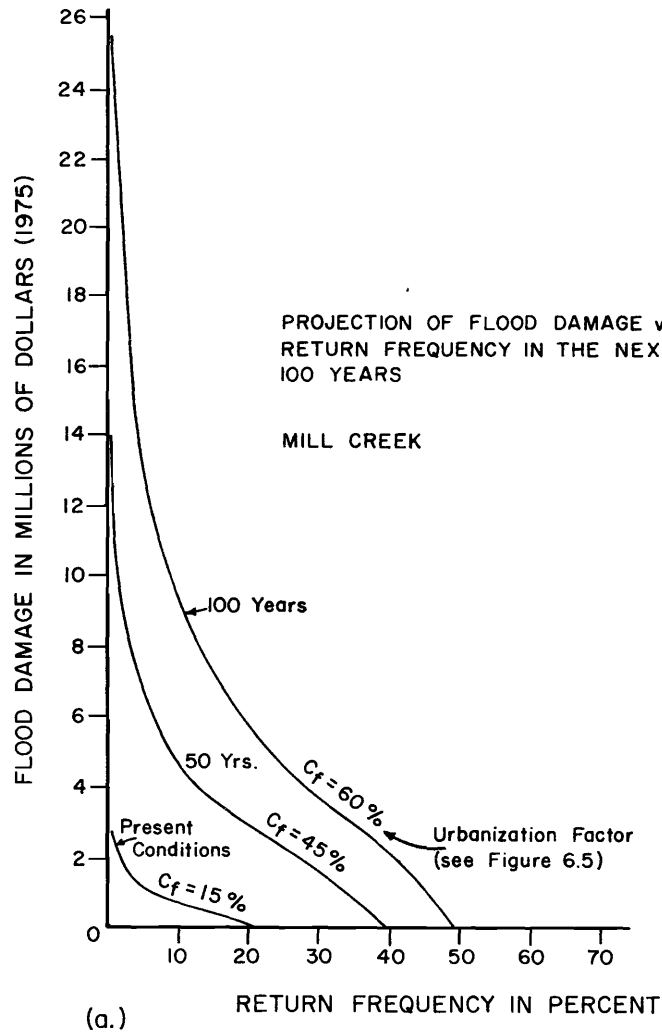

Figure 6.9a. Projected flood damages as a function of event frequency for various levels of urbanization (or time horizon) from Mill Creek.  
 Figure 6.9b. Estimated average annual flood damages as a function of time from Mill Creek.

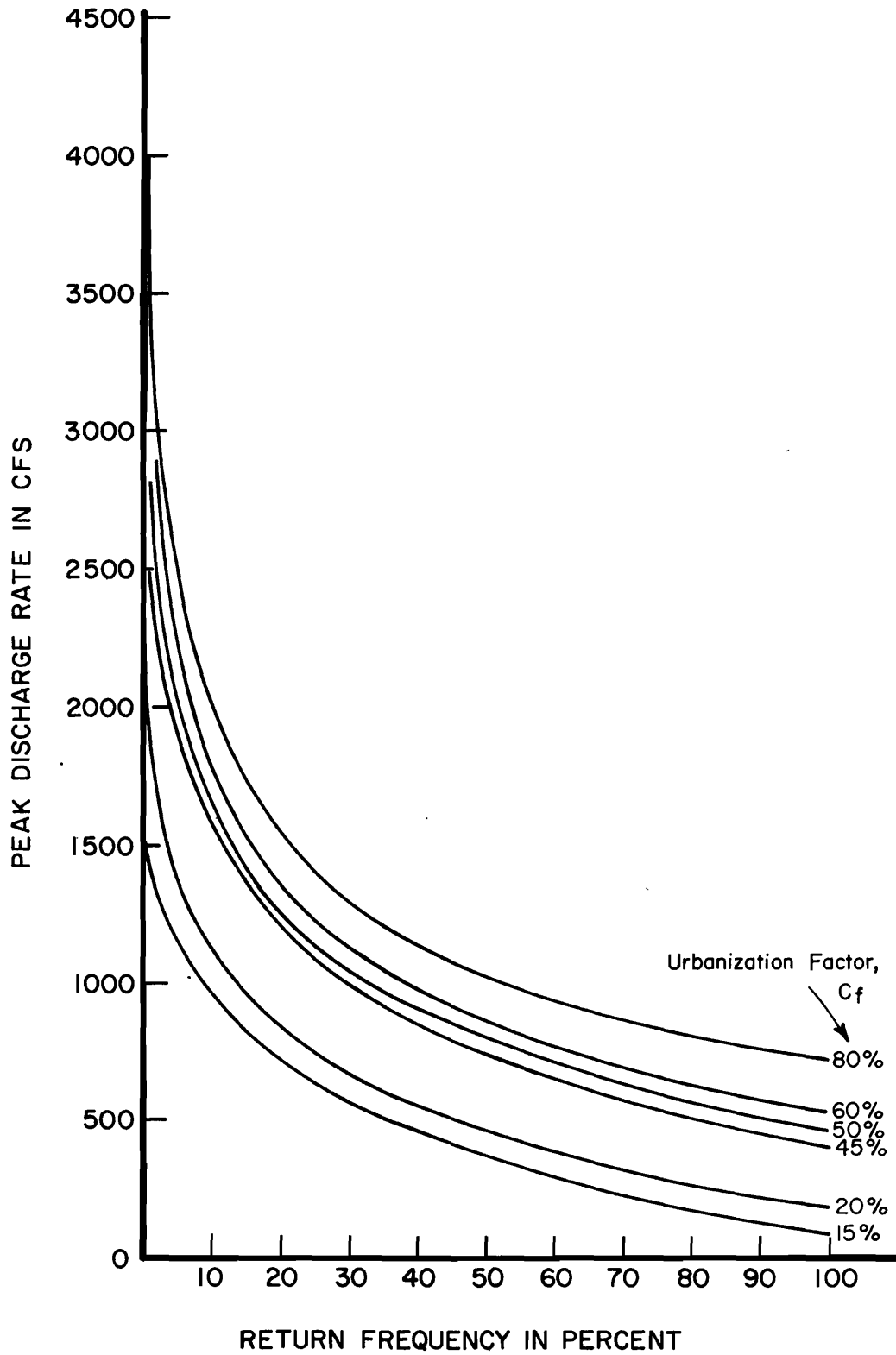

Figure 6.10. Peak discharge rate for Big Cottonwood Creek as a function of return frequency at different levels of urbanization and as modified by the impounding reservoir.

the curves now include the effects of the impounding reservoir. The following are the steps used in developing these curves.

a. For a particular flood frequency and level of urbanization, determine the corresponding peak discharge rate from Figure 6.10. As previously indicated, the present level of urbanization within the study area is about 15 percent, and this point is shown on the plot of Figure 6.5 as that corresponding to the year 1975.

b. Apply the peak flow rate from step (a) above to the Big Cottonwood curve of Figure 6.3 to estimate the flooded area in square feet.

c. For the same level of urbanization from step (a), use the curve of Figure 6.6 to estimate the damage costs in 1975 dollars.

d. For the same assumed level of urbanization, use the same procedure to estimate flood damages corresponding to a sufficient number of return frequencies to plot a frequency-damage curve at the assumed level of urbanization. In this case Figure 6.11(a) was developed by plotting curves for present conditions and for 50 years and 100 years in the future. Figure 6.5 was used to predict levels of urbanization at the two planning horizons of 50 and 100 years.

### 3. Determining the benefit-cost ratio.

a. From the curves of Figure 6.11(a), estimate the average annual damages for each of the three points in the time horizon. For the present, 50 year, and 100 year conditions, estimated average annual costs are, respectively, \$0.06, \$1.15, and 2.50 million dollars. The average annual damage for the entire 100 year period is approximately \$1.22 million.

b. From Figure 6.11(a), plot Figure 6.11(b) which indicates the estimated average annual flood damages under reservoir-modified conditions as a function of time. The same function for "no reservoir" conditions from Figure 6.7(b) also is superimposed on Figure 6.11(b), and the shaded area between the two curves is the flood damage reduction resulting from the reservoir. The average annual flood damage reduction is

the difference between the average annual damage of \$1.41 million from Figure 6.7(b) and the \$1.22 million from Figure 6.11(b), or \$0.19 million. A plot of the flood damage reduction as a function of time (derived from Figure 6.11(b)) is shown by Figure 6.12.

c. Determine the present values of the benefit and cost streams for a 100 year time period. With reference to the cost stream, the estimated initial or capital cost of the impounding reservoir and its associated works is \$527,000. To this figure is added the present value of the assumed average annual operating and maintenance costs of \$10,000 computed at an annual interest rate of six percent namely, \$163,500, for a total present value of approximately \$690,500. The calculations for the present value of the benefit stream over the 100 year time horizon and also computed at an annual interest rate of six percent are shown by Table 6.1. In order to reduce the number of calculations, computations are based on the mean value of the annual benefit for each 10 year increment. These mean values are taken from Figure 6.12. As indicated by Table 6.1, the estimated present value of the flood protection benefits provided by the reservoir over the 100 year period is \$1,554,090, thus giving a benefit/cost ratio of 2.25. It is noted that if interest is neglected, the total estimated value of the net benefits from the regulation reservoir is \$0.19 million per year, or \$19 million for the entire 100 year period. Other benefits, such as those associated with the use of the impounding basin as a park during non-flood periods, also might be considered in an analysis of this nature.

As already indicated, the main purpose of the preceding example, and indeed of the entire study, is to demonstrate the usefulness of a hydrologic model for predicting the impacts on runoff characteristics of planned or proposed changes within an urban area. The various hydrologic and economic relationships utilized in developing the benefit/cost ratio cited above could be incorporated readily into a single computer model, thus providing a comprehensive technique for the effective design and planning of water resource systems within the context of urban hydrology.



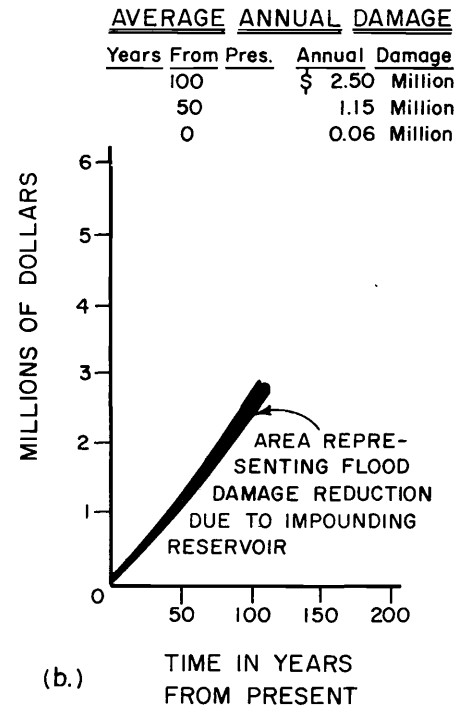
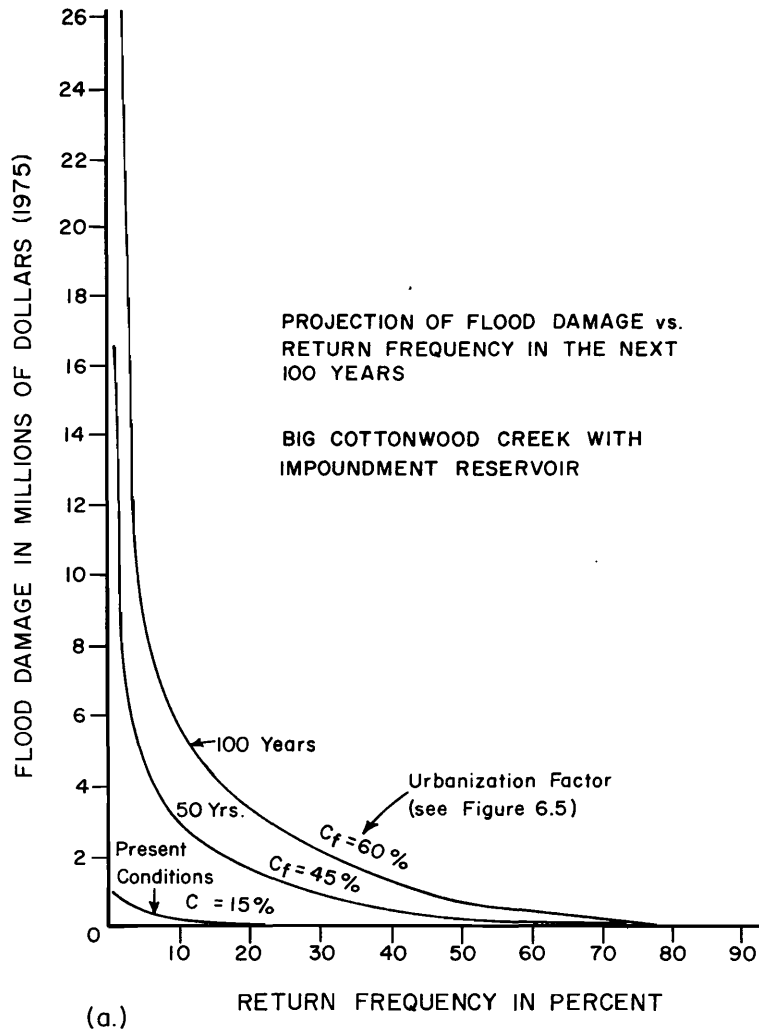

Figure 6.11a. Projected flood damages as a function of event frequency for various levels of urbanization (or time horizon) from Big Cottonwood Creek flows as modified by an impounding reservoir.

Figure 6.11b. Estimated average annual flood damages as a function of time for modified and unmodified flows from Big Cottonwood Creek.

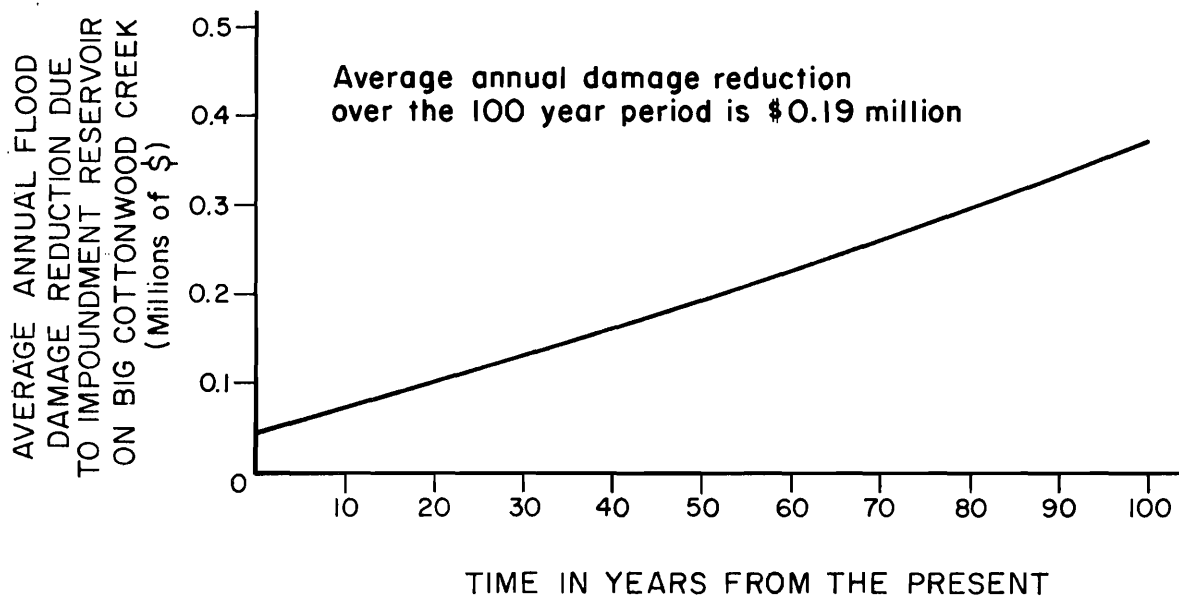

Figure 6.12. Estimated average annual flood damage reduction as a function of time from the impoundment reservoir on Big Cottonwood Creek.

Table 6.1. Benefit-cost calculations for a proposed runoff impounding reservoir on Big Cottonwood Creek.

A. Present values of costs:

1. Capital cost .....	\$527,000
2. Operating and maintenance costs:	
Present value of \$10,000 per year	
for 100 years at 6 percent .....	<u>163,500</u>
3. Approximate total present value of costs .....	<u>\$690,500</u>

B. Present value of benefits:

Average annual benefit for each 10-year period (From Figure 6.12) (Millions of \$)	Total 10-year benefit (Millions of \$)	Interest application period (Years)	Interest factor at 6 percent per year	Present value of average 10-year benefits. \$
0.06	0.6	95	0.737	442,200
0.08	0.8	85	0.412	329,440
0.11	1.1	75	0.229	252,010
0.15	1.5	65	0.128	191,400
0.18	1.8	55	0.072	130,500
0.21	2.1	45	0.041	85,260
0.24	2.4	35	0.022	53,590
0.28	2.8	25	0.012	34,920
0.31	3.1	15	0.007	21,580
0.35	3.5	5	0.004	13,190
Approximate total present value of benefits .....				<u>\$1,554,090</u>

C. Benefit/cost =  $\frac{1,554,090}{690,500} = \underline{\underline{2.25}}$

D. Based on 1975 price levels, total benefits, exclusive of interest, over the 100 year planning horizon are  $0.19 \times 100 = \$19$  million.



## CHAPTER VII

### SUMMARY AND CONCLUSIONS

A hydrologic simulation model which is capable of representing the dynamic processes within an urbanizing area is coupled with an economic analysis procedure for use in the design and planning of storm drainage systems for urban areas. In this case, the simulation model is synthesized on a hybrid computer, although the model is readily programmable for all-digital application. The model was first verified by historical data and then parameters which change with urbanization were identified. Regression equations were developed to correlate these parameters with urbanization factors. Thus, by adjusting the model parameters, simulation results represent the watershed responses at different stages of urbanization. By means of statistical analyses, precipitation and the upstream input flows are developed for particular return frequencies utilized in the study. These data, which are assumed to be stationary with respect to stages of urbanization, are routed through the model to produce curves of flood discharge versus return frequency at different levels of urbanization. These kinds of curves are useful for flood control planning and design.

An economic analysis follows the hydrologic study. Flood areas were mapped and measured in accordance with flood peak discharge. From information compiled by the Corps of Engineers (1969) flood damages in dollars per unit of area flooded are estimated as a function of degree of urbanization. Projected population growth within the area is used as a basis for estimating the rate of urbanization over the next 100 years. From this relationship it is possible to develop flow versus frequency, and thus damage versus frequency functions for various levels of urbanization, and thus various points in time within a planning horizon of 100 years. For a particular area of flooding, increasing flood damages with time are estimated on the basis of both increased degree of urbanization and increased real property values. The latter are estimated from income per capita projections for the area. The trend of increasing property values and urbanization causes a rapid increase in flood

damage potential within a particular area. This hazard is further increased by the fact that urbanization magnifies the flooding potential from an event of a particular frequency. Average annual flood damages within the study area are estimated for planning horizons up to 100 years. The utility of the procedure for design and planning purposes is demonstrated through an example of a benefit-cost analysis which is applied to a proposed flood control structure within a portion of the study area.

The following conclusions are drawn from this study:

1. Computer simulation is a useful tool in studying and managing the dynamic system of urban hydrology.
2. Urban water resources planning in modern society requires comprehensive consideration involving the physical, economic, sociological dimensions. Studying a system of this complexity demands large amounts of data. Hence, data collection is a vital component of urban water resources planning and management. The scope of the study reported herein was limited by data availability.
3. Future work should emphasize not only data collection as suggested by item 2 above, but also the expansion of the model to include the economic dimension (see Figure 1.1 and also Chapter VI), and ultimately various aspects of the social dimension.
4. Projection into the future depends largely on the extension of past trends. Clearly, therefore, uncertainties increase with the extension of the projection period. A planning horizon of 100 years for a large urban area is not excessive. However, projections of population and economic growth, within the area for 100 years involves large uncertainties. For this reason, long-term predictions and plans need continuous revision and updating through short-term planning which is based on current information.



## REFERENCES

- American Public Works Association. 1966. Urban drainage practices, procedures, and needs. Special Report, APWA Research Foundation, Chicago, Illinois. 54 p.
- ASCE Urban Hydrology Research Council. 1968. Urban water resources research. American Society of Civil Engineers, New York, New York. September.
- Crawford, N.H., and R.K. Linsley. 1962. The synthesis of continuous streamflow hydrographs on a digital computer. Technical Report No. 12. Department of Civil Engineering, Stanford University, Stanford California. 121 p.
- Crippen, J.R., and A.O. Waananen. 1969. Hydrologic effects of suburban development near Palo Alto, California. U.S. Department of the Interior, Geological Survey, Water Resources Division, Menlo Park, California. 126 p.
- Dempsey, Clyde R. 1968. The effects of geographical and climate setting on the economic advantages of alternative flood control measures. University of Kentucky, Water Resource Institute, Lexington, Kentucky. 166 p.
- Department of the Army, Sacramento District, Corps of Engineers. 1969. Flood plain information, Jordan River complex, Salt Lake City, Utah. 60 p.
- Espey, William H., Jr., Carl W. Morgan, and Frank D. Masch. 1965. A study of some of the effects of urbanization of storm runoff from a small watershed. Technical Report HY DO-7-6501, CRWR-2. Center for Research in Water Resources, Hydraulic Engineering Laboratory, Department of Civil Engineering, University of Texas, Austin, Texas. 109 p.
- Evelyn, Joseph B., V. V. Dhruva Narayana, J. Paul Riley and Eugene K. Israelsen. 1970. Hydrograph synthesis for watershed subzones from measured urban parameters. Utah Water Research Laboratory, College of Engineering, Utah State University, Logan, Utah. 51 p.
- Hachman, Frank C. 1975. County populations estimates for Utah. Bureau of Economics and Business Research, University of Utah, Salt Lake City, Utah, July.
- Hydrocorp International. 1971. Simulation of discharge and stage frequency for flood plain mapping in the North Branch of the Chicago River. A study for the Northeastern Illinois Planning Commission. Unpublished report. 75 p.
- James, L. Douglas. 1965. Using a digital computer to estimate the effects of urban development. Water Resource Research 1 (2): 233-234.
- Kaliser, Bruce N. 1973. Mt. Olympus Cove environment geology study. Report of Investigation No. 86. Utah Geological and Mineral Survey, Salt Lake City, Utah. 40 p.
- Narayana, V.V. Dhruva, J. Paul Riley, and Eugene K. Israelsen. 1969. Analog computer simulation of the runoff characteristics of an urban watershed. Utah Water Research Laboratory, College of Engineering, Utah State University, Logan, Utah. 83 p.
- Office of Business Economics. 1972. OBERS projections - regional economic activity in the US. Vol. 5, Standard Metropolitan Statistical areas. United States Water Resources Council, Washington, D.C.
- Richardson, E. Arlo. 1971. Estimated return periods for short duration precipitation in Utah. Department of Soils and Biometeorology, Utah State University, Logan, Utah. 69 p.
- Tholin, A.L., and C.L. Keifer. 1960. Hydrology of urban runoff. Transactions, American Society of Civil Engineers 125:1308-1379.
- Viessman, Warren, J. 1966. The hydrology of small impervious areas. Water Resources Research 2(3):405-412.
- Willeke, G.E. 1966. Time in urban hydrology. Journal of Hydraulics Division, Proceedings, American Society of Civil Engineers 92 (HY1):13-29.



## APPENDICES





## APPENDIX A

**Digital Computer Program "URBPARG" for Calculating the Percent Impervious Area,  $C_f$ , and the Characteristic Impervious Length Factor,  $L_f$ . Sample Output for the Mill Creek and the Big Cottonwood Urban Watersheds Within Salt Lake County, Utah, also is Given.**

Page 1            C            URBPARG PROGRAM            UTAH STATE UNIVERSITY            1971            RNP

```

C            PROGRAM WRITTEN FOR THE EAI 640 DIGITAL COMPUTING SYSTEM
C            PROGRAM FOR IMPERVIOUS AREA, CF, AND LENGTH FACTOR, LF, FOR WATMOD
C            NS = SUBAREA NUMBER IN MILLIONS FT. SQ.
C            R = ROADS                    IN THOUSAND FT. SQ.
C            H = HOMES                    IN THOUSAND FT. SQ.
C            S = SIDEWALKS                IN THOUSAND FT. SQ.
C            P = PARKING LOTS             IN THOUSAND FT. SQ.
C            B = BUILDING                 IN THOUSAND FT. SQ.
C            TIA= TOTAL IMP.             IN THOUSAND FT. SQ.
C            XLI= LOW LENGTH
C            XLM= WEIGHTED AVERAGE
C            XLF= CHARACTERISTIC IMPERVIOUS LENGTH FACTOR
C            XL = WATERSHED SUBAREA LENGTH
C            N = NUMBER OF SUBAREAS IN WATERSHED
C            RAFL IAP
C            DIMENSION NS(20), A(20), R(20), H(20), S(20), P(20), B(20), XLI(20), TIA (2
10) , RP(20), HP(20), SP(20), PP(20), BP(20), Q(20), T(20), AP(20)
1            READ (6,2) N, XL, (Q(I), I = 1,17)
2            FORMAT (I2, F7.1, 3X, 17A4)
             IF (N.EQ.0) GO TO 500
             DO 10 I = 1, N
             READ (6,5) NS(I), A(I), R(I), H(I),S(I),P(I),B(I),XLT(I)
5            FORMAT (5X, I5, 7F5.1)
10            CONTINUE
             TIAS = 0.0
             ET = 0.0
C            ADDING THE IMPERVIOUS AREAS - TOTAL IMPERVIOUS AREA
             DO 20 I = 1,N
             TIA(I) = R(I), + H(I) + S(I) + P(I) + B(I)
             TIAS = TIAS + TIA(I)
             T(I) = XLI(I) + TIA(I)
             ET = T(I) + ET
20            CONTINUE
             XLM = ET/TIAS
             XLF = XLM/XL
             DO 30 J=1,N
             RP(J) = R(J)/A(J) * .1
             HP(J) = H(J)/A(J) * .1
             SP(J) = S(J)/A(J) * .1
             PP(J) = P(J)/A(J) * .1
             BP(J) = B(J)/A(J) * .1
30            CONTINUE
             AT = 0.0
             DO 40 I = 1,N
             AT = A(I) + AT
40            CONTINUE
             DO 45 I = 1,N
             AP(I) = A(I)/AT * 100.
45            CONTINUE
             TAP = TIAS/(AT) * .001
             WRITE (6,100)
100            FORMAT ( 1H1)
             WRITE (6,47) (Q(I), I = 1,17)
47            FORMAT (4X, 17A4//)
             WRITE (8,50)

```

```

50 FORMAT (77H A AREA ROADS HOMES SIDEWALK PARKLOT BUILD
1IMPAREA LENGTH SUMS )
WRITE (6,55)
55 FORMAT (71H MSF KSF KSF KSF KSF KSF
1 KSF KF )
DO 200 I = 1,N
WRITE (6,60) NS(I), A(I),R(I),H(I),S(I)P(I),B(I),TIA(I),XLI(I),
1T(I)
60 FORMAT (2XI2,6F6.1, 3X, #F8.1)
WRITE (6,70)AP(I),RP(I),HP(I),SP(I),PD(I),BP(I)
70 FORMAT (4X, 6F8.1)
200 CONTINUE
WRITE (6,80) AT,ET
80 FORMAT (4X, F8.1,60X,F8.1)
WRITE (6,85) IAP, XLF
85 FORMAT (25H PERCENT IMPERVIOUS AREA=, F9.4, 5X,27H IMPERVIOUS, LEN
1CTH FACTOR =, F7.4)
GO TO 1
500 WRITE (6,90)
90 FORMAT(33H THIS COMPLETES THE WORK REQUESTED)
STOP
END

```

		HILL CREEK		SW-1							
A	AREA	ROADS	HOMES	SIDEWALKS	PARKLOT	BUILD	IMPAREA	LENGTH	SUMS		
	KSF	KSF	KSF	KSF	KSF	KSF	KSF	KSF	FK		
1	1.2	744.8	465.8	.0	.0	.0	1289.5	7.4	8951.8		
	1.0	62.0	38.0	.0	.0	.0					
2	6.7	432.0	792.0	14.4	262.5	634.5	2135.3	5.3	12776.9		
	18.8	6.4	11.0	.2	4.2	9.4					
3	3.5	432.0	328.0	7.2	91.5	73.8	933.3	3.5	3266.5		
	5.6	12.3	9.3	.2	2.6	2.1					
4	3.0	162.0	112.0	6.0	34.6	51.6	365.5	1.0	365.0		
	4.0	5.4	3.7	.2	1.1	1.7					
5	9.2	778.0	1017.6	13.5	263.9	180.5	2194.5	3.5	5461.4		
	14.0	8.3	11.0	.1	3.8	1.0					
6	3.7	469.2	549.0	.0	.0	.0	1210.0	7.4	7533.1		
	6.8	12.6	14.8	.0	.0	.0					
7	7.2	666.0	732.0	5.4	28.0	232.0	1620.3	7.5	12152.9		
	11.7	8.3	10.1	.1	.3	3.5					
8	4.0	932.3	542.4	3.6	87.3	49.0	1634.9	14.8	22469.9		
	7.0	19.0	11.8	.1	1.7	.0					
9	2.2	224.0	7.2	.0	.0	3.0	234.2	7.2	1686.2		
	3.5	16.1	.3	.0	.0	.1					
10	2.5	338.8	256.8	.3	.0	.0	586.6	10.0	5867.9		
	4.0	13.8	16.2	.0	.0	.0					
11	4.1	448.0	542.4	.0	296.0	98.0	1364.3	3.3	10915.1		
	6.6	12.9	13.2	.0	6.9	2.1					
12	3.4	292.6	364.3	4.8	282.0	140.0	1052.7	5.2	6496.7		
	5.5	8.0	10.7	8.2	4.1						
13	2.8	432.0	354.4	.3	131.5	25.5	1139.3	5.3	6836.3		
	4.6	15.3	19.8	.8	4.6	.8					
14	7.1	216.0	369.6	6.8	.0	.9	593.6	9.0	4748.7		
	11.5	3.8	5.2	.1	.8	.0					
	61.5									187529.4	

PERCENT IMPERVIOUS AREAS .2616 IMPERVIOUS LENGTH FACTOR .4772

BIG COTTONWOOD WATERSHED SW-1

A	AREA	ROADS	HOMES	SIDEWALKS	PARKLOT	BUILD	IMPAREA	LENGTH	SUMS		
	KSF	KSF	KSF	KSF	KSF	KSF	KSF	KSF	FK		
1	11.7	655.0	352.0	10.8	24.5	44.0	1587.0	10.2	19785.2		
	6.1	5.5	3.2	.1	.2	.3					
2	5.0	534.0	696.0	.0	400.0	146.0	1778.0	15.2	27025.5		
	2.0	10.0	13.9	.0	8.0	2.9					
3	2.1	621.0	744.0	35.0	216.0	212.5	1829.5	12.6	23051.6		
	4.7	7.5	8.1	.4	2.6	2.6					
4	10.7	954.0	1452.0	9.6	.0	.0	2415.5	13.0	31492.7		
	5.5	8.0	13.5	.1	.0	.0					
5	10.4	1023.4	1341.5	4.8	125.5	78.8	2572.0	14.8	38078.9		
	5.4	9.8	12.2	.0	1.2	.7					
6	8.9	724.0	548.0	14.4	39.8	22.8	1314.3	9.6	11029.5		
	4.6	7.9	6.0	.1	.3	.2					
7	6.8	630.0	384.0	48.0	.0	.0	1262.0	7.4	7858.7		
	3.5	9.2	5.6	.7	.0	.0					
8	7.4	676.8	494.4	14.4	27.0	125.0	1336.7	10.4	14191.2		
	3.8	8.1	6.6	.1	.3	1.6					
9	12.2	762.3	582.8	28.8	36.0	50.0	1469.5	3.8	5584.4		
	5.2	5.9	5.9	.2	.3	.5					
10	9.1	592.4	456.0	5.1	.0	.0	1153.5	2.8	3230.0		
	4.7	7.6	5.0	.1	.0	.0					
11	5.6	312.0	254.4	.0	.0	.0	966.4	3.2	1812.4		
	1.8	8.8	7.8	.0	.0	.0					
12	7.5	568.0	624.0	12.0	297.5	.0	1521.5	4.6	6086.8		
	3.9	7.8	8.3	.1	3.9	.0					
13	41.2	1338.0	1512.8	21.0	110.0	42.4	3023.3	16.4	58148.4		
	21.5	3.7	3.8	.1	.2	.1					
14	51.0	1121.0	249.6	.0	.0	50.0	1428.5	11.9	15626.5		
	26.6	2.1	.4	.0	.0	.1					
	191.4									255751.8	

PERCENT IMPERVIOUS AREAS .1178 IMPERVIOUS LENGTH FACTOR .6230

## APPENDIX B

Digital Computer Program "WATMOD" with Subroutine "ANALOG" for  
Preparing the Input Data (Precipitation and Stream Inflow),  
Calculating Coefficients for Evaluating Watershed  
Parameters, Routing Flow between Watershed  
Zones, and Controlling the Analog Computer.  
Subroutine "Print" also is Included.

PAGE 1

### SALT LAKE COUNTY WATERSHED PLANNING MODEL

```

SUBROUTINE ADATA(IW,IZ)
  SCALED FPACTION STP,DTOA,VAL
  COMMON STP(10),PPT(70),DTA(2,70),DTOA(2),VAL(2),RSLT(2,70),
  1PRST(70),ZR(70),CR(70),QT(70),SI(3,7),SD(3,7),FC(3,7),FJ(3,7),
  2TR(3,7),AR(3,7),TLK(3,7),HY(4,70)
  COMMON SPPT,SHY,KSTEP,TL
  DIMENSION A(15)
  STP(1)=.1/SI(IW,IZ)
  STP(2)=FJ(IW,IZ)
  STP(3)=.1/SD(IW,IZ)
  STP(4)=3./TR(IW,IZ)
  STP(5)=.25/TL
  DO 65 J=1,6
    AJ=A(J)
    BJ=STP(J)
    CALL QWPR(AJ,BJ,IERR)
    IF(J=4) 65,62,64
62  JFK=J+2
    AJ=A(JFK)
    DMY=BJ
    BJ=BJ/10.
    CALL QWPR(AJ,BJ,IERR)
    BJ=DMY
    GO TO 65
64  JFK=J+2
    DMY=STP(J)
    AJ=A(JFK)
    BJ=DMY/4.
    CALL QWPR(AJ,BJ,IERR)
    JFK=JFK+1
    AJ=A(JFK)
    BJ=DMY/1.5
    CALL QWPR(AJ,BJ,IERR)
    BJ=DMY
65  CONTINUE
  DO 25 I=1,KSTEP
    DTA(1,I)=PPT(I)/SPPT
  25  DTA(2,I)=PRST(I)/SHY
  RETURN
  END
```

```

C PREPARING INPUT DATA. PRECIPITATION AND INFLOW HYDROGRAPHS
DIMENSION HY(8,50)ASZ(10),A(7),PPT(7,50),SW(10,50)
READ(6,2)LY,MN,IDAY,KSTEP,KPPT
WRITE(6,13)
2 FORMAT(5I5)
4 FORMAT(1H0,5I5)
13 FORMAT(26H0 LY MN IDAY KSTEP KPPT)
16 FORMAT(1H0,10X,14F5.2)
17 FORMAT(1H0,10X,14F5.1)
18 FORMAT(5H0 A=,F5.2)
WRITE(6,2)LY,MN,IDAY,KSTEP,KPPT
DO 3 K=1,7
A(K)-0.0
DO 3 I=1,KSTEP
PPT(K,I)-0.0
READ(6,12)(HY(8,I),I=1,KSTEP)
5 READ(6,2)ID,NSZ
READ(6,8)(ASZ(J),J=1,NSZ)
8 FORMAT(10X,9F8.4)
READ(6,12)(HY(ID,I),I=1,KSTEP)
IF(ID.GT.1) GO TO 14
DO 10 I=1,KSTEP
10 HY(1,I)=HY(1,I)+HY(8,I)
12 FORMAT(10X,14F5.0)
14 DO 15 J=1,NSZ
READ(6,12)(SW(J,I),I=1,KPPT)
15 A(ID)=A(ID)+ASZ(J)
DP 20 I=1,KPPT
DO 20 J=1,NSZ
20 PPT(ID,I)=PPT(ID,I)+SW(J,I)*ASZ(J)/A(ID)
C PPT IS EQUAL INT. PRECIP FOR SW AREA COMBS.
IF(ID.LT.3) GO TO 5
A(7)-A(1)+A(2)+A(3)
DO 25 I=1,KSTEP
HY(7,I)=HY(1,I)+HY2,I)+HY3,I)
DO 25 K=1,3
25 PPT(7,I)=PPT(7,I)+PPT(K,I)*A(K)/A(7)
L=0
28 L=L+1
M=L+1
IF(L.DQ.3) M=1
ID=L+M
IF(ID.EQ.3) ID=6
A(ID)=A(L)+A(M)
DO 30 I=1,KSTEP
HY(ID,I)=HY(L,I)+HY(M,I)
30 PPT(ID,I)=(PPT(L,I)*A(L)+PPT(M,I)*A(M))/A(ID)
IF(M.EQ.1) GO TO 35
GO TO 28
35 DO 40 ID=1,7
WRITE(6,4) ID
WRITE(6,17)(HY(ID,I), I=1,KSTEP)
WRITE(6,18)A(ID)
40 WRITE(6,16) (PPT(ID,I), I=1,KPPT)
STOP
END

```

```

C PARAMETER IDENTIFICATION TO DETERMINE COEFFICIENTS FOR
C REGRESSION EQUATIONS
C MAIN PROGRAM
SCALED FRACTION CVP,STP,DTOA,VAL
COMMON CVP(10),STP(10),DHY(70),PPT(70),HY(70),DTA(2,70),KDS(10),
1KRS(10),SGN(10), DTOA(2),VAL(2),RSLT(2,70),RRST(70),DHY(70)
COMMON DLTA1,DLTA2,ERRV,SPPT,SHY,SVAR,KSTEP, LFA,VAR,VAR0,JPRM,
1ABSER,SUM,TOL,ERR
DIMENSION A(15)
DATA A(1),A(2),A(3),A(4),A(5)/4HP010,4HP011,4HP012,4HP013,4HP014/
DATA A(6),A(7),A(8),A(9)/4HP015,4HP016,4HP017,4HP018/
DATA A(10),A(11),A(12),A(13)/4HP019,4HP020,4HP021,4HP022/
DATA A(14),A(15)/4HP023,4HP024/
READ(6,9) JPRM,LFA,DLTA1,DLTA2,ERRV,SPPT,TOL
9 FORMAT(2I5,2X,5F10.5)
READ(6,11)(CVP(K),K=1,JPRM)
11 FORMAT(10(1X,S7))
DO 15 J=1,JPRM
SGN(J)=1.000
15 STP(J)=CVP(J)
12 READ(6,14)LY,MN,IDATE,KSTEP
14 FORMAT(5I5)
READ(6,24)(DHY(I),I=1,KSTEP)
24 FORMAT(10X,14F5.0)
SUM=0.000
SVAR=0.0
DO 40 I=1,KSTEP
SUM=SUM+DHY(I)
40 SVAR=SVAR+DHY(I)*DHY(I)
WRITE(6,7)LY,MN,IDATE,KSTEP
7 FORMAT(1X,4HDATE,3I4,2X,9HMYD,STEPS,13)
WRITE(6,82)
82 FORMAT(1X,21HDOWNSTREAM HYDROGRAPH)
WRITE(6,24)(DHY(I),I=1,KSTEP)
C THE DATA INPUT SERIES ARE (1)ENTIRE WATERSHED (2)MC+BC
C (3)LC (4)BC+LC (5)MC (6)MC+LC (7)BC
C PARAMETER IDENTIFICATION IN (1),(3),(5),(7)
C OUTFLOW HYDROGRAPH ESTIMATION FOR (3),(5),(7) AT (2),(4),(6) BY
C COMPUTING OUTFLOW FROM (2),(4),(6) USING PARAMETER VALUES FORM (1)
C HAND SET ICS AND INITIAL GUESS OF POT VALUES
CALL QSHYIN(IERR,500)
CALL QSC(1,IERR)
WRITE(6,52)(STP(J),J=1,JPRM)
20 READ(6,22)ID,AR
22 FORMAT(15,F8.4)
WRITE(6,38) ID,AR,SVAR,SUM
38 FORMAT(//2X,3HID=,I2,2X,5HAREA=,F8.4,2X,5HVAR=,E10.3,2X,4HSUM=,
1E10.3)
C SHY CONVERT DISCHARGE HYDROGRAPH IN CFS INTO RUNDEF IN INCHES
C IN A TIME UNIT (30 MIN.) AND SCALED ACCORDING TO PRECIP. SCALE.
C SHY=((30*00+12)/(5200+5200))*(1/(A*SPPT))
SHY=1291.*AR*SPPT
READ(6,24)(PPT(I),I=1,KSTEP)
READ(6,24)(HY(I),I=1,KSTEP)
WRITE(6,84)
84 FORMAT(1X,17HINFLOW HYDROGRAPH)

```

```

WRITE(6,24) (HY(I), I=1,KSTEP)
WRITE(6,42)
42 FORMAT(1X,13HPRECIPITATION)
WRITE(6,44) (PPT(I), I=1,KSTEP)
44 FORMAT(16F5,2)
DO 25 I=1,KSTEP
DTA(1,I)=PPT(I)/SPPT
25 DTA(2,I)=HY(I)/SHY
JJ=ID/2
KK=JJ*2
IF(KK,EQ,ID)GO TO 30
IF(ID,NE,1) GO TO 32
DO 50 I=1,KSTEP
50 OHY(I)=DHY(I)
32 WRITE(6,46)
46 FORMAT(1X,18HOUTFLOW HYDROGRAPH)
WRITE(6,48) (OHY(I), I=1,KSTEP)
48 FORMAT(13F6,1)
CALL OPTM(A)
WRITE(6,49) VAR,ERR
49 FORMAT(1X,4HOPTM,2X,4HVAR=F6,3,2X,4HERR=F6,3)
WRITE(6,52) (CVP(J), J=1,JPRM)
52 FORMAT(1X,16HPARAMETER VALUES, 2X,7(1X,S7))
WRITE(6,56)
56 FORMAT(1X,19HCOMPUTED HYDROGRAPH)
WRITE(6,48) (RRST(I), I=1,KSTEP)
IF(ID=1) 57,57,72
57 DO 60 J=1,JPRM
60 STP(J)=CVP(J)
72 IF(ID=7) 20,35,35
SET THE ENTIRE WATERSHED PARAMETER VALUES
30 DO 65 J=1,JPRM
AJ=A(J)
BJ=STP(J)
CALL GWPR(AJ,BJ,IERR)
IF(J=5) 65,62,64
62 JFK=J+2
AJ=A(JFK)
DHY=BJ
BJ=BJ/10.
CALL GWPR(AJ,BJ,IERR)
BJ=DHY
GO TO 65
64 JFK=J+2
DHY=STP(J)
AJ=A(JFK)
BJ=DHY/4.
CALL GWPR(AJ,BJ,IERR)
JFK=JFK+1
AJ=A(JFK)
BJ=DHY/1.5
CALL GWPR(AJ,BJ,IERR)
BJ=DHY
65 CONTINUE
CALL ANALOG
WRITE(6,56)
WRITE(6,48) (RRST(I),I=1,KSTEP)
SUM=0.000

```

```

SVAR=0.00
DO 55 I=1,KSTEP
OHY(I)=DHY(I)-RRST(I)
IF(OHY(I) .LE. 0.) OHY(I)=0.0
SUM=SUM+OHY(I)
55 SVAR=SVAR+OHY(I)+OHY(I)
GO TO 20
35 PAUSE 000
STOP
END

```

```

SUBROUTINE RANDOM(NSR)
SCALED FRACTION CVP,STP,DTOA,VAL
COMMON CVP(10),STP(10),DHY(70),PPT(70),HY(70),DTA(2,70),KDS(10),
1KRS(10),SGN(10), DTOA(2),VAL(2),RSLT(2,70),RRST(70),OHY(70)
COMMON DLTA1,DLTA2,EPRV,SPPT,SHY,SVAR,KSTEP, LFA,VAR,VAR0,JPRM,
1ABSER,SUM,TOL,ERR
C INPUT PRIME NO. LFA
C NSR=NO OF SEQUENCE TO BE DRAWN RANDOMLY
C KDS=COLUMN OF DUMMY SEQUENCE
C NRD=NJMBER RANDOMLY DRAWN
C KRS=COLUMN OF RANDOM SEQUENCE, RESULT
1 DO 2 J=1,NSR
2 KDS(J)=J
DO 10 I=1,NSR
C MACHINE LANGUAGE TO EXCHANGE NUMBER STORFD IN TWO REGISTERS
NR=NR1+LFA
LA NR1
M LFA
OCT 026540
STA NR
RSTN=NR
SN=RSTN+2.0**(-15)
NRD=SN+FLOAT(NSR+1-I)+0.999
IF(NRD .LE. 1) NRD=1
NGT=NSR+1-I
IF(NRD .GT. NGT) NRD=NGT
KRS(I)=KDS(NRD)
NRL=NSR-I
IF(NRD .GT. NRL) GO TO 10
DO 5 L=NRD,NRL
5 KDS(L)=KDS(L+1)
10 NR1=NR
RETURN
END

```

```

SUBROUTINE OPTM(A)
  SCALED FRACTION CVP,STP,DTOA,VAL
  COMMON CVP(10),STP(10),DHY(70),PPT(70),HY(70),DTA(2,70),KDS(10),
  1KRS(10),SGN(10),DTOA(2),VAL(2),RSLT(2,70),RRST(70),OHY(70)
  COMMON DLT1,DLT2,ERRV,SPPT,SHY,SVAR,KSTEP,LFA,VAR,VAR0,JPRM,
  1ABSER,SUM,TOL,ERR
  DIMENSION A(15)
  CALL ANALOG
  VAR0=VAR
  NLM=0
  KCK=4
C   NLM, CYCLE CONTROL
  4 NLM=NLM+1
C   L= NO OF PARAMETER TESTED, BUT NO IMPROVEMENT ACHIEVED
  L=1
  CALL RANDOM(JPRM)
  DO 40 I=1,JPRM
C   K, SIGN CONTROL, CHANGE SIGN AT K=2
  K=0
  8 DLT1=DLT1
  10 J=KRS(I)
  AJ=A(J)
  DS1=1.0+DLT1*SGN(J)
  DMY=CVP(J)
  BJ=DMY*DS1
  CVP(J)=BJ
  CALL GWPR(AJ,BJ,IERR)
  IF (J=5) 15,55,60
  55 JFK=J+2
  DMY=BJ
  AJ=A(JFK)
  BJ=BJ/10.
  CALL GWPR(AJ,BJ,IERR)
  BJ=DMY
  GO TO 15
  60 JFK=J+2
  AJ=A(JFK)
  DMY=BJ
  BJ=BJ/4.
  CALL GWPR(AJ,BJ,IERR)
  JFK=JFK+1
  AJ=A(JFK)
  BJ=DMY/1.5
  CALL GWPR(AJ,BJ,IERR)
  BJ=DMY
  15 CALL ANALOG
  IF (VAR .LE. ERRV) GO TO 50
  DVR=VAR0=VAR
  IF (DVR) 14,30,20
  14 K=K+1
  IF (K=2) 16,20,16
  16 IF (K .EQ. 4) GO TO 24
  DLT1=DLT2
  GO TO 10
  20 DMY=CVP(J)

```

PAGE 2

```

DNT=1.0+DLT1*SGN(J)+DLT2*SGN(J)+DLT1+DLT2
C   SET BACK TO ORIGINAL VALUE
  CVP(J)=DMY/DNT
  SGN(J)=-SGN(J)
  GO TO 8
  24 L=L+1
  DMY=CVP(J)
  DNT=1.0+DLT1*SGN(J)+DLT2*SGN(J)+DLT1+DLT2
  BJ=DMY/DNT
  CALL GWPR(AJ,BJ,IERR)
  CVP(J)=BJ
  GO TO 40
  28 VAR0=VAR
  IF (DVR-TOL) 30,32,32
  30 L=L+1
  32 IF (L .EQ. JPRM) GO TO 50
  40 CONTINUE
  IF (NLM .EQ. KCK) GO TO 50
  GO TO 4
  50 RETURN
  END

```

```

C DETERMINE THE LAG TIME AND CHANNEL ROUTING SCALE FACTOR
IF(IZ .NE. 1) GO TO 22
DO 22 K=1,KSTEP
20 PPST(K)=HY(IW,K)
22 RMAX=0.0
DO 25 K=1,KSTEP
IF(PPST(K) .GT. RMAX) RMAX=PPST(K)
25 CONTINUE
TL=TLK(IW,IZ)/(RMAX**0.4)
1291 CFS OF DISCHARGE INTO 1 SQ.MI. OF AREA EQUALS 1 INCH OF
RUNOFF IN 30 MIN.
C
C KHY=RMAX/1291.*AR(IW,IZ)+SPPT+1.5
SHY=FLOAT(KHY)*1291.*AR(IW,IZ)+SPPT
WRITE(F,61) I4, IZ
61 FORMAT(1X,12HSUBWATERSHED, I3, 2X, 4HZONE, I3)
CALL ADATA(IW,IZ)
CALL ANALOG
30 CONTINUE
WRITE(F,41) IW
41 FORMAT(1X,17HOUTFLOW AT POINT , I2,1X,16HJORDAN RIVER CFS)
DO 35 K=1,KSTEP
35 HY(4,K)=QT(K)+HY(4,K)
WRITE(F,14) (HY(4,K), K=1,KSTEP)
40 CONTINUE
READ(6,13) (HY(1,K),K=1,KSTEP)
WRITE(6,57)
57 FORMAT(//)
WRITE(6,14) (HY(1,K), K=1,KSTEP)
SUM=0.0
ASD=0.0
BAL=0.0
DO 55 K=1,KSTEP
SUM=SUM+HY(1,K)
BAL=BAL+HY(1,K)-HY(4,K)
55 ASD=ASD+ABS(HY(1,K)-HY(4,K))
ABSER=ASD/SUM
BALEK=BAL/SUM
WRITE(6,58) SUM,BAL,ASD,ABSER,BALEK
58 FORMAT(1X,3HSUM,F10.2,4H BAL,F10.2,4H ASD,F10.2,6H ABSER, F8.4,
14H BALEK, F8.4)
PAUSE 0000
GO TO 10
END

```

```

SUBROUTINE ANALOG(IW,IZ)
SCALED FRACTION STP,DTOA,VAL
COMMON STP(10),PPT(70),DTA(2,70),DTOA(2),VAL(2),RSLT(2,70),
1RRST(70),ZR(70),CR(70),QT(70),SI(3,7),SD(3,7),FC(3,7),F0(3,7),
2TR(3,7),AR(3,7),TLK(3,7),HY(4,70)
COMMON SPPT,SHY,KSTEP,TL
VAL(1) ZONE RUNOFF INPUT, FROM ADC00 TO DAC01
VAL(2) COMP RESULT,
C
C 100 CALL QSIC(IERR)
DTOA(1)=0.0
C (1) REF. TO PPT
DTOA(2)=0.0
C (2) REF. TO HY.
C CALL QWBDA5(DTOA,0,2,IERR)
CALL GSTDA
K=0
50 CALL QRLBB(ITEST,IERR)
IF(ITEST .EQ. '200') GO TO 50
52 CALL QRLBB(ITEST,IERR)
IF(ITEST .NE. '200') GO TO 52
CALL QSOP(IERR)
DO 60 K=1,KSTEP
DTOA(2)=DTA(2,K)
53 DTOA(1)=DTA(1,K)
CALL QWBDA5(DTOA,0,2,IEPR)
CALL GSTDA
II=K/2
NN=II*2
IF(NN .EQ. K) GO TO 56
56 CALL QRLBB(ITEST,IERR)
IF(ITEST .EQ. '200') GO TO 56
GO TO 59
58 CALL QRLBB(ITEST,IERR)
IF(ITEST .NE. '200') GO TO 58
59 CALL GRBADS(VAL,0,2,IERR)
RSLT(1,K)=VAL(1)
C (1) REF. TO PRECIP ZONE RUNOFF
RSLT(2,K)=VAL(2)
C (2) TOTAL RUNOFF FROM AREA
60 CONTINUE
CALL QSH(IERR)
CALL GSPS(IERR)
DO 70 K=1,KSTEP
IF(RSLT(1,K) .LE. 0.02) RSLT(1,K)=0.00
ZR(K)=RSLT(1,K)+SPPT*AR(IW,IZ)+1291.
CR(K)=RSLT(2,K)+SHY
IF(CR(K) .LE. 0.) CR(K)=0.
QT(K)=ZR(K)+CR(K)
70 CONTINUE
WRITE(6,10)
10 FORMAT(5X,17HOVERLAND FLOW CFS)
WRITE(6,30) (ZR(K),K=1,KSTEP)
TLM=TL*30.
WRITE(6,12) TLM
12 FORMAT(5X,22HCHANNEL FLOW(CFS) TLM ,F5.1)

```



PAGE 2

```
WRITE(6,30) (CR(K), K=1,KSTEP)
WRITE(6,14)
14 FORMAT(5X,19HTOTAL DISCHARGE CFS)
WRITE(6,30) (QT(K), K=1,KSTEP)
30 FORMAT(10F8.1)
RETURN
END
```

```
SUBROUTINE ANALOG
SCALED FRACTION CVP,STP,DTOA,VAL
COMMON CVP(10),STP(10),OHY(70),PPT(70),HY(70),DTA(2,70),KDS(10),
1KRS(10),SGN(10), DTOA(2),VAL(2),RSLT(2,70),RRST(70),OHY(70)
COMMON DLTA1,DLTA2,ERRV,SPPT,SHY,SVAR,KSTEP, LFA,VAR,VAR0,JPM,
1ABSER,SUM,TOL,ERR
CALL QSHYIN(IERR,580)
CALL QSC(1,IFRR)
C VAL(1) ZONE RUNOFF INPUT, FROM ADC00 TO DAC01
C VAL(2) COMP RESULT,
100 CALL QSIC(IERR)
DTOA(1)=0.0
C (1) REF. TO PPT
DTOA(2)=0.0
C (2) REF. TO HY,
CALL QWBDA(DTOA,0,2,IERR)
CALL QSTDA
K=2
50 CALL QRLBB(ITEST,IERR)
IF(ITEST .EQ. '200') GO TO 50
52 CALL QRLBB(ITEST,IERR)
IF(ITEST .NE. '200') GO TO 52
CALL QSOP(IERR)
DO 60 K=1,KSTEP
DTOA(2)=DTA(2,K)
53 DTOA(1)=DTA(1,K)
CALL QWBDA(DTOA,0,2,IERR)
CALL QSTDA
II=K/2
NN=II*2
IF(NN .EQ. K) GO TO 58
56 CALL QRLBB(ITEST,IERR)
IF(ITEST .EQ. '200') GO TO 56
GO TO 59
58 CALL QRLBB(ITEST,IERR)
IF(ITEST .NE. '200') GO TO 58
59 CALL QRBADS(VAL,0,2,IERR)
RSLT(1,K)=VAL(1)
C (1) REF. TO PRECIP ZONE RUNOFF
RSLT(2,K)=VAL(2)
C (2) TOTAL RUNOFF FROM AREA
60 CONTINUE
CALL QSM(IERR)
CALL QSPS(IERR)
DO 70 K=1,KSTEP
RRST(K)=RSLT(2,K)*SHY
IF(RRST(K) .LE. 0.) RRST(K)=0.0
70 CONTINUE
ABSER=0.0
VAR=0.000
DO 65 L=1,KSTEP
ERM=ABS(OHY(L)-RRST(L))
ABSER=ABSER+ERM
65 VAR=VAR+ERM**2/SVAR
ERR=ABSER/SUM
```

PAGE 2

```
RETURN
END
```

```

SUBROUTINE PRINT
COMMON/BK1/SW(50,7 ), QC(50,7 ),RSLT(50,7 ),QT(50,7 )
COMMON/BK2/DTV(10),GT(10),Q(20),T(50),QS(50), GF(10),
1 IW(10),NAT(50),J,JD,LL,H,I,NYEAR,N
COMMON/BK2/ CN(10),B(10), VOLQ(10),TLV(10),CFS(10),
1CFSX(10),CF(10),XLF(10),SI(10),FO(10),FC(10),SD(10),TR(10),SIV(10)
2,FCV(10),SDV(10),TRV(10),CL(10),S(10), POV(10),APOT(10),
3 VAL(10),A(10),TL(10), MH(30,2),DELT,QMAX,AREA,SCALE
WRITE (6,71) (Q(L), L=1,20)
71 FORMAT ( 1H1, 20A4)
WRITE (6,2) NYEAR
2 FORMAT (1H // 61H WATERSHED COEFFICIENTS FOR SUBZONES WITHIN THE
1 STUDY AREA 4X, I4,)
WRITE (6,7)
7 FORMAT (79H SI(IN) SD(IN) FO(IN/HR) FC(IN/HR)
1 TR(MIN) TL(MIN) //, 77H P-10 P-15 P-1
22 P-11,.13 P-15 P-19 )
WRITE (6,3) I,SI(I),SIV(I),SD(I),SDV(I),FO(I),FOV(I),FC(I),FCV(I),
1TR(I),TRV(I),TL(I),TLV(I)
3 FORMAT ( 3H SW,I2,F4.2,1H=F6.4,1HP,F4.2,1H=F5.4,1HP,F4.2,1H=,
1F6.4,1HP,F4.2,1H=F5.4,1HP,F4.0,1H=F6.4,1HP,F4.0,1H=F6.4,1HP,/)
WRITE (6,75) IW(I),LL,QMAX,H
75 FORMAT ( 4H SW,I2,5X,5H LAG=,I2,5X,3H Q=,F6.1,5X,3H M=,I2)
WRITE (6,76)
76 FORMAT (79H SUBZONE CFS ACC TOTAL CFS 1000 ACRE FT. STORED
1 CFS 1000 ACRE FT)
80 WRITE (6,81) ( RSLT(K,I), QC(K,I), QT(K,I),QS(K),T(K), K=1,M)
81 FORMAT ( 5F15,2)
IF ( I .EQ. N) GO TO 83
QMAX = 0.0
DO 83 K=1,M
QS(K) = 0.0
IF (QC(K,I) .LT. CFS(I+1)) GO TO 96
QS(K) = QC(K,I) - CFS(I+1)
QC(K,I) = CFS(I+1)
C FINDING MAXIMUM DISCHARGE
96 IF ( QC(K,I) .GE. QMAX) QMAX=QC(K,I)
C CONVERTING CFS DISCHARGE VALUES BACK INTO ANALOG UNITS
IF (QC(K,I) .EQ. .0) GO TO 82
QC(K,I) = QC(K,I) * DELT / (SCALE + 3871.2 * AREA)
82 IF(QS(K) .EQ. 0.0) GO TO 83
QS(K) = QS(K) * DELT / ( SCALE + 3871.2 * AREA)
IF (QMAX .EQ. 0.) QMAX = 1.0
83 CONTINUE
RETURN
END

```

