

Utah State University

DigitalCommons@USU

Reports

Utah Water Research Laboratory

January 1975

Urban Storm Runoff Inlet Hydrograph Study Volume 3: Hydrologic Data for Two Urban Highway Watersheds in the Salt Lake City Area, Utah

Joel E. Fletcher

Cheng-lung Chen

Follow this and additional works at: https://digitalcommons.usu.edu/water_rep



Part of the [Civil and Environmental Engineering Commons](#), and the [Water Resource Management Commons](#)

Recommended Citation

Fletcher, Joel E. and Chen, Cheng-lung, "Urban Storm Runoff Inlet Hydrograph Study Volume 3: Hydrologic Data for Two Urban Highway Watersheds in the Salt Lake City Area, Utah" (1975). *Reports*. Paper 480. https://digitalcommons.usu.edu/water_rep/480

This Report is brought to you for free and open access by the Utah Water Research Laboratory at DigitalCommons@USU. It has been accepted for inclusion in Reports by an authorized administrator of DigitalCommons@USU. For more information, please contact digitalcommons@usu.edu.



URBAN STORM RUNOFF INLET HYDROGRAPH STUDY

Volume 3

**Hydrologic Data for Two Urban Highway Watersheds
in the Salt Lake City Area, Utah**

by

Joel E. Fletcher and Cheng-lung Chen

Prepared for

**Federal Highway Administration
Offices of Research and Development
Washington, D.C. 20590**

**Utah Water Research Laboratory
College of Engineering
Utah State University
Logan, Utah 84322**

May 1975

PRWG106-3

The contents of this report reflect the views of the authors who are responsible for the facts and accuracy of the data presented herein. The contents do not necessarily reflect the official views or policy of the Department of Transportation. This report does not constitute a standard, specification, or regulation.

ABSTRACT

The main objective of this study is to develop an accurate design method for computing inlet hydrographs of surface runoff, with average recurrence intervals of 10, 25, and 50 years, from typical urban highway by flood routing technique.

Hydrologic data such as the rainfall intensity, runoff flow rate, air temperature, wind velocity, and soil moisture content were collected during rainfall seasons in 1972 and 1973 on two urban highway watersheds in the Salt Lake City area, Utah. These data were used in the verification of a mathematical model simulating the surface runoff from such highway watersheds. The difficulties and inherent problems associated with field data collection from urban highway cross-section are discussed and possible remedies recommended. Hyetographs and the corresponding hydrographs of major storms which occurred in 1972 and 1973 at both sites are presented. Watershed infiltration capacities of sideslopes at both sites are empirically evaluated.

Fletcher, J. E., and C. L. Chen, Urban Storm Runoff Inlet Hydrograph Study: Vol. 3. Hydrologic Data for Two Urban Highway Watersheds in the Salt Lake City Area, Utah. Final Report, PRWG106-3, Utah Water Research Laboratory, Utah State University, Logan, Utah 84322, May 1975.

Key Words: Air temperature, Data collection, Field data, Highway, Hydrographs, Hyetographs, Rainfall, Retention, Soil moisture, Storms, Runoff, Watershed, Wind

PREFACE

The work described in this report was performed under contract DOT-FH-11-7806, entitled "Urban Storm Runoff Inlet Hydrograph Study" between the Federal Highway Administration and Utah State University. This research contract was aimed at the development of an accurate design method for computing inlet hydrographs of surface runoff under intense rainstorms on urban highways. One of the major tasks in this research project was the collection of hydrologic data from typical urban highway cross-sections. The field data including precipitation and runoff were used in the verification of a mathematical model of surface runoff which was formulated in the analytical phase of the project. The work reported herein was part of the field phase of the project.

This report is a summary of the hydrologic data collected during rainfall seasons in 1972 and 1973 on two urban highway cross-sections in the Salt Lake City area, Utah.

The research was conducted under the general supervision of Dr. Cheng-lung Chen, Professor of Civil and Environmental Engineering at Utah State University. The field phase of the research was primarily performed by Joel E. Fletcher, Professor of Hydrology at Utah State University. Gratitude is due many students who helped collect and reduce field data in the course of the investigation.

The contract was monitored by Dr. D. C. Woo, Contract Manager, Environmental Design and Control Division, Federal Highway Administration. The authors are indebted to him for his ideas to initiate this study and overall research plan, detailed discussions of research conduct of all phases, and critical reviews and comments of the results during the course of the work.

This volume is third in a series. The others in the series are:

Vol. No.	Title	UWRL Report No.
1	Computer Analysis of Runoff from Urban Highway Watersheds Under Time- and Space-Varying Rainstorms	PRWG106-1
2	Laboratory Studies of the Resistance Coefficient for Sheet Flows over Natural Turf Surfaces	PRWG106-2
4	Synthetic Storms for Design of Urban Highway Drainage Facilities	PRWG106-4
5	Soil-Cover-Moisture Complex: Analysis of Parametric Infiltration Models for Highway Sideslopes	PRWG106-5

TABLE OF CONTENTS

	Page
INTRODUCTION	1
FIELD INSTALLATIONS OF EQUIPMENT	3
Selection of Test Sites	3
Layton Site	3
Layout	3
Measuring equipment	7
Parleys Site	11
Layout	11
Measuring equipment	11
Data Collection and Reduction	12
Nonelectronic charts	12
Precipitation charts	14
Runoff charts	14
Inlet flume	14
Problems associated with data collection	14
FIELD MEASUREMENTS	21
Layton Site	21
Precipitation data	21
Runoff data	21
Temperature data	21
Wind data	21
Soil moisture data	21
Parleys Site	21
Precipitation data	21
Runoff data	31
Temperature data	31
Wind data	31
Soil moisture data	31
HYETOGRAPHS AND HYDROGRAPHS FOR MAJOR STORMS	47
EVALUATION OF WATERSHED RETENTION	69
SUMMARY AND CONCLUSIONS	73
RECOMMENDATIONS	75
REFERENCES	77

LIST OF FIGURES

Figure		Page
1	Typical urban highway cross-sections in the Salt Lake City area	4
2	Location of field test sites with respect to Salt Lake City, Utah	5
3	Equipment layout and topography of Layton site	6
4	A view of the Layton site looking up the drainage channel—the paved portion and the cut slopes both drain toward the center and through the measuring flume	7
5	Bobbed tailed cutthroat flume used to measure the runoff at the Layton site	8
6	Typical weighing recording rain gage for measuring precipitation at the Layton site	9
7	The Truchek rain gage	9
8	The air temperature sensor used at both the Layton site and Parleys site	10
9	The wind speed and direction recorder used at the Layton site	10
10	Soil moisture measuring circuit	11
11	Switching system used to sense three soil moisture depths in sequence	12
12	Equipment layout and topography of Parleys site	13
13	Bobbed tailed cutthroat flume and view downstream from PW-1 at Parleys site number 1	14
14	A view of the curb inlet and electronics used to gage the runoff from PW-2 at the Parleys site number 2	15
15	Drawings of grate inlet box with measuring flume in place	15
16	Helical wound wire and protecting tube used as a depth sensor at PW-2 at the Parleys site number 2	16
17	Salt Lake City inlet flume depth measuring system, Parleys site	17
18	Schematic drawing of time synchronizer at both sites	19
19	September 5, 1972 storm at Layton site	48
20	October 19-20, 1972 storm at Layton site	49
21	October 23, 1972 storm at Layton site	50
22	April 17, 1973 (AM) storm at Layton site	51

LIST OF FIGURES (CONTINUED)

Figure		Page
23	April 17, 1973 (PM) storm at Layton site	52
24	May 25, 1973 storm at Layton site	53
25	May 25-26, 1973 storm at Layton site	54
26	July 19, 1973 storm at Layton site	55
27	September 1-2, 1973 storm at Layton site	56
28	November 18, 1973 storm at Layton site	57
29	September 5, 1972 storm at Parleys site	58
30	September 19, 1972 storm at Parleys site	59
31	October 4-5, 1972 storm at Parleys site	60
32	April 29, 1973 storm at Parleys site	61
33	July 19, 1973 storm at Parleys site	62
34	August 16, 1973 storm at Parleys site	63
35	September 1, 1973 storm at Parleys site	64
36	September 23, 1973 storm at Parleys site	65
37	October 8, 1973 storm at Parleys site	66
38	October 23, 1973 storm at Parleys site	67
39	Estimated infiltration capacity of soil on sideslope at Parleys site	70
40	Estimated infiltration capacity of soil on sideslope at Layton site	71

LIST OF TABLES

Table		Page
1	Rating table for a regular 2-foot 90° V-notched, cutthroat flume (bobbed tailed) in cfs	8
2	The relation between readings on the minigraph recorder chart in 1/100 inches and the flow through the inlet flume in cfs	16
3	Precipitation records for Layton site weighing gages	22
4	Precipitation in Truchek gages, Layton site	28
5	Hydrograph information, Layton site LW-1	29
6	Minimum and maximum temperature during runoff, Layton site	30
7	Layton site minimum and maximum winds and direction during runoff events	31
8	Soil moisture levels at the beginning of each runoff event, Layton site	31
9	The date, time, intensity, and accumulated depths of rainfall at the gages at Parleys site during 1972 and 1973	32
10	Precipitation in Truchek gages, Parleys site	40
11	Runoff dates, times of beginning, ending, and change of flow rate and flow rates for Parleys site 1972 and 1973 for PW-1 flume	41
12	Runoff measured in Parleys site sump flume (PW-2) with date of event, time of starting, change of flow rate, and ending with flow rates during each time period 1972-1973	43
13	Minimum and maximum temperature during runoff events at Parleys site	45
14	Maximum and minimum wind speed and direction during runoff events at Parleys site, 1972-1973	45
15	Soil moisture in the Parleys site at the beginning of the runoff events during 1973	45
16	Rainfall amounts at Layton and Parleys sites during storms when precipitation at one of the gages was zero	68

INTRODUCTION

Collection of field data such as precipitation and runoff for the verification of a mathematical model simulating the rainfall-runoff process is not an easy task, especially on an urban interstate highway where factors related to the human activities such as the amount of passing traffic reduce the reliability of data. For example, the splash from heavy traffic during a storm not only accounts for a significant portion of the precipitation lost but also interrupts the natural rainfall-runoff process. In addition, all the equipment to be installed would be subjected to potential dangers—accident and vandalism, because the highway nowadays becomes a center of the human activities. Despite these anticipated difficulties and other related problems, the equipment was installed and data collected for two rainfall seasons in 1972 and 1973. (Data were still being taken in 1974 at the time this report was written.) Field data collected include rainfall intensities, runoff flow rates, temperatures, wind velocities, and soil moisture

contents at two highway cross-sections in the Salt Lake City area, Utah. Data for each rainfall event in final, usable form are presented in this report.

The project was initiated in June 1971, requiring the balance of the first rainfall season for the selection of test sites as well as procurement and installation of field equipment. Thus, to date only two seasons of field data could be collected and reduced. As will be shown later in this report, the year 1972 happened to be a season with infrequent storms. Several major storms occurred in 1973, however. Hyetographs and the corresponding hydrographs of the major storms will be presented to characterize, if possible, the typical rainfall-runoff process on the urban highway cross-sections. No attempt was made herein to further analyze the hyetographs and hydrographs at the inlet, but such a study will be made in connection with other phases of the project.

FIELD INSTALLATIONS OF EQUIPMENT

In view of the difficulties in obtaining reliable field data, the senior author visited a few major cities such as Baltimore, Philadelphia, and Chicago where similar data were or have been collected for many years. Precaution was thus taken to avoid unnecessary interruption of field measurements due to the improper design of installed equipment, such as a discharge-measuring flume. The main problem encountered in Baltimore, according to Schaake (1971, personal contact), was the plugging of the stilling well intake by debris. However, no debris on the Baltimore watersheds was large enough to plug the throats of the Parshall flume installed.

The gaging problems encountered in Chicago were also due to debris plugging the 1/4 or 1/8 inch intake pipe to the stilling wells in the flumes (Kiefer, 1971, personal contact). The plugging showed its effects on both reduced depth in the stilling wells as well as on time lags in the hydrographs measured by the flumes. A slot or a series of small holes for the intake rather than a 1/4 or 1/8 inch pipe was devised in this project to solve such intake problems.

Field inspection of the runoff gaging sites indicated that a measuring device such as the cut-throat flume developed by Skogerboe et al. (1971) would be most advantageous since it passes debris and sediment and only requires a minimum head loss in the measurement.

Selection of Test Sites

In order to attain the primary objective of field data collection, namely, the verification of the mathematical model by use of field data, several factors were considered in the selection of test sites. It was determined that first the sites should have standard urban highway cross-sections which offer various aspects of the runoff process including a unique simple pattern of overland flow to either or both sides and/or gutter flow. Second, the geometry of the drainage area should be simple and the ground surface (paved or grassed) should be even and homogeneous so that there would be no problem in describing them mathematically. Finally, the precipitation expectancies at the sites should be so high that major storms with substantial intensities are expected to occur many times during a rainfall season.

Conferences were held with Utah Highway Department engineers to select test sites in the Salt Lake City area. A number of sites which have cross-sections similar to those specified by the Federal Highway Administration were considered and inspected before the selection. Three cross-sections, as shown in Figure 1, were chosen for collection of hydrologic data including rainfall intensity and runoff discharge.

A cross-section similar to Figure 1(a), which represents a single drainage area for runoff from a combined roadway (impervious) and sideslope (paved or grassed), was found near Gentile Street on I-15 at Layton, a suburb of Salt Lake City. This site will be hereafter called the Layton site. Two typical cross-sections were found on I-215 near Parleys Canyon and 33rd South Street in Salt Lake City. The first of these as shown in Figure 1(b), drains water from a sideslope to a gutter. The second, shown in Figure 1(c), drains water from a roadway having four traffic lanes to a curb and gutter. The former cross-section at Parleys Canyon hereafter will be referred to as Parleys site number 1 and the latter, Parleys site number 2. The locations of both sites with respect to Salt Lake City environments are shown in Figure 2. The installations of equipment on both sites are described below.

Layton Site

Layout

The equipment layout and the topography are shown in Figure 3. This test site has an area of 58,625 square feet (553 feet long and 106 feet wide) and has a single runoff gaging flume called WL-1. Precipitation is measured by six Belfort 5-780 weighing recording rain gages (L-1, L-2, L-3, L-4, L-5, and L-6) set at 24 hours per rotation, one Belfort 5-780 weighing recording rain gage (L-7) set at 196 hours per rotation, and six Truchek rain gages (SL-1, SL-2, SL-3, SL-4, SL-5, and SL-6). In addition to the precipitation gages, soil moisture is recorded at one location (LM), wind direction and speed (LW) at one location, and air temperature (LT) at one location.

The soil at this location is a compact, well aggregated clay loam covered with crested wheat

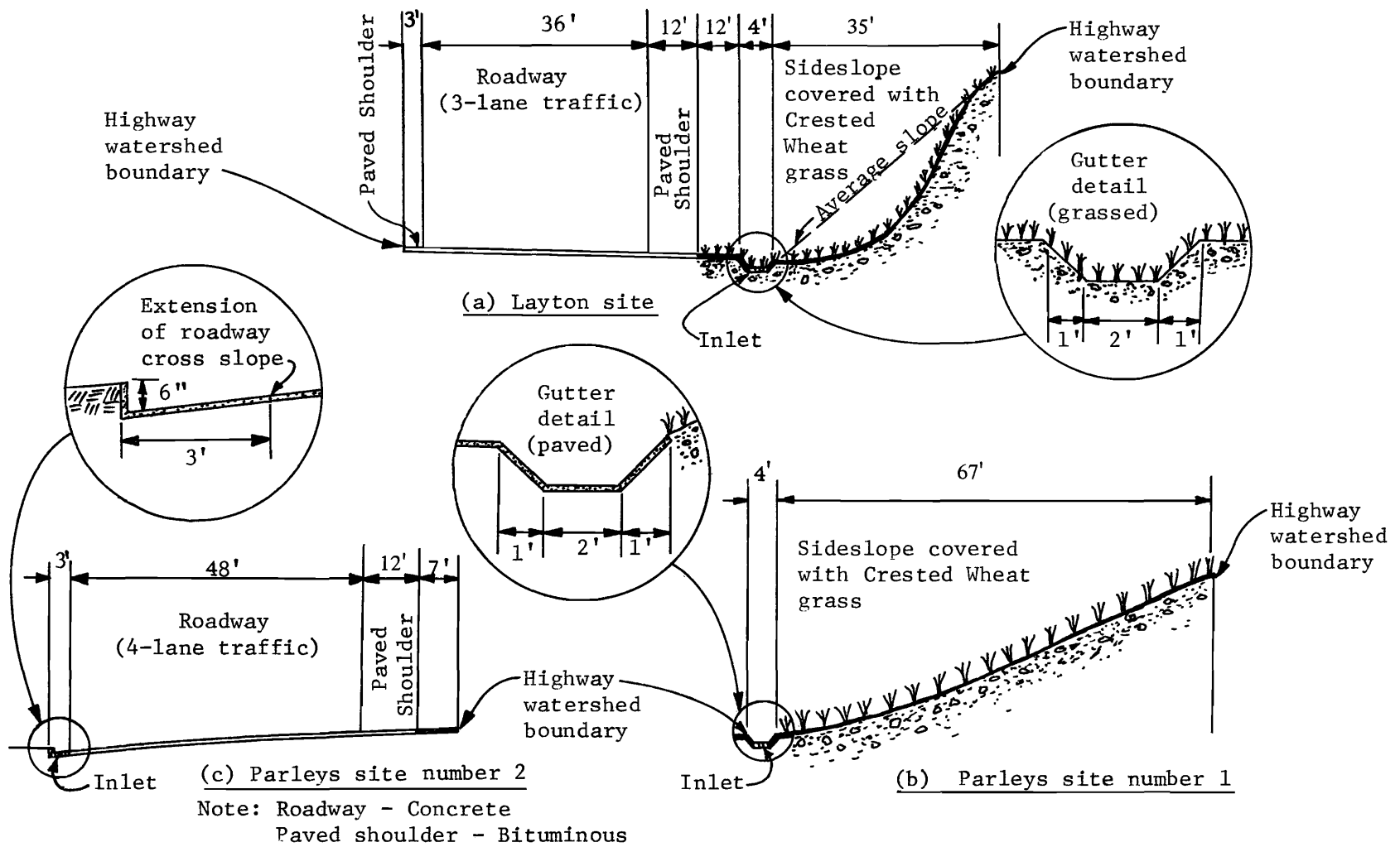

Figure 1. Typical urban highway cross-sections in the Salt Lake City area.

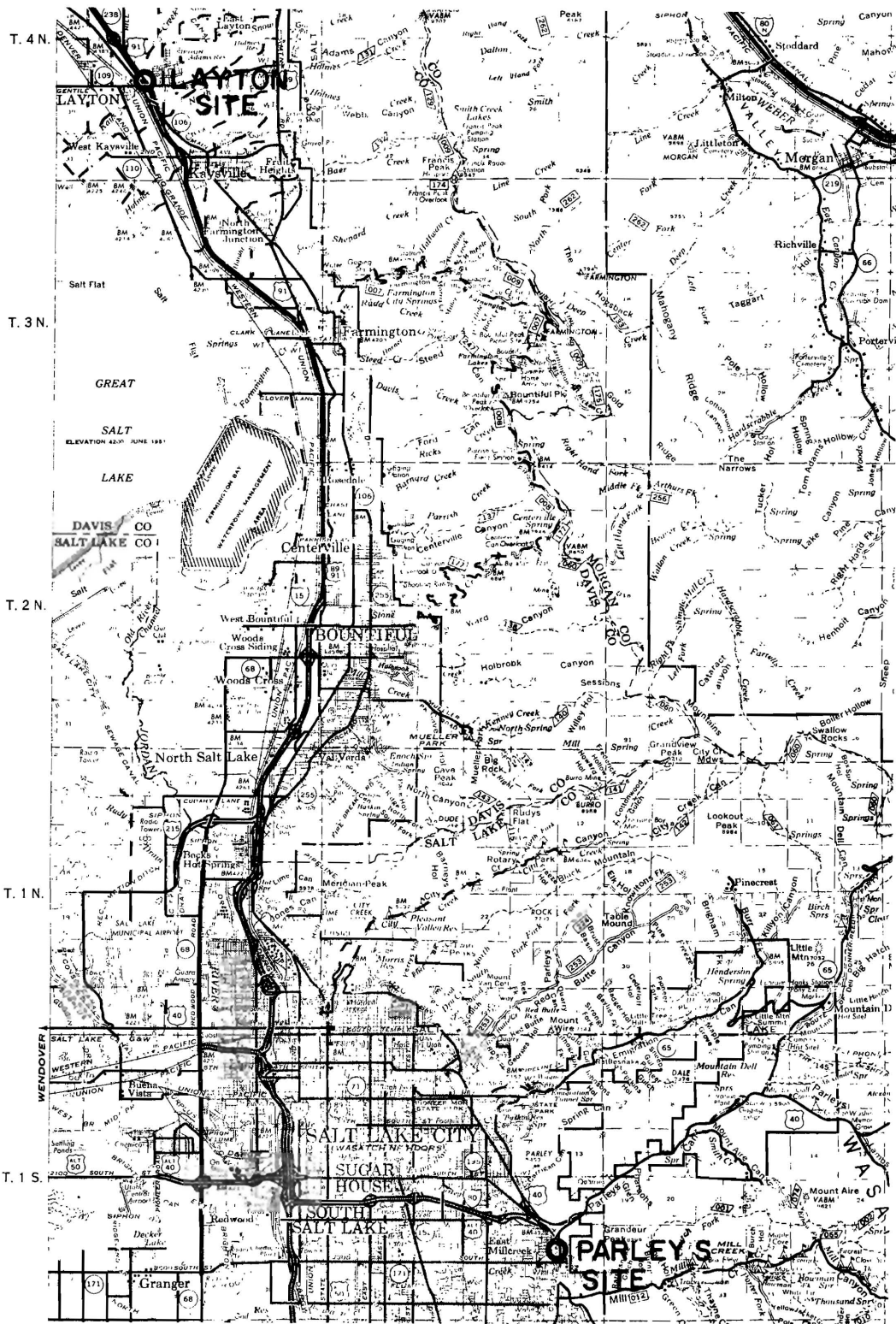

Figure 2. Location of field test sites with respect to Salt Lake City, Utah.

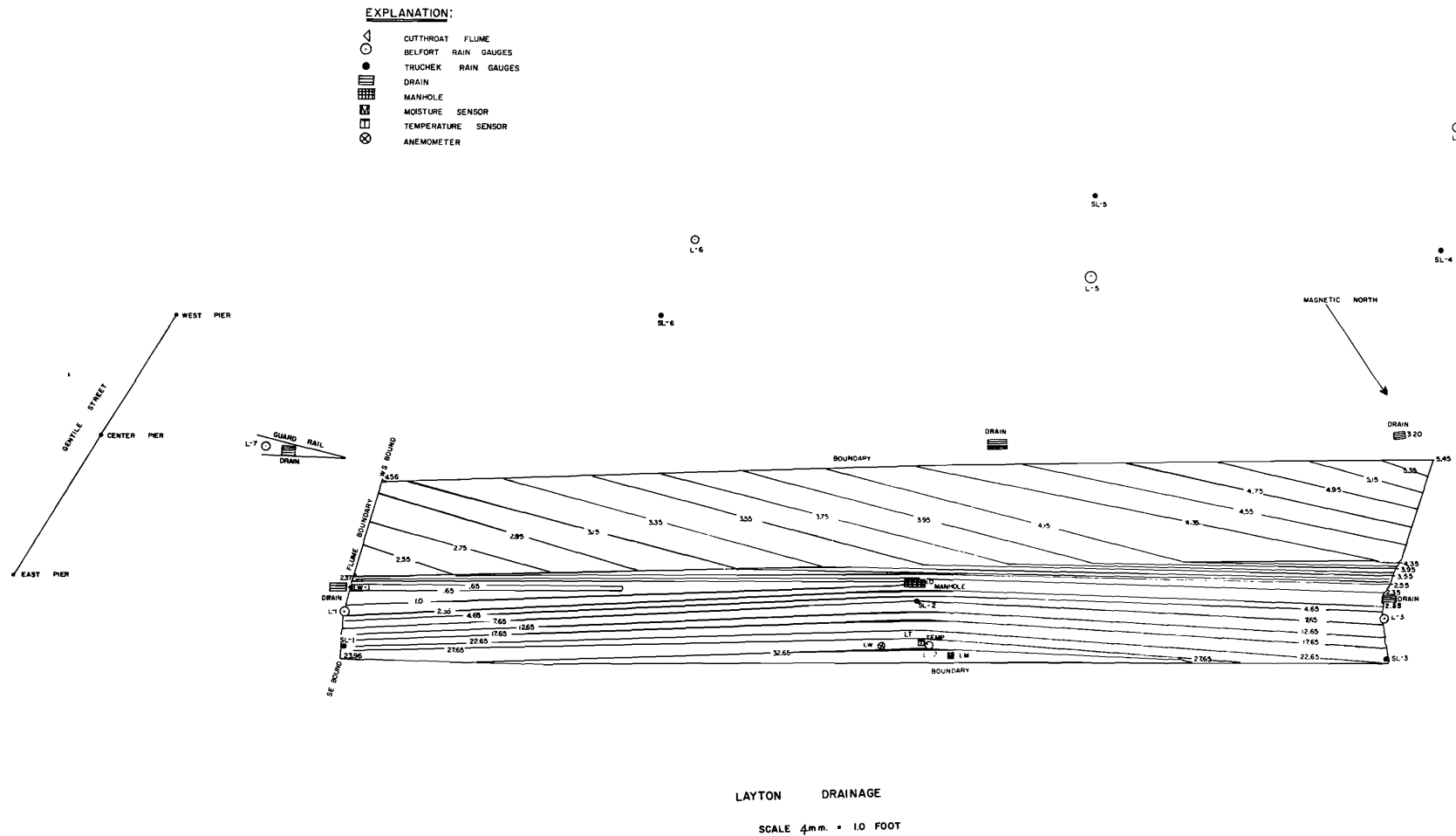

Figure 3. Equipment layout and topography of Layton site.

grass. The toe of the slope midway up the area is poorly drained and is wet throughout the year.

Figure 4 shows a photographic view of the Layton site from the measuring flume, WL-1, facing northerly and looking up the drainage area. The center of the northbound traffic lane of I-15 forms the west boundary of the drainage while the top of the sideslope on the right side of the picture forms the east boundary. Water from the drainage flows through the flume, WL-1, and free falls into the drainage grate inlet in the foreground.

Measuring equipment

Runoff is measured by a 90° bobbed tailed cutthroat flume shown in Figure 5, using a Belfort 5-FW-1 water level recorder on 12 hour rotation to record the water stage. This flume was developed by Skogerboe et al. (1967) at the Utah Water Research Laboratory. The rating table for the cutthroat flume is shown in Table 1. The cutthroat flume passes all types of debris with a minimum of interference and has about the same one percentage error on the small and large flow measurements. Debris was the principal problem on the Chicago and Baltimore watersheds. However, no debris difficulties have been experienced with this flume.

Rain gages. Rain gages L-1, L-2, L-3, L-4, L-5, and L-6 are 6 inches per traverse, weighing, recording rain gages, of Belfort 5-780 type (see Figure 6) and are set for 24 hours per rotation on an 8-day, mechanical clock. If the data on these charts are reduced on the electronic digitizer, intensities for time intervals as short as one minute and depths of 0.01 inch may be digitized. Rain gage L-7 is also a Belfort 5-780 type, but the clock is 192 hours per rotation to assure assigning the rains to the proper day and time of day.

Rain gages SL-1, SL-2, SL-3, SL-4, SL-5, and SL-6 are 6-inch capacity Truchek rain gages (Weather Measure P567). (See Figure 7.)

Temperature. Temperature is measured to 1° F by using a bimetallic temperature sensor obtained from Science Associates No. 156 (Figure 8) and recorded on a thermograph equipped with a 7-day rotation mechanical clock.

Wind. Wind velocity (speed and direction) is sensed at a single location near the center of the drainage area with a R. M. Young No. 6404 field recording wind set (Figure 9). The sensor measures wind speeds between 1.2 and 50 mph to about 2 percent accuracy and their directions to 16 points.



Figure 4. A view of the Layton site looking up the drainage channel—the paved portion and the cut slopes both drain toward the center and through the measuring flume.

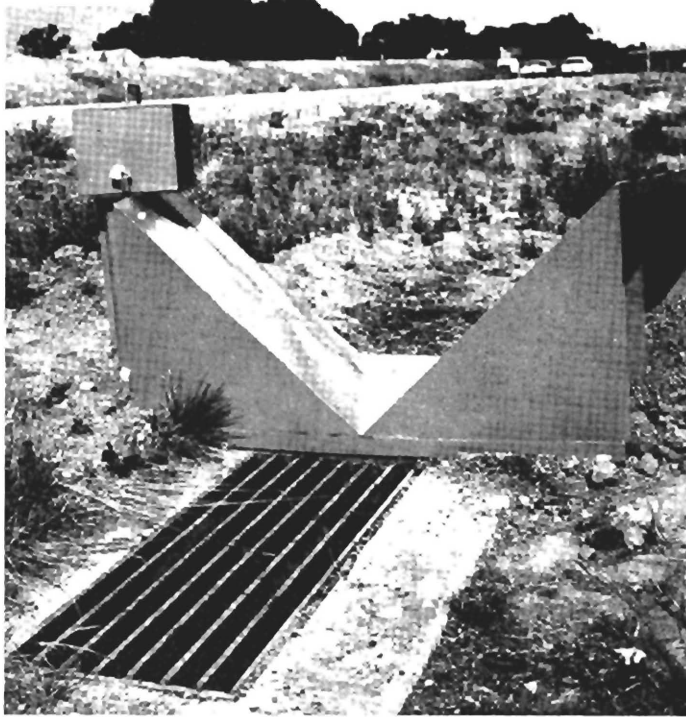

Figure 5. Bobbed tailed cutthroat flume used to measure the runoff at the Layton site.

Table 1. Rating table for a regular 2-foot 90° V-notched, cutthroat flume (bobbed tailed) in cfs.

h_a (ft)	.00	.01	.02	.03	.04	.05	.06	.07	.08	.09
0.0	0.0000	0.000018	0.00011	0.00031	0.00065	0.00115	0.00180	0.0027	0.0039	0.0052
0.1	0.0070	0.0088	0.011	0.0135	0.0165	0.0195	0.0235	0.0270	0.0315	0.0360
0.2	0.0410	0.0435	0.052	0.060	0.066	0.073	0.081	0.090	0.097	0.115
0.3	0.1170	0.1270	0.140	0.150	0.163	0.175	0.187	0.200	0.215	0.235
0.4	0.2470	0.2650	0.280	0.300	0.325	0.335	0.355	0.375	0.400	0.420
0.5	0.4400	0.4651	0.490	0.510	0.530	0.560	0.590	0.620	0.650	0.675
0.6	0.700	0.719	0.735	0.785	0.830	0.865	0.900	0.935	0.970	1.0000
0.7	1.030	1.045	1.12	1.16	1.20	1.24	1.28	1.34	1.40	1.44
0.8	1.48	1.52	1.56	1.60	1.64	1.70	1.76	1.83	1.90	1.95
0.9	2.00	2.05	2.10	2.16	2.22	2.28	2.35	2.42	2.50	2.55
1.0	2.60	2.68	2.76	2.84	2.92	3.00	3.08	3.16	3.24	3.32
1.1	3.40	3.48	3.56	3.64	3.72	3.80	3.88	3.97	4.05	4.12
1.2	4.20	4.26	4.32	4.38	4.44	4.50	4.62	4.74	4.86	4.98
1.3	5.10	5.20	5.30	5.40	5.50	5.60	5.72	5.84	5.96	6.08
1.4	6.20	6.32	6.44	6.56	6.68	6.80	6.92	7.04	7.16	7.28
1.5	7.40	7.56	7.72	7.88	8.04	8.20	8.32	8.44	8.56	8.68
1.6	8.80	8.92	9.04	9.16	9.28	9.40	9.48	9.56	9.64	9.72
1.7	9.80	9.93	10.05	10.18	10.32	10.45	10.52	10.59	10.66	10.73
1.8	10.80	10.94	11.08	11.22	11.36	11.50	11.68	11.86	12.02	12.20
1.9	12.40	12.62	12.84	13.06	13.28	13.60	13.78	13.96	14.14	14.32
2.0	14.50	14.70	14.90	15.10	15.30	15.50	15.66	15.83	15.98	16.14
2.1	16.30	16.52	16.74	16.96	17.28	17.50	17.64	17.78	17.92	18.11
2.2	18.30	18.58	18.86	19.14	19.42	19.70	19.86	20.02	20.18	20.36
2.3	20.50	20.74	20.98	21.23	21.48	21.72	21.97	22.21	22.46	22.71



Figure 6. Typical weighing recording rain gage for measuring precipitation at the Layton site. The instruments at its base are the recorders for wind and soil moisture.

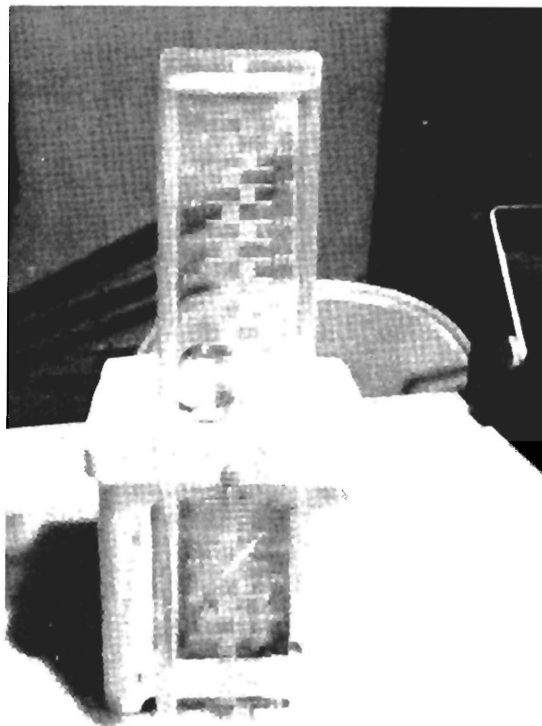

Figure 7. The Truchek rain gage.

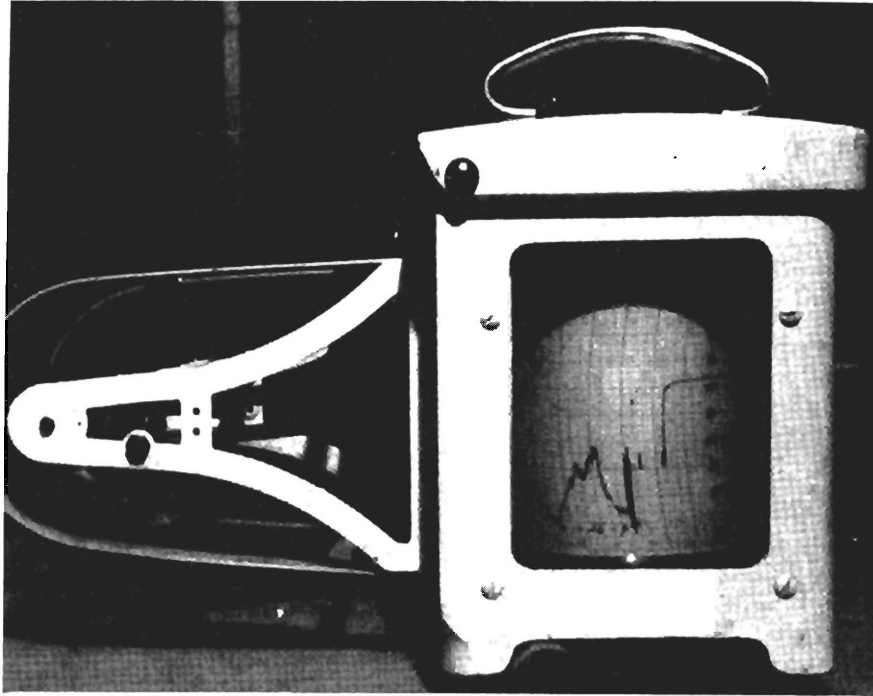

Figure 8. The air temperature sensor used at both the Layton site and Parleys site.



Figure 9. The wind speed and direction recorder used at the Layton site.

Soil moisture. Soil moisture is sensed at three soil depths—3 inches, 9 inches, and 18 inches—with Delmhorst plaster of paris blocks recording on an Esterline Angus minigraph 0-1MA recorder at one-fourth inch per hour chart speed. The sensing circuit is shown in Figures 10 and 11. The stepper rotates the readings successively from the depths 3 inches to 9 inches, from 9 inches to 18 inches, and back to 3 inches.

Parleys Site

Layout

The equipment layout and the topography of the Parleys site is shown in Figure 12. As mentioned previously, this site is composed of the two drainage areas, as shown in Figure 1. Site number 1 with an area of 23,529 square feet (351.50 x 66.94) drains from the top of the sideslope to the pavement edge. The runoff from this area is gaged with a 2-foot, 90° V-notched, bobbed tailed cutthroat flume, PW-1 (Figure 13), identical to that gaging the Layton site. The rating table (Table 1) also applies. Water in the flume is also sensed with a float and a Belfort 5-FW-1 water level recorder with the clock set for 12 hours per rotation. This area is well covered with a stand of crested wheat grass, but there are some small rills, as old erosion scars, which presently seem to be stabilized. The soil is a sandy loam with some silty clay lenses but of very loose, poorly aggregated structure.

Site number 2 draining 23,812 square feet (339.11 x 70.22) is the asphalt-paved northbound traffic lane of I-215. A curb forms the west boundary of the drainage with water from above being intercepted at the south grate inlet. The water from the roadway is discharged into the north grate inlet (Figure 14) where it is gaged. The water falls through the grill onto a flash plate which directs it into the upstream throat of an acute angled, 2 foot, V-notched cutthroat flume (PW-2) (Figure 15). The water level is sensed with a helical wound electrical depth sensor (Figure 16) and remotely recorded on an Esterline Angus minigraph recorder mounted between the guard rails in the median. This chart moves 1 inch per hour. The grate inlet and meter box are shown in the photograph in Figure 14. The rating table for flume PW-2 is shown in Table 2. The throat angle of this flume was of necessity made more acute than 90° to allow it to fit the grate inlet box and still have the required capacity. Some small quantities of debris have been observed to collect in the upper end of this flume such as pieces of automotive grill work, bolts, etc., but there is no evidence of sufficient accumulations to disturb the flow lines. The electronics are the principal problem with this flume and the calibrations must be checked weekly to ensure accurate time and depth.

Measuring equipment

Rain gages. Rain gages P-1, P-2, P-3, P-4, P-5, and P-6 (Figure 6) are Belfort 5-780 dual traverse, 6

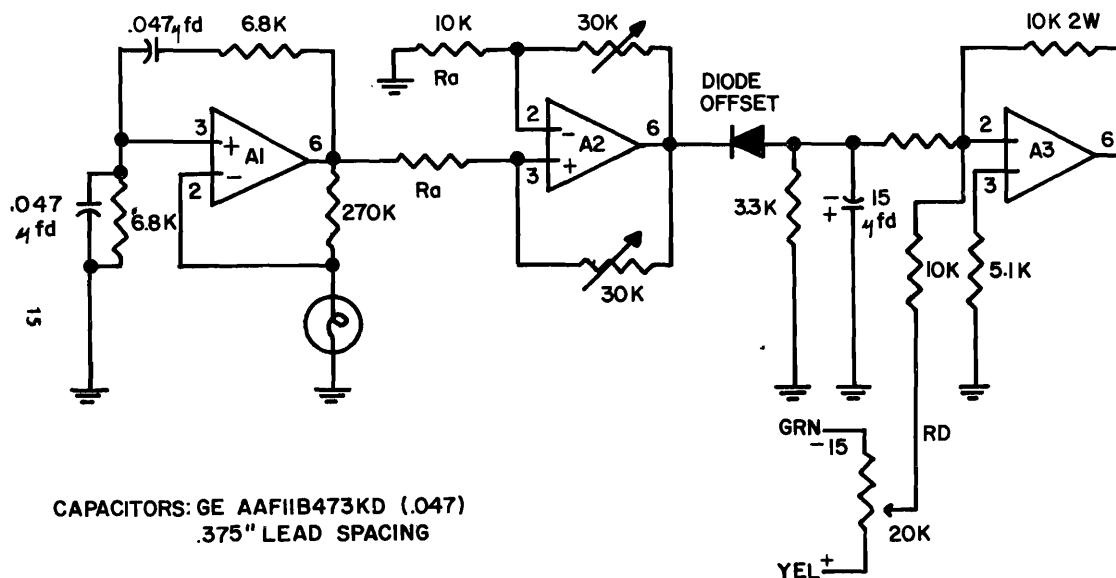

Figure 10. Soil moisture measuring circuit.

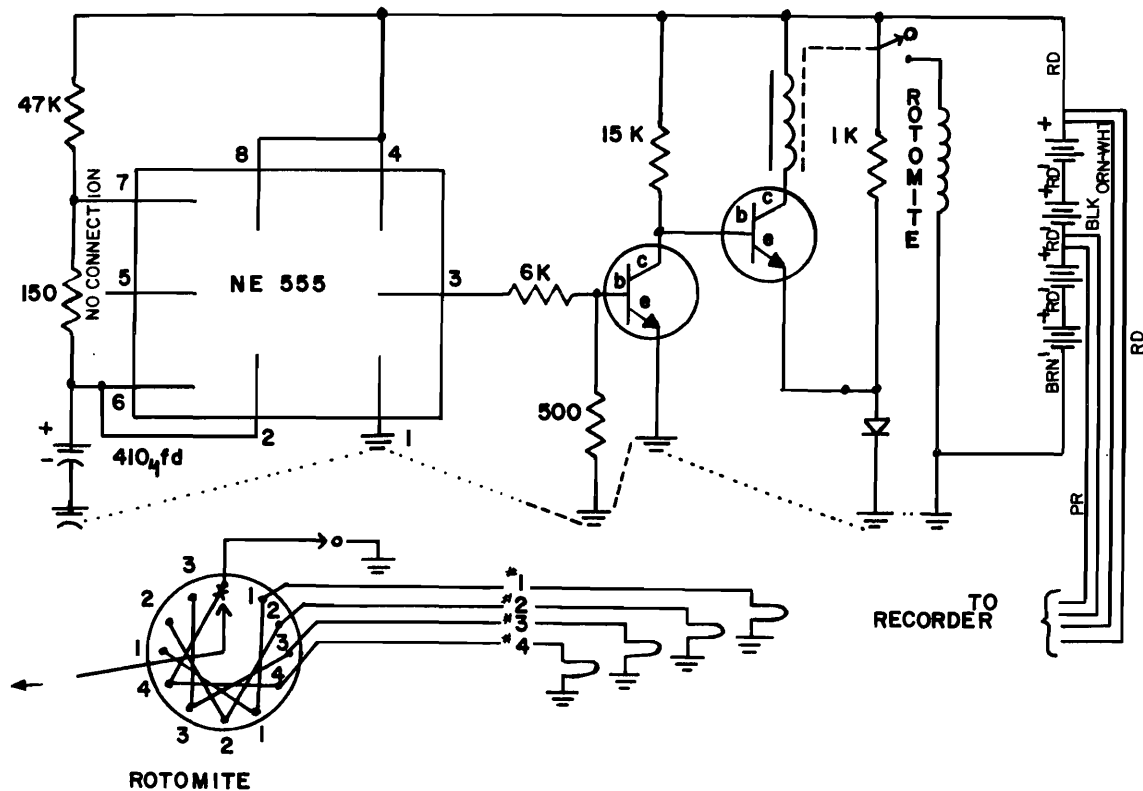

Figure 11. Switching system used to sense three soil moisture depths in sequence.

inches per traverse, weighing recording gages with the chart drives set for 24 hours per rotation. P-7 is the same Belfort 5-780 gage except that the chart drive is set for 192 hours per rotation. Rain gages SP-1, SP-2, SP-3, SP-4, SP-5, and SP-6 (Figure 7) are Truchek type gages (Weather Measure no. 567) the same as at the Layton site.

Temperature. Temperature is measured to 1°F with bimetallic temperature sensor (PT) and recorded on similar equipment to that at the Layton site (Figure 8).

Wind. Wind velocity is sensed to about 2 percent accuracy on equipment (PW) similar to that at the Layton site (Figure 9).

Soil moisture. Soil moisture is sensed and recorded on equipment (PM) similar to that at the Layton site (Figures 10 and 11).

Water level sensor for inlet flume. Circuitry for this water level sensor may be seen in Figure 17. The helical wound resistance coil is a 100 ohm per inch Beckman SM 350 helipot wire, bent in a U shape and mounted so as to be stable inside of a one inch PVC

perforated pipe (Figure 15). The four holes are only at the bottom and are one-fourth inch diameter to still the turbulent water as it falls into the flume. This pipe is mounted on the upstream wall of flume PW-2, as shown in Figure 15.

Data Collection and Reduction

Because mechanical recording systems were used in the field, all recorders required service at least once a week, regardless of whether or not there were storms. The collected data were reduced as follows:

Nonelectronic charts

The analog data on each chart are digitized on a Hewlett-Packard 9864A digitizer. In the Hewlett-Packard digitizer the analog trace of the chart record is traced with a cursor. This automatically tests any changes in slope which differ more than 10 percent and records them. The programs then reduce the data to an output form depending on which parameter is being read.

MAGNETIC NORTH

0 P-1
0 P-2
0 P-3
0 P-4
0 P-5
0 P-6
0 P-7
0 P-8
0 P-9
0 P-10
0 P-11
0 P-12
0 P-13
0 P-14
0 P-15
0 P-16
0 P-17
0 P-18
0 P-19
0 P-20
0 P-21
0 P-22
0 P-23
0 P-24
0 P-25
0 P-26
0 P-27
0 P-28
0 P-29
0 P-30
0 P-31
0 P-32
0 P-33
0 P-34
0 P-35
0 P-36
0 P-37
0 P-38
0 P-39
0 P-40
0 P-41
0 P-42
0 P-43
0 P-44
0 P-45
0 P-46
0 P-47
0 P-48
0 P-49
0 P-50
0 P-51
0 P-52
0 P-53
0 P-54
0 P-55
0 P-56
0 P-57
0 P-58
0 P-59
0 P-60
0 P-61
0 P-62
0 P-63
0 P-64
0 P-65
0 P-66
0 P-67
0 P-68
0 P-69
0 P-70
0 P-71
0 P-72
0 P-73
0 P-74
0 P-75
0 P-76
0 P-77
0 P-78
0 P-79
0 P-80
0 P-81
0 P-82
0 P-83
0 P-84
0 P-85
0 P-86
0 P-87
0 P-88
0 P-89
0 P-90
0 P-91
0 P-92
0 P-93
0 P-94
0 P-95
0 P-96
0 P-97
0 P-98
0 P-99
0 P-100

- EXPLANATION:
- COTTONWOOD FLUME
 - RECORD RAIN GAUGES
 - TRUCK RAIN GAUGES
 - DRAINAGE
 - METEOROLOGICAL
 - MOISTURE SENSOR
 - TEMPERATURE SENSOR
 - ANEMOMETER
 - WATER LEVEL RECORDER

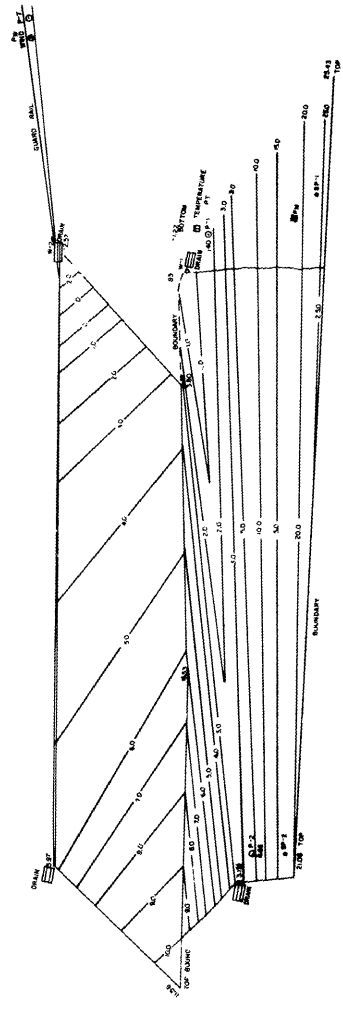

SCALE 1" = 100'

I-215 PARLEYS CANYON

Figure 12. Equipment layout and topography of Parleys site.

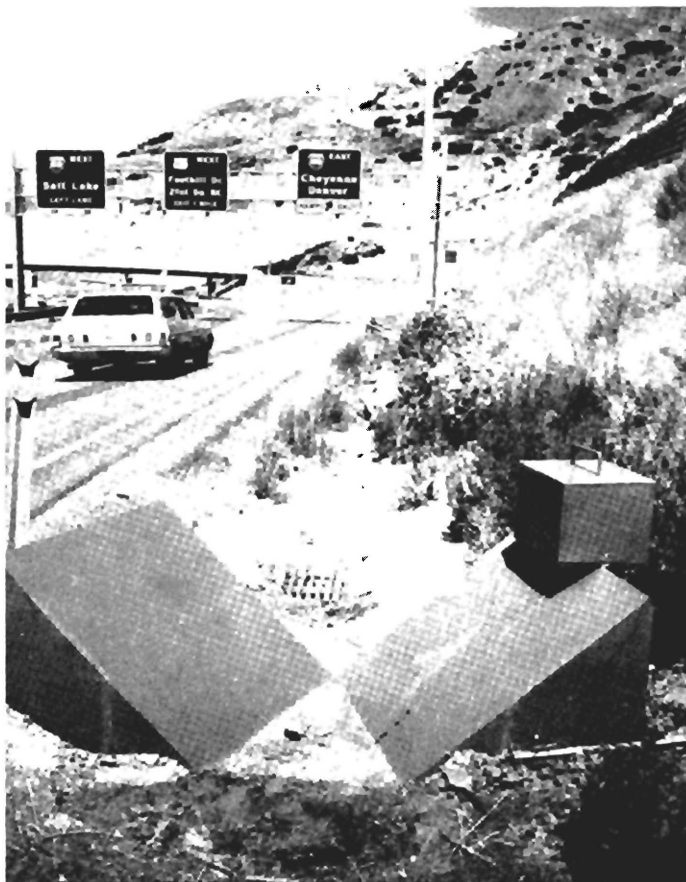

Figure 13. Bobbed tailed cutthroat flume and view downstream from PW-1 at Parleys site number 1.

Precipitation charts

The precipitation data are output as intensity for each time period whose slope does not differ more than plus or minus 10 percent.¹ Thus, the output is digitized into a form ready to plot directly on a histogram or convert directly to isopluvial maps, or standard time increments.

Runoff charts

Water level charts are digitized to read in time intervals in minutes and fractions, and depths in hundredths of a foot at the beginning and ending of each time interval. The data are in a form to directly enter the rating table to obtain either the intensity or direct flow hydrograph.

¹Ten percent is the amount of leeway required to ignore vibrations due to wind and traffic on a precipitation gage chart.

Inlet flume

The nature of the chart on this sensor is such as to render automatic reduction difficult since the reference base line shifts and differences must be read as well as the paper being pressure recorded. These were read with a scale directly in hundredths of an inch at each time interval. The rating table (Table 2) was entered with this reading to get the hydrograph intensities.

This sensor could and should be improved by means of more stable electronics and a recorder with a wider chart which records on paper suitable for electronic digitizing.

Problems associated with data collection

Many problems have been encountered during data collection. Some of them were readily corrected

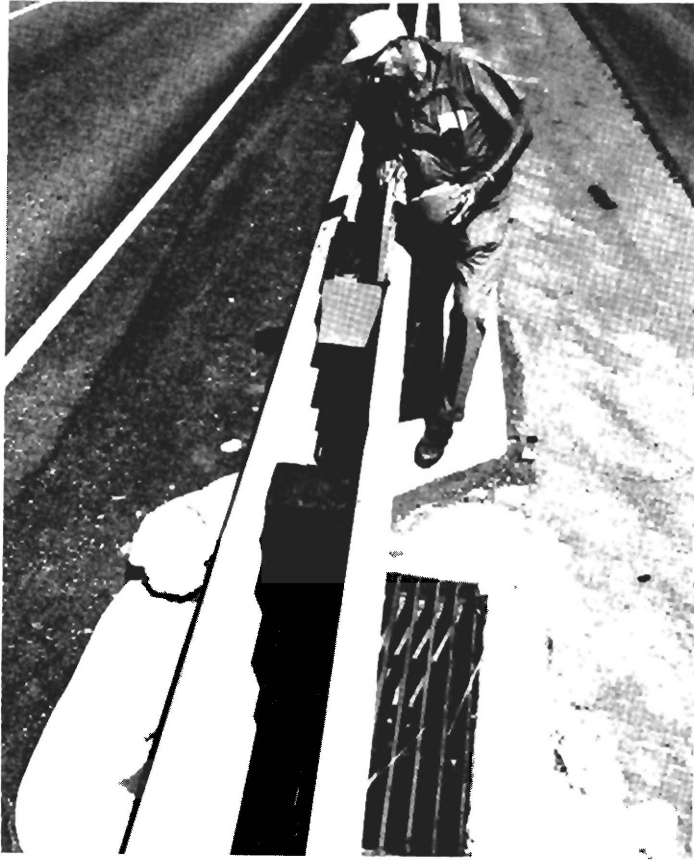

Figure 14. A view of the curb inlet and electronics used to gage the runoff from PW-2 at the Parleys site number 2.

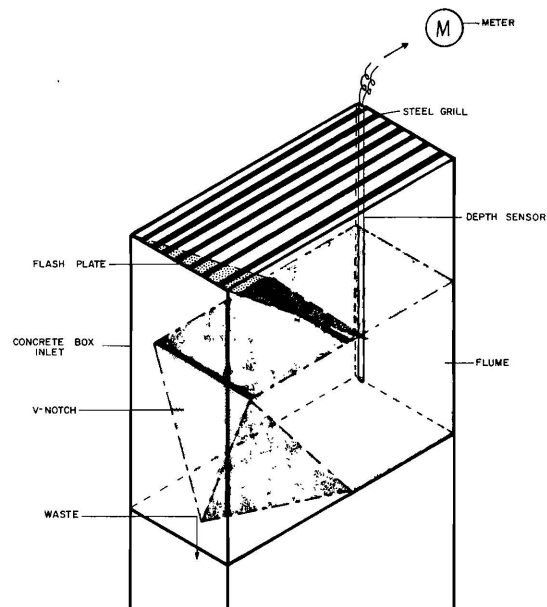

Figure 15. Drawings of grate inlet box with measuring flume in place.

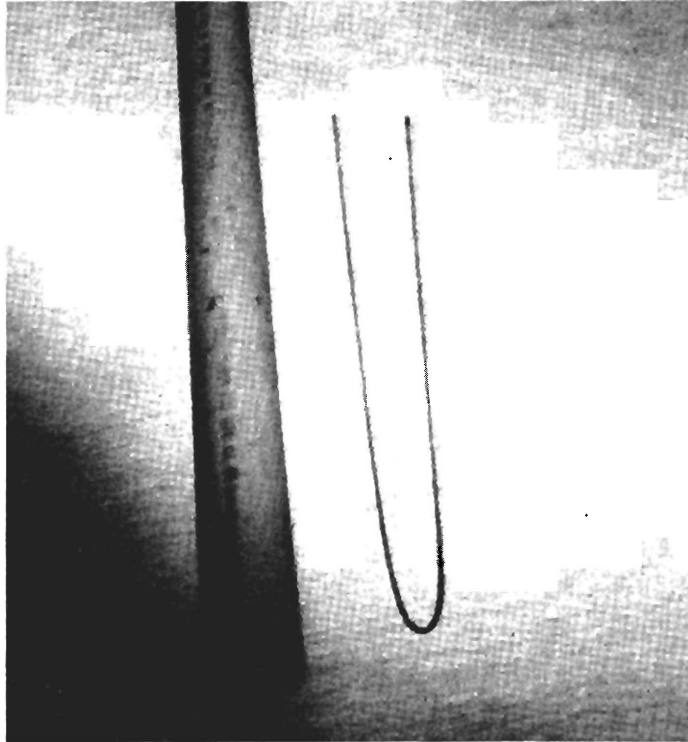
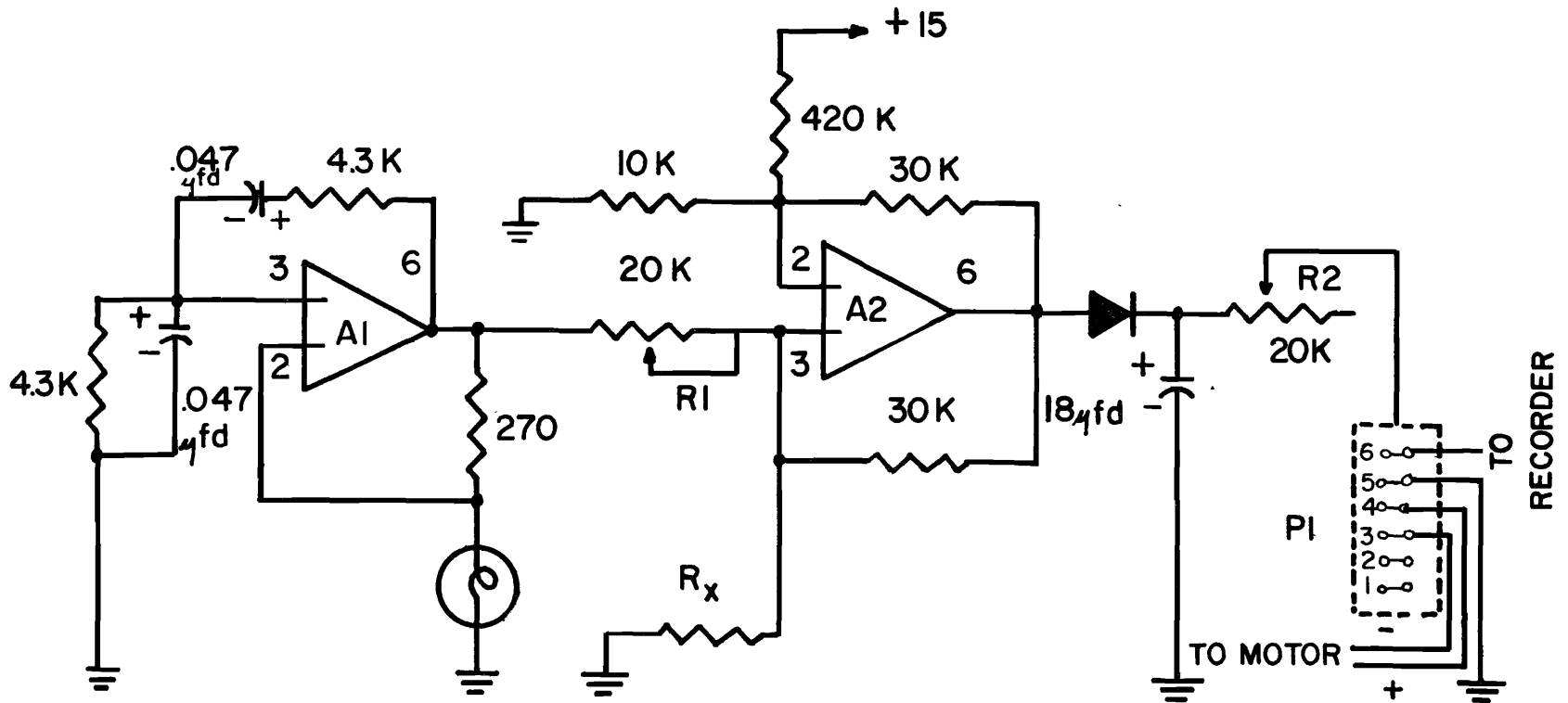

Figure 16. Helical wound wire and protecting tube used as a depth sensor at PW-2 at the Parleys site number 2.

Table 2. The relation between readings on the minigraph recorder chart in 1/100 inches and the flow through the inlet flume in cfs.

Inches	.00	.01	.02	.03	.04	.05	.06	.07	.08	.09
.00	0.0000	.0085	.018	.026	.034	.041	.049	.056	.063	.069
.10	.077	.083	.090	.097	.103	.109	.115	.122	.129	.135
.20	.140	.146	.154	.165	.175	.185	.195	.206	.216	.229
.30	.245	.260	.269	.279	.290	.305	.320	.330	.343	.362
.40	.375	.390	.400	.410	.423	.440	.450	.465	.480	.495
.50	.507		.54		.57		.60		.63	
.60	.66		.68		.72		.75		.78	
.70	.81		.84		.87		.90		.94	
.80	.97		1.00		1.03		1.07		1.11	
.90	1.15		1.19		1.22		1.25		1.30	
1.00	1.34		1.37		1.40		1.43		1.47	
.10	1.52		1.55		1.58		1.62		1.67	
.20	1.72		1.76		1.80		1.84		1.89	
.30	1.95		1.99		2.04		2.08		2.12	
.40	2.17		2.20		2.24		2.28		2.31	
1.50	2.35		2.40		2.45		2.50		2.55	
.60	2.60		2.63		2.67		2.70		2.76	
.70	2.80		2.86		2.92		2.98		3.04	
.80	3.10		3.14		3.18		3.22		3.26	
.90	3.30		3.34		3.38		3.42		3.46	
2.00	3.50		3.58		3.66		3.74		3.82	
.10	3.90		3.94		3.98		4.02		4.06	
.20	4.10		4.14		4.18		4.22		4.26	
.30	4.30		4.36		4.42		4.48		4.54	
.40	4.60		4.66		4.72		4.78		4.84	
.50	4.90		4.94		5.04					



ADJUST R_1 AT MINIMUM OUTPUT (IS 20in. OF WATER)
ADJUST R_2 AT MAXIMUM OUTPUT (IS 0in. OF WATER)
NOTE: THE RECORDER IS READING FULL-SCALE AT 0in. OF WATER.

Figure 17. Salt Lake City inlet flume depth measuring system, Parleys site.

in situ, but others could not be done without changes in the instrumentation systems. Such problems and their possible remedies are discussed in the following:

Rain gages. Calibration of the precipitation gages was checked at monthly intervals to be sure the depths recorded were correct. Each week the time was checked by watch and any differences recorded on the chart as part of the observer's notes.

Another problem that should be remedied before future data are taken is the gaps in the areal coverage of precipitation sensors in the medians. This could be greatly alleviated by putting more Truchek or other gages in locations where recorders would not be suitable either because of their being a hazard to traffic or vice versa.

Runoff measurement. One problem encountered in the measurement of runoff from the paved areas subject to heavy traffic was the lack of any measurements of water splashed away from area subject to gaging. The water on the east lane was splashed to the area draining through gage PW-1 and the water from the lane nearest the median was splashed across the curbing into the median which was not gaged. The net result of all the splashing during peak traffic periods was loss of a large portion of the water gaged by PW-2 and some supplementing of the water gaged by PW-1.

At Layton site the loss of water from the traffic lane is not obvious since the traffic lanes and cut slope both drain through gage LW-1 and the only water loss is that splashed into the median by traffic in the adjacent lane.

Inlet flume. Calibration of the inlet water level recorder was checked frequently by dipping the sensor in a cylinder of water of known depth and the recorded depth and measured depth compared.

Time synchronizing. Time blips were used to synchronize the timing on precipitation and water level equipment. The circuits for this timer are shown in Figure 18. Great difficulty was experienced in keeping this equipment operating because the exposed wires between the sensing equipment were such an easy target for vandals and chance encounters with highway maintenance equipment. If this synchronizer is to be used, the wires should be placed either underground or in the curved portions of guard rails, etc.

Soil moisture measurements. In areas such as these two sites, drought can persist for sufficient lengths of time that soils may become air dried. Research by Fletcher (1960) has shown that infiltration decreases both directions from near the wilting percentage. Normally only the zones above the wilting percentage are considered as antecedent moisture, but each moisture content is significant in the runoff process.

Temperature measurement. Temperature exerts its influence on the runoff process (Fletcher, 1949) through surface tension, viscosity, and wettability. The influence for one arid area amounted to 1.35 percent increase in runoff per degree centigrade raise in temperature.

Wind measurement. Wind up or down a drainage may either inhibit or enhance runoff rate particularly from the paved areas. With boundaries of the drainage being as flat as in the present sites, cross winds or up or down winds can actually blow water on or off of the basin. In addition, the rainfall catch is profoundly affected by winds in excess of 20 miles per hour.

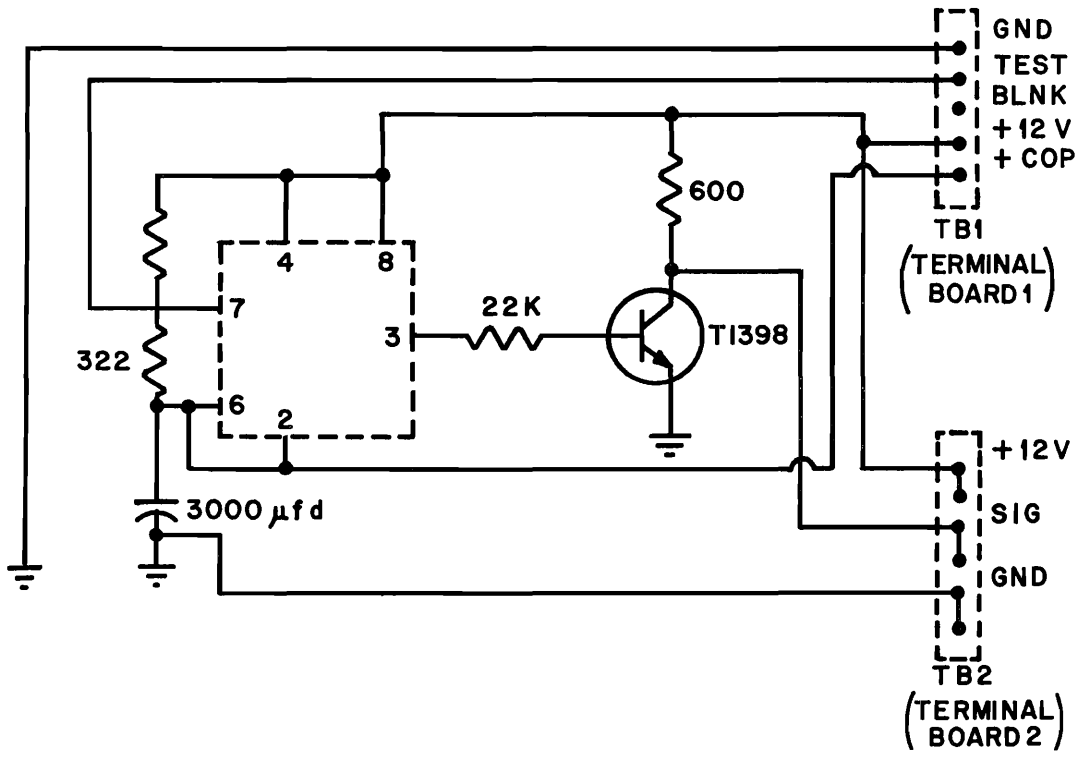
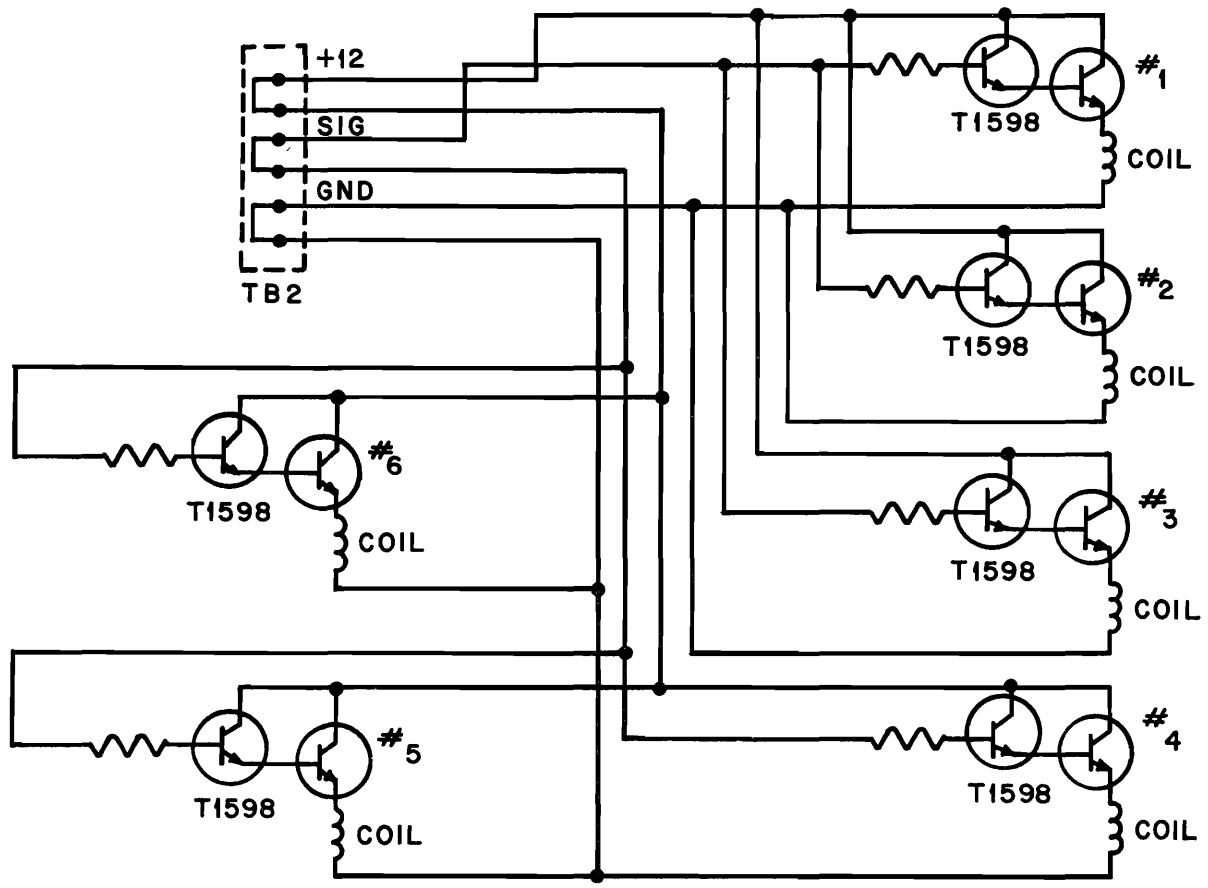

Figure 18. Schematic drawing of time synchronizer at both sites.

FIELD MEASUREMENTS

The field measurements are reported by each site beginning with precipitation, followed by runoff in a detailed fashion with temperature, wind, and soil moisture presented as summaries for periods of precipitation only.

Layton Site

Precipitation data

Precipitation data, time periods for constant units of intensity (or total in the case of nonsignificant storms), the accumulated depth and the intensity during the aforementioned time periods with periods of no record shown from the first measured rain at the site on June 23, 1972, through the first snowfall in October 1972 and beginning again after snowmelt, the first of April, through snowfall in November 1973. Observations are being continued through the thunderstorm season of 1974 and will be reported at a later date.

The rainfall depth and intensity for each of seven recording gages are given in Table 3 and the Truchek gage rainfall depths are given in Table 4.

Runoff data

The first runoff measured at the Layton site did not occur until September 1972 even though the station was in operation from April on. The runoff is tabulated in the chronological order of rainstorm events which occurred between snowmelt (April) and snowfall (November) in 1972 and 1973. In Table 5, for each event the rate of flow in cubic feet per second is tabulated against date time. Observations are continuing in 1974 and will be tabulated separately.

Temperature data

The minimum and maximum temperature (°F) during each runoff event beginning with the first runoff event at the Layton site on September 5, 1972, until snowfall after November 5, 1972, and

beginning again after snowmelt in April 1973 are tabulated in Table 6. There are no apparent temperature relations with respect to rainfall-runoff events, but no detailed analyses were made.

Wind data

The maximum and minimum wind speeds and mean direction of the wind during the runoff events at the Layton site are given in Table 7. There was customarily a veering in wind direction at the beginning of precipitation events.

Soil moisture data

Soil moisture samples were taken at three depths, from 0 to 6 inches, from 6 to 12 inches, and from 12 to 24 inches during 1973. Electrical resistance moisture sensors were also installed at depths of 3, 9, and 18 inches. The moisture samples served as calibration points for the recorder.

The soil moisture ranged from well above field capacity following rains before equilibria to just above air dry on the surface to wetting percentage at the lower depths. The moisture measurements are shown in Table 8.

Parleys Site

Precipitation data

Precipitation data, time of beginning and ending of each change in intensity, and the accumulated depth and intensity of these times are given for the rainy season of 1972 and 1973 in Table 9. The Truchek rain gage data are given in Table 10. Records began with the first rain after snowmelt on June 23, 1972, and continued until snowfall on November 7. The 1973 records began after snowmelt on April 14, 1973, and continued until snowfall after November 25, 1973. Records continued in 1974, and will be compiled at a later date. Truchek gages were read at the time the recording gages were serviced.

Table 3. Precipitation records for Layton site weighing gages.

L-1				L-2				L-3				L-4				L-5				L-6				L-7															
Date	Time	Depth in.	Intensity in./hr	Date	Time	Depth in.	Intensity in./hr	Date	Time	Depth in.	Intensity in./hr	Date	Time	Depth in.	Intensity in./in	Date	Time	Depth in.	Intensity in./hr	Date	Time	Depth in.	Intensity in./hr	Date	Time	Depth in.	Intensity in./hr												
1972																																							
23 June	12:15A	0	Began	23 June	12:12P	0	Began	23 June	12:12P	0	Began	23 June	12:15A	0	Began	23 June	12:15A	0	Began	23 June	12:15A	0	Began	23 June	12:15A	0	Began	23 June	12:15A	0	Began								
	1:00A	0.05	End		1:00P	0.05	End		1:00P	0.05	End		12:30A	0.05	End		12:30A	0.06	End		12:30A	0.05	End		12:30A	0.05	End		12:30A	0.02	End								
13 Aug.	5:40P		Began	13 Aug.	6:15P		Began	13 Aug.	5:30P		Began	13 Aug.	6:00P		Began	13 Aug.	6:25P		Began	13 Aug.	5:00P		Began	13 Aug.	5:15P		Began	13 Aug.	5:15P		Began								
	7:10P	0.15	End		7:00P	0.15	End		3:25P	0.22	End		3:15P	0.27	End		3:15P	0.27	End		3:10P	0.22	End		6:10P	0.14	End		6:10P	0.14	End								
14 Aug.	12:37P		Began	14 Aug.	2:00P		Began	5 Sept.	8:00A		Began	5 Sept.	7:50A		Began	5 Sept.	12:30A		Began	5 Sept.	7:55A		Began	14 Aug.	11:30A		Began	14 Aug.	11:30A		Began								
	3:17P	0.11	End		3:15P	0.12	End		12:30P	0.28	End		8:00A	0.05	0.30		12:30P	0.32	End		8:11A	0.20	0.75		3:05P	0.12	End		3:05P	0.12	End								
5 Sept.	2:05A		Began	5 Sept.	7:45A		Began	5 Sept.	4:17P		Began	5 Sept.	8:05A		0.20	5 Sept.	4:16P		Began	5 Sept.	8:45A		0.25	5 Sept.	2:00A		Began	5 Sept.	2:00A		Began								
	12:20P	0.35	End		12:25P	0.33	End		4:30P	0.05	0.23		8:30A	0.25	0.12		5:20P	0.06	0.06		12:00N	0.25	0.00	5 Sept.	12:15A	0.32	End	5 Sept.	12:15A	0.32	End								
5 Sept.	4:15P		Began	5 Sept.	4:15P		Began	5 Sept.	5:15P		0.05	5 Sept.	11:50A		0.25	5 Sept.	5:29P		0.15	5 Sept.	12:25P		0.35	6 Sept.	5:00P		Began	6 Sept.	5:00P		Began								
	4:30P	0.05	0.20		4:30P	0.05	0.20		5:20P	0.07	0.24		5:31P	0.32	0.16		5:31P	0.21	1.80		2:47P	0.35	0.00	6 Sept.	8:00P	0.52	End	6 Sept.	8:00P	0.52	End								
	5:22P	0.05	0.00		5:17P	0.06	0.01		5:37P	0.35	0.99		5:42P	0.34	0.71		5:42P	0.34	0.71		4:20P	0.35	0.00		8:00P		Began		8:00P		Began								
	5:29P	0.20	1.29		5:17P	0.14	2.40		5:45P	0.42	0.53	5 Sept.	5:47P		0.39		4:35P	0.40	0.20		4:35P	0.40	0.20		8:00P		Began		8:00P		Began								
	5:32P	0.27	1.40		5:26P	0.20	0.40		6:50P	0.47	0.05		5:57P	0.42	0.18		5:20P	0.42	0.18		5:20P	0.42	0.03		5:20P	0.42	0.03	18 Sept.	8:00P	0.58	End	18 Sept.	8:00P	0.58	End				
	5:37P	0.35	0.96		5:30P	0.30	1.50		7:53P	0.51	0.04		5:20P	0.14	0.96		7:45P	0.48	0.03		5:28P	0.55	0.96		5:28P	0.55	0.96	4 Oct.	4:00P		Began	4 Oct.	4:00P		Began				
	5:46P	0.41	0.47		5:33P	0.35	1.00		End		End		5:25P	0.18	0.48		11:20P	0.50	<0.01		5:32P	0.60	0.75		5:32P	0.60	0.75	5 Oct.	6:00P	0.60	End	5 Oct.	6:00P	0.60	End				
	5:57P	0.44	0.16		5:47P	0.45	0.43	18 Sept.	8:30P		Began		5:35P	0.35	1.02		End		End		5:40P	0.72	0.90		5:40P	0.72	0.90	9 Oct.	8:00A		Began	9 Oct.	8:00A		Began				
	7:45P	0.50	0.08		10:00P	0.55	0.02		9:20P	0.01	0.01		9:22P	0.09	2.40		7:45P	0.52	0.05	18 Sept.	9:15P		Began		5:46P	0.78	0.60		5:46P	0.78	0.60	9 Oct.	10:00A	0.20	Began	9 Oct.	10:00A	0.20	Began
18 Sept.	8:20P		Began	18 Sept.	8:30P		Began	19 Sept.	10:15P		0.15	18 Sept.	9:15P		Began	19 Sept.	10:00P		0.14	18 Sept.	7:47P		0.87	18 Sept.	7:47P		0.87	13 Oct.	5:00A		Began	13 Oct.	5:00A		Began				
	9:12P	0.04	0.05		9:10P	0.03	0.04	19 Sept.	12:40P		0.16	18 Sept.	9:20P		0.02	19 Sept.	12:30A		0.15	18 Sept.	8:27P		Began	18 Sept.	8:27P		Began												
	9:17P	0.12	0.96		9:15P	0.10	0.84		1:11A	0.20	0.08	18 Sept.	9:25P		0.07	19 Sept.	1:12A		0.19	18 Sept.	9:15P	0.01	0.01	19 Oct.	9:30A		Began	19 Oct.	9:30A		Began								
	10:00P	0.17	0.06		10:01P	0.16	0.08		1:30A	0.26	0.18	18 Sept.	9:20P		0.24	19 Sept.	1:35A		0.22	18 Sept.	9:17P	0.10	2.70	20 Oct.	4:00P	1.25	End	20 Oct.	4:00P	1.25	End								
	10:50P	0.20	0.03	19 Sept.	12:30A	0.20	0.02		1:46A	0.31	0.19	18 Sept.	9:25P		0.60	19 Sept.	2:25A	0.50	0.29	19 Sept.	10:00P	0.15	0.07	20 Oct.	6:00P		Began	20 Oct.	6:00P		Began								
19 Sept.	12:25A	0.21	0.02		1:07A	0.22	0.04		2:25A	0.50	0.29	18 Sept.	10:05P		0.12	19 Sept.	3:00A	0.57	0.12	19 Sept.	12:25A	0.17	0.01	28 Oct.	6:00P		Began	28 Oct.	6:00P		Began								
	1:02A	0.24	0.04		1:35A	0.32	0.21		3:00A	0.57	0.12	19 Sept.	3:40A		0.60	4 Oct.	7:05P		Began	19 Sept.	1:13A	0.20	0.04	29 Oct.	12:15P	0.23	End	29 Oct.	12:15P	0.23	End								
	1:17A	0.27	0.12		1:45A	0.35	0.18		End		End	4 Oct.	7:30P		Began	4 Oct.	7:30P	0.05	0.12	19 Sept.	2:25A	0.47	0.23	4 Nov.	9:45P		Began	4 Nov.	9:45P		Began								
	1:28A	0.33	0.32		2:12A	0.48	0.29		End		End	4 Oct.	9:00P	0.10	0.07	5 Oct.	2:33A	0.47	0.26	4 Oct.	2:15A	0.45	0.26	4 Nov.	2:20P		Began	4 Nov.	2:20P		Began								
	1:40A	0.35	0.10		3:00A	0.60	0.15	4 Oct.	7:30P		Began	4 Oct.	9:00P	0.10	0.07	5 Oct.	2:33A	0.47	0.26	5 Oct.	2:13A	0.20	0.15	4 Nov.	2:20P		Began	4 Nov.	2:20P		Began								
	2:15A	0.51	0.27		3:36A	0.64	0.07	4 Oct.	9:00P	0.10	0.07	5 Oct.	2:25A	0.14	<0.01	5 Oct.	2:30A	0.25	0.18	5 Oct.	2:13A	0.20	0.15	4 Nov.	2:20P		Began	4 Nov.	2:20P		Began								
	2:55A	0.60	0.14		End		End	5 Oct.	2:25A	0.14	<0.01	5 Oct.	2:37A	0.18	0.20	5 Oct.	2:30A	0.25	0.18	4 Oct.	2:30A	0.25	0.18	4 Nov.	2:20P		Began	4 Nov.	2:20P		Began								
	3:20A	0.63	0.07		End		End	5 Oct.	2:37A	0.18	0.20	4 Oct.	4:29A	0.28	0.18	4 Oct.	2:30A	0.25	0.18	4 Oct.	2:30A	0.25	0.18	4 Nov.	2:20P		Began	4 Nov.	2:20P		Began								
	End		End	4 Oct.	7:15P		Began	4 Oct.	4:30A	0.21	0.02	4 Oct.	4:29A	0.28	0.18	4 Oct.	2:30A	0.25	0.18	4 Oct.	2:30A	0.25	0.18	4 Nov.	2:20P		Began	4 Nov.	2:20P		Began								
4 Oct.	7:15P		Began	5 Oct.	9:02P	0.12	0.13	4 Oct.	4:40A	0.26	0.30	4 Oct.	4:29A	0.28	0.18	4 Oct.	2:30A	0.25	0.18	4 Oct.	2:30A	0.25	0.18	4 Nov.	2:20P		Began	4 Nov.	2:20P		Began								
	7:50P	0.05	0.09	5 Oct.	2:12A	0.15	<0.01	4 Oct.	4:40A	0.26	0.30	4 Oct.	4:29A	0.28	0.18	4 Oct.	2:30A	0.25	0.18	4 Oct.	2:30A	0.25	0.18	4 Nov.	2:20P		Began	4 Nov.	2:20P		Began								
	8:20P	0.05	0.00	5 Oct.	2:30A	0.18	0.10	4 Oct.	4:40A	0.26	0.30	4 Oct.	4:29A	0.28	0.18	4 Oct.	2:30A	0.25	0.18	4 Oct.	2:30A	0.25	0.18	4 Nov.	2:20P		Began	4 Nov.	2:20P		Began								
	9:00P	0.15	0.15	5 Oct.	3:28A	0.24	0.06	4 Oct.	4:40A	0.26	0.30	4 Oct.	4:29A	0.28	0.18	4 Oct.	2:30A	0.25	0.18	4 Oct.	2:30A	0.25	0.18	4 Nov.	2:20P		Began	4 Nov.	2:20P		Began								
5 Oct.	2:17A	0.20	0.01	5 Oct.	3:35A	0.29	0.43	4 Oct.	4:40A	0.26	0.30	4 Oct.	4:29A	0.28	0.18	4 Oct.	2:30A	0.25	0.18	4 Oct.	2:30A	0.25	0.18	4 Nov.	2:20P		Began	4 Nov.	2:20P		Began								
	2:30A	0.24	0.19	5 Oct.	6:25A	0.35	0.02	4 Oct.	4:40A	0.26	0.30	4 Oct.	4:29A	0.28	0.18	4 Oct.	2:30A	0.25	0.18	4 Oct.	2:30A	0.25	0.18	4 Nov.	2:20P		Began	4 Nov.	2:20P		Began								
	3:30A	0.25	0.01	5 Oct.	7:40A	0.41	0.05	4 Oct.	4:40A	0.26	0.30	4 Oct.	4:29A	0.28	0.18	4 Oct.	2:30A	0.25	0.18	4 Oct.	2:30A	0.25	0.18	4 Nov.	2:20P		Began	4 Nov.	2:20P		Began								
	4:25A	0.27	0.02	5 Oct.	8:05A	0.54	0.31	4 Oct.	4:40A	0.26	0.30	4 Oct.	4:29A	0.28	0.18	4 Oct.	2:30A	0.25	0.18	4 Oct.	2:30A	0.25	0.18	4 Nov.	2:20P		Began	4 Nov.	2:20P		Began								
	4:33A	0.34	0.52	5 Oct.	8:15A	0.55	0.06	4 Oct.	4:40A	0.26	0.30	4 Oct.	4:29A	0.28	0.18	4 Oct.	2:30A	0.25	0.18	4 Oct.	2:30A	0.25	0.18	4 Nov.	2:20P		Began	4 Nov.	2:20P		Began								
	6:15A	0.40	0.03	5 Oct.	8:47A	0.58	0.06	4 Oct.	4:40A	0.26	0.30	4 Oct.	4:29A	0.28	0.18	4 Oct.	2:30A	0.25	0.18	4 Oct.	2:30A	0.25	0.18	4 Nov.	2:20P		Began	4 Nov.	2:20P		Began								
	6:30A	0.45	0.20	5 Oct.	End		End	4 Oct.	4:40A	0.26	0.30	4 Oct.	4:29A	0.28	0.18	4 Oct.	2:30A	0.25	0.18	4 Oct.	2:30A	0.25	0.18	4 Nov.	2:20P		Began	4 Nov.	2:20P		Began								
	7:37A	0.46	0.01	5 Oct.	End		End	4 Oct.	4:40A	0.26	0.30	4 Oct.	4:29A	0.28	0.18	4 Oct.	2:30A	0.25	0.18	4 Oct.	2:30A	0.25	0.18	4 Nov.	2:20P		Began	4 Nov.	2:20P		Began								
	7:48A	0.53	0.38	9 Oct.	1:32A		Began	4 Oct.	4:40A	0.26	0.30	4 Oct.	4:29A	0.28	0.18	4 Oct.	2:30A	0.25	0.18	4 Oct.	2:30A	0.25	0.18	4 Nov.	2:20P		Began	4 Nov.	2:20P		Began								
	8:17A	0.63	0.20	9 Oct.	1:45A	0.04	0.18	4 Oct.	4:40A	0.26	0.30	4 Oct.																											

Table 3. Continued.

L-1			L-2			L-3			L-4			L-5			L-6			L-7									
Date	Time	Depth Intensity in. in./hr	Date	Time	Depth Intensity in. in./hr	Date	Time	Depth Intensity in. in./hr	Date	Time	Depth Intensity in. in./hr	Date	Time	Depth Intensity in. in./hr	Date	Time	Depth Intensity in. in./hr	Date	Time	Depth Intensity in. in./hr							
	10:14P	0.27 0.39		11:17P	0.20 0.02		8:30A	0.25 0.03	4 Nov.	10:25P	Began	1973						8 Sept.	4:20A	0.30	Began						
	10:25P	0.33 0.33	29 Oct.	11:00A	0.22 <0.01		8:45A	0.28 0.03	5 Nov.	2:20P	0.37	17 April	6:00A	Began	28 Oct.	7:28P	Began		3:10P		End						
	10:48P	0.40 0.18		1:35P	0.34 0.05		9:00A	0.30 0.08				17 April	6:45A	0.05 0.08	29 Oct.	12:45P	0.21	8 Sept.	10:10P		End						
		End			End		9:20A	0.35 0.04	1973				7:00A	0.07 0.08	4 Nov.	10:15P	Began		11:30P	0.03	End						
28 Oct.	7:50P	Began	1973				9:30A	0.45 0.60	17 April	4:15A	Began		7:30A	0.10 0.06	5 Nov.	12:20P	0.65	11 Sept.	4:30A		Began						
	11:45P	0.25					9:35A	0.50 0.60		4:20A	0.15 1.80		8:00A	0.18 0.20					4:15A	0.14	End						
29 Oct.	10:00A	Began	17 April	4:07A	Began		9:45A	0.60 0.60		4:25A	0.15 0.00		7:45A	0.15 0.20	1973			17 April	3:15A	Began	24 Sept.	3:00P	Began				
	12:15P	0.10		4:30A	0.10 0.22		10:00A	0.65 0.20		7:00A	0.20 0.03		8:10A	0.20 0.06					3:30A	0.08	End	4:10P	0.06	End			
		End			End		10:30A	0.68 0.06		7:15A	0.25 0.20		8:20A	0.25 0.30					6:45A	0.05 0.00	25 Sept.	1:00A	Began				
1973			17 April	6:45A	0.10	Began		End		8:00A	0.30 0.07		9:00A	0.37 0.10					7:00A	0.10 0.20		3:30A	0.08	End			
17 April	4:07A	Began		7:30A	0.15 0.07	17 April	1:00P	0.68	Began	8:15A	0.35 0.08		9:30A	0.42 0.10					9:30A	0.15 0.10		8 Oct.	8:30A	Began			
	4:23A	0.07 0.26		8:00A	0.19 0.08		1:10P	0.73 0.20		8:30A	0.40 0.20		9:45A	0.50 0.32					7:45A	0.20 0.20		2:30P	0.25	End			
	4:45A	0.10 0.09		8:15A	0.28 0.36		1:15P	0.74 0.04		8:45A	0.45 0.20		9:55A	0.60 0.60					8:00A	0.20 0.00		2:00P		End			
	7:03A	0.10 0.00		8:30A	0.31 0.12		1:30P	0.80 0.06		9:00A	0.50 0.20		10:15A	0.70 0.30					8:05A	0.25 0.60		23 Oct.	2:00P	Began			
	8:14A	0.22 0.10		9:00A	0.38 0.14		1:45P	0.85 0.20		9:15A	0.53 0.12		10:45A	0.75 0.10					8:15A	0.30 0.30		5:30P	0.32	End			
	8:16A	0.27 1.50		9:15A	0.40 0.08		2:00P	0.90 0.20		9:30A	0.55 0.08		1:15P	0.75 0.00					8:45A	0.35 0.10				End			
	8:25A	0.30 0.05		9:30A	0.45 0.20		2:15P	0.92 0.08		10:00A	0.60 0.10		1:25P	0.80 0.30					9:30A	0.40 0.07		1 Nov.	4:30A	Began			
	9:30A	0.40 1.20		9:45A	0.60 0.60		End	End		10:45A	0.60 0.00		1:30P	0.85 0.60					9:35A	0.50 1.20		7:00P	0.08	End			
	9:40A	0.45 0.30		10:00A	0.70 0.40				28 April	8:45A	Began		1:45P	0.90 0.20					9:40A	0.55 0.60		3 Nov.	11:00A	Began			
	9:47A	0.55 0.86		10:30A	0.75 0.10		8:45A	0.05 0.30		8:55A	0.05 0.30		2:00P	0.95 0.20					9:45A	0.60 0.60		12:00N	0.13	End			
	10:03A	0.65 0.37		11:00A	0.77 0.04		9:00A	0.10 0.60		1:00P	0.75 0.07		End	End	28 April	8:45P	Began		10:00A	0.65 0.20		4 Nov.	9:00A	Began			
	10:15A	0.70 0.25		End	End		9:05A	0.15 0.60		1:30P	0.78 0.06		8:50P	0.05 0.60					10:30A	0.72 0.14		9:30A	0.05	End			
	10:45A	0.74 0.08		17 April	1:00P	0.77	9:45A	0.16 0.06		1:30P	0.78 0.06		9:00P	0.15 0.60					1:00P	0.72 0.00		12 Nov.	2:00P	Began			
		End		1:15P	0.82 0.20		10:00A	0.20 0.06		28 April	8:40P	Began	29 April	9:00P	0.20 0.20					1:15P	0.82 0.40		4:30P	0.15	End		
17 April	1:10P	0.74	Began	1:30P	0.90 0.32		End	End	28 April	8:45P	0.05 0.60		9:15P	0.20 0.20					1:30P	0.90 0.32		16 Nov.	8:10P	Began			
	1:45P	0.80 0.10		1:45P	0.95 0.20				28 April	8:55P	0.10 0.30		5:30A	0.25 0.01					1:50P	0.95 0.15		10:15P	0.08	End			
	2:07P	0.93 0.59		2:00P	0.99 0.16		5:25P	Began	28 April	9:00P	0.15 0.60		5:45A	0.42 0.68					End	End	28 April	8:30P	Began	18 Nov.	6:05A	Began	
	2:35P	0.97 0.08		2:15P	1.00 0.04		6:55P	0.15 0.00		7:00P	0.17 0.24		6:45A	0.47 0.05					8:52P	0.10 0.43		3:30P	1.00	End			
18 April	2:05P	Began	18 April	7:00P	Began		7:45P	0.19 0.08		7:45P	0.19 0.08		End	End	29 April	8:15A	Began		9:00P	0.18 0.60		21 Nov.	2:00A	Began			
	3:45P	0.13 0.08		8:30P	0.05		End	End	29 April	10:00P	0.25 0.07		End	End	29 April	9:00A	0.08 0.10		9:30P	0.22 0.08		9:00A	0.02	End			
		End			End				29 April	5:15A	Began		9:15A	0.18 0.40					End	End	29 April	5:00A	Began	21 Nov.	11:45A	Began	
24-30 April	No record		19 April	5:00A	Began	25 May	3:30A	Began	29 April	5:30A	0.10 0.40		9:30A	0.23 0.20					5:30A	0.23 0.46		22 Nov.	1:10P	Began			
30 April	12:00N	Began		6:00A	0.01 0.01		4:25A	0.15 0.00		5:45A	0.15 0.20		10:00A	0.26 0.06					End	End	29 April	5:00A	Began	21 Nov.	4:00P	End	
	12:40P	0.07 0.09		End	End		4:35A	0.20 0.30		8:00A	0.20 0.02		End	End	29 April	9:30A	0.23 0.40		End	End	29 April	5:30A	Began	22 Nov.	1:45P	End	
		End		28 April	8:45P	Began	5:00A	0.25 0.12		9:00A	0.25 0.05		End	End	25 May	3:30A	Began		End	End	29 April	8:15A	Began	24 Nov.	10:30A	Began	
25 May	3:30A	Began		9:00P	0.05 0.30		5:10A	0.30 0.30		10:30A	0.28 0.02		3:40A	0.10 0.60					8:45A	0.05 0.10		8:45P	0.15	End	24 Nov.	4:40P	0.14
	3:45A	0.10 0.40		9:07P	0.10 0.43		5:20A	0.35 0.30		11:30A	0.30 0.02		4:00A	0.15 0.15					9:00A	0.10 0.20		9:00A	0.20	End	25 Nov.	1:00P	Began
	4:30A	0.15 0.07		9:15P	0.15 0.37		5:40A	0.40 0.15		1:30P	0.35 0.03		4:45A	0.20 0.07					9:30A	0.20 0.20		10:00A	0.25 0.10		3:00P	0.06	End
	4:50A	0.20 0.15		9:30P	0.20 0.20		6:00A	0.45 0.15		End	End	25 May	5:00A	0.20 0.00					10:30A	0.20 0.20		10:00A	0.30 0.10		26 Nov.	10:00A	Began
	5:00A	0.20 0.00		10:00P	0.25 0.10		6:30A	0.50 0.10		3:33A	Began		5:15A	0.25 0.20					11:00A	0.35 0.10		11:00A	0.35 0.10		27 Nov.	9:00A	0.76
	5:10A	0.25 0.30		10:00P	0.45 0.02		End	End	25 May	3:52A	0.10 0.33		5:18A	0.30 1.00					End	End	25 May	8:45A	Began	2 Dec.	10:30A	Began	
	5:30A	0.35 0.20		10:00A	0.65 0.06	25 May	7:45A	Began		4:08A	0.16 0.23		5:35A	0.35 0.17					End	End	25 May	9:00A	0.05 0.20		2:30P	0.19	
	5:45A	0.40 0.20		11:30A	0.80 0.30		8:15A	0.05 0.10		4:29A	0.18 0.06		6:00A	0.45 0.22					End	End	25 May	9:15A	0.55 0.07		3 Dec.	2:15A	Began
	6:00A	0.45 0.20		End	End		9:30A	0.10 0.20		4:48A	0.23 0.15		End	End	25 May	8:45A	Began		End	End	25 May	3:15A	Began		5:00A	0.13	
	6:30A	0.50 0.10		25 May	3:30A	Began	10:00A	0.10 0.00		5:10A	0.26 0.14		End	End	25 May	9:00A	0.05 0.20		4:30A	0.15 0.00		4:30A	0.15 0.00		3 Dec.	5:00A	End
	7:30A	0.50 0.00		3:45A	0.15 0.60		10:05A	0.15 0.60		5:17A	0.32 0.51		10:00A	0.10 0.05					4:35A	0.20 0.60		5:00A	0.25 0.12				
	8:00A	0.55 0.10		4:35A	0.20 0.06		10:10A	0.20 0.60		5:58A	0.42 0.15		10:30A	0.30 0.40					5:05A	0.30 0.60		5:20A	0.35 0.20				
	8:45A	0.55 0.00		5:06A	0.25 0.12		10:15A	0.25 0.60		6:45A	0.47 0.05		10:45A	0.35 0.20					5:45A	0.40 0.12		5:45A	0.40 0.12				
	9:30A	0.60 0.07		5:15A	0.30 0.20		10:20A	0.30 0.60		8:46A	0.52 0.03		11:30A	0.40 0.07					6:30A	0.45 0.07		6:30A	0.45 0.07				
	10:00A	0.60 0.00		5:20A	0.35 0.60		10:30A	0.35 0.30		10:00A	0.55 0.02		12:30P	0.45 0.05					7:45A	0.50 0.04		7:45A	0.50 0.04				
	10:12A	0.65 0.25		5:30A	0.40 0.30		10:20A	0.30																			

Table 3. Continued.

L-1				L-2				L-3				L-4				L-5				L-6				L-7					
Date	Time	Depth in.	Intensity in./hr	Date	Time	Depth in.	Intensity in./hr	Date	Time	Depth in.	Intensity in./hr	Date	Time	Depth in.	Intensity in./hr	Date	Time	Depth in.	Intensity in./hr	Date	Time	Depth in.	Intensity in./hr	Date	Time	Depth in.	Intensity in./hr		
14 June	4:15A	0.05	Began 0.08 End	25 May	11:45P		Began	14 June	3:30P		Began	14 June	3:20P		Began	14 June	12:00M		Began	14 June	12:00M		Began						
	5:30A				12:00M	0.05	0.20		3:40P	0.05	0.30		3:30P	0.05	0.30		12:05A	0.05	0.60		12:05A	0.05	0.60						
14 June	9:20A		Began	26 May	12:15A	0.10	0.20	14 June	7:45P		Began	14 June	7:45P		Began	14 June	1:00A		0.00		1:00A	0.05	0.00						
	9:30A	0.05	0.30 End		12:40A	0.15	0.12		7:50P	0.07	0.84		8:00P	0.10	0.40		1:15A	0.10	0.20		1:15A	0.10	0.20						
14 June	3:00P		Began	14 June	12:00M		Began	12 July	12:00N		Began	13 July	1:19A		Began	13 July	1:45A		0.00		1:45A	0.10	0.00						
	3:40P	0.05	0.07 End		1:15A	0.08	0.07		12:27P	0.06	0.20		1:39A	0.03	0.09		2:00A	0.15	0.20		2:00A	0.15	0.20						
14 June	7:45P		Began		1:30A	0.10	0.08	13 July	12:45A		Began	13 July	10:38A		Began	13 July	2:00A		0.20		2:15A	0.20	0.20						
	7:50P	0.05	0.60 End		2:00A	0.15	0.10		1:06A	0.02	0.06		1:58A	0.04	0.03		2:15A	0.20	0.20		2:15A	0.20	0.20						
13 July	1:00A		Began	14 June	9:15A		Began	13 July	10:36A		Began	13 July	9:20P		Began	13 July	9:28P		0.00		3:30P	0.10	0.40						
	1:19A	0.02	0.06 End		9:30A	0.05	0.20		10:56A	0.03	0.09		9:40P	0.01	0.03		9:48P	0.01	0.03		10:06P	0.09	0.27						
13 July	10:45A		Began	14 June	3:30P		Began	13 July	9:37P		Began	13 July	10:17P		0.16	0.17	14 June	7:42P		Began	7:42P	0.05	0.60						
	11:42A	0.06	0.06 End		3:40P	0.05	0.30		9:55P	0.04	0.13		10:36P	0.18	0.06		7:47P	0.05	0.60		7:47P	0.05	0.60						
13 July	9:31P		Began	14 June	7:45P		Began	13 July	10:32P		0.15	0.32	18 July	5:27P		Began	18 July	5:40P		Began	12 July	12:01P		Began					
	9:51P	0.03	0.09		7:50P	0.05	0.60		10:32P	0.15	0.06		5:45P	0.03	0.09		5:58P	0.06	0.20		12:19P	0.06	0.20						
	10:07P	0.11	0.29		End				10:51P	0.18	0.09		6:04P	0.09	0.20		6:14P	0.14	0.29		End								
	10:26P	0.15	0.13	12 July	12:00N		Began	18 July	5:40P		Began		6:18P	0.20	0.47	13 July	12:38A		Began	13 July	12:38A		Began						
	10:45P	0.16	0.03		12:18P	0.07	0.23		5:58P	0.03	0.09		6:28P	0.35	0.89		1:00A	0.01	0.03		1:00A	0.01	0.03						
	11:05P	0.20	0.13 End		End				6:14P	0.16	0.51		6:42P	0.46	0.46		1:21A	0.03	0.06		1:21A	0.03	0.06						
18 July	5:41P		Began	13 July	1:07A		Began	19 July	6:37P		1.70	19 July	10:42A		Began	19 July	10:48A		Began	13 July	10:31A		Began						
	5:59P	0.06	0.20		1:26A	0.03	0.08		6:52A	0.52	0.43		11:01A	0.01	0.03		11:08A	0.01	0.03		11:51A	0.02	0.02						
	6:15P	0.13	0.28		End				7:18P	0.56	0.12		11:20A	0.05	0.13		11:26A	0.06	0.17		End								
	6:30P	0.21	0.32	13 July	9:34P		Began	19 July	10:44A		Began		11:40A	0.11	0.18		11:43A	0.13	0.24		13 July	9:30P		Began					
	6:39P	0.37	0.97		9:54P	0.01	0.03		11:24A	0.02	0.03		12:02P	0.19	0.19		12:02P	0.19	0.19		9:48P	0.06	0.20						
	6:55P	0.46	0.34 End		10:09P	0.12	0.45		11:59A	0.16	0.24		12:18P	0.20	0.06		12:21P	0.21	0.06		10:03P	0.16	0.39						
19 July	11:00A		Began	18 July	5:46P		Began	19 July	12:19P		0.20	0.13		12:41P	0.41	1.50		12:41P	0.43	1.14		10:23P	0.16	0.00					
	11:18A	0.03	0.10		6:06P	0.05	0.16		12:41P	0.23	0.08		12:53P	0.53	0.62		1:03P	0.55	0.53		10:42P	0.20	0.12						
	11:36A	0.10	0.24		6:21P	0.16	0.43		12:54P	0.36	0.58		1:11P	0.60	0.23		1:24P	0.63	0.22		End								
	12:13P	0.20	0.15		6:34P	0.30	0.63		1:03P	0.50	0.92		1:29P	0.64	0.13		1:47P	0.65	0.05		18 July	5:53P		Began					
	12:32P	0.22	0.06		6:43P	0.44	0.90		1:21P	0.57	0.23		1:49P	0.67	0.09		2:06P	0.69	0.13		6:12P	0.01	0.03						
	12:48P	0.32	0.40		7:01P	0.48	0.13		2:00P	0.65	0.13		4:09P	0.69	0.01		4:21P	0.71	0.01		6:28P	0.10	0.34						
	12:54P	0.49	1.60		End				2:38P	0.66	0.02		4:28P	0.70	0.03		5:03P	0.72	0.01		6:45P	0.17	0.24						
	1:10P	0.57	0.29		19 July	10:48A		Began	2:58P	0.68	0.06		4:46P	0.74	0.13		5:22P	0.74	0.06		6:54P	0.31	0.88						
	1:30P	0.60	0.09		11:07A	0.01	0.03		3:36P	0.70	0.03		End				End				7:07P	0.43	0.58						
	1:49P	0.65	0.15		11:46A	0.12	0.17		5:18P	0.71	0.01		20 July	7:10P		Began	20 July	7:16P		Began	7:26P	0.46	0.09						
	2:09P	0.67	0.06		12:03P	0.18	0.21		5:31P	0.74	0.09		7:24P	0.10	0.40		7:33P	0.21	1.14		19 July	11:36A		Began					
	2:51P	0.69	0.03		12:21P	0.23	0.17		5:49P	0.78	0.13		7:33P	0.24	1.02		7:40P	0.21	1.14		11:56A	0.05	0.15						
	4:48P	0.70	0.01		12:42P	0.26	0.09		End				7:51P	0.25	0.03		7:56P	0.30	0.34		12:14P	0.11	0.21						
	5:29P	0.76	0.09 End		12:52P	0.40	0.73		20 July	7:18P		Began	8:11P	0.27	0.06		8:15P	0.32	0.06		12:32P	0.16	0.17						
20 July	7:49P		Began		1:01P	0.54	0.90		7:37P	0.02	0.06		8:30P	0.31	0.12		8:35P	0.33	0.03		12:53P	0.19	0.09						
	7:57P	0.11	0.44		1:20P	0.60	0.20		7:47P	0.15	0.78		8:50P	0.34	0.09		8:56P	0.36	0.04		1:11P	0.26	0.24						
	8:15P	0.12	0.03		1:39P	0.64	0.12		8:04P	0.21	0.21		End				End				1:55P	0.41	1.71						
	8:57P	0.18	0.09 End		1:59P	0.67	0.09		8:44P	0.29	0.12		22 July	5:42P		Began	22 July	5:42P		Began	1:55P	0.41	1.71						
17 Aug.	8:51P		Began		2:38P	0.68	0.02		8:59P	0.05	0.16		5:48P	0.16	1.57		6:00P	0.07	0.25		1:29P	0.54	0.61						
	9:12P	0.02	0.06		2:57P	0.70	0.06		9:18P	0.11	0.19		End				6:07P	0.21	1.20		1:47P	0.59	0.17						
	9:31P	0.05	0.09		4:57P	0.72	0.01		9:37P	0.14	0.09		17 Aug.	8:10P		Began	17 Aug.	8:08P		Began	2:25P	0.67	0.13						
	9:51P	0.05	0.00		5:13P	0.74	0.06		9:59P	0.15	0.03		8:28P	0.03	0.09		8:27P	0.01	0.03		4:26P	0.69	0.02						
	10:10P	0.08	0.00 End		5:32P	0.77	0.09		End				8:44P	0.13	0.37		9:26P	0.13	0.12		5:05P	0.71	0.03						
21 Aug.	11:24P		Began	20 July	6:51P		Began	17 Aug.	8:40P		Began		9:04P	0.17	0.12		10:24P	0.13	0.00		5:24P	0.76	0.16						
	11:40P	0.09	0.34		7:31P	0.01	0.01		8:59P	0.05	0.16		9:23P	0.20	0.10		10:54P	0.21	0.16		5:43P	0.77	0.03						
	11:58P	0.15	0.20		7:57P	0.23	0.50		9:18P	0.11																			

Table 3. Continued.

L-1				L-2				L-3				L-4				L-5				L-6				L-7														
Date	Time	Depth	Intensity	Date	Time	Depth	Intensity	Date	Time	Depth	Intensity	Date	Time	Depth	Intensity	Date	Time	Depth	Intensity	Date	Time	Depth	Intensity	Date	Time	Depth	Intensity	Date	Time	Depth	Intensity							
		in.	in./hr			in.	in./hr			in.	in./hr			in.	in./hr			in.	in./hr			in.	in./hr			in.	in./hr			in.	in./hr							
1 Sept.	4:57A		Began	9:15P	0.14	0.16		10:37P	0.10	0.20		1 Sept.	5:40A		Began	1 Sept.	6:04A		Began		9:55P	0.11	0.00															
	5:37A	0.02	0.03	9:34P	0.20	0.19		10:55P	0.10	0.00			6:01A	0.02	0.06	1 Sept.	6:23A	0.06	0.18		10:41P	0.47	0.34															
	5:55A	0.03	0.03	10:15P	0.22	0.03		11:14P	0.15	0.16			6:20A	0.03	0.09		6:44A	0.08	0.06																			
	6:16A	0.05	0.06																		21 Aug.	10:50P		Began														
			End	21 Aug.	11:15P		Began	1 Sept.	3:40A		Began	1 Sept.	9:21A		Began	1 Sept.	9:36A		Began		11:28P	0.02	0.03															
1 Sept.	9:46A		Began	11:35P	0.03	0.09		3:59A	0.01	0.03			9:39A	0.04	0.13	1 Sept.	9:54A	0.05	0.17		11:45P	0.11	0.33															
	10:05A	0.06	0.19	11:53P	0.10	0.24		4:17A	0.04	0.10			9:58A	0.10	0.19		10:11A	0.13	0.29		12:02A	0.17	0.21															
	10:35A	0.20	0.40	12:11A	0.16	0.20							10:31A	0.26	0.29		10:26A	0.22	0.34		12:22A	0.21	0.12															
	10:54A	0.30	0.12	12:30A	0.20	0.13						1 Sept.	6:16A		Began		10:46A	0.27	0.16																			
	11:15A	0.30	0.00									6:35A	0.04	0.13							31 Aug.	10:06P		Began														
	11:35A	0.37	0.21																		10:24P	0.06	0.20															
			End	31 Aug.	9:47P		Began	1 Sept.	8:59A		Began	1 Sept.	3:49P		Began	1 Sept.	4:13P	0.06	0.19		11:03P	0.12	0.09															
			End	10:07P	0.03	0.09		9:37A	0.01	0.02		4:07P	0.07	0.24		5:46P	0.06	0.01			11:23P	0.14	0.06															
1 Sept.	3:28P		Began	10:26P	0.08	0.16		10:13A	0.13	0.20		4:28P	0.09	0.06																								
	4:08P	0.01	0.02	10:49P	0.10	0.05		10:28A	0.22	0.34																												
	4:24P	0.09	0.29	11:10P	0.14	0.12		10:45A	0.30	0.29																												
			End																																			
1 Sept.	10:16P		Began									1 Sept.	10:20P		Began	1 Sept.	10:07P		Began																			
	10:35P	0.04	0.13	1 Sept.	4:07A		Began	1 Sept.	4:06P		Began	1 Sept.	11:39P	0.12	0.09	1 Sept.	10:27P	0.05	0.15		5:53A	0.02	0.01															
	10:56P	0.05	0.03	4:48A	0.02	0.03		4:22P	0.10	0.37		11:58P	0.17	0.16	2 Sept.	10:46P	0.06	0.03		6:37A	0.04	0.03																
	11:14P	0.08	0.10	5:28A	0.04	0.03						12:35A	0.25	0.14	2 Sept.	10:53P	0.16	0.09																				
	11:35P	0.12	0.12	5:48A	0.05	0.03						12:53A	0.30	0.17	2 Sept.	12:29A	0.26	0.18																				
	11:57P	0.15	0.08	6:08A	0.07	0.06						1:33A	0.36	0.09		12:48A	0.30	0.13		1 Sept.	9:30A		Began															
	12:16A	0.19	0.22	6:29A	0.09	0.06		1 Sept.	10:01P		Began	1:53A	0.37	0.03		1:07A	0.33	0.10		9:50A	0.06	0.18																
2 Sept.	12:35A	0.25	0.19									2:14A	0.39	0.06		1:24A	0.39	0.21		10:09A	0.14	0.25																
	1:35A	0.37	0.12									2:33A	0.43	0.13		1:45A	0.41	0.06		10:25A	0.23	0.34																
	1:56A	0.40	0.09	1 Sept.	9:34A		Began					3:10A	0.49	0.10		2:05A	0.42	0.03		10:44A	0.27	0.13																
	2:15A	0.41	0.03	9:52A	0.04	0.13						3:29A	0.54	0.17		2:25A	0.44	0.06																				
	2:37A	0.44	0.08	10:08A	0.12	0.29						3:47A	0.61	0.23		2:44A	0.49	0.16		1 Sept.	4:03P		Began															
	2:59A	0.48	0.11	10:25A	0.22	0.37		2 Sept.	12:16A	0.23	0.19		4:08A	0.66	0.14		3:02A	0.52	0.10		4:21P	0.05	0.17															
	3:19A	0.50	0.06	10:42A	0.30	0.27											3:42A	0.61	0.16																			
	3:37A	0.55	0.17	11:22A	0.32	0.03											3:59A	0.68	0.25		1 Sept.	10:14P		Began														
	4:14A	0.70	0.24									1:33A	0.38	0.09	2 Sept.	4:18A	0.73	0.16		10:53P	0.06	0.09																
	4:36A	0.72	0.06									1:53A	0.40	0.06		5:58A	0.07	0.11		11:53P	0.18	0.12																
	4:56A	0.75	0.09	1 Sept.	3:59P		Began					2:13A	0.42	0.06						12:32A	0.28	0.15																
	6:04A	0.77	0.02	4:17P	0.04	0.13						2:52A	0.48	0.09		5:55A	0.74	0.01		12:51A	0.32	0.13																
	6:23A	0.79	0.06	6:59P	0.06	0.01						3:11A	0.50	0.06						1:30A	0.38	0.06																
			End									4:07A	0.70	0.21						1:50A	0.40	0.06																
			End	1 Sept.	10:08P		Began					4:26A	0.75	0.16						2:10A	0.41	0.03																
8 Sept.	12:10A		Began	10:29P	0.05	0.15						4:45A	0.78	0.09						2:29A	0.43	0.06																
	12:30A	0.03	0.09	11:12P	0.10	0.11						6:40A	0.80	0.01						2:47A	0.48	0.17																
	12:48A	0.08	0.16	11:32P	0.12	0.06															3:07A	0.50	0.06															
	1:06A	0.12	0.13																		3:42A	0.62	0.20															
			End	2 Sept.	12:14A	0.22	0.13														3:59A	0.69	0.25															
			End	12:33A	0.27	0.16		7 Sept.	11:54P		Began									6:05A	0.71	0.01																
8 Sept.	5:14A		Began	1:32A	0.39	0.12		8 Sept.	12:13A	0.02	0.06																											

Table 3. Continued.

L-1				L-2				L-3				L-4				L-5				L-6				L-7															
Date	Time	Depth	Intensity	Date	Time	Depth	Intensity	Date	Time	Depth	Intensity	Date	Time	Depth	Intensity	Date	Time	Depth	Intensity	Date	Time	Depth	Intensity	Date	Time	Depth	Intensity	Date	Time	Depth	Intensity								
		in.	in./hr			in.	in./hr			in.	in./hr			in.	in./hr			in.	in./hr			in.	in./hr			in.	in./hr			in.	in./hr								
23 Sept.	7:15A		Began	11 Sept.	5:56A		Began					11:08A	0.95	0.27		8:05A	0.11	0.23	22 Sept.	9:39P		Began																	
	7:34A	0.04	0.13		6:36A	0.02	0.03		9:04A	0.13	0.06		11:42A	1.07	0.21		8:53A	0.42	0.39		9:59P	0.01	0.03																
	7:51A	0.09	0.17		6:56A	0.05	0.09		9:22A	0.16	0.09		12:01P	1.10	0.10		9:11A	0.48	0.20		10:18P	0.05	0.13																
	8:06A	0.18	0.36		8:09A	0.06	0.01		10:08A	0.17	0.01		1:19P	1.11	0.01		9:30A	0.52	0.13		10:37P	0.08	0.09																
	8:20A	0.30	0.50		8:31A	0.09	0.08		End				End				9:47A	0.57	0.16		End																		
	8:53A	0.48	0.33		9:11A	0.11	0.03		22 Sept.	9:52P		Began	24 Sept.	4:13A		Began		10:26A	0.71	0.23	23 Sept.	7:24A		Began															
	9:10A	0.55	0.25		10:10A	0.13	0.02		10:31P	0.08	0.12		4:34A	0.02	0.06		10:44A	0.80	0.31		7:42A	0.05	0.17																
	9:30A	0.58	0.09		10:30A	0.15	0.06		End				6:52A	0.04	0.01		11:00A	0.87	0.25		7:58A	0.12	0.25																
	10:05A	0.70	0.20		End				23 Sept.	7:16A		Began	24 Sept.	4:05P		Began		11:18A	0.93	0.20		8:48A	0.41	0.35															
	10:56A	0.94	0.29		22 Sept.	9:47P		Began		7:36A	0.02	0.06	24 Sept.	4:23P	0.03	0.09		11:35A	1.01	0.29		9:06A	0.46	0.17															
	11:32A	1.07	0.21		10:08P	0.02	0.06			7:53A	0.09	0.25		4:42P	0.07	0.13		11:56A	1.07	0.17		9:25A	0.49	0.09															
12:12P	1.15	0.12		10:26P	0.08	0.20			8:38A	0.39	0.40		End				12:14P	1.11	0.13		9:43A	0.54	0.17																
			End	10:47P	0.10	0.06			8:56A	0.48	0.32		25 Sept.	1:41A		Began	24 Sept.	4:03A		Began		10:01A	0.60	0.20															
			End						9:14A	0.53	0.16		1:59A	0.04	0.13		6:04A	0.02	0.01		10:18A	0.68	0.28																
24 Sept.	4:19A		Began	23 Sept.	7:18A		Began		10:13A	0.72	0.20		2:18A	0.07	0.10		6:25A	0.03	0.03		10:34A	0.77	0.36																
	5:41A	0.02	0.01		7:37A	0.03	0.09		10:29A	0.81	0.32		3:16A	0.08	0.01		End				10:50A	0.84	0.25																
	6:40A	0.03	0.01		7:55A	0.09	0.20		11:19A	1.02	0.25		End				End				11:26A	0.97	0.21																
	End				8:38A	0.42	0.46		11:38A	1.07	0.17		8 Oct.	8:58A		Began	24 Sept.	3:58P		Began		11:46A	1.02	0.16															
24 Sept.	3:41P		Began		8:53A	0.51	0.36		11:57A	1.11	0.13		End				4:18P	0.03	0.09		12:06P	1.06	0.12																
	4:02P	0.02	0.06		10:08A	0.73	0.18		12:17P	1.14	0.09		9:43A	0.02	0.03		4:37P	0.07	0.13		12:34P	1.07	0.02																
	4:22P	0.04	0.06		10:59A	0.97	0.28		End				10:04A	0.06	0.11		5:14P	0.08	0.02		End																		
	4:40P	0.08	0.13		11:35A	1.09	0.21		24 Sept.	3:57A		Began	12:11P	0.08	0.01		End				24 Sept.	3:44P		Began															
	End				11:54A	1.14	0.17		6:14A	0.02	0.01		1:19P	0.19	0.10		End				4:04P	0.02	0.06																
25 Sept.	1:32A		Began		12:13P	1.18	0.13		End				End				25 Sept.	1:42A		Began	4:22P	0.06	0.13																
	1:32A	0.04	0.12		End				24 Sept.	4:10P		Began	1:19P	0.19	0.10		2:00A	0.04	0.13		End																		
	2:11A	0.07	0.09		24 Sept.	3:55A		Began	4:26P	0.08	0.29		3:01A		Began	9 Oct.	3:01A		Began	2:20A	0.06	0.06																	
	2:30A	0.08	0.03		3:29A	0.02	0.06		4:46P	0.10	0.26		3:29A	0.02	0.04		2:41A	0.08	0.06		2:41A	0.05	0.16																
	2:49A	0.12	0.13		5:40A	0.04	0.01		End				3:50A	0.03	0.03		3:02A	0.09	0.03		2:11A	0.08	0.09																
	End				5:40A	0.05	0.03		End				End				3:37A	0.11	0.03		2:30A	0.10	0.06																
8 Oct.	9:05A		Began		End				25 Sept.	1:28A		Began	23 Oct.	2:16P		Began	8 Oct.	9:26A		Began	2:49A	0.11	0.03																
	9:26A	0.02	0.06		24 Sept.	3:49P		Began	1:46A	0.07	0.23		2:54P	0.10	0.16		10:32A	0.07	0.06		End																		
	9:45A	0.04	0.06		4:28P	0.02	0.03		2:05A	0.12	0.16		3:14P	0.12	0.06		10:52A	0.10	0.09		8 Oct.	8:56A		Began															
	10:23A	0.06	0.03		4:46P	0.06	0.13		2:25A	0.16	0.12		3:33P	0.15	0.09		12:20P	0.13	0.02		9:18A	0.02	0.05																
	10:43A	0.08	0.06		5:05P	0.07	0.03		2:45A	0.19	0.09		3:53P	0.23	0.25		12:47P	0.15	0.04		9:34A	0.04	0.06																
	12:06P	0.09	0.01		End				End				4:11P	0.25	0.06		1:07P	0.17	0.06		10:11A	0.06	0.04																
	12:26P	0.12	0.09		25 Sept.	1:31A		Began	8 Oct.	9:05A		Began	4:31P	0.28	0.09		1:30P	0.20	0.08		10:30A	0.09	0.09																
	12:47P	0.14	0.06		1:52A	0.03	0.09		9:46A	0.04	0.06		5:17P	0.33	0.12		End				12:02P	0.11	0.01																
	1:21P	0.19	0.09		2:10A	0.08	0.16		10:07A	0.06	0.06		5:37P	0.36	0.09		End				12:22P	0.13	0.06																
	End				2:29A	0.10	0.06		10:28A	0.09	0.09		End				23 Oct.	2:24P		Began	12:41P	0.14	0.03																
8 Oct.	8:02P		Began		End				10:47A	0.13	0.13		1 Nov.	4:20A		Began	8 Oct.	2:44P	0.04	0.12	12:41P	0.14	0.03																
	9:56P	0.02	0.01		8 Oct.	9:11A		Began	12:26P	0.15	0.01		4:39A	0.03	0.10		3:04P	0.07	0.09		1:10P	0.20	0.13																
	End				9:56A	0.01	0.01		12:46P	0.17	0.06		5:00A	0.05	0.06		3:24P	0.09	0.06		1:57P	0.22	0.03																
9 Oct.	1:16A		Began		10:14A	0.04	0.1																																

Table 4. Precipitation in Truchek gages, Layton site.

SL-1		SL-2		SL-3		SL-4		SL-5		SL-6	
Date	Amt. (in.)	Date	Amt. (in.)	Date	Amt. (in.)	Date	Amt. (in.)	Date	Amt. (in.)	Date	Amt. (in.)
<u>1972</u>											
20 Sept.		20 Sept.		20 Sept.		20 Sept.		20 Sept.		20 Sept.	
9 Oct.	.75	9 Oct.	.75	9 Oct.	.73	9 Oct.	.75	9 Oct.	.71	9 Oct.	.76
9 Oct.		9 Oct.		9 Oct.		9 Oct.		9 Oct.		9 Oct.	
16 Oct.	.08	16 Oct.	.08	16 Oct.	.07	16 Oct.	.07	16 Oct.	.07	16 Oct.	.08
16 Oct.		16 Oct.		16 Oct.		16 Oct.		16 Oct.		16 Oct.	
23 Oct.	1.30	23 Oct.	1.29	23 Oct.	1.25	23 Oct.	1.30	23 Oct.	1.27	23 Oct.	1.27
23 Oct.		23 Oct.		23 Oct.		23 Oct.		23 Oct.		23 Oct.	
25 Oct.	.40	25 Oct.	.40	25 Oct.	.40	25 Oct.	.40	25 Oct.	.39	25 Oct.	0.40
25 Oct.		25 Oct.		25 Oct.		25 Oct.		25 Oct.		25 Oct.	
30 Oct.	.29	30 Oct.	.30	30 Oct.	.30	30 Oct.	.29	30 Oct.	.22	30 Oct.	.32
<u>1973</u>											
4 Apr.		4 Apr.		4 Apr.		4 Apr.		4 Apr.		4 Apr.	
18 Apr.	.93	18 Apr.	.98	18 Apr.	.95	18 Apr.	1.00	18 Apr.	.94	18 Apr.	.96
18 Apr.		18 Apr.		18 Apr.		18 Apr.		18 Apr.		18 Apr.	
24 Apr.	.10	24 Apr.	.10	24 Apr.	.09	24 Apr.	.10	24 Apr.	.09	24 Apr.	.08
24 Apr.		24 Apr.		24 Apr.		24 Apr.		24 Apr.		24 Apr.	
30 Apr.	.81	30 Apr.	.85	30 Apr.	.74	30 Apr.	.80	30 Apr.	.80	30 Apr.	.84
30 Apr.		30 Apr.		30 Apr.		30 Apr.		30 Apr.		30 Apr.	
9 May	.04	9 May	.04	9 May	.04	9 May	.04	9 May	.04	9 May	.04
15 May		15 May		15 May		15 May		15 May		15 May	
22 May	.09	22 May	.09	22 May	.06	22 May	.09	22 May	.08	22 May	.08
22 May		22 May		22 May		22 May		22 May		22 May	
29 May	1.24	29 May	1.24	29 May	1.24	29 May	1.25	29 May	1.23	29 May	1.24
29 May		29 May		29 May		29 May		29 May		29 May	
4 June	.07	4 June	.07	4 June	.06	4 June	.08	4 June	.08	4 June	.08
12 June		12 June		12 June		12 June		12 June		12 June	
18 June	.34	18 June	.34	18 June	.29	18 June	.34	18 June	.36	18 June	.34
8 July		8 July		8 July		8 July		8 July		8 July	
16 July	.40	16 July	.40	16 July	.38	16 July	.40	16 July	.40	16 July	.40
16 July		16 July		16 July		16 July		16 July		16 July	
23 July	1.75	23 July	1.75	23 July	1.75	23 July	1.77	23 July	1.75	23 July	1.77
13 Aug.		13 Aug.		13 Aug.		13 Aug.		13 Aug.		13 Aug.	
27 Aug.	.20	27 Aug.	.20	27 Aug.	.20	27 Aug.	.19	27 Aug.	.20	27 Aug.	.20
27 Aug.		27 Aug.		27 Aug.		27 Aug.		27 Aug.		27 Aug.	
4 Sept.	1.25	4 Sept.	1.25	4 Sept.	1.26	4 Sept.	1.25	4 Sept.	1.20	4 Sept.	1.27
4 Sept.		4 Sept.		4 Sept.		4 Sept.		4 Sept.		4 Sept.	
10 Sept.	.50	10 Sept.	.48	10 Sept.	.48	10 Sept.	.46	10 Sept.	.46	10 Sept.	.46
10 Sept.		10 Sept.		10 Sept.		10 Sept.		10 Sept.		10 Sept.	
17 Sept.	.11	17 Sept.	.10	17 Sept.	.10	17 Sept.	.09	17 Sept.	.10	17 Sept.	.09
17 Sept.		17 Sept.		17 Sept.		17 Sept.		17 Sept.		17 Sept.	
24 Sept.	1.15	24 Sept.	1.20	24 Sept.	1.25	24 Sept.	1.25	24 Sept.	1.20	24 Sept.	1.20
24 Sept.		24 Sept.		24 Sept.		24 Sept.		24 Sept.		24 Sept.	
1 Oct.	.15	1 Oct.	.13	1 Oct.	.12	1 Oct.	.12	1 Oct.	.12	1 Oct.	.11
1 Oct.		1 Oct.		1 Oct.		1 Oct.		1 Oct.		1 Oct.	
9 Oct.	.24	9 Oct.	.24	9 Oct.	.22	9 Oct.	.25	9 Oct.	.25	9 Oct.	.24
23 Oct.		23 Oct.		23 Oct.		23 Oct.		23 Oct.		23 Oct.	
29 Oct.	.32	29 Oct.	.30	29 Oct.	.32	29 Oct.	.32	29 Oct.	.30	29 Oct.	.30
29 Oct.		29 Oct.		29 Oct.		29 Oct.		29 Oct.		29 Oct.	
4 Nov.	.38	4 Nov.	.42	4 Nov.	.44	4 Nov.	.42	4 Nov.	.38	4 Nov.	.38
4 Nov.		4 Nov.		4 Nov.		4 Nov.		4 Nov.		4 Nov.	
19 Nov.	1.25	19 Nov.	1.28	19 Nov.	1.28	19 Nov.	1.25	19 Nov.	1.23	19 Nov.	1.27
19 Nov.		19 Nov.		19 Nov.		19 Nov.		19 Nov.		19 Nov.	
26 Nov.	Snow	26 Nov.	Snow	26 Nov.	Snow	26 Nov.	Snow	26 Nov.	Snow	26 Nov.	Molested
26 Nov.		26 Nov.		26 Nov.		26 Nov.		26 Nov.		26 Nov.	
10 Dec.	1.20	10 Dec.	1.15	10 Dec.	1.10	10 Dec.	1.15	10 Dec.	.95	10 Dec.	

Table 5. Hydrograph information, Layton site LW-1.

Date	Time	Discharge (cfs)	Notes	Date	Time	Discharge (cfs)	Notes	Date	Time	Discharge (cfs)	Notes	Date	Time	Discharge (cfs)	Notes	
<u>1972</u>				<u>1972</u>				<u>1972</u>				<u>1973</u>				
5 Sept.	5:28P	0.0	Began	9 Oct.	2:46A	0.0002		23 Oct.	10:21P	0.0105		17 April	9:27A	0.124		
	5:30P	0.006		cont.	2:50A	0	End	cont.	10:34P	0.029		cont.	9:34A	0.115		
	5:35P	0.012							10:42P	0.032			9:40A	0.090		
	5:38P	0.025		20 Oct.	3:16A	0	Began		10:52P	0.042			9:46A	0.073		
	5:42P	0.027			3:23A	0.00002			11:20P	0.014			9:52A	0.060		
	5:44P	0.028			3:36A	0.0001			11:50P	0.003			9:59A	0.047		
	5:48P	0.028			3:53A	0.0001							10:06A	0.039		
	6:01P	0.014			4:00A	0.0004			24 Oct.	12:20A	0.0006		10:14A	0.032		
	6:10P	0.002			4:06A	0.001			1:00A	0.00002			10:22A	0.025		
	6:15P	0.001			4:13A	0.003			1:40A	0	End		10:29A	0.018		
	6:29P	0.0001			4:24A	0.007					Began		10:37A	0.014		
	6:56P	0.00001			4:36A	0.008			28 Oct.	9:50P	0		10:44A	0.010		
	9:40P	0	End		4:51A	0.008				9:56P	0.0001		10:51A	0.007		
19 Sept.	2:08A	0	Began		5:06A	0.013				10:16P	0.0001		10:58A	0.005		
	2:13A	0.002			5:26A	0.016				10:25P	0.0003		11:07A	0.003		
	2:21A	0.007			5:32A	0.018				10:48P	0.0015		11:15A	0.003		
	2:27A	0.010			5:45A	0.017				11:07P	0.0015		11:20A	0.002		
	2:36A	0.011			6:00A	0.022			29 Oct.	12:07A	0.0001		11:31A	0.002		
	2:36A	0.011			6:08A	0.023				12:44A	0.0001		11:41A	0.001		
	3:06A	0.011			6:26A	0.042				1:10A	0.00002		11:52A	0	End	
	3:38A	0.004			6:49A	0.034				1:12A	0	End			Began	
	3:44A	0.003			7:51A	0.009			4-5 Nov.	No time	0.007	Peak	17 April	12:42P	0	
	4:02A	0.002			8:03A	0.007			<u>1973</u>				12:44P	0.004		
	4:10A	0	End		8:48A	0.0003			17 April	8:22A	0	Began	12:46P	0.016		
5 Oct.	7:56A	0	Began		9:02A	0.0001				8:23A	0.0003		12:47P	0.027		
	7:59A	0.004			9:38A	0.00005				8:25A	0.002		12:50P	0.041		
	8:03A	0.007			10:00A	0	End			8:29A	0.004		12:52P	0.060		
	8:12A	0.012		20 Oct.	4:16P	0	Began			8:37A	0.007		12:55P	0.079		
	8:38A	0.012			4:21P	0.0002				8:44A	0.007		12:59P	0.100		
	8:45A	0.010			4:34P	0.003				8:52A	0.008		1:07P	0.115		
	9:16A	0.003			4:40P	0.004				8:56A	0.015		1:14P	0.092		
	9:44A	0.001			4:49P	0.004				8:58A	0.025		1:20P	0.075		
	10:00A	0	End		5:36P	0.0005				8:59A	0.039		1:26P	0.061		
9 Oct.	1:55A	0	Began		6:20P	0.0001				9:02A	0.058		1:32P	0.044		
	2:00A	0.0001			6:52P	0	End			9:04A	0.078		1:38P	0.039		
	2:04A	0.0007		23 Oct.	9:52P	0	Began			9:08A	0.107		1:45P	0.032		
	2:07A	0.0008			9:58P	0.0001				9:13A	0.127		1:52P	0.026		
	2:30A	0.0009			10:03P	0.0018				9:20A	0.143		1:58P	0.012		
	2:42A	0.0005			10:10P	0.0032							2:05P	0.016		

Table 5. Continued.

Date	Time	Discharge (cfs)	Notes	Date	Time	Discharge (cfs)	Notes	Date	Time	Discharge (cfs)	Notes	Date	Time	Discharge (cfs)	Notes	
<u>1973</u>				<u>1973</u>				<u>1973</u>				<u>1973</u>				
17 April	2:13P	0.012		29 April	10:03A	0.035		25 May	7:40A	0.00001		25 May	8:38P	0.041		
cont.	2:21P	0.009		cont.	10:10A	0.029		cont.	7:53A	0	End	cont.	8:44P	0.034		
	2:28P	0.007			10:17A	0.022							8:52P	0.027		
	2:37P	0.006			10:24A	0.017		25 May	10:03A	0	Began		8:58P	0.019		
	2:52P	0.005			10:32A	0.014			10:10A	0.0001			9:05P	0.068		
	2:53P	0.004			10:40A	0.014			10:14A	0.0045			9:12P	0.011		
	3:02P	0.003			11:02A	0.027			10:23A	0.0343			9:19P	0.008		
	3:10P	0.003			11:10A	0.031			10:26A	0.048			9:26P	0.006		
	3:17P	0.002			11:34A	0.028			10:31A	0.066			9:35P	0.005		
	3:25P	0.002			11:42A	0.026			10:38A	0.075			9:43P	0.002		
	3:35P	0.002			11:50A	0.022			10:46A	0.076			9:51P	0.002		
	3:49P	0.001			11:58A	0.016			10:55A	0.067			9:59P	0.001		
	3:58P	0	End		12:05P	0.010			11:01A	0.054			10:07P	0.001		
28 April	5:38P	0	Began		12:12P	0.009			11:07A	0.040			10:14P	0.0002		
	5:41P	0.002			12:19P	0.004			11:13A	0.031			10:22P	0.0001		
	5:47P	0.004			12:27P	0.003			11:20A	0.023			10:38P	0.0		
	5:55P	0.004			12:35P	0.003			11:28A	0.018			11:10P	0.0		
	6:02P	0.003			12:43P	0.002			11:35A	0.015			11:36P	0.00	End	
	6:10P	0.002			12:50P	0.002			11:43A	0.012			11:44P	0.0		
	6:18P	0.002			12:59P	0.002			12:24P	0.011					Began	
	6:25P	0.001			1:07P	0.001			12:32P	0.010		26 May	12:04A	0		
	6:33P	0.001			1:15P	0.001			12:41P	0.0078			12:12A	0.0062		
	6:40P	0.0001			1:22P	0.0006			12:49P	0.007			12:26A	0.0304		
	6:48P	0.0001			1:30P	0.0005			12:58P	0.007			12:34A	0.034		
	6:55P	0.0001			1:38P	0.0003			1:05P	0.003			12:41A	0.040		
	7:11P	0.0001			1:50P	0.0002			1:13P	0.002			12:49A	0.041		
	7:43P	0.0001			1:58P	0.0002			1:20P	0.001			12:57A	0.049		
	7:51P	0	End		2:05P	0.0001			1:28P	0.001			1:04A	0.049		
29 April	8:46A	0	Began		2:21P	0	End		1:37P	0.0003			1:12A	0.041		
	8:53A	0.0003		25 May	5:53A	0	Began		1:45P	0.00001			1:20A	0.038		
	9:01A	0.0005			5:55A	0.0001			2:43P	0	End		1:26A	0.031		
	9:07A	0.002			5:58A	0.0001			25 May	7:52P	0	Began		1:34A	0.025	
	9:20A	0.007			6:05A	0.0002				7:53P	0.0034			1:42A	0.019	
	9:28A	0.020			6:29A	0.0002				7:55P	0.030			1:49A	0.015	
	9:34A	0.030			6:45A	0.0001				7:57P	0.044			1:56A	0.012	
	9:41A	0.034			7:01A	0.0001				7:59P	0.064			2:04A	0.009	
	9:48A	0.038			7:24A	0.0001				8:05P	0.079			2:11A	0.006	
	9:56A	0.038			7:32A	0.0001				8:20P	0.085			2:21A	0.005	
										8:26P	0.068			2:29A	0.004	
										8:32P	0.058			2:37A	0.003	

Table 5. Continued.

Date	Time	Discharge (cfs)	Notes	Date	Time	Discharge (cfs)	Notes	Date	Time	Discharge (cfs)	Notes	Date	Time	Discharge (cfs)	Notes	
1973				1973				1973				1973				
26 May	2:45A	0.002		19 July	2:03P	0.086		2 Sept.	4:14A	0.020		23 Sept.	9:14A	0	Began	
cont.	2:53A	0.002		cont.	2:10P	0.070		cont.	4:22A	0.022			9:17A	0.002		
	3:02A	0.001			2:17P	0.061			4:29A	0.026			9:28A	0.007		
	3:18A	0.001			2:24P	0.050			4:34A	0.034			9:32A	0.014		
	3:26A	0.0004			2:32P	0.041			4:42A	0.041			9:40A	0.016		
	3:56A	0.0001			2:40P	0.034			4:49A	0.043			9:47A	0.020		
	4:29A	0	End		2:47P	0.026			4:56A	0.058			9:55A	0.024		
18 July	6:46P	0	Began		2:54P	0.022			5:02A	0.055			10:02A	0.027		
	6:47P	0.0004			3:01P	0.016			5:10A	0.077			10:25A	0.026		
	6:49P	0.007			3:08P	0.012			5:19A	0.075			10:32A	0.021		
	6:50P	0.024			3:17P	0.008			5:26A	0.069			11:04A	0.023		
	6:53P	0.036			3:24P	0.007			5:32A	0.058			11:11A	0.026		
	7:03P	0.036			3:32P	0.005			5:39A	0.044			11:18A	0.031		
	7:10P	0.027			3:45P	0.003			5:46A	0.041			11:25A	0.036		
	7:15P	0.019			3:53P	0.003			5:54A	0.034			11:32A	0.042		
	7:19P	0.011			4:01P	0.002			6:01A	0.027			11:40A	0.043		
	7:25P	0.008			4:23P	0.001			6:07A	0.019			12:00N	0.044		
	7:32P	0.005			4:32P	0.001			6:13A	0.014			12:31P	0.044		
	7:39P	0.032			4:40P	0.001			6:20A	0.011			12:40P	0.043		
	7:46P	0.002			5:01P	0.0006			6:27A	0.008			12:47P	0.040		
	7:53P	0	End		5:58P	0.0005			6:36A	0.006			12:54P	0.036		
19 July	12:13P	0	Began		6:05P	0.0001			6:44A	0.005			1:03P	0.031		
	12:19P	0.0013			6:33P	0	End		6:52A	0.004			1:11P	0.026		
	12:22P	0.0056							7:02A	0.003			1:19P	0.022		
	12:26P	0.0086		2 Sept.	12:41A	0	Began		7:17A	0.002			1:26P	0.018		
	12:33P	0.013			1:02A	0.014			7:25A	0.002			1:36P	0.014		
	12:57P	0.013			1:10A	0.017			7:42A	0.001			1:45P	0.012		
	1:04P	0.019			1:15A	0.025			7:53A	0	End		1:50P	0.009		
	1:07P	0.031			1:22A	0.029							1:58P	0.007		
	1:12P	0.097			2:38A	0.030			8 Sept.	12:33A	0	Began		2:05P	0.004	
	1:13P	0.127			2:46A	0.026				12:38A	0.001			2:12P	0.002	
	1:14P	0.165			2:54A	0.022				12:44A	0.003			2:20P	0.0016	
	1:16P	0.210			3:02A	0.020				1:15A	0.002			2:27P	0.0011	
	1:21P	0.240			3:09A	0.016				1:23A	0.002			2:35P	0.0008	
	1:29P	0.240			3:17A	0.016				1:31A	0.001			2:45P	0.0005	
	1:36P	0.215			3:27A	0.014				2:10A	0.001			2:52P	0.0003	
	1:41P	0.175			3:43A	0.014				5:20A	0.0001			3:00P	0.0002	
	1:45P	0.150			3:51A	0.018				6:25A	0.001			3:12P	0.0001	
	1:51P	0.127			3:59A	0.019				6:42A	0.001			3:20P	0.00002	
	1:57P	0.100								7:41A	0.0002			3:41P	0.00001	
										9:00A	0	End				

Table 5. Continued.

Date	Time	Discharge (cfs)	Notes	Date	Time	Discharge (cfs)	Notes
1973				1973			
23 Sept.	3:53P	0.00001		18 Nov.	11:15A	0.011	
cont.	4:03P	0.00001		cont.	12:09P	0.004	
	4:21P	0.0	End		12:40P	0.003	
18 Nov.	7:40A	0	Began		1:12P	0.003	
	7:43A	0.0012			1:17P	0.004	
	7:52A	0.0018			1:30P	0.004	
	8:04A	0.0018			1:40P	0.004	
	8:24A	0.0080			1:54P	0.004	
	8:30A	0.0088			2:32P	0.0018	
	9:16A	0.090			2:36P	0.0011	
	9:43A	0.090			3:58P	0.0003	
	10:14A	0.019			4:33P	0.0001	
	10:49A	0.013			4:41P	0.00001	
					5:54P	0	End

Table 6. Minimum and maximum temperature during runoff, Layton site.

Date	Runoff Time		Temperature (°F)	
	Start	End	Max.	Min.
1972				
5 Sept.	5:28P	9:40P	71	60
19 Sept.	2:08A	4:10A	65	46
5 Oct.	7:56A	10:00A	46	44
9 Oct.	1:55A	2:50A	52	44
20 Oct.	3:16A	10:00A	44	38
20 Oct.	4:16P	6:52P	54	41
23-24 Oct.	9:52P	1:40A	57	27
28-29 Oct.	9:50P	1:12A	29	29
4-5 Nov.	-	-		
1973				
17 April	8:22A	11:52A	NR*	NR
17 April	12:42P	3:58P	NR	NR
28 April	5:38P	7:51P	NR	NR
29 April	8:46A	2:21P	60	54
25 May	5:53A	7:53A	59	57
25 May	10:03A	2:43P	61	56
25 May	7:52P	11:44P	52	51
26 May	12:04A	4:29A	50	48
18 July	6:46P	7:53P	76	68
19 July	12:13P	6:33P	74	68
2 Sept.	12:41A	7:53A	32	29
8 Sept.	12:33A	9:00A	39	35
23 Sept.	9:14A	4:21P	50	32
18 Nov.	7:40A	5:54P	46	28

Note: *NR = no record

Table 7. Layton site minimum and maximum winds and direction during runoff events.

Date	Runoff Time		Wind		
	Begin	End	Speed (miles/hr)		Direction
			Max.	Min.	
1972					
5 Sept.	5:28P	9:40P	7	1	NE
19 Sept.	2:08A	4:10A	NR ^a	NR	NR
5 Oct.	7:56A	10:00A	3	0	NE
9 Oct.	1:55A	2:50A	2	0	S
20 Oct.	3:16A	10:00A	3	0	W
20 Oct.	4:16P	6:52P	5	2	E
23-24 Oct.	9:52P	1:40A	3	0	E
28-29 Oct.	9:50P	1:12A	10	3	NNE
4-5 Nov.	-	-	7	0	NNE
1973					
17 April	8:22A	11:52A	5	2	N
17 April	12:42P	3:58P	5	3	N
28 April	5:38P	7:51P	NR	NR	NR
29 April	8:46A	2:21P	NR	NR	NR
25 May	5:53A	7:53A	2	0	NE
25 May	10:03A	2:43P	2	0	NE
25 May	7:52P	11:44P	3	2	S
26 May	12:04A	4:29A	3	0	E
18 July	6:46P	7:53P	32	5	SSW
19 July	12:13P	6:33P	10	0	NW
2 Sept.	12:41A	7:53A	10	2	SW
8 Sept.	12:33A	9:00A	NR	NR	NR
23 Sept.	9:14A	4:21P	17	0	NW
18 Nov.	7:40A	5:54P	10	0	S to NE

Note: ^a NR = no record

Table 8. Soil moisture levels at the beginning of each runoff event, Layton site.

Date	Soil Moisture Content (%) at depth		
	0-6"	6-12"	12-24"
1973			
18 July	4.89	2.20	5.15
19 July	16.93	10.58	7.45
2 Sept.	9.39	7.86	11.35
8 Sept.	16.94	15.49	13.46
23 Sept.	10.97	6.67	8.60
18 Nov.	14.78	11.84	10.61

Runoff data

Runoff was measured at two locations on the Parleys site. The first PW-1 flume measures only the

runoff from the east sideslope of I-215 plus that derived from traffic splash from the north bound east traffic lane. The second location PW-2 flume measures only the runoff from the north bound traffic lanes remaining after traffic splash.

The dates, times of beginning, times of flow beginning, rate changes, flow rates, and end of runoff for PW-1 flume are given in Table 11. The same data for PW-2 flume are given in Table 12.

Temperature data

The maximum and minimum temperatures observed during all of the runoff events with the dates and times of these events are given in °F in Table 13 for the Parleys site.

Wind data

Wind at the Parleys site was measured in the median near PW-2 flume in contrast to the location on the Layton site which was on the east cut slope.

The maximum and minimum speed and direction of wind that occurred during the 1972 and 1973 runoff events are shown in Table 14 for the Parleys site.

Soil moisture data

The soil at the Parleys site is so highly variable that considerable noise exists in the soil moisture data. The soil moisture data in 1973 are tabulated in Table 15 at the beginning of each of the runoff events. Soil moisture measurements were not conducted in 1972 because of delay in installation of soil moisture blocks.

Table 9. Continued.

P-1				P-2				P-3				P-4				P-5				P-6				P-7																			
Date	Time	Depth	Intensity	Date	Time	Depth	Intensity	Date	Time	Depth	Intensity	Date	Time	Depth	Intensity	Date	Time	Depth	Intensity	Date	Time	Depth	Intensity	Date	Time	Depth	Intensity	Date	Time	Depth	Intensity												
13 Oct.	10:00A		Began	14 Oct.	5:50P		Began	18 Oct.	10:05A		Began	10 Oct.	3:15A		Began	6 Nov.	4:45P	0.54	0.05					23 Oct.	10:10P		Began	25 May	7:30A	0.65	End												
	10:30A	0.02	End		7:00P	0.06	End		10:17A	0.04	0.20		6:00A	0.14	End		12:00M	0.60	0.01Snow						10:55P	0.20	End		9:30A	0.10	Began												
14 Oct.	5:50P		Began	15 Oct.	8:25P		Began	18 Oct.	10:30A	0.10	0.28	13 Oct.	9:55A		Began	17 April	8:00A		Began	24 Oct.	11:30P	0.40	End	25 May	11:30A		Began		10:45A		End		10:00P	0.70	End								
	7:00P	0.06	End		9:30P	0.09	End		4:00P	0.10	0.00		10:15A	0.07	End		8:00P	0.05	End		11:45P	0.45	End		11:00P		End		11:30A		Began												
15 Oct.	8:25P		Began	18 Oct.	10:17A		Began	19 Oct.	8:42P	0.16	<0.01	14 Oct.	6:25P		Began	17 April	8:15A	0.03	0.12	24 Oct.	1:15A	0.60	End	25 May	11:30A		Began		10:00P		End		10:00P		End								
	9:30P	0.09	End		10:30A	0.05	0.23		9:22P	0.20	0.09		8:00P	0.05	End		8:30A	0.05	0.08	29 Oct. -30 Oct.	0.30	Snow	26 May	2:00A		Began		2:15A	0.05	End		2:00A		Began									
18 Oct.	10:10A		Began		10:38A	0.10	0.38		1:30A	0.28	0.16	18 Oct.	10:18A		Began		5 Nov.	1:00A	Began		5:00P	0.95	End	26 May	2:15A	0.05	End		3:45A		Began		4:00A	0.05	End								
	10:40A	0.09	0.18		10:45A	0.11	0.09		1:30A	0.28	0.16		10:40A	0.02	0.05		5 Nov.	5:00P	0.95	End		3:45A		Began		4:00A	0.05	End		3:45A		Began		4:00A	0.05	End							
	4:10P	0.12	<0.01		4:15P	0.14	<0.01		3:15A	0.38	0.06		10:52A	0.08	0.30	17 April	2:00P		Began		2:15P	0.05	0.20		3:00P	0.10	0.07		3:00P	0.10	0.07		3:00P	0.10	0.07		3:00P	0.10	0.07				
	8:25P	0.17	<0.01		8:45P	0.19	0.01		4:45A	0.56	0.12		11:10A	0.10	0.07		2:15P	0.05	0.20		3:00P	0.10	0.07		3:00P	0.10	0.07		3:00P	0.10	0.07		3:00P	0.10	0.07								
	9:40P	0.24	0.06		9:40P	0.24	0.06		5:50A	0.75	0.18		End		End		3:00P	0.10	0.07		3:00P	0.10	0.07		3:00P	0.10	0.07		3:00P	0.10	0.07		3:00P	0.10	0.07								
19 Oct.	1:30A	0.28	<0.01	19 Oct.	1:33A	0.28	0.01		7:00A	0.84	0.08		End		End		6:00P	0.15	0.01	14 April	10:00A		Began	1 June	5:00P		Began		6:00P		End		6:00P		End		6:00P		End				
	1:55A	0.34	0.14		3:44A	0.44	0.07		End		End		End		End		7:45P	0.20	0.03		10:15A	0.05	0.20		6:00P	0.30	Began		6:00P		End		6:00P		End								
	3:30A	0.42	0.05		6:05A	0.77	0.05	23 Oct.	10:00P		Began	18 Oct.	4:27P		Began		End		End		End		End		End		End		End		End		End		End								
	5:00A	0.61	0.13		7:17A	0.87	0.09		10:30P	0.07	0.14	18 Oct.	7:30P		Began	19 April	8:30A		Began	14 April	3:15P		Began	14 June	1:00A	0.10	End		1:00A	0.10	End		1:00A	0.10	End		1:00A	0.10	End		1:00A	0.10	End
	7:00A	0.85	0.12		End		End		10:50P	0.14	0.21		9:05P	0.02	0.01		12:00N	0.05	0.01		3:30P	0.05	0.20	14 June	6:00A		Began		6:00A		Began		6:00A		Began		6:00A		Began				
	End		End	23 Oct.	10:10P		Began		11:20P	0.29	0.30		9:55P	0.12	0.12		End		End		End		End		6:15A	0.05	End		6:15A	0.05	End		6:15A	0.05	End		6:15A	0.05	End				
23 Oct.	10:10P		Began		10:25P	0.05	0.20		11:30P	0.36	0.42		11:03P	0.15	0.03		End		End		End		End		6:15A	0.05	End		6:15A	0.05	End		6:15A	0.05	End								
	11:05P	0.18	0.20		10:58P	0.16	0.21		11:45P	0.43	0.28		11:03P	0.15	0.03		End		End		End		End		6:15A	0.05	End		6:15A	0.05	End		6:15A	0.05	End								
	11:35P	0.38	0.40		11:27P	0.26	0.20		12:30A	0.47	0.05	19 Oct.	1:43A	0.15	0.00	19 April	3:45P		Began	17 April	8:30A		Began	13 July	10:58A		Began		10:58A		Began		10:58A		Began		10:58A		Began				
	11:55P	0.47	0.27		11:40P	0.37	0.51	24 Oct.	12:55A	0.54	0.17		2:05A	0.22	0.19		4:00P	0.03	0.12		8:45A	0.05	0.20		12:05P		End		12:05P		End		12:05P		End		12:05P		End				
	12:53A	0.54	0.07		11:55P	0.44	0.28		1:37A	0.59	0.06		2:50A	0.25	0.04		End		End		End		End		8:21P		Began		8:21P		Began		8:21P		Began								
	2:55A	0.65	0.05	24 Oct.	12:35A	0.46	0.03		4:41A	0.65	0.02		3:20A	0.29	0.08	20 April	9:00A		Began	17 April	2:10P		Began		9:37P		End		9:37P		End		9:37P		End								
	End		End		1:00A	0.52	0.14		End		End		4:02A	0.33	0.06		10:00A	0.12	0.12		2:15P	0.05	0.60	18 July	5:58P		Began		5:58P		Began		5:58P		Began								
25 Oct. to	11:46A		Began		3:30A	0.60	0.03	25 Oct.	Clock		Began		4:02A	0.33	0.06	28 April	9:15P		Began		2:43P	0.10	0.00	19 July	11:37A		Began		11:37A		Began		11:37A		Began								
30 Oct.	2:19P	0.19	End(Snow)		End		End	30 Oct.	stopped	0.45	End		5:20A	0.52	0.15		11:30P	0.05	0.02		2:45P	0.15	1.50		1:34P	0.72	End		1:34P	0.72	End		1:34P	0.72	End								
5 Nov.	12:40A		Began	28 Oct.	9:30P		Began	5 Nov.	12:28A		Began		7:12A	0.70	0.11	28 April	9:15P		Began		3:00P	0.15	0.00	19 July	11:37A		Began		11:37A		Began		11:37A		Began								
	3:05A	0.24	0.10		10:10P	0.05	End		2:00A	0.15	0.10	23 Oct.	10:05P		Began		3:00P	0.15	0.00		3:00P	0.15	0.00		3:00P	0.15	0.00		3:00P	0.15	0.00		3:00P	0.15	0.00								
	4:50A	0.43	0.11		5:00P		Began		5:25A	0.54	0.11		10:25P	0.05	0.15	29 April	11:45A		Began		4:00P	0.20	0.05	22 July	6:08P		Began		6:08P		Began		6:08P		Began								
	6:10A	0.52	0.07	29 Oct.	6:45P	0.15	End		7:45A	0.60	0.03		11:20P	0.27	0.34		2:00P	0.05	0.03		6:00P	0.25	0.02		7:23P	0.30	0.05		7:23P	0.30	0.05		7:23P	0.30	0.05								
	11:50A	0.65	0.02		End		End		11:20A	0.66	0.02		11:40P	0.38	0.33		2:30P	0.15	0.10		7:00P	0.30	0.05		7:00P	0.30	0.05		7:00P	0.30	0.05												
	3:55P	0.87	0.05	30 Oct.	11:40A		Began		4:05P	0.95	0.06	24 Oct.	12:40A	0.50	0.12		3:00P	0.20	0.10	19 April	8:30A		Began		7:45P	0.20	0.03		7:45P	0.20	0.03		7:45P	0.20	0.03								
	End		End		1:15A	0.06	End		End		End		2:12A	0.63	0.08		3:20P	0.30	0.30		9:00A	0.10	0.20		9:00A	0.10	0.20		9:00A	0.10	0.20												
1973				5 Nov.	12:45A		Began	1973					End		End		End		End		End		End		End		End		End		End												
14 April	10:00A		Began		2:00A	0.06	0.05	19 April	8:35A		Began	28 Oct.	9:30P		Began	15 May - 22 May	Clock	stopped	20 April	8:45A		Began		10:00P		End		10:00P		End		10:00P		End									
	10:15A	0.05	0.20		4:45A	0.37	0.11		9:00A	0.05	0.12		11:30P	0.08	End		End		End		9:00A	0.02	0.08		12:30A	0.15	Began		12:30A	0.15	Began												
	3:15P	0.10	0.01		6:40A	0.49	0.06		9:30A	0.10	0.10		End		End	25 May	4:20A		Began		9:30A	0.05	0.06		31 Aug.	10:00P		Began		10:00P		End											
	End		End		12:55P	0.72	0.03		End		End	29 Oct.	2:30P		Began		10:00A	0.10	0.10		10:00A	0.10	0.10		1 Sept.	12:00M	0.21	End		12:00M	0.21	End											
17 April	8:00A		Began		4:05P	0.87	0.04	20 April	8:35A		Began	29 Oct.	7:25P	0.16	End	25 May	4:30A	0.05	0.30		End		End		End		End		End		End												
	8:30A	0.05	0.10		End		End		9:00A	0.03	0.07		End		End		5:05A	0.10	0.10		End		End		End		End		End		End												
	8:45A	0.07	0.08		End		End		9:15A	0.05	0.08	5 Nov.	12:15A		Began		7:30A	0.23	0.10		End		End		End		End		End		End												
	2:00P	0.07	0.00		End		End		9:45A	0.10	0.10		4:30P		End		8:25A	0.35	0.11	28 April	9:15P		Began		8:30A		Began		8:30A		Began												
	2:15P	0.10	0.12		End		End		10:00A	0.15	0.20		End		End		11:25A	0.45	0.03		9:30P	0.10	0.40	1 Sept.	11:30A		Began		11:30A		Began												
	2:30P	0.15	0.20		End		End		End		End	14 April	10:00A		Began		1:00P	0.48	0.01		10:30P	0.10	0.00		1:40P	0.11	End		1:40P	0.11	End												
	2:45P	0.20	0.20		End		End		End		End		10:05A	0.05	0.60		1:05P	0.53</																									

Table 9. Continued.

P-1				P-2				P-3				P-4				P-5				P-6				P-7					
Date	Time	Depth	Intensity	Date	Time	Depth	Intensity	Date	Time	Depth	Intensity	Date	Time	Depth	Intensity	Date	Time	Depth	Intensity	Date	Time	Depth	Intensity	Date	Time	Depth	Intensity		
	10:45A	0.25	0.01		9:30A	0.05	0.10	19 May	1:07P		Began		9:20A	0.10	0.24	18 July	6:04P		Began				End				4:00P	0.10	End
	11:20A	0.30	0.09		10:00A	0.10	0.10		1:25P	0.05	0.18				End		6:23P	0.02	0.06	25 May	10:15A		Began	4 Nov.	12:00N		Began		
	12:30P	0.35	0.04				End				End	20 April	9:00A		Began		7:28P	0.11	0.08		10:30A	0.05	0.20		2:00P	0.35	End		
	1:00P	0.40	0.10	28 April	10:30P		Began	20 May	4:15P		Began	20 April	9:15A	0.05	0.20		8:07P	0.12	0.02		11:20A	0.05	0.00		2:00P		Began		
	1:45P	0.50	0.12		10:45P	0.03	0.12		4:20P	0.10	1.20		9:30A	0.06	0.04		8:28P	0.14	0.06		11:30A	0.10	0.30	12 Nov.	2:00P		Began		
	2:10P	0.55	0.11		11:00P	0.08	0.20				End		9:45A	0.10	0.16		8:47P	0.18	0.13		12:15P	0.10	0.00		5:00P	0.40	End		
	2:20P	0.60	0.30				End	20 May	6:25P		Began		10:00A	0.12	0.08				End		12:20P	0.25	1.80	18 Nov.	7:50A		Began		
	2:40P	0.64	0.12				End		6:32P	0.05	0.45				End	19 July	11:56A		Began		1:15P	0.30	0.05		4:00P		End		
19 May	1:15P		Began	29 April	10:45A		Began				End	28 April	9:15P		Began		12:10P	0.12	0.52		1:45P	0.35	0.10		12:00N		Began		
	1:45P	0.05	0.10		11:00A	0.05	0.20				End	25 May	4:00A		Began		12:14P	0.28	2.48		2:45P	0.40	0.05	18 Nov.	3:00P		Began		
	2:30P	0.10	0.07		11:15A	0.10	0.20		4:05A	0.05	0.60		9:25P	0.05	0.30		12:23P	0.42	0.97		4:45P	0.40	0.00	19 Nov.	10:00P	0.55	End		
			End	29 April	12:30P		Began		4:15A	0.10	0.30		9:30P	0.07	0.24		12:37P	0.53	0.47		5:00P	0.45	0.20		4:00P		End		
20 May	4:45P		Began		12:45P	0.05	0.20		4:25A	0.15	0.30		9:45P	0.09	0.08		1:25P	0.81	0.35	25 May	8:00P		Began	21 Nov.	2:30P		Began		
	4:50P	0.07	0.84		1:00P	0.10	0.20		5:00A	0.20	0.10		10:45P	0.10	0.01				End		8:10P	0.05	0.30		4:00P		End		
			End		1:15P	0.12	0.08		5:20A	0.25	0.15		11:15P	0.15	0.10		22 July	2:34P		Began		8:30P	0.10	0.15		4:00P		End	
20 May	7:00P	0.07	Began		1:30P	0.15	0.12		5:35A	0.30	0.20	29 April	10:45A		Began		5:12P	0.39	0.15		8:35P	0.15	0.60	22 Nov.	11:30A		Began		
	7:05P	0.10	0.36		1:45P	0.20	0.20		5:50A	0.35	0.20		11:00A	0.10	0.40		5:11P	0.40	0.02		8:45P	0.20	0.30		3:00P		End		
			End		2:15P	0.25	0.10		6:15A	0.40	0.12		11:45A	0.15	0.07		6:11P	0.42	0.06		9:00P	0.25	0.20		2:00P		Began		
25 May	4:15A		Began		2:30P	0.30	0.20		6:30A	0.45	0.20		12:30P	0.15	0.00		6:29P	0.43	0.03		9:15P	0.30	0.20	23 Nov.	2:00P		Began		
	4:23A	0.05	0.38				End		6:40A	0.50	0.30		12:45P	0.20	0.20		6:48P	0.51	0.26				End		6:00P	0.15	End		
	4:30A	0.10	0.43	19 May	1:15P		Began		6:50A	0.55	0.30		1:15P	0.25	0.10				End										
	4:35A	0.15	0.60		1:30P	0.05	0.20		7:00A	0.60	0.30		1:30P	0.30	0.20	16 Aug.	3:40P		Began	26 May	2:45A		Began		3:00A	0.05	0.20		
	5:15A	0.20	0.08		2:30P	0.10	0.05		7:45A	0.65	0.07		2:00P	0.35	0.10		3:47P	0.14	1.20				End						
	5:30A	0.24	0.16				End	25 May	9:50A		Began		2:15P	0.40	0.20		3:48P	0.29	6.56		26 May	4:45A		Began		5:00A	0.08	0.32	
	5:45A	0.25	0.04		4:45P		Began		10:05A	0.05	0.20		2:25P	0.45	0.30		4:10P	0.46	0.06				End						
	6:00A	0.30	0.20	20 May	4:50P	0.10	1.20		10:55A	0.05	0.00	25 May	4:15A		Began		4:53P	0.48	0.03				End						
	6:15A	0.35	0.30				End		11:05A	0.10	0.30		4:20A	0.05	0.60				End		13 July	10:58A		Began					
	6:35A	0.40	0.30		7:00P		Began		11:45A	0.10	0.00		4:30A	0.10	0.30	17 Aug.	7:48P		Began		11:18A	0.04	0.12						
	6:50A	0.45	0.20		7:05P	0.05	0.60		11:50A	0.15	0.60		5:00A	0.15	0.10		8:28P	0.02	0.03		11:30A	0.16	0.59						
	7:05A	0.50	0.20				End		12:00N	0.20	0.30		5:15A	0.15	0.00		8:47P	0.07	0.16		12:05P	0.28	0.21						
	7:30A	0.60	0.23		8:15A	0.65	0.07	25 May	12:30P	0.25	0.10		5:25A	0.20	0.30		9:47P	0.08	0.01				End						
	8:15A	0.65	0.07		4:25A		Began		1:00P	0.30	0.10		5:40A	0.20	0.00				End		13 July	8:21P		Began					
			End		4:30A	0.05	0.60		1:45P	0.35	0.07		6:10A	0.30	0.20				End		21 Aug.	10:13P		Began					
25 May	10:15A		Began		4:35A	0.10	0.60				End		6:30A	0.35	0.15	21 Aug.	10:13P		Began		8:39P	0.06	0.19						
	11:20A	0.05	0.05		4:45A	0.15	0.30		5:10P		Began		6:45A	0.40	0.20		11:11P	0.02	0.02		8:51P	0.19	0.69						
	12:05P	0.10	0.07		5:00A	0.20	0.20	25 May	5:15P	0.05	0.60		6:50A	0.45	0.60		11:32P	0.04	0.06		9:00P	0.32	0.80						
	12:10P	0.20	1.20		5:30A	0.25	0.10				End		7:15A	0.50	0.12		11:53P	0.07	0.09		9:06P	0.47	1.60						
	12:45P	0.25	0.09		5:55A	0.30	0.12		7:30A	0.55	0.20		7:30A	0.55	0.20	22 Aug.	12:12A	0.08	0.03		9:09P	0.62	2.88						
	1:15P	0.30	0.10		6:15A	0.35	0.15	25 May	7:20P		Began		7:45A	0.60	0.20		12:53A	0.14	0.12		9:15P	0.77	1.57						
	2:00P	0.35	0.07		6:30A	0.40	0.20		7:35P	0.05	0.20				End		1:13A	0.16	0.06		9:27P	0.90	0.65						
	5:00P	0.40	0.02		6:45A	0.45	0.20		8:00P	0.10	0.12				End		2:13A	0.18	0.02				End						
	7:50P	0.45	0.02		7:00A	0.50	0.20		8:10P	0.15	0.30	25 May	10:15A		Began				End		18 July	5:58P		Began					
	8:00P	0.50	0.30		7:05A	0.55	0.60		8:15P	0.20	0.60		10:30A	0.05	0.20				End			6:37P	0.06	0.09					
	8:23P	0.55	0.12		7:30A	0.60	0.12		8:30P	0.30	0.20				End				End		31 Aug.	9:51P		Began					
	8:30P	0.60	0.43		7:45A	0.65	0.20		9:15P	0.35	0.07	25 May	11:10A		Began		10:10P	0.04	0.13		6:56P	0.08	0.06						
	8:40P	0.65	0.30				End				End		11:25A	0.05	0.20		10:26P	0.11	0.24		7:14P	0.12	0.13						
	9:00P	0.70	0.15	25 May	10:15A		Began	26 May	2:15P		Began		12:00N	0.05	0.00		10:44P	0.16	0.17		7:56P	0.14	0.03						
	9:30P	0.75	0.10		10:30A	0.05	0.20		2:25P	0.10	0.30		12:10P	0.15	0.60		11:03P	0.20	0.13		8:16P	0.20	0.18						
26 May	2:40A		Began		11:15A	0.05	0.00				End		12:20P	0.20	0.30	1 Sept.	12:27A	0.25	0.02	19 July	11:39A		Began						
	2:45A	0.05	0.60		11:30A	0.10	0.20		4:15P	0.03	0.36		1:00P	0.25	0.07		1:08A	0.27	0.03		11:58A	0.01	0.03						
			End		12:00N	0.10	0.00	26 May	4:10P		Began		1:30P	0.30	0.10				End										

Table 9. Continued.

P-1				P-2				P-3				P-4				P-5				P-6				P-7											
Date	Time	Depth	Intensity	Date	Time	Depth	Intensity	Date	Time	Depth	Intensity	Date	Time	Depth	Intensity	Date	Time	Depth	Intensity	Date	Time	Depth	Intensity	Date	Time	Depth	Intensity	Date	Time	Depth	Intensity				
	9:03P	0.44	1.08	26 May	4:45A		Began	18 July	5:37P		Began	1 June	4:45P		Began		6:11P	0.06	0.18		8:37P	0.05	0.09						8:56P	0.09	0.12				
	9:07P	0.59	2.06		5:00A	0.03	0.12		6:34P	0.09	0.09		5:15P	0.05	0.10		6:34P	0.09	0.08		8:56P	0.09	0.12						9:18P	0.11	0.06				
	9:10P	0.75	2.74				End		7:34P	0.11	0.02		5:20P	0.10	0.60		6:52P	0.13	0.13		9:18P	0.11	0.06												
	9:16P	0.91	1.48				End		8:17P	0.13	0.03		5:30P	0.15	0.30				End				End												
	9:32P	1.00	0.34	1 June	5:00P		Began		8:37P	0.15	0.06		5:40P	0.20	0.30	1 Sept.	11:31P		Began	21 Aug.	10:24P		Began												
	9:52P	1.03	0.09		5:15P	0.05	0.20				End		6:00P	0.25	0.15	2 Sept.	11:50P	0.04	0.13		11:45P	0.02	0.01												
			End		5:20P	0.10	0.60	19 July	11:29A		Began		6:15P	0.30	0.20		12:08A	0.09	0.17	22 Aug.	12:04A	0.03	0.03												
18 July	6:05P		Began		5:30P	0.15	0.30		11:48A	0.01	0.03				End		1:07A	0.21	0.12		12:25A	0.07	0.12												
	6:24P	0.03	0.09		5:45P	0.20	0.20		11:58A	0.14	0.83	13 July	11:30A		Began		2:04A	0.23	0.02		1:26A	0.09	0.02												
	7:02P	0.05	0.03		6:05P	0.25	0.15		12:04P	0.29	1.53		11:40A	0.14	0.88		3:05A	0.27	0.05		1:46A	0.10	0.03												
			End				End		12:07P	0.44	3.13		12:16A	0.24	0.16		4:23A	0.29	0.02				End												
	7:22P	0.08	0.09				End				End				End		4:24A	0.31	0.06	31 Aug.	9:43P		Began												
	8:00P	0.10	0.03				End		12:22P	0.55	0.43	13 July	8:35P		Began		5:01A	0.34	0.10		10:06P	0.01	0.03												
	8:20P	0.12	0.06		11:26A	0.14	1.02		12:35P	0.44	0.51		8:53P	0.07	0.23		5:27A	0.36	0.05		10:28P	0.03	0.05												
	8:41P	0.16	0.12		11:41A	0.23	0.35		12:52P	0.73	0.24		9:00P	0.21	1.12		5:49A	0.37	0.02		10:47P	0.07	0.13												
			End				End		1:54P	0.82	0.09		9:05P	0.36	1.95		6:12A	0.40	0.08		11:25P	0.17	0.16												
			End				End				End		9:11P	0.52	1.60		6:53A	0.42	0.03		11:43P	0.21	0.13												
19 July	11:47A		Began	13 July	8:48P		Began	22 July	5:34P		Began	13 July	9:15P	0.67	2.06		7:16A	0.44	0.06	1 Sept.	12:07A	0.24	0.07												
	12:05P	0.04	0.13		8:51P	0.15	2.77		5:55P	0.01	0.03		9:17P	0.82	4.50				End				End												
	12:12P	0.17	1.20		8:56P	0.30	1.64		6:35P	0.12	0.16		9:23P	0.97	1.44				End				End												
	12:18P	0.33	1.44		9:03P	0.44	1.08				End		9:31P	1.12	1.20	8 Sept.	12:00M		Began	1 Sept.	3:04A		Began												
	12:42P	0.59	0.65		9:06P	0.59	2.88				End		9:50P	1.14	0.06		1:04A	0.01	0.01		5:49A	0.02	0.01												
	12:57P	0.67	0.34		9:16P	0.90	1.93	21 Aug.	9:47P		Began		10:08P	1.18	0.03		1:23A	0.04	0.09		6:10A	0.04	0.06												
	1:15P	0.74	0.21				End		10:26P	0.02	0.03				End		3:41A	0.06	0.01		6:21A	0.17	0.70												
	1:34P	0.78	0.13				End		10:45P	0.06	0.12	18 July	5:59P		Began		6:03A	0.08	0.01		6:35A	0.30	0.56												
			End	18 July	5:35P		Began				End		6:18P	0.01	0.03		7:01A	0.09	0.01		6:55A	0.33	0.19												
			End		6:15P	0.02	0.03	22 Aug.	12:06A		Began		6:37P	0.06	0.16		7:50A	0.15	0.08		7:16A	0.37	0.12												
22 July	6:16P		Began		6:53P	0.06	0.03		12:26A	0.03	0.09		7:16P	0.08	0.03		8:31A	0.16	0.01		7:26A	0.39	0.12												
	6:53P	0.08	0.08				End				End		7:54P	0.09	0.02		8:50A	0.18	0.06		7:47A	0.44	0.15												
21 Aug.	9:43P		Began		7:13P	0.08	0.06				End		8:33P	0.11	0.03		9:10A	0.20	0.06		8:12A	0.44	0.00												
	10:02P	0.01	0.03		7:34P	0.12	0.12	31 Aug.	10:01P		Began		9:16P	0.13	0.03		9:29A	0.24	0.13		8:37A	0.48	0.10												
	10:21P	0.04	0.09		8:14P	0.14	0.03		10:20P	0.05	0.16				End				End				End												
	10:39P	0.08	0.13		8:35P	0.16	0.06		10:56P	0.17	0.20	19 July	11:56A		Began	11 Sept.	3:48A		Began	1 Sept.	9:43A		Began												
	10:56P	0.09	0.01		8:55P	0.18	0.06		11:15P	0.19	0.06		12:09P	0.12	0.57		4:10A	0.02	0.05		10:04A	0.04	0.12												
22 Aug.	12:20A	0.11	0.06				End				End		12:14P	0.28	1.07		4:29A	0.03	0.03		10:43A	0.06	0.03												
	12:40A	0.14	0.09				End	1 Sept.	4:41A		Began		12:20P	0.43	1.38		4:50A	0.06	0.09		11:03A	0.09	0.09												
			End	19 July	12:04P		Began		5:00A	0.02	0.06		12:34P	0.54	0.51		6:52A	0.10	0.02		11:22A	0.10	0.03												
31 Aug.	9:38P		Began		12:17P	0.12	0.52		5:41A	0.03	0.01		12:49P	0.63	0.34		7:30A	0.12	0.03		12:40P	0.12	0.02												
	9:58P	0.01	0.03		12:22P	0.27	1.95		5:49A	0.17	1.08		1:07P	0.69	0.24		7:50A	0.15	0.09		12:59P	0.17	0.15												
	10:18P	0.03	0.06		12:32P	0.10	0.81		6:04A	0.29	0.50		1:26P	0.76	0.18		8:11A	0.17	0.06		3:46P	0.19	0.01												
	10:38P	0.05	0.06		12:44P	0.53	0.63		6:43A	0.40	0.17				End		8:33A	0.21	0.11		5:46P	0.21	0.01												
	10:56P	0.08	0.10		1:18P	0.70	0.30		7:34A	0.41	0.01				End		9:56A	0.23	0.01		6:01P	0.22	0.03												
	11:14P	0.14	0.20		1:37P	0.73	0.10		7:55A	0.45	0.12	22 July	6:09P		Began				End		6:22P	0.27	0.14												
1 Sept.	1:32A	0.16	0.01				End		8:13A	0.48	0.10		6:28P	0.03	0.09	23 Sept.	7:38A		Began		8:26P	0.29	0.01												
	2:19A	0.18	0.03	22 July	5:56P		Began		9:34A	0.49	0.01		6:47P	0.08	0.16		7:56A	0.07	0.24		10:12P	0.31	0.01												
	3:00A	0.20	0.03		6:35P	0.02	0.03		9:53A	0.54	0.15		7:06P	0.12	0.13		8:06A	0.20	0.74		11:13P	0.33	0.02												
			End		6:52P	0.10	0.29		11:12A	0.55	0.01				End		8:22A	0.29	0.34	2 Sept.	11:53P	0.35	0.03												
1 Sept.	5:57A		Began		7:10P	0.14	0.13		12:10P	0.57	0.02	16 Aug.	3:10P		Began		8:38A	0.37	0.29		12:13A	0.39	0.12												
	6:16A	0.04	0.13				End		12:29P	0.62	0.15		3:29P	0.01	0.03		8:52A	0.48	0.47		12:32A	0.42	0.10												
	6:22A	0.19	1.60	21 Aug.	10:14P		Began				End		3:47P	0.07	0.20		9:05A	0.60	0.56</																

Table 9. Continued.

P-1				P-2				P-3				P-4				P-5				P-6				P-7																											
Date	Time	Depth	Intensity	Date	Time	Depth	Intensity	Date	Time	Depth	Intensity	Date	Time	Depth	Intensity	Date	Time	Depth	Intensity	Date	Time	Depth	Intensity	Date	Time	Depth	Intensity	Date	Time	Depth	Intensity																				
2 Sept.	11:57P	0.06	0.03																																																
	12:17A	0.11	0.15																													12:43P	0.64	0.09	1:17A	0.05	0.12	1 Sept.	5:53A	Began	25 Sept.	7:18A	Began	11 Sept.	3:37A	0.02	Began				
	12:37A	0.17	0.18																													1:04P	0.69	0.15	1:04P	0.05	End	6:14A	0.27	0.78	7:38A	0.03	0.09								
	1:16A	0.23	0.09																													1:50P	0.69	0.00	8 Sept.	5:52A	Began	6:33A	0.33	0.19	7:55A	0.09	0.21								
	1:35A	0.25	0.06																													4:56P	0.71	0.01	6:10A	0.06	0.18	6:53A	0.34	0.03	8:13A	0.14	0.17								
	1:58A	0.27	0.05																													5:34P	0.73	0.03	6:29A	0.09	0.09	7:28A	0.37	0.05	8:34A	0.16	0.06								
	2:55A	0.29	0.02																													5:55P	0.75	0.06	7:10A	0.09	0.00	8:25A	0.46	0.09	9:34A	0.18	0.02								
	3:54A	0.31	0.02																													6:14P	0.80	0.16	7:27A	0.19	0.36	9:47A	0.50	0.02	End	6:11A	0.08					0.13			
	4:34A	0.33	0.03																													6:32P	0.81	0.03	End	10:06A	0.54	0.13	10:06A	0.54	0.13	25 Sept.	2:12P					Began	6:30A	0.11	0.09
	4:53A	0.36	0.09																													6:53P	0.84	0.09	11 Sept.	3:59A	Began	12:29P	0.56	0.01	2:52P	0.02	0.03					6:50A	0.13	0.06	
	5:13A	0.36	0.00																													9:15P	0.86	0.01	4:19A	0.03	0.09	12:48P	0.60	0.13	4:10P	0.04	0.02					8:14A	0.20	0.04	
	5:32A	0.39	0.10																													10:12P	0.88	0.02	4:38A	0.04	0.03	1:52P	0.62	0.02	4:29P	0.05	0.03					8:53A	0.26	0.09	
	5:51A	0.41	0.06																													11:31P	0.90	0.02	5:36A	0.06	0.02	End	4:47P	0.08	0.10	9:14A	0.31					0.15			
	6:13A	0.42	0.03																													11:52P	0.91	0.03	5:57A	0.08	0.06	1 Sept.	5:36P	Began	End	9:32A	0.34					0.09			
6:34A	0.44	0.06	2 Sept.	12:31A	0.99	0.12	6:38A	0.10	0.03	5:55P	0.03	0.10	23 Oct.	2:59P	Began	End	End																																		
6:58A	0.46	0.05	1:10A	1.05	0.09	7:33A	0.11	0.01	6:34P	0.13	0.15	3:18P	0.02	0.06	23 Sept.	7:41A	Began	7:57A	0.08	0.30																															
End			1:28A	1.06	0.03	8:11A	0.19	0.13	End	End	End	3:40P	0.04	0.05	8:08A	0.21	0.69	8:43A	0.35	0.24																															
			1:48A	1.09	0.09	8:31A	0.21	0.06	1 Sept.	10:19P	Began	4:01P	0.07	0.09	8:55A	0.48	0.67	9:11A	0.56	0.30																															
8 Sept.	1:13A	Began	2:10A	1.10	0.03	8:52A	0.24	0.08	10:38P	0.02	0.06	5:05P	0.27	0.19	9:26A	0.67	0.43	9:11A	0.56	0.30																															
	1:32A	0.03	End	2:31A	1.12	0.06	End	End	11:39P	0.03	0.01	5:25P	0.32	0.16	9:42A	0.76	0.34	9:26A	0.67	0.43																															
	End		End	End					End	End	5:44P	0.36	0.12	10:01A	0.84	0.26	9:42A	0.76	0.34																																
8 Sept.	6:04A	Began	2 Sept.	4:31A	Began	23 Sept.	7:17A	Began	End	End	End	End	End	10:01A	0.84	0.26	10:01A	0.84	0.26																																
	6:33A	0.04	4:31A	0.05	4:49A	0.05	8:22A	0.34	0.32	2 Sept.	1:21A	Began	29 Oct.	11:56A	Began	10:20A	0.90	0.06	10:20A	0.90	0.06																														
	6:53A	0.07	4:49A	0.08	5:09A	0.08	8:31A	0.48	0.89	1:42A	0.01	0.03	12:48P	0.04	0.05	10:40A	0.90	0.06	10:40A	0.90	0.06																														
	6:58A	0.08	5:09A	0.12	5:31A	0.10	8:48A	0.55	0.25	2:22A	0.03	0.03	2:26P	0.06	0.01	10:59A	0.92	0.06	10:59A	0.92	0.06																														
	7:38A	0.09	5:31A	0.10	5:52A	0.13	9:04A	0.66	0.42	3:01A	0.05	0.03	2:50P	0.08	0.05	11:19A	0.95	0.09	11:19A	0.95	0.09																														
	7:58A	0.12	5:52A	0.13	6:11A	0.14	9:20A	0.75	0.32	4:43A	0.06	0.01	3:10P	0.10	0.06	11:41A	0.96	0.03	11:41A	0.96	0.03																														
	End		6:11A	0.14	6:37A	0.16	9:39A	0.82	0.23	5:04A	0.10	0.09	3:35P	0.14	0.10	11:59A	0.99	0.10	11:59A	0.99	0.10																														
11 Sept.	3:23A	Began	End	6:37A	0.16	0.03	9:57A	0.86	0.13	5:24A	0.13	0.12	4:38P	0.15	0.01	12:19P	1.01	0.06	12:19P	1.01	0.06																														
	3:43A	0.02	End	End			10:16A	0.86	0.00	6:03A	0.14	0.02	End	End	12:38P	1.03	0.06	12:38P	1.03	0.06																															
	4:03A	0.04	11 Sept.	12:05A	Began	10:35A	0.89	0.09	6:22A	0.17	0.09	End	End	12:57P	1.04	0.03	12:57P	1.04	0.03																																
	4:23A	0.06	4:11A	0.03	10:54A	0.90	0.03	6:41A	0.18	0.03	1 Nov.	4:28A	Began	End	End	End	End	End																																	
	5:39A	0.08	4:30A	0.04	11:34A	0.98	0.12	End	End	End	4:49A	0.01	0.03	5:08A	0.06	0.15	24 Sept.	3:00A	Began	4:49A	0.01	0.03																													
	6:38A	0.09	4:49A	0.06	12:16P	1.00	0.03	12:57A	0.01	0.03	5:08A	0.06	0.15	6:38A	0.16	0.03	4:37A	0.01	0.01	5:08A	0.06	0.15																													
	7:29A	0.09	5:31A	0.08	1:13P	1.02	0.02	1:16A	0.04	0.09	5:28A	0.12	0.18	7:08A	0.16	0.00	4:57A	0.03	0.06	5:28A	0.12	0.18																													
	7:48A	0.10	6:46A	0.10	1:32P	1.03	0.03	2:35A	0.06	0.02	6:38A	0.16	0.03	7:30A	0.19	0.08	End	End	End	6:38A	0.16	0.03																													
	8:08A	0.12	7:49A	0.11	End	End	End	3:05A	0.02	0.01	7:08A	0.16	0.00	7:50A	0.27	0.23	25 Sept.	1:10A	Began	7:08A	0.16	0.00																													
	8:26A	0.16	8:08A	0.14	24 Sept.	3:05A	Began	4:26A	0.02	0.01	7:30A	0.19	0.08	9:09A	0.30	0.02	1:44A	0.16	0.28	7:30A	0.19	0.08																													
	9:05A	0.19	8:28A	0.18	4:26A	0.02	0.01	5:38A	0.08	0.01	9:09A	0.30	0.02	9:52A	0.33	0.04	2:23A	0.27	0.17	9:09A	0.30	0.02																													
	9:24A	0.20	8:48A	0.20	5:47A	0.04	0.01	5:59A	0.09	0.03	9:52A	0.33	0.04	10:13A	0.36	0.09	2:43A	0.30	0.09	9:52A	0.33	0.04																													
	End		9:10A	0.23	End	End	End	6:19A	0.11	0.06	10:13A	0.36	0.09	End	End	End	End	End																																	
	End		End	End	End	End	End	6:37A	0.15	0.13	End	End	End	End	End	End	End	End																																	
25 Sept.	1:07A	Began	25 Sept.	7:56A	Began	25 Sept.	12:51A	Began	6:37A	0.15	0.13	End	End	End	End	End	End	End																																	
	1:22A	0.10	8:09A	0.11	0.51	1:10A	0.04	0.13	End	End	End	End	End	End	End	End	End	End																																	
	1:39A	0.17	8:43A	0.28	0.30	1:26A	0.11	0.25	8 Sept.	7:08A	Began	3 Nov.	1:32P	Began	25 Sept.	3:46A	Began	1:32P	Began																																
	1:57A	0.22	9:14A	0.48	0.39	2:02A	0.23	0.20	8:45A	0.02	0.01	4:26A	0.08	0.12	4:26A	0.08	0.12	1:57P	0.02	0.05																															
	2:16A	0.26	9:29A	0.59	0.43	2:21A	0.26	0.10	9:04A	0.05	0.09	4:45A	0.14	0.19	4:45A	0.14	0.19	2:22P	0.05	0.07																															
	3:16A	0.28	10:02A	0.75	0.29	2:43A	0.30	0.11	9:25A	0.09	0.12	5:03A	0.19	0.16	5:03A	0.19	0.16	2:54P	0.07	0.04																															
	3:35A	0.30	10:20A	0.79	0.13	4:05A	0.32	0.01	9:45A	0.10	0.03	5:43A	0.25	0.09	5:43A	0.25	0.09	4:36P	0.15	0.05																															
	4:35A	0.42	10:40A	0.82	0.09	4:22A	0.39	0.24	End	End	End	6:43A	0.26	0.01	6:43A	0.26	0.01	End	End	End																															
	4:56A	0.47	11:17A	0.83	0.02	4:41A	0.43	0.13	End	End	End	7:13A	0.26	0.00	7:13A	0.26	0.00	End	End	End																															
	5:16A	0.49	11:37A	0.85	0.06	5:01A	0.49	0.18	11 Sept.	4:16A	Began	4 Nov.	12:05P	Began	7:33A	0.30	0.12	12:05P	Began																																
	5:35A	0.50	11:59A	0.89	0.11	5:20A	0.50	0.03	4:59A	0.02	0.03	12:24P	0.01	0.03	7:52A	0.47	0.22	12:24P	0.01	0.03																															
	5:55A	0.52	12:20P	0.92	0.09	5:40A	0.52	0.06	5:20A	0.04	0.06	12:34P	0.14	0.79	8:12A	0.53	0.18	12:34P	0.14	0.79																															
	End		1:19P	0.94	0.02	End	End	End	5:40A	0.05	0.03	12:47P	0.26	0.56	8:34A	0.55	0.06	12:47P	0.26	0.56																															
	End		End	End	End	End	End	End	6:20A	0.07	0.03	End	End	End	End	End	End																																		
25 Sept.	7:10A	Began	25 Sept.	7:13A	Began	25 Sept.	7:13A	Began	6:39A	0.08	0.03	8 Sept.	7:08A	Began	18 Nov.	8:35A	Began	25 Sept.	2:22P	Began																															
	7:29A	0.04	7:29A	0.05	0.15	7:33A	0.05	0.15	8:18A	0.09	0.01	8:45A	0.02	0.01	8:55A	0.07	0.22	3:43P	0.02	0.01																															
	7:47A	0.10	7:52A	0.11	0.19	7:52A	0.11	0.19	8:56A	0.17	0.13	9:04A	0.05	0.09	10:32A	0.08	0.01	4:20P	0.04	0.03																															

Table 9. Continued.

P-1				P-2				P-3				P-4				P-5				P-6				P-7							
Date	Time	Depth	Intensity	Date	Time	Depth	Intensity	Date	Time	Depth	Intensity	Date	Time	Depth	Intensity	Date	Time	Depth	Intensity	Date	Time	Depth	Intensity	Date	Time	Depth	Intensity	Date	Time	Depth	Intensity
29 Oct.	5:19P	0.30	0.09	25 Sept.	7:36A	0.63	0.15	9 Oct.	6:12P	0.32	0.05	25 Sept.	5:53A	0.03	0.02	19 Nov.	8:58A		Began	9 Oct.	6:57P	0.08	0.03								
	11:59A		Began		7:55A	0.67	0.13		6:43P	0.35	0.06		6:14A	0.05	0.06		9:16A	0.02	0.06		7:28P	0.09	0.02								
	12:19P	0.01	0.03		8:13A	0.72	0.17		7:21P	0.40	0.08		End	10:03A	0.04		0.03	End	10:39A		0.08	0.07	End								
	12:57P	0.03	0.03		8:32A	0.74	0.06		End	3:59A			Began	11:26A	0.14		0.08	11:26A	0.14		0.08	4:01A		Began							
	2:37P	0.04	0.01		8:53A	0.75	0.03		End	4:18A	0.01		0.03	1:26A	0.04		0.13	11:34A	0.14		0.00	5:01A	0.02	0.02							
	2:57P	0.07	0.09		End	9 Oct.	3:33P			Began	4:31A		0.03	0.06	1:43A		0.11	0.25	11:56A		0.16	0.05	5:26A	0.05	0.07						
	3:41P	0.10	0.05		End	3:34P	0.02		0.02	5:04A	0.04		0.02	2:01A	0.17		0.20	12:19P	0.17		0.03	End									
1 Nov.	4:17A		Began	3:53P	0.04	0.06	5:32A	0.06	0.04	2:19A	0.22	0.17	2:56A	0.28	0.10	2:44P	0.30	0.03	23 Oct.	3:02P		Began									
	4:59A	0.01	0.01	3:34P	0.02	0.02	End	3:56A	0.29	0.10	2:56A	0.28	0.10	3:44P	0.35	0.05	4:02P	0.09		0.09											
	5:18A	0.07	0.19	3:53P	0.04	0.06	23 Oct.	4:14A	0.32	0.09	4:14A	0.32	0.09	End	4:23P	0.13	0.12	4:02P		0.09	0.09										
	5:37A	0.11	0.13	3:53P	0.04	0.06	2:56P		Began	4:32A	0.39	0.23	4:32A	0.39	0.23	4:41P	0.21	0.27		4:23P	0.13	0.12									
	6:55A	0.13	0.02	3:53P	0.04	0.06	3:33P	0.06	0.10	4:53A	0.44	0.15	5:11A	0.51	0.23	4:59P	0.25	0.13		4:41P	0.21	0.27									
	End	End	End	3:33P	0.06	0.10	4:12P	0.16	0.16	5:11A	0.51	0.23	6:30A	0.53	0.02	5:20P	0.27	0.06		4:59P	0.25	0.13									
1 Nov.	8:30A		Began	4:30P	0.22	0.19	4:48P	0.29	0.24	7:13A	0.53	0.00	7:52A	0.54	0.02	12:02P	0.06	0.12	5:42P	0.31	0.11	29 Oct.	12:16P		Began						
	8:50A	0.02	0.06	4:48P	0.29	0.24	5:10P	0.32	0.08	8:30A	0.62	0.12	8:47A	0.70	0.21	End	6:01P	0.32	0.03												
	9:49A	0.04	0.02	5:10P	0.32	0.08	5:29P	0.36	0.13	8:30A	0.62	0.12	9:08A	0.73	0.09	End	End	End													
	10:10A	0.06	0.06	5:29P	0.36	0.13	End	11:16A		Began	9:27A	0.75	0.06	9:27A	0.75	0.06	End	End	End												
	End	End	End	End	29 Oct.	11:16A		Began	9:27A	0.75	0.06	9:27A	0.75	0.06	End	End	End														
	End	End	End	End	12:41P	0.02	0.02	2:42P	0.03	<0.01	9:08A	0.73	0.09	9:27A	0.75	0.06	End	End	End												
3 Nov.	1:56P		Began	5:22P	0.29	0.01	3:05P	0.06	0.08	2:47P		Began	4:25P	0.04	0.03	23 Nov.	12:14P		Began	1 Nov.	3:49A		Began								
	2:38P	0.02	0.03	5:42P	0.32	0.09	3:29P	0.07	0.02	3:47P	0.02	0.03	12:34P	0.01	0.03		4:37A	0.02	0.03												
	2:58P	0.05	0.09	6:53P	0.34	0.02	4:00P	0.12	0.10	4:25P	0.04	0.03	12:53P	0.04	0.10		4:37A	0.02	0.03												
	3:17P	0.09	0.13	7:13P	0.35	0.03	End	4:19A		Began	4:44P	0.06	0.06	1:32P	0.06		0.03	4:57A	0.04		0.06										
	3:36P	0.10	0.03	End	9 Oct.	4:55A		Began	4:40A	0.02	0.06	5:05P	0.09	0.09	1:41P		0.20	0.93	5:43A		0.10	0.08									
	4:13P	0.14	0.07	End	5:55A	0.02	0.02	6:15A	0.03	0.03	5:57A	0.07	0.02	2:16P	0.21		0.02	6:34A	0.14		0.05										
5:29P	0.15	0.01	End	6:15A	0.03	0.03	End	5:57A	0.07	0.02	6:08A	0.11	0.11	End	7:22A	0.14	0.00	4:37A	0.02	0.03											
4 Nov.	11:19A		Began	3:22P	0.01	0.03	4:19P	0.10	0.09	7:16A	0.11	0.00	11:07A	0.08	0.02	25 Nov.	10:53A		Began	9 Oct.	2:24A		Began								
	12:17P	0.02	0.02	4:19P	0.10	0.09	7:16A	0.11	0.00	9:20A	0.17	0.03	11:07A	0.08	0.02		11:16A	0.03	0.08		2:24A		Began								
	12:21P	0.17	2.06	4:37P	0.17	0.24	9:20A	0.17	0.03	End	11:07A	0.08	0.02	12:22P	0.05		0.02	12:22P	0.05		0.02	2:12P	0.08	0.02							
	12:40P	0.20	0.17	4:55P	0.22	0.17	End	1:20P		Began	2:34P	0.09	<0.01	11:16A	0.03		0.08	2:12P	0.08		0.02										
	12:58P	0.23	0.03	5:20P	0.27	0.12	3 Nov.	1:20P		Began	2:51P	0.19	0.34	12:43P	0.06		0.03	9:22A	0.22		0.09	4:15P	0.18	0.05							
	End	End	End	5:38P	0.33	0.21	End	2:45P	0.02	0.01	3:10P	0.25	0.18	1:28P	0.11		0.07	5:32P	0.20		0.02										
12 Nov.	3:20P		Began	End	5:38P	0.33	0.21	End	3:05P	0.05	0.09	3:30P	0.28	0.09	2:15P	0.14	0.04	3 Nov.	12:32P		Began										
	3:38P	0.06	0.20	12:37P		Began	3:36P	0.08	0.06	6:10P	0.29	<0.01	End	12:32P		Began															
	3:54P	0.14	0.30	12:58P	0.03	0.09	4:34P	0.11	0.03	6:31P	0.32	0.09	End	12:58P	0.03	0.07															
	4:11P	0.20	0.21	1:46P	0.05	0.02	End	12:40P		Began	End	1:19P	0.06	0.09	1:19P	0.06	0.09														
	4:30P	0.25	0.16	2:08P	0.08	0.08	4 Nov.	12:40P		Began	9 Oct.	2:24A		Began	2:12P	0.08	0.02														
	4:49P	0.29	0.13	3:41P	0.10	0.01	12:44P	0.15	2.48	1:20P	0.27	0.20	2:49A	0.01	0.02	4:15P	0.18		0.05												
5:28P	0.35	0.09	4:00P	0.13	0.10	6:14P	0.40	0.10	5:08P	0.15	0.02	End	5:32P	0.20	0.02	5:32P	0.20	0.02													
18 Nov.	8:47A		Began	5:08P	0.15	0.02	End	End	End	23 Oct.	3:02P		Began	4 Nov.	12:22P		Began														
	9:05A	0.04	0.13	End	12 Nov.	3:00P		Began	3:42P	0.02	0.03	3:42P	0.02		0.03	12:34P	0.13	0.69													
	10:39A	0.05	0.01	1 Nov.	3:47A		Began	3:22P	0.03	0.08	4:21P	0.10	0.12		12:49P	0.25	0.48														
	11:38A	0.19	0.14	4:31A	0.01	0.01	4:25P	0.28	0.24	4:56P	0.23	0.22	1:08P		0.26	0.03															
	11:58A	0.21	0.06	4:52A	0.03	0.06	4:47P	0.31	0.08	5:14P	0.26	0.10	End																		
	12:23P	0.24	0.07	5:18A	0.08	0.12	5:07P	0.36	0.15	5:34P	0.31	0.16	End																		
	3:26P	0.24	0.00	5:41A	0.10	0.05	5:26P	0.38	0.06	5:53P	0.32	0.03	End																		
	4:10P	0.30	0.08	6:55A	0.13	0.02	5:56P	0.41	0.06	End	End																				
	4:30P	0.32	0.05	End	End	18 Nov.	10:14A		Began	2:15P		Began	3:11P			Began															
	5:41P	0.34	0.02	1 Nov.	7:21A		Began	10:37A	0.04	0.11	2:35P	0.02	0.06		3:32P	0.04	0.12														
	6:40P	0.36	0.02	8:21A	0.01	0.01	8:57A	0.03	0.03	10:59A	0.09	0.13	2:53P		0.05	0.10	3:48P	0.12	0.30												
	7:00P	0.38	0.06	9:28A	0.07	0.08	9:28A	0.07	0.08	11:18A	0.12	0.09	3:14P		0.06	0.03	4:06P	0.19	0.24												
8:37P	0.40	0.01	10:13A	0.09	0.03	End	11:53A	0.15	0.05	3:28P	0.09	0.10	4:52P	0.28	0.12																
8:59P	0.41	0.03	End	End	12:32P	0.17	0.03	12:32P	0.17	0.03	3:56P	0.12	0.08	5:10P	0.34	0.19															
End	End	End	End	12:55P	0.18	0.03	End	12:55P	0.18	0.03	4:39P	0.14	0.03	5:29P	0.37	0.10															
13 Nov.	8:20A		Began	2:04P		Began	3:08P	0.20	0.01	3:08P	0.20	0.01	6:08P	0.17	0.02	18 Nov.	10:29A		Began												
	9:03A	0.02	0.03	2:27P	0.01	0.03	3:31P	0.21	0.03	3:31P	0.21	0.03	6:08P	0.17	0.02		10:50A	0.04	0.11												
	10:16A	0.04	0.02	2:47P	0.05	0.12	4:28P	0.24	0.03	4:28P	0.24	0.03	6:08P	0.17	0.02		11:11A	0.07	0.09												
	10:34A	0.06	0.06	3:50P	0.07	0.02	4:50P	0.27	0.08	4:50P	0.27	0.08	End	11:11A	0.07		0.09														
	10:53A	0.07	0.03	4:09P	0.10	0.10	6:02P	0.31	0.03	6:02P	0.31	0.03	End	11:43A	0.13		0.11														
	11:33A	0.13	0.09	4:57P	0.15	0.06	6:28P	0.33	0.05	6:28P	0.33	0.05	End	12:20P	0.15		0.03														
	11:52A	0.14	0.03	End	End	7:10P	0.35	0.03	7:10P	0.35	0.03	End	12:50P	0.16	0.02																
	12:07P	0.15	0.03	4 Nov.	11:50A		Began	8:44P	0.37	0.01	8:44P	0.37	0.01	End	3:29P		0.18	0.01													
	12:26P	0.17	0.06	12:29P	0.01	0.02	10:03P	0.39	0.02	10:03P	0.39	0.02	End	3:50P	0.20		0.05														
	1:37P	0.23	0.06	12:39P	0.15	0.88	10:28P	0.40	0.02	10:28P	0.40	0.02	End	4:36P	0.23		0.04														
	2:01P	0.24	0.03	12:53P	0.25	0.42	10:58P	0.42	0.04	10:58P	0.42	0.04	End	5:15P	0.26		0.05														
	2:51P	0.28	0.05	1:11P	0.29	0.13	End	End	End	End	End	5:35P	0.29	0.09																	
3:11P	0.30	0.06	End	End	19 Nov.	4:32A		Began	3:07P	0.20	0.10	End	6:23P	0.30	0.01																
3:41P	0.32	0.04	12 Nov.	3:15P		Began	4:55A	0.02	0.05	3:26P	0.21	0.03	End	6:48P	0.34	0.10															
4:34P	0.34	0.02	3:33P	0.04	0.13	End	6:11A	0.05	0.02	4:38P																					

Table 9. Continued.

P-1			P-2			P-3			P-4			P-5			P-6			P-7		
Date	Time	Depth Intensity	Date	Time	Depth Intensity	Date	Time	Depth Intensity	Date	Time	Date Intensity	Date	Time	Date Intensity	Date	Time	Date Intensity	Date	Time	Date Intensity
21 Nov.	11:36A	Began		3:59P	0.08 0.09	19 Nov.	8:14A	Began		4:58P	0.31 0.03	19 Nov.	2:51A	Began						
	11:56A	0.03 0.09		4:28P	0.15 0.15		8:57A	0.02 0.03		5:33P	0.35 0.07		4:04A	0.01 0.01						
	12:18P	0.05 0.05		4:47P	0.21 0.18		9:19A	0.03 0.03		6:08P	0.38 0.05		4:29A	0.03 0.05						
	1:47P	0.06 0.01		5:07P	0.26 0.16		9:39A	0.06 0.09					5:05A	0.04 0.02						
	2:07P	0.09 0.09		5:42P	0.31 0.08		10:05A	0.09 0.07	4 Nov.	10:49A	Began		6:09A	0.06 0.02						
		End			End		10:36A	0.12 0.06		11:09A	0.01 0.03			End						
			18 Nov.	10:34A	Began		10:36A	0.12 0.06		12:08P	0.13 0.12		19 Nov.	9:48A	Began					
22 Nov.	12:50P	Began		10:56A	0.03 0.08		11:02A	0.16 0.09			End			10:11A	0.02 0.05					
	1:11P	0.04 0.12		11:35A	0.11 0.12			End						10:54A	0.08 0.08					
	2:05P	0.12 0.09		11:55A	0.14 0.09	19 Nov.	12:03P	Began	12 Nov.	3:08P	Began			11:16A	0.09 0.03					
	2:25P	0.14 0.06		12:16P	0.15 0.03		12:28P	0.02 0.05		3:27P	0.01 0.03			11:38A	0.09 0.00					
	3:09P	0.19 0.07		1:07P	0.19 0.05		12:48P	0.03 0.03		3:43P	0.11 0.37			11:59A	0.16 0.20					
	3:43P	0.20 0.02		3:31P	0.20 0.00		2:23P	0.11 0.05		4:01P	0.17 0.21			12:22P	0.18 0.05					
	4:32P	0.23 0.04		3:49P	0.22 0.06		2:47P	0.11 0.00		4:37P	0.27 0.16			1:04P	0.20 0.03					
		End		4:12P	0.23 0.03		3:23P	0.14 0.05		4:56P	0.31 0.13			1:29P	0.22 0.05					
23 Nov.	2:04P	Began		4:32P	0.25 0.06		4:12P	0.16 0.02		5:14P	0.34 0.10			2:05P	0.26 0.07					
	2:26P	0.03 0.08		4:53P	0.27 0.06		6:01P	0.18 0.01			End			2:52P	0.30 0.05					
	2:45P	0.07 0.12		6:10P	0.32 0.04			End	18 Nov.	10:36A	Began			3:31P	0.31 0.02					
	2:47P	0.23 4.27		6:30P	0.32 0.00					10:59A	0.01 0.03			4:45P	0.33 0.02					
	3:08P	0.26 0.09		7:19P	0.36 0.05	21 Nov.	11:41A	Began		11:22A	0.04 0.08				End					
		End		8:50P	0.38 0.01		12:04P	0.02 0.05		11:44A	0.08 0.10									
25 Nov.	1:19P	Began		9:13P	0.40 0.05		12:23P	0.04 0.06		12:11P	0.09 0.02		21 Nov.	11:47A	Began					
	1:41P	0.04 0.11		11:35P	0.42 0.01		1:13P	0.06 0.02		12:32P	0.11 0.06			12:37P	0.01 0.01					
	3:23P	0.06 0.01			End		3:39P	0.08 0.01		1:08P	0.15 0.07			12:57P	0.03 0.06					
	3:44P	0.08 0.06	19 Nov.	2:38A	Began		4:03P	0.09 0.02		3:21P	0.17 0.01			1:28P	0.05 0.04					
		End		4:23A	0.02 0.01			End		3:59P	0.19 0.03			2:05P	0.07 0.03					
				4:46A	0.04 0.05					4:19P	0.20 0.03				End					
			19 Nov.	9:59A	Began		22 Nov.	12:44P	Began		4:47P	0.23 0.06		22 Nov.	2:37P	Began				
				10:18A	0.03 0.09			1:03P	0.03 0.09		5:13P	0.24 0.09			2:57P	0.03 0.09				
				10:38A	0.05 0.06			2:27P	0.19 0.11		5:35P	0.26 0.05			3:21P	0.09 0.15				
				11:04A	0.07 0.05			2:47P	0.20 0.03		6:23P	0.30 0.05			3:48P	0.12 0.07				
				11:33A	0.10 0.09			4:41P	0.28 0.04		7:04P	0.36 0.09			4:20P	0.15 0.06				
				11:50A	0.13 0.07	23 Nov.	12:34P	Began		8:26P	0.37 0.01			5:02P	0.16 0.01					
				11:58A	0.13 0.00		12:49P	0.10 0.39		8:47P	0.39 0.06				End					
				12:17P	0.14 0.03		1:11P	0.12 0.05		10:22P	0.43 0.03									
				12:37P	0.16 0.06	25 Nov.	10:30A	Began	19 Nov.	2:45A	Began									
				1:24P	0.21 0.06		11:28A	0.02 0.02		3:10A	0.02 0.05									
				2:00P	0.24 0.05		2:01P	0.04 0.01		4:53A	0.05 0.03									
				2:40P	0.28 0.06		2:20P	0.05 0.03			End			25 Nov.	3:11P	Began				
				3:29P	0.31 0.04		2:52P	0.07 0.04							5:04P	0.16 0.08				
				4:31P	0.32 0.01			End		19 Nov.	8:53A	Began				End				
					End					9:34A	0.02 0.03									
										9:53A	0.03 0.03									
										11:05A	0.09 0.05									
			21 Nov.	11:51A	Began					11:23A	0.11 0.06									
				12:08P	0.07 0.24					11:51A	0.16 0.11									
				1:01P	0.09 0.02						End									
				1:20P	0.10 0.03															
				2:05P	0.13 0.04															
					End					19 Nov.	12:25P	Began								
										1:04P	0.02 0.03									
										1:26P	0.04 0.05									
			22 Nov.	1:08P	Began					2:01P	0.06 0.03									
				1:26P	0.03 0.09					2:34P	0.08 0.04									
				1:46P	0.07 0.12					3:08P	0.10 0.04									
				2:25P	0.11 0.06					3:52P	0.12 0.03									
				2:58P	0.15 0.07					4:17P	0.13 0.02									
				3:46P	0.19 0.05					4:37P	0.15 0.06									
				4:42P	0.22 0.03						End									
					End					21 Nov.	12:29P	Began								
										12:47P	0.03 0.09									
										1:39P	0.06 0.03									
										3:28P	0.08 0.01									
										3:49P	0.09 0.03									
					End						End									
										22 Nov.	12:41P	Began								
										1:20P	0.06 0.09									
										1:59P	0.14 0.12									
										2:18P	0.19 0.17									
										2:47P	0.23 0.08									
										3:35P	0.27 0.05									
										4:12P	0.31 0.06									
										4:59P	0.34 0.04									
					End						End									

Table 9. Continued.

P-1			P-2			P-3			P-4			P-5			P-6			P-7			
Date	Time	Depth Intensity	Date	Time	Depth Intensity	Date	Time	Depth Intensity	Date	Time	Depth Intensity	Date	Time	Depth Intensity	Date	Time	Depth Intensity	Date	Time	Depth Intensity	
									23 Nov.	12:14P											
										12:59P	0.02	0.03									
										2:25P	0.04	0.01									
										3:29P	0.05	0.01									
										3:50P	0.09	0.12									
										4:27P	0.12	0.05									
																					End
									25 Nov.	11:07A											
										11:27A	0.02	0.06									
										1:54P	0.04	0.01									
										2:14P	0.06	0.06									
										2:51P	0.09	0.05									
										3:49P	0.12	0.03									
																					End

Table 10. Precipitation in Truchek gages, Parleys site.

SP-1		SP-2		SP-3		SP-4		SP-5		SP-6	
Date	Amt. (in.)	Date	Amt. (in.)	Date	Amt. (in.)	Date	Amt. (in.)	Date	Amt. (in.)	Date	Amt. (in.)
<u>1972</u>											
11 Sept.		20 Sept.		20 Sept.		20 Sept.		20 Sept.		20 Sept.	
18 Sept.	.10	2 Oct.	.09	2 Oct.	.10	2 Oct.	.08	2 Oct.	.08	2 Oct.	.09
18 Sept.		2 Oct.		2 Oct.		2 Oct.		2 Oct.		2 Oct.	
1 Oct.	.10	9 Oct.	.59	9 Oct.	.60	9 Oct.	.61	9 Oct.	.61	9 Oct.	.64
1 Oct.		9 Oct.		9 Oct.		9 Oct.		9 Oct.		9 Oct.	
8 Oct.	.63	16 Oct.	.22	16 Oct.	.25	16 Oct.	.23	16 Oct.	.22	16 Oct.	.27
8 Oct.		16 Oct.		16 Oct.		16 Oct.		16 Oct.		16 Oct.	
16 Oct.	.24	21 Oct.	.80	22 Oct.	.82	22 Oct.	.76	21 Oct.	.72	22 Oct.	.80
16 Oct.		21 Oct.		22 Oct.		22 Oct.		21 Oct.		22 Oct.	
19 Oct.	.82	25 Oct.	.62	25 Oct.	.60	25 Oct.	.68	25 Oct.	.64	25 Oct.	.65
19 Oct.		25 Oct.		25 Oct.		25 Oct.		25 Oct.		25 Oct.	
23 Oct.	.62	30 Oct.	.17	30 Oct.	.40	30 Oct.	.18	30 Oct.	.20	30 Oct.	.31
23 Oct.		30 Oct.		30 Oct.		30 Oct.		30 Oct.		30 Oct.	
30 Oct.	.40										
<u>1973</u>											
9 Apr.		18 Apr.	.55	18 Apr.	.58	18 Apr.	.56	18 Apr.	.50	18 Apr.	.55
18 Apr.	.53	18 Apr.		18 Apr.		18 Apr.		18 Apr.		18 Apr.	
24 Apr.	.36	24 Apr.	.33	24 Apr.	.39	24 Apr.	.34	24 Apr.	.37	24 Apr.	.37
24 Apr.		24 Apr.		24 Apr.		24 Apr.		24 Apr.		24 Apr.	
30 Apr.	.60	30 Apr.	.05	30 Apr.	.62	30 Apr.	.60	30 Apr.	.66	30 Apr.	.64
30 Apr.		30 Apr.		30 Apr.		30 Apr.		30 Apr.		30 Apr.	
9 May	.07	9 May	.10	9 May	.11	9 May	.08	9 May	.10	9 May	.08
15 May		15 May		15 May		15 May		15 May		15 May	
22 May	.19	22 May	.19	22 May	.21	22 May	.16	22 May	.19	22 May	.19
22 May		22 May		22 May		22 May		22 May		22 May	
29 May	1.27	29 May	1.25	29 May	1.25	29 May	1.30	29 May	1.25	29 May	1.26
29 May		29 May		29 May		29 May		29 May		29 May	
4 June	.29	4 June	.28	4 June	.25	4 June	.25	4 June	.29	4 June	.29
12 June		12 June		12 June		12 June		12 June		12 June	
18 June	.06	18 June	.06	18 June	.08	18 June	.07	18 June	.08	18 June	.11
7 July		7 July		7 July		7 July		7 July		7 July	
16 July	1.30	16 July	1.12	16 July	1.25	16 July	1.00	16 July	1.10	16 July	1.10
16 July		16 July		16 July		16 July		16 July		16 July	
23 July	1.00	23 July	.96	23 July	1.00	23 July	.82	23 July	.94	23 July	.96
13 Aug.		13 Aug.		13 Aug.		13 Aug.		13 Aug.		13 Aug.	
20 Aug.	.40	20 Aug.	.40	20 Aug.	.36	20 Aug.	.32	20 Aug.	.40	20 Aug.	.40
20 Aug.		20 Aug.		20 Aug.		20 Aug.		20 Aug.		20 Aug.	
27 Aug.	.05	27 Aug.	.05	27 Aug.	.06	27 Aug.	.03	27 Aug.	.04	27 Aug.	.04
27 Aug.		27 Aug.		27 Aug.		27 Aug.		27 Aug.		27 Aug.	
4 Sept.	1.35	4 Sept.	1.27	4 Sept.	1.25	4 Sept.	1.22	4 Sept.	1.18	4 Sept.	Molested
										9 Oct.	
										10 Oct.	.14
4 Sept.		4 Sept.		4 Sept.		4 Sept.		4 Sept.		4 Sept.	Molested
10 Sept.	.22	10 Sept.	.20	10 Sept.	.20	10 Sept.	.22	10 Sept.	.20	10 Sept.	
10 Sept.		10 Sept.		10 Sept.		10 Sept.		10 Sept.		10 Sept.	
17 Sept.	.16	17 Sept.	.15	17 Sept.	.14	17 Sept.	.15	17 Sept.	.15	17 Sept.	
17 Sept.		17 Sept.		17 Sept.		17 Sept.		17 Sept.		17 Sept.	
24 Sept.	1.06	24 Sept.	1.00	24 Sept.	1.05	24 Sept.	1.05	24 Sept.	1.05	24 Sept.	1.07
24 Sept.		24 Sept.		24 Sept.		24 Sept.		24 Sept.		24 Sept.	
1 Oct.	.73	1 Oct.	.70	1 Oct.	.70	1 Oct.	.70	1 Oct.	.62	1 Oct.	.70
1 Oct.		1 Oct.		1 Oct.		1 Oct.		1 Oct.		1 Oct.	
9 Oct.		9 Oct.	.44	9 Oct.	.44	9 Oct.	.42	9 Oct.	.46	9 Oct.	.48
23 Oct.		23 Oct.		23 Oct.		23 Oct.		23 Oct.		23 Oct.	
29 Oct.	.36	29 Oct.	.36	29 Oct.	.38	29 Oct.	.34	29 Oct.	.36	29 Oct.	.40
29 Oct.		29 Oct.		29 Oct.		29 Oct.		29 Oct.		29 Oct.	
3 Nov.	.62	3 Nov.	.60	3 Nov.	.70	3 Nov.	.60	3 Nov.	.60	3 Nov.	.60
3 Nov.		3 Nov.		3 Nov.		3 Nov.		3 Nov.		3 Nov.	
12 Nov.	.15	12 Nov.	.12	12 Nov.	.08	12 Nov.	.04	12 Nov.	.05	12 Nov.	.07
12 Nov.		12 Nov.		12 Nov.		12 Nov.		12 Nov.		12 Nov.	
19 Nov.	1.55	19 Nov.	1.50	19 Nov.	1.75	19 Nov.	1.45	19 Nov.	1.48	19 Nov.	1.50
19 Nov.		19 Nov.		19 Nov.		19 Nov.		19 Nov.		19 Nov.	
26 Nov.	Snow	26 Nov.	Snow	26 Nov.	Snow	26 Nov.	Snow	26 Nov.	Snow	26 Nov.	Snow
26 Nov.		26 Nov.		26 Nov.		26 Nov.		26 Nov.		26 Nov.	
10 Dec.	1.25	10 Dec.	1.10	10 Dec.	1.35	10 Dec.	.82	10 Dec.	1.10	10 Dec.	1.30

Table 11. Runoff dates, times of beginning, ending, and change of flow rate and flow rates for Parleys site 1972 and 1973 for PW-1 flume.

Date	Time	Discharge (cfs)	Notes	Date	Time	Discharge (cfs)	Notes	Date	Time	Discharge (cfs)	Notes	Date	Time	Discharge (cfs)	Notes	
<u>1972</u>				<u>1972</u>				<u>1972</u>				<u>1972</u>				
13 Aug.	8:46P	0	Began	5 Sept.	12:42P	0.0022		19 Sept.	1:59P	0.015		9 Oct.	3:01A	0.0009		
	8:50P	0.00005		cont.	1:00P	0.0015		cont.	4:01P	0.0039		cont.	3:27A	0.0007		
	8:58P	0.00005			1:06P	0.0015			4:04P	0.00065			3:33A	0.00002		
	9:00P	0	End		1:09P	0.0021			4:07P	0.00031			6:32A	0	End	
2 Sept.	9:02P	0	Began		1:14P	0.0021			4:08P	0.00012		10 Oct.	3:12A	0	Began	
	9:04P	0.0040			1:30P	0.0002			4:11P	0.00002			3:14A	0.00029		
	9:12P	0.0040			3:06P	0.0001			4:20P	0.000003			3:23A	0.00029		
	9:14P	0.0012			3:07P	0	End		4:32P	0	End		3:40A	0.000008		
	9:20P	0.0005		5 Sept.	3:07P	0	Began	4 Oct.	8:14P	0	Began		4:10A	0.000002		
	9:22P	0.008			3:08P	0.042			8:15P	0.00002			4:12A	0.00065		
	9:24P	0.012			3:09P	0.048			8:16P	0.052			4:16A	0.0022		
	9:29P	0.012			3:11P	0.048			8:19P	0.260			4:19A	0.0022		
	9:36P	0.008			3:14P	0.007			8:20P	0.034			4:21A	0.0018		
	9:46P	0.0002			3:18P	0.0012			8:25P	0.0044			4:26A	0.0018		
	9:48P	0	End		3:26P	0.0002			8:28P	0.0026			4:33A	0.00014		
5 Sept.	8:24A	0	Began		3:36P	0.0001			8:34P	0.0024			4:42A	0.00014		
	8:25A	0.0040			4:00P	0	End		8:35P	0.002			4:44A	0.00022		
	8:27A	0.0055		19 Sept.	1:40A	0	Began		8:40P	0.0008			4:49A	0.00022		
	8:30A	0.0055			1:44A	0.002			8:45P	0.00005			4:56A	0.000009		
	8:36A	0.0015			1:45A	0.047			9:33P	0	End		5:13A	0.000004		
	8:50A	0.0002			1:55A	0.047			4 Oct.	11:15P	0	Began		5:16A	0.0018	
	9:03A	0	End		2:02A	0.040				11:16P	0.000001			5:19A	0.0018	
5 Sept.	10:59A	0	Began		2:17A	0.040				11:19P	0.0023			5:27A	0.000014	
	11:02A	0.014			2:20A	0.050				11:23P	0.0023			5:51A	0.000002	
	11:06A	0.014			2:50A	0.0018				11:26P	0.00068			5:53A	0.00006	
	11:12A	0.0019			2:56A	0.0135				11:29P	0.00061			5:59A	0.00006	
	11:22A	0.0003			3:00A	0.0135				11:31P	0.0003			6:03A	0.000002	
	11:28A	0.0002			3:06A	0.0027				11:35P	0.00002			6:24A	0	End
	12:18P	0.0001			3:10A	0.0009			5 Oct.	1:14A	0	End	20 Oct.	1:32A	0	Began
	12:19P	0.0170			3:18A	0.0003				2:16A	0	Began		1:36A	0.00048	
	12:23P	0.0660			3:35A	0.0002				2:19A	0.0003			1:37A	0.0007	
	12:24P	0.1050			3:50A	0	End			2:22A	0.0003			1:40A	0.0018	
	12:25P	0.1050		19 Sept.	3:52P	0	Began			2:24A	0.0021			1:44A	0.0018	
	12:27P	0.0290			3:54P	0.0039				2:30A	0.0021			1:50A	0.00031	
	12:32P	0.0130			3:56P	0.0110				2:37A	0.0008			1:54A	0.00014	
	12:36P	0.0130			3:57P	0.0150				2:40A	0.0008			2:03A	0.00011	
										2:44A	0.0021			2:12A	0.000013	
										2:56A	0.0021			2:39A	0.000006	

Table 11. Continued.

Date	Time	Discharge (cfs)	Notes	Date	Time	Discharge (cfs)	Notes	Date	Time	Discharge (cfs)	Notes	Date	Time	Discharge (cfs)	Notes		
<u>1972</u>				<u>1972</u>				<u>1972</u>				<u>1972</u>					
20 Oct.	2:44A	0.00021		20 Oct.	10:24A	0.000002		28 Oct.	9:43P	0	Began	29 Oct.	7:08A	0.00011			
cont.	3:09A	0.00021		cont.	10:29A	0.0013			9:48P	0.000018		cont.	9:50A	0.00002			
	3:16A	0.000018			10:32A	0.0018			9:56P	0.000018			10:50A	0.00	End		
	3:30A	0.000017			10:33A	0.0030			9:59P	0.0150			30 Oct.	2:28P	0	Began	
	3:32A	0.00011			10:36A	0.0030			10:01P	0.0186				2:32P	0.00003		
	3:46A	0.00011			10:42A	0.00005			10:05P	0.0270	Peak			2:39P	0.00065		
	3:51A	0.00031			10:48A	0.000008			10:08P	0.0270	Peak			2:40P	0.00080		
	3:59A	0.00115			10:58A	0.000004			10:15P	0.000018				2:43P	0.00080		
	4:05A	0.00115			11:26A	0	End		10:20P	0.000012				2:52P	0	End	
	4:12A	0.00070		23 Oct.	10:26P	0	Began		10:22P	0.00011			30 Oct.	3:12P	0	Began	
	4:27A	0.00065			10:27P	0.00148			10:25P	0.00031				3:14P	0.00002		
	4:29A	0.00060			10:34P	0.0041			10:27P	0.00025				3:27P	0.00002		
	4:56A	0.00065			10:37P	0.0041			10:33P	0	End			3:30P	0	End	
	4:58A	0.00145			10:42P	0.00160			29 Oct.	12:03A	0	Began		5 Nov.	11:54P	0	Began
	5:02A	0.00180			10:48P	0.00160				12:36A	0.00011			6 Nov.	12:00M	0.00065	
	5:04A	0.0020			10:52P	0.00170				1:20A	0.0018				12:04A	0.00080	
	5:06A	0.0020			10:56P	0.00155				2:04A	0.0123				12:19A	0.00080	
	5:13A	0.0014			11:02P	0.0036				2:15A	0.0150				12:35A	0.00031	
	5:20A	0.0014			11:06P	0.0036				2:18A	0.0185	Peak			12:40A	0	End
	5:22A	0.00148			11:10P	0.0027				2:46A	0.0185			6 Nov.	2:00A	0	Began
	5:36A	0.00148			11:15P	0.0052				2:57A	0.0150				2:14A	0.00021	
	5:38A	0.00115			11:26P	0.0033				3:02A	0.0020				2:34A	0.00021	
	5:57A	0.00115			11:32P	0.0070				3:05A	0.00011				2:36A	0.00011	
	6:04A	0.00065			11:33P	0.0110				3:09A	0.000009				2:42A	0.00011	
	6:15A	0.00065			11:36P	0.0130	Peak			3:45A	0	End			2:44A	0.00021	
	6:19A	0.00031			11:37P	0.012			29 Oct.	4:16A	0	Began			2:52A	0.00065	
	6:38A	0.00029			11:40P	0.011				4:20A	0.00003				3:02A	0.00065	
	6:52A	0.00009			11:44P	0.0088				4:34A	0.00003				3:18A	0.00015	
	6:54A	0.00060			11:54P	0.0070				4:52A	0.00011				4:24A	0.00011	
	6:58A	0.00060			11:59P	0.0019				4:56A	0.00065				4:28A	0.00048	
	7:05A	0.00002			12:36A	0.00029				5:16A	0.00065				4:39A	0.00048	
	7:16A	0.000009		24 Oct.	12:38A	0.00031				5:24A	0.00115				5:03A	0.00011	
	7:45A	0	End		12:43A	0.00037				5:50A	0.00115				5:36A	0.00011	
20 Oct.	8:54A	0	Began		12:48A	0.00009				6:14A	0.0006				5:37A	0.000018	
	9:02A	0.00025			12:57A	0.00008				6:24A	0.00011				6:00A	0.000018	
	9:09A	0.00025			1:00A	0.000018				6:48A	0.00011				6:09A	0	End
	9:16A	0.00011			1:20A	0.000004				6:53A	0.00031						
	9:36A	0.00008			2:00A	0.00	End			6:56A	0.00011						
	9:52A	0.000018															

Table 11. Continued.

Date	Time	Discharge (cfs)	Notes	Date	Time	Discharge (cfs)	Notes	Date	Time	Discharge (cfs)	Notes	Date	Time	Discharge (cfs)	Notes
<u>1973</u>				<u>1973</u>				<u>1973</u>				<u>1973</u>			
12 April	9:31A	0	Began	19 April	1:52P	0	Began	28 April	9:29P	0	Began	29 April	11:56A	0.0018	
	9:36A	0.00031			1:59P	0.000058			9:30P	0.00031		cont.	12:04P	0.0014	
	9:43A	0.00031			2:33P	0.000055			9:31P	0.0018			12:11P	0.0043	
	10:24A	0	End		2:41P	0.000073			9:37P	0.00085			12:14P	0.0090	
17 April	2:13P	0	Began		6:28P	0.000055			9:44P	0.00051			12:15P	0.0253	
	2:16P	0.00045			6:32P	0.000018			10:15P	0.00023			12:17P	0.0390	
	2:19P	0.0022			6:44P	0.000011			10:39P	0.00015			12:18P	0.074	
	2:26P	0.0018			7:20P	0.000011			10:46P	0.00045			12:20P	0.0235	
	2:32P	0.00075			7:26P	0	End		11:38P	0.00031			12:22P	0.0135	
	2:40P	0.00155		20 April	4:40P	0	Began		11:54P	0	End		12:22P	0.0135	
	2:47P	0.0018			4:47P	0.00007		29 April	12:38A	0	Began		12:24P	0.0077	
	2:54P	0.00085			4:54P	0.00019			1:21A				12:29P	0.0034	
	3:02P	0.00058			5:18P	0.00011			1:29A				12:32P	0.0016	
	3:40P	0.00045			5:27P	0.00007			1:56A				12:39P	0.0012	
	3:49P	0.00038			5:34P	0.00034			2:04A				1:00P	0.0015	
	3:56P	0.00023			6:47P	0.00031			2:14A		End		1:10P	0.0015	
	4:14P	0.00015			6:55P	0.00019		29 April	6:41A	0	Began		1:17P	0.0018	
	4:43P	0.00009			7:24P	0.00023			6:49A	0.000011			1:32P	0.0014	
	5:29P	0.00011			7:32P	0.00034			6:54A	0.00027			2:17P	0.0012	
	5:37P	0.0009			7:35P	0.0018			6:58A	0.0020			2:26P	0.0051	
	7:09P	0.00023			7:41P	0.0006			7:05A	0.0014			2:47P	0.0005	
	7:17P	0.00045			7:49P	0.00045			7:14A	0.0009			4:04P	0.00035	
	7:41P	0.00045			8:17P	0.00031			7:22A	0.0008			4:21P	0.0003	
	8:20P	0.00031			8:25P	0.00023			7:41A	0.0005			4:30P	0.0002	
	8:22P	0.00027			8:32P	0.00011			7:58A	0.0005			4:40P	0.0002	
	9:00P	0.00019			9:44P	0.00011			8:04A	0.0003			6:59P	0.00007	
	10:13P	0.00011			9:52P	0.00027			8:16A	0.0003			7:23P	0	End
18 April	12:41A	0.00003			9:58P	0.00075			9:11A	0.0002		20 May	4:52P	0	Began
	1:14A	0.00004			10:07P	0.00045			9:18A	0.0001			4:53P	0.0004	
	1:46A	0	End		10:24P	0.00027			9:26A	0.0002			4:54P	0.0022	
19 April	10:44A	0	Began		11:20P	0.00015			10:03A	0.00006			5:01P	0.0016	
	10:52A	0.000014			11:28P	0.00005			10:50A	0.00003			5:13P	0.0015	
	10:59A	0.000014		21 April	12:19A	0.000018			10:52A	0.0007			7:30P	0.0015	
	11:07A	0.000055			12:28A	0.000011			10:53A	0.0003			11:30P	0.0006	
	12:02P	0.000026			1:45A	0.000009			11:00A	0.0002		21 May	7:00A	0.00011	
	1:04P	0.000014			2:01A	0	End		11:07A	0.0011			12:00N	0.00002	
	1:37P	0	End						11:25A	0.0006			4:00P	0	End
									11:49A	0.0007		25 May	4:31A	0	Began

Table 11. Continued.

Date	Time	Discharge (cfs)	Notes	Date	Time	Discharge (cfs)	Notes	Date	Time	Discharge (cfs)	Notes	Date	Time	Discharge (cfs)	Notes
<u>1973</u>				<u>1973</u>				<u>1973</u>				<u>1973</u>			
25 May	4:32A	0.00031		25 May	4:40P	0.00115		1 June	5:18P	0.0052		16 Aug.	3:50P	0	Began
cont.	4:33A	0.0020		cont.	4:46P	0.0029		cont.	5:19P	0.00115			3:51P	0.00004	
	4:36A	0.0054			4:53P	0.0032			5:26P	0.0089			3:58P	0.00090	
	4:42A	0.0030			5:02P	0.0018			5:29P	0.0045			4:06P	0.0007	
	4:55A	0.0018			5:23P	0.00127			5:36P	0.0045			4:13P	0.0004	
	5:19A	0.0015			7:23P	0.00665			5:43P	0.0027			4:29P	0.00035	
	5:27A	0.0014			7:44P	0.0014			5:51P	0.0023			4:45P	0.00028	
	5:34A	0.0023			7:52P	0.00095			6:05P	0.0019			5:25P	0.00022	
	5:41A	0.0016			7:59P	0.0047			6:13P	0.0015			5:48P	0.00011	
	5:49A	0.0016			8:07P	0.0039			6:36P	0.0014			6:20P	0.0001	
	5:57A	0.0085			8:14P	0.0034			6:50P	0	End		6:58P	0.00006	
	6:24A	0.0021			8:37P	0.0070		19 July	12:08P	0	Began		7:06P	0.000022	
	6:32A	0.0039			8:46P	0.0077			12:13P	0.106			8:36P	0.00001	
	6:49A	0.0034			8:58P	0.0056			12:14P	0.0526			8:58P	0	End
	6:52A	0.0073			9:07P	0.0039			12:15P	0.106		31 Aug.	11:08P	0	Began
	7:00A	0.0062			9:16P	0.0032			12:26P	0.0254			11:11P	0.000043	
	7:07A	0.0055			9:34P	0.0029			12:28P	0.0147			11:19P	0.0007	
	7:31A	0.0052			9:43P	0.0023			12:35P	0.025			11:34P	0.0005	
	7:38A	0.0029			9:50P	0.0023			12:42P	0.0171			11:42P	0	End
	7:42A	0.0023			10:05P	0.00167			12:48P	0.0118					
	7:50A	0.0025			10:24P	0.0014			12:53P	0.0043		1 Sept.	12:43A	0	Began
	8:01A	0.0015			10:32P	0.00127			1:01P	0.0044			12:48A	0.00065	
	8:32A	0.0013			10:40P	0.00095			1:08P	0.0033			12:55A	0.00002	
	10:17A	0.0009			10:53P	0.00060			1:16P	0.0019			1:00A	0	End
	11:17A	0.0009		26 May	12:06A	0.00065			1:23P	0.0029		1 Sept.	5:35A	0	Began
	11:33A	0.0018			12:32A	0.00049			1:31P	0.0020			6:07A	0.00023	
	11:51A	0.0018			12:58A	0.00037			1:39P	0.0016			6:09A	0.0183	
	12:01P	0.0012			2:47A	0.00031			2:31P	0.0014			6:11A	0.064	
	12:07P	0.0029			2:51A	0.00167			2:40P	0.0012			6:15A	0.140	
	12:11P	0.0165			2:53A	0.0052			3:45P	0.0011			6:16A	0.105	
	12:15P	0.0088			3:01A	0.0029			4:08P	0.0009			6:18A	0.043	
	12:17P	0.0039			3:13A	0.00127			6:27P	0.0007			6:22A	0.004	
	12:28P	0.0015			4:44A	0.0095			6:35P	0	End		6:31A	0.0009	
	12:37P	0.0014			4:50A	0.0023							6:46A	0.00043	
	12:44P	0.0022			4:58A	0.00167		19 July	6:35P	0	Began		6:52A	0.00090	
	1:01P	0.0025			5:05A	0.00127			6:37P	0.0024			7:03A	0.00065	
	1:08P	0.00167			5:28A	0.0009			6:38P	0.0070			7:26A	0.00049	
	1:25P	0.0014			7:42A	0.0009			6:40P	0.0030			7:29A	0.0027	
	1:34P	0.00095			7:44A	0	End		6:47P	0.0021			7:36A	0.0035	
	2:16P	0.00127		1 June	5:11P	0	Began		7:37P	0.0021			7:43A	0.0010	
	4:16P	0.00095							11:00P	0	End				

Table 11. Continued.

Date	Time	Discharge (cfs)	Notes	Date	Time	Discharge (cfs)	Notes	Date	Time	Discharge (cfs)	Notes	Date	Time	Discharge (cfs)	Notes
<u>1973</u>				<u>1973</u>				<u>1973</u>				<u>1973</u>			
1 Sept. cont.	7:44A	0.0009		2 Sept. cont.	1:13A	0.0007		23 Sept. cont.	1:44P	0.0002		25 Sept. cont.	9:16A	0.0006	
	7:50A	0.0007			1:32A	0	End		2:32P	0.0001			9:40A	0.0005	
	8:05A	0.0005							2:48P	0.00003			11:14A	0.0003	
	8:07A	0.0024		23 Sept.	7:57A	0	Began		2:56P	0.00002			11:38A	0.0002	
	8:15A	0.0016			7:58A				3:05P	0.00002			12:03P	0.00015	
	8:29A	0.0007			7:59A				3:13P	0.00001			12:10P	0.00011	
	8:55A	0.0005			8:05A				3:32P	0	End		12:50P	0.00015	
	9:02A	0.0005			8:10A						Began		1:35P	0.00014	
	9:29A	0.0003			8:15A			25 Sept.	1:23A	0			4:00P	0	End
	10:01A	0.0004			8:21A				1:24A	0.0005					
	10:05A	0.0018			8:27A	0.0030			1:25A	0.0020		8 Oct.	2:24P	0	Began
	10:13A	0.0012			8:31A	0.0072			1:32A	0.0016			2:26P	0.0017	
	10:23A	0.0008			8:36A	0.0039			1:40A	0.0014			2:34P	0.0027	
	10:35A	0.0005			8:43A	0.0021			1:47A	0.0090			2:41P	0.0033	
	11:40A	0.0004			8:50A	0.0030			1:54A	0.0018			2:48P	0.0020	
	12:07P	0.0003			8:53A	0.0070			2:01A	0.0012			2:54P	0.0008	
	12:46P	0.0003			8:56A	0.0135			2:10A	0.0090			3:02P	0.0006	
	12:48P	0.0018			9:00A	0.0315	Peak		2:19A	0.0070			3:11P	0.0004	
	12:55P	0.0012			9:01A	0.0220			2:50A	0.0006			3:19P	0.0011	
	1:02P	0.0007			9:05A	0.0130			3:54A	0.0005			3:27P	0.00065	
	1:02P	0.0004			9:07A	0.0065			4:28A	0.0004			3:43P	0.00042	
	3:42P	0.0003			9:11A	0.0027			4:35A	0.0008			4:05P	0.0003	
	5:09P	0.0002			9:18A	0.0027			4:42A	0.0012			5:10P	0.0002	
	6:05P	0.0002			9:22A	0.0068			4:50A	0.0090			5:54P	0.00007	
	6:13P	0.0005			9:24A	0.0120			4:58A	0.0090			10:08P	0.00001	
	6:15P	0.0025			9:27A	0.0200			5:05A	0.0012			10:16P	0	End
	6:22P	0.0039			9:29A	0.0125			5:13A	0.0014					
	6:28P	0.0016			9:34A	0.0070			5:21A	0.0090		23 Oct.	4:28P	0	Began
	6:37P	0.0007			9:41A	0.0052			5:29A	0.0070			4:29P	0.00024	
	7:03P	0.0004			9:49A	0.0046			5:57A	0.0006			4:31P	0.0015	
	7:20P	0.0004			9:57A	0.0040			7:37A	0.0006			4:46P	0.0014	
	7:29P	0.0005			10:04A	0.0025			7:42A	0.0018			4:54P	0.0012	
2 Sept.	12:10A	0	End		10:10A	0.0010			7:43A	0.0014			5:02P	0.0007	
					10:17A	0.0009			7:58A	0.0012			5:58P	0.0005	
2 Sept.	12:10A	0	Began		10:43A	0.0006			8:05A	0.0016			6:31P	0.0004	
	12:16A	0.00055			12:03P	0.0007			8:13A	0.0015			6:58P	0.0003	
	12:25A	0.00070			12:28P	0.0006			8:21A	0.0012			7:38P	0.0002	
	12:33A	0.00085			12:53P	0.0005			8:28A	0.0008		24 Oct.	12:30A	0	End
	12:40A	0.0016			1:18P	0.0003			8:52A	0.0006					
	12:47A	0.0009			1:37P	0.0003									

Table 12. Runoff measured in Parleys site sump flume (PW-2) with date of event, time of starting, change of flow rate, and ending with flow rates during each time period 1972-1973.

Date	Time	Notes	Chart Depth (in.)	Discharge (cfs)	Date	Time	Notes	Chart Depth (in.)	Discharge (cfs)
<u>1972</u>					<u>1972</u>				
13 Aug.	8:45P	Began	0	0	25 May cont.	4:38A		0.15	0.109
	8:52P		0.85	1.05		4:57A		0.15	0.109
	9:19P	End	0	0		5:02A		0.10	0.077
5 Sept.	12:18P	Began	0	0		5:12A		0.10	0.077
	12:19P		0.38	0.343		5:15A		0.15	0.109
	12:22P		0.18	0.129		5:22A		0.08	0.063
	12:28P		0.23	0.165		5:28A		0.10	0.077
	1:06P	End	0	0		5:37A		0.10	0.077
19 Sept.	1:40A	Began	0	0		5:50A		0.05	0.041
	1:41A		0.36	0.320		6:08A	End	0	0
	1:59A		0.12	0.090					
	2:14A		0.20	0.140		10:05A	Began	0	0
	2:40A		0.05	0.041		10:15A		0.07	0.056
	3:16A		0.08	0.063		10:40A		0.07	0.056
	3:56A		0.06	0.049		10:50A		0.01	0.0085
	4:16A		0.09	0.069		11:25A		0.01	0.0085
	5:14A	End	0	0		11:29A		0.05	0.041
19 Sept.	3:52P	Began	0	0		11:38A	End	0	0
	3:54P		0.20	0.140	25 May	4:10P	Began	0	0
	3:58P	End	0	0		4:25P		0.03	0.026
29 Oct.	12:05P	Began	0	0		6:40P		0.03	0.026
	12:41P		0.60	0.66		6:43P		0	0
	12:55P		0.65	0.73		7:45P		0	0
	1:20P		0.70	0.81		7:48P		0.08	0.063
	1:45P		0.77	0.92		7:58P		0.04	0.034
	2:15P		0.75	0.88		8:03P		0.09	0.069
	2:45P		0.20	0.140		8:10P	End	0	0
	2:55P		0.40	0.375	1 June	5:17P	Began	0	0
	3:35P		0.17	0.122		5:21P		0.22	0.154
	3:40P		0.27	0.206		5:40P		0.13	0.097
	3:48P	End	0	0		5:44P		0.20	0.140
25 May	4:15A	Began	0	0		5:53P		0.20	0.140
	4:17A		0.40	0.375		5:57P		0.31	0.260
	4:21A		0.40	0.375		6:03P	End	0	0
	4:30A		0.20	0.140	13 July	11:23A	Began	0	0
						11:25A		0.18	0.129
						11:30A		0.32	0.269
						11:32A		0.57	0.62

Table 12. Continued.

Date	Time	Notes	Chart Depth (in.)	Discharge (cfs)	Date	Time	Notes	Chart Depth (in.)	Discharge (cfs)
<u>1972</u>					<u>1973</u>				
13 July	11:34A		0.48	0.480	16 Aug.	3:48P		0.30	0.245
cont.	11:35A		0.50	0.507	cont.	3:51P		0.45	0.440
	11:38A		0.20	0.140		3:59P		0.55	0.58
	11:43A		0.14	0.103		4:08P		0.45	0.440
	11:47A		0.14	0.103		5:00P		0.35	0.305
	11:48A		0.17	0.122		7:15P		0.25	0.185
	12:58P		0.17	0.122		9:00P	End	0	0
	1:03P		0.03	0.026	1 Sept.	6:10A	Began	J	0
	1:10P	End	0	0		6:18A		0.15	0.109
<u>1973</u>						6:19A		0	0
13 July	8:43P	Began	0	0		6:20A		0.18	0.129
	8:47P		0.05	0.041		6:25A		0.36	0.320
	8:49P		0.05	0.041		6:27A		0.60	0.66
	8:50P		0.14	0.103		6:28A		0.70	0.81
	8:53P		0.14	0.103		6:30A		0.50	0.507
	8:55P		0.45	0.440		6:40A		0.51	0.53
	8:59P		0.14	0.103		6:53A		0.40	0.375
	9:03P		0.01	0.0085		7:01A		0.25	0.185
	9:07P		0.06	0.049		7:06A		0.25	0.185
	9:09P		0.03	0.026		7:15A		0.20	0.140
	9:14P		0	0		7:21A	End	0	0
	9:37P		0	0	23 Sept.	7:49A	Began	0	0
	9:46P		0.10	0.077		7:53A		0.15	0.109
	9:51P	End	0	0		7:57A		0.18	0.129
14 July	9:18P	Began	0	0		7:59A		0.74	0.87
	9:23P		0.12	0.090		8:02A		0.45	0.440
	9:28P		0.11	0.083		8:06A		0.38	0.343
	9:33P		0.19	0.135		8:12A		0.22	0.154
	9:35P		0.34	0.290		8:16A		0.24	0.175
	9:38P		0.25	0.185		8:18A		0.49	0.495
	9:52P		0.15	0.109		8:22A		0.45	0.440
	10:24P		0.13	0.097		8:28A		0.15	0.109
	10:29P		0.13	0.097		8:32A		0.18	0.129
	10:33P		0.08	0.063		8:36A		0.18	0.129
	10:48P		0.01	0.0085		8:52A		0.03	0.026
	12:00M	End	0	0		9:02A		0.05	0.041
16 Aug.	3:36P	Began	0	0		9:06A		0.07	0.056
	3:40P		0.55	0.58		9:10A		0.00	0
	3:41P		1.85	3.20		9:14A		0.05	0.041
	3:45P		0.90	1.15					

Table 12. Continued.

Date	Time	Notes	Chart Depth (in.)	Discharge (cfs)	Date	Time	Notes	Chart Depth (in.)	Discharge (cfs)
<u>1973</u>					<u>1973</u>				
23 Sept.	9:34A		0.00	0	23 Oct.	3:13P	Began	0	0
cont.	9:37A		0.12	0.090		3:14P		0.87	1.09
	9:40A		0.19	0.135		3:18P		0.96	1.25
	10:06A		0.06	0.049		3:20P		1.03	1.38
	11:12A		0.37	0.330		3:22P		0.92	1.19
	11:22A		0.36	0.320		3:25P		0.98	1.30
	11:58A		0.25	0.185		3:29P		0.90	1.15
	12:10P		0.25	0.185		3:47P		0.91	1.17
	12:15P		0.28	0.216		4:01P		0.77	0.92
	12:30P		0.28	0.216		4:19P		0.60	0.66
	12:50P		0.25	0.185		4:25P		0.59	0.62
	1:12P		0.34	0.290		4:31P		0.56	0.60
	1:14P		0.30	0.245		4:34P		0.49	0.495
	1:21P		0.08	0.063		4:38P		0.44	0.423
	1:40P	End	0	0		4:40P		0.47	0.465
25 Sept.		Recorder Disturbed				4:58P		0.29	0.229
8 Oct.	2:17P	Began	0	0		5:02P		0.30	0.245
	2:25P		0.11	0.083		5:05P	End	0	0
	2:43P		0.21	0.146					
	2:45P		0.19	0.135					
	2:51P		0.27	0.206					
	2:57P		0.30	0.245					
	3:00P		0.27	0.206					
	3:22P		0.30	0.245					
	3:25P		0.23	0.165					
	3:29P		0.21	0.146					
	3:36P		0.23	0.165					
	3:37P		0.24	0.175					
	3:39P		0.25	0.185					
	3:58P		0.28	0.216					
	4:00P		0.28	0.216					
	4:05P		0.18	1.29					
	4:09P		0.17	0.122					
	4:11P		0.15	0.109					
	4:13P		0.14	0.103					
	4:22P		0.12	0.090					
	4:25P		0.04	0.034					
	4:32P	End	0	0					

Table 13. Minimum and maximum temperature during runoff events at Parleys site.

Date	Runoff Time		Temperature (°F)	
	Start	End	Max.	Min.
1972				
13 Aug.	8:46P	9:00P	NR*	NR
2 Sept.	9:02P	9:48P	NR	NR
5 Sept.	8:24A	9:03A	60	58
5 Sept.	10:59A	3:07P	54	52
5 Sept.	3:07P	4:00P	54	52
19 Sept.	1:40A	3:50A	56	52
19 Sept.	3:52P	4:32P	54	52
4 Oct.	8:14P	9:23P	49	46
4-5 Oct.	11:15P	1:14A	49	48
9 Oct.	2:16A	6:32A	45	44
10 Oct.	3:12A	6:24A	50	43
20 Oct.	1:32A	7:45A	54	45
20 Oct.	8:54A	11:26A	54	45
23-24 Oct.	10:26P	2:00A	43	40
28 Oct.	9:43P	10:33P	36	28
29 Oct.	12:03A	3:45A	29	26
29 Oct.	4:16A	10:50A	28	26
30 Oct.	2:28P	2:52P	32	26
30 Oct.	3:12P	3:30P	40	21
5-6 Nov.	11:54P	6:09A	32	27
1973				
12 April	9:31A	10:24A	NR	NR
17-18 April	2:13P	1:46A	89	68
19 April	10:44A	1:37P	90	85
19 April	1:52P	7:26P	90	74
20-21 April	4:40P	2:01A	68	66
28 April	9:29P	11:54P	66	58
29 April	12:38A	2:14A	77	68
29 April	6:41A	7:23P	84	68
20-21 May	4:52P	4:00P	69	60
25-26 May	4:31A	7:44A	59	57
1 June	5:11P	6:50P	62	61
19 July	12:08P	6:35P	80	67
19 July	6:35P	11:00P	71	65
16 Aug.	3:50P	8:58P	70	48
31 Aug.	11:08P	11:42P	NR	NR
1 Sept.	12:43A	1:00A	NR	NR
1-2 Sept.	5:35A	12:10A	NR	NR
2 Sept.	12:10A	1:32A	NR	NR
23 Sept.	7:57A	3:32P	89	42
25 Sept.	1:23A	4:00P	66	44
8 Oct.	2:24P	10:16P	30	26
23-24 Oct.	4:28P	12:30A	35	26

Note: *NR = no record

Table 14. Maximum and minimum wind speed and direction during runoff events at Parleys site, 1972-1973.

Date	Runoff Time		Wind		
	Begin	End	Speed (miles/hr)		Direction
			Max.	Min.	
1972					
13 Aug.	8:46P	9:00P	NR*	NR	
2 Sept.	9:20P	9:48P	9	2	SSW
5 Sept.	8:24A	9:03A	3	2	SSE
5 Sept.	10:59A	3:07P	7	4	NE
5 Sept.	3:07P	4:00P	7	4	NE
19 Sept.	1:40P	3:50A	5	3	NNE
19 Sept.	3:52P	4:32P	7	2	NNE
4 Oct.	8:14P	9:23P	8	3	NNE
4-5 Oct.	11:15P	1:14A	5	2	NE
9 Oct.	2:16A	6:32A	17	2	ESE
10 Oct.	3:12A	6:24A	12	2	S
20 Oct.	1:32A	11:26A	6	2	S
23-24 Oct.	10:26P	2:00A	NR	NR	NR
28 Oct.	9:43P	10:33A	20	3	SSW
29 Oct.	12:03A	10:50A	2	2	S
30 Oct.	2:28P	3:30P	9	2	S
5-6 Nov.	11:54P	6:09A	4	2	S
1973					
12 April	9:31A	10:24A	7	5	SW
17-18 April	2:13P	1:46A	6	3	NNE
19 April	10:44A	1:37P	8	2	NNE
19 April	1:52P	7:26P	5	2	NE
20-21 April	4:40P	2:01A	4	2	NNE
28 April	9:29P	11:54P	8	2	NNE
29 April	12:38A	2:14A	7	5	NE
29 April	6:41A	7:23P	5	2	S
20-21 May	4:52P	4:00P	11	2	NE
25-26 May	4:31A	7:44A	10	2	E
1 June	5:11P	6:50P	4	2	S
19 July	12:08P	6:35P	NR	NR	NR
19 July	6:35P	11:00P	NR	NR	NR
16 Aug.	3:50P	8:58P	19	4	NE
31 Aug.	11:08P	11:42P	6	2	NNE
1-2 Sept.	12:43A	12:10A	11	1	NE
2 Sept.	12:10A	1:32A	5	2	NE
23 Sept.	7:57A	3:32P	9	2	SSE
25 Sept.	1:23A	4:00P	8	3	NE
8 Oct.	2:24P	10:16P	16	3	NNE
23-24 Oct.	4:28P	12:30A	18	2	NNE

Note: *NR = no record

Table 15. Soil moisture in the Parleys site at the beginning of the runoff events during 1973.

Date	Soil Moisture Content (%) at Depth		
	0-6"	6-12"	12-24"
1973			
19 July	6.86	6.07	9.62
16 Aug.	3.58	4.12	2.17
31 Aug.	3.58	4.12	2.17
1-2 Sept.	3.58	4.12	2.17
23 Sept.	12.98	12.26	14.05
25 Sept.	3.92	4.14	1.50
8 Oct.	19.77	16.76	14.07
23-24 Oct.	7.67	12.49	10.39

HYETOGRAPHS AND HYDROGRAPHS FOR MAJOR STORMS

For comparison, hyetographs and the corresponding hydrographs for major storms producing flows greater than an arbitrary 0.025 cfs at the gage are plotted. There were about 10 major storms on each site. Ten major storms at Layton site are shown in Figures 19 through 28 and those at Parleys site are shown in Figures 29 through 38. The year 1972 was very dry and no measurable storm was recorded until late in the summer. The first major storm occurred on September 5, 1972, at both sites. A comparison of the hyetographs and hydrographs reveals that a similarity in pattern exists among the hyetographs and hence the corresponding hydrographs plotted at each site. Physiographically both sites are in the same Salt Lake City region but in different portions of the region so they are somewhat different. These differences manifest themselves in precipitation and runoff patterns measured at both sites.

Runoff from the highway watershed at Layton site, as shown in Figure 1(a) is composed of two overland flows, one from an impervious roadway and the other from a grass-covered sideslope. The two overland flows meet at a gutter where storm water collects from both sides and flows downstream to the inlet. At Parleys site, on the other hand, these areas are two different watersheds: Parleys site number 1 is a sideslope with a gutter and Parleys site number 2 is a four-lane roadway with a curb gutter as shown in Figures 1(b) and 1(c), respectively. An inspection of Figures 29 through 38 reveals that runoff rate from the roadway appears many times higher than that from the sideslope. Such a big difference in the runoff rate between the roadway and the sideslope is probably caused by the substantial amount of precipitation lost to infiltration, grass interception, and depression storage on the sideslope. It is conceivable that precipitation from storms of mild intensity and short duration may be entirely depleted by interception and infiltration.

In view of relatively small portion of the total runoff from the sideslope at Parleys site, the inlet hydrographs at Layton site for most of the rainfall events with the exception of prolonged ones, can be said to be contributed mostly by runoff from the roadway. A question may arise, however, as to the accuracy of the hydrographs measured, especially during traffic hour storms. As mentioned previously, the splash from traffic appeared to be a sizable

portion of runoff lost from the roadway. Adding to this problem was the electronic instability of the water level recorder for the inlet flume at Parleys site number 2. Because of these two main sources of problems, some of the runoff discharges at Parleys site number 2 such as occurred on October 4, 1972 (Figure 31), April 29, 1973 (Figure 32), and July 19, 1973 (Figure 33), could not be measured.

Seven Belfort rain gages, in addition to six Truchek rain gages, were installed for each site on drainage area of less than 0.1 square miles. Despite such dense precipitation measuring points on the areas, the amount of precipitation recorded varies from one gage to another, especially under low intensity storms (see Figures 23 and 25). Sometimes, there was even no record of rain at some gages for the same rainfall event. For example, Table 16 shows that no measurable rain was recorded at gage L-4 on May 25-26, 1973, at Layton site (Figure 25), at gage P-5 on October 4, 1972, at Parleys site (Figure 31), at gages P-1, P-2, and P-3 on August 16, 1973, at Parleys site (Figure 34), and at gages P-1 and P-5 on October 8, 1973, at Parleys site (Figure 37). Because a calibration check on the rain gages was made on a monthly basis and mechanical clocks were checked every week, it is unlikely that the variability of rainfall data recorded was caused by a malfunction of the gages and recorders.

The nature of temporal and spatial variations in storm patterns over the urban highway watersheds manifested itself on the rainfall data recorded. Despite the complexity in storm patterns, as shown in Figures 19 through 38, the inlet hydrographs in response to the major storm inputs at Layton site look very similar to each other, namely all suddenly rise to the peak and then gradually taper off in the receding stage. The longer base of the hydrographs at Layton indicates the basin lag to be longer than at either Parleys watershed and the more complicated pattern of flow sequencing by the timing of the flow from the pavement to the central gutter and from the sideslope to the central gutter where they join to continue to the gage at LW-1. An analogous hydrograph might be obtained by incrementally adding the hydrographs of PW-1 and PW-2 at the Parleys site.

A further analysis of the hyetographs and hydrographs is not attempted in this report, but will be made, if necessary, in the other phase of research.

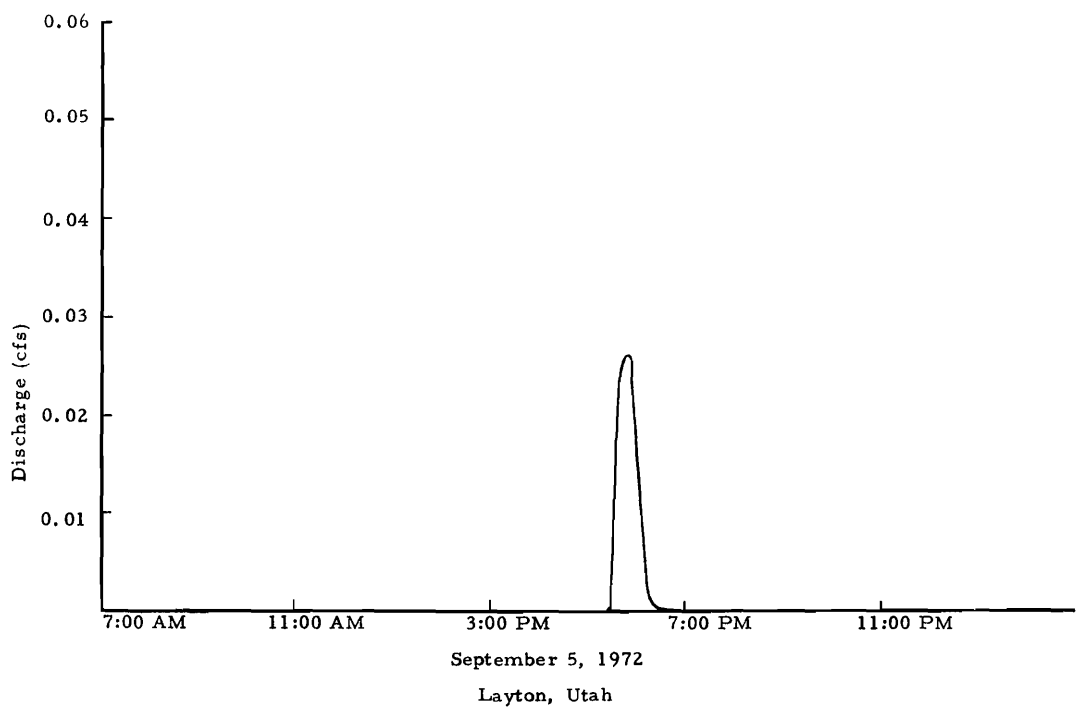
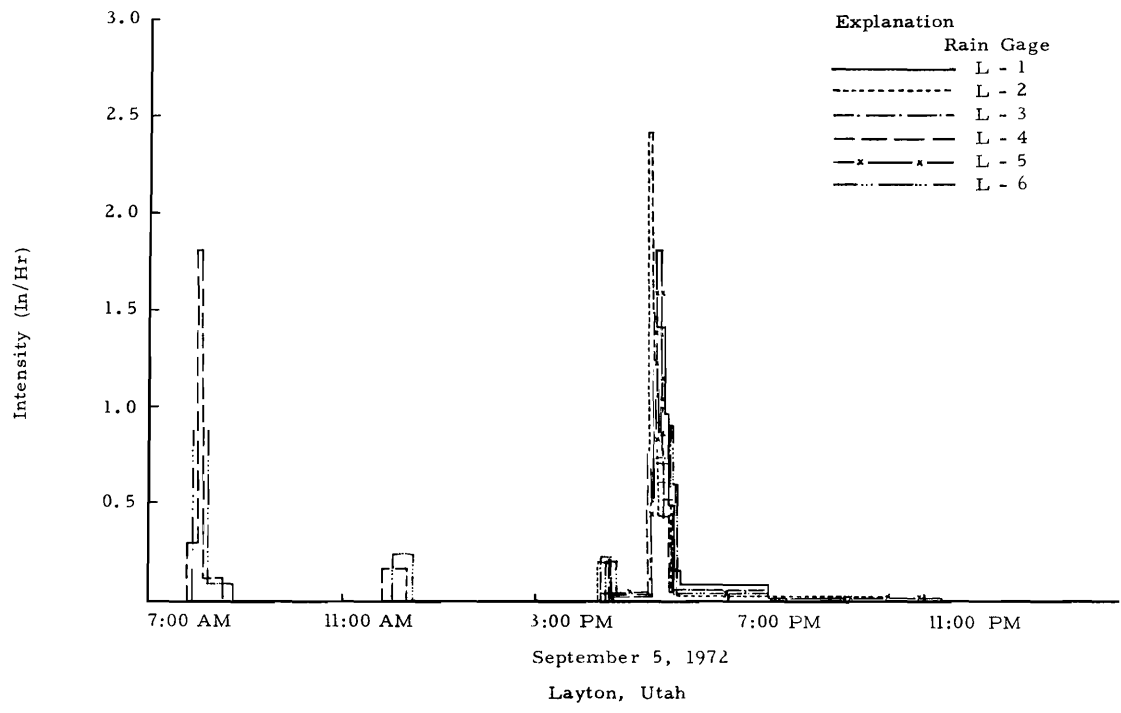

Figure 19. September 5, 1972 storm at Layton site.

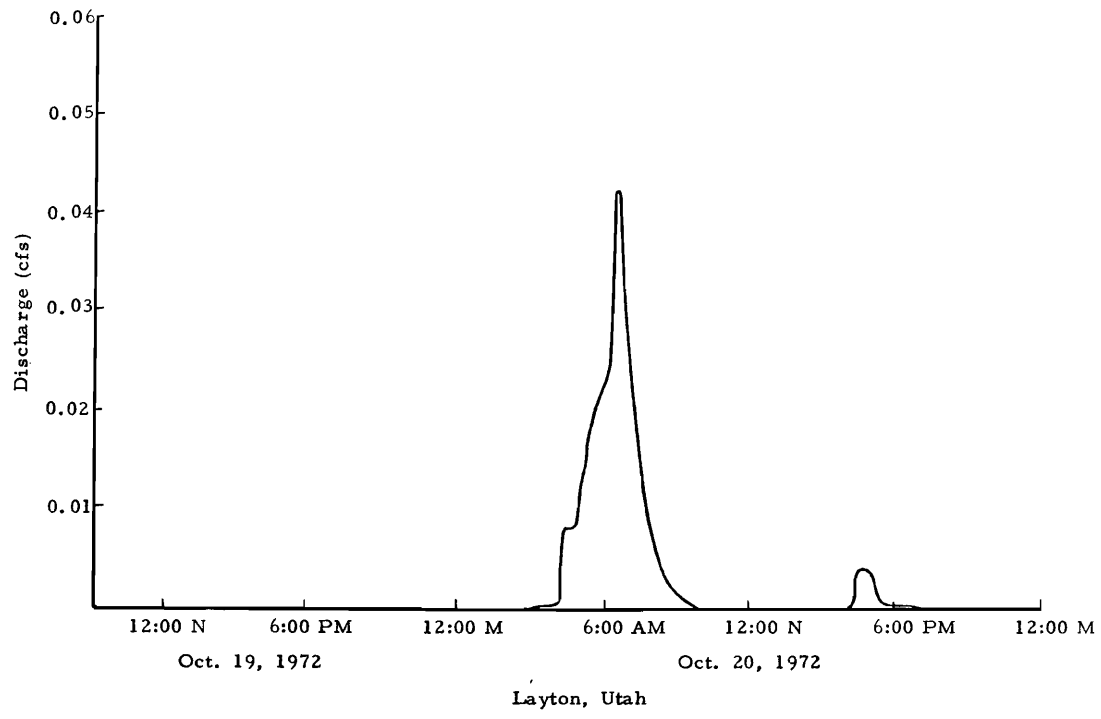
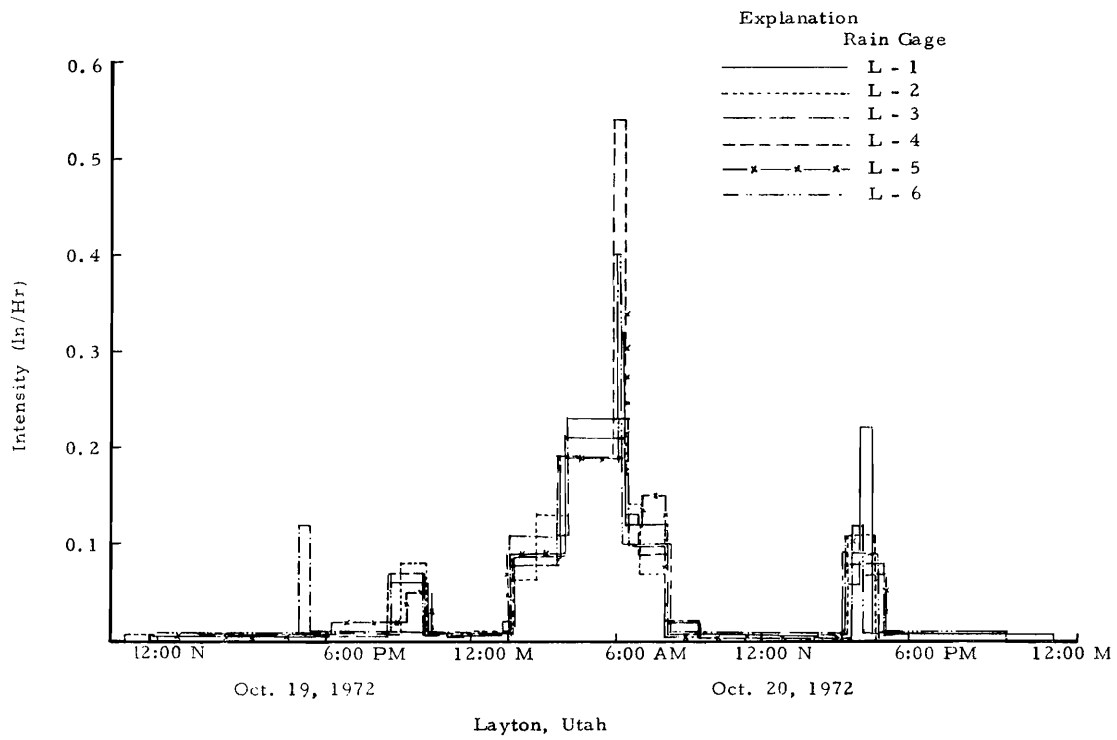

Figure 20. October 19-20, 1972 storm at Layton site.

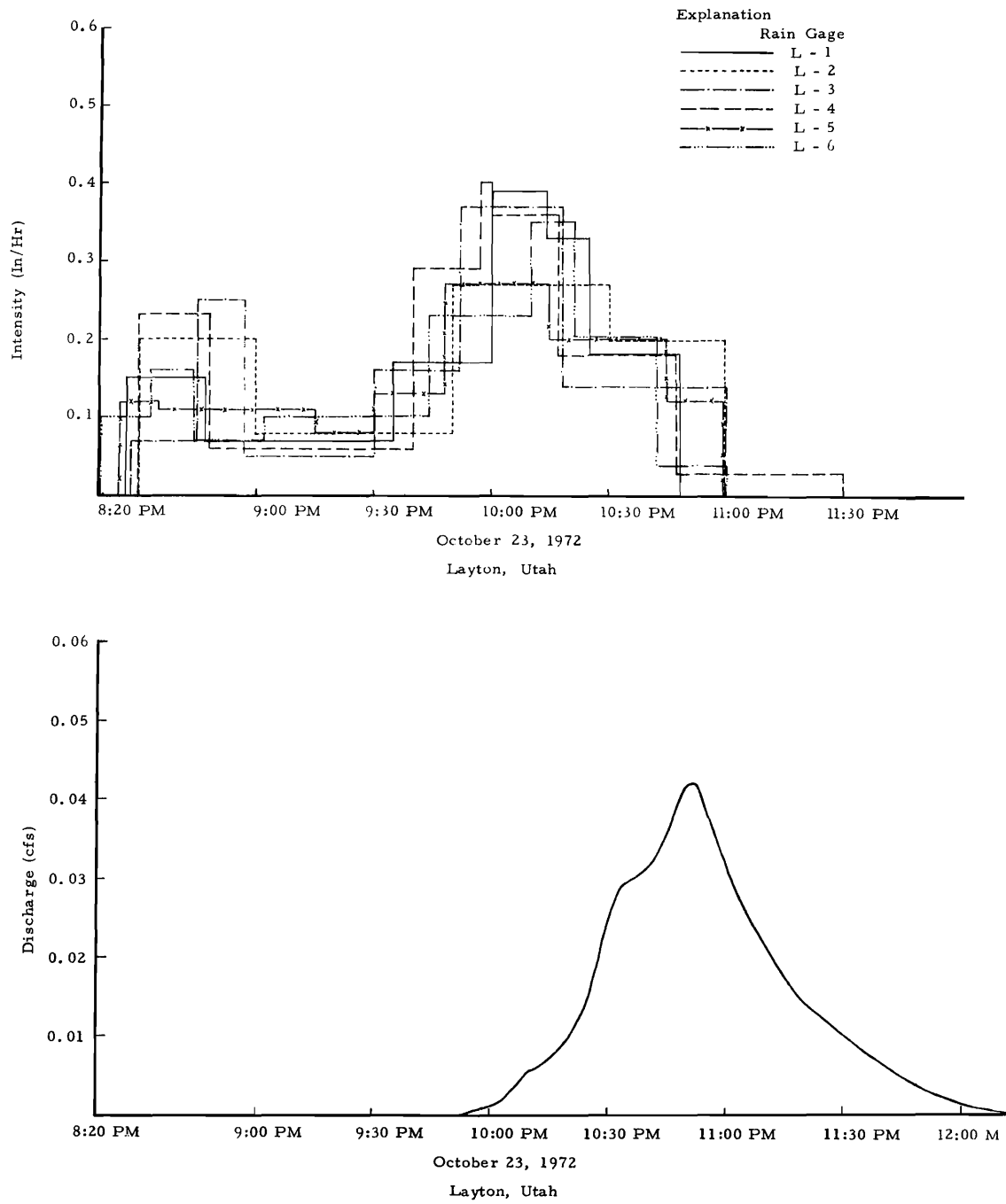

Figure 21. October 23, 1972 storm at Layton site.

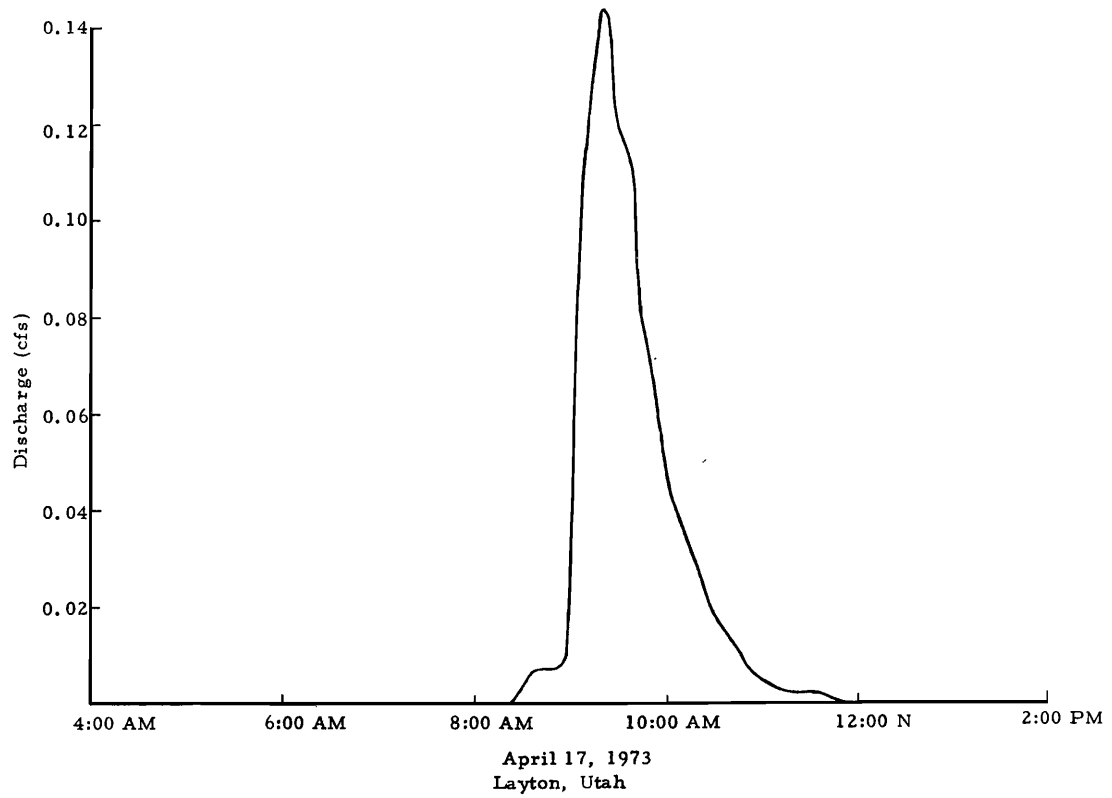
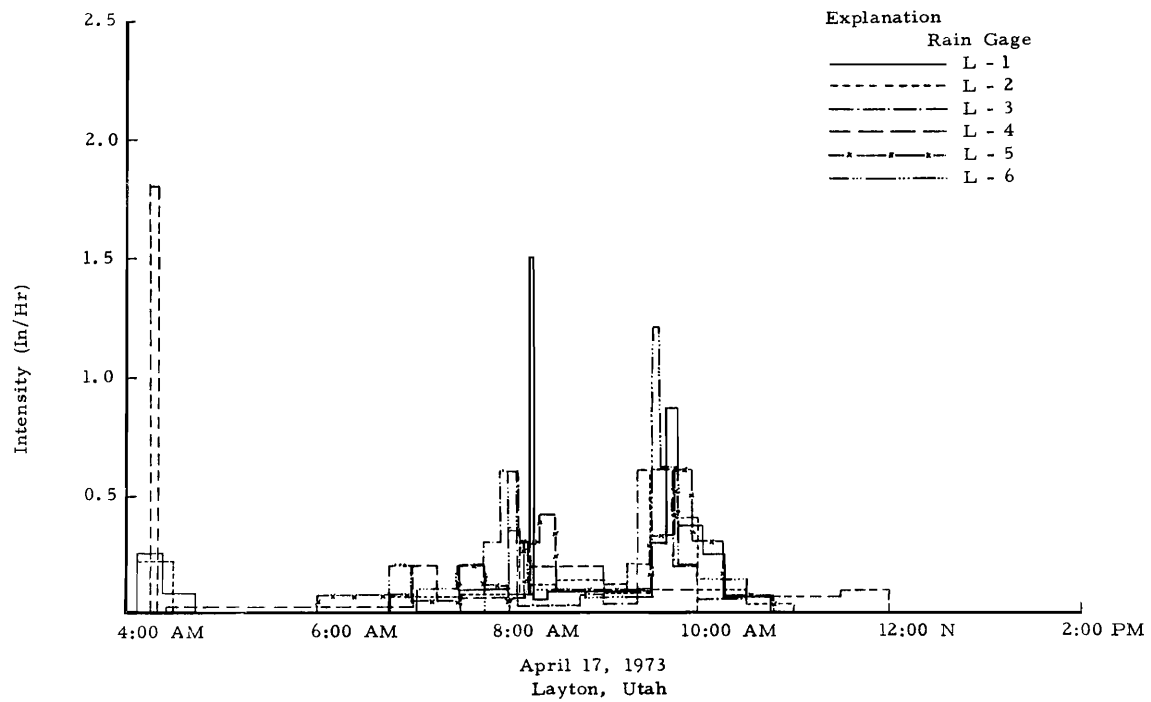

Figure 22. April 17, 1973 (AM) storm at Layton site.

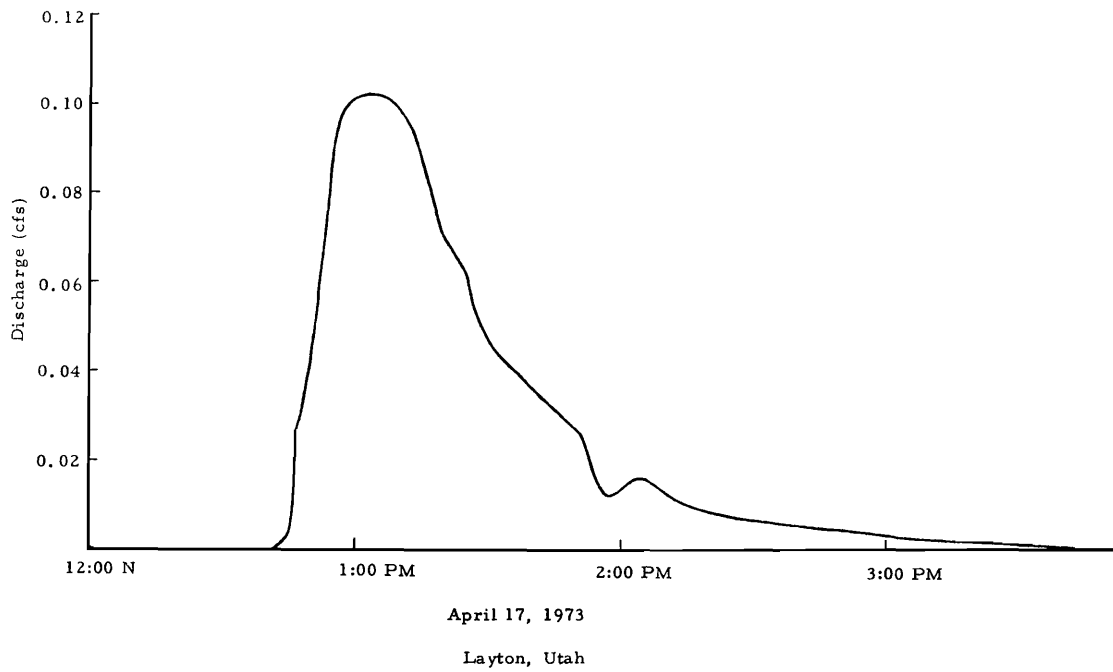
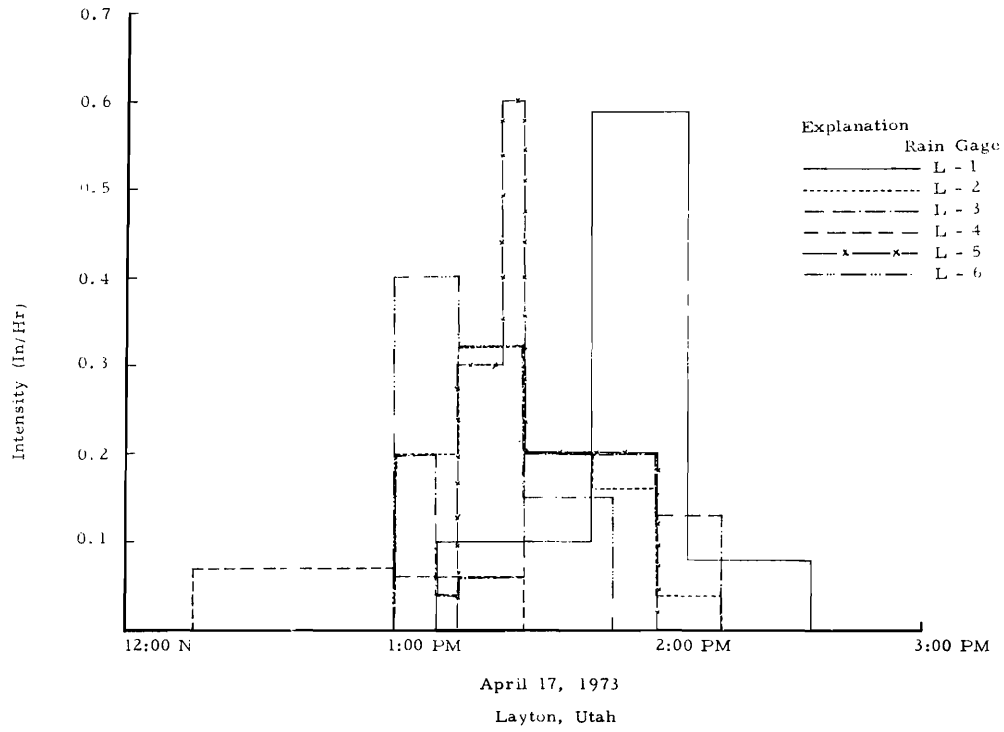

Figure 23. April 17, 1973 (PM) storm at Layton site.

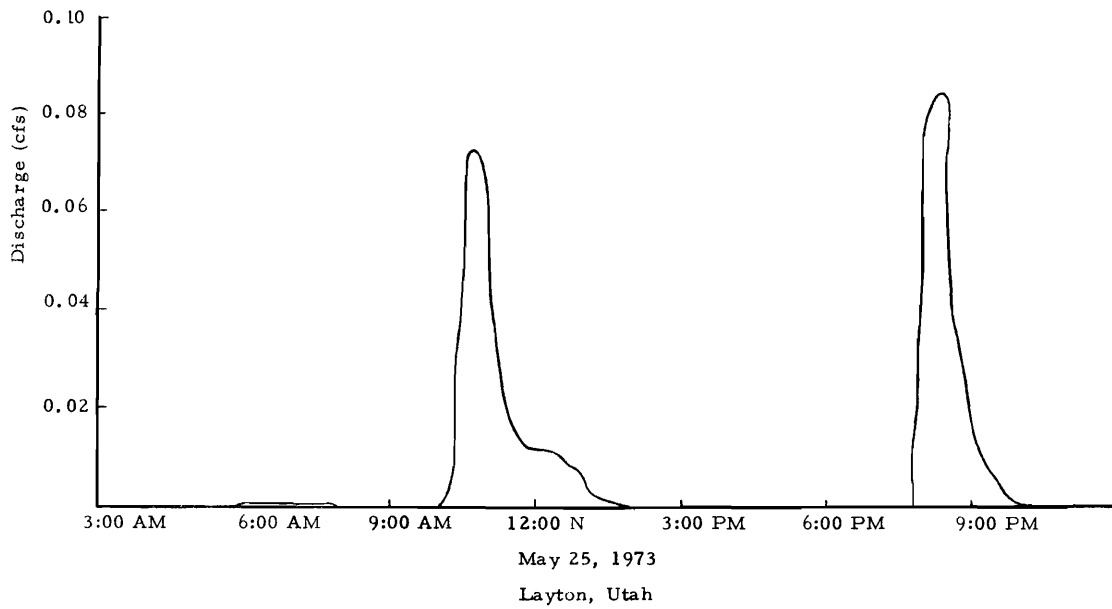
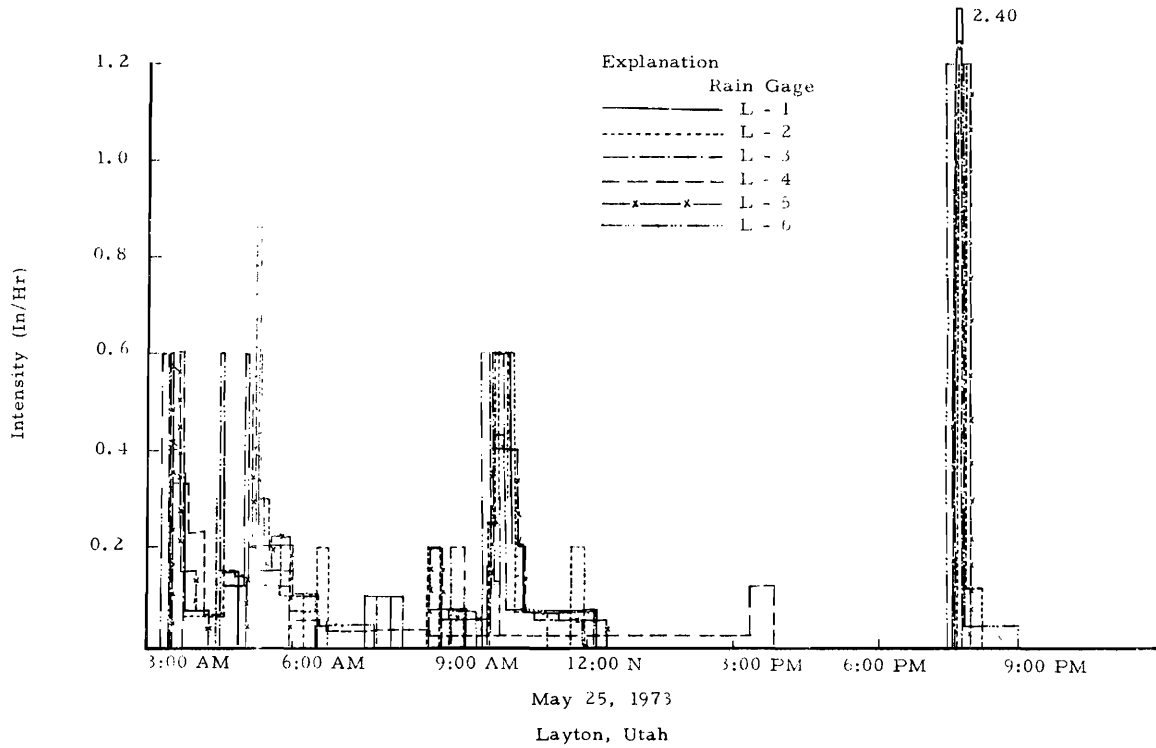

Figure 24. May 25, 1973 storm at Layton site.

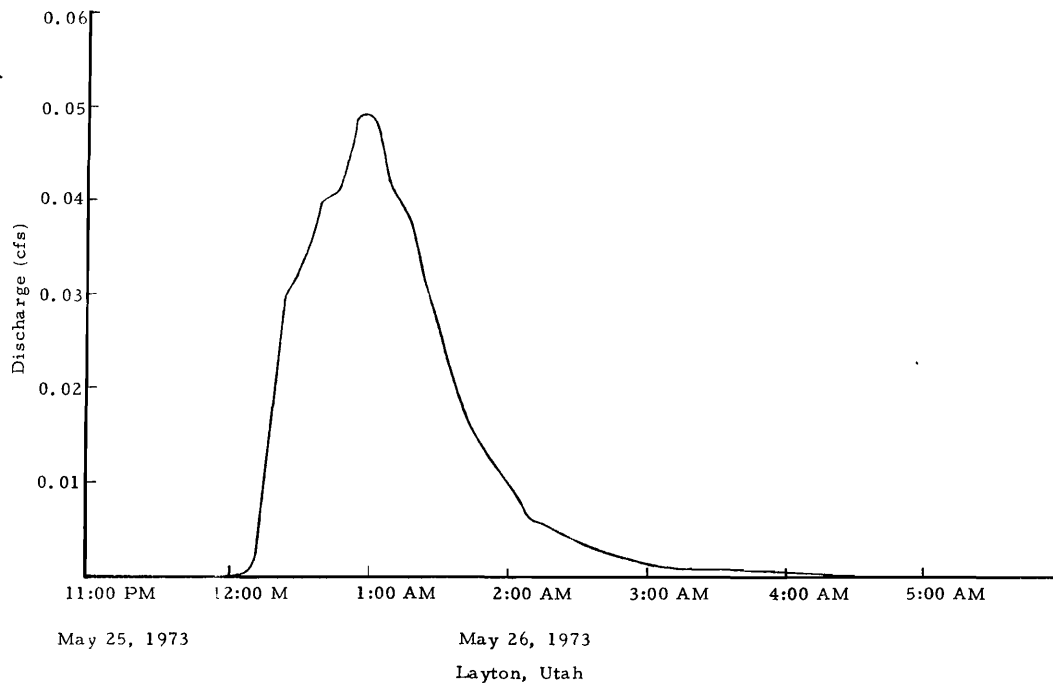
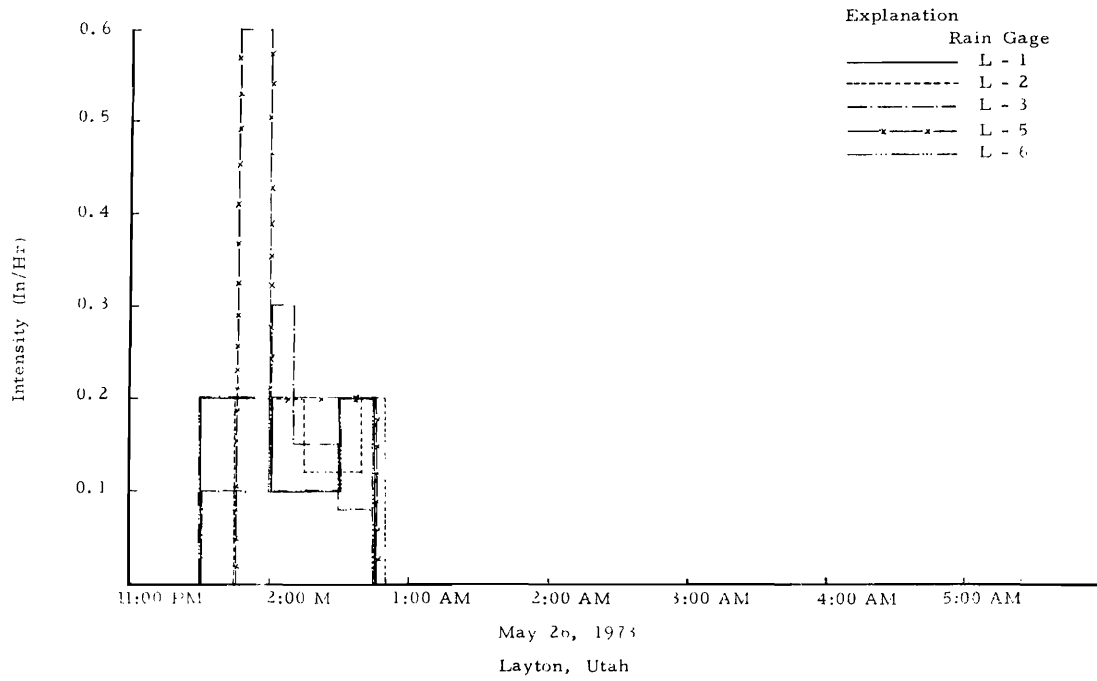

Figure 25. May 25-26, 1973 storm at Layton site.

EVALUATION OF WATERSHED RETENTION

Watershed retention may be evaluated with the same accuracy as streamflow or precipitation from an event on the drainages by first estimating the mass or accumulative retention. Beginning with the Parleys event of October 4-5, 1972, on drainage site No. 1 which drains a sideslope the next six steps may be followed:

1. Plot the mass rainfall curve for each precipitation gage beginning with the gage where precipitation first began (gage No. 3 at 7:53 PM) and continuing through gage No. 1 (precipitation at 7:55 PM). The net mass rainfall input curve is made by taking the mean at each of the 5 minute intervals from the beginning of rainfall on the first gage to the ending of rainfall on the last gage. All non-recording precipitation gages are assumed to be distributed in time the same as this mean mass curve. For the event being considered, the procedure gives 13 different curves (7 Belfort and 6 Truchek), depending on the total precipitation at each non-recording gage, representing either the mean mass time distribution curve or its actual time distribution curve.
2. Plot the mass runoff curve for the event. In the 4-5 October 1972 example there are two runoff curves (see Figure 31). The first runoff began at 8:14 PM and ended at 9:33 PM with a volume of 0.0128 acre-inches. The second runoff began at 11:15 PM on October 4 and ended at 1:14 AM on October 5, 1972, with a volume of 0.000357 acre-inches. Thus, the total volume of both runoff events corresponding to the October 4-5 rainstorm is 0.0132 acre-inches.
3. The difference in the mass rainfall volume for each 5-minute interval of precipitation is obtained by planimetering the isohyetal map for that time period and adding the total measured volumes for all time periods. This sum is the actual volume of rainfall during the storm. This volume is reduced by the volume of runoff to give the volume of watershed retention. Note that watershed infiltration is only a part of watershed retention. Factors such as evapotranspiration are too small to measure and depression storage eventually infiltrates. Interception is a true retention as was the water required to wet the watershed surface under thunderstorms.
4. Since the rain began at 7:53 PM on October 4, 1972, and ended at 12:45 AM on October 5, 1972, infiltration continued for a period of 4 hours and 53 minutes, but not at a maximum rate after runoff stopped, since after this time watershed infiltration exceeded rainfall rate. Subtracting a mass runoff of 0.024 inch from the mean mass precipitation of 0.40 inch from 7:53 PM to 12:46 AM resulted in a mass infiltration of 0.376 inch in 4 hours and 53 minutes.
5. Plot the maximum of 0.376 inch of infiltration on 3 x 5 cycle log paper at the time of 17,580 seconds and assume arbitrarily the lowest unit of infiltration or 0.001 inch infiltration in 1 second. Draw a straight line through these two points. This is the mass infiltration curve.
6. On the same sheet, plot the infiltration rates against time, as taken from the corresponding times and amounts of the mass infiltration curve. For example, at 1 second the mass infiltration is 0.001 inch so that $(0.001/1) \times 3,600 = 3.60$ inches/hour mean infiltration rate for the 1 second period. The estimated watershed infiltration decay curve for the sideslope at Parleys site No. 1 is thus plotted, as shown in Figure 39.

The same procedure may be applied to the Layton storm of October 4-5, 1972, except that it was necessary to correct it for the amount of the runoff from the roadway which occupies 1/2 of the total drainage. It had been previously observed that the roadway at Parleys site No. 2 retained 0.02 inch of water in the same period of time so the mass precipitation was reduced by this amount of retention to account for the retention of runoff by the roadway. After runoff from the roadway is determined, an estimate of the runoff from the sideslope could be made. The mass infiltration curve may be constructed similarly. The upper point on the mass infiltration curve for this event is 0.41 inch in 52,800 seconds, while the lower point can again be assigned as a mass infiltration of 0.001 inch in 1 second. The estimated watershed infiltration decay curve for the sideslope at Layton site is shown in Figure 40. Note that the curves at both sites look very similar.

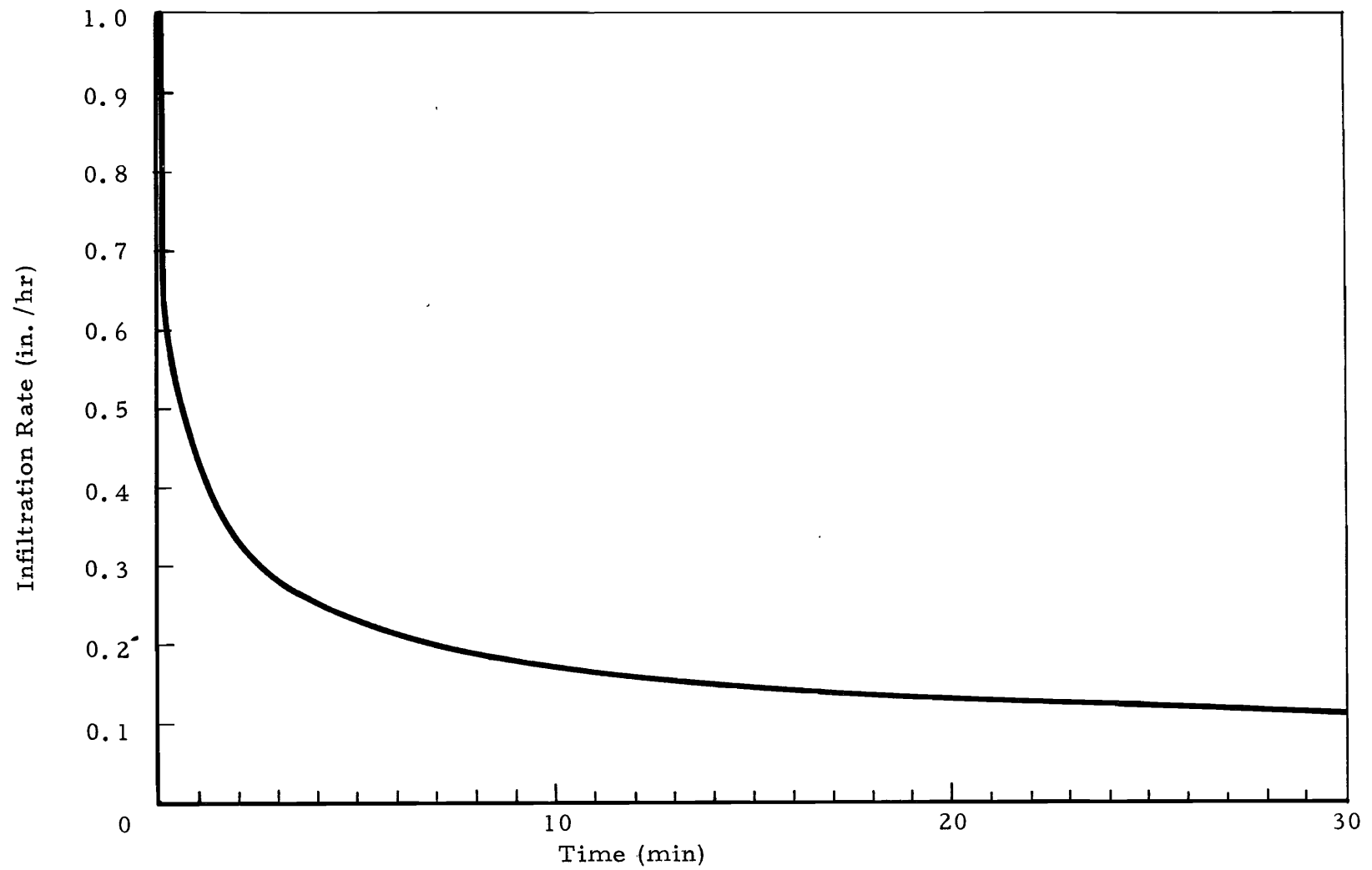

Figure 39. Estimated infiltration capacity of soil on sideslope at Parleys site.

14

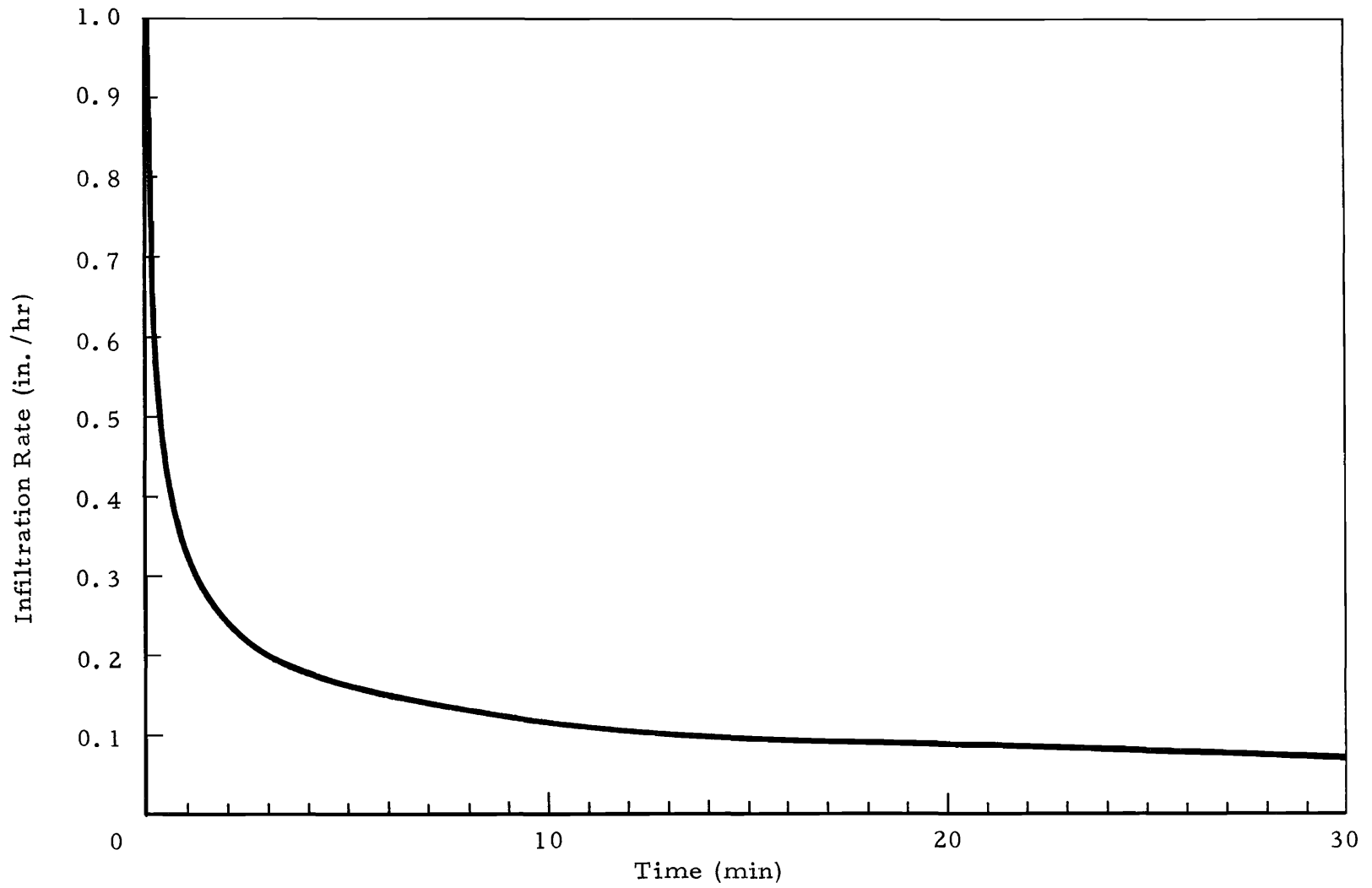

Figure 40. Estimated infiltration capacity of soil on sideslope at Layton site.

SUMMARY AND CONCLUSIONS

Hydrologic data including precipitation and runoff for two rainfall seasons in 1972 and 1973 were collected for two urban highway watersheds in the Salt Lake City area, Utah. The data are needed for the verification of a mathematical model simulating the rainfall-runoff process on typical highway watersheds. The procurement and installation of field equipment as well as the selection of two test sites were accomplished in 1971 through 1972. Only two seasons of field data could be collected to date. However, the year 1972 happened to be a season with infrequent storms. No measurable storm was recorded until late in the summer of 1972. All precipitation, runoff, air temperature, wind, and soil moisture data collected for each rainfall event are presented in this report.

Despite the arrangement of considerably dense precipitation-measuring points on each site, rainfall data collected varied from one gage to another, especially under low-intensity storms. A comparison of hydrographs plotted for major storms at Parleys site numbers 1 and 2 reveals that a substantial amount of precipitation was depleted by infiltration, grass interception and depression storage on the sideslope. The hydrographs at the Layton site in the early rising stage were judged to be constituted mainly of runoff from the roadway, but in the late receding stage contributed mostly from the sideslope.

The splash from heavy traffic during rainfall at Parleys site number 2 was observed to account for a

significant amount of runoff lost from the roadway. Unfortunately, corrective provisions were not made to measure the amount of splash. Without this measurement, it is difficult to determine the effect of splash on the inlet hydrographs. The seriousness of splash due to traffic at the Layton site was not so obvious as at Parleys site number 2 because the total runoff at Layton site consisted of those from the paved roadway, paved shoulder, and grass slope.

The most difficult problem encountered during field data collection from the highway cross-section is the traffic that not only interrupts the natural rainfall-runoff process on the roadway, but also constitutes a potential hazard to the field instruments and vice versa. To accurately compute the inlet hydrograph due to runoff from the roadway, human factors such as traffic should be taken into consideration in the mathematical modeling.

Debris plugging difficulties of the discharge-measuring flumes found in Baltimore, Philadelphia, and Chicago have not been experienced with the cutthroat flumes installed. There were also several other problems encountered during data collection and reduction. Some of them were readily corrected *in situ*, but others could not be remedied without partial or entire modifications of the field instrumentation systems. Those which should be improved were already pointed out earlier and will be summarized in the following section.

RECOMMENDATIONS

The principal future works recommended for the field phase of the project are as follows:

1. Continuance of the field data collection through a few more seasons would certainly yield valuable information on the unique rainfall-runoff process on the typical urban highway cross-sections. In order for data to be useful, a total of at least 10 seasons is required. The additional field data will be extremely important in the verification of the mathematical model and can be obtained at minimal unit cost since the capital investments have already been made.

2. A great variety of precipitation data recorded at various rain gages including Belfort and Truchek on each site with the same rainfall event certainly indicated the necessity of having more rain gages installed on each site. Apparent gaps in the areal coverage of rain gages were in the medians. A denser network of rain gages will enable plotting an isohyetal map for every storm occurring on each site and hence analyze the rainfall-runoff relationship for the typical urban highway watershed.

3. The splash from traffic appeared to be a sizable portion of many of the events at Parleys site

number 2, but not so obvious at Layton site. Most of this water could be directed back to the roadway by flashings between the guard posts of the median by the curb side and measured with trough gages on the uphill side of the traffic lane.

4. The water level sensor and recorder for the inlet flume (PW-2) at Parleys site number 2 could and should be improved by means of more stable electronics and a recorder with a wider chart which records on paper suitable for electronic digitizing.

5. Great difficulty was experienced in keeping time synchronizers at both sites operating because the exposed wires between the sensing equipment were such an easy target for vandals and chance encounters with highway maintenance equipment. The wires for the time synchronizers should be placed either underground or in the curved portions of guard rails.

6. Infiltration capacity of the sideslopes at both sites should be measured by use of an infiltrometer. The amount of interception and depression storage for various rainfall events should be determined *in situ*.

REFERENCES

- Fletcher, J. E. 1949. Some properties of water solutions that influence infiltration. *Trans., AGU* 30(4):548-554.
- Fletcher, J. E. 1960. The effect of vegetation on infiltration in the Southwest. Part of a Symposium on Water Yield in Relation to Environment in the Southwestern United States, AAAS, Sul Ross State College, Alpine, Texas. (Barton H. Warnock and J. Linton Gardners, Eds.)
- Skogerboe, G. V., M. L. Hyatt, R. K. Anderson, and K. O. Eggleston. 1967. Design and calibration of submerged and open channel flow measurement structures. Part 3. Cutthroat flumes. Utah Water Research Laboratory PRWG31-4, Utah State University, Logan, Utah. 37 p.

