

CUORE Image Analysis and CUORE-0 Shifting:
A Contribution to the Search for Neutrinoless Double Beta Decay

A Senior Project
presented to
the Faculty of the Physics Department
California Polytechnic State University, San Luis Obispo

In Partial Fulfillment
Of the Requirements for the Degree
Bachelor of Science

by

Dakota Christopher Rose

June, 2015

Senior Project Advisor:
Prof. Thomas D. Gutierrez



Special Thanks to the NSF
For Grant NSF-PHY-1404205

Introduction

The Standard Model of Physics is the rulebook of modern particle physics, the guidebook by which physicists define the interactions that take place in this universe. Using these guidelines, physicists are able to predict the occurrences and patterns of our universe, and are able to describe the effects that we humans see. By delving into the mechanisms that this Model predicts, we can probe the depths of possibility and explore the full range of knowledge that our universe has to offer.

To this end, I had the opportunity to aid one area of modern particle physics research through cooperation with and travel to the Cryogenic Underground Observatory of Rare Events (CUORE), based out of Italy's Gran Sasso National Laboratory, also known as the Laboratori Nazionali del Gran Sasso (LNGS). Located near the town of Assergi in the Abruzzo region of central Italy, the lab is home to approximately ten different experiments in various stages of operation, with CUORE being one of them. CUORE is a project searching for neutrinoless double beta decay ($0\nu\beta\beta$) through the use of a tellurium oxide (TeO_2) detector, with the tellurium-130 (^{130}Te) acting both the source and the detector of this rare decay. My job during my stay at the lab was to monitor the incoming data and experimental parameters for the CUORE-0 "test run" of the CUORE project to watch for fluctuations in the data that may indicate issues with the experimental apparatus. Furthermore, my partner and myself were also tasked with aiding with the general maintenance of the experiment, amounting to refilling the liquid helium inside the detector every other day, and generally helping with necessary adjustments.

Back in California, I had a separate task to undertake to aid this project. In order to account for all the different possible variables and sources of error, there exists a large number of

images of the TeO_2 crystals, showing the small spots of glue used in the construction process. These images either have five spots of glue, or nine spots of glue each, and for each image the area of each spot must be calculated, so that we may compare the variability in the size of the spots with any fluctuations in the data from the crystals. As we begin to account for all these areas of error in the experiment, we are able to get closer to the potential discovery of this extremely rare decay.

Theory: The Standard Model ^[1]

In particle physics, the Standard Model is the theory concerning how the strong, weak, and electromagnetic forces facilitate interactions between subatomic particles of all types. Furthermore, the Standard Model also has the function of categorizing the subatomic particles that determine the behavior of physics at the fundamental level. Over the past century, the Standard Model has developed through numerous breakthroughs both theoretically and experimentally that have confirmed the accuracy of this model.

Within the Standard Model, there are two categories of particles: fermions, and gauge bosons. Within these overarching categories, the particles are further split into groups determined by their properties, such as spin. Fermions are the spin- $\frac{1}{2}$ matter particles that obey the Pauli exclusion principle, while the bosons are the integer-spin force particles.

Bosons are the force mediator particles in the Standard Model. They are whole-integer spin particles, and each is related to a specific atomic force. The gluon is the force mediator particle for the strong force. Denoted by the symbol g , it facilitates strong nuclear force interactions such as the color charge changes of the quarks. The photon, denoted by γ , is the force mediator for the electromagnetic force of spin 1 and electric charge 0. For the weak nuclear force, there are three mediator particles in the W^+ , W^- and Z^0 bosons. The W^\pm bosons have an

electric charge of ± 1 respectively, and the Z^0 boson is electrically neutral. A diagram of the bosons is seen in Figure 1 below.

BOSONS force carriers
spin = 0, 1, 2, ...

Unified Electroweak spin = 1			Strong (color) spin = 1								
Name	Mass GeV/c ²	Electric charge	Name	Mass GeV/c ²	Electric charge						
γ photon	0	0	g gluon	0	0						
W⁻	80.39	-1	Higgs Boson spin = 0 <table border="1"> <thead> <tr> <th>Name</th> <th>Mass GeV/c²</th> <th>Electric charge</th> </tr> </thead> <tbody> <tr> <td>H Higgs</td> <td>126</td> <td>0</td> </tr> </tbody> </table>			Name	Mass GeV/c ²	Electric charge	H Higgs	126	0
Name	Mass GeV/c ²	Electric charge									
H Higgs	126	0									
W⁺ W bosons	80.39	+1									
Z⁰ Z boson	91.188	0									

Figure 1

Bosons of the Standard Model

Fermions are matter particles. This category is made up of six quarks, and six leptons of spin one-half that obey the Pauli exclusion principle. This is the principle that dictates how many fermions can occupy a quantum state, constrained by their spins and energies. Fermions of the same spin cannot occupy the same energy level, and thus their distribution through the quantum states is determined following this law. Existing in many different combinations, the leptons and quarks are what constitute all ordinary matter in our universe (not including dark matter or dark energy), and are elementary. That is, they have no constituent parts, and are the most basic materials with which all matter is built.

For quarks, the group consists of six different types, also known as “flavors.” There are Up (u), Down (d), Top (t), Bottom (b), Strange (s), and Charm (c) quarks. Each quark has its own antiquark associated with it. Both the quarks and the antiquarks can have one of three “colors,” denoted red, green, and blue. This “color charge” is related to the strong nuclear force, and does not pertain to conventional colors of visible light. When combined, the various flavors of quarks and antiquarks form composite particles called hadrons, bound by the strong nuclear force. Within hadrons, there can be combinations of either two or three quarks, with the resultant particle forced to be color-neutral. Mesons are quark-antiquark composites, while any combination of three quarks and/or antiquarks is called a baryon. The flavor of each quark within a composite hadron determines the resultant particle; protons and neutrons are the simplest example of this. A proton, uud, has two up quarks and a down quark, and flipping an up to a down gives a neutron, udd. Flavor-changing even a single quark inside a baryon will alter its particle identity.

For leptons, there are also six flavors of particles. These are the electron (e), the electron neutrino (ν_e), the muon (μ), the muon neutrino (ν_μ), the tauon (τ), and the tau neutrino (ν_τ). Leptons do not carry color charge, as the baryons do, and the three neutrinos do not even carry electrical charge (they are neutral). The electron, muon, and tauon all have an electric charge of -1. These six leptons are ordered as generations, created with a mass hierarchy. The first generation is the electron and the ν_e , the second generation is the muon and the ν_μ , and the third generation is the tauon and the ν_τ . It is important to note that each of the $e/\mu/\tau$ is much more massive than any of the neutrinos, whose masses are so small and the particles themselves so difficult to detect that they have not been fully categorized as of yet. It has, however, been established that the neutrinos have nonzero masses through the neutrino oscillation experiments

(Griffiths). As with the baryons, each lepton has an associated antiparticle of equal mass, equal charge magnitude, but opposite charge sign. A diagram showing the different fermions is seen in Figure 2 below.

FERMIONS matter constituents spin = 1/2, 3/2, 5/2, ...					
Leptons spin = 1/2			Quarks spin = 1/2		
Flavor	Mass GeV/c ²	Electric charge	Flavor	Approx. Mass GeV/c ²	Electric charge
ν_L lightest neutrino*	$(0-2)\times 10^{-9}$	0	u up	0.002	2/3
e electron	0.000511	-1	d down	0.005	-1/3
ν_M middle neutrino*	$(0.009-2)\times 10^{-9}$	0	c charm	1.3	2/3
μ muon	0.106	-1	s strange	0.1	-1/3
ν_H heaviest neutrino*	$(0.05-2)\times 10^{-9}$	0	t top	173	2/3
τ tau	1.777	-1	b bottom	4.2	-1/3

Figure 2

Fermions in the Standard Model

One of the multitude of rules that is applied to the Standard Model, and arguably one of the more important rules for the analysis of the $0\nu\beta\beta$ decay, is that concerning conservation of lepton number in decays. Each leptonic fermion is given a lepton number of either 1, or -1 for antileptons. All other elementary particles have a lepton number of 0. As is typical of conservation laws, any reaction that does not conserve lepton number is currently forbidden. As of yet, there is no known violation of conservation of lepton number.

Another important part of understanding $0\nu\beta\beta$ decays is how antiparticles interact. First predicted in the 1930s by Paul Dirac, and initially experimentally confirmed in 1932 by Carl

Anderson, antimatter is the physical opposite of the matter that makes up the universe. Having properties of equal magnitude and opposite quantum numbers in comparison to conventional matter, an antimatter particle cannot exist in the same location as its matter counterpart. If placed in proximity to its twin and being in the appropriate quantum states, matter and antimatter can collide and annihilate, producing other particles in the reaction. Depending on the incoming and outgoing particles, this pair annihilation can have a number of intermediary particles (depending on the force facilitating), and the outgoing particles will have known energies. There are some particles, such as the photon, gluon, and Z^0 boson, that are their own antiparticles. These “Majorana particles” are generally electrically neutral, and as such questions arise concerning the neutral neutrinos and how they are different from their antiparticles.

The neutrino was first discovered in the mid-1950s by Clyde Cowan et al. in the Cowan-Reines neutrino experiment, nearly 25 years after its theoretical prediction by Wolfgang Pauli in 1930.^[2] Pauli had proposed the existence of an electrically neutral, small-mass particle to account for discrepancies in the conservation of energy, momentum, and angular momentum in beta decay. The observed energies and directions of the resultant particles from beta decay did not match the theoretical predictions, so a change had to be made to the theory, as multiple experiments yielded the same results. The result of this alteration was the neutrino, meaning “little neutral one” and coined by Enrico Fermi. It was proposed that this particle was very weakly interacting with matter, and thus this was the cause for it not having been discovered yet. It is now known that the neutrinos only interact via the weak nuclear force, and that due to the extremely small interaction distance of this force neutrinos can pass through even the entirety of the Earth without interacting with another matter particle. Now, neutrinos are also interesting for reasons besides their low interaction rates. One specific area of interest is with their chirality. As

of yet, all produced and observed neutrinos have had left-handed chirality, and all observed antineutrinos have had right-handed chirality. One of the possible explanations for this is that these two opposite-chirality partners may not exist. If this is the case, then it is possible that neutrinos are Majorana particles, and what we observe as the right-handed antineutrinos are simply right-handed Majorana neutrinos. This is what the CUORE $0\nu\beta\beta$ experiment is aiming to test.

Theory: Radioactive Decay

Radioactive decay is a nuclear process by which an unstable atomic nucleus will release energy in the form of particles in an attempt to move closer toward a stable energy state. This energy is emitted as ionizing radiation, classified as alpha particles, beta particles, gamma rays and conversion electrons. Any material that emits such ionizing radiation is called radioactive. With elemental nuclei, the only constituent particles are the three-quark protons and neutrons. Bound by the strong nuclear force, the nucleus becomes unstable as the ratio of nucleons drifts away from one. To combat this, there is a random calculable probability that the nucleus will undergo a stabilizing radioactive decay, which attempts to equalize the nucleon ratio.

The specific type of radioactive decay that the CUORE project is concerned with is beta decay (hereby referred to as β decay), which has two decay schemes, β^+ and β^- . In β^- decay, the unstable nucleus emits an electron and an electron antineutrino, $\bar{\nu}_e$, converting one of the neutrons inside the nucleus into a proton and thereby increasing the atomic number by one. An example of this can be seen in the decay of carbon-14 (^{14}C) into nitrogen-14 (^{14}N):

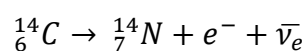

Conversely, β^+ decay occurs when an unstable nucleus emits a positron and an electron neutrino, ν_e , thereby converting a proton inside the nucleus into a neutron and reducing the atomic number by one. An example of β^+ decay can be seen in the decay of magnesium-23 (^{23}Mg) into sodium-23 (^{23}Na):

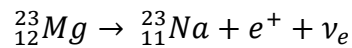

In combining two β^- decays the rare double beta decay ($\beta\beta$ decay) event is produced. With $\beta\beta$ decay, two neutrons within the atomic nucleus, each emitting one e^- and one $\bar{\nu}_e$, are converted into protons. This raises the atomic number by two, further stabilizing the nucleus.

In the CUORE experiment, we are dealing with an isotope of the element tellurium, tellurium-130 (^{130}Te). In the case of ^{130}Te , the $\beta\beta$ decay occurs because normal β^- decay is disallowed by the element one atomic number higher having a lower binding energy, while the element two atomic numbers above had a higher binding energy. Thus, while a single β^- decay is not allowed, $\beta\beta$ decay is not only allowed, but is the only mode of decay for this isotope. ^{130}Te decays into ^{130}Xe , as shown with the following scheme:

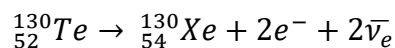

It is important to note that $\beta\beta$ decay in ^{130}Te has been observed by the NEMO-3 experiment, where the half-life was measured to be $(7.0 \pm 0.9 \pm 1.1) \times 10^{20}$ years (source). Now, what CUORE is specifically searching for is known as neutrinoless double beta decay ($0\nu\beta\beta$ decay). The idea behind this concerns the theory that the neutrino may be a Majorana particle, and thus its own antiparticle. If this is the case, there is a small probability that during a $\beta\beta$ decay event, the neutrino emitted by one nucleon is absorbed by the other and the resulting absence of neutrinos is seen in the energy data. This is essentially what the following Feynman diagram illustrates, with the single neutrino shown acting as an intermediary for the event:

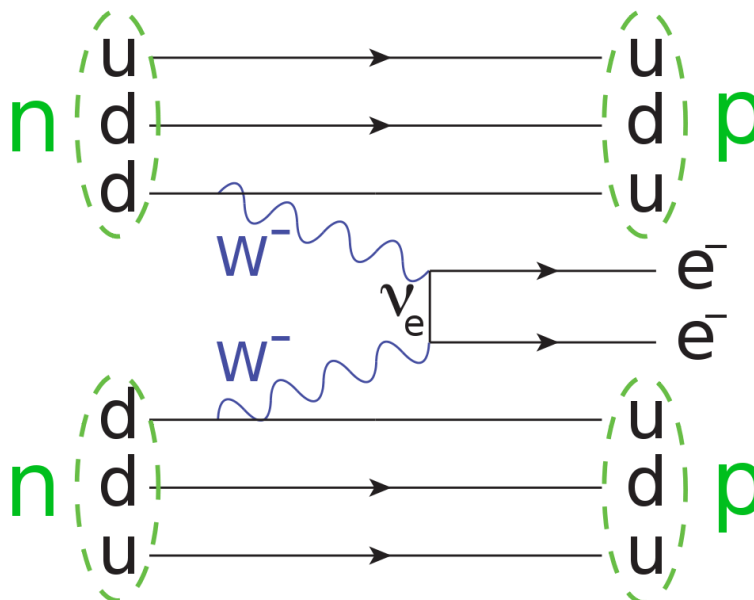

Figure 3

Neutrinoless Double Beta Decay

As shown above, because β decay is a weak-force interaction we see the W^- boson emitted by a down quark in each neutron. This is a necessary for a quark generation change, which alters the identity of a given quark to another, with some limitations. After the emission, each W^- boson decays into the observed e^- and $\bar{\nu}_e$ particles. In the neutrino absorption explanation, the $\bar{\nu}_e$ that is emitted by one W^- boson interacts with the second W^- boson to create the second e^- . This is only allowed if the neutrino is its own antiparticle.

Laboratori Nazionali del Gran Sasso ^[3]

The laboratory where the **Cryogenic Underground Observatory Of Rare Events** (CUORE) project is located is called, in Italian, the **Laboratori Nazionali del Gran Sasso** (LNGS). Situated in the Abruzzo region of central Italy, between the cities of L'Aquila and Teramo and about 120 km from Rome, the lab is home to about eleven experiments in various stages of completion. Some of the more notable experiments to occur there are the **Oscillation Project with Emulsion-tRacking Apparatus** (OPERA) and the **Imaging Cosmic And Rare**

Underground Signals (ICARUS) neutrino detection experiments, and the XENON Dark Matter Search Experiment. The laboratory is divided into two separate facilities: the surface facility, located at the base of the Gran Sasso mountain, where the scientists working at LNGS have their offices, cafeteria, and social/recreational area, and the underground laboratory buried beneath the mountain. The underground lab was built underneath about 1400 meters of rock, which protects the sensitive experiments from the cosmic rays that would interfere with the data.

The underground laboratory is divided in three “halls,” called Hall A, Hall B, and Hall C. Each hall contains a number of experiments, divided and placed in specific locations for safety reasons. The layout of the underground lab is shown below:

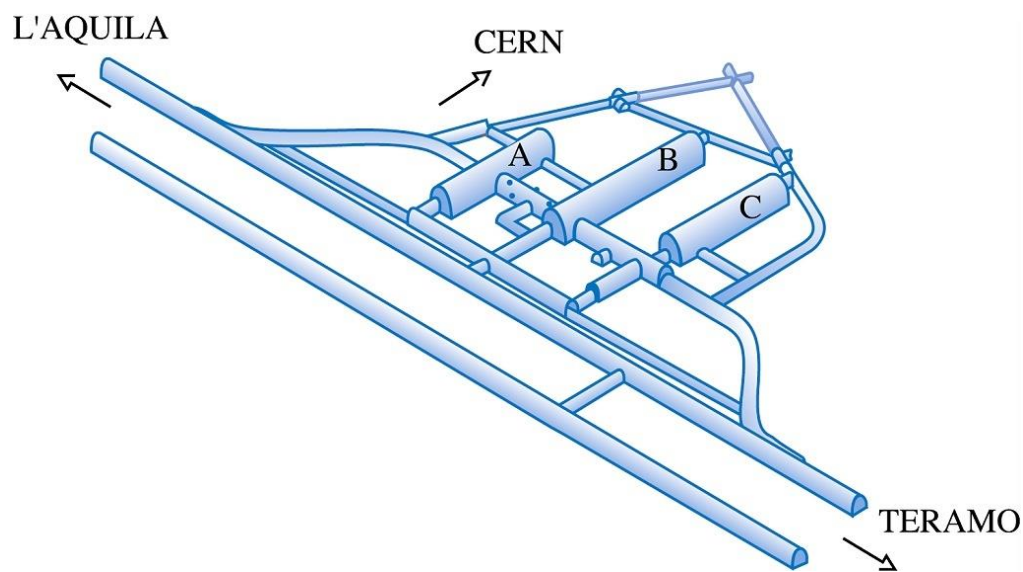

Figure 4

Map of the underground laboratory at LNGS

As depicted, the entrance and exit to the laboratory is in the tunnel going towards L’Aquila, and we see the three main experiment halls. Upon exiting the highway, video surveillance confirms the identity of the incoming vehicle, and guards posted inside open the doors to allow access to the lab. Once inside, all those entering must undergo check-in with the guards, where they make sure those entering have the necessary security clearance, as well as recording who goes in and

out and at what time they do so. Thus, once work is completed those leaving check out at the guard station before boarding the shuttle back to the aboveground lab.

The CUORE Experiment ^[4]

CUORE is a multi-national collaborative effort to discover the theoretical $0\nu\beta\beta$ decay in ^{130}Te . Italian-led, the project involves around 100 individuals distributed through about 20 institutions from primarily Italy and the United States, which includes the Cal Poly collaborators.

The CUORE experiment utilizes tellurium oxide (TeO_2) crystals of ^{130}Te as both the source and the detector for the $0\nu\beta\beta$ decay. Acting as bolometers to measure energy spikes via changes in temperature, there are 988 TeO_2 crystals containing 203 kg of ^{130}Te source material. These crystals must be cooled to approximately 10 mK above absolute zero to ensure that the thermal signals do not swamp out the detection signals, as well as altering the specific heat of the crystals to make changes in energy easier to observe. This signal energy for the $0\nu\beta\beta$ decay is theoretically calculated to be 2527.518 ± 0.013 keV,^[4] and would be a peak in the electron pair energy compared to the wide energy distribution in the 2-neutrino case, as depicted below.

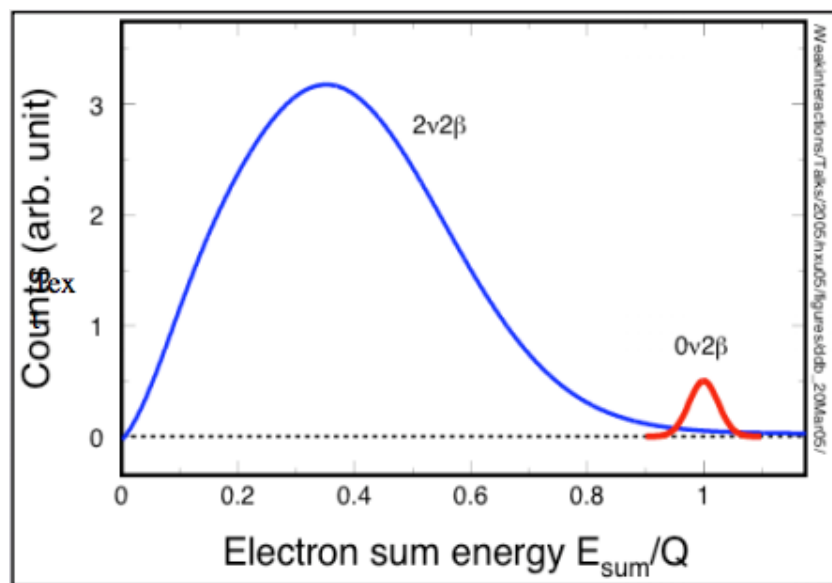

Figure 5

Energy plot of a $0\nu\beta\beta$ event versus a $2\nu\beta\beta$ event

In honing in on the most stable and interference-free experimental design, the CUORE project has gone through three distinct phases of testing. The first prototype was called Cuoricino, which as “cuore” is Italian for “heart,” means “little heart.” The prototype contained 62 TeO₂ crystals and was designed to test how low the background signal could be reduced to. Essentially, this project was intended to answer the question, “is this experiment feasible?” This question was answered in the affirmative, and the project moved to the second phase, CUORE-0. CUORE-0 was built to confirm both design and process improvements that would be taken into account during the construction of the full version of CUORE. It consisted of 52 TeO₂ crystals with much better surface purity, where the data devices would be attached. CUORE-0 is kept between 13 and 15 mK, and while experimental confirmation was not expected nor found with this version, it was still an important stepping stone in the development of the CUORE project. CUORE-0 will continue to take data until CUORE is completed.

One of the more interesting yet simple pieces of each of these three phases is the lead shielding that protects the internals from most external background sources. This lead radiation shield was created from ingots pulled from an Ancient Roman shipwreck, and due to its age is much more pure and less radioactive than modernly smelted lead. The reason for this comes from a chemically indistinguishable isotope of lead, lead-210 (²¹⁰Pb), that naturally populated lead ingots as they are smelted from the ores. The isotope is radioactive, but with a half-life (the time taken for half of any given element to decay into another isotope) of only 20 years! Thus, the older the lead, the more ²¹⁰Pb has decayed away, leaving the ingot nearly non-radioactive. Because of this, the lead does not contribute nearly at to the background radiation, and especially so in comparison with modern lead that has not had the time to purify.

My Role at LNGS

When my roommate and colleague Evan Johnston, also a physics major at Cal Poly, and I had the opportunity to travel to Italy during August of 2014, we had signed on to undertake a somewhat specific set of duties as CUORE-0 on-shift workers, also known as “shifters.” CUORE-0 shifters at LNGS have certain duties that they must handle, while at the same time participating in other requested projects, time permitting.

Our day-to-day activities were very straightforward. The main duty of the CUORE-0 shifter is to monitor the incoming data from CUORE-0 via a specific set of webpages that would display information on the cryostat, from the amount of helium still circulating inside the cryostat to the various pressures and temperatures for the important inner chambers. All of the images to follow are from these pages, but as the pages are not accessible by the general public, the links will not be provided. During our three-week stay at the lab, my research partner and I were to check on the incoming data and the experiment parameters that ensured proper function. Specifically, there were two webpages, and three possible computers that we would have to occasionally monitor via the remote desktop control program TeamViewer. Arguably the most important webpage that we had to monitor was the controller of the CUORE-0 cryostat. A cryostat is a device designed to maintain low cryogenic temperatures for the materials within the cryostat (s).

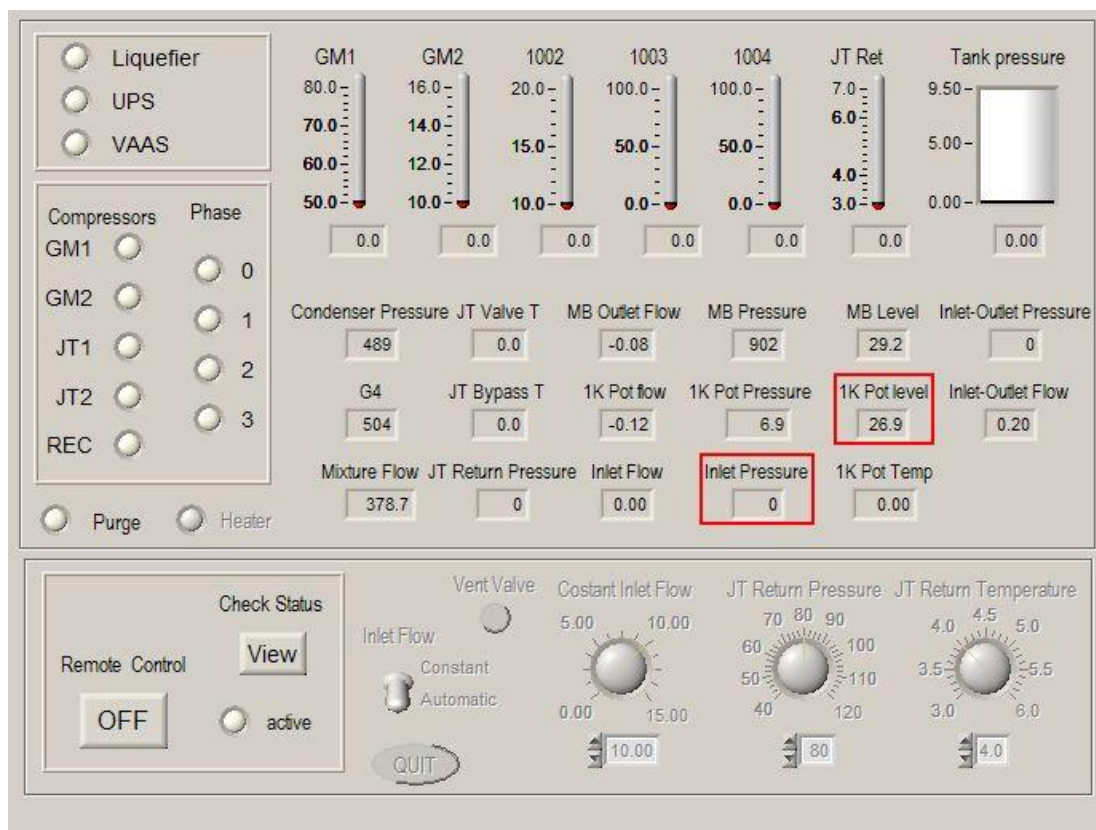

Figure 6

Cryostat Control Panel

The values that we were to routinely check and make note of are the Main Bath (MB) level, the MB pressure, the 1K Pot level, the 1k Pot pressure, the Condenser pressure, and the mixture flow. The Main Bath refers to the main liquid helium (He) bath, which slowly evaporates over time due to slight inefficiencies in the apparatus design. The main bath is what fills the 1K pot, also known as the 1 kelvin layer of the experiment. The helium levels within this area must be carefully regulated, as either too much or too little He in the 1K pot causes significant aberrations in the incoming data. As the levels of the main bath decrease, an attempt is made to recycle as much of this He gas as possible, which is what the job of the condenser is: recovering lost He gas through re-condensation.

The second area that we had to monitor was the experiment verticalization parameters. Within the small structure that housed the CUORE-0 apparatus (called the CUORE-0 hut) there were three computers that monitored the experiment. One, as mentioned above, monitored the cryostat and related parameters. Another had the ability to access previous cryostat data, allowing for analysis of the past data values. The last computer controlled the verticalization system. This computer did not have an assigned webpage, and instead it was required to use TeamViewer to remote in. As such, there will be no pictorial example of this program. The verticalization program controlled the tilt of the TeO₂ crystal towers within CUORE-0. It was necessary to carefully monitor these parameters, as if the towers were not properly aligned they could touch the containment walls and be thrown out of thermal equilibrium.

The final area that we had to monitor was through the CUORE-0 Offline Run Control (CORC) tool. This webpage was where the thermal tower data was sent, allowing those watching to look for abnormalities (and even positive experimental results) directly and instantaneously. CORC is set up to show any data run, organized by the guise under which any particular run was begun. For example, runs intended to be “test runs” to monitor the towers after a liquid helium (LHe) refill were labeled “Test,” and “data runs” where the parameters were good would be labeled “Data.”

CORC: CUORE-0 online run check							
Previous 100 runs:							
Run	Run Type	Setting Basket	Start Date	Stop Date	Run Time (s)	Hours	Stop Status
203136	Setup_LoadCurves	1432	15-06-06 22:32				
203135	Test	1465	15-06-05 18:59	15-06-06 22:29	98969	27.49	OK
203134	Setup_WorkingPoint	1459	15-06-05 18:37	15-06-05 18:43	376	0.10	OK
203133	Test	1465	15-06-05 18:32	15-06-05 18:36	188	0.05	OK
203132	Setup_WorkingPoint	1459	15-06-05 18:11	15-06-05 18:17	376	0.10	OK
203131	Test	1465	15-06-05 14:44	15-06-05 18:10	12386	3.44	OK
203130	Setup_WorkingPoint	1459	15-06-05 14:26	15-06-05 14:32	376	0.10	OK
203129	Test	1465	15-06-05 11:22	15-06-05 14:26	11018	3.06	OK
203128	Setup_LoadCurves	1432	15-06-05 06:37	15-06-05 10:30	13947	3.87	OK
203127	Setup_WorkingPoint	1459	15-06-05 06:30	15-06-05 06:36	366	0.10	OK
203126	Setup_WorkingPoint	1459	15-06-05 06:16	15-06-05 06:22	366	0.10	OK
203125	Setup_LoadCurves	1432	15-06-05 01:25	15-06-05 05:18	13947	3.87	OK
203124	Setup_WorkingPoint	1459	15-06-05 01:19	15-06-05 01:25	371	0.10	OK
203123	Setup_WorkingPoint	1459	15-06-05 00:36	15-06-05 00:42	371	0.10	OK
203122	Setup_LoadCurves	1432	15-06-04 20:29	15-06-05 00:21	13948	3.87	OK
203121	Setup_WorkingPoint	1459	15-06-04 20:11	15-06-04 20:17	371	0.10	OK
203120	Test	1465	15-06-04 17:27	15-06-04 20:09	9750	2.71	OK
203119	Test	1465	15-06-04 16:27	15-06-04 17:27	3563	0.99	OK
203118	Setup_LoadCurves	1432	15-06-04 10:40	15-06-04 16:23	20568	5.71	OK
203117	Test	1474	15-06-04 10:36	15-06-04 10:39	222	0.06	OK
203116	Setup_WorkingPoint	1459	15-06-04 10:22	15-06-04 10:28	366	0.10	OK
203115	Setup_LoadCurves	1432	15-06-04 08:23	15-06-04 09:36	4388	1.22	OK
203114	Setup_WorkingPoint	1459	15-06-04 08:15	15-06-04 08:21	371	0.10	OK
203113	Test	1465	15-06-04 08:03	15-06-04 08:13	638	0.18	OK
203112	Setup_LoadCurves	1432	15-06-03 21:26	15-06-04 01:18	13898	3.86	OK

Figure 7

CORC Homepage

Above is an image of the CORC webpage from June 6th, 2015. As can be seen, they do not appear to be doing Data runs, and instead are calibrating the system with the Working Point tests and Load Curve runs. The working point measurements check how well the crystals are behaving, and as such must be done during stable conditions such as those found directly after the stoppage of a data run.

All of these data values and experiment parameters also needed to be logged multiple times per day. It is a job of the on-site shifters to not only check these systems, but also record many of their values in a text file that could be uploaded or copied online at the end of the day. Below are the templates for the two types of days: non-LHe-refill days, and LHe-refill days (to be discussed after).

8:xx Run 20xxxx ongoing.

MB level = xxx.x%
MB pressure = xxx
1Kpot level = xx.x%
1Kpot pressure = x.x
Condenser pressure = xxx
Mixture flow = xxx.x

Verticalization:

Axis1 = -x.xxxx
Axis2 = -x.xxxx
Axis3 = -x.xxxx

X = -x.xx

Y = -x.xx

Temp = xx.xx

CORC:

ch56 is at xxx mV, ch 57 is at
xxx mV

09:xx Stop Background run
20xxxx

Resistance Measurement Run
2016xx

(Setup_WorkingPoint):

09:xx start time

09:xx stop time

xx errors: (chx; chx...)

09:xx Start Background
Measurement, Run 20xxxx

09:xx Restart tiltmeter
program, and restart
verticalization, logging in a
new file, renamed the old file
with run number 20xxxx.

MB level = xx.x%
MB pressure = xxx
1Kpot level = xx.x%
1Kpot pressure = x.x
Condenser pressure = xxx
Mixture flow = xxx.x

Verticalization:

Axis1 = -x.xxxx

Axis2 = -x.xxxx

Axis3 = -x.xxxx

X = -x.xx

Y = -x.xx

Temp = xx.xx

CORC:

ch56 is at xxx mV, ch 57 is at
xxx mV

12:xx Run 20xxxx Ongoing

MB level = xx.x%

MB pressure = xxx

1Kpot level = xx.x%

1Kpot pressure = x.x

Condenser pressure = xxx

Mixture flow = xxx.x

Verticalization:

Axis1 = -x.xxxx

Axis2 = -x.xxxx

Axis3 = -x.xxxx

X = -x.xx

Y = -x.xx

Temp = xx.xx

CORC:

ch56 is at xxx mV, ch 57 is at
xxx mV

14:xx Run 20xxxx Ongoing

MB level = xx.x%

MB pressure = xxx

1Kpot level = xx.x%

1Kpot pressure = x.x

Condenser pressure = xxx

Mixture flow = xxx.x

Verticalization:

Axis1 = -x.xxxx

Axis2 = -x.xxxx

Axis3 = -x.xxxx

X = -x.xx

Y = -x.xx

Temp = xx.xx

CORC:

ch56 is at xxx mV, ch 57 is at
xxx mV

16:xx Run 20xxxx Ongoing

MB level = xx.x%

MB pressure = xxx

1Kpot level = xx.x%

1Kpot pressure = x.x

Condenser pressure = xxx

Mixture flow = xxx.x

Verticalization:

Axis1 = -x.xxxx

Axis2 = -x.xxxx

Axis3 = -x.xxxx

X = -x.xx

Y = -x.xx

Temp = xx.xx

CORC:

ch56 is at xxx mV, ch 57 is at
xxx mV

19:xx Run 20xxxx Ongoing

MB level = xx.x%

MB pressure = xxx

1Kpot level = xx.x%

1Kpot pressure = x.x

Condenser pressure = xxx

Mixture flow = xxx.x

Verticalization:

Axis1 = -x.xxxx

Axis2 = -x.xxxx

Axis3 = -x.xxxx

X = -x.xx

Y = -x.xx

Temp = xx.xx

CORC:

ch56 is at xxx mV, ch 57 is at
xxx mV

08:xx Run 20xxxx ongoing.

MB level = xx.x%
MB pressure = xxx
1Kpot level = xx.x%
1Kpot pressure = x.x
Condenser pressure = xxx
Mixture flow = xxx

Verticalization:

Axis1 = -x.xxxx
Axis2 = -x.xxxx
Axis3 = -x.xxxx
X = -x.xx
Y = -x.xx
Temp= xx.xx

CORC:

ch56 is at xxx mV, ch 57 is at xxx mV

xx:xx Stop Background run 20xxxx

Resistance Measurement Run 20xxxx

(Setup_WorkingPoint):

xx:xx start time
xx:xx stop time
xx errors !!!! (chx; chx...)

xx:xx Start test run 20xxxx

xx:xx start He refill, switched MB meter to high
xx:xx Stop He refill MB level 10x.x%, 1kpot and MB meter to low

MB level = xx.x%
MB pressure = xxx
1Kpot level = xx.x%
1Kpot pressure = x.x
Condenser pressure = xxx
Mixture flow = xxx

Verticalization:

Axis1 = -x.xxxx

Axis2 = -x.xxxx

Axis3 = -x.xxxx

X = -x.xx

Y = -x.xx

Temp= xx.xx

xx:xx stop test Run 20xxxx

xx:xx Start Background Measurement, Run 20xxxx

12:xx Restart tiltmeter program, and restart verticalisation, logging in a new file, renamed the old file with run number 20xxxx.

14:xx Run 20xxxx Ongoing

MB level = xx.x%
MB pressure = xxx
1Kpot level = xx.x%
1Kpot pressure = x.x
Condenser pressure = xxx
Mixture flow = xxx.x

Verticalization:

Axis1 = -x.xxxx

Axis2 = -x.xxxx

Axis3 = -x.xxxx

X = -x.xx

Y = -x.xx

Temp = xx.xx

CORC:

ch56 is at xxx mV, ch 57 is at xxx mV

16:xx Run 20xxxx Ongoing

MB level = xx.x%
MB pressure = xxx
1Kpot level = xx.x%
1Kpot pressure = x.x
Condenser pressure = xxx
Mixture flow = xxx.x

Verticalization:

Axis1 = -x.xxxx

Axis2 = -x.xxxx

Axis3 = -x.xxxx

X = -x.xx

Y = -x.xx

Temp = xx.xx

CORC:

ch56 is at xxx mV, ch 57 is at xxx mV

19:xx Run 20xxxx Ongoing

MB level = xx.x%
MB pressure = xxx
1Kpot level = xx.x%
1Kpot pressure = x.x
Condenser pressure = xxx
Mixture flow = xxx.x

Verticalization:

Axis1 = -x.xxxx

Axis2 = -x.xxxx

Axis3 = -x.xxxx

X = -x.xx

Y = -x.xx

Temp = xx.xx

CORC:

ch56 is at xxx mV, ch 57 is at xxx mV

The second template refers to the shifters' other major duty at the lab. Every other day the on-site shifters must venture down into the underground laboratory and join one of the lab technicians working underground. After meeting up, the shifters aid the technician in refilling the main LHe repository, the Main Bath, to ensure that the CUORE-0 temperatures do not climb above accepted values. The refill is necessary due to the aforementioned evaporation of the LHe



Figure 8

Ladder up the side of the CUORE-0 Faraday Cage

over time. While the condenser does indeed recapture the majority of the He gas, it is not designed to directly re-deposit the newly condensed LHe into the man bath. Once the technician was ready with the large tank of LHe, the shifters would climb up the ladder on the side of the faraday cage that houses the CUORE-0 apparatus inside the hut

(Figure 6). On the top of the cage, the shifters insert a hollow metal rod into the CUORE-0 cage, inside which the technician grabs the tube and guides it into the apparatus. After this has sufficiently cooled, the hose line from the LHe container is attached to the hollow rod, and refilling can commence.

After the refilling finished, the technician would gather the used LHe tank and leave, returning it to the storage area near the condenser unit. At this point the shifters were to reset the verticalization unit and ensure that all the monitoring programs and machinery were properly configured for the resuming of a data run. However, we could not simply leave and be done with it, as refilling the LHe main bath has thrown the system out of equilibrium. Upon completion of

these tasks, the shifters left the CUORE-0 hut and climbed up to the CUORE hut, where the cryostat for the full CUORE experiment was being completed. Here, safely out of the CUORE-0 hut, we could walk around without fear of disturbing the sensitive instruments running inside CUORE-0. It is here that the shifters wait and watch, monitoring the system until it regains equilibrium. CORC is the preferred way to watch this process, as through monitoring the baseline voltages of each channel (corresponding to a crystal in the towers) we will see when the system reaches equilibrium. Once normalcy has been attained, the shifters reset the run, stopping the test run that is used during refills, and restarting either a data run, or something else as specified by someone in charge.

One final responsibility that my travel partner and I were tasked with at the lab was another daily monitoring job. Before we arrived, the crystal towers for CUORE had already been assembled, and were now sitting within sealed containers that were being flushed with nitrogen



Figure 9

Tellurium crystal array for CUORE

gas to remove external impurities and contaminants, as shown in Figure 7. To this end, one of the general tasks that had to be completed daily was checking on the towers to ensure that the nitrogen flush had not stopped, or just that the pressure inside the containers had not

dropped. There were four different containers, each with varying numbers of towers that had to be checked. One was separated from the other three, situated in on the top level of the CUORE hut, presumably to be able to show interested parties what the towers looked like. The other three were in the second level of the CUORE hut, inside a clean room. Upon entering the clean room, everyone had to put on a white clean room “bunny suit” over their clothes, along with donning a hair net, facemask, and gloves as seen in Figure 8 below. Inside the clean room, we would go to each set of towers and check the nitrogen flow rates and pressures, making sure they were at the levels that we wanted them to be at. This was a daily occurrence, requiring us to go into the underground lab whether or not we had a refill to be done that day.



Figure 10

Myself in full clean room gear

As this process was usually very quick, much shorter than the journey into the lab, refill days allowed us to do both tasks in one excursion and make better use of our time.

As the CUORE construction was nearing completion, they did not have many other tasks to give the shifters. Besides the normal duty, the tower check was the only extra task assigned to us during our stay at the lab.

Image Analysis

Back at Cal Poly, my work continued in the form of image analysis for the CUORE project. During the construction of the TeO_2 towers, the crystals had small spots of glue attached to them, to bond the crystals together along with the thermistors that would measure the minute temperature changes. For each crystal, there were a number of images taken that showed the glue spots on the different faces. Each image has either five glue spots:

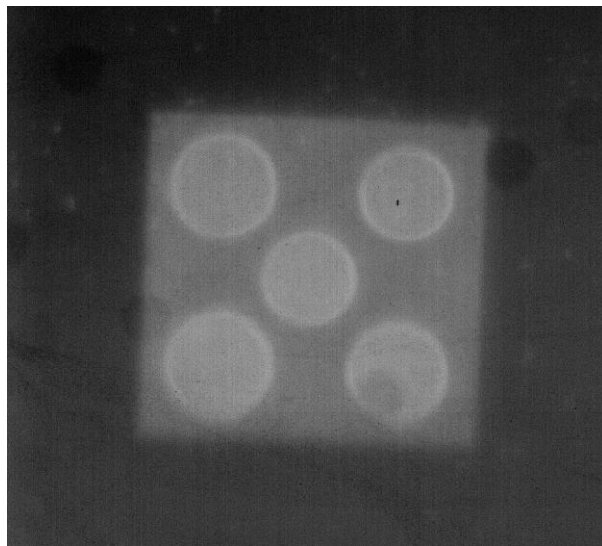

Figure 11

Five-spot crystal image

or nine glue spots:

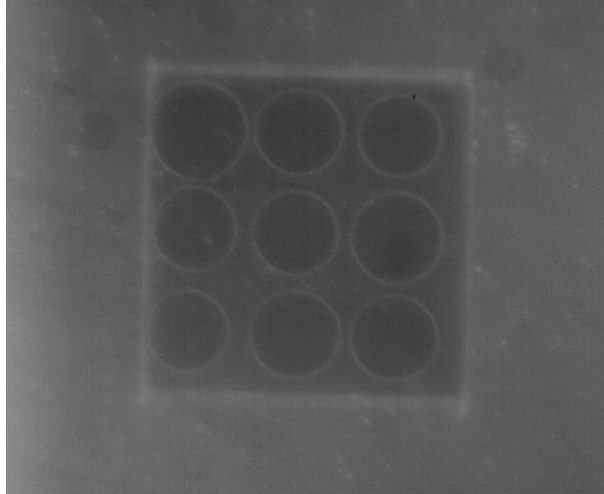

Figure 12

Nine-spot crystal image

For each image, my job was to measure the area of each of the glue spots. For now, each of the areas is measured in pixel area, which will eventually be converted into full area in proper units.

Now, I feel that I must comment on the small sample size of crystals that were completed. It would normally be expected that with a ten week quarter, there would be plenty of time to do a large number of image analysis with the crystals, and that was the case last quarter, up until week eight. During week eight of the quarter during which I was doing the majority of the image analysis, I suffered a major setback in the form of a computer crash. This crash occurred while I was working on the project, and as just before my computer exhibited signs of something being wrong, I instinctively attempted to save the file. However, right as I pressed the command to save, I received the blue screen indicative of a Fatal Windows Error. Upon restarting the computer, I attempted to reopen the spreadsheet file only to discover that it had been corrupted by the crash. Despite my attempts, I was unable to recover the file and was forced to start anew with the analysis. Thus, the low number of images processed.

The process that I used for analyzing the images was fairly simple. For each image, I uploaded it into Photoshop and used a line drawing tool to measure the pixel diameter on two perpendicular axes. From this, I would plug both diameters into the ellipse area equation,

$$A = \pi ab$$

where a and b are the semi-major and semi-minor axes of the ellipse. It is easy to see that for circular objects a and b are the same, and are thus ab is the square of the radius, as is expected for circles. The as-of-yet preliminary results from the analysis is shown below, as histograms.

The first graph shows a histogram of the number of glue spots within various bin sizes, with the bin width set to 2500 pixels.

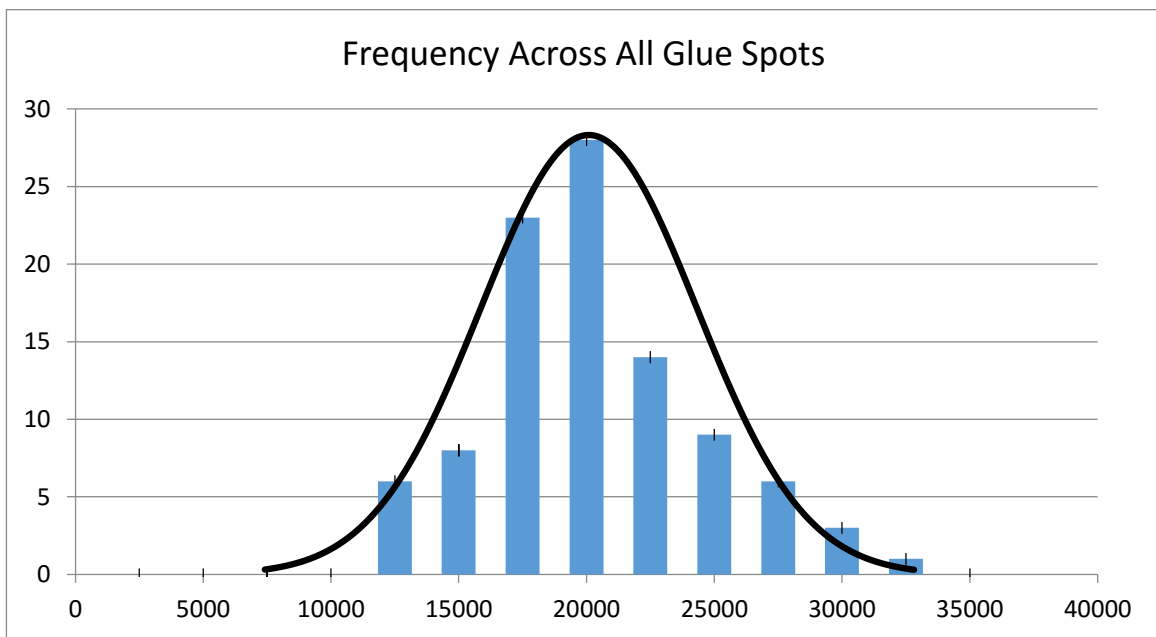

Figure 13

The distribution is Gaussian, as expected, centered on a pixel area of about 20,000 pixels. We calculated a mean value of 19,089.9 pixels with a standard deviation of 4,226.2 pixels. There are outliers on either side, but in general there is nothing overly surprising. The next histogram is taken over only the glue spots from the 5-spot images.

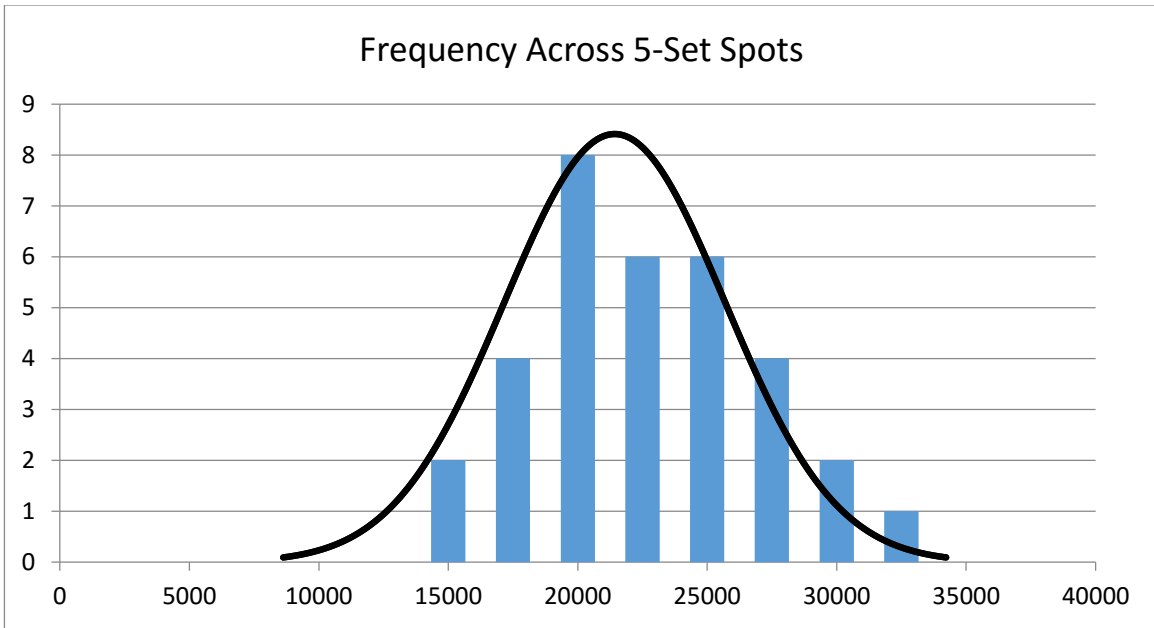

Figure 14

This distribution is similar, however there is a trend for these spots to be on the larger end. Here, the calculated mean is 21,426.6 pixels, with a standard deviation of 4,267.6 pixels. This makes sense, as with only five spots on this face of the crystal there is more area for the spots to spread over without touching. The final histogram is taken over the 9-spot images only:

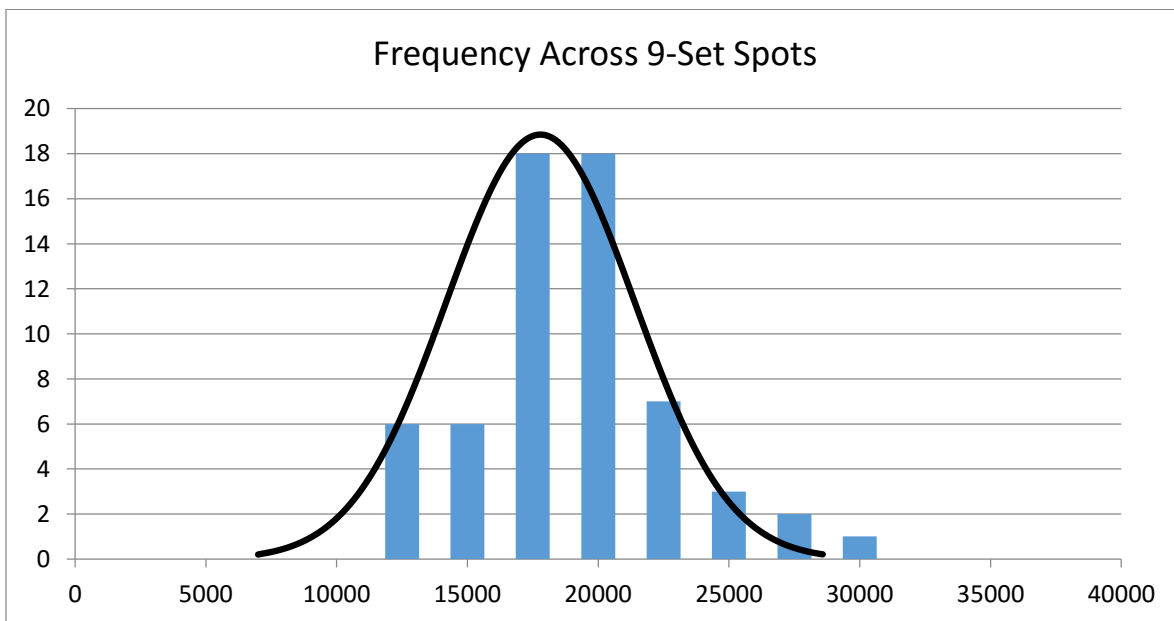

Figure 15

Here, the distribution tends towards the smaller size, which once again makes sense. The mean is calculated to be 17,791.8 pixels, with a standard deviation of 3,598.3 pixels. With 9 spots on the crystal face, there is not enough room for the spots to be larger without coming in contact with one another.

	Total	5-Spot Heater	9-Spot NTD
Mean (pixels)	19,089.9	21,426.6	17,971.8
Sigma (pixels)	4,226.2	4,267.6	3,598.3

Table 1

Conclusion

There is still much work to be done with this project, especially in the area of the image analysis. There are still a large number of images that need to be processed, either manually or using some automated program. This in particular is one avenue that can be pursued, as writing a program to automate this process would dramatically increase the turnaround time of this portion of the project. This is an important step as the CUORE project will need the analysis data to properly account for the different sources of error during the data analysis.

Bibliography

References

- [1] Griffiths, David J. *Introduction to Elementary Particles*. 2nd, Rev. ed. Weinheim: Wiley-VCH, 2008.
- [2] Brown, Laurie M. (1978). "The idea of the neutrino". *Physics Today* 31 (9): 23–8.
- [3] <http://www.lngs.infn.it/en/lngs-overview>
- [4] <https://www.lngs.infn.it/en/cuore-eng>
- [5] [arXiv:0902.2139v1](https://arxiv.org/abs/0902.2139v1)

Figures

- [1] <http://atlas.ch/news/2013/higgs-into-fermions.html>
- [2] <http://atlas.ch/news/2013/higgs-into-fermions.html>
- [3] https://en.wikipedia.org/wiki/File:Double_beta_decay_feynman.svg
- [4] <http://www.fix.net/wreil/Gran-Sasso-Trip-Technical.htm>
- [5] http://nuclear.ucdavis.edu/~tguierr/CalPolyFeb2006_AC.pdf

General References

CUORICINO:

" ^{130}Te Neutrinoless Double-Beta Decay with CUORICINO," CUORICINO Collaboration, *Astropart.Phys.* 34 (2011) 822-831, <http://arxiv.org/abs/1012.3266>

CUORE-0:

"Search for Neutrinoless Double-Beta Decay of ^{130}Te with CUORE-0" accepted to *Physical Review Letters*, CUORE Collaboration, <http://arxiv.org/abs/1504.02454>

CUORE:

"CUORE: A Cryogenic Underground Observatory for Rare Events," CUORE Collaboration, <http://arxiv.org/abs/hep-ex/0501010>