

Optimal assignments with supervisions

Niv, Adi; Maccaig, Marie; Sergeev, Serge

DOI:

[10.1016/j.laa.2020.02.032](https://doi.org/10.1016/j.laa.2020.02.032)

License:

Creative Commons: Attribution-NonCommercial-NoDerivs (CC BY-NC-ND)

Document Version

Peer reviewed version

Citation for published version (Harvard):

Niv, A, Maccaig, M & Sergeev, S 2020, 'Optimal assignments with supervisions', *Linear Algebra and its Applications*, vol. 595, pp. 72-100. <https://doi.org/10.1016/j.laa.2020.02.032>

[Link to publication on Research at Birmingham portal](#)

General rights

Unless a licence is specified above, all rights (including copyright and moral rights) in this document are retained by the authors and/or the copyright holders. The express permission of the copyright holder must be obtained for any use of this material other than for purposes permitted by law.

- Users may freely distribute the URL that is used to identify this publication.
- Users may download and/or print one copy of the publication from the University of Birmingham research portal for the purpose of private study or non-commercial research.
- User may use extracts from the document in line with the concept of 'fair dealing' under the Copyright, Designs and Patents Act 1988 (?)
- Users may not further distribute the material nor use it for the purposes of commercial gain.

Where a licence is displayed above, please note the terms and conditions of the licence govern your use of this document.

When citing, please reference the published version.

Take down policy

While the University of Birmingham exercises care and attention in making items available there are rare occasions when an item has been uploaded in error or has been deemed to be commercially or otherwise sensitive.

If you believe that this is the case for this document, please contact UBIRA@lists.bham.ac.uk providing details and we will remove access to the work immediately and investigate.

Journal Pre-proof

Optimal assignments with supervisions

Adi Niv, Marie MacCaig, Sergeĭ Sergeev

PII: S0024-3795(20)30104-X

DOI: <https://doi.org/10.1016/j.laa.2020.02.032>

Reference: LAA 15319

To appear in: *Linear Algebra and its Applications*

Received date: 17 September 2019

Accepted date: 24 February 2020

Please cite this article as: A. Niv et al., Optimal assignments with supervisions, *Linear Algebra Appl.* (2020), doi: <https://doi.org/10.1016/j.laa.2020.02.032>.

This is a PDF file of an article that has undergone enhancements after acceptance, such as the addition of a cover page and metadata, and formatting for readability, but it is not yet the definitive version of record. This version will undergo additional copyediting, typesetting and review before it is published in its final form, but we are providing this version to give early visibility of the article. Please note that, during the production process, errors may be discovered which could affect the content, and all legal disclaimers that apply to the journal pertain.

© 2020 Published by Elsevier.

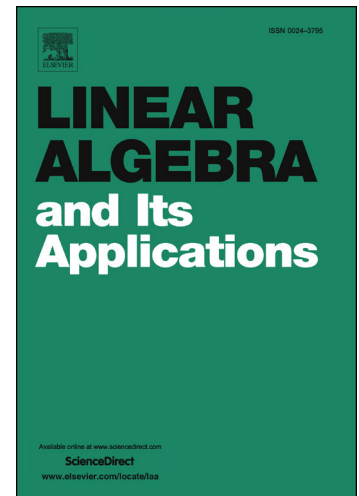

OPTIMAL ASSIGNMENTS WITH SUPERVISIONS

ADI NIV, MARIE MACCAIG, AND SERGEÏ SERGEEV

ABSTRACT. In this paper we provide a new graph theoretic proof of the tropical Jacobi identity, recently obtained in [AGN18]. We also develop an application of this theorem to optimal assignments with supervisions. That is, optimally assigning multiple tasks to one team, or daily tasks to multiple teams, where each team has a supervisor task or a supervised task.

Keywords: Optimal assignment problem, tropical algebra, weighted graphs, compound matrix, permanent.

AMSC: 05C17; 05C22; 05C38; 05C50; 05E15; 15A15; 15A24; 15A80; 90B80.

1. INTRODUCTION

The tropical semiring \mathbb{R}_{\max} is the set $\mathbb{R} \cup \{-\infty\}$ of real numbers formally joined with $-\infty$, equipped with the additive operation $a \oplus b = \max\{a, b\}$ and the multiplicative operation $a \odot b = a + b$ (for all $a, b \in \mathbb{R}_{\max}$). In this language, the *tropical permanent* of a matrix $A \in \mathbb{R}_{\max}^{n \times n}$ is

$$\text{per}(A) = \bigoplus_{\pi \in S_n} \bigodot_{i \in [n]} A_{i, \pi(i)} = \max_{\pi \in S_n} \sum_{i \in [n]} A_{i, \pi(i)},$$

and $\sigma \in S_n$ is an *optimal permutation* if $\text{per}(A) = \bigodot_{i \in [n]} A_{i, \sigma(i)} = \sum_{i \in [n]} A_{i, \sigma(i)}$. Here $[n] = \{1, \dots, n\}$ and S_n is the set of all permutations on $[n]$.

For $A \in \mathbb{R}_{\max}^{n \times n}$ we denote by $A[I, J]$ or $A_{I, J}$, where $I \subset [n], J \subset [n]$, the $|I| \times |J|$ *submatrix* of A with rows in I and columns in J . Given $I \subseteq [n]$ we denote by I^c the complement of I (so that $I \cup I^c = [n]$ and $I \cap I^c = \emptyset$).

The *tropical adjoint* $\text{adj}(A)$ of $A \in \mathbb{R}_{\max}^{n \times n}$ is defined by $\text{adj}(A)_{i, j} = \text{per}(A_{\{j\}^c, \{i\}^c})$, i.e. $(\sum_{i \in [n]} A_{i, \pi(i)} - A_{j, i})$ for some permutation $\pi \in S_n$ such that $\pi(j) = i$ and such that it is optimal among all such permutations.

Motivated by Butkovič's combinatorial interpretations of various objects in tropical algebra (see [But03]), and in particular, since optimal permutations are associated to the optimal assignment problem, we ask whether there exists an interpretation to tropical identities, focusing on Jacobi identity, using some form of 'partial assignment problem' and/or 'multiple assignment problem'.

The tropical Jacobi identity of a matrix A , if $\text{per}(A) = 0$, states that the permanent of a $k \times k$ submatrix of $\text{adj}(A)$ is either equal to or surpasses the permanent of the corresponding $(n - k) \times (n - k)$ -submatrix of A . This tropical identity was obtained in [AGN18], motivated by the classical Jacobi identity described in [FJ11, Section 1.2].

The first author was supported by INRIA postdoctoral fellowship and the Chateaubriand grant.

The second author was supported by a public grant as part of the *Investissement d'avenir* project, reference ANR-11-LABX-0056-LMH, LabEx LHM.

The third author was supported by EPSRC Grant EP/P019676/1.

The digraph associated with the permanent of A describes the well known optimal assignment problem in the sense that $\text{per}(A)$ provides the weight of optimal permutations in the digraph associated with A . When we consider the digraph associated with $\text{adj}(A)_{i,j}$, we are optimizing over permutations in S_n with a single edge removed. In this language, we provide a graph theoretic proof of a tropical analogue of the Jacobi identity, by showing that the weight of an optimal permutation of the digraph associated with a $k \times k$ submatrix of $\text{adj}(A)$ either equals to the weight of the optimal permutation of the digraph associated with the corresponding $(n - k) \times (n - k)$ -submatrix of A , or there exist at least two such optimal permutations.

Motivated by this graph theoretic proof, we study the optimal assignment problem under a given condition or requirement that a person i performs a fixed assignment j , whose cost/profit is out of consideration and would later be considered as the supervisor assignment.

We develop applications to team assignments, where supervision needs to take place. Thus we show that the Jacobi identity is closely related to optimizing multiple tasks, involving multiple teams, daily assignments, supervisor assignment or supervised assignments.

2. PRELIMINARIES

We provide some known graph theory definitions, as well as define ways to represent multiple assignments as series of perfect matchings.

2.1. Basic definitions.

Definition 2.1. A *digraph* (or directed graph) is an ordered pair $G = (V_G, E_G)$ where V_G is a set whose elements are called *nodes* (or vertices), and E_G is a set of ordered pairs of vertices, called *directed edges* (or arcs), allowing loops.

The number of edges terminating (resp. originating) at $v \in V_G$ is denoted by $\deg^-(v)$ (resp. $\deg^+(v)$). The *source* (resp. *target*) of an edge $e \in E_G$ is denoted by $s(e)$ (resp. $t(e)$). The edge e may also be denoted by (v_i, v_j) if $v_i = s(e), v_j = t(e)$. A graph is called *simple* if it does not have multiple edges.

A *multigraph* is a (di)graph which is permitted to have multiple edges that have the same end nodes. Thus two vertices may be connected by more than one edge. We say two multigraphs are equal if they have the same edge set, counting multiplicities.

Definition 2.2. A *bipartite graph* $H = (V_{H,1}, V_{H,2}, E_H)$ is a nondirected graph such that $i \in V_{H,1}$ if and only if $j \in V_{H,2}$ for every $(i, j) \in E_H$. The number of edges exiting $v \in V_{H,1} \cup V_{H,2}$ is denoted by $\deg(v)$. We say H is *equally partitioned* if $|V_{H,1}| = |V_{H,2}|$. The *complete bipartite graph*, denoted $K_{m,n}$ is the bipartite graph

$$G = ([m], [n], E) : E = \{(u, v) : u \in [m], v \in [n]\}.$$

A *star* is the complete bipartite graph $K_{1,k}$, denoted as ST_k .

Definition 2.3. A graph (resp. digraph, and in particular multigraph) $G = (V, E)$ is *k-regular* if $\deg(v) = k$ (resp. $\deg^+(v) = \deg^-(v) = k$), $\forall v \in V$.

Definition 2.4. A *path* in a digraph $G = (V, E)$ is a sequence of nodes and edges, $P = (v_1, e_1, v_2, e_2, \dots, e_{n-1}, v_n)$ such that, for all $i \in [n-1]$, $e_i = (v_i, v_{i+1})$. In particular, $s(P) = s(e_1) = v_1$, $t(P) = t(e_{n-1}) = v_n$. If $v_1 = v_n$, then P is *closed*. If P is a path

in which all intermediate nodes are distinct, and different from its source and target, then P is *elementary* and denoted by (v_1, v_2, \dots, v_n) (when clear which edges are used). The *length of a path* $\ell(P) = n - 1$ is the number of its edges. A *cycle* is an elementary closed path, denoted by $(v_1, v_2, \dots, v_{n-1}, v_1)$.

Definition 2.5. Let $G = (V, E)$ be a graph and $E' \subseteq E$. The *subgraph of G induced by $E' \subseteq E$* is the subgraph $G' = (V(E'), E')$, where $V(E') \subseteq V$ denotes the set of endpoints (sources and targets when G is a digraph) of E' .

Definition 2.6. If $G = (V_G, E_G)$ and $H = (V_H, E_H)$, then $G + H = (V_G \uplus V_H, E_G \uplus E_H)$ is called the *disjoint union graph*. The graph kG is formed of k disjoint copies of G .

Definition 2.7. We say $G = (V, E)$ is a *k -bipartite* graph if

$$E = \bigsqcup_{r=1}^k E_r,$$

where $B_r = (U_r, V_r, E_r)$, $U_r, V_r \subseteq V$, $\forall r \in [k]$ are bipartite graphs. We say G is *equally partitioned* if $|U_1| = \dots = |U_k| = |V_1| = \dots = |V_k|$.

The graph G is *disjoint- k -bipartite* if $G = B_1 + \dots + B_k$. The graph G is *star- k -bipartite* if $\{B_r\}_{r \in [k]}$ are *glued* at a common vertex set: $V_r = V$, $\forall r \in [k]$, and G may be denoted by (U_1, \dots, U_k, V, E) . The graph G is *path- k -bipartite* if $\{B_r\}_{r \in [k]}$ are *concatenated*: $V_r = U_{r+1}$, $\forall r \in [k-1]$, and G may be denoted by (U_1, \dots, U_{k+1}, E) .

The number of edges exiting $v \in V_r$ towards V_{r-1} (resp. V_{r+1}) is denoted by $\deg_t(v)$ (resp. $\deg_s(v)$).

Lemma 2.8. *There exists a one-to-one correspondence from the set of digraphs with n nodes onto the set of equally partitioned bipartite graphs with $2n$ nodes.*

Proof. Let (V_G, E_G) be a digraph, and $(V_{H,1}, V_{H,2}, E_H)$ be an equally partitioned bipartite graph. We define the correspondence by duplicating the set V_G : $v_i \in V_{H,1}, u_i \in V_{H,2}$, $\forall i \in V_G$, which function as the sets of sources and targets respectively. That is, $(v_i, u_j) \in E_H$, $\forall (i, j) \in E_G$. This correspondence is of course one-to-one and onto. \square

Lemma 2.9. *There exists a one-to-one correspondence between all equally partitioned k -bipartite graphs.*

Proof. Straightforward, using their B_r -presentations. \square

Example 2.10. See Figure 1. The bold edges correspond to the digraph on top and will be recalled later on.

2.2. Definitions related to assignment problems. Let S_n denote the set of permutations on $[n]$, and $S_{I,J}$ denote the set of bijections from $I \subseteq [n]$ to $J \subseteq [n]$ (that is, $|I| = |J|$). Recall that the zero element $\mathbb{0}$ of \mathbb{R}_{\max} is $-\infty$, the unit element $\mathbb{1}$ of \mathbb{R}_{\max} is 0, and for $A \in \mathbb{R}_{\max}^{n \times n}$ the max-plus permanent is given by

$$\text{per}(A) = \max_{\pi \in S_n} \sum_{i \in [n]} A_{i, \pi(i)}.$$

We recall the correspondence between weighted simple digraphs and square matrices. Let $G = (V, E, w)$ be a weighted digraph, where $w(e)$ denotes the weight of the edge $e \in E$. For an $n \times n$ matrix M , we associate a weighted simple digraph $G_M = ([n], E, w)$,

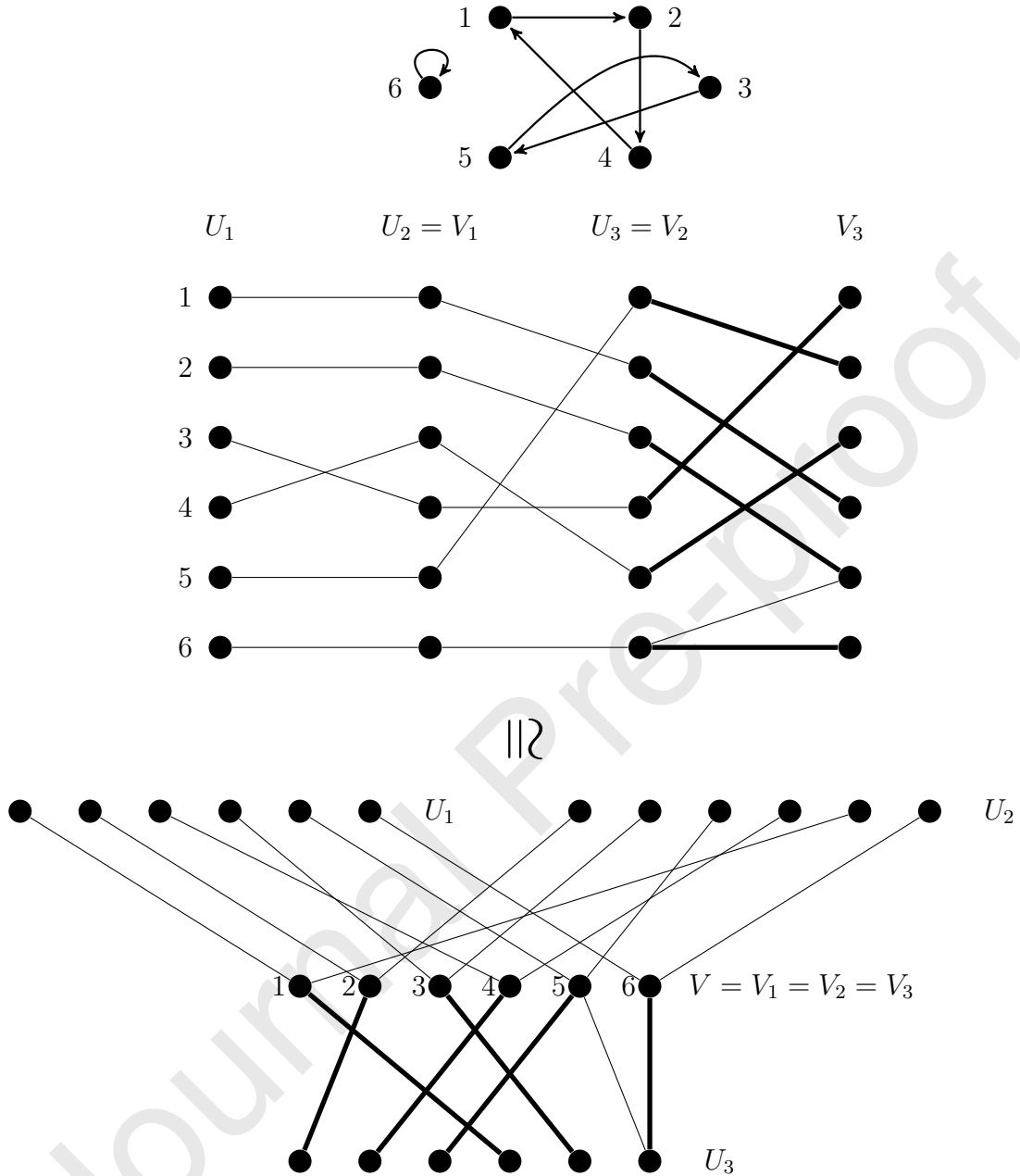

FIGURE 1. Correspondence between path-3-bipartite and star-3-bipartite

where for all $M_{i,j} \neq 0$, $(i, j) \in E$ with $w(i, j) = M_{i,j}$. Conversely, for a weighted simple digraph $G = ([n], E, w)$ we associate an $n \times n$ weight matrix M_G , where

$$M_{i,j} = \begin{cases} w(i, j) & ; \text{ if } (i, j) \in E, \\ 0 & ; \text{ otherwise.} \end{cases}$$

See for instance the correspondence in Figure 2 between the 3×3 matrix M and the weighted simple digraph G with node-set $[3]$, where the edge-value denotes its weight.

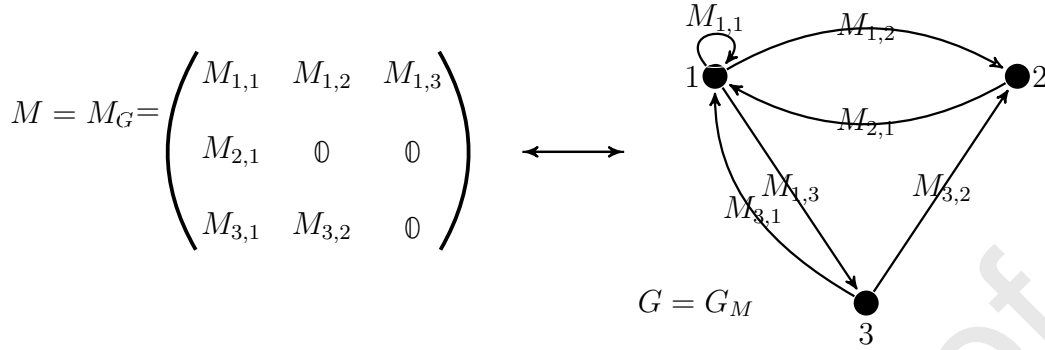

FIGURE 2. Associated square matrix and simple weighted digraph

To a max-plus product P of entries of $M \in \mathbb{R}^{n \times n}$, we assign a sub-digraph with the set of edges E_P (multiplicities allowed) that correspond to the entries in the max-plus product, and the set of nodes $V(E_P)$. In particular, we have the *bijection-subdigraph* $G = (V(E_\pi), E_\pi)$, where $\pi \in S_{I,J}$, corresponding to the max-plus product $P = \bigodot_{i \in [I]} M_{i,\pi(i)}$, and satisfying $\deg^+(v) = \deg^-(u) = 1$, $\forall v \in I, u \in J$.

Thus, in the sense of Lemma 2.8, G corresponds to a 1-regular bipartite graph B , where $V_{B,1} = I$, $V_{B,2} = J$, which is a perfect matching. The set of permutations of maximal weight in M (or optimal permutations of M), denoted by

$$\text{ap}(M) = \left\{ \pi \in S_n : \text{per}(M) = \bigodot_{i \in [n]} M_{i,\pi(i)} \right\},$$

is identical to the set of optimal solutions to the assignment problem in the graph corresponding to the digraph associated with M .

Example 2.11.

- (1) Every non-0 (max-plus) summand $\bigodot_{i \in [n]} M_{i,\pi(i)}$ in the permanent of M may be assigned with the permutation-subgraph of G_M

$$V(E_\pi) = [n], E_\pi = \{(i, \pi(i)) \mid \forall i \in [n]\}.$$

- (2) The upper-right bipartite subgraph and bold perfect matching in Figure 1, correspond to the digraph and its bold permutation in Figure 3

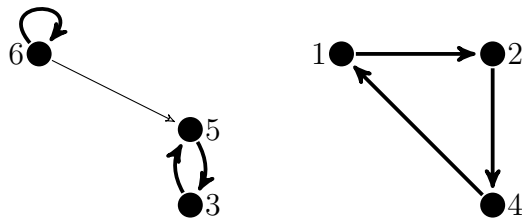

FIGURE 3. A digraph and its permutation subgraph

Definition 2.12. We say that a bipartite graph H is *perfect* if

$$\deg(v) = 1 \quad \forall v \in V_{H,1} \cup V_{H,2}.$$

A disjoint- k -bipartite graph $G = (V, E)$ is perfect if $\deg(v) = 1$ for all $v \in V(G)$. Consequently, a path- k -bipartite or star- k -bipartite graph is called perfect if it corresponds to a perfect disjoint- k -bipartite graph.

Formally, a path- k -bipartite graph $H = (V_1, \dots, V_{k+1}, E)$ is perfect if

$$\deg^+(v) = \deg^-(u) = \deg^+(u) = \deg^-(w) = 1, \quad \forall v \in V_{H,1}, u \in \bigcup_{\ell \in [k-2]} V_{H,\ell+1}, w \in V_{H,k},$$

and a star- k -bipartite graph $G = (U_1, \dots, U_k, V, E_G)$ is perfect if for every $i \in [k]$

$$\deg(u) = 1, \quad \forall u \in U_i.$$

The following proposition is a result of Lemma 2.8, Hall's Marriage Theorem [Slo02] and Proposition 3.17, [IR11].

Proposition 2.13. *A k -regular digraph (and in particular multigraph) corresponds to a perfect k -bipartite graph, and its edge-set is the disjoint union of edge-sets of k permutation-subgraphs.*

The correspondence is demonstrated in Figure 4.

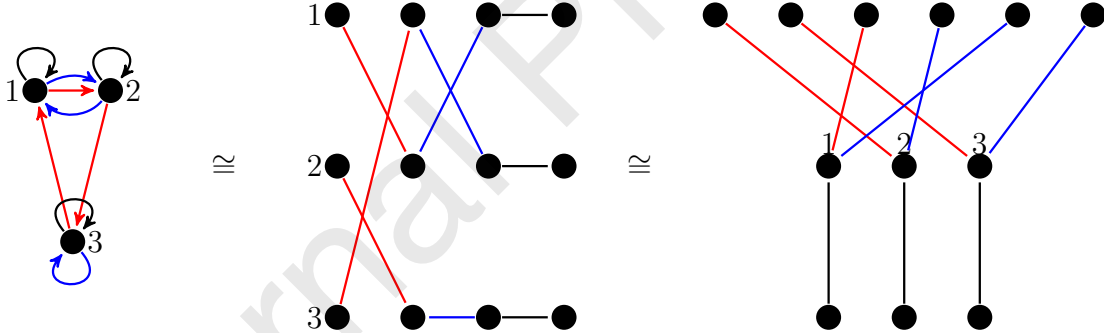

FIGURE 4. Correspondence between 3-regular digraph and perfect 3-bipartites.

Definition 2.14. Let $G = ([n], E)$ be a k -regular multigraph, and let

$$E = \bigsqcup_{i \in [k]} E_{\rho_i}, \quad \rho_i \in S_n$$

be the disjoint union of edge-sets of k permutation-subgraphs $G_i = ([n], E_{\rho_i})$ of G . We say G is (ℓ, k) -regular with respect to $\{I_j, J_j : |I_j| = |J_j| = k \quad \forall j \in [\ell]\}$ if there exist $e_{i_1}, \dots, e_{i_\ell} \in E_{\rho_i} \quad \forall i \in [k]$ such that

$$(V(E_{\pi_j}), E_{\pi_j} = \{e_{1_j}, \dots, e_{k_j}\}), \quad j \in [\ell], \quad \pi_j \in S_{I_j, J_j}$$

are ℓ disjoint bijection-subgraphs. (In particular $|E_{\pi_j}| = k, \quad \forall j \in [\ell]$.) We denote

$$G = ([n], \bigsqcup_{i \in [k]} E_{\rho_i}, \{\pi_j\}_{j \in [\ell]}).$$

Example 2.15.

- (1) The digraph in Figure 4 is $(1, 3)$ -regular with respect to $I = J = [3]$, where $\pi = (1\ 2)$ is constructed from red edge $(1, 2)$, blue edge $(2, 1)$ and black loop $(3, 3)$, as indicated by green edges in Figure 5. This is a special case where $n = k$.

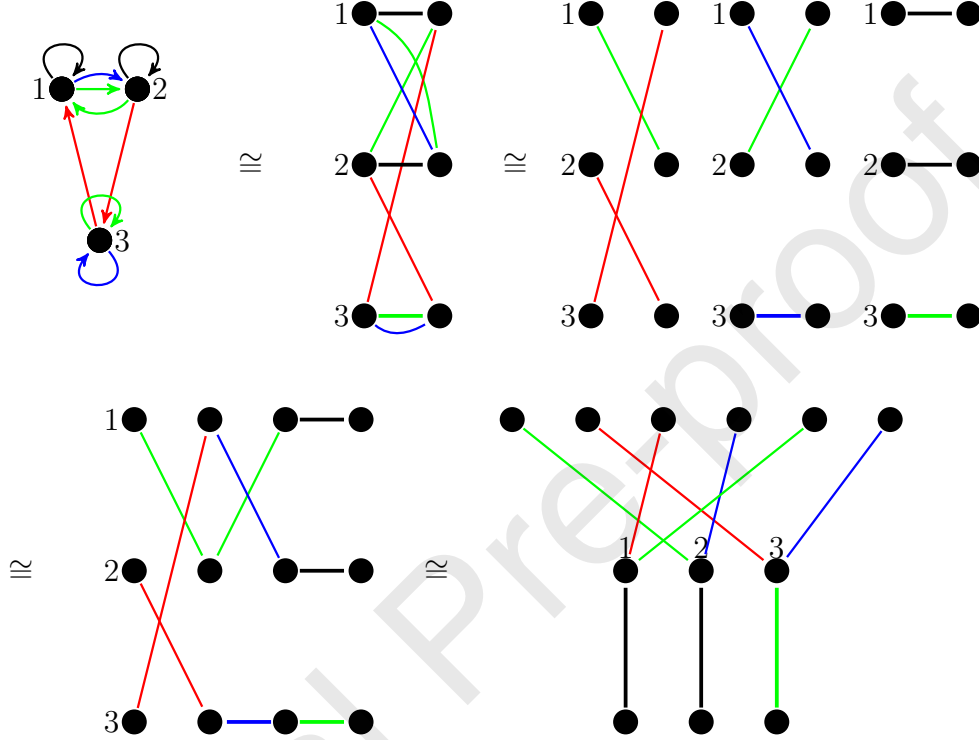

FIGURE 5. $(1, 3)$ -regular.

- (2) If $G = ([n], \biguplus_{i \in [k]} E_{\rho})$ for some $\rho \in S_n$, then for every $I \subseteq [n] : |I| = k$, the digraph G is (k, k) -regular with respect to $I = I_j, J = J_j, \forall j \in [k]$, where

$$\pi_j = \pi = \rho|_I \in S_{I,J}, \forall j \in [k].$$

It is also $(n - k + 1, k)$ -regular with respect to

$$I_j = \{t + j - 1 : t \in [k]\}, J_j = \{\rho(t + j - 1) : t \in [k]\}, j \in [n - k + 1],$$

where

$$E_{\pi_{j+1}} = \{(j + k, \rho(j + k))\} \biguplus E_{\pi_j} \setminus \{(j, \rho(j))\}.$$

- (3) A filled Sudoku table represents an (ℓ, k) -regular digraph, with respect to $I = J = [9]$, where $n = k = \ell = 9$.

The rough idea behind Example 2.15 part (1) is to present a set of assignments of people to jobs, using permutations over multi-digraphs. Observing Figure 5, this can be applied in different equivalent ways. For instance, assigning different sets of jobs to the same team, or the same set of jobs to different teams, as described by the lower-right star-3-bipartite graph. One may assign a team of experienced workers to tutor new workers, which 6 months later will tutor newer workers, and so on, as described

by the lower-left path-3-bipartite graph. In this paper, we consider assigning the same set of jobs, to the same team over a given time interval, as described in the middle-upper multi-digraph, or assigning different jobs to different teams, as described in the right-upper disjoint-3-bipartite graph.

Additionally, we want to be able to consider assignments performed under some restrictions. That is, for a single assignment relating to G_A , one edge is fixed, and we consider all perfect matchings including this edge.

Definition 2.16. Let $A \in \mathbb{R}_{\max}^{n \times m}$. We denote by $A^{\wedge k} \in \mathbb{R}_{\max}^{\binom{n}{k} \times \binom{m}{k}}$ the max-plus k^{th} compound matrix of A defined by

$$A_{I,J}^{\wedge k} = \max_{\substack{\sigma: I \rightarrow J \\ \text{bijection}}} \sum_{i \in I} A_{i, \sigma(i)} \quad \forall I \subseteq [n] \text{ and } J \subseteq [m] : |I| = |J| = k.$$

In particular, $A^{\wedge 1} = A$, $A^{\wedge 0} = \mathbb{1}$ and $\text{per}(A) = A^{\wedge n}$ is the max-plus permanent of A when $n = m$. In this case we denote by $\text{adj}(A)_{i,j} = A_{\{j\}^c, \{i\}^c}^{\wedge n-1}$ the (i, j) entry of the max-plus adjoint of A .

For a non- \emptyset product of concatenating entries of $M \in \mathbb{R}^{n \times n}$

$$P = M_{j_1, j_2} \odot M_{j_2, j_3} \odot \cdots \odot M_{j_k, j_{k+1}},$$

the edge-set of the digraph $G = (V(E_P), E_P)$ corresponds to a path

$$p = e_1 \cdots e_k : s(e_i) = j_i, t(e_i) = j_{i+1} \quad \forall i \in [k]$$

of length $l(p) = k$, from $s(p) = s(e_1) = j_1 \in V(E_P)$ to $t(p) = t(e_k) = j_{k+1} \in V(E_P)$, and with weight $w(p) = \odot_{i \in [k]} w(e_i, G)$. When it is clear which matrix we are using we may just write $w(p)$.

We decompose a bijection $\rho \in S_{I,J}$ (and in particular, when $I = J$, a permutation) into disjoint cycles whose set is denoted by \mathcal{C} , and elementary paths whose set is denoted by \mathcal{P} . This corresponds to the restrictions $\rho|_{\overline{s(p)}}$, $s(p) \in I$, where

$$\overline{s(p)} = \{j \in I : \text{s.t. } \rho^m(s(p)) = j \text{ for some } m \in \mathbb{N}\}.$$

The quotient set

$$\begin{aligned} & \{\overline{s(p)} : p \text{ is a cycle or an elementary path of } \rho\} = \\ & \underbrace{\{\overline{s(p)} : \rho^m(s(p)) \in I, \forall m \in \mathbb{N}\}}_{\text{corresponds to } \mathcal{C}} \cup \underbrace{\{\overline{s(p)} : \exists m_p \in \mathbb{N} \text{ s.t. } \rho^{m_p}(s(p)) \notin I\}}_{\text{corresponds to } \mathcal{P}} \end{aligned}$$

is the partition of I corresponding to the source-nodes of the disjoint cycles and paths of ρ . Moreover, a bijection-subgraph $G' = (V(E_\rho), E_\rho) \subseteq G = ([n], E)$ satisfies

$$E_\rho = \{e \in E : t(e) = \rho(s(e)) \quad \forall s(e) \in I\}, \quad \deg^+(i) = \deg^-(\rho(i)) = 1 \quad \forall \rho(i) \in J, i \in I,$$

and

$$w(\rho) = \underbrace{\bigodot_{\overline{s(p)}} \bigodot_{s(e) \in \overline{s(p)}}}_{\text{cycles}} w(e) = \underbrace{\bigodot_{\overline{s(p)} \in \mathcal{C}} \bigodot_{\overline{s(p)} \in \mathcal{P}}}_{\text{paths}} w(p), \quad \text{where } \rho^{m_p}(s(p)) = \begin{cases} s(p), \overline{s(p)} \in \mathcal{C} \\ t(p), \overline{s(p)} \in \mathcal{P} \end{cases}.$$

(That is, over \mathbb{R}_{\max} , the weight of a permutation is the sum of weights of its disjoint cycles and paths, which is the sum of weights of its edges).

In particular, every elementary path (resp. cycle) is a bijection (resp. permutation) from its set of source-nodes to its set of target-nodes, and can be extended to a bijection $J^c \cup I \rightarrow I^c \cup J$ (resp. permutation in S_n) by composing it with the loops

$$e : s(e) = t(e) = j, \forall j \in I^c \cap J^c \text{ (resp. } j \in I^c).$$

Every bijection $\rho \in S_{I,J}$ can be extended to a permutation $\pi \in S_{I \cup J}$ by defining

$$\pi(j) = \begin{cases} \rho(j) & , j \in I \\ s(p) & , j = t(p) \in J \setminus I \end{cases}$$

In the same way, every permutation $\pi \in S_I = S_{I,I}$ can be reduced to a bijection $\rho \in S_{J,K}$, $J, K \subseteq I : K = \{\pi(j) : j \in J\}$ by defining $\rho = \pi|_J$.

We note that a path p from $s(p)$ to $t(p)$ can be decomposed into (not necessarily disjoint) cycles and an elementary path from $s(p)$ to $t(p)$.

Definition 2.17. Let $I, J \subseteq [n]$ such that $|I| = |J| = k$. We say that $\pi \in S_n$ is an *optimal permutation* in a simple digraph $G = ([n], E)$ weighted over \mathbb{R}_{\max} , if $w(\pi) \geq w(\tau) \forall \tau \in S_n$, or equivalently

$$\text{per}(M_G) = \sum_{i \in [n]} (M_G)_{i, \pi(i)}.$$

We say that $\sigma \in S_{I,J}$ is an *optimal bijection with respect to I, J* in G if $w(\sigma) \geq w(\rho) \forall \rho \in S_{I,J}$, or equivalently

$$(M_G)_{I,J}^{\wedge k} = \sum_{i \in I} (M_G)_{i, \sigma(i)}.$$

We say that $([n], \biguplus_{i \in [k]} E_{\rho_i}, \sigma)$ is an *optimal $(1, k)$ -regular multigraph* of G with respect to I, J if

$$\left(\sum_{i \in [k]} w(\rho_i) \right) - w(\sigma) \geq \left(\sum_{i \in [k]} w(\rho'_i) \right) - w(\sigma'),$$

for every $(1, k)$ -regular multigraph $([n], \biguplus_{i \in [k]} E_{\rho'_i}, \sigma')$ of G with respect to I, J . Equivalently

$$(\text{adj}(M_G))_{J,I}^{\wedge k} = \sum_{i \in I} (\text{adj}(M_G))_{\sigma(i), i}, \text{ where } (\text{adj}(M_G))_{\sigma(i), i} = \sum_{j \in \{i\}^c} (M_G)_{j, \rho_i(j)}.$$

Note that, the rough idea here is to represent a set of assignments of people to jobs. In the assignment problem for example, we have a matrix A associated with a digraph $G_A = ([n], E_G)$ on which we find an optimal permutation π , which can equivalently be viewed as a perfect matching in a bipartite graph $B = ([n], [n], E_B)$ corresponds to G_A . We want to extend this to the problem of multiple assignments. Trivially k assignments can be represented as $M_1 + M_2 + \dots + M_k$ where each M_r , $r \in [k]$ is a perfect matching. These can also be viewed as a perfect k -bipartite graph, or specific versions of a perfect star/path/disjoint- k -bipartite graph.

More importantly, we want to be able to consider assignments performed under some restrictions. That is, for a single assignment relating to G_A , one edge is fixed (in some to-be-defined way), and we consider all perfect matchings including this edge.

3. COMBINATORIAL INTERPRETATION OF THE COMPOUND MATRIX OF THE TROPICAL ADJOINT

We describe a new form of the assignment problem whose solutions are given by entries of the compound matrix of the tropical adjoint.

Given is a set of n workers and n assignments. The entries of a matrix $M \in \mathbb{R}_{\max}^{n \times n}$ represent the *value* of person i performing assignment j . This value could, for example, be the negative cost of the assignment, the negative time taken, the persons experience level of performing the job, or some function of multiple factors.

The usual assignment problem finds an assignment of people to jobs which maximises the value. The assignment problem can be solved in $\mathcal{O}(n^3)$ [Mun57] time by the Hungarian Algorithm [Kuh55] which transforms to a non-positive matrix $B = D_1 \otimes M \otimes D_2$, D_1, D_2 diagonal. This transformation preserves the set of permutations of maximum weight and B additionally has the property that every permutation π of maximum weight satisfies $B_{i, \pi(i)} = 0, \forall i$.

Suppose that, within a workplace, the same n jobs have to be performed each day, and one person is required to perform each task (possibly using specialist equipment). Additionally, a supervisor wishes to observe, or train, a subset of his employees on various tasks/pieces of equipment throughout the week. On each day he will observe one worker and one task.

Then, a set of k assignments of workers to tasks is required which additionally has the property that, in each assignment, a different worker $i \in I$ performs a different task $j \in J$.

Definition 3.1. We define k assignments with supervisions I on J to be permutations $\pi_1, \dots, \pi_k \in S_n$ with a supervision $\tau : I \rightarrow J$ with $\tau(i_t) := j_t, \forall t \in [k]$ with the property that $\pi_t(i_t) = j_t, \forall t \in [k]$.

Remark 3.2. Obviously, for a week of assignments where there is one supervision per day we set $k = 5$. We can generalise from *weekly* to daily/hourly and so on by changing the value of k .

Example 3.3. Let $I = \{1, 3, 6\}$ and $J = \{2, 3, 5\}$. Shown in Figure 6 is a set of three assignments $\pi_1, \dots, \pi_3 \in S_6$ with the property that, distributed over the assignments is a permutation $\tau \in S_3$ representing the supervisions.

Given that the supervisor has deemed it necessary that each worker $i \in I$ performs one of the tasks $j \in J$, it is accepted that the full assignment of people to jobs may not be optimal under this condition (for example if the supervisor wishes to train a worker i for job j , the worker won't have experience of this job, and the value $M_{i,j}$ will be low). Thus, we aim to optimise the value of all other assignments throughout the week, ignoring the value of the supervisions I on J . This leads to the following definition.

Definition 3.4. Let $M \in \mathbb{R}_{\max}^{n \times n}$. The *base value* of k assignments ρ_t for $t \in [k]$ with supervisions $(i_t, j_t) \in I \times J$ defined by a bijection $\sigma : I \rightarrow J$ is the weight of the $(1, k)$ -regular multigraph $([n], \biguplus_{t \in [k]} E_{\rho_t}, \sigma)$

$$\sum_{t \in [k]} (w(\rho_t, M) - M_{i_t, \sigma(i_t)}) = \sum_{t=1}^k \sum_{i \neq i_t} M_{i, \rho_t(i)}.$$

OPTIMAL ASSIGNMENTS WITH SUPERVISIONS

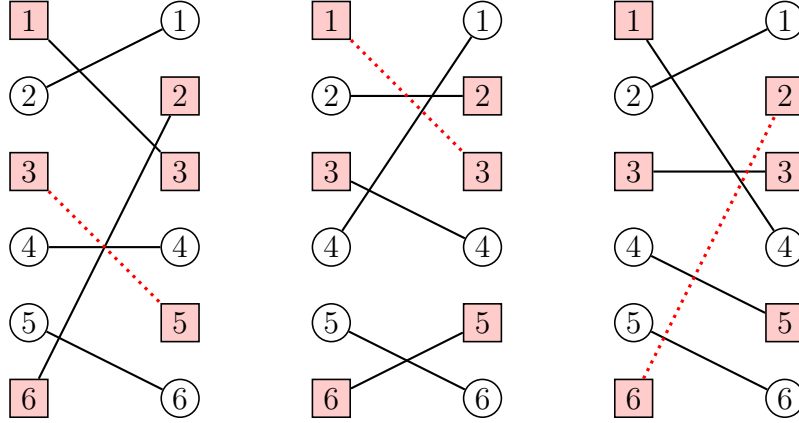
FIGURE 6. 3 Assignments with supervisions $\{1, 3, 6\}$ on $\{2, 3, 5\}$.

Example 3.5. The base value for the 3 assignments with supervisions shown in Figure 6 is

$$\begin{aligned} & (M_{1,3} + M_{2,1} + M_{4,4} + M_{5,6} + M_{6,2}) \\ & + (M_{2,2} + M_{3,4} + M_{4,1} + M_{5,6} + M_{6,5}) \\ & + (M_{1,4} + M_{2,1} + M_{3,3} + M_{4,5} + M_{5,6}). \end{aligned}$$

Observation 3.6. *The optimal (with respect to M) base value of k assignments with supervisions I on J is equal to the weight of optimal $(1, k)$ -regular multigraph with respect to I and J , which is*

$$\bigoplus_{\sigma \in \mathcal{S}_{J,I}} w(\sigma, \text{adj}(M)_{J,I}) = [\text{adj}(M)]_{J,I}^{\wedge k}.$$

Notation 3.7. Solution of an optimization problem is in general non-unique, and so is (in general) the solution of the optimal assignment problem associated with any particular entry of $\text{adj}(M)$. Below we will indicate the presence of multiple optimal solutions to this problem by the superscript \bullet , being inspired by [BCOQ92, Gau92].

Notation 3.8. For a bijection $\beta : I \rightarrow J$ we will also use the notation

$$\beta = (i_1, j_1), (i_2, j_2), \dots, (i_k, j_k)$$

where $\beta(i_t) = j_t$ for $t \in [k]$.

Example 3.9. Let

$$M = \begin{pmatrix} 0 & 1 & -2 & -4 \\ -3 & 0 & 5 & 2 \\ -5 & 4 & 0 & 6 \\ -1 & -6 & 3 & 0 \end{pmatrix}, \text{ then } \text{adj}(M) = \begin{pmatrix} 9 & 10 & 6^\bullet & 12 \\ 10 & 9 & 5^\bullet & 11 \\ 5 & 6 & 2 & 6^\bullet \\ 8 & 9 & 5 & 9 \end{pmatrix}.$$

Suppose we want 2 assignments of people to jobs with maximum base value such that we additionally supervise $I = \{2, 4\}$ on $J = \{1, 2\}$.

The maximum base value is given by

$$\text{adj}(M)_{J,I}^{\wedge 2} = \text{per} \begin{pmatrix} 10 & 12 \\ 9 & 11 \end{pmatrix} = 21^\bullet.$$

Here, after accounting for the transposition in $\text{adj}(M)$, we get that the bijections/supervisions attaining this maximum value are $\sigma_1 = (2, 1)(4, 2)$ (corresponding to the identity permutation in $\text{adj}(M)_{J,I}$) and $\sigma_2 = (2, 2)(4, 1)$ (corresponding to permutation (12)(21) in $\text{adj}(M)_{J,I}$).

Of course, we could finish here and report both of these assignments with supervisions as solutions, returning $S = \{\sigma_1, \sigma_2\}$ as the solution set. But it may be that, given a subset S of k assignments with supervisions I on J which all have the same base value, it is desired that we return the 'best' of these under some criteria. Obviously we could consider which of the supervisions in S have the optimal value in

$$M[I, J] = \begin{pmatrix} -3 & 0 \\ -1 & -6 \end{pmatrix}.$$

In this case the optimum is clearly given by σ_2 .

However, it could be that this is not the best criteria to differentiate between supervisions. Consider, for example, the following: a low value of $M_{i,j}$ could indicate that worker i has not been trained for job j , in which case supervising/training i on j could be beneficial to the company as it would increase that workers skill set and usefulness in the future. In light of this, we consider a matrix C reflecting the value of supervising $i \in I$ on task $j \in J$.

Definition 3.10. We define $C \in \mathbb{R}_{\max}^{k \times k}$ to be the *priority matrix*, with rows $i \in I$ and columns $j \in J$, where $C_{i,j}$ is the priority the supervisor sets for supervising person $i \in I$ on task $j \in J$. Denoting by $E_{J,I}^{ap}$ the set of edges belonging to the optimal bijections in $\text{adj}(M)_{J,I}$, we will assume that

$$(3.1) \quad C_{i,j} \neq -\infty \Rightarrow (j, i) \in E_{J,I}^{ap},$$

and that at least one bijection from I to J has a finite weight with respect to C .

Note that by (3.1), finite priorities are assigned only for the edges in $E_{J,I}^{ap}$. Thus, assumption (3.1) allows the supervisors to assign only essential priorities and it can decrease their costs of assigning priorities from $O(k^2)$ to $O(k)$ if there is only a small number of optimal permutations in $\text{ap}(\text{adj}(M)_{J,I})$. Let us consider the computational cost of identifying $E_{J,I}^{ap}$, which is necessary for setting the priorities matrix C .

Proposition 3.11. *Given $A \in \mathbb{R}_{\max}^{n \times n}$ and $I, J \subseteq [n]$ with $|I| = |J| = k$, one needs no more than $O(k^2 n^3)$ operations to identify all edges of $E_{J,I}^{ap}$.*

Proof. We first compute $\text{adj}(M)_{J,I}$. To compute each entry $\text{adj}(M)_{j,i}$ we need to find an optimal bijection in $M_{\{i\}^c, \{j\}^c}$. This takes $O((n-1)^3)$ operations for each entry, and hence $O(k^2 n^3)$ operations for all k^2 edges.

We now identify the set of edges $E_{J,I}^{ap}$ from J to I that are contained in these bijections. To do this we first apply the Hungarian algorithm to $\text{adj}(M)_{J,I}$. Having complexity $O(k^3)$, it brings matrix $\text{adj}(M)_{J,I}$ to the form where all entries on optimal permutations are $\mathbb{1}$ and all other entries do not exceed $\mathbb{1}$. In order to identify all edges on optimal permutations we can further decrease the entries which do not lie on optimal permutations. This can be done, e.g., by means of the strict visualization scaling of [SSP09] in no more than $O(k^3)$ operations. \square

Note that in general, except for imposing (3.1), we do not assume that the entries of M and C are anyhow related to one another.

In other words, we now want to rate a set of k assignments with supervisions under two criteria. First, the set must have optimal base value with respect to assignment matrix A . Then, of those that meet this criteria, we can choose to optimise with respect to the supervision priority matrix C .

Example 3.12. Recalling Example 3.9, suppose that it is highly desired that person 2 is supervised on task 1, it is recommended that person 2 is supervised on task 2 and that person 4 is supervised on task 1, however person 4 is well-trained on task 2. Then we might set

$$(3.2) \quad C = \begin{pmatrix} 3 & 1 \\ 1 & 0 \end{pmatrix}$$

and conclude that the overall most valued supervisions are 2 on 1 with 4 on 2 (regardless of what we have in M and although 4 is well-trained on 2). That is, the supervision σ_1 is optimal.

Let us now formally define a general version of the optimization problem which we solved in Example 3.12.

Definition 3.13. Given an assignment matrix $M \in \mathbb{R}_{\max}^{n \times n}$ and a supervision priority matrix $C \in \mathbb{R}_{\max}^{k \times k}$, the optimal value of k assignments with supervisions $I \subset [n]$ on tasks $J \subset [n]$ prioritized by C is defined as

$$(3.3) \quad \text{adj}(M)_{J,I}^{\wedge k} \odot \text{per}(C) = \text{per}(\text{adj}(M)_{J,I}) \odot \text{per}(C),$$

where C is as in Definition 3.10.

Observation 3.14. For the value defined in (3.3) we have

$$(3.4) \quad \begin{aligned} \text{per}(\text{adj}(M)_{J,I}) \odot \text{per}(C) &= \bigoplus_{\sigma' \in S_{J,I}} w(\sigma', \text{adj}(M)_{J,I}) \odot \bigoplus_{\sigma \in S_{J,I}} w(\sigma^{-1}, C) \\ &= \bigoplus_{\sigma' \in S_{J,I}} w(\sigma', \text{adj}(M)_{J,I}) \odot \bigoplus_{\sigma \in \text{ap}(\text{adj}(A)_{J,I})} w(\sigma^{-1}, C). \end{aligned}$$

This value is attained by those k assignments with supervisions I of J for which the total value of these supervisions (computed from the priority matrix C) is the greatest.

Proposition 3.15. Given $M \in \mathbb{R}_{\max}^{n \times n}$, $I, J \subseteq [n]$, set $E_{J,I}^{\text{ap}}$ and $C \in \mathbb{R}_{\max}^{k \times k}$ that satisfies 3.1 one needs at most $O(k^3)$ operations to compute value (3.3) and no more than $O(kn^3)$ operations to identify a set of supervised assignments that attains that value.

Proof. We first compute $\text{per}(C)$ in at most $O(k^3)$ operations and identify a bijection $\beta \in \text{ap}(C)$. By (3.1) $(\beta(i), i) \in E_{J,I}^{\text{ap}}$ for each $i \in I$, hence $\beta^{-1} \in \text{ap}(\text{adj}(M)_{J,I})$ and we compute $w(\beta^{-1}) = \text{per}(\text{adj}(M)_{J,I})$ in $O(k)$ operations.

By now, value (3.3) has been found. In order to find a supervised assignment that attains that value we take $\beta \in \text{ap}(C)$ found previously, and for each edge (i, j) from that bijection we find an optimal bijection in $M_{\{i\}^c, \{j\}^c}$. This takes $O((n-1)^3)$ operations for each edge, and hence $O(kn^3)$ operations for all k edges of the bijection. \square

Remark 3.16. In the procedure described above, it is possible to decrease the amount of operations required to compute $\text{per}(C)$. Indeed, let m be the number of entries that are not equal to $-\infty$ in C . Applying the Fibonacci heaps technique of [FT87], the complexity of computing $\text{per}(C)$ is decreased to $O(k^2 \log k + km)$.

Example 3.17. In Example (3.12) we found that σ_1 is optimal if we take C as in (3.2). For the assignment $2 \rightarrow 1$ of σ_1 we consider

$$M[[4] \setminus \{2\}, [4] \setminus \{1\}] = \begin{pmatrix} \mathbf{1} & -2 & -4 \\ 4 & 0 & \mathbf{6} \\ -6 & \mathbf{3} & 0 \end{pmatrix},$$

which has optimal permutation shown in bold, corresponding to the bijection $\beta_1 = (1, 2)(3, 4)(4, 3)$. By adding in the supervision edge, we recover $\pi_1 = (1\ 2)(2\ 1)(3\ 4)(4\ 3)$. Similarly, for the supervision $4 \rightarrow 2$, we get the bijection $\beta_2 = (1, 1)(2, 3)(3, 4)$ which corresponds to $\pi_2 = (1)(2\ 3\ 4)$.

4. JACOBI IDENTITY

The following theorem is the tropical analogue of the Jacobi identity (see [FJ11]), and was recently proved in [AGN18].

Theorem 4.1. (*Jacobi identity*, [AGN18, Theorem 3.4]) *Let $M \in \mathbb{R}_{\max}^{n \times n}$ and $I, J \subseteq [n]$ such that $|I| = |J| = k$. For every $k \in \{0\} \cup [n]$, at least one of the following statements holds*

- (1) $[\text{per}(M)^{\odot -1} \text{adj}(M)]_{I,J}^{\wedge k} = \text{per}(M)^{\odot -1} M_{J^c, I^c}^{\wedge n-k}$,
- (2) *There exist distinct bijections $\pi, \sigma \in S_{I,J}$ such that*

$$[\text{adj}(M)]_{I,J}^{\wedge k} = \sum_{i \in I} \text{adj}(M)_{i, \pi(i)} = \sum_{i \in I} \text{adj}(M)_{i, \sigma(i)}.$$

Actually, the identity proved in [AGN18] is a true analogue of the original, for it is proved over an extension of the tropical semiring called *symmetrized* (see [Gau92]). The symmetrized tropical semiring is constructed by copies of \mathbb{R}_{\max} to include so called ‘balancing’ elements, and therefore include the signs of permutations throughout (in per , adj and $\wedge k$). Since in this paper we work over the (non-extended) tropical semiring, the signs are omitted from the formulation stated in Theorem 4.1.

The main purpose of this section will be to obtain a graph-theoretic counterpart of Theorem 4.1.

Let us consider the following kind of matrices.

Definition 4.2. $M \in \mathbb{R}_{\max}^{n \times n}$ is called **normalized** if Id is an optimal permutation of M (i.e., $\text{Id} \in \text{ap}(M)$) and $M_{i,i} = \mathbf{1}$ for all $i \in [n]$.

M is called **strictly normalized** if it is normalized and Id is the only optimal permutation (i.e., $\text{ap}(M) = \{\text{Id}\}$).

We will use the following result, whose proof will be skipped.

Lemma 4.3. *If $M \in \mathbb{R}_{\max}^{n \times n}$ is normalized (respectively, strictly normalized) then the weight of every cycle is not greater (respectively, smaller) than the weight of the identity permutation on its subset of nodes, and therefore the weight of every permutation is not greater (respectively, is smaller) than that of a permutation obtained by replacing either of its cycles by the corresponding identity permutation.*

We now consider optimal $(1, k)$ -regular multigraphs of the digraph associated with a normalized matrix.

Notation 4.4. Let $G = ([n], E)$ be a simple weighted digraph with n nodes associated with a normalized matrix, i.e., Id is an optimal permutation and all the loops (i.e., edges e with $s(e) = t(e)$) are in E and have weight $\mathbb{1}$. Let us construct an optimal $(1, k)$ -regular multigraph of G with respect to $I, J \subseteq [n]$. We will denote it by $F = ([n], \bigsqcup_{i \in [k]} E_{\rho_i}, \pi)$

Assume $\pi \neq \text{Id}$, and let

$$(4.1) \quad e_i \text{ be the edge of } E_{\pi} \text{ which is in } \rho_i,$$

$$(4.2) \quad C_i \text{ be the cycle in } \rho_i \text{ which includes } e_i,$$

$$(4.3) \quad P_i \text{ be the elementary path such that } C_i = P_i \circ e_i.$$

One can find ρ_i, C_i, P_i, e_i described in Figures 7 and 8 in case that ρ_i has no more than one cycle which is not a loop.

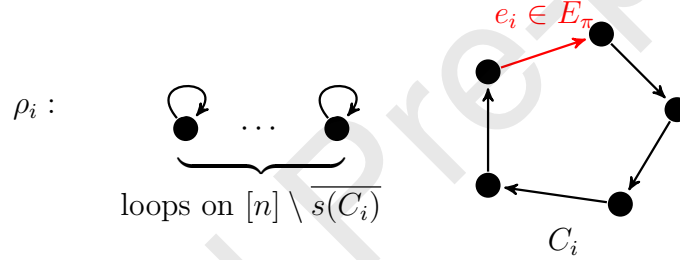

FIGURE 7. Paths and cycles

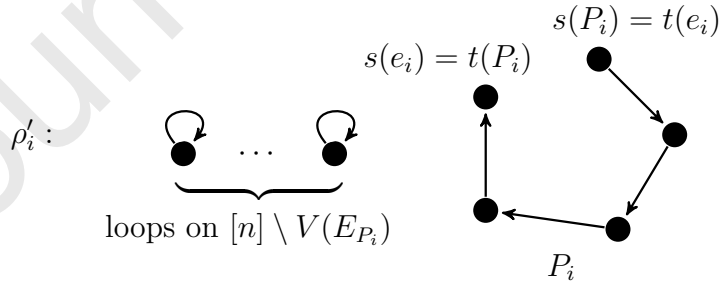

FIGURE 8. Elementary paths, sources and targets

Let us also add some remarks on Notation 4.4.

Remark 4.5. For every $i \in [k]$, denote by ρ'_i the subdigraph $([n], E_{\rho_i} \setminus e_i)$. Note that it is a permutation: $\rho'_i \in S_{\{s(e_i)\}^c, \{t(e_i)\}^c}$. Note also that P_i introduced in (4.3) has $s(P_i) = t(e_i)$ (and $s(e_i) = t(P_i)$), and that it is the only elementary path in the decomposition of ρ'_i . See Figure 8.

Remark 4.6. Note that

- $\overline{s(C_i)} = \overline{s(P_i)} \cup t(P_i) = V(E_{P_i})$,
- All the loops on $[n] \setminus (\bigcup_{i \in [k]} \overline{s(C_i)})$ belong to F if all ρ_i are as on Figure 7.
- Some (but not all) e_i might be loops. In this case $C_i = e_i$, and $E_{P_i} = \emptyset$.

Remark 4.7. If identity is the unique optimal permutation (i.e., if the associated matrix is strictly normalized), then all permutations in any optimal $(1, k)$ -regular multigraph have no more than one cycle in their decomposition (as in Figure 7).

Definition 4.8. For a given multigraph F , denote its set of loops by L_F . A multigraph F is said to be *equivalent* to a simple graph G if $E_G = E_F \setminus L_F$.

The following theorem is (loosely speaking) an equivalent of the Jacobi identity ([AGN18]) in terms of graphs theory. Recall that the i, j -entry of the adjoint matrix of a matrix A is determined by permutations in S_n where j is sent to i . The entry $A_{j,i}$ is then removed from the product resulting in this entry. The corresponding graph of this product is therefore missing the j, i -edge. These ‘missing adj-edges’ are combinatorially considered as fixed conditions. (It resembles the combinatorial approach explaining the identity for the number of choices of a subset of size k from a set of size n :

$$\binom{n-1}{k-1} + \binom{n-1}{k} = \binom{n}{k}$$

as choosing from a set of size $n-1$ having a fixed element either inside the subset or outside the subset.)

Theorem 4.9. Let $G = ([n], E)$ be a simple weighted digraph where Id is an optimal permutation. Let $F = ([n], \biguplus_{i \in [k]} E_{\rho_i}, \pi)$ be an optimal $(1, k)$ -regular multigraph of G with respect to $I, J \subseteq [n]$, such that each ρ_i has no more than one cycle that is not a loop. Then there exists a k -regular multigraph $F' = ([n], \biguplus_{i \in [k]} E_{\tau_i})$ of G such that at least one of the following statements holds

- (1) $F' = F$ and $E_\pi \subseteq E_{\tau_\ell}$ for some $\ell \in [k]$, and $\pi' \in S_{I^c, J^c}$ defined by $E_{\pi'} = E_{\tau_\ell} \setminus E_\pi$ satisfies $\bigcup_{i \in [k]} E_{P_i} \subseteq E_{\pi'}$ and is an optimal bijection (with respect to I^c, J^c).
- (2) There exists $\tilde{\pi} \in S_{I, J}$ such that $F' = ([n], \biguplus_{i \in [k]} E_{\tau_i}, \tilde{\pi}) \neq F$ satisfies

$$\left(\biguplus_{i \in [k]} E_{\tau_i} \right) \setminus (E_{\tilde{\pi}} \cup L_{F'}) \subseteq \left(\biguplus_{i \in [k]} E_{\rho_i} \right) \setminus E_\pi$$

and is also an optimal $(1, k)$ -regular multigraph with respect to I, J .

Proof. Let us first observe that the optimality of a $(1, k)$ -regular multigraph with respect to $I, J \in [n]$ or a bijection in $S_{I, J}$ will not change if we multiply each column (or each row) of the matrix associated with G by some scalar. Indeed, this will multiply the weight of each $(1, k)$ -regular multigraph by the same constant and the weight of each bijection in $S_{I, J}$ by the same constant. This shows that it suffices to prove the theorem for the case where in addition to Id being optimal, all loops are in E and have weight $\mathbb{1}$, i.e., where the associated matrix is normalized. We will further assume that G has this property and consider the following two principal cases.

Case 1: All paths P_i for $i \in [k]$ are pairwise disjoint.

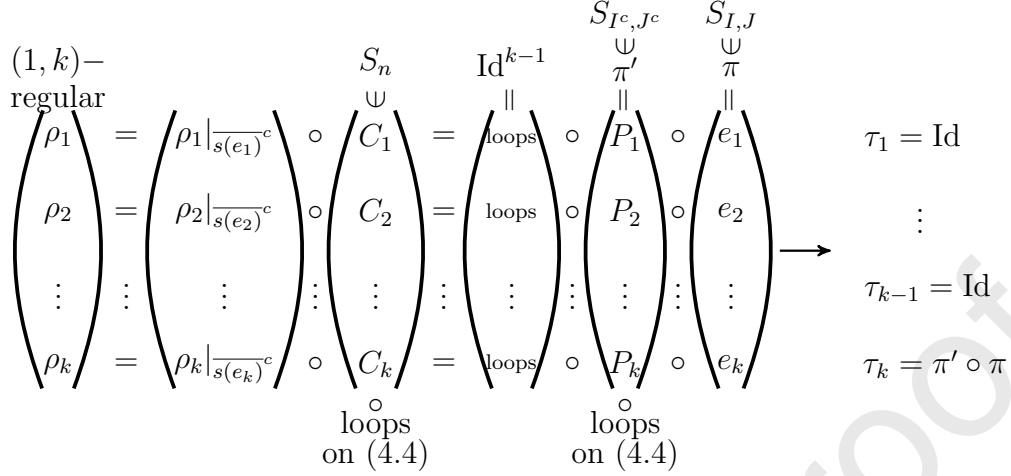

FIGURE 9. Case (1): Optimal $(1, k)$ -regular multigraph F is equivalent to an optimal permutation w.r.t. I^c, J^c . (See Notations (4.1) – (4.3))

We will show that (1) occurs by proving that $\biguplus_{i \in [k]} E_{\rho_i} \setminus E_{\pi}$ is equivalent (in the sense of Definition 4.8) to an optimal permutation w.r.t. I^c, J^c (see Figure 9).

To formalize the description of this case, which will later help us to deal with the remaining cases, observe that C_i (equivalently P_i . See Notation 4.2) are disjoint exactly when all the following conditions hold:

- (a) All sources and targets are disjoint, which is equivalent to

$$s(P_i) \in J \setminus I = I^c \setminus J^c \text{ and } t(P_i) \in I \setminus J = J^c \setminus I^c, \quad \forall i \in [k],$$

- (b) Sources and targets are disjoint to all intermediate nodes, which is equivalent to

$$V(E_{P_i}) \setminus \{s(P_i), t(P_i)\} \subseteq I^c \cap J^c, \quad \forall i \in [k],$$

- (c) All intermediate nodes are disjoint:

$$(V(E_{P_i}) \setminus \{s(P_i), t(P_i)\}) \cap (V(E_{P_j}) \setminus \{s(P_j), t(P_j)\}) = \emptyset, \quad \forall i \neq j.$$

Then, under these conditions, the composition of $C_1 \circ \dots \circ C_k$ with the loops on

$$(4.4) \quad [n] \setminus \underbrace{\left(\bigcup_{i \in [k]} V(E_{P_i}) \right)}_{\supseteq I \cup J} = (J \cup I)^c \setminus \left(\bigcup_{i \in [k]} V(E_{P_i}) \right) = J^c \cap I^c \setminus \left(\bigcup_{i \in [k]} V(E_{P_i}) \right)$$

is a permutation that can be taken for τ_ℓ and the composition of $P_1 \circ \dots \circ P_k$ with these loops for the bijection $\pi' \in S_{I^c, J^c}$ such that $E_{\pi'} = E_{\tau_\ell} \setminus E_{\pi}$. Note that all the edges of $(\biguplus_{i \in [k]} E_{\rho_i}) \setminus E_{\pi}$ that are not in E_{τ_ℓ} are loops that compose $k - 1$ copies of the identity permutation. So we can take $F' = ([n], \biguplus_{i \in [k]} E_{\tau_i})$, where τ_ℓ is as defined above and all other τ_i for $i \neq \ell$ are equal to Id , and then $F' = F$ as claimed.

It remains to show that π' is an optimal bijection of S_{I^c, J^c} in G . For this we remind that the optimality of F is achieved by its weight, to which the weights of e_i (see Notation 4.1) do not contribute. That is, by the rearrangement, the weight of F is the

weight of the rearrangement not including the weights of e_i , which is the weight of the bijection π' (multiplied by weight $\mathbb{1}$ of loops constituting the $k - 1$ copies of identity).

By contradiction, assume that there exists a bijection $\pi'' : I^C \rightarrow J^C$ whose weight strictly surpasses the weight of π' . Then it is decomposed into paths and cycles. It can be seen that the beginning nodes of the paths compose $I^C \setminus J^C = J \setminus I$ and the end nodes of the paths compose $J^C \setminus I^C = I \setminus J$. Completing each path into a cycle by a single edge and composing it with disjoint loops yields a permutation. Consider the set of such permutations and $|I \cap J|$ copies of Id corresponding to the nodes of $I \cap J$ (that can be neither beginning nor end nodes of paths in decomposition of π''). These permutations constitute a $(1, k)$ -regular multigraph of G with respect to I, J . The weight of this multigraph equals the weight of π'' , which strictly surpasses the weight of F .

Case 2: Paths P_i are not pairwise disjoint (see Figures 10 – 12 and Notation 4.1 – 4.3)

In this case we will show that (2) occurs by proving that there exists $\tilde{\pi} \in S_{I, J}$ and $\tau_1, \dots, \tau_k \in S_n$ such that the multigraph $F' = ([n], \biguplus_{i \in [k]} E_{\tau_i}, \tilde{\pi})$ is $(1, k)$ -regular and optimal with respect to I, J , and

$$\left(\biguplus_{i \in [k]} E_{\tau_i} \right) \setminus (E_{\tilde{\pi}} \cup L_{F'}) \subseteq \left(\biguplus_{i \in [k]} E_{\rho_i} \right) \setminus E_{\pi}.$$

Observe that Case 2 occurs when one of the conditions a – c in Case 1 fails. That is, if at least one of the following conditions holds:

- (a) There exists a source which is also a target, or vice versa (of course the sources are disjoint and the targets are disjoint),
- (b) There exists an intermediate node which is also a source or a target,
- (c) There exists an intermediate node common to two paths.

We will consider each of these cases separately.

Case 2a: There exists a source which is also a target (Figure 10)

In this case $\exists i, j \in [k] : t(P_j) = s(P_i)$.

We compose $P_j \circ P_i$ and get a path Q such that

$$s(Q) = s(P_j), \quad t(Q) = t(P_i).$$

If Q is an elementary path, then composed with the loops on nodes disjoint to $V(E_Q)$, we get a bijection in $S_{\{t(P_i)\}^c, \{s(P_j)\}^c}$, which can be completed by one edge into a permutation τ . Therefore, taking $\tau_i = \tau$, $\tau_j = \text{Id}$, instead of ρ_i, ρ_j , and $\tau_\ell = \rho_\ell$ for all $\ell \neq i, j$, we obtain the $(1, k)$ -regular multigraph $F' = ([n], \biguplus_{\ell \in [k]} E_{\tau_\ell}, \tilde{\pi})$ with respect to I, J in G , where $\tilde{\pi}$ is formed from π by replacing the edges $(t(P_j), s(P_j))$ and $(t(P_i), s(P_i))$ with the edges $(t(P_i), s(P_j))$ and $(t(P_j), s(P_i))$.

Since the set of edges $\bigcup_{i \in [k]} E_{\rho_i} \setminus E_{\pi}$ has not changed, but was rather rearranged, F' is optimal:

$$\left(\sum_{i \in [k]} w(\rho_i) \right) - w(\pi) = \left(\sum_{i \in [k]} w(\tau_i) \right) - w(\tilde{\pi}).$$

If Q is not elementary, then it includes nontrivial cycles, and therefore its weight is less than or equal to the weight of the elementary path Q' from $s(Q)$ to $t(Q)$ included in Q , where the cycles of Q are replaced by loops of nodes disjoint to $V(E_{Q'})$. As a result,

the weight of F is less than or equal to the weight of the $(1, k)$ -regular multigraph F' , where τ_i is now the elementary path Q' composed with loops disjoint to $V(E_{Q'})$. In the case when the weight of F is strictly less, we have a contradiction with the optimality of F . In the case when the weights are equal, we have found the desired F' .

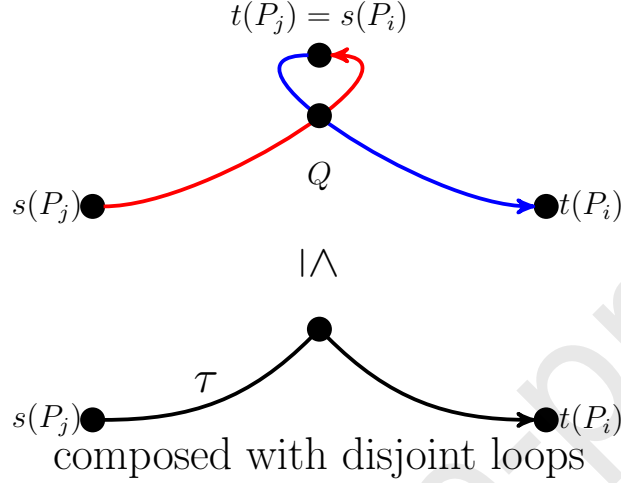

FIGURE 10. Case (2a)

Case 2b: There exists an intermediate node which is also a source or a target (see also Figure 11)

This case occurs when

$$\exists i \in [k], t \in \overline{s(P_i)} \setminus \{s(P_i)\} : t \notin (I^c \cap J^c) (\Leftrightarrow t \in I \cup J).$$

Since $\pi \in S_{I,J}$, $\exists j \in [k]$ such that $t = t(P_j)$ or $t = s(P_j)$ (w.l.o.g. $t = s(P_j)$). Hence we have,

$$\exists i, j \in [k], t \in \overline{s(P_i)} : t = s(P_j).$$

We assume without loss of generality that Case 2a does not occur.

We compose $P_i \circ P_j$, and decompose P_i at t , denoted by $Q_1 \circ Q_2 \circ P_j$ such that

$$s(Q_1) = s(P_i), t(Q_1) = t = s(Q_2), t(Q_2) = t(P_i).$$

We then write the composition as $(Q_1 \circ P_j) \circ Q_2$ where Q_2 is elementary, and $Q_1 \circ P_j$ is a path Q such that

$$s(Q) = s(P_i), t(Q) = t(P_j).$$

As before, if Q is elementary, then composed with the loops of nodes disjoint to $V(E_Q)$, we get a bijection in $S_{\{t(P_j)\}^c, \{s(P_i)\}^c}$, which can be completed by one edge into a permutation τ . Composing Q_2 with the loops of nodes disjoint to $V(E_{Q_2})$, we get a bijection in $S_{\{t(P_i)\}^c, \{s(P_j)\}^c}$, which can be completed by one edge into a permutation τ' . Therefore, taking $\tau_i = \tau$, $\tau_j = \tau'$, instead of ρ_i, ρ_j , and $\tau_\ell = \rho_\ell$ for all $\ell \neq i, j$, we obtain the $(1, k)$ -regular multigraph $F' = ([n], \biguplus_{\ell \in [k]} E_{\tau_\ell}, \tilde{\pi})$ with respect to I, J in G , where $\tilde{\pi}$ is formed from π by replacing the edges $(t(P_j), s(P_j))$ and $(t(P_i), s(P_i))$ with the edges

$(t(P_i), s(P_j))$ and $(t(P_j), s(P_i))$. Since the set of edges $\bigcup_{i \in [k]} E_{\rho_i} \setminus E_{\pi}$ has not changed, but was rather rearranged, F' is optimal.

If Q is not elementary, then it includes nontrivial cycles, and therefore its weight is less than or equal to the weight of the elementary path Q' from $s(Q)$ to $t(Q)$ included in Q , where the cycles of Q are replaced by loops of nodes disjoint to $V(E_{Q'})$. As a result, the weight of F is less than or equal to the weight of the $(1, k)$ -regular F' above, where τ_i is the elementary path Q' composed with loops disjoint to $V(E_{Q'})$. As in case 2a, the weight of F cannot be less than the weight of F' , so we have found the desired F'

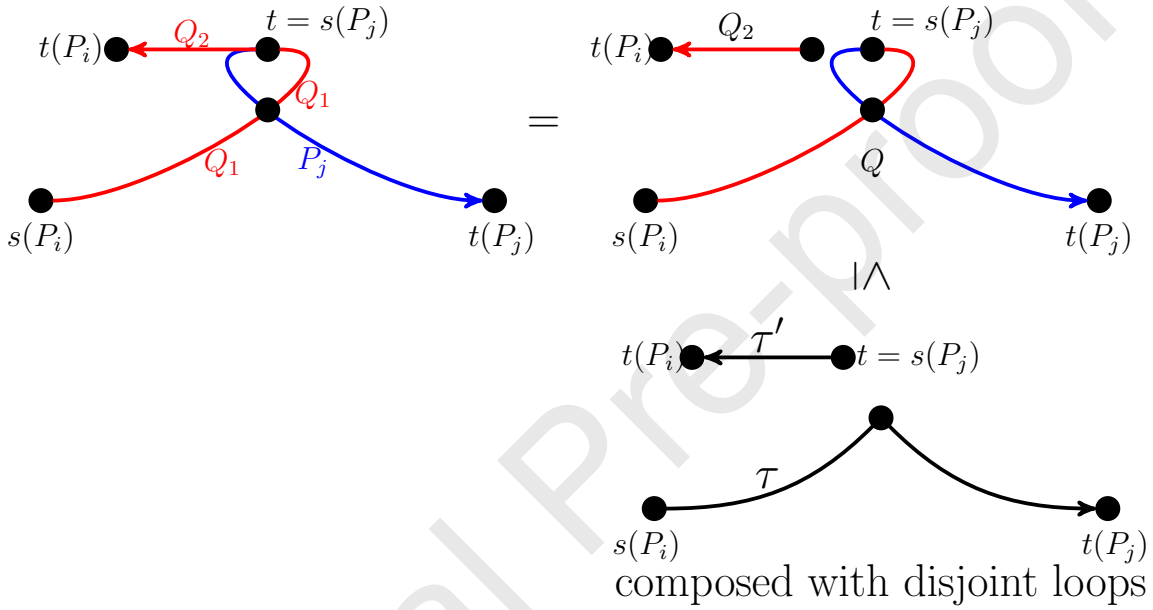

FIGURE 11. Case (2b)

Case 2c: There exists an intermediate node common to two paths (see Figure 12)

In this case we have that,

$$\exists t \in (\overline{s(P_i)} \setminus \{s(P_i)\}) \cap (\overline{s(P_j)} \setminus \{s(P_j)\}) \text{ for some } i \neq j.$$

We assume without loss of generality that Cases 2a and 2b do not occur.

Let $P_i = Q_1 \circ Q_2$ where Q_1 is the segment of P_i between $s(P_i)$ and t , and Q_2 is the segment from t to $t(P_i)$.

Similarly let $P_j = Q_3 \circ Q_4$ where $s(Q_3) = s(P_j)$, $s(Q_2) = t = s(Q_4)$ and $t(Q_4) = t(P_j)$.

Then we can write the composition $P_i \circ P_j$ as $(Q_1 \circ Q_4) \circ (Q_3 \circ Q_2)$ where

$$s(Q_1 \circ Q_4) = s(P_i), \quad s(Q_3 \circ Q_2) = s(P_j), \quad t(Q_1 \circ Q_4) = t(P_j), \quad t(Q_3 \circ Q_2) = t(P_i).$$

Once again, if $Q_1 \circ Q_4$ and $Q_3 \circ Q_2$ are elementary, then composed with the loops of nodes disjoint to $V(E_{Q_1 \circ Q_4})$ and $V(E_{Q_3 \circ Q_2})$ respectively, we get bijections in $S_{\{t(P_j)\}^c, \{s(P_i)\}^c}$ and $S_{\{t(P_i)\}^c, \{s(P_j)\}^c}$, which can be completed, by one edge each, into permutations τ, τ' . Therefore, taking $\tau_i = \tau$, $\tau_j = \tau'$, instead of ρ_i, ρ_j , and $\tau_\ell = \rho_\ell$ for all $\ell \neq i, j$, we obtain

the $(1, k)$ -regular multigraph $F' = ([n], \biguplus_{\ell \in [k]} E_{\tau_\ell}, \tilde{\pi})$ with respect to I, J in G , where $\tilde{\pi}$ is formed from π by replacing the edges $(t(P_j), s(P_j))$ and $(t(P_i), s(P_i))$ with the edges $(t(P_i), s(P_j))$ and $(t(P_j), s(P_i))$. Since the set of edges $\bigcup_{i \in [k]} E_{\rho_i} \setminus E_\pi$ has not changed, but was rather rearranged, F' is optimal.

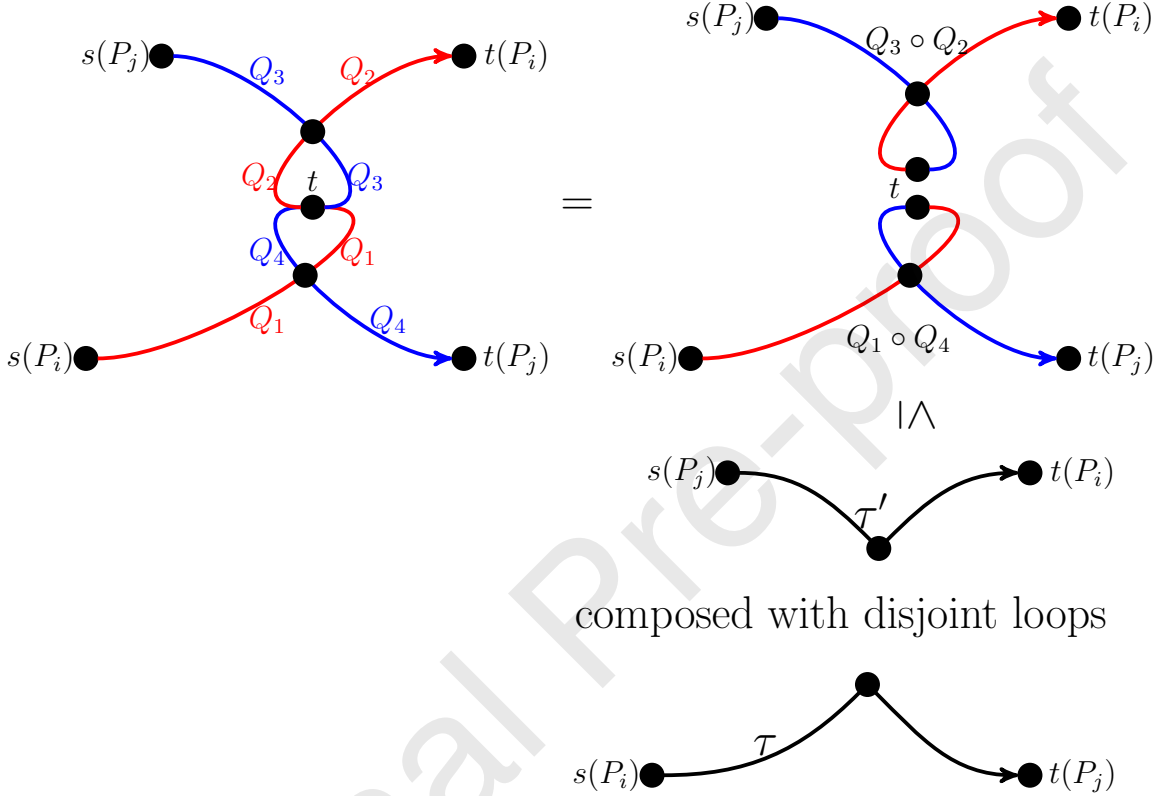

FIGURE 12. Case (2c)

If $Q_1 \circ Q_4$ (resp. $Q_3 \circ Q_2$) is not elementary, then it includes nontrivial cycles, and therefore its weight is less than or equal to the weight of the elementary path Q' from $s(Q_1 \circ Q_4)$ (resp. $s(Q_3 \circ Q_2)$) to $t(Q_1 \circ Q_4)$ (resp. $t(Q_3 \circ Q_2)$) included in $Q_1 \circ Q_4$ (resp. $Q_3 \circ Q_2$), where the cycles of $Q_1 \circ Q_4$ (resp. $Q_3 \circ Q_2$) are replaced by loops of nodes disjoint to $V(E_{Q'})$. As a result, the weight of F is less than or equal to the weight of the $(1, k)$ -regular F' above, where τ_i (resp. τ_j) is the elementary path Q' composed with loops disjoint to $V(E_{Q'})$. We conclude in the same way as in Cases 2a and 2b.

Observe that in all subcases of Case 2 we change the set of edges of two permutations in the multigraph, and therefore $F' \neq F$. \square

Remark 4.10. If, in addition, Id is the unique optimal permutation then every optimal multigraph F has the required property by Lemma 4.3.

Let us also formulate a version of the above theorem which applies to any optimal multigraph.

Corollary 4.11. *Let $G = ([n], E)$ be a simple weighted digraph where Id is an optimal permutation. Let $F = ([n], \biguplus_{i \in [k]} E_{\rho_i}, \pi)$ be an arbitrary optimal $(1, k)$ -regular multigraph of G with respect to $I, J \subseteq [n]$. Then there exists a k -regular multigraph $F' = ([n], \biguplus_{i \in [k]} E_{\tau_i})$ of G such that at least one of the following statements holds*

- (1) $E_\pi \subseteq E_{\tau_\ell}$ for some $\ell \in [k]$, and $\pi' \in S_{I^c, J^c}$ defined by $E_{\pi'} = E_{\tau_\ell} \setminus E_\pi$ satisfies $\bigcup_{i \in [k]} E_{P_i} \subseteq E_{\pi'}$ and is an optimal bijection (with respect to I^c, J^c).
- (2) There exists $\tilde{\pi} \in S_{I, J}$ such that $F' = ([n], \biguplus_{i \in [k]} E_{\tau_i}, \tilde{\pi}) \neq F$ satisfies $(\biguplus_{i \in [k]} E_{\tau_i}) \setminus (E_{\tilde{\pi}} \cup L_{F'}) \subseteq (\biguplus_{i \in [k]} E_{\rho_i}) \setminus E_\pi$ and is also an optimal $(1, k)$ -regular multigraph with respect to I, J .

Proof. Using Lemma 4.3, multigraph F can be replaced with a multigraph with ρ_i having the same cycles C_i as in F and with all other cycles being loops, maintaining the optimality. Then all properties of both alternatives follow from the corresponding alternatives in Theorem 4.9. □

Remark 4.12. (On the General Case) Identity is not an optimal permutation for a general matrix, but any optimal permutation can be relocated to the diagonal by permuting columns (or rows). Let us consider this process on the digraph G_A corresponding to $A \in \mathbb{R}_{\max}^{n \times n}$, and furthermore on the bipartite graph corresponding to G_A . Note that the permutations are interpreted as assignments matching n workers to n tasks. In that sense, one has the freedom of renumbering the tasks. If assigning worker i to task $\pi(i)$ for every $i \in [n]$ is an optimal assignment, then one can count task $\pi(i)$ as task i . This is easy to do once an optimal permutation is known, hence the condition that Id should be optimal is not restrictive in practice.

4.1. Example showing both cases of tropical Jacobi identity in terms of assignments and supervisions. Here we consider how a set of k assignments with supervisions I on J links to the cases observed in Theorems 4.1 and 4.9.

Example 4.13.

$$A = \begin{pmatrix} 0 & -1 & -5 & -4 \\ -6 & 0 & -2 & -1 \\ -3 & -4 & 0 & -3 \\ -2 & -7 & 0 & 0 \end{pmatrix}.$$

We calculate $\text{adj}(A)$ and also show the table of bijections (in A) corresponding to each entry of the adjoint.

$$\text{adj}(A) = \begin{pmatrix} 0 & -1 & -2 & -2 \\ -3 & 0 & -1 & -1 \\ -3 & -4 & 0 & -3 \\ -2 & -3 & 0 & 0 \end{pmatrix} \leftrightarrow \left(\begin{array}{cccc} \begin{array}{c} \bullet \\ \bullet \\ \bullet \\ \bullet \\ \bullet \\ \bullet \\ \bullet \\ \bullet \end{array} & \begin{array}{c} \bullet \\ \bullet \\ \bullet \\ \bullet \\ \bullet \\ \bullet \\ \bullet \\ \bullet \end{array} & \begin{array}{c} \bullet \\ \bullet \\ \bullet \\ \bullet \\ \bullet \\ \bullet \\ \bullet \\ \bullet \end{array} & \begin{array}{c} \bullet \\ \bullet \\ \bullet \\ \bullet \\ \bullet \\ \bullet \\ \bullet \\ \bullet \end{array} \\ \begin{array}{c} \bullet \\ \bullet \\ \bullet \\ \bullet \\ \bullet \\ \bullet \\ \bullet \\ \bullet \end{array} & \begin{array}{c} \bullet \\ \bullet \\ \bullet \\ \bullet \\ \bullet \\ \bullet \\ \bullet \\ \bullet \end{array} & \begin{array}{c} \bullet \\ \bullet \\ \bullet \\ \bullet \\ \bullet \\ \bullet \\ \bullet \\ \bullet \end{array} & \begin{array}{c} \bullet \\ \bullet \\ \bullet \\ \bullet \\ \bullet \\ \bullet \\ \bullet \\ \bullet \end{array} \\ \begin{array}{c} \bullet \\ \bullet \\ \bullet \\ \bullet \\ \bullet \\ \bullet \\ \bullet \\ \bullet \end{array} & \begin{array}{c} \bullet \\ \bullet \\ \bullet \\ \bullet \\ \bullet \\ \bullet \\ \bullet \\ \bullet \end{array} & \begin{array}{c} \bullet \\ \bullet \\ \bullet \\ \bullet \\ \bullet \\ \bullet \\ \bullet \\ \bullet \end{array} & \begin{array}{c} \bullet \\ \bullet \\ \bullet \\ \bullet \\ \bullet \\ \bullet \\ \bullet \\ \bullet \end{array} \\ \begin{array}{c} \bullet \\ \bullet \\ \bullet \\ \bullet \\ \bullet \\ \bullet \\ \bullet \\ \bullet \end{array} & \begin{array}{c} \bullet \\ \bullet \\ \bullet \\ \bullet \\ \bullet \\ \bullet \\ \bullet \\ \bullet \end{array} & \begin{array}{c} \bullet \\ \bullet \\ \bullet \\ \bullet \\ \bullet \\ \bullet \\ \bullet \\ \bullet \end{array} & \begin{array}{c} \bullet \\ \bullet \\ \bullet \\ \bullet \\ \bullet \\ \bullet \\ \bullet \\ \bullet \end{array} \end{array} \right).$$

Theorem 4.9 Case 1 $\text{adj}(A)_{\{2,3,4\}, \{1,2,3\}}^{\wedge 3} = -2 = a_{41} = A_{\{4\}\{1\}}^{\wedge 1}$ thus the tropical Jacobi identity holds with equality for this choice of I and J .

In this case there is only one set of 3 assignments with supervisions I on J which achieves the maximum base value. This value $\text{adj}(A)_{\{2,3,4\},\{1,2,3\}}^3$ is attained for the bijection (in $\text{adj}(A)$) $(2, 2), (3, 3), (4, 1)$ which corresponds to the following three bijections (in A), that is, three assignments with supervisions:



We can rearrange the solid edges so that we have $k - 1 = 2$ full permutations in S_4 , and a bijection representing the optimal permutation of $A^{\wedge n-k}$ which can be completed to a full permutation by adding the edges representing supervisions. Indeed, in the figure below we have, on the left, the 3 assignments with supervisions described by the bijections. On the right we rearrange the edges (note that they both represent the same digraph, and have the same value).

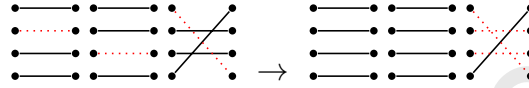

By rearranging the edges in this way, we have found that the base value of the k assignments (the sum of the weights of the solid assignments on the left hand side) is equal to the sum of the value of two identity permutations (which achieve the value of $\text{per}(A)$) and one bijection from $J^C = \{4\}$ to $I^C = \{1\}$ (which reflects the value of $A_{J^C, I^C}^{\wedge(n-k)}$). Further, in this case, the supervised edges are always constitute a bijection σ from J to I which is the complement to the bijection τ from J^C to I^C which attains the value of $A_{J^C, I^C}^{\wedge(n-k)}$ in the sense that together σ and τ form a permutation in S_n .

Case 2a in the proof of Theorem 4.9 For $I = \{1, 2, 3\}$ and $J = \{1, 3, 4\}$ we have

$$\text{adj}(A)_{J,I}^3 = -3^\bullet > A_{J^C, I^C}^1 = A_{4,2} = -7.$$

This is attained by two bijections (in $\text{adj}(A)$), $(1, 2), (3, 3), (4, 1)$ and $(1, 1), (3, 3), (4, 2)$. These represent, in A , the following choices for 3 assignments with supervisions. Note that the supervisions change, but the edges representing the assignments are only rearranged.

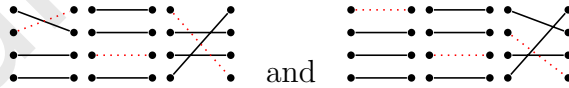

This is what was expected from Theorem 4.9; that the daily assignments of workers to jobs which are not a supervised assignment (the solid edges in the above) can be swapped between days to give another set of k assignments with the same base value but a different set of supervisions I on J .

Case 2b in the proof of Theorem 4.9 Finally, it can be verified that, for $I = \{1, 2\}$ and $J = \{3, 4\}$ we have

$$\text{adj}(A)_{J,I}^2 = -6^\bullet = (\text{adj}(A)_{3,1} \text{adj}(A)_{4,2}) \oplus (\text{adj}(A)_{3,2} \text{adj}(A)_{4,1})$$

and $A_{J^C, I^C}^2 = -6 = A_{3,2} A_{4,1}$. In this case $\text{adj}(A)_{J,I}^2$ is attained twice and equality holds in the tropical Jacobi identity. There are three sets of 2 assignments obtaining the optimal base value in this case, shown below. The final one can be rearranged into an identity permutation, and the edges $(3, 2)$ and $(4, 1)$ which reflect the bijection attaining the value of A_{J^C, I^C}^2 .

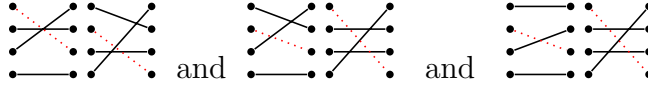

4.2. The Jacobi identity and assignments with supervisions. Tropical Jacobi tells us that either more than one set of bijections corresponding to optimal base value ($= \text{adj}(A)_{J,I}^k$) of k assignments with supervisions I on J or, it is sufficient to calculate the optimal bijection on $A[[n] - I, [n] - J]$.

Using the same method as the proof of Theorem 4.9, we get the following.

Proposition 4.14. *If equality holds in the tropical Jacobi identity, then an optimal set of k assignments with supervisions can be found in $\mathcal{O}(n^3)$ time.*

Proof. Assume $\tau : I^C \rightarrow J^C$ attains $A_{I^C, J^C}^{\wedge(n-k)}$. Then τ is composed of elementary paths $P \in \mathcal{P}$ and cycles $C \in \mathcal{C}$. Observe that the cycles in \mathcal{C} can be assumed loops (given that we are working in the normalized case).

For each path we construct one assignment and identify its supervised edge as follows:

Let $p = (i_1, j_1 = i_2, j_2 = i_3, \dots, j_{k-1} = i_t, j_t)$ where $i_1, \dots, i_t \in I$ and $j_1, \dots, j_t \in J$. The edge/assignment $(t(p), s(p))$ completes p into a cycle, and we add loops (r, r) for $r \in [n] \setminus \{i_1, \dots, i_k\}$ to obtain $\pi_p \in S_n$. The supervised edge in π_p is $(t(p), s(p))$.

Note that, if there are less than k elementary paths in the decomposition of τ , then the remaining permutations and supervised edges are respectively identity permutations and loops between unassigned vertices. Finally, observe that there will never be more than k elementary paths. The most computationally expensive part of this procedure is finding the bijection at the start, this is $\mathcal{O}((n-k)^3)$ by the Hungarian Method. \square

5. ACKNOWLEDGEMENT

We are grateful to Peter Butkovič, Stéphane Gaubert and Marianne Akian for supporting and inspiring us, and also to the anonymous referees of this paper for their careful reading and useful comments.

REFERENCES

- [AGN18] M. Akian, S. Gaubert, and A. Niv. Tropical compound matrix identities. *Linear Algebra Appl.*, 551:162–206, 2018.
- [BCOQ92] F. Baccelli, G. Cohen, G.J. Olsder, and J.P. Quadrat. *Synchronization and linearity*. Wiley Series in Probability and Mathematical Statistics: Probability and Mathematical Statistics. John Wiley & Sons, Ltd., Chichester, 1992. An algebra for discrete event systems.
- [But03] P. Butkovič. Max-algebra: the linear algebra of combinatorics? *Linear Algebra Appl.*, 367:313–335, 2003.
- [FJ11] S. M. Fallat and C. R. Johnson. *Totally Nonnegative Matrices*. Princeton Series in Applied Mathematics. Princeton university press, 2011.
- [FT87] M.L Fredman and R.E. Tarjan. Fibonacci heaps and their uses in improved network optimization algorithms. *Journal of the ACM*, 596-615(3):34, 1987.
- [Gau92] S. Gaubert. *Théorie des systèmes linéaires dans les dioïdes*. Phd dissertation, École des Mines de Paris, Paris, July 1992.
- [IR11] Z. Izhakian and L. Rowen. Supertropical matrix algebra. *Israel J. Math.*, 182:383–424, 2011.
- [Kuh55] H. W. Kuhn. The hungarian method for the assignment problem. *Navel Research Logistics Quarterly*, 2:83–97, 1955.
- [Mun57] J. Munkres. Algorithms for the assignment and transportation problems. *J. of the Soc. for Industrial and Appl. Math.*, 5:32–38, 1957.

- [Slo02] M. Slone. Proof of hall's marriage theorem, 2002. PlanetMath.Org.
- [SSP09] S. Sergeev, H. Schneider, and Butkovic P. On visualization scaling, subeigenvectors and kleene starsin max algebra. *Linear Algebra Appl.*, 431:2395–2406, 2009.

ADI NIV, MATHEMATICS DEPARTMENT, SCIENCE FACULTY, KIBBUTZIM COLLEGE. ADDRESS: KIBBUTZIM COLLEGE, 149 NAMIR RD., TEL-AVIV, ISRAEL.

Email address: `adi.niv@smkb.ac.il`

MARIE MACCAIG, CMAP, ÉCOLE POLYTECHNIQUE. ADDRESS: ROUTE DE SACLAY, 91128 PALAISEAU CEDEX, FRANCE.

Email address: `m.maccaig.maths@outlook.com`

SERGEÏ SERGEEV, SCHOOL OF MATHEMATICS, UNIVERSITY OF BIRMINGHAM. ADDRESS: WATSON BUILDING, UNIVERSITY OF BIRMINGHAM, EDGBASTON BIRMINGHAM B15 2TT UK.

Email address: `s.sergeev@bham.ac.uk`