

# An Arc to Glow Transition approach for Practical Use in DC Low Power, Low Voltage Electric Grids

Miedzinski B., Wisniewski G., Kharin S.N., Nouri H. and Grechanyuk N.

**Abstract**— This paper presents and discusses results of analysis from investigations of arc to glow transformation phenomenon at contact opening, under dc low energy ( $\leq 10$  J) and low voltage ( $\leq 250$  V) inductive loads. Dependency of the duration of arcing and glowing on current magnitude, voltage magnitude, properties of the contact material, gas quenching medium velocity and its pressure, as well as contact opening velocity and contact gap are investigated. The transition phenomenon of arc to glow is analyzed by means of fast photography and emission spectroscopy. Also discussed is the theoretical evaluation of conditions of arc instability. From the results possible procedures are formulated to control the arc to glow transformation for practical use in DC low voltage and low power electrical grids.

**Index Terms**— switching DC arc, low voltage and low power installation, arc-to-glow transition.

## I. INTRODUCTION

RECENTLY a rising interest can be seen for use of DC grids in residential homes. This is due to an increasing application of renewable DC energy sources (mainly photovoltaic cells) and the tendency to reduce both wiring and utility costs by elimination of DC/AC power electronic converters. An implementation of additional, separate DC installation is therefore recommended (especially in residential buildings), adaptable for connection to an AC primary [1]. However, use of the DC power source has serious disadvantages in its inability to transform to different voltage levels and in finding a switch that can break/make high values of current. Both of these disadvantages could be overcome by use of both special semiconductor and/or hybrid devices with overvoltage protection. In certain applications, where the current value is small and the breaking speed is not important, the contact switches are equipped with damping resistors [2-4]. However, this approach is not applicable to cases during

Miedzinski B. is with the Institute of Innovative Technologies, EMAG, Leopolda 31, 40-189 Katowice, Poland (e-mail: b.miedzinski@ibemag.pl).

Wisniewski G. is with the Department of Electrical Engineering, Wrocław University of Science and Technology, Wybrzeże Wyspińskiego 27, 50-370 Wrocław, Poland (e-mail: grzegorz.wisniewski@pwr.edu.pl).

Kharin S.N. is with the Kazakh-British Technical University, Almaty, Kazakhstan,

Nouri H. is with the University of The West of England, Bristol, UK

Grechanyuk N is with the Institute of Material Science UAS, Kiev, Ukraine

breaking inductive loads, as the arc duration can be prolonged significantly and this leads to rapid damage of contacts in switches. In recent years studies of arcing under low voltage DC have shown in a number of cases that it can be advantageous if spontaneous transition of the arc into glow discharge can be achieved [5,6]. This reduces erosion of the contacts surface and increases the electrical life of the switch considerably, often with zero switching overvoltage. The duration of the glow discharge is dependent on the energy of the inductive circuit and therefore in some cases it is necessary to use forced limitation of this. However, in most applications there is no such need. Difficulty is encountered in the practical implementation of the switch structure to enable control of the DC switching arc transition into glow discharge, speedily after contact opening. The complexity relates to mutually interacting phenomena within the contact gap associated with the electrical discharge. However, an earlier study [6] found that either a fast transformation of initial unstable electrical pre-arc into the glow discharge, or after a short duration of burning arc into the glow discharge or total lack of glow discharge can occur [6]. This change is primarily due to a difficulty in maintaining the same reproducible physical-chemical conditions on the contact surfaces as well as within a relatively small gap between the contacts. Some explanations for the conditions of instability are provided via a mathematical description of this effect based on the experimental results [6].

In the first part of this article, a theoretical evaluation of conditions of the arc instability is discussed. In the second part attempts are made to present and discuss the results of experimental studies of DC arc into a glow discharge transition when interrupting an inductive current of low power/energy ( $\leq 10$ J) and low voltage ( $\approx 250$ V). The experimental work is further elaborated by considering the impact of current magnitude, voltage magnitude, properties of the contact material, gas quenching medium and its pressure as well as contact opening velocity and contact gap on duration of arcing and glowing. Particular emphasis is placed on the selection of contact material.

From both the mathematical and experimental studies, criteria have been formulated for implementation of the arc to glow transition effect in selected contact switches of a low power and low voltage DC. The latter is based on fast photography and spectroscopy.

## II. THEORETICAL EVALUATION FOR CONDITIONS OF ARC INSTABILITY

A glow discharge appears under unstable burning of the arc and is initiated, or is initiated almost immediately after the start of the opening the contact and/or after some time of the arc existence [6-11]. Approximate theoretical analysis of the

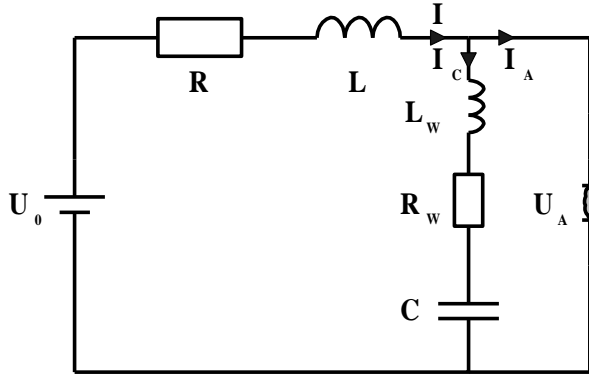

Fig. 1. Electrical circuit diagram of the test rig ( $U_0$ ,  $I$ -supplied voltage and load current,  $U_A$ -arc voltage,  $R, L, C$ -load resistance, inductance and circuit capacity,  $L_w, R_w$ - wires inductance and resistance respectively)

arc transition into a glow discharge, (for the electric circuit as shown in Fig.1) is given in detail in [12]. On the basis of the investigated results [5,6,12] the process of contact opening, associated with arc to glow discharge, can be presented in four stages representing different phenomena [2,3,6,7,12-15] as illustrated in Fig.2. The stage I (pre-arcing) is related to the initial conditions for arc ignition, in particular the values of current, voltage, density of evaporated metallic particles from contacts, length of contact gap, as well as electric field intensity, that are important for further arc evaluation. According to different temperature values in the contact spot, one can distinguish here, three intervals as follows: first-from initial to softening temperature (elastic restitution); second-from softening to melting (plastic deformation) and third-from melting to boiling temperature (bridging) respectively. Since the first two parts are of a very short duration in our case (under consideration) thus, a liquid contact bridge is the most important factor for further arc development. There are two existing mechanisms of the bridge formation and its dynamics are strongly related to the physical properties of the contact material. The first of these corresponds to a bridge formation due to melting of a micro-asperity on the contact surface, whereas the second is due to the extension of a liquid drop from the melted area in the constriction zone [6]. This drop extension mechanism of the bridge formation is typical for low-melting point metals with high thermal conductivity like silver and its compositions. Therefore, for such contact materials the length and duration of the ruptured bridge ( $t_b$  in Fig. 2) is large enough to provide thermal ionization of metal vapours needed for the arc ignition [9,10]. The further evaporation is also sufficient enough to maintain a stable arc of a relatively long duration (extended stage II-Fig.2). Therefore, silver and its compositions are not suitable for the arc to glow applications confirmed by the experiment. On the

contrary the micro-asperity genesis seems to be peculiar for more refractory metals such as nickel. The quantity of vapours of the micro-asperity is not sufficient for stable arc ignition and its occurrence is due to field emission breakdown and/or air avalanches breakdown. The bridge is in such a case significantly reduced or even invisible. Sometimes it may be accompanied by a showering phenomenon [14] and/or

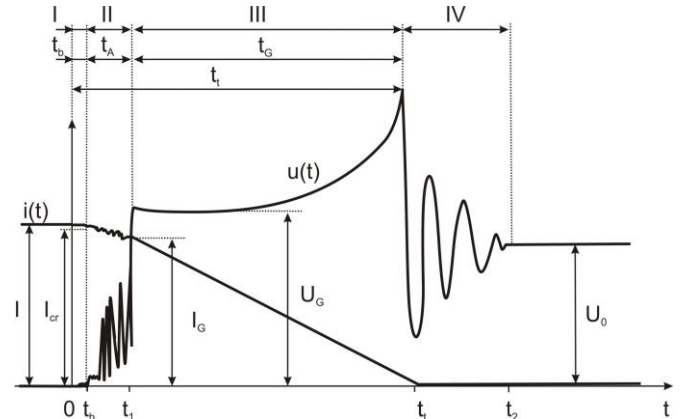

Fig. 2. Illustration of voltage current characteristics at contact opening ( $t_t, t_G, t_A, t_b, t_{cr}$ - total, glowing, arc discharge, bridge and critical arc time respectively,  $U_0, U_G$ -supply and glow voltage,  $I_{cr}, I_G$ -critical arc and glow transition current respectively).

explosive electron emission (ecton process) [15]. As a result the arc duration at this mechanism of bridge formation is small and depends on the pressure according to Pashen's law [2,4]. When the decreasing current reaches the certain critical value  $I_{cr}$  at the critical time  $t_{cr}$  the arc becomes unstable, therefore even a very small perturbation of current or voltage may cause the arc to collapse (see Fig. 2.). From a mathematical point of

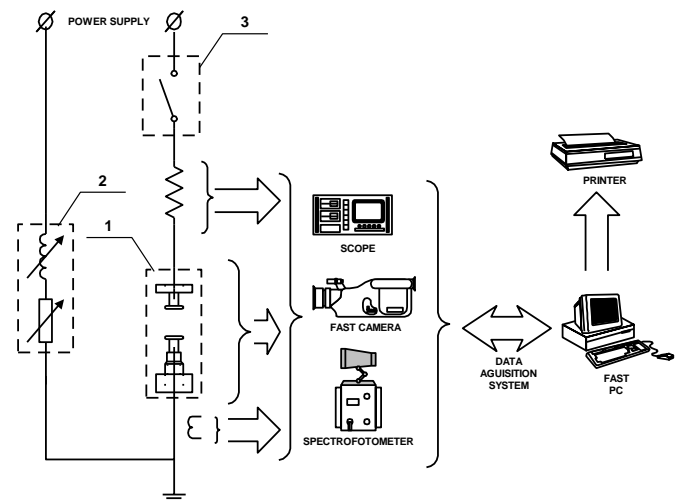

Fig. 3. Schematic set-up of the test apparatus (1-dismantlable chamber stand, 2-load to be adjusted, 3-auxiliary protection switch)

view arc instability correlates with instability of the solution of the differential equations for arc current and voltage corresponding to the electrical circuit from Fig. 1. Of course, the heat equation for the arc temperature that is related to arc thermal capacity, radius and length as well as to its electrical conductivity, and anode, cathode and radiation losses have to be also taken into consideration [8].

Arc stability can be investigated on the base of general

methods of motion stability created by A.M. Lyapunov, in particular using the method of small perturbations. This method requires definition of the conditions of arc stability in terms of small perturbations of current or voltage damp in time [17,18,19]. Such analysis has been carried out by authors previously and is presented in [6]. According to this, the arc instability criteria can (for the given circuit as in Fig.1) be formulated as follows

$$\frac{R}{L} + \frac{1}{C R_A} - \frac{1}{k_A} < 0 \quad (1)$$

$$\left(\frac{R}{L} + \frac{1}{C R_A} - \frac{1}{k_A}\right) \left(\frac{1}{L C} + \frac{R}{L C R_A} + \frac{1}{k_A C R_A} - \frac{R}{k_A L}\right) - \frac{1}{k_A LC} \left(\frac{R}{R_A} - 1\right) < 0 \quad (2)$$

$$\frac{R}{R_A} - 1 < 0 \quad (3)$$

where:

$$R_A = \frac{U_A}{I_A} \quad (4)$$

$$k_A = \frac{C_A V_A T_A}{P} \quad (5)$$

Where  $R_A$  is the arc resistance and  $k_A$  is the thermal heat constant important for the relation between the times  $t_A$  and  $t_G$  respectively for the duration of arc and glow ( $V_A$  is the arc volume,  $T_A$ —arc temperature,  $P$ - arc power,  $C_A$  – heat capacity of the arc) [15]. The criterion in form (1) defines the impossibility of the stationary arc existence; whereas, criteria according to (2) and (3) formulate additional conditions of the dynamic arc instability. Therefore, the solution of the non-linear ( $R_A$  and  $k_A$  parameters are non-linear) equation set (1)-(3) enables one to find critical time  $t_{cr}$ , critical arc power and critical current  $I_{cr}$  (Fig. 2.) for arc instability, however, only for particular cases[6].

### III. EXPERIMENTAL INVESTIGATIONS

#### A. Test procedure

In order to conduct research a special test system equipped with a dismountable hermetic chamber to house the contact system, designed and assembled earlier [19] was utilized. The dedicated test rig is controlled by a PC and Fig.3 shows the schematic diagram of the whole experimental setup. Plain, round contacts with a diameter of 5 mm and thickness of 1 mm are tested in different gaseous medium (air, pure argon and  $N_2+H_2$  5% mixture) under pressure ranges from a few kPa up to about 300kPa, a contacts opening velocity ranging 0.04m/s to 0.4m/s and a contact force from 0.6 N to around 40

N. The used contact materials are from refractory and non-refractory fine metals (like W, Mo, Ni, Ti, and Ta), selected fine powder tungsten-copper sinters (with some additives like Co 2%), vapour deposited copper molybdenum and copper chromium compositions. Furthermore the investigations are performed for currents and voltages in the range of 0.5 A-3.0 A and 48 V to 250 V respectively at a circuit time constant varying from 10ms to 40ms (discharge energy less than 10J). Contact materials, gas type and pressure as well as load conditions under test are identified in Table 1.

Table 1. Contact materials and test conditions

Materials	Gaseous environment	Load
<b>Pure materials:</b>		
Ti, Ta	(air, N <sub>2</sub> H <sub>2</sub> (5%))100kPa	0.5-1A; 48-250V;10-30ms
Ni,	(air, N <sub>2</sub> H <sub>2</sub> (5%),Ar) 10-100kPa	0.5-3A; 48-250V;10-40ms
Mo, W	(air, N <sub>2</sub> H <sub>2</sub> (5%))10-100kPa	0.5-2.5A;48-250V;10-30ms
<b>Fine powder sinters:</b>		
W-Co-Cu; W-Co-Cu-Ti-Al	air, 100kPa	0.5-1A; 48-250V;10-30ms
<b>Vacuum deposited composition (condensed):</b>		
Cu-Mo, Cu-Cr	air, 100kPa	0.5A; 110V;20-40ms

In all tests, voltage, current, discharge power and the contact gap length variation are recorded. To reduce the influence of surface contaminations, contacts are mechanically and chemically cleaned before the test. Ten samples for each contact material are selected and the mean values and predicted ranges with a 95% level of confidence are calculated after completion of tests. Finally with the use of fast photography (2200 frames per second) and radiation spectra measurements the length of contact gap is enlarged from 2.5 mm up to about 7 mm. However, due to the limitation of performance in transient of the selected fiber-optics spectrometer (time spectrum analysis about 200ms) the research of emission spectrum (in visible light range from 300 nm to 750 nm) is carried out separately for generated arc and glow discharges under DC inductive load breaking.

#### B. Results and discussion

##### 1) Contact material effect

The study shows that the effect of transition of the arc discharge into a glow is dependent on contact material. However, it is observed that for both refractory and non-refractory materials under specified conditions of operation no loss of materials (such as silver and its alloys) is attainable. It is also found that for consecutive switching under identical conditions, the transition in each operation is not identical but the trend is similar. Also the arc to glow transformation is subject to the law of probability. In general the glow discharge

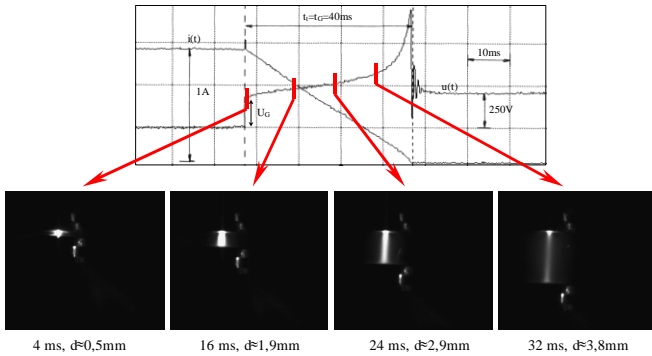

Fig. 4. Glow discharge triggered at the beginning of the contact separation when breaks inductive load DC (250 V, 1 A, 40 ms) in air ( $\sim 100$  kPa) with contacts made of fine nickel. ( $t$ ,  $t_G$  – total and glowing time respectively,  $U_G$  – glow voltage)

at contact opening is found to arise most easily when fine nickel is applied to the contact. This condition is attainable even at the beginning of contact displacement (at the moment of bridge evaporation or protrusions explosion) as illustrated in Fig. 4. The dissipated discharge energy within the contact area is at a much higher voltage level ( $U_g$  about 300V) and current decreases linearly with time. But, both contact erosion and switching over-voltage values are reduced significantly.

In general glowing is generated due to transition from unstable arc discharge (short arc, showering arc) which can be seen from Fig. 5 and Fig. 6. In these cases the discharge tends to lead to occasional arcing due to explosive erosion from the cathode (see in Fig 5, the 30 ms and gap length ( $d$ )  $\approx 3.6$  mm).

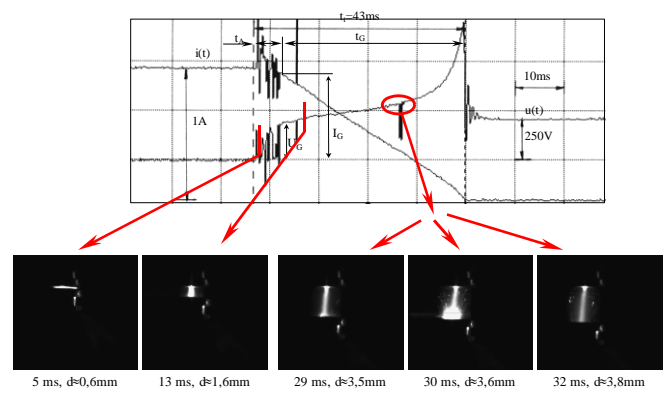

Fig. 5. The unstable arc to glow transition when use the nickel contacts (250 V, 1 A, 40 ms, air  $\sim 100$  kPa) ( $t$ ,  $t_{ARC}$ ,  $t_G$  – total, arcing and glow discharge time respectively,  $U_G$  – glow voltage,  $I_G$  – arc to glow transformation current value)

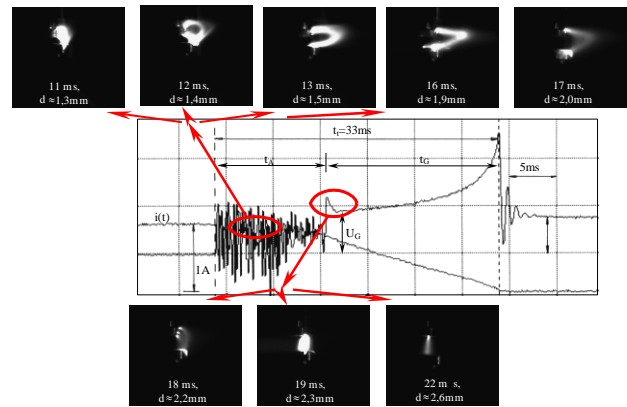

Fig. 6. Development of the electrical discharge when use contacts made of fine molybdenum (250, 0.5 A, 40 ms, in air under 100 kPa)

This is related to a sudden change of the cathode surface conditions and associated reinforced emission, which confirms the major role of this electrode.

For the contacts made of refractory materials like tungsten or molybdenum the arc to glow transformation can also be obtained. However, the extensive unstable arcing can be seen even for relatively low current values when interrupted as demonstrated in Fig. 6. Since the arc appearance for tungsten and molybdenum contacts does not vary significantly in pure argon (as a quenching medium), the increased oxidation of the contact surface in air at an elevated temperature does not seem to be a major stimulating factor. Besides, it is worth noting that just at the transition moment, the anodic spot may be split into a few separate parts (see in Fig 6, the three spots at 18 ms and gap length ( $d$ )  $\approx 2.2$  mm). It appears that the diffused anodic arc or multi-spot glowing also confirms the importance of the anode and complexity of the problem. It has been reported that the arc to glow transition can be initiated at a current ( $I_G$ ) higher than so called 'minimum arcing' current values ( $I_{cr}$ ) for the applied contact materials [2,4]. This is particularly visible for fine nickel where ratio of  $I_G/I_{cr}$  value can reach 2.5. The fine copper, similar to silver and its compositions is found impractical as a contact material under DC heavy inductive loads. This is because the electric discharge within the contact gap area is usually dominated by a stable electric arc [20-22]. However, for copper-molybdenum condensed materials, with the increase of the molybdenum content (under the test up to about 14%) the arc to glow transition is visible, but with a small portion of glow duration. A comparison of the total discharge time and portion of the arc and glow duration for tested contact materials when interrupting inductive load (250V<sub>DC</sub>, 1.0A, 30ms) in open air under normal pressure ( $\approx 100$ kPa) is shown in Fig. 7. The results of measuring the radiation spectra (Figs 8 and 9) during electrical discharges at contact opening confirm the arc to

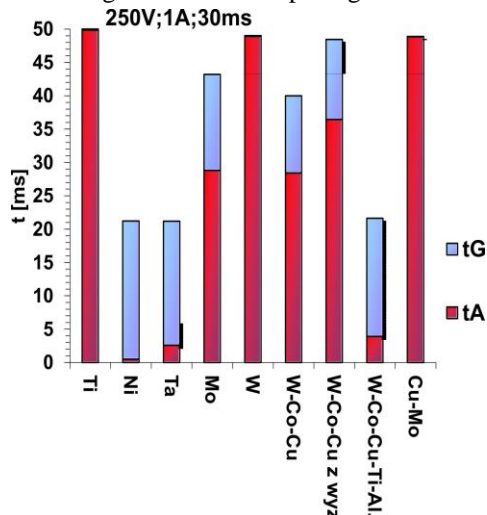

Fig. 7. Comparison of total discharge time and portion of the arc ( $t_A$ ) and glow ( $t_G$ ) duration for tested contact materials when interrupting inductive load DC (250V, 1.0A, 30ms) in open air under normal pressure ( $\approx 100$ kPa)

glow transition phenomenon. The spectrum from the arc in Fig. 8 consists of emission lines from both the electrode metal vapor and the gas. In contrast, the spectrum of Fig. 9 from the glow consists mostly of lines from the gas. The plasma temperature could not be estimated from the spectral line widths due to insufficient spectral resolution in our measuring instrumentation. The contribution of gaseous elements (when operated in air) in arc radiation intensity is about 60%. As

shown in Fig. 9, the intensity of the glowing radiation is about 10-times lower and exhibits the same profile as the arc irrespective of contact material. The contribution of the electrodes elements under glowing, which is about 14%, results most probably from the fact that the metallic vapours

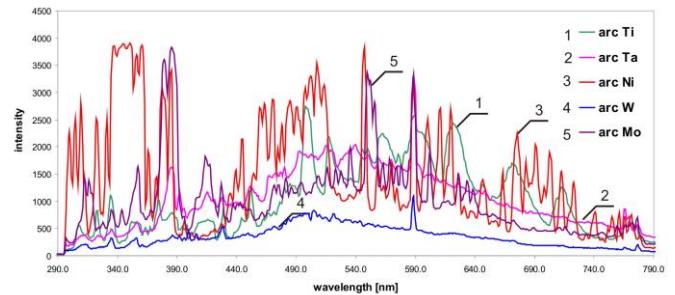

Fig. 8. Radiation spectrum of breaking arc in air under normal pressure for contacts made of different fine materials (Ti, Ta, Ni, W, Mo)

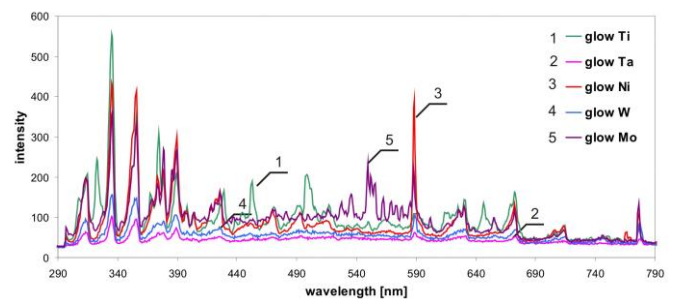

Fig. 9. Radiation spectrum for glowing discharge at contact opening in air for different fine contact materials (Ti, Ta, Ni, W, Mo)

inject into the gap area at the moment of bridge or protrusion explosion.

## 2) Velocity and contact gap effect

The arc to glow transition, which occurs under DC inductive loads in a gaseous medium does not exhibit a strong dependence, neither on contact opening velocity (under the

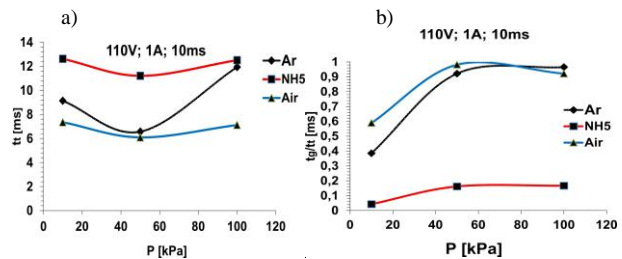

Fig. 10. Variation of the discharge time  $t$ , and the portion of the glow duration ( $t_G/t$ ) versus pressure ( $P$ ) when interrupting inductive load DC (110V, 1A, 10ms) in selected gaseous mediums (air, argon, nitrogen-hydrogen 5% mixture) with contacts made of fine nickel.

range investigated) nor on the gap length. Note that maximum velocity up to about 0.4 m/s is selected due to the compliance and damping of bellows anticipated for use in a real model of hermetic compact auxiliary switch operating, according to DC-13 category of utilization. The glow discharge can be reached almost immediately after contact separation (contact gap  $\leq 0.1$  mm) or after short arcing (contact gap  $\leq 2.5$  mm) so the discharge phenomena are greatly affected by the electrodes and their neighboring contraction regions. Therefore, the arc to glow transformation seems little dependent on contact gap



length. The rate of voltage at the glow stage is found to be positive for contact material investigated at contact velocity up to about 0.4 m/s (see Fig 4-6). However, it is interesting to note that for AgCdO contacts it can be positive in the range of opening velocity up to about 0.4 m/s while in the range from 0.5 m/s to 0.75 m/s becomes negative [6]. For higher ( $> 0.5$  m/s) opening velocity it is also observed that both velocity at contact separation and also variation of acceleration can be important for the control of arc-to-glow transition.

### 3) Load and environment effect

For the given stored circuit inductive energy (circuit time constant) the total discharge time ( $t_i$ ) is found to be almost independent on the quenching medium pressure particularly for air and nitrogen-hydrogen (5%) mixture. However, as shown in Fig. 10a, for fine nickel contacts, the quenching medium pressure reduction is more pronounced to about 50 kPa when pure argon is applied. Fig 10b depicts the ratio of the discharge time  $t_i$  and the portion of the glow duration ( $t_G/t_i$ ) against various pressures (P) when interrupting an inductive load DC (110V, 1A, 10ms) in selected gaseous media (air, argon, nitrogen-hydrogen 5% mixture) with contacts made of fine nickel. It is also worth noting that in argon the glow duration is extending due to a much lower glowing voltage ( $U_G$ ) value [6]. On the contrary, when the air is replaced with  $N_2+H_2$  (5%) gaseous mixture, the results under both normal and decreased pressure appear unsatisfactory due to the generation of high stability arc discharge [6]. The total discharge time  $t_i$  as well as the portion of the glow duration  $t_G$  is enhanced by the increased supply voltage, which for different contact materials is illustrated in Fig 11. For almost all materials applied, it is found that there is a certain value of gas pressure under which the arc is easily transformed. The best results are obtained for the fine nickel contacts when used either with pure argon or air (as a quenching medium) under

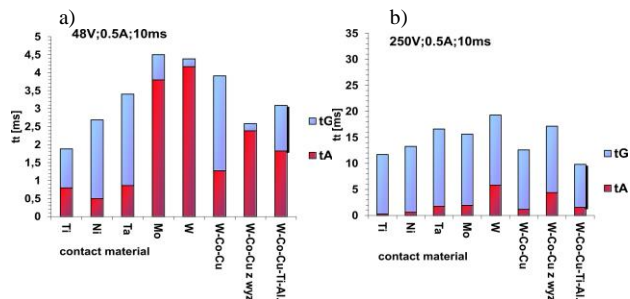

Fig. 11. Comparison of total discharge time ( $t_i$ ) and portion of the glow duration ( $t_G$ ) for tested contact materials when interrupting inductive load DC (0.5A, 10ms) at different voltage value (48V and 250V) in air under normal pressure ( $\sim 100$ kPa)

pressures around (50-100) kPa. However, titanium seems to be promising as well particularly as a dopant for fine powder sinters (Fig 11) [13]. The superiority of fine nickel as a contact material over tungsten concerning the arc to glow transition, particularly as the current increases is visible in Fig. 12. The portion of the glow duration here, is the highest under the same conditions of operation which reduces surface erosion significantly. The surface topography inspection, as well as a microstructure

analysis, indicates that in a case when the arc-glow transition occurs easily the erosion is less extensive. For example, for pure nickel the eroded area of the contact surface (particularly the anode) after about 300 switchings is found to be

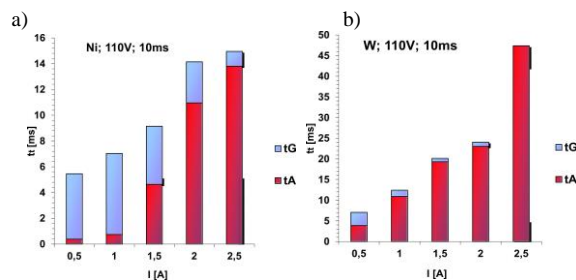

Fig. 12. Comparison of total discharge time ( $t_i$ ) and portion of the glow duration ( $t_G$ ) for nickel and tungsten as contact materials when interrupting inductive load DC (110V, 10ms) at different current value in air under normal pressure ( $\sim 100$ kPa)

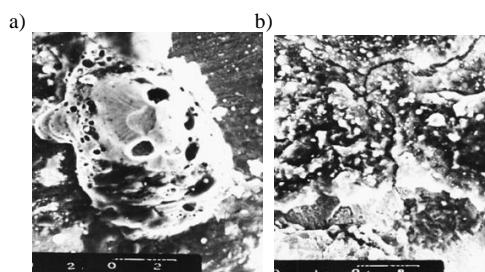

Fig. 13. Micrographs of selected eroded surface of an anode for nickel contacts(X1000), (a) -after 40 operations with dominant arc discharge (1.2A, 110V, 10ms), (b) -after 300 operations for dominant glowing (1A, 250V, 30ms).

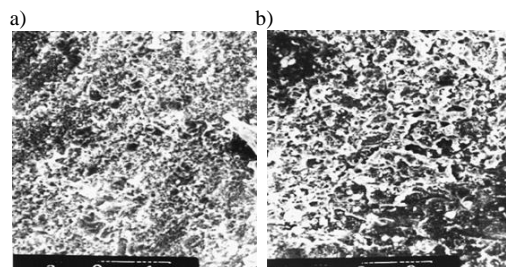

Fig. 14. Micrographs of selected eroded surface of cathode for nickel contacts(X1000); (a)-after 40 operations with dominant arc discharge (1.2A, 110V, 10ms), (b)-after 300 operations for dominant glowing (1A, 250V, 30ms).

significantly smaller than after 40 switchings with predominant arcing [5,12]. This is equivalent to an increase in electrical life of the switch. For example, Fig. 13 and Fig.14 show micrographs of selected eroded surfaces of the nickel contacts after operation when subjected to an arcing and/or glow discharge. It can be seen that the surface erosion is much less for dominated glowing., especially the anode when compared with the number of switchings.

### 4) Relation to theoretical results

The modeling of the arc transition into glowing is based on a large error due to complex phenomena and mutually dependent parameters. Unfortunately, despite the extensive experimental research, changes in transient cannot be determined precisely, mostly due to the lack of appropriate available high resolution measuring equipment. Therefore, the

tests are usually conducted for steady state of arcing and separately for stable glowing. In our case, use of fast-photography was very helpful when combined with analysis of the current and voltage waveforms and variation of elongation of the contact gap as a function of time. It was not possible to perform a similar study with reference to emission spectra due to the long measurement time of the spectrophotometer applied (Although this spectrometer could be set to measure the spectrum at every 5ms data transmission time to the computer was around 100ms).

However, it should be noted that for a given switching circuit, the parameters  $R$ ,  $L$ ,  $C$  are already predetermined. Thus, only on the basis of the calculated value (from measurements) arc resistance ( $R_A$ ) one can estimate the thermal time constant of this arc  $k_A$  for which, the transition of the unstable arc (usually short) to the glowing can take place. The  $k_A$  value is of course nonlinear and depends primarily on the power  $P$  provided to the arc, its temperature  $T_A$ , and arc volume  $V_A$ , according to (5). Therefore, using the eqn.(5) for the experimentally selected values of the arc volume and its temperature one can estimate the maximum power value of the arc, i.e. the maximum value of the current at which interruption of the arc-to glow transition will take place. Note, that if the arc resistance  $R_A$  tends to infinity, the  $k_A$  value is close to the circuit time constant ( $T=L/R$ ).

#### IV. CONCLUSION

The transition of the switching arc into glow in inductive circuits of low voltage and low power (the most onerous category of utilization - DC-13) is an advantage because it significantly decreases erosion of the contact surface, thus extending the switch life and reduces the voltage surge.

Due to the complexity of mutually interacting phenomena greatly affected by the electrodes and their neighboring contraction regions exact control of the transition effect of the DC switching arc into a glow discharge is particularly difficult to achieve. It is almost impossible to keep the same conditions at both the electrode surfaces and within the contact gap area during subsequent switching cycles, in particular under varying load conditions.

Thus, although repeatability of current as well as switching voltage waveforms at each successive cycle is not satisfied, statistically the transition of arc into a glow discharge will be achieved. Theoretical conditions specifying the criteria to ensure arc instability can be mathematically formulated for particular electrical circuits on the basis of non-linear differential equations of the circuit with electric arc. However, the transition can be obtained for any low voltage and low power contact switch, operating even in open air, but it is particularly recommended for auxiliary encapsulated (hermetic) switches of a compact structure, in which many interfering effects, such as oxidation, contamination etc. can be reduced or even eliminated.

#### REFERENCES

- [1] J P Meckler, f. Gerdinand, R.Weiss, U.Boeke, A. Mauer "Hybrid switches in protective devices for low-voltage DC grids at commercial used buildings" Proc.of 27th Int.Conf. on Electric Contacts, June 22-26,2014. Dresden Germany,pp.120-125
- [2] R. Holm " Electric contacts.Theory and applications" Marcel Dekker Ed.Basel, Switzerland,1999
- [3] T.E.Browne "Circuit interruption. Theory and design" Marcel Dekker Ed,1984
- [4] P. Slade: "Electrical Contacts Principles and Applications, Marcel Dekker Ed. Basel, Switzerland, 1999
- [5] B. Miedzinski, A.Szymanski, G.Wisniewski, A.Grodzinski: „Transformation of low power arc to glowing under inductive load DC" Proc.Int. Conf. SAP 2001, Lodz, Poland, 17-20.09.2001, pp.117-120
- [6] S.N.Kharin, H.Nouri, B.Miedzinski, G.Wisniewski:" Transient phenomena of arc to glow discharge transformation at contact opening" Proc.of 21st Int.Conf.on Electric contacts, Zurich,Switzerland, 9-12.09.2002,pp.425-431
- [7] S.N.Kharin:" Post bridge phenomena in electric contacts at the initial stage" IEEE Trans on Comp. Packaging and Man.Tech, partA,vol19,No3,1996,pp.313-319
- [8] S.N. Kharin:" Mathematical model of the short arc phenomena at the initial stage" Proc.43rd IEEE Holm Conf. on Electric Contacts, Philadelphia,USA, 1997,pp.289-305
- [9] S.N.Kharin:" Mathematical model of the arc evaluation from metallic phase to gaseous phase" Proc. 20th Int.Con. on Electric Contacts ,Stockholm,Sweden, 2000,pp.155-160
- [10] A.E.Guile;" Arc -electrode phenomena" Proc IEE Reviews ,vol118, No 9R,September 1971,pp.1131-1154
- [11] F. Llewellyn-Jones:" The glow discharge and an introduction to plasma physics" London-Methuen Co.Ltd. 1966
- [12] H.Nouri, B.Miedzinski, S.N.Kharin, G.Wisniewski:" Analysis and investigations of arc to glow discharge transformation under DC inductive load" Mechanizacja i Automatyzacja Górnictwa MIAG,No8/439,2007,pp.7-22

- [13] N.Ben Jemaa "Effect of Parameters on the Transition from Anodic to Cathodic Arc" Proceedings ICEC, 1999 pp. 173-179
- [14] C.W. Mills:" The mechanism of the showering arc" IEEE Trans. on Parts,Hybrids and packaging, vol PMP-5, No1,1969,pp.47-55
- [15] G.A.Mesyats:" Catodic spot at an ecton process" Proc. 41st IEEE Holm Conf, Montreal, Canada,1995,pp.247-251
- [16] S.N. Kharin, H.Nouri, T.Davis:" Influence of inductance on the arc evaluation in AgMeO contacts" Proc.48th IEEE Holm Conf, Orlando,USA,2002,pp.108-119
- [17] E.F.Beckenbach: Modern mathematics for the engineer. New York. McGraw Hill 1961.
- [18] F.R. Gantmacher, Theory of Matrices, Nauka Edition, Moscow, 1967
- [19] P. Bakowski, B. Miedzinski, S.Szkolka, H.Poniewierski:" System for material testing of hermetic switches" Proc SAP-93 Conf., Lodz,1993, pp.301-304
- [20] B. Miedzinski, G.Wisniewski, V.N.Shoffa, N.I.Grechanyuk:" Performance of copper-molybdenum contacts when used for inductive DC load" Electrical Contacts and Electrodes, Institute of Material Science 2004,pp.19-23
- [21] B.Miedzinski, P.Wojtas, J.Wosik, A.Kozlowski, A.Grodzinski N.I.Grechanyuk:" Usefulness of laminated Cu-Mo composites as contact material for low –voltage power contactor" Proc.27th ICEC, June 22-26,2014, Dresden,Germany, pp.215-220
- [22] S.N. Kharin, H. Nouri, T. Davies, "Influence of Inductance on the Arc Evolution in AgMeO Electrical Contacts", Proc. 48th IEEE Holm Conf. On Electrical Contacts, Orlando, USA, 2002, pp. 108-119