

FAMILY RITUALS 2.0

EPSRC

Engineering and Physical Sciences
Research Council

CONTENTS

02	Forward
04	Introduction
10	Project Overview

Stage One

13	Understanding The Work/Life Balance Of Mobile Workers
18	Working With Families
19	Interview Locations
20	The Families
22	Research Through Design
25	Design Ethnography
26	Design Ethnography Probes

Stage Two

43	Ritual Machines
44	Design Briefs; The Ritual Machines
66	Ritual Machine; Living With The Families
78	Ethnography Through Design; Reflections From the Designers
82	Conclusion
84	Research Team & Acknowledgements
86	Project Outputs

FAMILY
RITUALS
2.0

FORWARD

Professor Glenn Lyons

Associate Dean Research and Knowledge Exchange,
University of the West of England, Bristol

In July 2013, the *Engineering and Physical Sciences Research Council (EPSRC)* trialed an experimental approach for bringing researchers together around the theme of 'Sustainable Society: Achieving work/life balance in a digitally dependent world'. The *Creativity Greenhouse* utilised a virtual suite of meeting rooms where discussion were had, and ideas developed, between 16 participants and research mentors, working virtually from multiple locations across the UK.

The participants in the *Creativity Greenhouse* had to respond to the research challenge that was to generate an interdisciplinary project dealing with the potential benefits and concerns about the future digital economy in relation to work/life balance. Various questions such as: 'What opportunities does the Digital Economy give in pursuit of greater work/life balance, e.g. remote working, creating time-space flexibilities in activity engagement, living and working in the Cloud?'; 'What is the future shape of social networking and how does this influence the nature and extent of co-present social interaction?'; and 'What is the need for regulatory control to provides checks and balances to the technology wave?', were used to stimulate thinking.

Family Rituals 2.0 emerged as one of three projects awarded funding from this event.

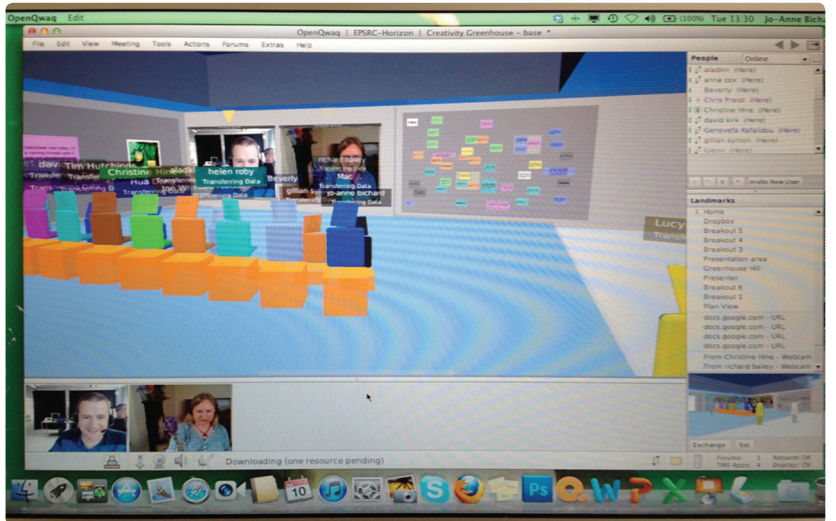

Fig 1. The virtual suite in the Creativity Greenhouse where the Family Rituals 2.0 project was conceived.

INTRODUCTION

Dr David Kirk

Principal Investigator *Family Rituals 2.0*

The notion of family is broad (and changing) and encompasses a variety of different social structures beyond the classic conception of the nuclear family [1] yet it is a cornerstone of our social worlds. Even as many in 'Western' society follow the trend of isolated living, in single occupant dwellings [ibid], for most people, notions of home are intimately tied to notions of family. We form familial bonds (regardless of traditional notions of kinship) [ibid], with those with whom we live.

The rise of network society [2] and the pervasiveness of digital technologies [3] has however, meant that the boundaries between our working and domestic lives are becoming increasingly blurred [4]. The impacts of this on home and family life are being further exacerbated by changes in our patterns of living, which are pushing us towards increased mobility and itinerant domesticity [5]. Increasingly, life is marked by significant periods of absence from home and family, and increasingly we may turn to digital technologies to help us mediate that absence.

Arguably, a core element of domestic life is its ritualistic aspects, which are important features of the functional and emotional landscape of the home [6]. Wolin and Bennett [7] have defined family ritual as “**a symbolic form of communication that, owing to the satisfaction that family members experience through its repetition, is acted out in a systematic fashion over time.**”

Family Rituals 2.0 sought to understand the ritual activities that families engage in during periods of remote working, and to speculate on the potential roles of technology in mediating complex working family lives.

[1] Chambers, D. (2012) *A Sociology of Family Life*. Polity

[2] Castells, M. (2009) *The Rise of the Network Society: Information Age: Economy, Society, and Culture*. (2nd Ed). Wiley-Blackwell

[3] Greenfield, A. (2006) *Everyware: The Dawning Age of Ubiquitous Computing*. New Riders

[4] Nippert-Eng, C.E. (1996) *Home and Work: Negotiating Boundaries through Everyday Life*. University of Chicago Press

[5] Urry, J. (2007) *Mobilities*. Polity Press

[6] Bell, C. (2010) *Ritual: Perspectives and Dimensions*. Oxford University Press

[7] Wolin, S. and Bennett, L. (1984) *Family Rituals*. *Family Process Journal*, 23, 3

Figs 2- 8. (mixture of ethno-graphic tools, ethnography and machines)

A SYMBOLIC FORM
OF COMMUNICATION THAT,
OWING TO THE SATISFACTION
THAT FAMILY MEMBERS
EXPERIENCE THROUGH ITS
REPETITION, IS ACTED OUT
IN A SYSTEMATIC FASHION
OVER TIME



Fig 2.

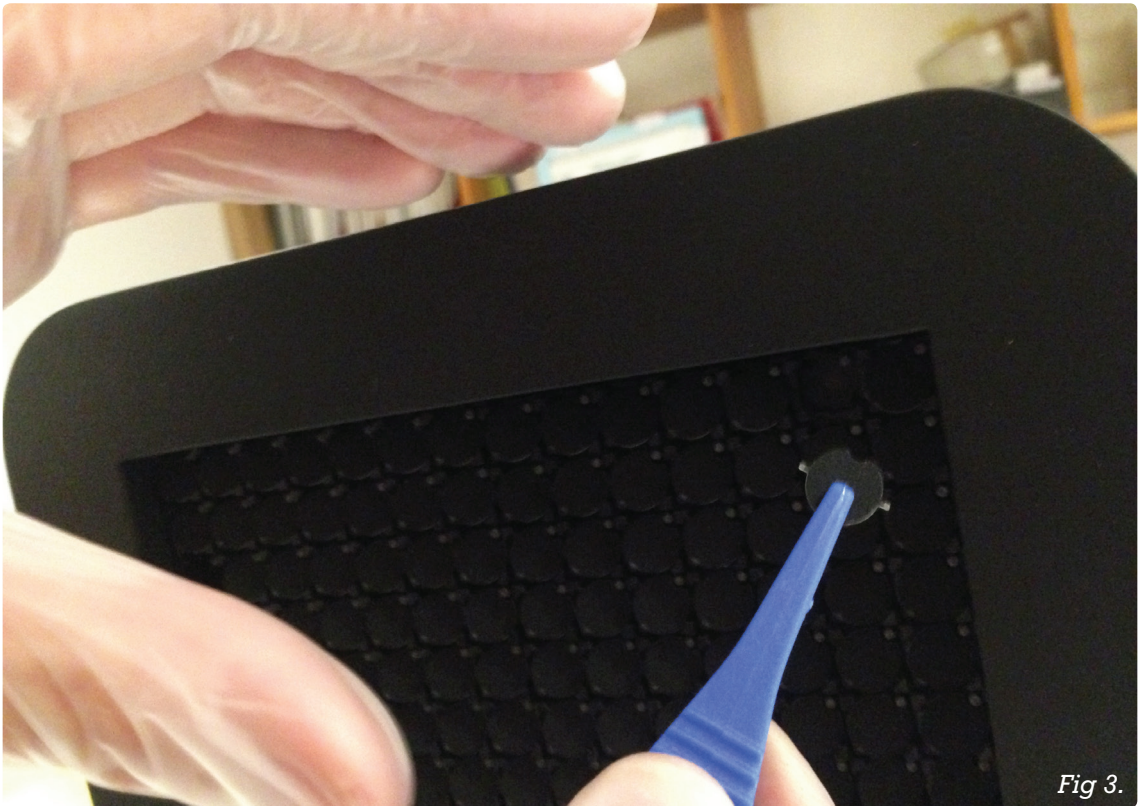

Fig 3.



Fig 4.



Fig 5.

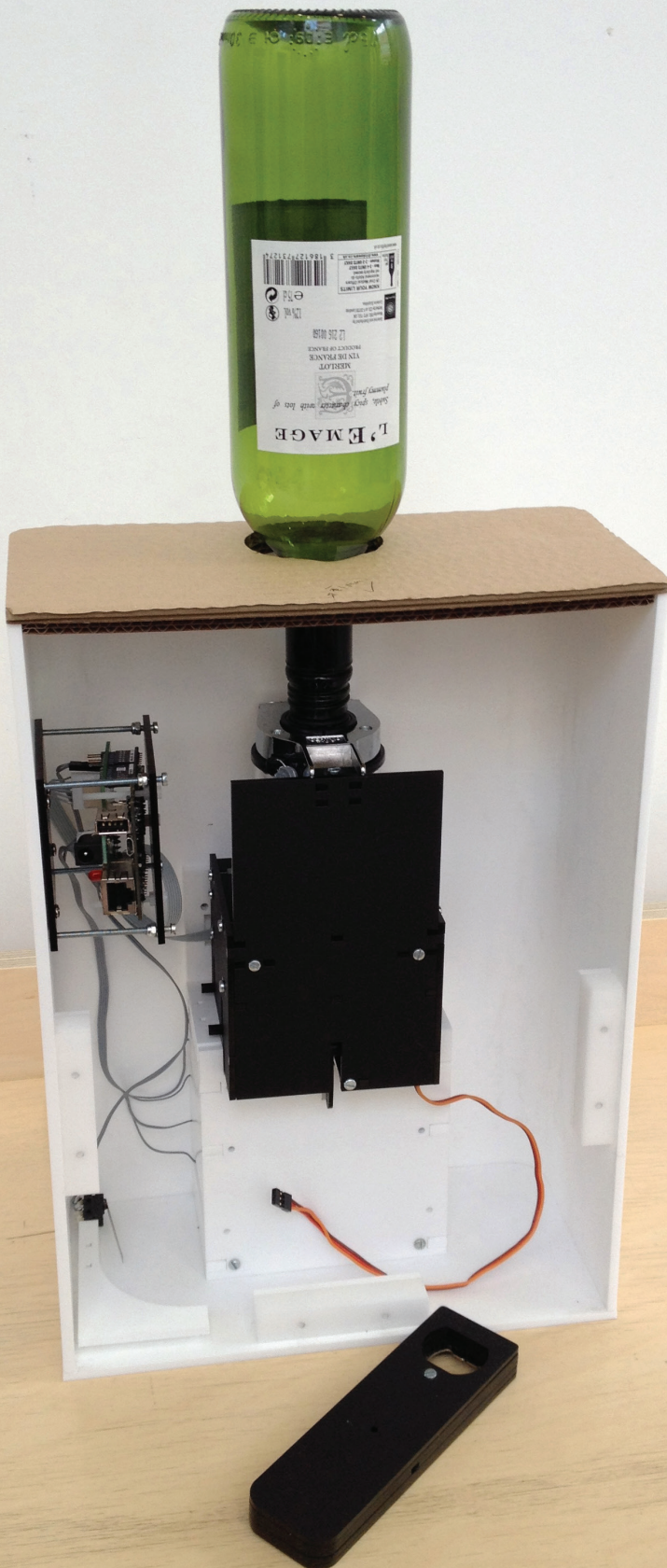

Fig 6.

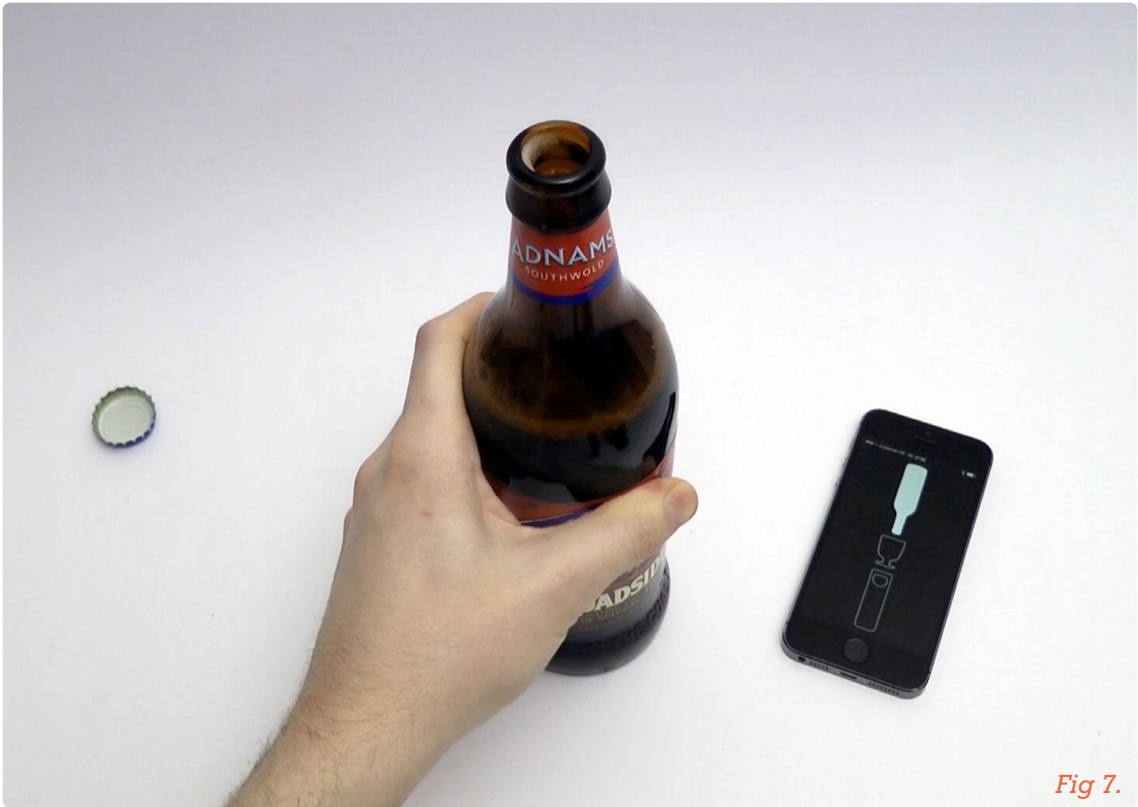
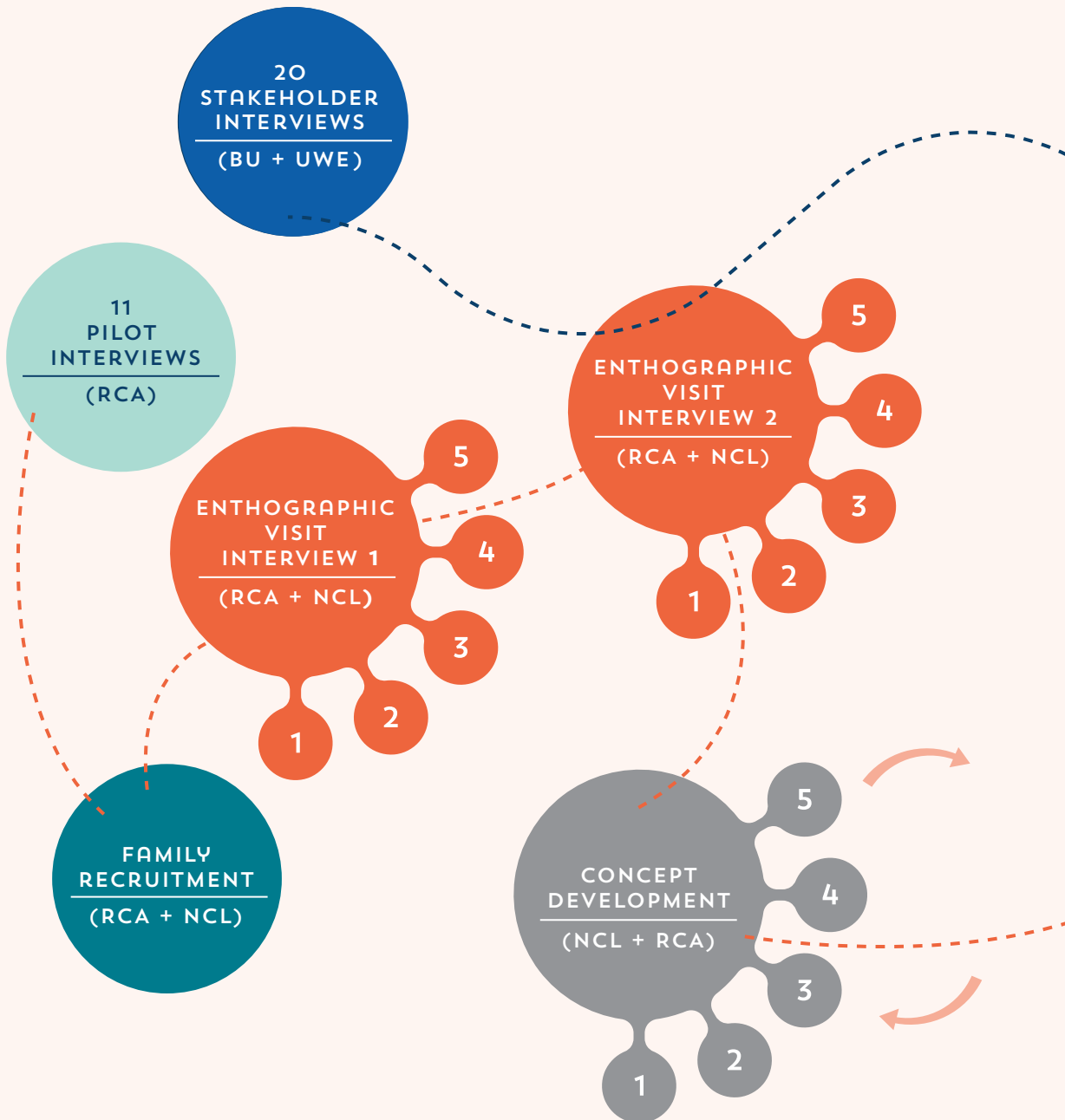

Fig 7.



Fig 8.

PROJECT OVERVIEW



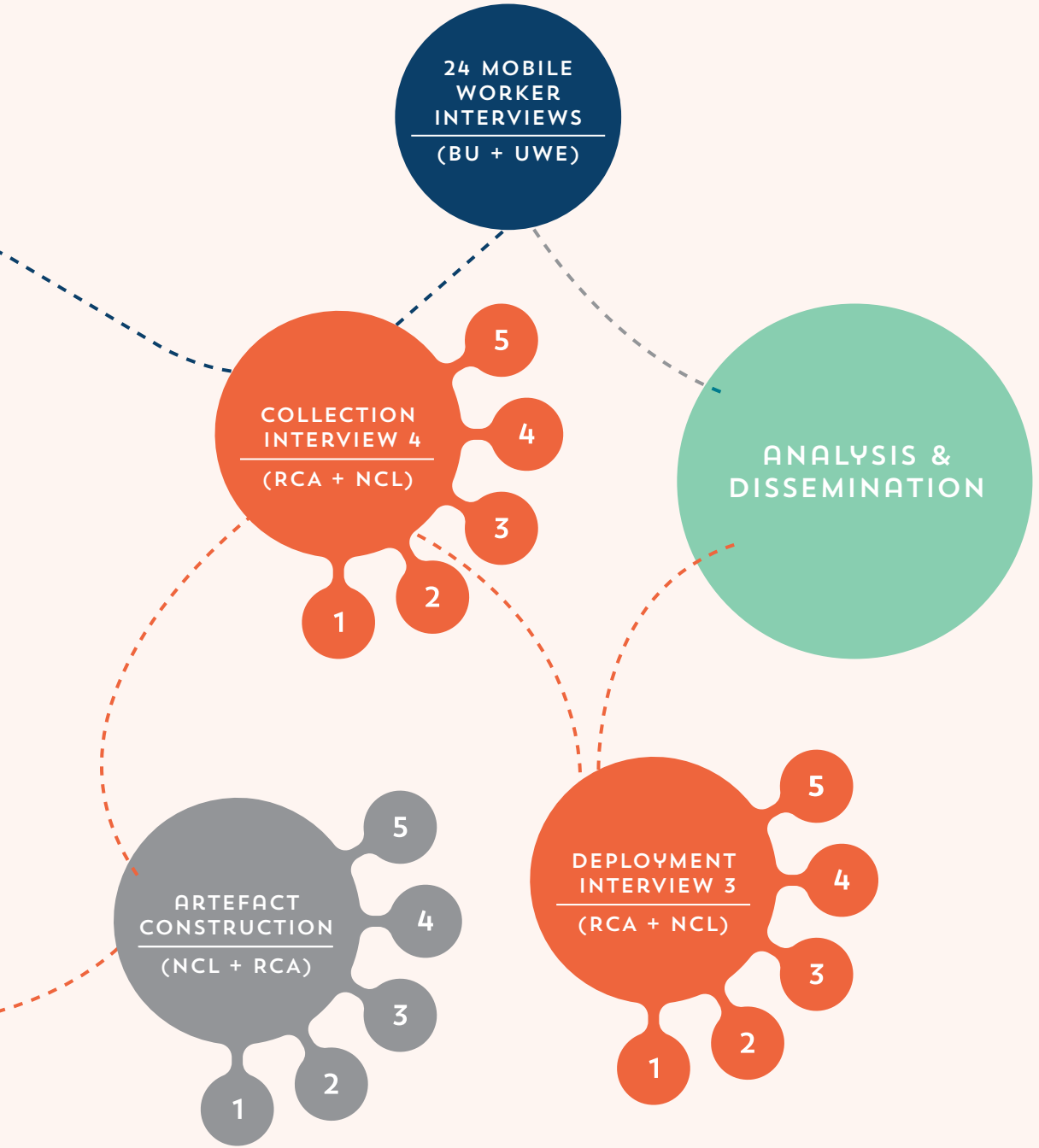

STAGE ONE

UNDERSTANDING THE WORK/LIFE BALANCE OF MOBILE WORKERS

**Dr Juliet Jain, Dr William Clayton,
Professor Adele Ladkin,
Dr Marina Marouda**

A key element of *Family Rituals 2.0* was to find out how employers considered the experiences of their employees who travel away for work, and identify any company policies that informed issues of work/life balance for this group of people. Human resource managers from 15 organisations, representing small public sector to large corporate multi-nationals, were interviewed. Sectors included tourism and hospitality, transport and logistics, media, non-governmental organisations and consultancy organisations. Who travelled, the type of travel and destinations varied across sector, with some employees travelling abroad for significant periods of time, others describing frequent but shorter-term national and international travel, and some only travelling on a national scale.

Many organisations consider the work/life balance needs of employees, often offering flexible working or the opportunity to work from home.

However, none of these organisations specifically considered the needs of mobile workers beyond what was required to perform their jobs while away (e.g. providing a phone or laptop computer). However, in the logistics sector there was more concern about the work/life balance of drivers than office-based staff who may also travel as part of their work. While many workers were given phones and laptops for work, more generally these were perceived as work tools rather than a means of connecting back home.

“Embedded into our culture is that we encourage work/life balance.”

Employer interview

Findings from the family interviews and design ethnographies may be able to prompt employers to consider the impact of work related travel and absence from families and the need to support it in innovative ways.

Twenty four mobile workers provided insights into their work, family life, and the experiences of communicating with home when away with work. Eleven of these gave the research team additional access to family members. The second interview with the mobile worker and the family member(s) explored meaningful family activities, and how these were experienced when the mobile worker was away. The sectors the mobile workers came from included haulage, media, seafarers, airlines, public transport, charity workers, tour operators and oil workers.

Most of the mobile workers enjoyed the travelling they undertook for work, and some of whom had taken the job precisely because of the travel involved. Being away was often justified as enabling more time at home, or greater flexibility with family. For instance, some people were able to condense work into fewer days, or worked on rosters that enabled longer periods off. At the same time these workers recognised that being away was not always easy for the person(s) left behind at home.

The activity that was important to most families was eating and drinking. This included shopping for food and preparation, as well as sitting down together.

Some people noted keeping intergenerational family traditions such as a Sunday roast. Families with younger children had many rituals associated with their children like reading stories at night, and children's activities such as sport.

“For me definitely and I think for [mobile worker] as well that bedtime ritual – and especially once they’re out the bath and into bed – for me it’s a really important time, I’ve chatted to them about their day when I’ve picked them up from nursery, I’ve found out how they’ve got on, what kind of stuff they’ve done, and it’s just a really nice time to build on the relationships and develop them more and I really enjoy it.”

Female [partner] Family interview

“On a weekday night, just hanging around in the kitchen, having a glass of wine, one of us cooking.” Female [worker] Family interview

RELATIONSHIPS CAN BE
MAINTAINED IN SOME WAYS
AT A DISTANCE THROUGH
DIGITAL TECHNOLOGY,
AND PEOPLE ARE QUITE
RESOURCEFUL IN MAKING THESE
COMMUNICATION TECHNOLOGIES
WORK FOR THEM

Some couples undertook specific activities together, like competitive dancing. For many sharing time in front of the TV, doing crosswords and Sudoku together, or just ‘flopping down’ on the settee were collective family moments. Travelling elsewhere together was also important.

Although the interviews demonstrated there were many ordinary and more special activities that were important to family life, only some of these were integrated into communications with home in a number of different ways depending on the nature of the activity, the choice of the communication ‘tool’, and any time differences if abroad. However, many activities for example – sharing a Sudoku puzzle over coffee on a weekend, or going to a dancing class together – could not be mediated. Absence was readily noted and not easily substituted.

In other instances shared activities or interactions were managed at a distance. Examples include a woman who travelled a lot would read to her son over *FaceTime*; a father would phone in and provide parental support over the speaker phone when the family drove home from school; and another couple asynchronously shared amusing observations via photo messaging.

Some families deferred wider social and cultural events such as Christmas until they were all together at home. Sometimes it was only when absence from a family event had been experienced the need to be there was expressed by other family members.

Often the ability to connect was limited by time. Time-zone differences, the needs of work, and the cost of communicating contributed to such time limitations. It emerged that mobile workers often ‘digitally glimpsed’ home through short catch-ups and brief interactions. They rarely partook of generic activities at-a-distance by linking up via a webcam (e.g. through *Skype*) just to be connected while getting on with things (which has been the approach noted by in studies of some migrant workers).

“Going to X location to watch football with A and B... It is quite mundane and everyday but it’s those things that I miss a lot. And we don’t do hugely exciting stuff, we are not into mountain bike riding or hand gliding or anything – yachting or anything like that, we don’t do that sort of thing. But it is that ‘everydayness’ of walking round a supermarket together and having a laugh about what’s on the shelves. It is really that simple.”

Male [worker]

Mobile worker interview

“Like, Freya ‘Snapchats’ me a little cool thing of making our son smile, or snoring, or when he’s sleeping he’s doing some giggles in his sleep; so she Snapchats it to me, which is kind of cool. It’s nice, it’s just like a little snippet, it makes me go: ‘oh I want to be there’, but also it’s without going through the whole thing of “let’s go on Skype and then holding the phone up”. And just like a little kind of snapshot of my life. My normal life at home I suppose.”

Male [worker] – Mobile worker interview

Travelling for work sometimes felt lonely for the mobile worker and there could be a sense that time was continuously work orientated, however for some it gave the opportunity to do tasks digitally that supported home life. A pilot explained how he could undertake ‘boring’ tasks like searching for deals on the Internet while he was away, so he had more time with the family when at home.

Veteran mobile workers indicated that sustaining a level of mobility and family life could be challenging over time. Family members become less tolerant of absence, and ceased practicing rituals around leaving and arriving home as absence becomes normalised.

The family interviews support the idea that relationships can be maintained in some ways at a distance through digital technology, and people are quite resourceful in making these communication technologies work for them.

“We Skype, mainly in the house, I would call them. You can see what they are doing so they can show you things they’ve made or drawn or pictures or something, something they can show you, so take the iPad around the house and show you things.” *Male [worker] – Family interview*

However, employers might consider these issues in more depth concerning how communication time between the employee and their family is facilitated, especially where different time zones make connection time harder, and how a positive family experience of work-related mobility can be beneficial for employee wellbeing and sustained over time.

“So back in the day, I would have experienced Harry’s disappearances as a treat, but now it’s the other way round. God; scary!”

*Female [partner]
Family interview*

WORKING WITH FAMILIES

Opening the door onto the intimacy of family life can be difficult, especially when people are busy and frequently away. To recruit mobile workers and their families for the project we had to use a lot of different approaches to generate interest – adverts on social networking sites such as *Netmums*, e-mails through the employers, flyers and press releases were some of the ways people were recruited. For the mobile worker and family interviews it was difficult to gain access the family due to time or interest, so in some instances only the mobile worker was interviewed. The sample of 24 mobile workers included eight females and 16 males, who were employed in a range of sectors with varying travel patterns, and had a range of family contexts. Additionally the 11 family interviews included eight female partners and three male partners. 12 of the families (out of the total 24) had children (but they were generally not included in the interviews). The participants came from a range of employment sectors, had a variety of absence patterns and were from a variety of family types.

Equally, for the design ethnography aspect of the project, accessing families proved to be problematic, especially given the level of interaction ethnographic collaboration can entail; such as spending time with families, observing family rituals, collecting visual data on home and work life as well as interviews. Initially, the programme was designed to recruit families from the mobile worker and family interviews. However, it soon became apparent to the research team that families were reluctant to allow additional investigation to interrupt precious and private family time. These hurdles to fieldwork, forced the design research team to concentrate on recruiting an additional five families for the more in-depth ethnographic work. These five families consisted of four couples with children. Mobile work comprised national and international travel with varying amounts of time spent apart, from a few days to a few months.

A total of 15 interviews were conducted with stakeholders' human resources managers.

In total, 70 people including HR managers, mobile workers and their families, located throughout the UK, contributed to the Family Rituals 2.0 project.

INTERVIEW LOCATIONS

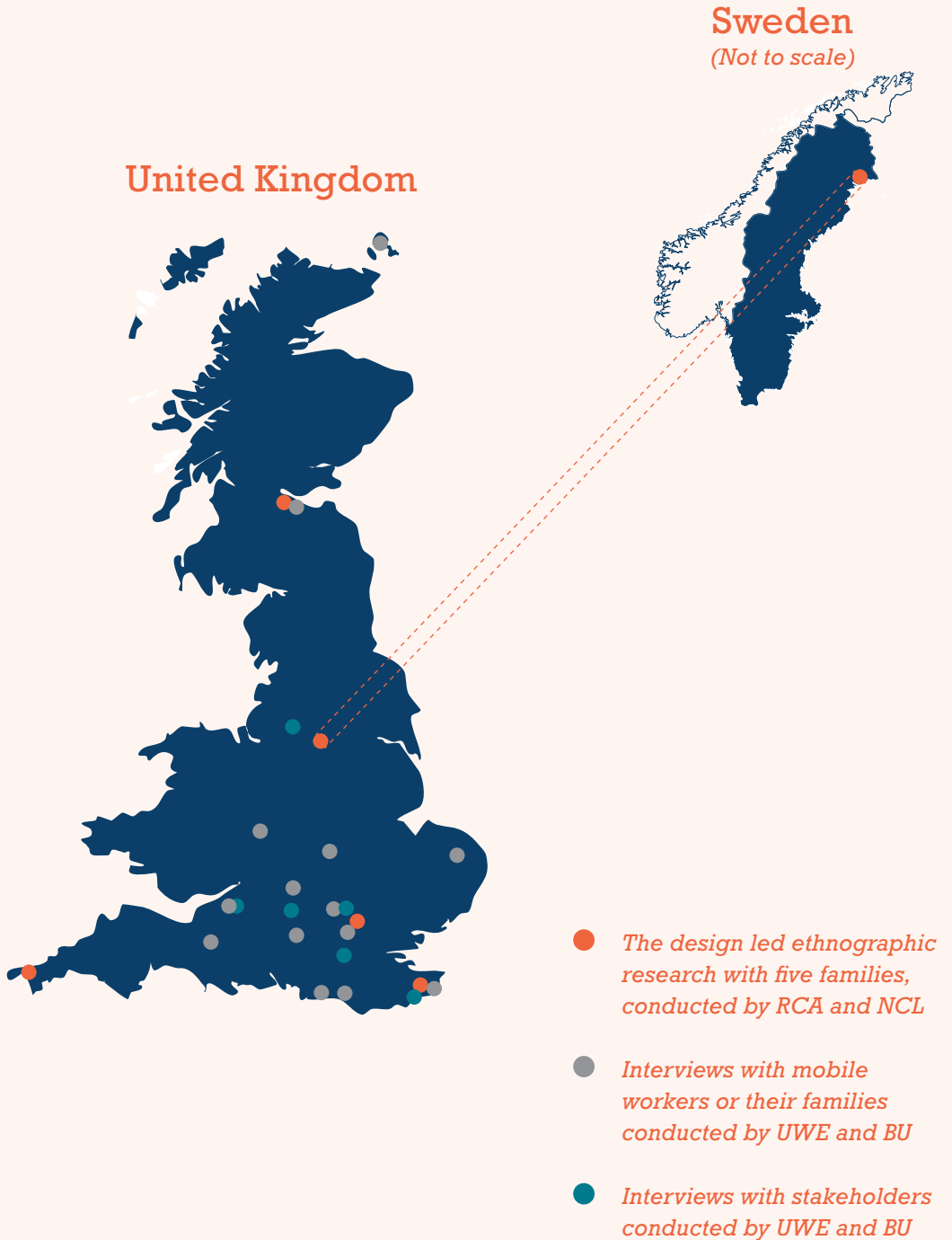

THE FAMILIES

The Five Families for our Design Led Ethnographic Research

The design researchers recruited five families who were regularly separated by work for a series of Design Led Ethnographic case studies, over a typically nine month engagement.

Family One are Craig, Holly and their two-year-old son Sam. They live in Edinburgh, where Craig works as a consultant in the financial sector and Holly is a public relations professional. Craig is frequently away from home for two or three nights during the week, visiting clients in London and the south of England. Holly is now establishing her own company working from home. Holly is Sam's primary carer.

Family Two is Hywel and Jesper, who live in East London. Hywel works in fashion, he is a lecturer and a freelance writer, and is primarily London based. Jesper works in the hospitality industry, and is typically away from home up to eight times a year on both short and longer trips, sometimes for several months at a time.

Family Three is David, Irene and their two teenage children Rikard and Rebecca, and Charlie the family cat. The family home is in Northern Sweden where Irene works as an IT manager; David works in Sheffield as a lecturer and returns home at the end of each academic semester. Whilst in England, David lives in a small town close to his parents and brother, making a daily commute on the train to Sheffield.

Family Four Family Four is Lisa and Will, who live in Kent with their six children: Alex (26), Oliver (16), Steve (12), Kevin (11), Billy (9) and Rachel (8)*. Lisa is a 'tramper', a long distance lorry driver working across the UK. She is away for up to 5 nights every week, sleeping overnight in the cabin of her truck. Her working week begins on Tuesdays and she returns home on Saturdays. Whilst Lisa is 'on the road', Will looks after the younger children at home.

Family Five is Emmie, Mark, their eight-year-old son Joseph and their dog Molly. They live in rural Cornwall, in a house that is adjoined by Emmie's parents. Both Emmie and Mark are self-employed. Mark is a lawyer with clients who are based across the South of England. He makes visits to them in their homes and will typically spend two or three nights away per week. Emmie is a management consultant for cultural organisations; she also has periods of working away from home, but less regularly than Mark.

** Names have been changed to protect the privacy of individuals.*

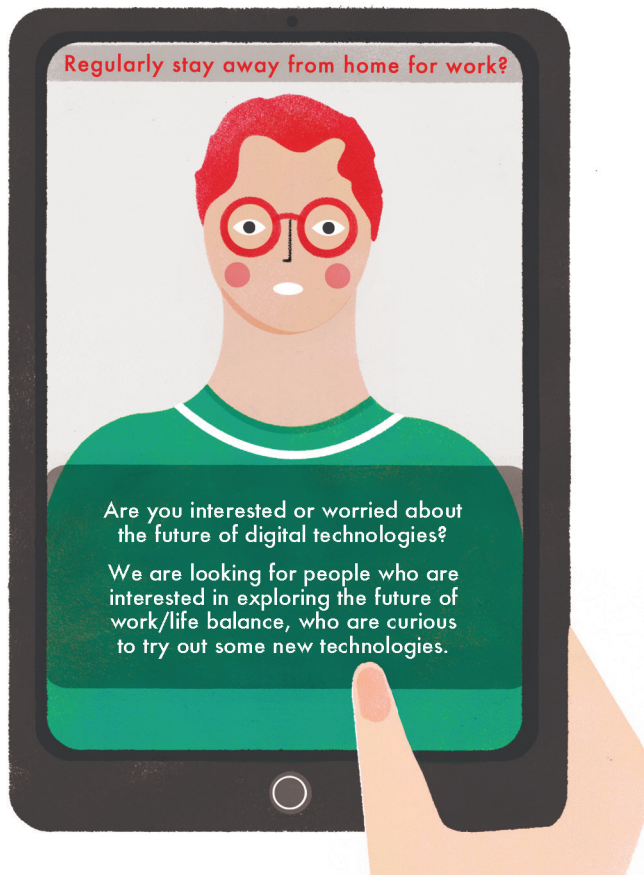

*Fig 9. Advertising material for family recruitment.
Illustration by Naomi Elliott.*

RESEARCH THROUGH DESIGN

Dr Jo-Anne Bichard, Dr David Kirk

Our research through design process incorporated two main phases of activity, phase one utilised design ethnography, deploying specific designed research probes, given to our participating families. Phase two involved the design and development of a series of *Ritual Machines*, each a bespoke designed response to a family's specific circumstances and deployed with them as a provocation and material exploration prompting deeper reflection on their attitudes towards and management of remote working.

The use of such designed artefacts (and supporting interviews) served to act *in absentia* of a design ethnographers' persistent presence by collecting information that served at times as both creative inspiration and critical reflection for the design team. The probes were essential to reflexively understanding how to engage the families taking part in the study.

Our initial findings suggested that regular separation and reunion created a form of 'elastic distancing', an approximation of home life that offers the family periods of reflection and an opportunity to see family life with a fresh perspective. Whilst certain aspects of family life are reflected upon, there is also acceptance that some significant events are missed, but that separation can offer opportunities to foster new kinds of ritual to engender 'togetherness' of another kind.

We also noted distinct rhythms of family life dependent on the length or frequency of absence of the mobile worker. These cycles involved; preparing for separation, separation, preparing for re-union and re-union and re-adaptation to family life together, and appear more frequently for mobile workers who frequently travel, than those who travel less often but are away for longer periods of time. By mapping these rhythms the research highlights that, similarly with the complexity of defining ritual, the complexity of defining a mobile worker are equally tenuous, with idiosyncratic rhythms relevant to each mobile worker and their family.

Rhythms of the Mobile Worker and Family



Travel 3 days a week



Travel 1 week every month



There is flexibility within these rhythms, with some mobile workers shifting from being away for short periods and then long periods. Creating a standard pattern and routine for some mobile workers may be difficult and hence the quotidian rituals of family life may provide key anchors that allow for the elasticity of separation and reunion.



Fig 10.



Fig 11.

DESIGN ETHNOGRAPHY

Our design ethnography aimed to understand how regular separation from home affects the lives of our five participating families and capture the daily rituals that form family life when together and separated. Due to the families' reluctance to allow researchers to conduct a more traditional form of participant observation, we structured our interaction with each family into four phases over a period of roughly nine months.

Phase One involved an introductory visit to their homes, or if this was not possible, a meeting via Skype. This interview covered a range of questions to understand broadly the family's situation, typical activities and practices around being separated by work. At this interview our participating families received a pack of *Design Led Ethnographic Probes*, in the tradition of Gaver et al's [8] *Cultural Probes*. This began Phase Two of the ethnography.

Phase Two concluded after four to six weeks, when we retrieved the ethnographic probes and conducted a second interview; structured around the material the family had generated in that time. By the second interview we had personally met all our families in their homes.

In **Phase Three** we designed and built a bespoke *Ritual Machine* for each family. Using material from our two interviews and the probes, we started to sketch various machines and systems that we believed would create or extend some particular rituals with that family and cause them to reflect further on their separation and work/life balance. After a period of development and refinement the *Ritual Machine* was delivered to the family. At this point a third short interview was conducted, to gauge their initial reactions to, and expectations of, their machine.

In **Phase Four**, the family lived with the *Ritual Machine* for a period of up to eight weeks. At the end of this we conducted a final interview talking about their experiences of living with their machine and their final reflections on their rituals, working practices and the experience of being a participant in the project. We collected the machine at this stage.

At all stages the process was documented with video, audio and photography.

[8] Gaver, W.W., Dunne, A., & Pacenti, E. (1999). *Cultural Probes. Interactions vi(1), 21–29*

DESIGN ETHNOGRAPHY PROBES

Paulina Yurman, David Chatting

In the second phase, previously described, we designed three packs of probes to try to capture fragments of family life, which we could not observe through traditional ethnographic means. We were interested in three periods of time:

- 1) A family pack with probes to be completed by all family members together.*
- 2) A pack for the mobile worker to complete during work trips.*
- 3) A pack for those at home to complete while the mobile worker was on a work trip.*

In each pack we created a playful collection of diverse printed and object-based activities to provide us with a glimpse of their domestic and family life, and more importantly insights into the significant, daily quotidian rituals that formed it. In addition we wanted to gather hints of their sensibilities, styles and attitudes.

These packs were carefully designed to communicate a seriousness and level of finish that would be the basis of building trust with the families for the later machine deployment.



Fig 12.

*Figs 12-14.
Examples of Family Home
and Away Probes*

1) A FAMILY PACK WITH PROBES
TO BE COMPLETED BY ALL
FAMILY MEMBERS TOGETHER.

2) A PACK FOR THE
MOBILE WORKER TO COMPLETE
DURING WORK TRIPS.

3) A PACK FOR
THOSE AT HOME TO COMPLETE
WHILE THE MOBILE WORKER
WAS ON A WORK TRIP.

With some variations, the set of probes consisted of:

HOME:

A DIGITAL QUESTION BOX
ASKING TIMELY QUESTIONS
OF THE HOUSEHOLD WHILE THE
MOBILE WORKER IS AWAY.

A MAP ACTIVITY SO A HOME
GEOGRAPHY COULD BE CREATED.

A BOOKLET CALLED
WHAT MAKES YOU YOU?
WITH QUESTIONS AND TASKS
FOR THE FAMILY.

A LIKE/DISLIKE CAMERA
AND STAMP ACTIVITY.

A CARD ASKING ABOUT
HOUSE RULES.



E F G H I J K

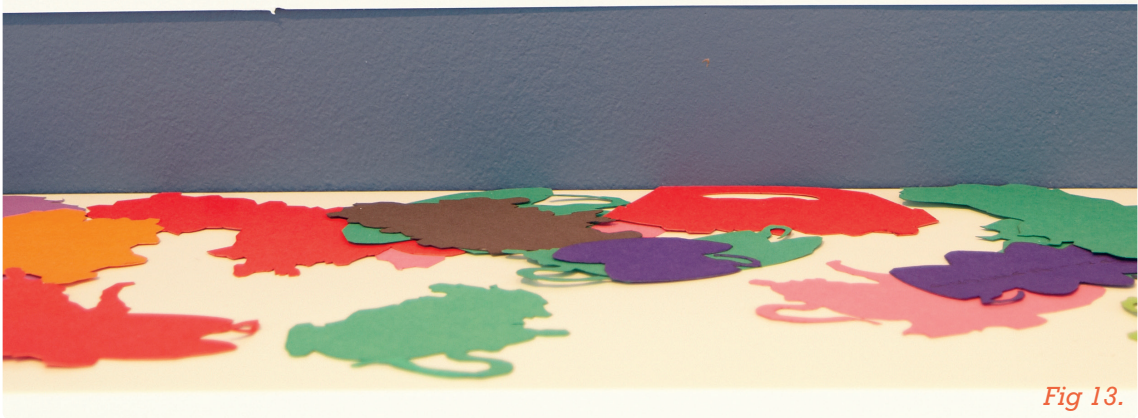

Fig 13.



WHERE ARE YOU NOW?
 UK

ARE YOU STILL TRAVELLING?
 Yes, Daily Commute

WHERE TO?
 Belper → Sheffield

HOW LONG IS/WAS YOUR TRIP?
 3 months ago.

WHERE IS IT WHERE YOU ARE NOW?
 Irene came to UK at Easter

8:00
 19:00
 SWEDEN

FRIDAY 30th May
 date:

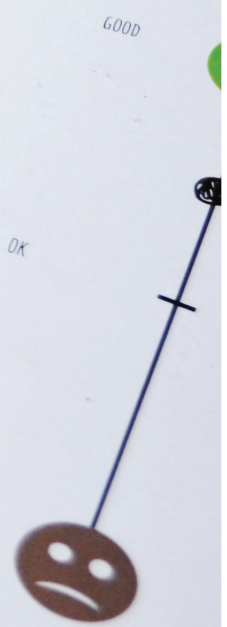

Fig 14.

With some variations, the set of probes consisted of:

AWAY:

**A BOOKLET CALLED
YOUR LIFE AS A MOBILE WORKER
FOR THE MOBILE WORKER TO
COMPLETE WHILST AWAY.**

**A LIST OF PHOTOS FOR THE
MOBILE WORKER TO TAKE
DURING WORK TRIPS.**

**A SET OF MAPS WITH STICKERS
FOR THE MOBILE WORKER TO
INDICATE TRIPS AND NETWORKS.**

HOME GEOGRAPHIES

This activity encouraged those at home to create a geography of home life. Island and lake card shapes were given to participants, along with a gridded blue poster, asking them to create a map, naming their islands, lakes, bays and oceans based on feelings or activities at home, and creating an emotional geography of what goes on at the domestic space. Each household member was asked to place him/herself on the map, with a plastic toy piece representing them, and write down their coordinates to record their trajectory. A family member may report being in the *'island of boredom'* in the morning, but in the *'tea by the sofa while the potatoes boil'* in the afternoon. This activity provided us with information about their state of mind trajectories, but also gave us a feeling of their specific attitude to ambiguous open tasks, their creative input, emotional vocabulary, significant activities and domestic goings-on. More importantly, all families who did his activity told us they had fun doing the map, and it was able to incorporate children's perceptions as well.

*Figs 15-16. Montage of Home
Geographies map tool*

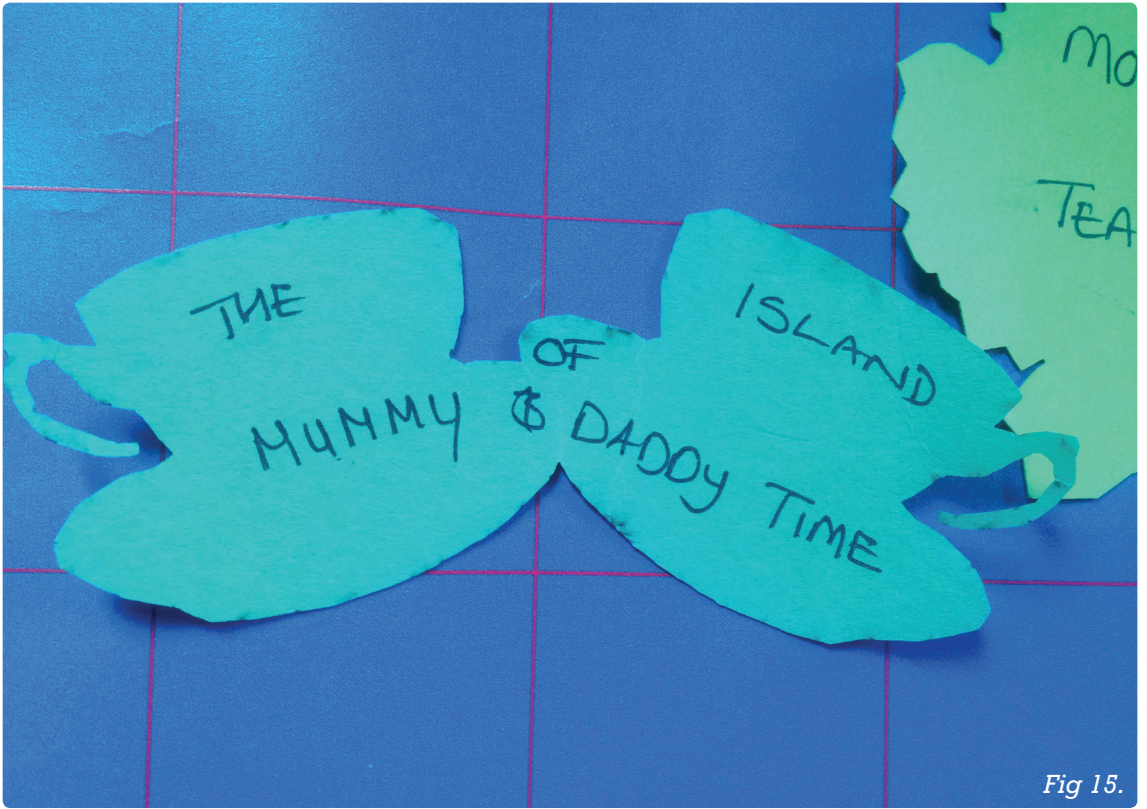

Fig 15.



Fig 16.

LIKE/DISLIKE CAMERA

Like/Dislike Camera encouraged participants to point out specific items in their home that they liked or disliked using the cultural idiom of *Facebook's 'Like/Dislike'* options. This activity gave us a view into the preferences they had with the material world that surrounded them (and the toleration for each others 'stuff'). This probe also provided design and aesthetic clues for the researchers for creating the bespoke design for each family. Sometimes the same items received both like and dislike, as different family members had varied feelings towards objects at home. The photos generated from this activity provided the basis for more in-depth investigations that were conducted during the second interview with families.

Figs 17-21. Montage of Like/Dislike camera



Fig 17.



Fig 18.



Fig 19.



Fig 20.

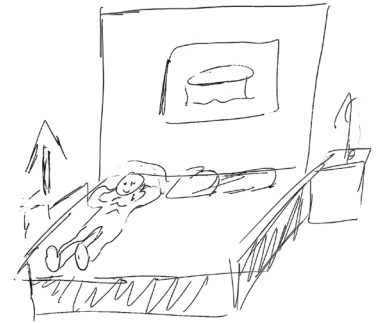

Fig 21.

A GLIMPSE OF THEIR
DOMESTIC AND FAMILY LIFE,
AND MORE IMPORTANTLY
INSIGHTS INTO THE SIGNIFICANT,
DAILY QUOTIDIAN RITUALS
THAT FORMED IT

DIARY OF A MOBILE WORKER

We gave the mobile worker map cards to record their trip locations, and a booklet called *Your Life (as a mobile worker)* asking a range of questions about their work trip including; what aspects of home they missed when being away, ways in which they may 'treat' themselves during the trip, their travel essentials, how often they connected to home, what preparing to arrive back home felt like? We also created a list of photographs we asked each mobile worker to take during their work trip. These images offered us a glimpse of the temporary environment they created whilst being away from home and the characteristics of their travel, and what quotidian rituals might be replicated for the mobile worker when they were away from home.



date: 2/4 Miltenkayos.

Figs 22-23. Photo and sketch of mobile workers room

Fig 22.



Fig 23.



Fig 24.



Fig 25.

DIGITAL QUESTION BOX

We wanted to ask questions to those at home, while the mobile worker was away, and we wanted to be able to ask different questions at different times, change them, improve, send open or more esoteric questions, in the hope that new information may be revealed.

We created a device, based on an inexpensive *Android* mobile phone and with a custom app, which would display questions at different times of the day, either from a scheduled list or as received by text message from us in and displayed for a finite time. We developed a series of cardboard housings that evolved over the period of the project from birdhouse shapes, inspired in part by the *Luckybite BirdBox* (Durrell Bishop and Tom Hulbert, 2009), to devices that contained mechanical elements, intended to create a sense of occasion. In all, we asked participants to write the answers on paper supplied, which was then 'posted' into a slot on the box. Some questions requested more detailed responses or photographs, in which could be sent by e-mail. The answers tended to be given spontaneously and quite casually, in contrast to some of the other probes that were more deliberate.

Figs 24-27. Montage of Digital Question Box and responses

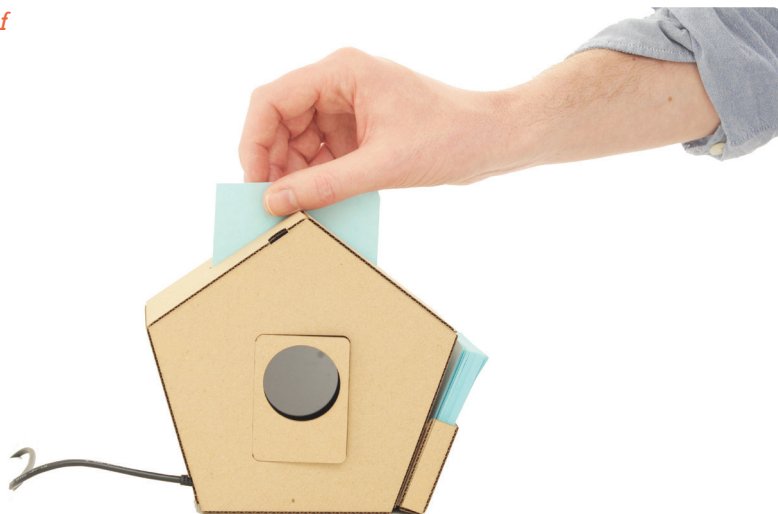

Fig 26.



We didn't
do anything
superstitious and
only just realised
it is Friday 13th!

Watching oblivion
Drinking Tea
and smoking a
Cag

~~13th~~

IF I'M AT WORK
DRINK A COFFEE
AND GET 20 MINS
SLEEP
IF AT HOME CUP OF
COFFEE AND A FAG!

She is going
to Banbury and
Redditch

We have put the
house in the kitchen,
on the worktop.

Cornwall News
19.6.14
'Storms boost airport
business'
- Winter storms cut
off rail link + more
people used Newquay
airport

Plans for
THIS SUNDAY
ARE SIT + RELAX
AFTER GETTING
BACK FROM WORK
@ 12:10
HELP NEXT DOOR WITH
CAR AS BROKEN 12/10/14
DOWN

I'm Home
THIS EVENING
SO AFTER WE
WE ALL SAT
WATCHING A
FILM BEFORE
BED.

Fig 27.

EMBEDDED
INTO OUR CULTURE
IS THAT WE
ENCOURAGE
WORK/LIFE BALANCE

STAGE TWO

RITUAL MACHINES

**David Chatting, Paulina Yurman,
Dr David Kirk**

The fragmentary information collected from the ethnographic phase provided us with a vast range of data from each of our families. Unlike the traditional ethnographic data of an interview transcript and photographs from the ethnographer's perspective, most of our data had been created directly by the users in our absence. We received a total of 115 photos from the *Like/Dislike camera*, 42 responses from the *Question Boxes*, and 46 comments from the *Home Geographies* activity. This 'data' as such, provided design inspiration for the team in which key insights relating to each family were identified to inspire the resulting bespoke designs. These insights included activities the families shared together, their engagement with digital technology and where strongly indicated through the design inspiration material, their aesthetic preferences.

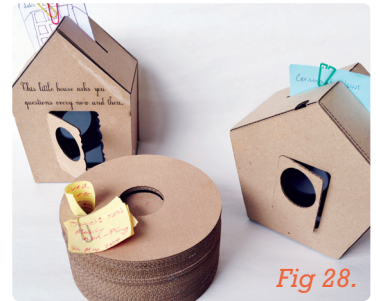

Fig 28.

Figs 28-29. Putting together the collected data from a family for analysis and interpretation



Fig 29.

Using the full diversity of material generated for each family, we began to make early design responses that we believed might create or extend rituals with around their periods of separation. We were not looking for a solution to 'the problem of separation', rather something that would provoke conversations about the quotidian rituals experiences of home and separation from it. As such we intended the resulting *Ritual Machines* to be playful and provocative.

We used sketching of all forms to develop our ideas and allow them to be productively critiqued towards working artifacts that we could expect would live with the family, in and out of the home, for up to eight weeks without our intervention.

DESIGN BRIEFS; THE RITUAL MACHINES

Playful and provocative, the *Ritual Machines* are the result of our Design-Led Ethnographic case studies with our five participating families. Each machine was specifically designed to live with a particular family for up to eight weeks, identifying their specific domestic rituals and their attitudes towards home, work, separation and reunion. Rather than presenting a solution to 'the problem of separation', the machines aimed to create a conversation about the quotidian rituals we experience at home and within family life, and what it might mean for work/life balance to be separated from it.

HOME
WORK
SEPARATION
REUNION

RITUAL MACHINE 1

Drinking Together Whilst Apart

This *Ritual Machine* comprises a beer bottle opener that is connected to the Internet. On opening a bottle of beer at a separate location, the *Ritual Machine* pours a glass of wine at home.

Our first family, Craig, Holly and their young son Sam, live in Edinburgh and are regularly separated by Craig's work travel to the South of England. Craig and Holly have an active social life and their home was decorated with photos of themselves and friends at parties and events, both before and after Sam's arrival in their lives. The ethnographic probes revealed shared pleasures together and frustrations when separated.

A simple shared pleasure was the couple's enjoyment of having a drink together, at the end of the day. When Sam is finally asleep and they have done 'all the serious stuff', when they can relax and share each other's company. The *Ritual Machine* we built for Craig and Holly is a machine for drinking together whilst being apart, allowing this ritual to be recreated when separated by Craig's travel for work.

There are two elements to this *Ritual Machine*, these are a wine machine that remains in the home and an electronic bottle-opener that can be transported away from home. When the beer bottle opener is used somewhere in the world, the machine will dispense a glass of wine at home. The wine machine, was designed for the home and specifically as a white kitchen appliance, it connects by WiFi to the Internet. The bottle-opener was implicitly designed for Craig to take with him while away, it connects via Bluetooth to an iPhone app installed on his iPhone, and makes a connection to the wine machine. Whenever a glass is placed in the machine an alert is sent to the *iPhone*. The machine will not operate without a glass being present.

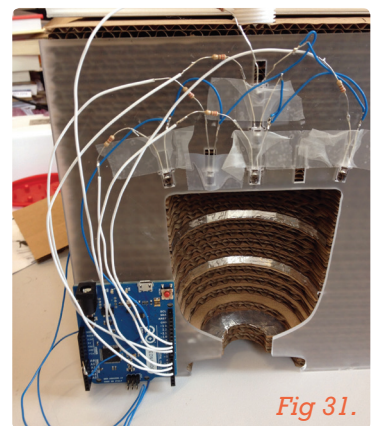
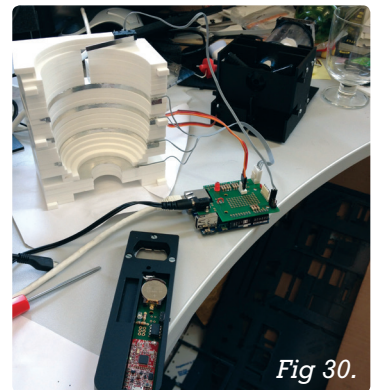

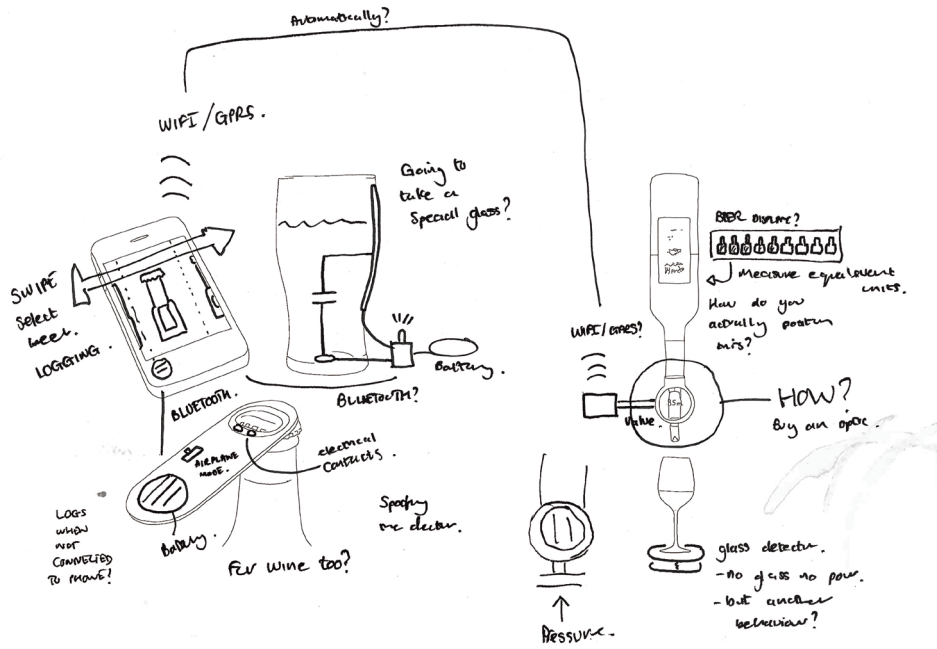

Fig 32.

In developing this machine we had to address the challenges of dealing safely with fluids and electronics, additionally to find a way to pour alcohol through a valve that would be 'food safe'. We had to ensure that the machine could be cleaned and maintained by Craig and Holly independently.

In addition to the design of the enclosures, the machine and bottle-opener contain custom electronics and a mechanism to pour the wine. Software was developed for the bottle-opener, the iPhone application, the server and wine machine.

This *Ritual Machine* poses questions about activities people enjoy together and whether these rituals can be maintained when separated. Can the *Ritual Machine* maintain the spontaneous nature of this family custom? Or does the spatial distance mean we are really drinking alone?

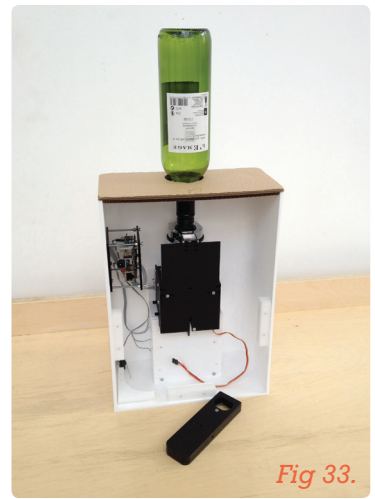

Fig 33.

Figs 30-37. Montage of machines development including final machine



Fig 34.



Fig 35.

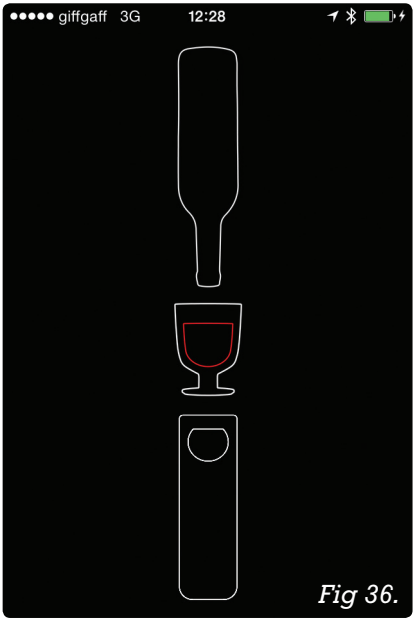

Fig 36.



Fig 37.

RITUAL MACHINE 2

Anticipation of Time Together

This machine counts down to a shared, significant event. The anticipation of this event is experienced while being together or when separated.

Hywel and Jesper live together in East London, but are regularly separated due to Jesper's work. However, when Jesper returns home they often take a holiday together. This is a ritual they've been engaged in for a number of years.

Looking forward to these trips of reuniting, the anticipation of being together again and going on holiday, became the focus for the design of this *Ritual Machine*.

For Hywel and Jesper we found much inspiration in their attitude to time keeping and routine, Jesper's love of travel and Hywel's design sensibility. We responded to their anticipation of being together again and this became the focus for the design of their *Ritual Machine*. This machine counts down to a shared significant event, that they first set together, then experience the passing of time and finally celebrate the arrival of the event. It resembles and evokes an electronic sand timer.

Our ethnographic interviews and probes revealed that Hywel and Jesper had a specific design aesthetic, and therefore the design of this *Ritual Machine* would need to meet the families design preferences. The machine is a flip-dot display, a mechanical display that consciously references the departure boards of airports and railway stations. The flipping of dots produces a sound that contrasts moments of change, like a ticking clock or the drama of a full display update.

“We save up like mad and go on holidays... it's a big thing to do” (Hywel)

We built an *iPhone* app for both Hywel and Jesper allowing them to interact with the display, which otherwise has no direct interactivity. From anywhere in the world, the app shows what is currently displayed at home, allowing them to check the progress of an event. Any touches on the *iPhone* screen are displayed in real-time on the home display, that may be co-opted for phatic communication.

We wanted to create specific moments for them both while in front of the display and were inspired by Cold War film language of double locks and secure systems that require two people to initiate a sequence. The display is a Bluetooth *iBeacon* and this allows the *iPhone*s to judge their distance, allowing the system to ensure that all parties are together and close-by. When an event has not yet been set the display reacts to the presence of each *iPhone*. When both are present an interface is shown that spans the two screens and allows a future time and date to be set. When the time arrives an animation creates a moment of celebration.

This *Ritual Machine* alludes to the sense of excitement associated with travel. The anticipation for the mechanical cascading of the dots is analogue to the anticipation of the next trip or time together. The choice of material and colour was a deliberate attempt to design a machine that would be accepted into Hywel and Jesper's living room, a space that we had observed was carefully curated.

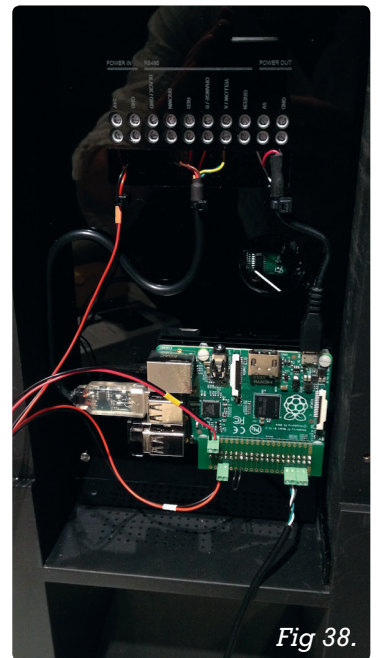

Figs 38-42. Montage of machines development including final machine



Fig 39.

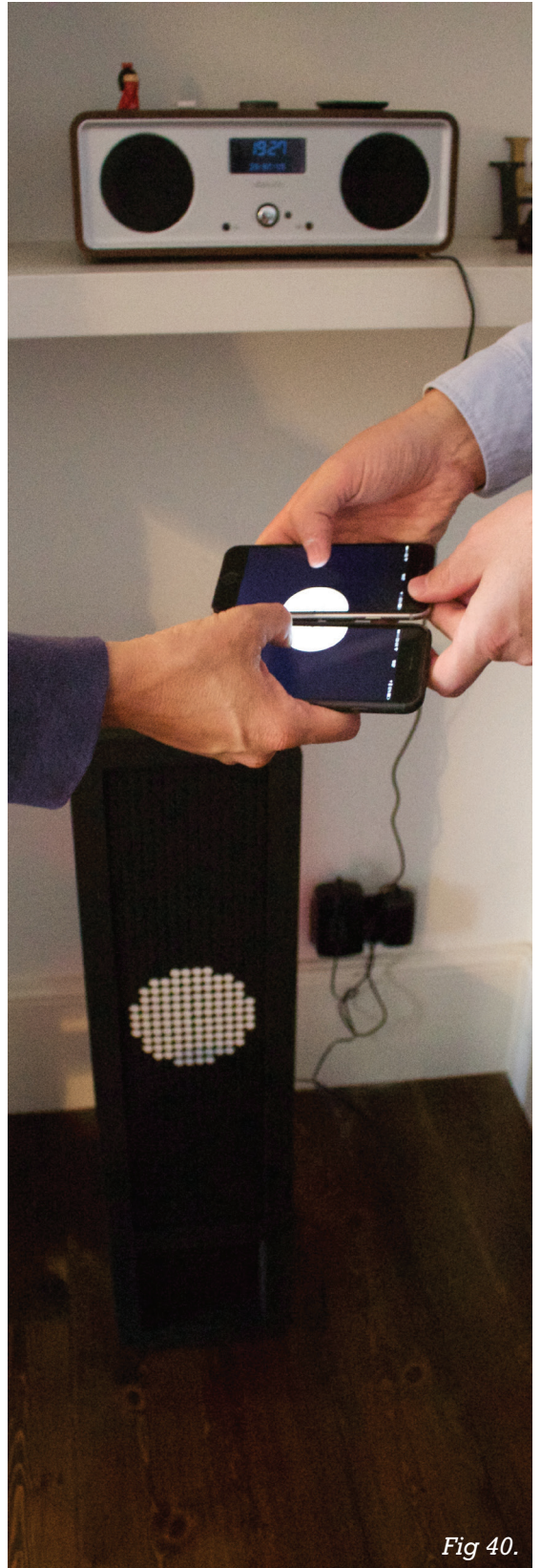

Fig 40.

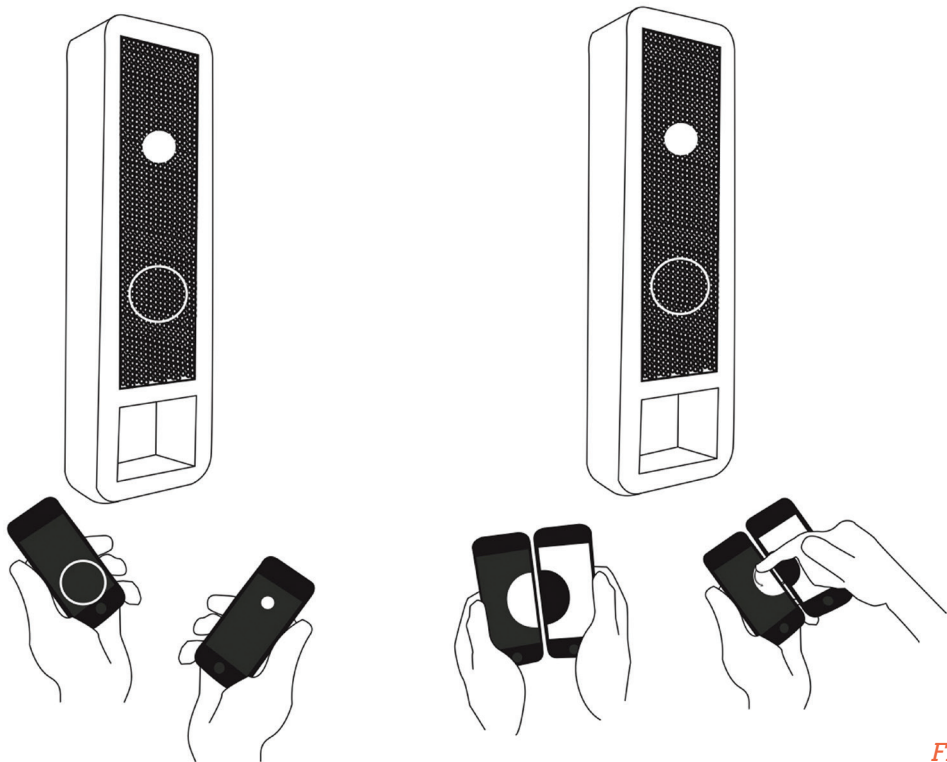

Fig 41.



Fig 42.

RITUAL MACHINE 3

Connecting Through Housework

A robot vacuum cleaner is set to begin vacuuming but only when the counterpart device, carried by the absent family member, moves.

David spends blocks of between two or three months of the year separated from his wife Irene and their teenage children Rikard and Rebecca. David feels he has two homes; one in the UK, where he works (his 'work-home') and one in Sweden, (his 'home-home').

For David in Sheffield and for Irene, Rikard and Rebecca in Sweden, we saw how the family made heavy use of technologies, particularly video Skype, to stay in regular daily contact. However Rikard and Rebecca told us how they have less of a sense of his patterns of activity when their father is away.

We became interested in how the patterns of daily life continue in these two spaces and how this changes when they are together.

Mischievously, we wondered how we might allow David to contribute to the daily chores in Sweden whilst away. We began to develop sketches based on an adapted Roomba, the commercially available robot vacuum cleaner. We decided we wanted to make apparent David's daily travel routines through the behaviour of the vacuum, arguably a kind of digital possession.

The third of our *Ritual Machine's* transforms David's movements when in the UK into the movements of the robot vacuum cleaner in Sweden. When David walks at a leisurely pace, the robot moves silently around the house. When David quickens his pace by beginning his daily commute on the train, the robot begins to clean the house. When he returns to his 'work-home' the vacuum seeks out its recharging station.

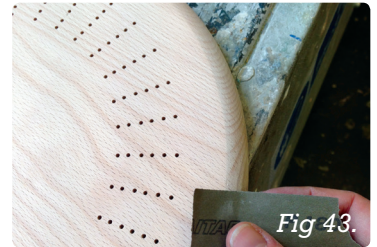

“When he comes home, I don’t have to do the gardening. I don’t otherwise have to do shopping.”
(Rikard)

“It’s just like a burden is lifted from our shoulders. We have less responsibility for the house, which is quite nice to have.”
(Rebecca)

In this way it reveals the pattern of David's activities and potentially contributes to the housework. Through the activities of the robot based on David's movements; Irene, Rikard and Rebecca can begin to read some of his routines while he is away.

Technically, this *Ritual Machine* works by an adapted *Android* phone that runs custom software measuring David's speed by GPS and communicating this across the Internet to the Roomba. The machine has been adapted with a bespoke case and custom electronics that connects it to WiFi and determines the Roomba's behaviour.

The vacuum also subtly reveals David's location through colour displayed on the lid of the vacuum and matched by the display on his own device. With work-home displaying white, his distance and bearing from there is used to calculate a colour which, whilst consistent for specific places does not disclose the actual destination.

David can cause the vacuum to rotate on the spot by shaking his device. Irene, Rikard and Rebecca can 'pause' the vacuum by knocking on the lid. This action causes David's device to vibrate and make a knocking sound and halts the vacuum until it is 'knocked' for a second time.

For this machine we produced a detailed instruction manual as it was very important to communicate to the family how the vacuum should avoid water and delicate obstacles and generally be used. However, we were deliberately ambiguous with describing how David and the vacuum's behaviour was linked, as we wanted them to explore this for themselves.

"I would say when he's coming home, they are in a way in a holiday. It's really noticeable going from two grown ups to one. It's really noticeable the amount of work that's really split between the two of us. Even though if you're two of you, you can think about sometimes, well, I do most and he's not going to do nothing. Then you realise when he's not around, a lot of things that he usually does do, and you don't think about it. It's really noticeable, that is, to be one instead of two." (Irene)

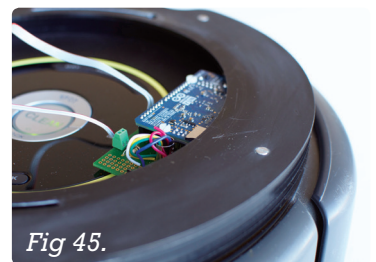
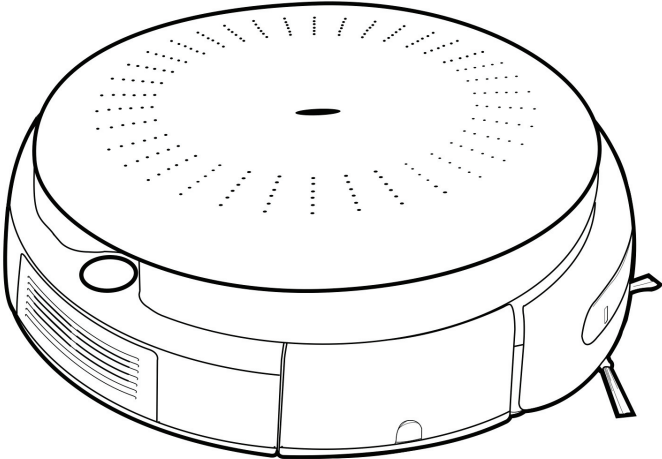

Fig 45.

Figs 43-48. Montage of machines development including final machine and instruction manual

Ritual Machine 3 User Manual



Family Rituals 2.0

Fig 46.

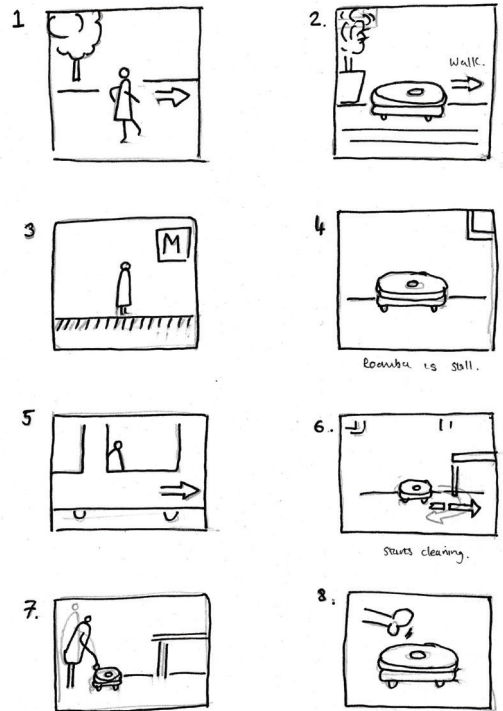

Fig 47.



Fig 48.

RITUAL MACHINE 4

A Message in a Jar

A jam jar can be spoken into and replays messages to absent family member through a specially designed speaker.

This machine was created for Lisa and her husband Will and their children Alex, Oliver, Steve, Kevin, Billy and Rachel*, who live in Kent. When driving her truck, Lisa often finds cards and messages that one of the children has hidden in her bag. These are welcome little mementoes from home that she cherishes, as she is regularly on the road up to five days a week. Although Lisa admits that she often misses home, she also really enjoys her work and travelling around the UK.

For Lisa, and her family, we were immediately drawn to the lorry cab as a site for the interaction. This space operates both as work and home for Lisa for five nights a week, through the probe responses and interviews we got a sense of her complex relationship to this: the freedom of the road, the pressures of a making delivery times despite traffic, living with very basic amenities, in a male-dominated profession and the separation from her family with whom she stayed intimately involved whilst away.

We were very interested in the ways in which Lisa brought homely touches to the cab of her truck. There are relatively few ways in which she can adapt the space and we learnt about a pink rug and her pride in the presentation of curtains that draw across the windscreen at the end of each day. She cannot materially change the cab space.

The choice of pink was a recurring theme and one Lisa clearly enjoyed: from the rug, to her carefully painted nails, to the bodywork of the car that she and Will had built together. Lisa explicitly saw this as a way of expressing her femininity.

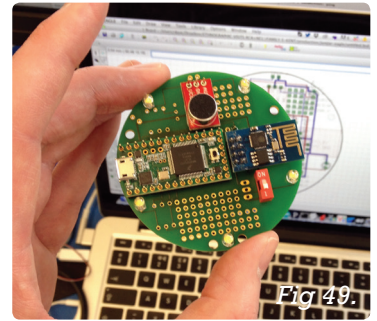

“Yeah. I love the job that I do but at home, once I’m home, I love being at home. When I go back to work, I miss home badly to the fact that I will cry as I’m driving up the way. If you look up and see a truck driver bawling their eyes out that’s normally me. The further north I go and the more miles I get between home, like here and wherever I’m going, the easier it gets for me. Then I find that I’m fine once I’m out. Then of course as the week rolls on, I can’t actually wait to get back.”
(Lisa)

After exploring a variety of ideas, we focused on the traffic jam as a time in which we could suggest a new ritual. Hold-ups seriously impact a lorry driver's day and cause a good deal of stress in meeting tight deadlines. We wondered if we could make a counterpoint to this.

This Ritual Machine has two components a speaker that hangs inside the cab of Lisa's lorry and a jam jar embedded with electronics that stays at home. By removing the lid of the jam jar a voice message can be stored within that is sent to the speaker in the lorry, but only played at the moment of a traffic jam. We played on this pun.

The jar contains custom electronics on a printed circuit board that records audio messages, illuminates the jar to show when a message is stored and connects to WiFi to transfer the file to the server and then to the speaker which is with Lisa in the cab.

The speaker has been specifically designed to reflect Lisa's femininity and resembles a small pink handbag. The unit contains an Android phone that uses GPS to determine the lorries location and speed; using this information in conjunction with online traffic services, the speaker can determine if Lisa is in a traffic jam or not, and replays any messages stored in the jam jar at home.

** Names have been changed to protect the privacy of individuals.*

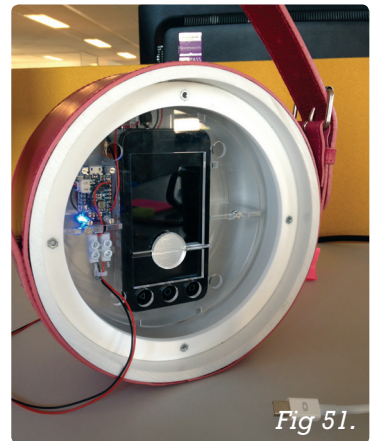

Figs 49-55. Montage of machines development including final machine

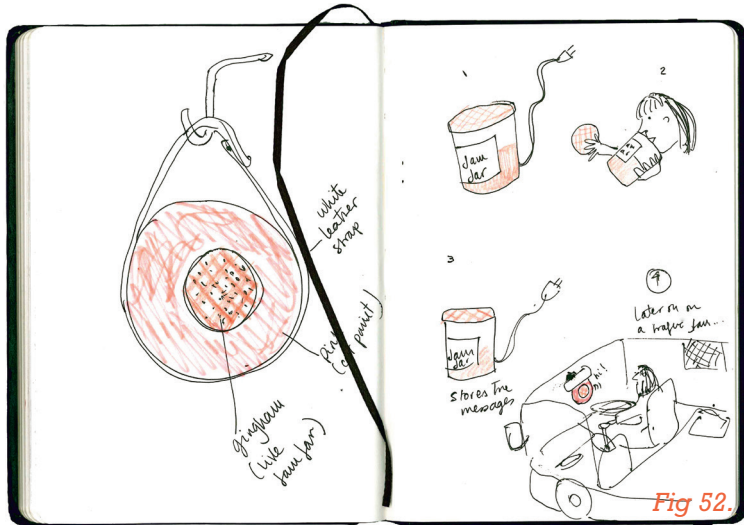

Fig 52.

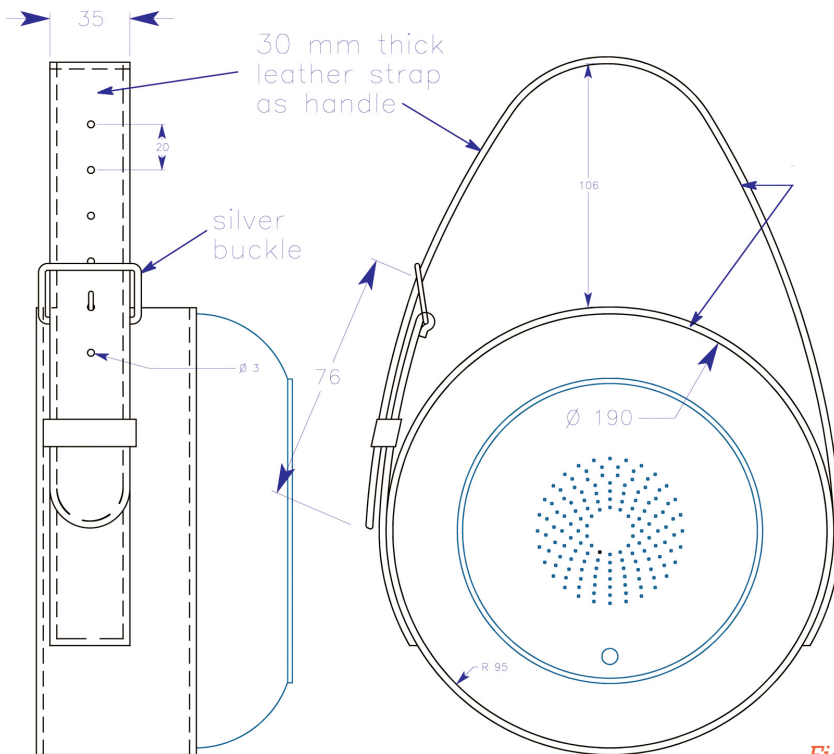

Fig 53.



Fig 54.



Fig 55.

RITUAL MACHINE 5

Where Are You?

Our fifth family is Emmie, Mark, Joseph and their dog Molly. They live in a small village in Cornwall in a house that is adjoined to Emmie's parents. Mark travels regularly for work and can be away from home for up to three nights a week. Emmie who is freelance also travels for work – but not as often as Mark. The couple moved to Cornwall from London after Joseph was born, seeking a healthier lifestyle for them all.

For Emmie, Mark and Joseph we immediately responded to their love of their geography and the outdoors. We became interested in the way in which Joseph communicated his mum and dad when they were away. Mark told us about a sense of frustration he felt when he was away when talking to Joseph on the telephone.

When Joseph was younger he gave his father a small stuffed toy, which Mark took with him on his travels and would photograph at various landmarks. These pictures were then sent back to Joseph so that he could see where daddy was and where he had been. We decided to extend this ritual.

During our time with the family and with Emmie beginning to travel more for work as well, we decided to focus on this dynamic of the parents being away but Joseph being able to see where they are.



“Sometimes Joseph’s okay on the phone, but sometimes he’s not very talkative. [If] he’s had a busy day at school, he doesn’t want to recount what he’s been doing, and I just sometimes get, ‘Hiya, dad.’ ‘You all right?’ ‘Yeah, I’m fine. I’m passing you back to mummy now,’ and he’s off playing Lego or something”
(Mark)

This Ritual Machine is an electronic telescope for Joseph that can be pointed in any direction and shows the world beyond, by zooming and moving the telescope the whole country can be explored. The world visible is an illustrated facsimile, with major towns, cities and landmarks, in a familiar landscape. When one of his parents goes away they take a second device, which when activated will leave a marker at the correct place in the illustrated world, which Joseph can then search out. With a paper map Joseph can then mark that location. We hoped this would begin a conversation about where Mark or Emmie has been or might go, either on the telephone whilst away or together with the map when they return.

The telescope contains an iPhone running an app of the illustrated world, it is equipped with WiFi and uses the electronic compass and gyroscope to determine the position. The parent's device is based on an Android phone with custom software, using GPS and the mobile data network.



Fig 57.

*Fig 57. The illustrated world inside the telescope.
Illustration by Naomi Elliott.*

Figs 56-60. Montage of machines development including final machine and instruction manual

TELESCOPE.

TUESDAY 5 August 2014.

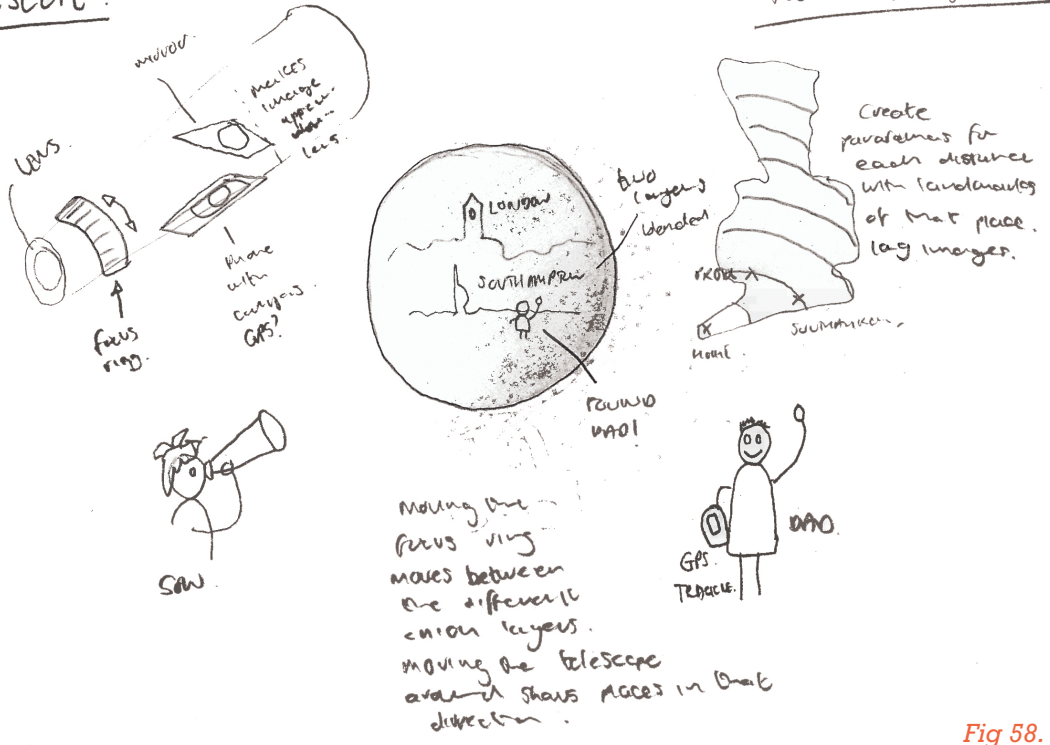

Fig 58.



Fig 59.



Fig 60.

RITUAL MACHINES; LIVING WITH THE FAMILY

The research team were very careful in how the *Ritual Machine* was presented to the family. Beyond the values we communicated by form, choice of materials and finish, each machine was presented in a bespoke box and included a personalised instruction manuals. The manuals detailed any important safety or maintenance details of rather than dictating how we intended it to be used. The result almost resembled a mass-produced, commercial product, rather than a bespoke design. An ambiguity we deliberately leveraged.

Prior to the day of delivery the families had very little idea what had been designed for them. This helped to create a sense of occasion, we were frequently told it's, 'like Christmas!'

On receiving the machines, most families asked:
"Did you design this for all your families or just for us?"

In a sense, the machines gave materiality to the family's responses to our interviews and interaction with the ethnographic tools. The machines embed something quite personal. This created an interesting space where participants were a bit unsure as to the degree in which the information they contributed had an impact on the design. We wanted to see how the machine came to live and exist in the homes of our families, and to what extent it was integrated or excluded from their daily life.

At time of press two of our *Ritual Machines*, 'A Message in a Jam' and the 'Where Are You?', were still living with families.

DID YOU DESIGN THIS
FOR ALL YOUR FAMILIES
OR JUST FOR US?

FAMILY 1

Drinking Together Whilst Apart

While Holly and Craig greeted the machine with a good deal of approval and excitement, there was soon a note of hesitation. They wondered if we had honed in on this specific ritual as a reflection of wider health narratives that focus on drinking.

We assured them this was not the case at all, and that we found their social nature and their enjoyment of this shared occasion to be the inspiration for a machine, which we hoped, would replicate this experience when they were separated.

Following the unpacking there was an immediate problem: in the period between initial interviews and design work, Holly and Craig had moved, and we found the machine with the bottle intact would not fit anywhere in the kitchen. We also had to consider placing it somewhere where it would be out of Sam's reach. Hence we found the *Ritual Machine* had no home.

After a while and still untested, the *Ritual Machine* began to blend into the family home and on opportunities to use it whilst Craig was away they found *'you just forgot it [the bottle opener] numerous times'* (Craig)

After a period of weeks we became aware that the machine had not been used and as the date of the retrieval of the *Ritual Machine* drew closer, we asked Craig and Holly to make a special effort to use it.

"There was actually the final D-Day. Gary was round, just for dinner, and we were like, right, let's do it! And we did. It was funny that I actually had somebody with me here when we finally did use it. I think that it really showed, actually, that I don't really drink that much on my own, even if Craig was actually on the other side on Facetime.... If I am going to have a drink, I would rather have a drink when he is here rather than on my own" (Holly)

"We are not alcoholics but we do like to have a drink, and we do, like most of the country, I think." (Holly)

"Oh, we really should cut back. It's only to do with our own insecurities." (Holly)

"We did try to give it some attention and maybe... Why we didn't is an interesting point. I guess ... Being judged isn't the right word..." (Craig)

On the day of collection we discovered the machine stored on a shelf unplugged, next to an unused bread maker. There had been no site for this ritual to establish itself. There could be no casual interactions with the machine; on each occasion it would have to temporarily set-up and then packed away.

In addition at the final interview it became clear to us the complexity of the moment we had designed, where all the conditions were correct. That machine was on, a bottle of wine had been opened, that Sam was quietly asleep, that Craig had remembered to take the bottle-opener, that he had a beer and was ready to drink it in a place that he would feel comfortable.

While the machine was largely unused, its presence in the house did arouse curiosity from friends: *“Most people are actually interested in it, “Wow! You are taking part in a bit of research.” And “How often have they been to see you?” And “What is it expecting to achieve?” (Holly)*

Such was the curiosity that the machine became *“quite special”* to Holly and Craig.

However, Holly did have one critique about the machine. This focused on the ritual machine pouring her a drink only when Craig opens a beer:

“Yeah, it was really annoying as well, because ... In some ways, actually, in some ways you can think I can pour my own glass of wine. I don’t need a man to pour my glass of wine. If you are going back to gender stereotypes it’s actually the woman who’s the hostess. It’s the woman who is pouring all the drinks.” (Holly)



“It was amazing, and that’s reflected in our bragging about it, and when people were asking us questions, we were only too happy to go into lots and lots of detail, including practical demonstrations.” (Craig)

Figs 61-64. Montage of machines in family homes



Fig 62.



Fig 63.



Fig 64.

FAMILY 2

Anticipation of Time Together

A key consideration for the design of *Ritual Machine 2* was its aesthetic qualities so that it would fit the styling of Hywel and Jesper's home. The machine had been designed for a number of possible locations in the house with Hywel and Jesper having the final decision on where it should be.

Hywel and Jesper also meet their machine with a good deal of excitement; *"It looks very expensive. I didn't think it would be so big. I thought I was going to get a box with a screen on it!"* (Hywel)

They rapidly made the connection with travel and departure boards, and they also referenced the *Troika Cloud* installation at Heathrow Terminal 5, which had been an inspiration. The default animation changes every second and this causes a ticking sound, our intention was to create a strong association with time, which was also quickly understood.

We designed the machine to be sympathetic to the aesthetics of their living room, but we could not dictate where it would live. We knew that Hywel carefully curated that space and he would ultimately make that decision. When the machine was delivered with very little discussion it was quickly placed in its home, an alcove of the living room and there it stayed.

The machine soon became a fixture within the home: *"When we knew we'd have it for a while, instead of calling it a machine, we gave it a name, it makes it easier. [...] We generally give names to things. Our car is called Bob. Our car before was called Eva. Not for everything... we didn't give the TV a name. [...] We call the ritual machine Richard."* (Hywel)

"It sounds like a grandfather clock in the background."
(Jesper)

Since we first met Hywel and Jesper their lives have changed. Jesper is spending much less time away having changed jobs. They have also bought a second home in the country, visiting that at and letting out their London home.

When the machine was initially installed Hywel and Jesper had some concerns about the fragility of the piece and if visitors might damage it, as the whole house it frequently let out for short periods to visitors. Our intervention allowed us to discuss how the home adjusts to the presence of strangers.

Hywel and Jesper set the countdown four times during the period they had the machine for a variety of events.

“it was exciting to see what was going to happen [...] I don’t know I thought maybe it was going to play music, but I’m glad it didn’t!” (Hywel)

While they did use the iPhone app away from home and display their touches on the machine, it was clear that had not been a frequent interaction. However the machine had embedded itself into their home *“but you know when we think of the machine we think of this room.” (Hywel)*

However, the machine was the subject of conversations when they were apart. Hywel told us, *“yes, we’d text ‘how is Richard?’ - ‘Richard is ticking!’”* Asked if they felt that the machine had become a ritual for them Hywel said, *“I don’t think we had it long enough, ’cos for a ritual to happen it has to happen long enough, to be permanent.”*

Would there be something here about their changing schedule?



“Because we rent this house so much, we have not unpacked our toiletries, our bathroom is like a hotel bathroom, it’s almost like we are not staying... it does not bother me.” (Hywel)

“But this is definitely home.” (Jesper)

Figs 65-68. Montage of machines in family homes



Fig 66.



Fig 67.

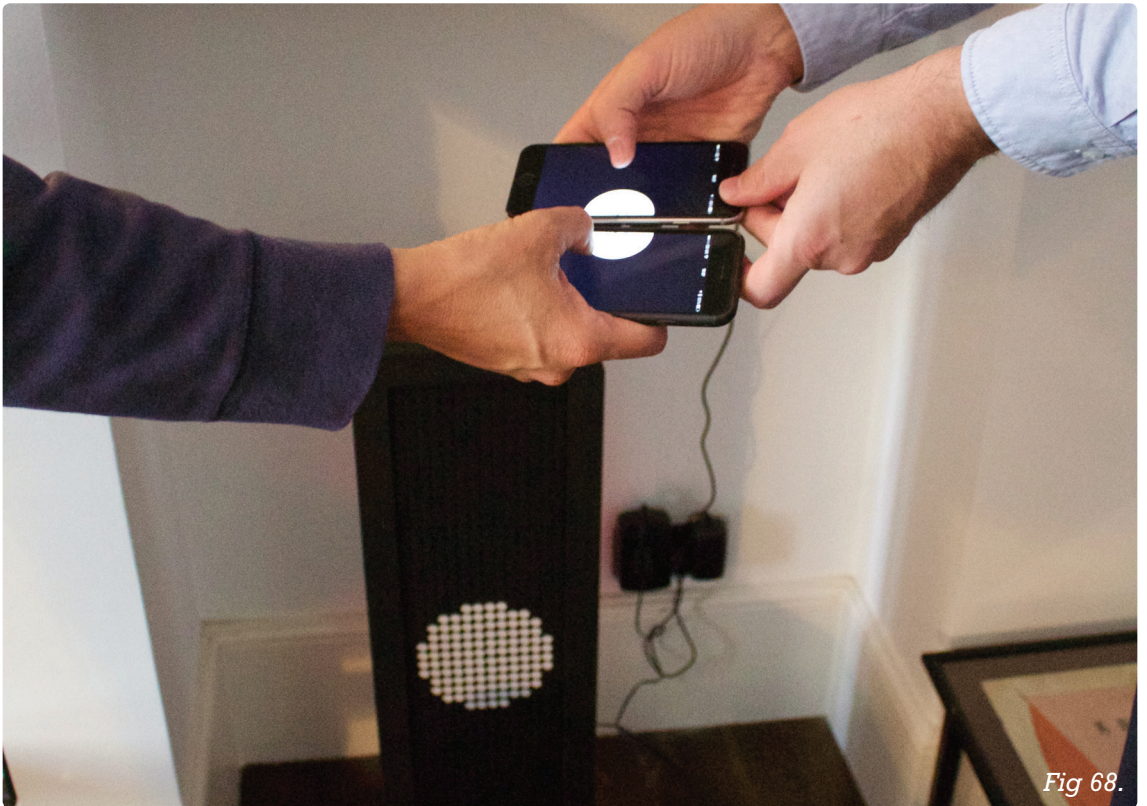

Fig 68.

FAMILY 3

Connecting Through Housework

The delivery of the machines for David, Irene, Rikard and Rebecca posed an immediate logistical challenge as they were separated between Sheffield and Sweden. We prepared two custom built boxes and instruction manuals that were sent by courier and arranged a time for a three-way video *Skype* as they were unpacked. Of the parcel in Sweden they told us by e-mail, ***“MUCH bigger than we were expecting.”*** and David wrote, ***“Very small box compared to the one that arrived in Sweden... :- (“*** The initial installation went well.

We deliberately framed the interaction between David's device and the vacuum in Sweden as a puzzle that the family should explore, which they engaged with enthusiastically. However, over a period of days David and Irene struggled to find an explanation for the robot's behaviour, despite concerted and systematic attempts. We then disclosed that David's movements and the robots were linked, but still the association was not tight enough for this to be readable.

The deployment of David's device exhibited technical problems, but ones we feel highlight the complexity of interacting with changing infrastructures whilst on the move. Specifically our strategy for irregular GPS polling to preserve battery life proved unreliable, when the device was frequently indoors or unable to obtain a fix on the train.

The presence of the robot at home in Sweden did cause some friction. Specifically the sound it made whilst vacuuming, ***“I couldn't stop the sound and it was very loud.”*** (Irene)

Irene reported that she did not want to be in the same room as the robot. However, rather than rejecting it, she asked, ***“I hope you can give some advice how I can check that the robot is 'ok'”.***



Fig 69.



Fig 70.

The robot could have been seen as an intruder and one that if misbehaved could have physically damaged their home. They told us anecdotes of the battles the robot had had with their cat Charlie.

Throughout the project the family remained engaged and willing to help us resolve the technical issues. Unfortunately they never had the experience of the machine quite as we had designed. However, as David told us, *“It is certainly giving us something to talk about!”*

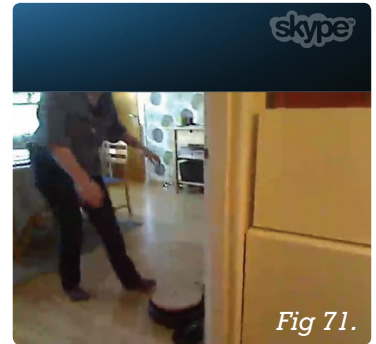

Fig 71.

Figs 69-71. Montage of machines in family homes

FAMILY 4 & FAMILY 5

A Message in a Jar Where Are you?

At time of putting together this publication the *Ritual Machines* for Family 4: A Message in a Jar and Family 5: Where Are You?, were still living with their families. Please see our website *Family Rituals 2.0* <http://familyrituals2-0.org.uk/> to see how the families and *Ritual Machines* interacted.

ETHNOGRAPHY THROUGH DESIGN; REFLECTIONS FROM THE DESIGNERS

David Chatting

Beyond the design of machines that engage and are cause for reflection, the key challenge of the *Family Rituals* project has been to design and build systems that work. Work not only technically, but also within a family's specific home environments and the spaces and infrastructures they move through when traveling. There is an inherent complexity and risk in negotiating these practical, social and technological constraints that we could only partially anticipate. The machines were designed as an intervention and as such do necessarily cause a degree of friction in everyday life, however crucially this must be within boundaries if the machine is to remain a welcome guest over a period of weeks.

We recognised that to be successfully and quickly integrated into the home our machines would need to find an obvious place, especially those which were designed to be at a fixed location (the Wine and Anticipation machines). Having visited the homes we had an intention of where they might be situated, which we communicate through form and language, but ultimately this was not our choice to make.

The *Wine Machine* was too tall to fit under Holly and Craig's kitchen units. In a home with a newly walking inquisitive son and a machine full of liquid, there were very few places where it could be accommodated. To this degree it didn't work. The machine immediately had no place.

In contrast the *Anticipation Machine* was always intended to be in Hywel and Jesper's living room, a space we knew was carefully curated. Our choice of colour, form and behaviour (especially acoustically) meant that it was welcomed into that space and even named. We had previously considered a wall-hung device, but we felt that would present an immediate barrier to installation: making holes and securing a bracket.

We have primarily been designing moments, moments that we hope have a significance or poignance. With many of our machines these have been fleeting and infrequent, and so a great deal of meaning is attached to these moments for the families and for us. They are the product of our considerable design and technological labours over many months. For us this represents a good deal of risk. While we wanted to communicate a seriousness in our study, we did not want to over stress this, fearing it would create some anxiety or false compliance.

We have described these machines as prototypes. The word prototype is often used in a derogatory way to suggest a level of unfinished and a flaky or absent technical effect. Aesthetically the archetypical prototype is fragile, demanding an imaginative mind to see potential. Such prototypes have no utility in longitudinal studies that robustly engage with everyday life. A bespoke prototype has the opportunity to have a higher level of finish and specificity than any mass manufactured product.

As such, each of our bespoke prototypes has been designed to ape the language of the mass manufactured product world. This gives them a solidity of form and we intend to communicate that they will be well behaved and trustworthy. If ill behaved, some, like the roomba, have the potential to do damage. To complement this we carefully designed the digital behaviours, electronic design and the supporting materials: the packaging, manuals and our own language when talking to the family.

Our prototypes not only communicate in the home, but also in public with the mobile worker. There are public sensitivities to the use of electronics in public, especially those, which appear, homemade. Consider the electronic *Bottle Opener* that Craig was likely to be taking onto aeroplanes. Here we designed a printed circuit board and carefully constructed case. The top is easily removed and the design quality remains high on the inside.

While the prototypes might be read as products, we have striven to maintain a level of ambiguity about their utility. We want them to be interpreted and hopefully integrated in some personal ritual behaviour. There is a necessary complexity to this and we have inevitably been more and less successful in each case.

Paulina Yurman

For the last two and a half years David Chatting and I have been immersed in a project that has placed us as both researchers and subjects of our area of investigation. Travelling to see families for ethnographic visits has meant having to face some of the challenges created by regular separation and reunion from home life that our participants encounter on a daily basis. As recurrent themes began to emerge in the research, we were able to identify design spaces where proposals could be developed as metaphors to embody our participants' issues, but also our own as mobile workers. From a personal perspective, the research has allowed me not only to see what 'my own home looks like at a distance' but also, by working with practitioners from other disciplines I have been able to gain a glimpse into what 'my own design practice looks like at a distance'.

Working in close collaboration with anthropologists and *HCI* experts has demanded the design and development of proposals that had to implicitly give materiality to arguments that were becoming relevant in our research. Analysing the information retrieved from the design-led ethnographic visits demanded that the design and aesthetic language of the *Ritual Machines*, the shape and form they took, had to fit in within the domestic context of each family, and represent the values of specific quotidian rituals inherent to their lives. The various ways in which the families interacted with the machines had to embody the principles that as a team we thought relevant. From a more practical point of view, the machines also had to be robust enough to survive daily interaction in people's homes. Much of the work demanded developing methodologies as situations aroused, action plans that were frequently exploratory and relying on intuition, sometimes 'borrowing' methods from anthropological and social science practices, often providing surprising and novel results.

During the deployment visits to our participating families, one of their recurrent reactions when seeing their *Ritual Machine* for the first time was that of perplexed surprise: ***“has this been designed just for us? Are the other families in the project getting the same machine?”*** The act of giving and receiving an artefact that has been crafted to fit into their living environments, of seeing themselves and their rituals reflected in the design has had the characteristics of

a mise-en-abîme: observing their responses towards our designs has mirrored the way in which we see ourselves as designers in the research, providing much material for design reflexivity. Each *Ritual Machine* has been designed to fit into a particular moment in the lives of our families. Reaching the final stages of the project we are finding that families are non-static organisms and that their habits and situations change with time, bringing new meanings to the rituals we originally designed for. Trying to capture the way in which each family interacted with their *Ritual Machine* has not been straightforward: people's lives are always more complex than what we could have anticipated through interviews and probes. The *Ritual Machines* have served to highlight the complexities of rituals in family life, sometimes through the reluctance or difficulties of participants to interact with them, bringing up to surface ritualistic aspects that might have previously been hidden, albeit latent.

The work produced an estimated 30 hours of interviews, 167 photographs taken by our participants, around five hundred photos taken by myself and my research partner documenting our work in progress, five returned sets of probes from our participating families, five ethnographic diaries detailing our field work, many hours of conversations and discussions amongst the team members, some 3000 emails, five sketchbooks, dozens of technical drawings, 3D renderings and various cardboard models. It generated several design proposals, of which only five were developed to a high level of resolution to become the *Ritual Machines*. Encompassing a broader space than the five *Ritual Machines* alone, all this material, the 'stuff of research through design' works as a collection, forming the experimental narrative of our work.

The research has also provided a platform from which to generate further themes to be explored: the possible ambivalences felt towards technologies that blur separation between domestic and work life, its implication in gender politics and how these can be tacitly represented through objects.

CONCLUSION

Dr David Kirk

Through this project we have sought to reflect up the concerns of contemporary society, picking through the details of modern working lives. We have sought to examine the complex ways in which families deal with practices of remote working and the ways in which emerging patterns of mobility are impacting upon the family. We have focused in part on the role of ritual, as an everyday practice, which brings people together through the enactment of at once mundane, but simultaneously meaningful, activities, as a means for structuring daily life. And we have sought to consider how digital technologies might leverage notions of shared ritual activity to find ways of bringing remote workers back in to the fold of family life whilst far from home.

Our project has been interdisciplinary from its inception and we have benefited from a close collaboration between diverse disciplines, which have enabled us to approach this research space from multiple perspectives. Our social science led enquiry has allowed us to talk to mobile workers, their families and employers to understand better the strategies that they employ to support their working and living practices. Our 'research through design' enquiry has, in parallel, allowed us to produce bespoke provocations for a set of focused family case studies, offering them materials to foster deeper reflections on their own practices, priorities and values. Together these investigations have highlighted some of the key concerns of working families and opened up a rich design space for potential digital interventions. Hopefully this will help to raise debate around the changing nature of family life, and the role of technology in ameliorating or exacerbating this. We also hope that this work will inspire further research and development for new digital technologies and services to support work-life balance, further stimulating our burgeoning digital economy.

THESE INVESTIGATIONS
HAVE HIGHLIGHTED
SOME OF THE KEY
CONCERNS OF WORKING
FAMILIES AND OPENED
UP A RICH DESIGN SPACE
FOR POTENTIAL DIGITAL
INTERVENTIONS

RESEARCH TEAM & ACKNOWLEDGEMENTS

Research Team

Principal Investigator

Dr David Kirk, Reader in Cultural Computing,
Open Lab, Newcastle University

Co Investigators

Dr Jo-Anne Bichard Senior Research Fellow,
The Helen Hamlyn Centre for Design, Royal College of Art

Dr Juliet Jain Senior Research Fellow,
Centre for Transport and Society,
University of the West of England, Bristol.

Professor Adele Ladkin, School of Tourism,
Bournemouth University

Social Researchers

Dr William Clayton, Research Fellow,
Centre for Transport and Society,
University of the West of England, Bristol.

Dr Marina Marouda, Research Fellow,
School of Tourism, Bournemouth University

Design Researchers

David Chatting, Research Associate,
Open Lab, Newcastle University

Paulina Yurman, Research Associate,
The Helen Hamlyn Centre for Design, Royal College of Art

Photo Credits

David Chatting, David Kirk, Paulina Yurman, Sara Hibbert

Acknowledgements

First and foremost we would like to thank all the families who contributed to the *Family Rituals 2.0* project, for giving up precious family time to speak with us, share aspects of their lives and finally living with the *Ritual Machines*. We would also like to thank the employers who took part in our research responding to our enquiries about supporting work-life balance

We are grateful for the support of the *Engineering and Physical Sciences Research Council* and especially Richard Bailey for shepherding the project.

Our colleagues at our respected research centres and departments especially Professor Glenn Lyons, Professor Jeremy Myerson and Professor Patrick Olivier.

PROJECT OUTPUTS

Conference Papers, Workshops, Presentations and Exhibitions

'Ritual Machines from the Family Rituals 2.0 Project'.

HOME | SICK Exhibition, Science Gallery, Dublin, May 1-July 19 2015

'Family Rituals 2.0: Apparatus for Domestic Rituals'.

(London Design Festival) Royal College of Art, London 19-24 September 2015

Bichard, J. and Yurman, P. (2015)

'The Ethnography of Absence: Mapping Emotions'.

Interactive workshop. Design Anthropological Futures. Research Network for Design Anthropology. Royal Danish Academy of Fine Arts, Copenhagen, Denmark

Chatting, D., Kirk, D.S., Yurman, P. and Bichard, J. (2015)

'Designing for Family Phatic Communication: A Design Critique Approach'.

In Proceedings of British HCI 2015, University of Lincoln

Chatting, D., Yurman, P., Bichard, J., & Kirk, D. (2015)

'Ritual Machines'.

HOME | SICK Exhibition, Science Gallery, Dublin

Clayton, W., and Jain, J. (2015)

'Imagined Journeys: Experiences of connecting home for those who travel away for work'.

47th Universities' Transport Study Group Conference. City University, London, UK

Clayton, W., and Jain, J. (2015)

'Glimpsing into home: mobile work, the digital, and imaginative travel'.

Paper in preparation

Kazakos, K., Kirk, D., Durrant, A., Chatting, D., Yurman, P., Bichard, J., Paik, J. (2015)

'Design led enquiry for mobile lives'.

In Proceedings of ACM Conference on Human Factors in Computing Systems (CHI Extended Abstracts), ACM Press

Yurman, P. Hypnos: (2015)

'Sleeping in between Home and Work'.

discussion panel at Sto Werkstatt, Clerkenwell, London, UK

Ladkin, A. (2015)

'Family Ritual 2.0: Work-life Balance in a Digitally Dependent World'.

Keynote GENTOUR International Forum, Re-engineering the Tourism Labour Market through Gender-aware Research, Interdisciplinary Approaches and Future Trends Aveiro, Portugal. July 2015

Yurman, P., Chatting, D., Bichard, J. Kirk, D. (2015)

'Ritual Machines'. Poster presentation at Design Anthropological Futures. Research

Network for Design Anthropology. Royal Danish Academy of Fine Arts, Copenhagen, Denmark

Bichard, J., Yurman, P., Chatting, D & Kirk, D. (2014)

'Quotidian Ritual and Work Life Balance; an ethnography of not being there'.

EPIC Ethnographic Praxis in Industry Conference, Fordham University, New York. Clayton

W., and Jain, J. (2014)

'Reconfiguring absence with digital connections'.

Royal Geographical Society Annual International Conference 2014

Imperial College, London, UK

Jain, J., and Clayton, W. (2014)

'Can digital presence reconfigure experiences of absence?'.

5th New Zealand Mobilities Symposium: Future Mobilities and Resilience [keynote]

University of Otago, Wellington, NZ

Jain, J., Clayton, W. (2014)

'Negotiating home while away with work'.

Summer Mobilities Workshop. University of the West of England, Bristol, UK

Yurman, P., Chatting, D., Bichard, J. Kirk, D. (2014)

'Capturing the Quotidian: what Home Life looks like at a Distance.

Home-work: connections, transitions and the wider world'.

Centre for Studies of Home, The Geffrye Museum of the Home, London, UK.

Bichard, J., Jain, J., Kirk, D. & Ladkin, A. (2013)

'Family Rituals 2.0. Overcoming distance in the work/life balance of mobile workers.

Contemporary issues in long-distance commute work in the extractive industries and other sectors'.

University of Vienna, Austria.

Bichard, J., Jain, J., Kirk, D., and Ladkin, A. (2013)

'Connecting to home: Mobile workers engagement in family life. Reconceptualising visiting

friends and relatives'. (VFR) Travel. University of Surrey Think Tank. Guildford, June 2013.

Jain, J., Clayton, W., Ladkin, A., and Marouda, M. (2013)

'Family Rituals 2.0 – The Employers' Perspective'.

Centre for Transport and Society Winter Conference 2013.

University of the West of England, Bristol, UK.

THE CHANGING NATURE
OF FAMILY LIFE,
AND THE ROLE OF
TECHNOLOGY IN
AMELIORATING OR
EXACERBATING THIS

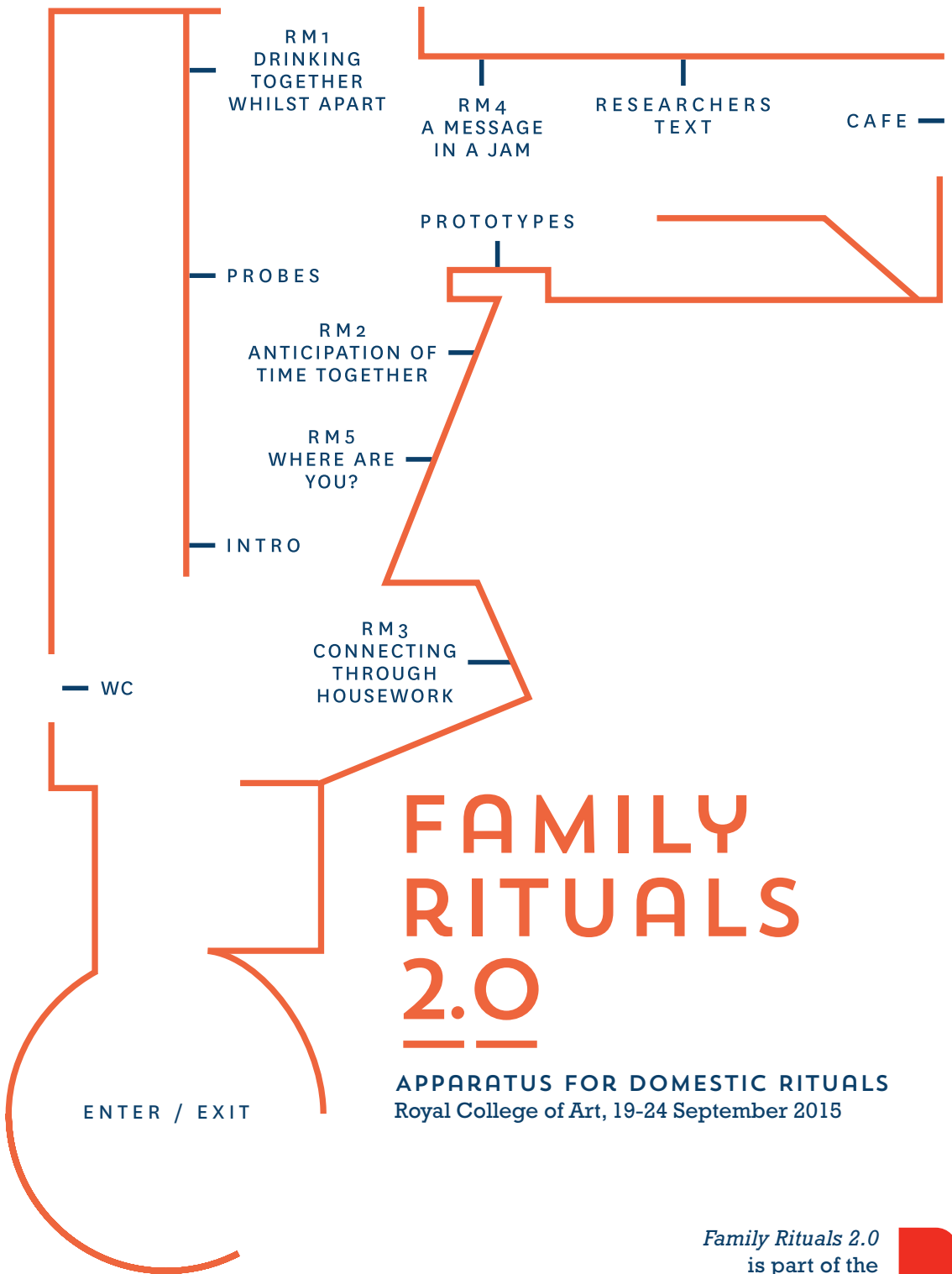

FAMILY RITUALS 2.0

APPARATUS FOR DOMESTIC RITUALS
Royal College of Art, 19-24 September 2015

Family Rituals 2.0
is part of the
London Design
Festival 2015





Royal College of Art

**THE HELEN HAMLYN
CENTRE FOR DESIGN**



**Newcastle
University**



BRISTOL

University of the
West of England



**Bournemouth
University**

Authors

Dr Jo-Anne Bichard, David Chatting,
Dr William Clayton, Dr Juliet Jain,
Dr David Kirk, Professor Adele Ladkin,
Dr Marina Marouda, Paulina Yurman

Exhibition and Publication Designers

Elizabeth Raby, Abbie Vickress