

University of Arkansas, Fayetteville

ScholarWorks@UARK

Chemical Engineering Undergraduate Honors
Theses

Chemical Engineering

5-2020

Improving PV Module Efficiency Through Cooling

Ashley Cox

Follow this and additional works at: <https://scholarworks.uark.edu/cheguht>



Part of the [Chemical Engineering Commons](#), and the [Power and Energy Commons](#)

Citation

Cox, A. (2020). Improving PV Module Efficiency Through Cooling. *Chemical Engineering Undergraduate Honors Theses* Retrieved from <https://scholarworks.uark.edu/cheguht/163>

This Thesis is brought to you for free and open access by the Chemical Engineering at ScholarWorks@UARK. It has been accepted for inclusion in Chemical Engineering Undergraduate Honors Theses by an authorized administrator of ScholarWorks@UARK. For more information, please contact ccmiddle@uark.edu.

As part of my honors thesis, I was part of a team competing in the 30th Annual Waste-management Education Research Consortium (WERC) in Las Cruces, NM. The competition is hosted by the University of New Mexico and our team was tasked with finding passive cooling methods for PV modules to increase the module's efficiencies. Unfortunately, due to the coronavirus, our team was not able to officially compete in the competition.

My role in developing this thesis was that of Research Coordinator. My role was to organize research efforts among other team members during the literary review stage and organize experimentation efforts once experimenting could begin. I wrote weekly emails to my team members outlining experimental and research tasks that needed to be completed by each member along with an estimated deadline.

Our team began researching in the middle of January and was able to work directly until the middle of March. During the first couple of weeks of the process, literary reviews were done on a variety of cooling technologies including water spraying, phase change materials, thermosyphons, optical coatings, heat sinks, and thermal electric generators (TEGs). Many of the technologies were eliminated based on scale up feasibility, equipment requirements, and overall cooling capacity. As a team, we decided to conduct experiments on 3 main cooling technologies, heat sinks in the form of fins, optical coatings in the form of a mylar covering, and thermal electric generators. I worked directly with the department's machinist to develop a design for building fins and then worked to build them with some of my teammates. I also worked on the construction of our mylar covering along with planning the experiments done by the team members each week and participated in nearly all experiments conducted. For the thermal electric generator experiments, I was in charge of wiring the system and developing a layout for the back of the panel. I also built additional fins scaled for the TEGs. Experiments on the TEGs were cut short due to the school closure.

For the competition, a paper and a presentation were written to discuss the experimentation process and results. For the paper and presentation, I was in charge of bench scale experimentation and collaborated on the El Chaparral Solar Facility design considerations section. I also wrote a majority of the economic analysis section. I worked on those contributing sections for the presentation as well.

During the duration of this project, I gained a variety of knowledge regarding the inner workings of solar panels and solar farms. I was able to gain knowledge about a variety of cooling technologies and work hands on with fin cooling, water cooling, cooling from coatings, and cooling utilizing thermal electric generators. I learned how to research, design, and experiment an idea to test its validity. I also had the opportunity to speak with workers in the solar panel industry including distributor Shine Solar and representatives from Ozark Electric.



University of Arkansas
Improving PV Module Efficiency Through
Cooling

Improving PV Module Efficiency Through Cooling

March 4th, 2020

Solarbacks

Blake Bradley

Brandon Conrad

Ashley Cox

Harrison Dawson

George Hill

Donhy Mai

Megan Reynolds

Faculty Advisors: Dr. Michael Ackerson & Dr. W. Roy Penney

Ralph E. Martin Department of Chemical Engineering

University of Arkansas

Fayetteville, AR

Table of Contents

Executive Summary:	6
Introduction:	8
Literature Review and Research Considerations:	9
Heat Sinks (Fins):	9
Hydraulic Cooling:	10
Optical Coatings:	12
Thermosyphon/Heat Pipe:	13
PCMs (Passive):	15
TEMs:	16
El Chaparral Design Considerations:	18
Fins:	19
Thermal Electric Generators (TEGs):	21
Economic Analysis:	23
Bench Scale Operation:	24
Fins:	25
Mylar Covering:	26
Thermal Electric Generators (TEGs):	27
Safety Considerations:	28
Experimental Results and Discussion:	28
Conclusions and Recommendations:	33
Acknowledgements:	34
References:	34

Executive Summary:

The Solarbacks researched and designed a variety of cooling methods that could be used to improve the efficiency of photovoltaics. These cooling methods can be separated into two categories: active and passive methods. The active cooling method of hydraulic cooling and the passive cooling methods of heat sinks (fins), optical coatings, thermosyphons, phase change materials, and thermoelectric generators were all taken into consideration as potential cooling methods. Passive cooling methods were preferred because the use of electricity required for the cooling mechanism would reduce the net electricity and subsequent profit from the panels.

Two variations of hydraulic cooling were researched: water spraying and the use of closed channels along the back of the panel. Both water spraying and closed channels along the back of the panel could effectively cool down photovoltaics, but the energy required to pump the necessary amount of water would exceed the additional power generated from cooling. Both variations would also require significant capital cost and would be difficult to scale up.

Two passive methods – thermosyphons and phase change materials – were researched but not tested as a final design. Thermosyphons use heat from the panel to boil a working fluid, increased buoyancy moves the fluid upwards where excess heat is released into the environment, condensing the fluid back into a liquid. This starts the process over again. Thermosyphons have been proven to work effectively for concentrated photovoltaic systems; however, the layout of typical solar farms is not conducive for thermosyphons if they utilize a solar tracking system. Chosen phase change materials would have a melting point that is within the operating range of the heated solar panel and would cool the panel through conductive heat transfer from the back of the panel to the phase change material. When put in thermal contact with the panel, the panel's temperature would not exceed the melting temperature of the material until all of it had melted. This method was disregarded because once the material had melted, the panel would no longer be cooled.

Additional passive methods were researched and tested. Ideal optical coatings reflect any solar irradiance that is not used by the panel to produce electricity, however, the coatings researched and tested produced minimal cooling. The coating Solarbacks tested was a thin sheet of mylar (saran wrap). The average cooling produced by the saran wrap was about 2.4°C. However, most of this cooling is thought to be a result of a thermosyphon effect because the

saran wrap was elevated off the surface of the panel rather than being directly attached. This elevation likely induced forced convection with the outside air to cool the panel. Fins as a heat sink work by increasing the surface area that heat can be dissipated from.

One of the biggest disadvantages to fins is that their efficacy is strongly dependent on ambient conditions. The fins tested by Solarbacks were 1" tall, spaced 1" from each other, and placed on a 1/8" aluminum sheet and attached to the photovoltaic panel using a thermal mastic. The approximate cost of materials per panel would be around \$28 when materials are purchased in bulk for a 1/32" thickness extruded fin. Testing showed that fins could cool the panel 14°C during peak temperatures and increase power output by about 5.52%.

Thermal electric generators (TEGs) use electrically dissimilar semiconductors to produce an electric current. When put in thermal contact with the back of the panel, the generator would use any excess heat to produce electricity. The heat TEGs use to produce electricity could help cool the panel to some degree, but their main contribution is the additional electricity they generate. This additional electricity would outweigh the losses due to heating and increase the profitability of each solar panel. If the back of a panel was covered with TEGs and a 20°C temperature difference was maintained for 8 hr. a day in New Mexico, the TEGs would produce an additional 0.778 kWh/day. The biggest disadvantage to using TEGs is the capital cost. Using typical TEG dimensions (40mm*40mm), 536 of them would need to be bought per panel with each TEG costing about \$2.92. Larger TEGs could be produced to fit to back of each panel and could reduce this capital cost significantly.

Overall, TEGs with fins provides the greatest amount of panel cooling and additional power production. There is an average of a 12.1°C temperature difference along a panel with this solution installed. Using manufacturer data, an estimated 135W can be produced from the TEGs at a 20°C temperature differential along the TEGs. However, when payout for this method is considered, it would take nearly 31 years. Purchasing additional panels that produce the same amount of power as the TEGs would have a payout period of less than 6 years. TEGs with fins at their current cost is not an economic alternative to purchasing more panels despite its cooling and power production capabilities.

Introduction:

For renewable energy, photovoltaic (PV) power is a necessary part of making the global shift to cleaner energy. With an expected 17% increase in energy demands over the next twenty-three years and rising awareness of the impact carbon emissions have on Earth's ecosystem, the need for non-traditional resources is escalating¹. Although research has led to significant increases in PV cell efficiency, most commercial modules top out at 20-22% solar energy to electricity conversion.

PV modules work by utilizing the energy from sunlight to produce a light-generated current within a semi-conductor material. The absorption of photons creates electron-hole pairs within the semi-conductor, causing the electron to move to a higher energy state, freeing it from the lattice structure while leaving behind a "hole" where the electron was bound. A diagram of a solar cell that shows the electron-hole pairs is provided in Figure 1. These electron-hole pairs are generated provided that the photon has an energy greater than the material's band gap, the minimum energy required to excite an electron from its bounded state to an excited state. Any energy below, or above, the band gap is converted to heat and is the source of heating within a PV module. Heating leads to two main issues for PVs: decreased efficiency and increased degradation mechanisms, shortening the life of a PV module.

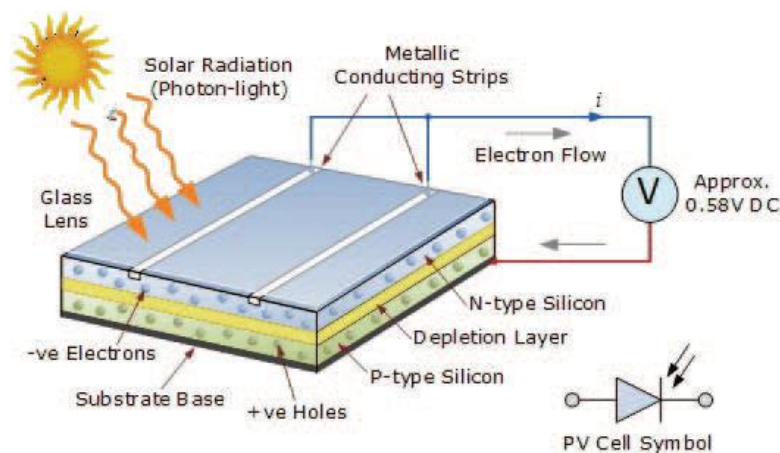

Figure 1. Basic construction and function of a photovoltaic cell (Sainthiya)

During normal operation, solar cells can reach temperatures upwards of 30-40°C above the ambient temperature depending on location and weather conditions. As PV modules heat up

a 0.4-0.5% decrease in power per °C occurs within silicon cells, depending on the manufacturing of the PV module². This leads to decreased electricity productions during hotter climates, when electricity demands are the highest, as well as a longer economic payouts for solar facility projects. This also conflicts with the main area of interest for solar facilities, deserts.

Deserts are an ideal location for solar facilities due to the increased sun exposure and lack of interest for human population. However, panel facilities located in deserts, such as the 10 MW El Chaparral, NM site owned by El Paso Electric, are subject to extreme heating effects and can benefit from cooling which they currently lack. Due to the mechanism through which the heating occurs within PV modules, there are two main strategies for cooling panel temperature: removal of waste heat production with traditional cooling methods and minimizing waste heat production by blocking sunlight with energies below the band gap of the semiconductor materials.

Literature Review and Research Considerations:

Before beginning the design process, an extensive literature review was conducted to assess the state of the art in photovoltaic (PV) and electronic cooling. Investigation into existing technologies for photovoltaic cooling facilitated both an understanding of possible heat removal tools and the formulation of a unique design solution. In this section, each of the cooling technologies is explained briefly and useful information is compiled in Table 1 below.

Heat Sinks (Fins):

Heat sinks are devices placed in thermal contact with a heat source that functionally increase the heat dissipation from the panel by increasing the surface area of heat transfer and natural convection from the panel³. They represent a simple, low-cost solution to photovoltaic cooling that requires little to no maintenance and consumes no electricity⁴. The heat sink's effectiveness is strongly dependent on the ambient conditions around and configuration of the panel system (wind speed and direction, orientation and elevation of panels, and geometry of the heat sink, etc.). Heat sink effectiveness is primarily limited by the inconsistency of appropriate ambient conditions and the poor thermal properties of air^{3,4}. For the purpose of PV cooling, most heat sinks are aluminum fins of some configuration attached to the back of the panel as in Figure 2. In small scale lab conditions, aluminum fin heat sinks bonded to PV cells by thermal grease have been proven to decrease panel operating temperature by 13-18°C and increase electrical output by up to 16%⁵. However, fins only decreased temperature and increased efficiency by 6°C

and 1.77%, respectively, in 30W panels⁶. Despite the varied performance of heat sinks, a study of three passive cooling technologies for a 30 kW PV system found that only fins were able to lower the levelized cost of energy (LCOE), the average net present cost of electricity generation for a power facility's lifetime, for the system⁷.

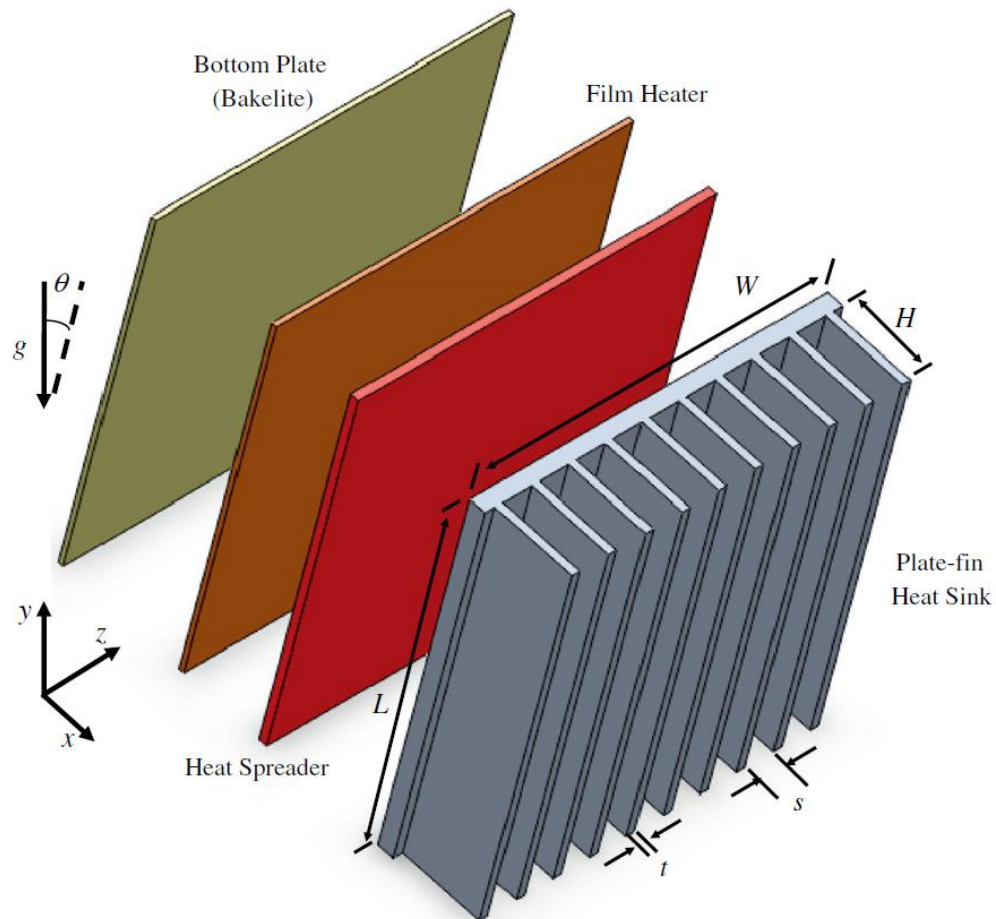

Figure 2. Diagram of fin heat sink for PV cooling²⁷

Hydraulic Cooling:

Hydraulic cooling is the removal of heat from the PV system via forced contact with water, either in the form of a spray from nozzles/drippers or thermal contact with closed channels through which water is pumped. This active cooling method requires electrical energy for the pump which circulates the water through the system, but in some small systems a DC pump can be powered directly by the panel⁸.

Water spraying is a well-established and effective method of photovoltaic cooling that has been shown to increase electrical output and potentially clean the panel if under dusty or sandy conditions⁹. Water is sprayed from nozzles or through a fan onto the top or bottom surface of the PV panel and allowed to flow down the surface into a collecting trough or drainpipe, from which it is recirculated to the sprayer by a pump¹⁰ (Figure 3). Water spraying systems have been shown to improve electrical output of the PV panel by up to 15%^{11,12} but these figures don't take into account the energy cost of the pump, which offsets gains⁹. Despite its clear potential, water spraying was not heavily considered in the design process as it requires large capital and operating investments, utilizes a limited resource in great capacity, and has little economic potential for scale up¹³.

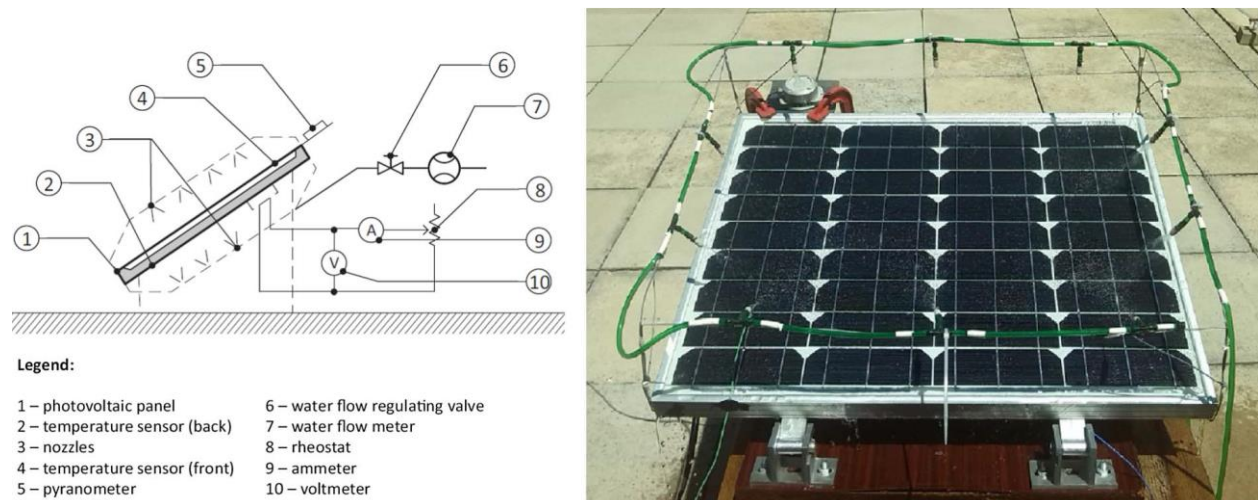

Figure 3. Water spraying diagram and experimental setup²⁰

Water circulation utilizes the forced convection of water through channels attached to the PV panel to remove heat from the PV system (Figure 4). This type of system, often referred to as a photovoltaic/thermal (PV/T) hybrid system, has the benefit of capturing thermal energy in the form of the hot water stream and has potential applications in residential water heating¹⁴.

Additionally, a wide variety of configurations—such as those found in Nižetić and Papadopoulos¹³—display the diversity and customizability exhibited by applications of this technology. In large-scale power production operations, water circulation presents issues of scale and total efficiency as the infrastructure required increase the LCOE beyond a conventional system¹³. Most industrial PV power plants don't have a convenient use for the thermal energy gained by the forced circulation system. As with water spraying, this is an effective way to

regulate PV module temperature but fails to reach economic feasibility given the substantial initial investment, maintenance costs, and power consumed to pump water through the cooling apparatus.

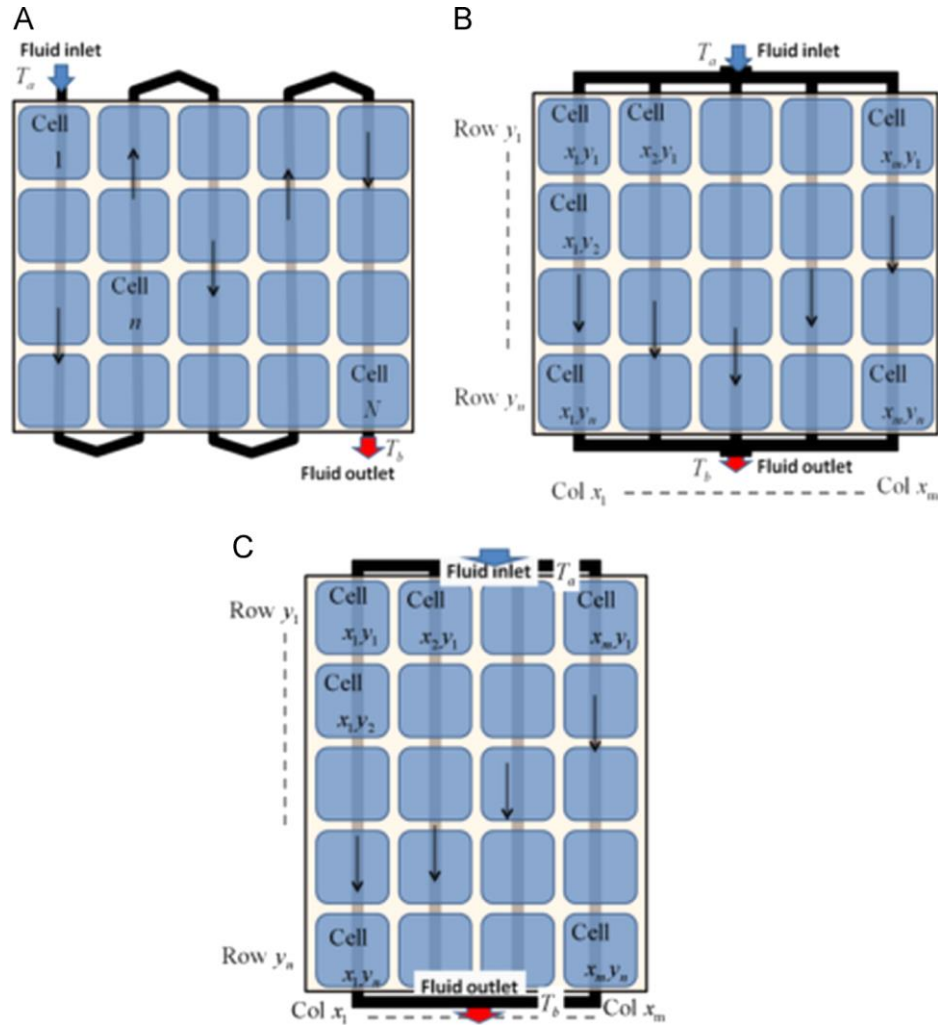

Figure 4. Diagrams of possible forced water circulation designs¹³

Optical Coatings:

Almost half of solar irradiance falls into the near-infrared (NIR) portion of the electromagnetic spectrum, which modern solar cells fail to efficiently convert to electricity¹⁵. The result of this incongruity between solar emission and PV absorption spectra is that most of the incident infrared radiation is absorbed by the panel as heat¹⁵. Optical coatings can help prevent some of NIR absorption by reflecting it upon incidence and take advantage of the

atmosphere's high transmittance for thermal radiation from a blackbody within midinfrared (MIR) ranges¹⁶. These coatings are often transparent and contain thin layers of micro- or nano-structures/materials selected or designed for their high emissivity/absorptivity in the visible spectrum and low absorptivity in the infrared¹⁷. When this coating is placed over the surface of the panel, it can limit heat generation within the panel and, while exposed to the sky directly, can redirect heat directly into space¹⁷ (Figure 5). The primary difficulty facing radiative cooling are the small amount of cooling achieved—about 1.5°C—compared to the highly specialized nature of the materials and the decrease in convective cooling, which dominates heat transfer from the panel, caused by many optical/photonic materials¹⁸. A mylar coating is a suggested solution evaluated in this report. Mylar films are often used in window coverings to block additional IR from entering buildings, leading to cooler indoor temperatures. Mylar is capable of a significant reduction of IR transmission beyond the 7 μm range, dropping to nearly 20% transmission from that range through the entirety of the IR spectrum¹⁹. Applying a coating at an elevation above the panel surface has also been suggested to cause a thermosyphon effect between the panel's surface and the coating.

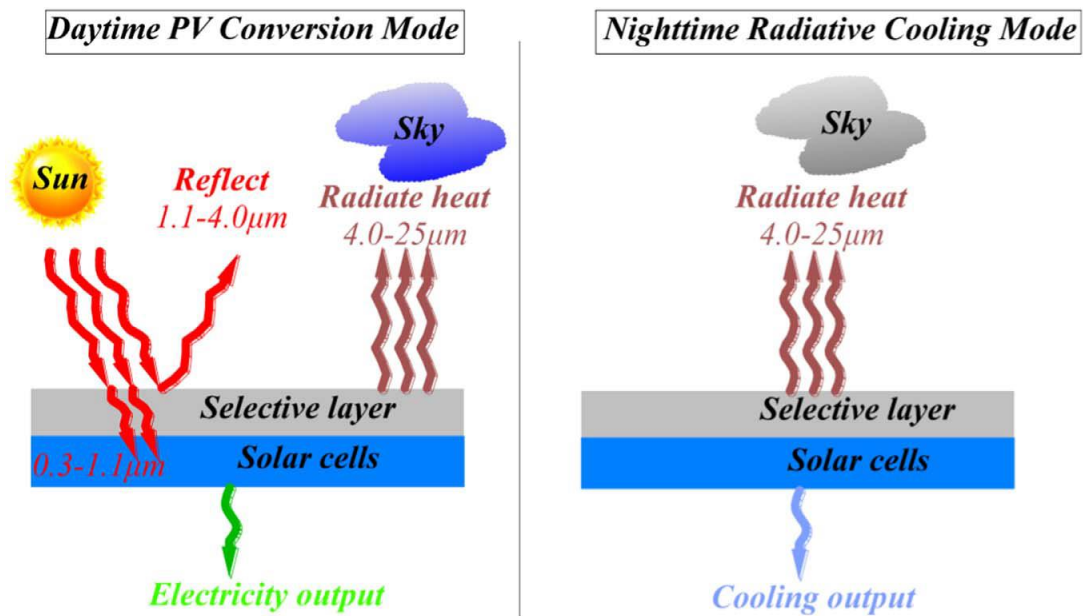

Figure 5. Day/Nighttime activity of optical coatings for radiative cooling¹⁷

Thermosyphon/Heat Pipe:

Thermosyphons and heat pipes are passive heat transfer apparatuses consisting of an evaporator and a condenser, connected by insulated (adiabatic) pipe²⁰ (Figure 6). They make use

of phase change behavior to remove heat from the PV while passively driving the continued removal of energy. For example, a working fluid with its boiling point between the desired operating temperature and the maximum system temperature comes in contact with the heat source (evaporator section), where a portion of the fluid is vaporized and absorbs heat equal to its heat of vaporization. This energy is carried through the adiabatic portion by the increased buoyancy of the vapor to the condenser where heat is rejected into the surroundings until the fluid condenses back into vapor. The condensation and subsequent increase in density causes gravity to drive the fluid back through the adiabatic section to the evaporator. This device can be configured as a pipe with wicking material along its walls or as a closed loop and is proven to be an effective means of heat transfer relative to other passive technologies²¹. Thermosyphons have been proven to achieve effective cooling in many electronic systems including concentrated photovoltaics (cooled from 84°C to 46°C²²) due to their ability to transfer a large amount of heat even when a small temperature difference between the heat load and ambient conditions is present²¹. Despite its effectiveness and simplicity of design, the thermosyphon requires that the evaporator be below the condenser to drive the process, which can be difficult to achieve with the existing layouts of many solar power facilities. Additionally, single- or dual-axis tracking systems pose a problem for heat pipe applications as the changing angle of the panel would alter the conditions of the thermosyphon.

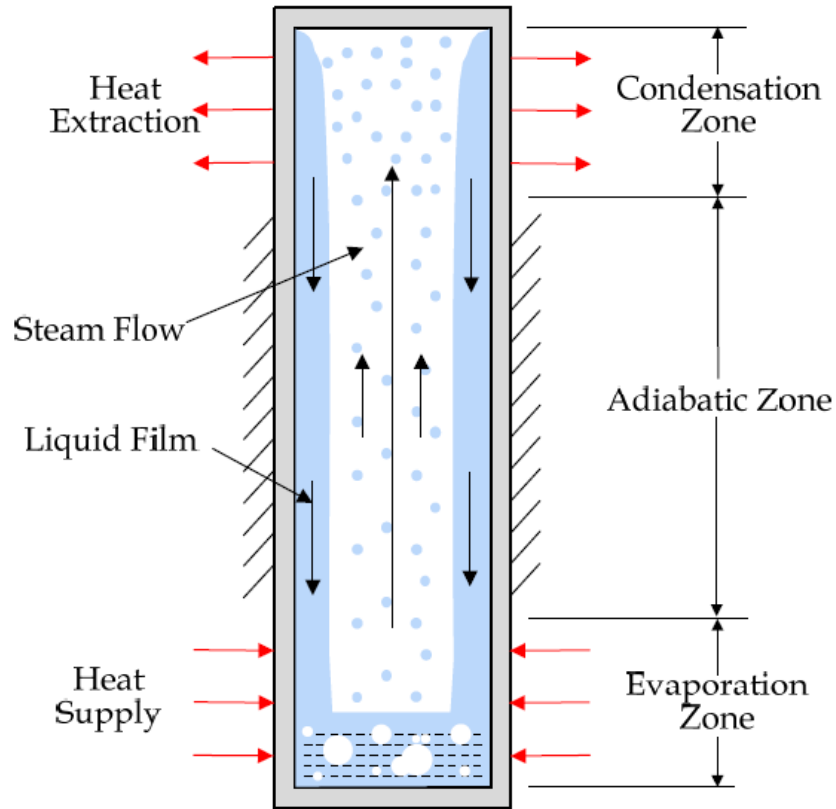

Figure 6. Basic structure and function for a two-phase closed thermosyphon²⁸

PCMs (Passive):

Phase change materials (PCMs) are used to remove heat from a system according to the latent heat of the PCM¹⁰. These are typically organic materials, such as paraffin wax, that are selected by melting point corresponding to the goal temperature of the system being cooled. The PCM is placed in thermal contact with the system (Figure 7); as the temperature of the system exceeds the desired temperature, the PCM in contact with the panel reaches its melting point and absorbs heat equal to its latent heat and stores energy in its liquid form²³(Figure 8). Once the ambient temperature drops below the melting point of the PCM (evening/night), this heat is evolved to the surroundings and the PCM ‘resets’ to its solid form in preparation for its next melting. In many PCM cooling systems heat transfer to the PCM is limited by poor thermal conductivity, which can be enhanced by embedding aluminum fins in the material to increase heat transfer from the panel. Despite the high heat capacity of many PCMs, specialized materials bear high initial cost and the cooling is limited by the volume and thermal properties of the material chosen⁷.

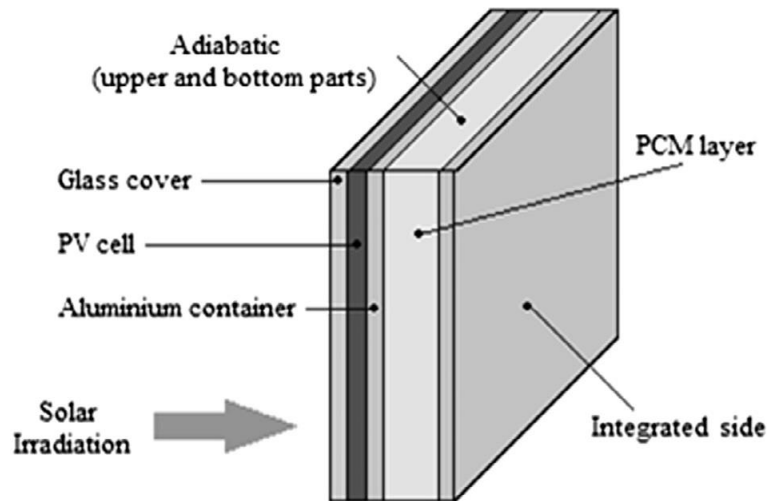

Figure 7. Structure of PCM cooling apparatus for PV cell⁷

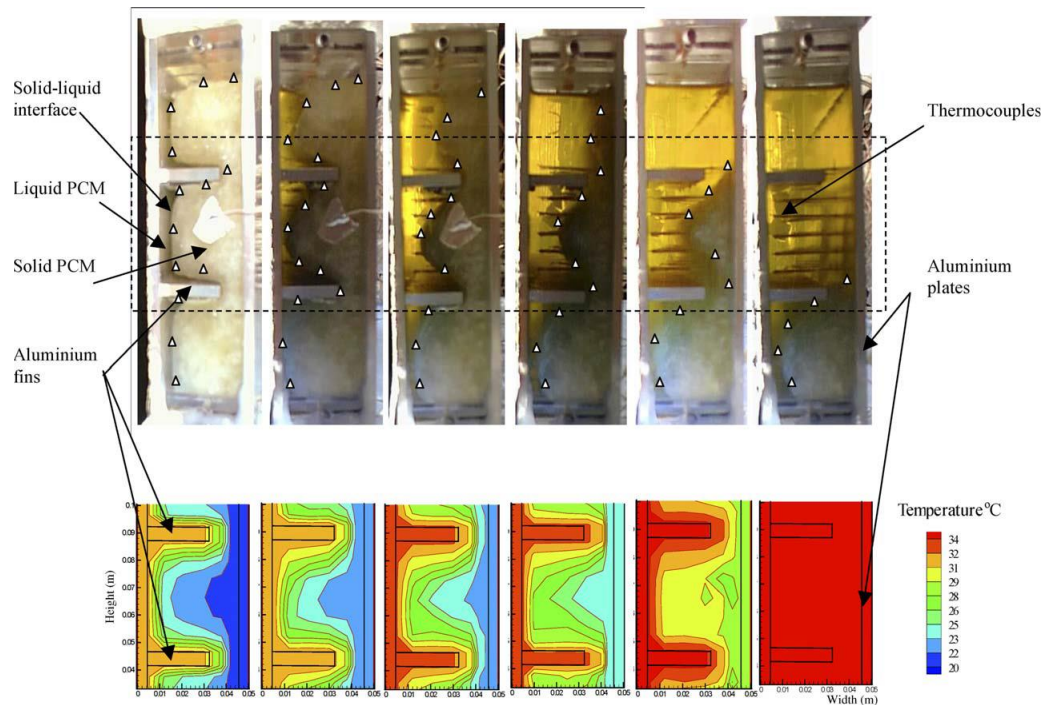

Figure 8. PCM with aluminum fins on back of PV panel as heat is absorbed over time⁷

TEMs:

Thermoelectric modules (TEM) consist of p- and n-doped (electrically dissimilar) semiconductors connected thermally in parallel and electrically in series to facilitate one of two effects: electricity generation at the expense of heat, or active cooling at the expense of electricity²⁴. When a current is run through the TEM, it generates heating on one surface and

cooling on the other according to the Peltier effect (thermoelectric cooler or TEC). Conversely, a temperature gradient across the semiconductors causes the migration of charge-carriers across the TEM, resulting in a potential difference between the ends of the TEM nodes and causing a voltage through module according to the Seebeck effect (thermoelectric generator or TEG). The material science of semiconductors has not achieved high efficiency in this conversion but TEMs represent solid-state, durable, devices with the capacity to increase electricity output in the PV when applied to the panel as in Figure 9²⁵. While not much literature exists on the application of thermoelectric cooling to PV arrays, this study considered them for two potential applications: applied thermoelectric cooling may increase electricity output by increasing PV efficiency according to the cooling capacity of the TEC while TEGs may recover some of the lost electrical output of the PV system from waste heat without increasing the land use.

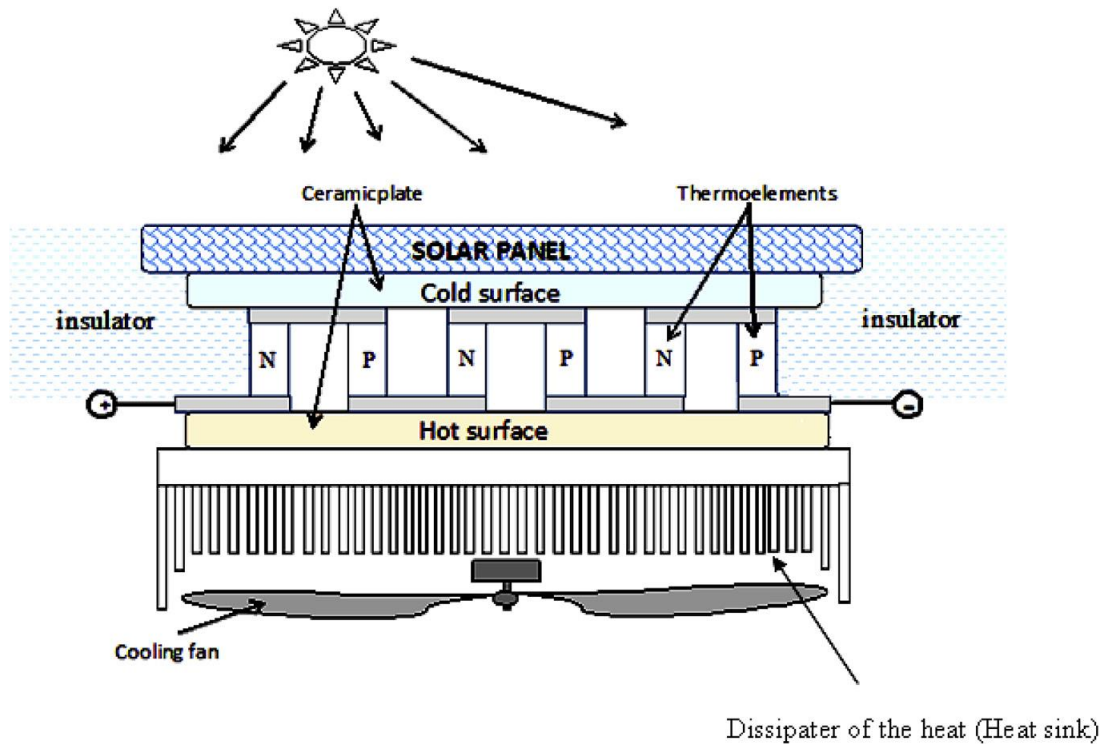

Figure 9. Thermoelectric cooling of a solar panel. Thermoelectric generation would be an identical configuration with switched ‘hot’ and ‘cold’ surfaces²⁹

Table 1. Advantages and Disadvantages of Various Cooling Methods

Method:	Advantages:	Disadvantages:
---------	-------------	----------------

Hydraulic cooling	<ul style="list-style-type: none"> - High heat transfer rate - Cooling control via flow rate 	<ul style="list-style-type: none"> - High initial and operating cost (pumps) - High water requirement
Optical Coatings	<ul style="list-style-type: none"> - Non-intrusive - Decreases heat generated by panel - Increases heat rejected by panel 	<ul style="list-style-type: none"> - Highly specialized and expensive - Interference by dust and particulates
Thermosyphon/Heat Pipe	<ul style="list-style-type: none"> - Very high heat removal potential - Closed, passive system 	<ul style="list-style-type: none"> - Large capital investment - Increased potential for malfunction - Geometric limitations for many panel configurations
Phase Change Materials	<ul style="list-style-type: none"> - High heat transfer - Little to no maintenance 	<ul style="list-style-type: none"> - Limited capacity throughout day - High capital cost
Fins/Heat Sink	<ul style="list-style-type: none"> - Simple, non-expensive - Very low operating cost - Ease of manufacture and acquisition 	<ul style="list-style-type: none"> - Limited heat removal ability - Climate/PV array configuration dependent
Thermoelectric Generators (TEGs)	<ul style="list-style-type: none"> - Solid state, durable - Ease of integration - Utilizes heat waste stream to produce energy 	<ul style="list-style-type: none"> - Expensive - Limited efficiency - High capital cost
Thermoelectric Coolers (TECs)	<ul style="list-style-type: none"> - Solid state, durable - Ease of integration - Active cooling with control 	<ul style="list-style-type: none"> - Expensive - High energy cost - High capital cost

El Chaparral Design Considerations:

Designs for currently constructed solar facilities were assessed in consideration to the El Paso Electric El Chaparral Solar Farm in Chaparral, New Mexico. This solar farm consists of 40,300 polycrystalline panels that create a 10 MW array and serves as a representative base model for implementation of cooling technologies. Satellite images of the El Chaparral site are shown in Figure 10 below.



Figure 10. El Chaparral Solar Facility

Two primary cooling methods were assessed for industry scaleups: fins and thermoelectric generators. The solutions were then compared to the alternative of purchasing additional panels for the facility. Selection of these passive methods was determined by projected solar cell efficiency improvement and economic feasibility. In addition, fabrication, installation, and maintenance requirements were also considered.

Fins:

Implementation of fins onto existing panels would be highly labor intensive. The material of construction for the fins will be aluminum, as it provides high thermal conductivity of approximately $200 \frac{W}{m \cdot K}$, and is a relatively lightweight, cost-effective metal alloy that is commonly extruded. The fins would be extruded to an optimal trapezoidal geometry from a sheet of aluminum backing that would provide maximum thermal contact with the back of the solar panels. The desired thickness of the sheet and the fins would be 1/32” with a fin height of 1” by 1” spacing between fins. A sketch of this fin design along the back of a solar panel is shown in Figure 11. As can be seen in the figure, the fins would be placed to run parallel to the portrait orientation of the panel.

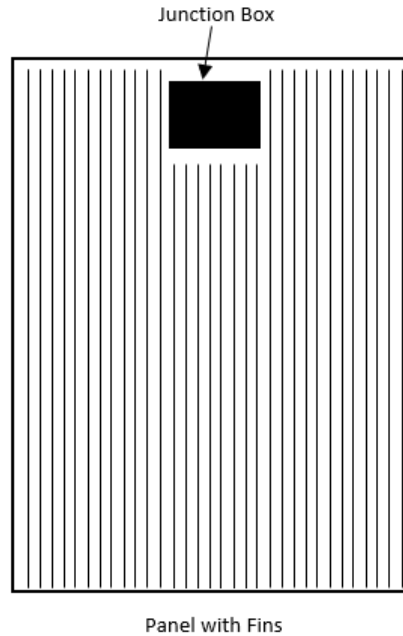

Figure 11. Panel diagram with fins attached to back

A sheet of extruded aluminum with these specifications could be produced at a price of \$1.05 per pound and would weigh approximately 17.25 pounds. Therefore, aluminum fins for each panel would cost approximately \$18.11. In addition, the installation of the fins would require a thermal mastic to effectively conduct heat from the back of the panel to the fins so that the excess heat may be distributed over the surface area of the fins. A potential thermal mastic can be purchased from China at \$0.95/kg which after applying a 1/8” layer to each panel would be an additional \$10.36 per panel.

Along with material costs, labor costs are applicable to installation of fins to existing solar facilities. The median labor cost for photovoltaic installers in New Mexico is \$20.52, and the anticipated installation time for one panel is 0.5 hours based on bench scale installation times. Therefore, the total fin installation time for the El Chaparral Solar Farm would result in a total labor cost of just above \$413,000. While the material and installation cost of aluminum fins is significant, the fins provide a passive method of cooling with minimal maintenance costs. Once the fins are installed, the system would be weather-proofed and would not require cleaning or routine upkeep, easily lasting the normal expected lifetime of a panel of 20-30 years. It is also worth noting that these costs would be for installation on a preexisting facility. Application of fins can be incorporated into the manufacturing of panels for a fraction of this cost due to

reductions in installation time as well as labor cost. We estimate that incorporating fins during manufacturing could reduce installation and labor cost by at least 75%.

Fins constructed with the optimal specifications detailed above are predicted to cool the panels by 14°C during peak temperatures through dissipation of heat and forced air convection. This temperature reduction corresponds to a 5.52% increase in power output efficiency per panel. Over the full scale of the El Chaparral Solar Farm of 40,300 panels, adding the fins allow the panels to produce an estimated 23.88 kW/yr in additional power annually. At a peak power rate of \$0.13 per kilowatt hour in El Paso, fins would result in a \$125,094 annual revenue increase for this facility alone.

Thermal Electric Generators (TEGs):

Full scale implementation of thermoelectric generators would require the largest capital cost of all proposed methods but would present the largest opportunity of panel efficiency increase and profitability. Thermoelectric generator modules are most commonly manufactured in a 40 mm by 40 mm size. However, if these sized modules were to be used for a solar facility, each panel would require approximately 536 of these sized TEGs in order to cover 55.6% of the panel while allowing room for wire spacing. In turn, this would require all 536 modules to be wired in series. A bench-scale design with the spacing and wiring specifications is shown in Figure 12. For this design, 25 thermoelectric generator modules were wired in series and placed on the back of the panel. If the same modules were implemented at a solar facility, the back of each panel would be equipped with 536 modules.



Figure 12. 25 TEGs on the back of a 300 W panel

A 40 mm x 40 mm sized TEG can be purchased in China for a price of \$2.92. At this price, it would cost around \$1,565 to cover the back of a panel. If a grid of 18 by 36 TEGs is set up on the back of a panel and the 8 hours of full sunlight a day observed on average in New Mexico is taken into consideration, one panel would produce 1.13 kWhr/day for a 20°C temperature gradient along the TEG. If this setup was placed in the El Chaparral solar farm, an extra 45,595 kWhr/day would be produced, or an additional 16.7 million kWhr/yr.

The extent of this labor is impractical for a single panel and is entirely unrealistic for a full solar facility with thousands of panels. Larger TEGs would significantly reduce labor costs for both maintenance and upkeep but would need to be custom ordered from a manufacturer. Currently, the Solarbacks have not found a manufacturer to produce the custom TEGs that would be required for large-scale implementation. As with the fins discussed above, the thermoelectric generators would require maximum thermal contact in order to optimally remove excess heat from the back of the panel. In addition, the thermoelectric generators would operate more effectively with an added heat sink to the cool side of the module. One such proposed heat sink would be aluminum fins, as discussed above. These fins would operate the same way but would now dissipate heat from TEGs as opposed to directly from the panel. Similarly, the fins would require a thermal mastic for maximized thermal contact and support.

While this solution requires greater capital investment and installation time, the potential for increased efficiency and profitability are notably higher than other methods. In addition, TEGs secured by aluminum fins would serve as a passive, weatherproofed cooling alternative. Routine upkeep would be minimal for this system. Our bench scale experiments were run with 25 TEGs wired in series. These were the 40 mm by 40 mm TEGs, and they were equipped with aluminum fins to aid in creation of a greater temperature difference. Additional power produced by the TEGs could be stored in a battery system that many solar facilities are equipped with or directed to the local power grid. This cooling method is a passive, weatherproof system that has the potential for a large payout, particularly in desert conditions where panel temperatures may reach as high as 85°C. Detailed economics are provided in the Full-Scale Economic Analysis below.

Economic Analysis:

Each of the full-scale systems have a rather high capital installation cost which are detailed in Table 2 below. All costing estimates assumed that panel power would be used for peak power which sells for \$0.13/kWhr in New Mexico compared to the average selling price of \$0.11/kWhr.

Table 2. Economic Analysis for TEGs and Fins vs Buying More Panels for El Chaparral

Method	Install Cost (\$)	Materials Cost (\$)	Total Capital Investment (\$)	Additional Power/year (kWhr/yr)	Additional Profits/yr (\$/yr)	Payback Period (yr.)
Adding Solar Panels	\$10,429,902	\$4,836,000	\$15,265,902	16,653,845	\$2,163,517.98	5.96
Adding TEGs	\$3,307,824	\$63,471,094.76	\$66,799,800.80	16,653,845	\$2,163,517.98	30.88
Adding Fins	\$413,478	\$1,147,473.80	\$1,560,951.80	962,295.15	\$125,093.69	12.48

In Table 2, the initial cost and additional power produced by each situation are provided. It can be observed that adding TEGs would add an additional 16.7 million kWhr/yr. To produce that same extra amount of power as that of the TEGs, the purchase of 19,320 additional panels

would be necessary. With equipment and installation cost taken into consideration, it would take nearly 6 years to gain the additional payback from installing new panels as opposed to adding TEGs which would take nearly 31 years to gain payback on at the current selling price and installation cost for the small TEGs. If a company was able to manufacture a large, singular TEG that would produce similar outputs for under \$1,500 per panel, that would make this solution more economical. Having a large TEG would also increase the surface area of the TEG contact with the panel which would increase power output. Currently, there are no advertised manufacturers that sell panel size TEGs but there are several manufacturers in China that custom design TEGs. If installation of the TEGs was done during the production process as opposed to installation on preexisting solar farms, this would be another reduction in the cost for TEGs.

Comparing adding fins to adding more panels, a similar cost dilemma is encountered. To add fins to all the panels at the El Chaparral facility would only contribute to half the power increase a year that adding the 19,320 panels would produce yearly. Though the installation cost is comparable and total capital investment is half of that for adding panels, the additional profits are far lower than that of adding TEGs or panels since the fins themselves do not produce extra power. As a consequence, the payback period is far longer at 12.48 year. This payback is at least within the lifetime of the panel (20-30 working years) but is still an unreasonable proposition for an investment. To reduce the costs of the fins, they could be added onto panels at the manufacturing stage to replace the normal plastic weather-proof backing to save money and forgo the cost of installation.

Bench Scale Operation:

Three separate bench scale experiments were constructed in detail on a full-sized panel. Three testing methods were constructed for full-sized panels: fins, mylar covering, and TEGs. On a smaller 12V panel model, transitional IR blocking films, TEGs, and fins were tested both indoors and outdoors. The indoor setup, shown in Figure 13, is a single panel test using 6 halogen lights at 1 ½ feet from the panel surface. The panel is held vertically during this test to ensure full light coverage along the panel. The indoor test allows surface temperature across the panel to reach up to 100°C. For this section, we will focus on the full-sized panel testing procedures. Each panel was tested with an electric load drawn on the panel varying from 0 to 18 Ohms (Ω). Arkansas weather limited the heat peaks of the panel to 50°C during panel testing.



Figure 13. Indoor Testing Module

Fins:

For fin testing, two test models were created, a 1' x 1' model for TEGs and a large-scale fin covering the entire back of the panel. Small scale fins were constructed by pop riveting 1/4" aluminum U channels in the back of a 1/8" sheet of aluminum. Similarly, large scale fins were constructed by pop riveting 1" aluminum U channels to a 1/8" sheet of aluminum. The fins cover the entire backing of the panel, adding an additional 15 ft. of surface area to the back of the panel. To ensure full contact with the panel, a thermal paste is used. A 1/8" layer is applied on the fin side to seal the panel. A wiring system along the top of the panel attached to the frame is used to ensure a good seal along the panel backing for maximizing heat transfer. Fins were tested both indoors and outdoors. To attach the fins to the back of the panel, a wire strap is attached at the left and right of the panel at 1/4th and 3/4th the height of the panel. A picture of the large-scale fins is shown in Figure 14.



Figure 14. In-House Constructed Fins

Mylar Covering:

To test this solution, a saran wrap coating was placed above the panel using a PVC mounting frame. The frame was secured to the panel using duct tape to ensure full stretch coverage of the panel by the film. The frame raised the film 8” above the panel to allow for air flow and a thermosyphon effect between the film and panel. The mylar covering is shown in Figure 15.



Figure 15. Saran Wrap Coating

Thermal Electric Generators (TEGs):

TEGs were tested in a variety of configurations to determine cooling on a larger scale. A single TEG used in testing is 40 mm x 40 mm so total coverage of the panel backing would require approximately 536 at this size. To demonstrate the TEG's cooling ability on the panel surface, arrays were made using 1, 9, and 25 TEGs in grid patterns while monitoring the front of the panel, the panel surface between the panel and TEGs, and the back of the TEGs. Secondary testing was conducted with the TEGs evenly spread along the back of the panel in a 5 x 5 pattern to see how spacing affected cooling. These tests were all done inside the laboratory at temperatures up to 65°C. In addition to the TEGs, a fin heat sink was added to the back of the fins for testing outdoors in the 5 x 5 grid pattern as shown in Figures 16 and 17. This test was conducted to show a maximized cooling system created by the TEGs. All TEG test were conducted with the TEGs in series with a 5Ω resistor in line.

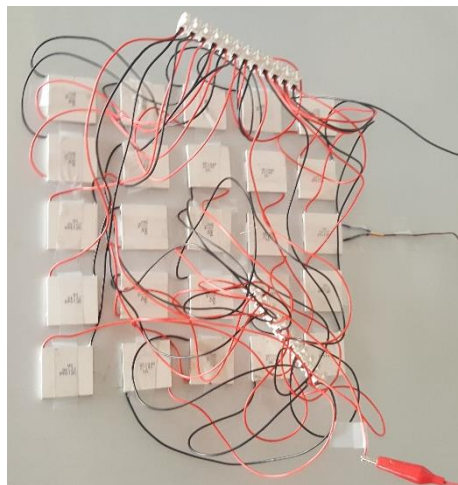

Figures 16. TEG setup with fins

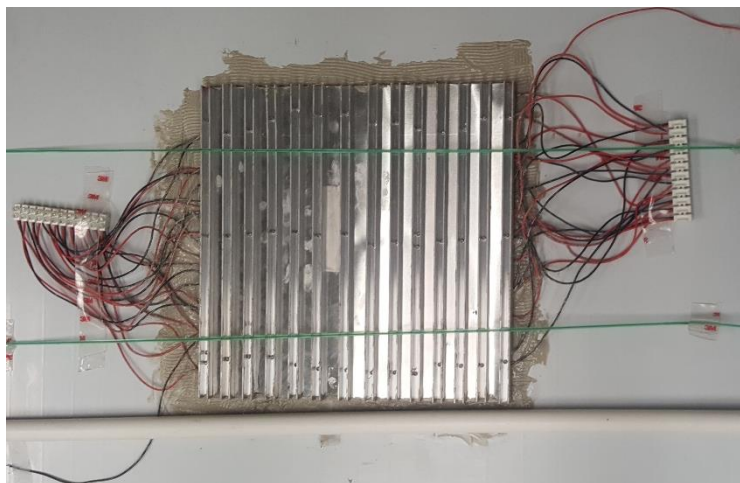

Figure 17. TEG setup without fins

Safety Considerations:

High temperatures and electrical componentry are the major hazards faced by this project. In situations where temperatures exceeded 85°C, heat resistant gloves were used for handling equipment. For reading power of the panels, an in-house resistor setup was constructed using a variety of resistors each designed to dissipate a minimum of 45 W of power in order to withstand the outputs of the panels.

Experimental Results and Discussion:

Mylar Covering:

A sheet of Mylar covering the solar panel 8" off of the panel resulted in slight cooling. The average cooling was about a 2.4°C difference with a max cooling of 4.07°C. The average temperature of the base panel was 43.5°C while the average temperature of the panel with the Mylar covering was 41.1°C. The temperatures of the base panel and the panel with the Mylar covering over time can be seen in Figure 18, while the temperature difference between the front temperatures of both panels can be seen in Figure 19. As can be seen in both figures, the temperature of the Mylar covered panel was consistently less than the base panel.

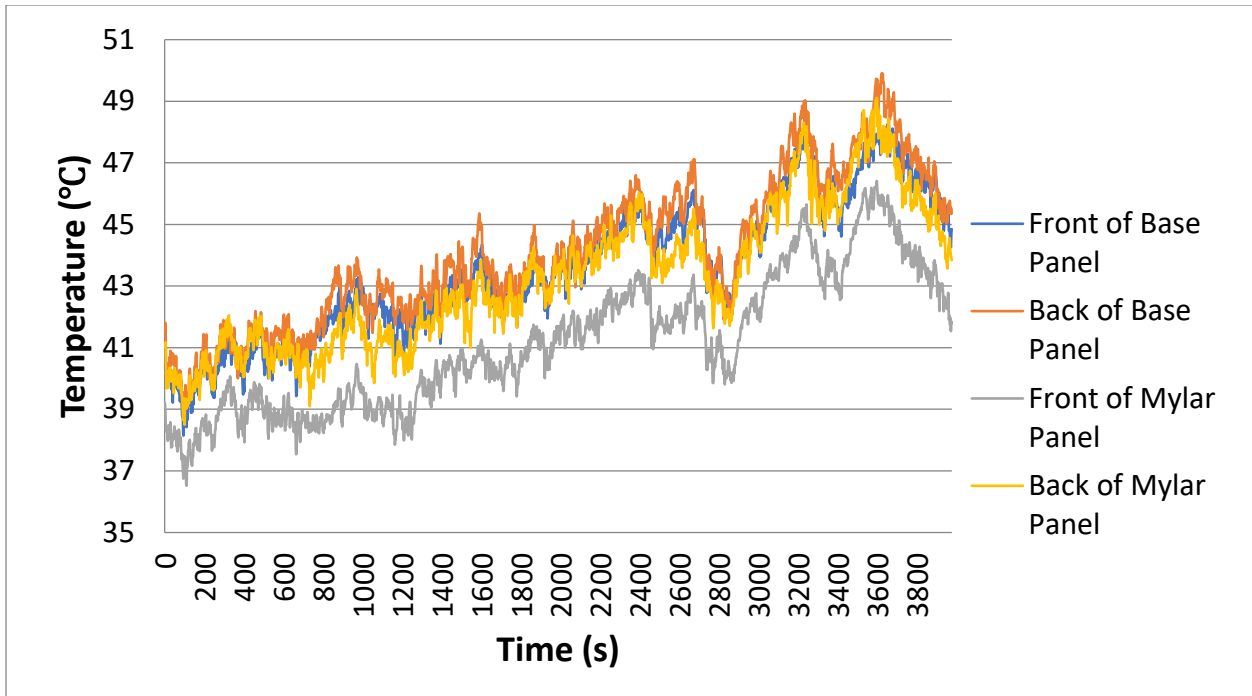

Figure 18. Temperature vs. Time for two panels; a base panel and a panel with a Mylar cover. Testing started at 11:20 AM and ended at 12:32 PM.

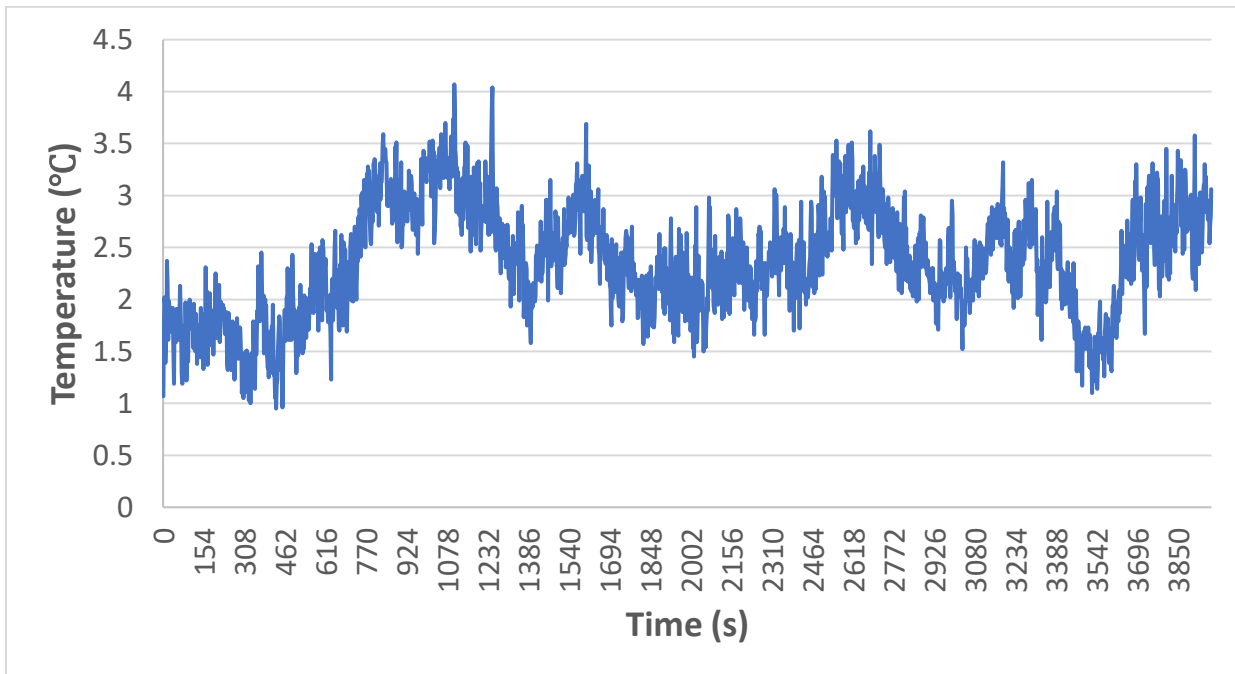

Figure 19. The temperature difference vs time of the front of the base panel and the front of the Mylar covered panel.

The Mylar-covered panel showed an increase of power at an average of 1.3% with a max increase of 3.3%. The small difference in power between the base panel and the Mylar covered panel over time can be seen in Figure 20. The peak power difference was around the end of the experiment and was approximately 3 degrees Celsius.

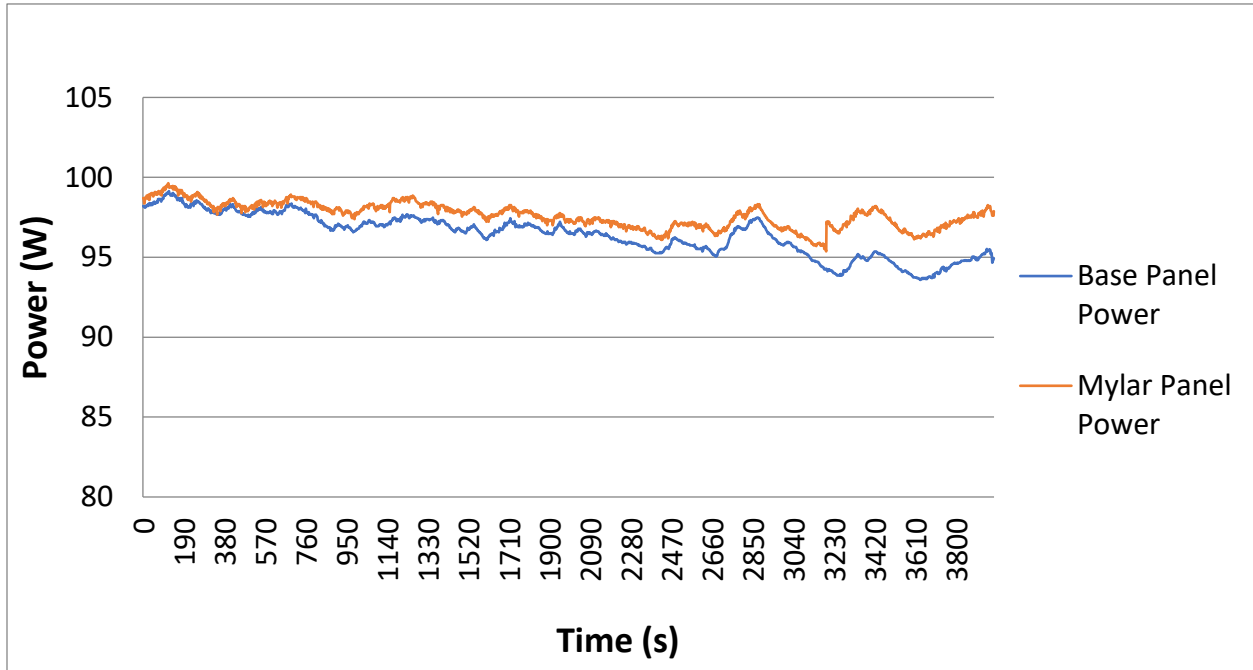

Figure 20. Power vs. Time for two panels; a base panel and a panel with a Mylar cover. Testing started at 11:20 AM and ended at 12:32 PM.

Fins:

The maximum temperature difference between the front of the base panel and the front of the panel with fins attached was 2.82°C. The front of the base panel had a corresponding temperature of 31.64°C. The minimum temperature difference was 0.48°C which had a corresponding temperature of 21.41°C. This shows that the efficacy of the fins decreases when the temperature of the panel decreases. The average temperature difference throughout the test was 1.12°C. The temperatures of the front and backs of both panels over time can be seen in Figure 21. There is a clear distinction in the temperature difference of the panels at the beginning of the experiment than at the end of the experiment. This is evident in Figure 22, in which one can evaluate the temperature difference between the fronts of both panels over time. With time, the temperature difference between the two panels decreased from approximately 2.5°C to 0.5°C.

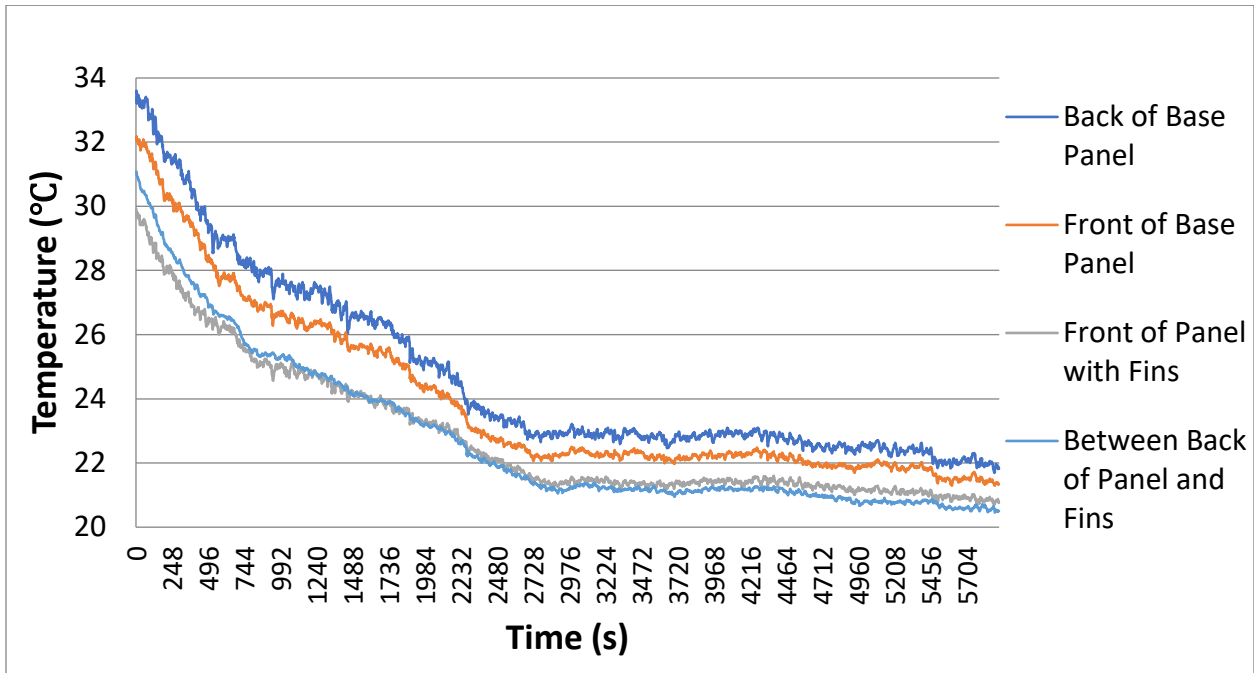

Figure 21. Temperature vs. Time for a base panel and a panel with fins. Testing started at 2:53 PM and ended at 4:32 PM.

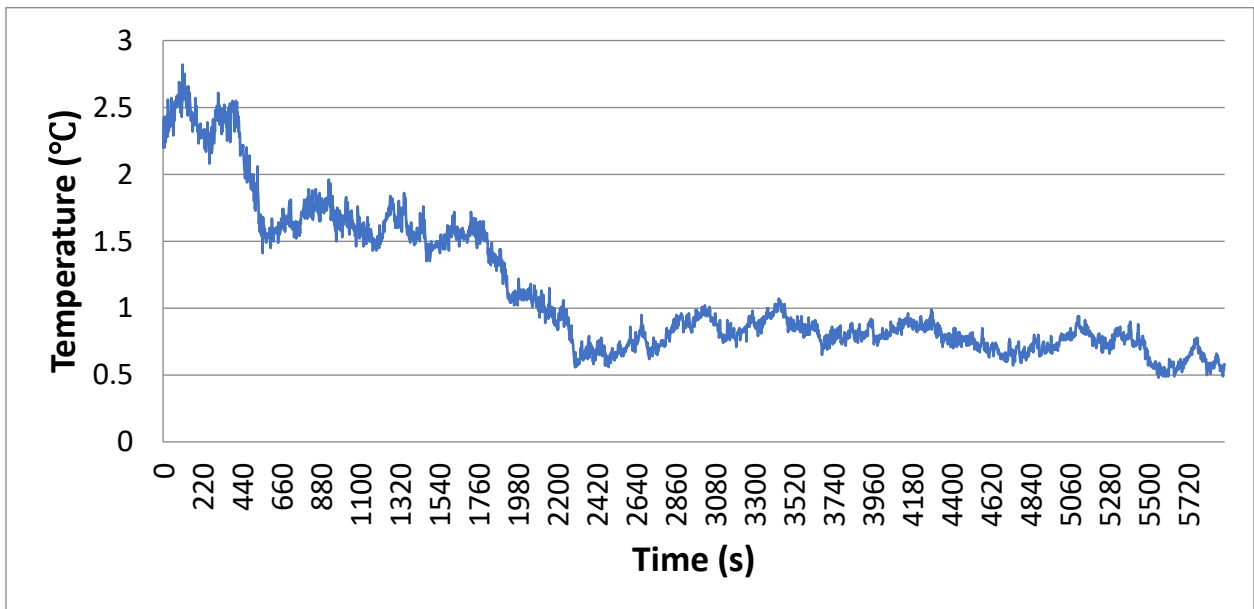

Figure 22. The temperature difference vs time of the front of the base panel and the front of the panel with fins attached.

As can be seen in Figure 23, the panel with the fins attached to the back had a higher power output than the base panel. The average power increase during the time scale showed was 5.7%. The max power increase was 8.6%.

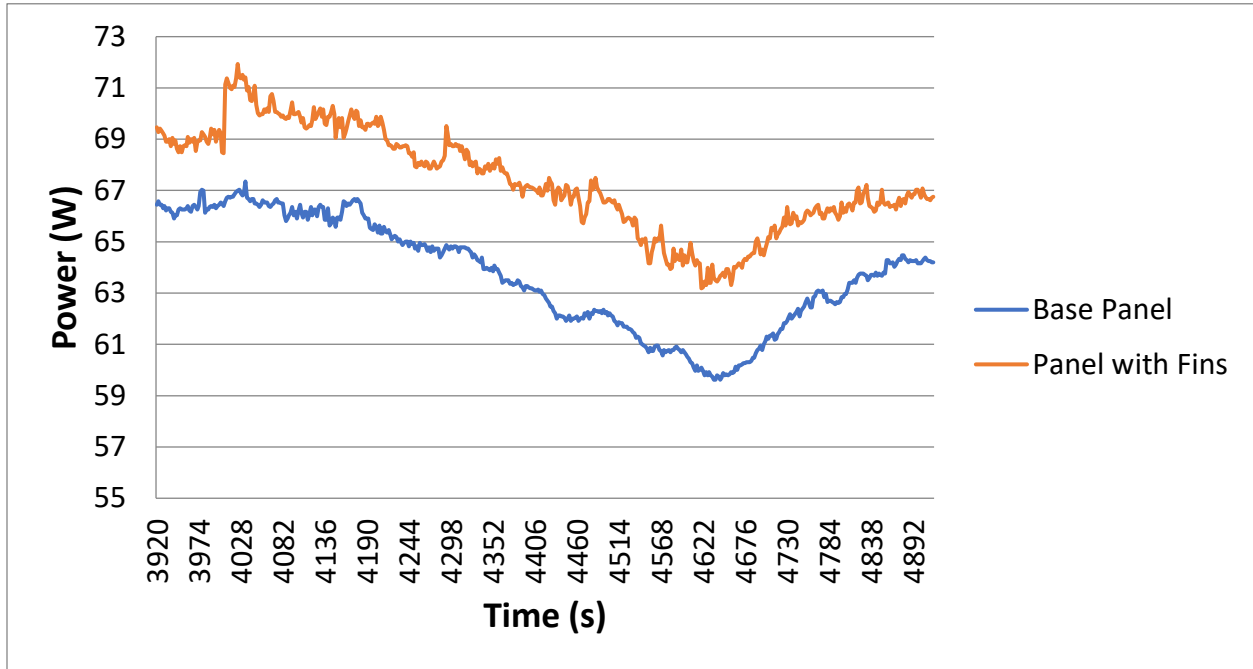

Figure 23. Power vs Time graph for a base panel and the panel with fins during the same experiment shown in Figure 22.

Overall, the addition of the fins showed reduced cooling but a greater power increase, while the Mylar covering showed a smaller increase in power but greater cooling. Table 4 displays an overview of the relative changes in temperature and power for both fins and Mylar covering.

Table 4. The power and temperature changes for fins and a Mylar covering.

Experiment Type	Percent Power Increase	Temperature Change
Fins	5.7% Average; 8.6% Max	1.12°C Average; 2.82°C Max
Mylar Covering	1.3% Average; 3.3% Max	2.4°C Average; 4.07°C Max

TEGs:

In testing of the TEGs, it was found that $15\ \Omega$ had a power output of approximately 0.025W . Resistances over $15\ \Omega$ could not be tested at the time of the experiment, so further testing could have resulted in a greater power output. The temperature of the front of the panel was, on average, about 62.5°C during this experiment. There was a temperature difference of, on average, 12.1°C from the front of the panel to the back of the panel. This was achieved by using a fan with a constant wind speed of $4.19\ \frac{\text{m}}{\text{s}}$. This wind speed is the average wind speed in Las Cruces in March. Therefore, at $15\ \Omega$ each TEG will generate about 0.001W . This corresponds to 0.54W for 536 TEGs. Using manufacturer data, the power a single TEG can generate with a 20°C temperature difference is 0.25W . This corresponds to 135W for 536 TEGs. The estimated max power output of the solar panel used in the experiment was 300W so the TEGs would increase the total power output by 45%. The cooling effects as a result of the TEGs requires further testing.

Conclusions and Recommendations:

Based off the various test conducted, pairing TEGs with fins provided the greatest overall cooling and increased power output for the panel of the methods tested. TEGs with fins were able to produce an average of 12.1°C temperature difference between the front and back of the panel. With the full panel covering of 536 TEGs, it is estimated the panel will also produce an addition 16.7M kWh/yr per panel. However, from an economics standpoint, no cooling method tested would prove to be more financially viable than purchasing additional solar panels. The additional profits per year from installing TEGs on a $10\ \text{MW}$ solar array would be just shy of $\$2.2\ \text{million/year}$. To produce those same profits from the purchase of more panels would require 19,320 panels. Purchasing this many panels has a payback period of just under 6 years while installing TEGs would have a payback period of nearly 31 years. In order to make TEGs with fins a more financially viable option, a custom design would be required for the TEGs in order to cover the back for less than $\$1,500$. Installation cost would also need to be reduced by including the TEGs and fins for install during the manufacture of the panels. Though cooling solar panels can lead to increases in power production and utilizing the heat during the cooling process can attribute to additional power production, current equipment costing, and panel production methods make cooling panels unviable. Cooling solar panels at this time is not considered to be a financially sound alternative to purchasing additional panels to meet power needs.

Acknowledgements:

The Solarbacks would like to thank Harold Watson and Dearl Peachee for their assistance in experimental proceedings. The Solarbacks would also like to thank Shine Solar for their donations of 2 solar panels so the team could conduct the test needed to draw the conclusions of this study. The Solarbacks would also like to thank Ozark Electric for the opportunity to tour their solar facilities to gain a better understanding of the workings of large-scale solar operations.

References:

1. Energy demands: Three Drivers. ExxonMobil. <https://corporate.exxonmobil.com/Energy-and-environment/Looking-forward/Outlook-for-Energy/Energy-demand#threeDrivers>. Accessed February 6, 2020.
2. C.B.Honsberg and S.G.Bowden, "Photovoltaics Education Website," www.pveducation.org, 2019. Accessed February 6, 2020.
3. I. Tari, M. Mehrtash, Natural convection heat transfer from inclined plate-fin heat sinks, *Int. J. Heat Mass Transfer* 56 (2013) 574-593. doi:10.1016/j.ijheatmasstransfer.2012.08.050
4. A. Shukla, K. Kant, A. Sharma, P.H. Biwole, Cooling methodologies of photovoltaic module for enhancing electrical efficiency: A review, *Sol. Energy Mater. Sol. Cells* 160 (2017) 275-286. doi:10.1016/j.solmat.2016.10.047
5. E. Cuce, T. Bali, S.A. Sekucoglu, Effects of passive cooling on performance of silicon photovoltaic cells, *Int. J. Low-Carbon Technol.* 6 (2011) 299–308.
6. A. El Mays, R. Ammar, M. Hawa, M.A. Akroush, F. Hachem, M. Khaled, et al., Improving photovoltaic panel using finned plate of aluminum. *En. Proced.* 119 (2017) 812-7. doi:10.1016/j.egypro.2017.07.103.
7. S. Nižetić, A.M. Papadopoulos, E. Giama, Comprehensive analysis and general economic-environmental evaluation of cooling techniques for photovoltaic panels, Part I: passive cooling techniques. *Energy Convers. Manag.* 149 (2017) 334e354. doi:/10.1016/j.enconman.2017.07.022
8. S. Dubey, G.N. Tiwari, Analysis of PV/T flat plate water collectors connected in series, *Sol. Energy*, 83 (2009) 1485-98. doi:10.1016/j.solener.2009.04.002.
9. K. A. Moharram, M. S. Abd-Elhady, H. A. Kandil, and H. El-Sherif, "Enhancing the 741 performance of photovoltaic panels by water cooling," *Ain Shams Eng. J.*, 4 (2013) 869-742.
10. J. Siecker, K. Kusakana, B.P. Numbi, A review of solar photovoltaic systems cooling technologies, *Renewable and Sustainable Energy Reviews.* 79 (2017) 192–203.
11. S. Odeh, M. Behnia, Improving photovoltaic module efficiency using water cooling, *Heat Transfer Eng.*, 30 (2009) 499-505.
12. C.Y. Mah, B.H. Lim, C.W. Wong, M.H. Tan, K.K. Chong, A.C. Lai, Investigating the performance improvement of a photovoltaic system in a tropical climate using water cooling method, *En. Proc.* 159 (2019) 78-83. doi:10.1016/j.egypro.2018.12.022.
13. S. Nižetić, E. Giama, and A. M. Papadopoulos, Comprehensive analysis and general economic environmental evaluation of cooling techniques for photovoltaic panels, Part II: Active cooling techniques, *Energy Convers. Manag.* 155 (2017) 301–323.
14. T.T. Chow, W. He, J. Ji, Hybrid photovoltaic-thermosyphon water heating system for residential application. *Sol Energy* 80 (2006) 298–306. doi:10.1016/j.solener.2005.02.003.

15. C. Yuan, G. Chen, L. Li, J.A. Damasco, Z. Ning, H. Xing, T. Zhang, L. Sun, H. Zeng, A.N. Cartwright, P.N. Prasad, H. Ågren, Simultaneous multiple wavelength upconversion in a core-shell nanoparticle for enhanced near infrared light harvesting in a dye-sensitized solar cell, *ACS Appl. Mater. Interfaces* 6 (2014) 18018-18025.
16. L. Zhu, A.P. Raman, S. Fan, Radiative cooling of solar absorbers using a visibly transparent photonic crystal thermal blackbody. *Proc. Natl Acad. Sci. USA* 112 (2015) 6–11.
17. B. Zhao, M. Hu, X. Ao, Q. Xuan, G. Pei, Comprehensive photonic approach for diurnal photovoltaic and nocturnal radiative cooling, *Sol. En. Mat. Sol. Cells* 178 (2018) 266-272. doi:10.1016/j.solmat.2018.01.023.
18. A.R. Gentle, G.B. Smith, Is enhanced radiative cooling of solar cell modules worth pursuing?, *Sol. En. Mat. Sol. Cells* 150 (2016) 39-42. doi:10.1016/j.solmat.2016.01.039.
19. P.T. Tsilingiris, Comparative evaluation of the infrared transmission of polymer films, *Energy Convers. Manage.* 44 (2003) 2839–2856. doi:10.1016/S0196-8904(03)00066-9.
20. S. Sargunanathan, A. Elango, and S. T. Mohideen, Performance enhancement of solar photovoltaic cells using effective cooling methods: A review, *Ren. and Sust. En. Rev.* 64 (2016) 382-393
21. A.S. Jadhav, S.A. Patil, Two phase thermosyphon – A review of studies, *Int. J. of Eng. Sci. Res. Tech.* 5 (2016) 193-205.
22. A. Akbarzadeh, T. Wadowski, Heat pipe-based cooling systems for photovoltaic cells under concentrated solar radiation, *Appl. Therm. Eng.* 16 (1996) 81–7.
23. A. Hasan, S.J. McCormack, M.J. Huang, B. Norton, Evaluation of phase change materials for thermal regulation enhancement of building integrated photovoltaics, *Sol. En.* 84 (2010) 1601-12. doi:10.1016/j.solener.1010.06.010.
24. L. Lin, Y.F. Zhang, H.B. Liu, J.H. Meng, W.H. Chen, X.D. Wang, A new configuration design of thermoelectric cooler run by thermoelectric generator, *Appl. Therm. Eng.* 160 (2019) doi:10.1016/j.applthermaleng.2019.114087.
25. E.A. Man, E. Schultz, L. Rosendahl, Chapter 18: Thermoelectric generator power converter system configurations: A review, *Proc. 11th Eur. Conf. on Thermo.* (2013) doi:10.1007/978-3-319-07332-3_18.
26. Schedule No. 24 General Service Rate. El Paso Electric Company. https://www.epelectric.com/files/html/Rates/TX_Tariff_Schedules/TX_Sch_No._24_General_Service.pdf. Accessed March 13, 2020.
27. K.H. Do, T.H. Kim, Y.S. Han, B.I. Choi, M.B. Kim, General correlation of a natural convective heat sink with plate fins for high concentrating photovoltaic module cooling, *Sol. En.* 86 (2012) 2725-34.
28. I. Carvajal-Mariscal, F. Sanchez-Silva, G. Polupan, Development of high efficiency two-phase thermosyphons for heat recovery, *Heat Exchangers – Basic Design Applications* (2012) 97-116. doi:10.5772/32693
29. M. Benganem, A.A. Al-Mashraqi, K.O. Daffalah, Performance of solar cells using thermoelectric module in hot sites, *Ren. En.* 89 (2016) 51-59.