

COLLAGEN ORIENTATION AND WAVINESS WITHIN THE VEIN WALL

JAN VESELY^{*}, LUKAS HORNY^{*}, HYNEK CHLUP^{*} AND RUDOLF ZITNY^{*}

^{*} Faculty of Mechanical Engineering
Czech Technical University in Prague
Technicka 4, 16607 Prague, Czech Republic
e-mail: Jan.Vesely1@fs.cvut.cz, www.biomechanika.cz/departments/20

Key words: Vena cava, Blood vessel architecture, Collagen, Fiber orientation distribution, Anisotropy

Summary. This paper presents the analysis of the internal structure and organization of components within the vein wall. Dominant directions and statistical distribution of collagen fibers undulation were investigated in digitalized histological sections from media and adventitia layer of human vena cava inferior.

Orientations of collagen fibers were analyzed by the in-house developed software Binary Directions. Digital images were converted to binary pixel maps with collagen fibers enhanced. The software employs an algorithm of the *Rotation Line Segment* to determine significant directions in digital images. It was found that collagen fibers are aligned in circumferential direction in media layer. Contrary to that in adventitia fibers are arranged in longitudinal direction. In contrast to elastic artery, no evidence of helically reinforced composite structure was found.

Second goal was to find out which statistical distribution, usually using in structural models (Gamma, Beta or Weibull), fits to the undulation distribution of collagen fibers. Collagen waviness was characterized by a probability density function for the strain necessary to straighten a crimped fiber. Computer analysis of the end-to-end and contour length was performed using Nis-Elements software. The statistical analysis suggests that the waviness of collagen fibers is identical in media and adventitia. It was found that the average strain necessary for straightening collagen fibers is 0.24 ± 0.11 (\pm SD) and that all three probability distributions fit straightening strains very well and can be used in structural models.

1 INTRODUCTION

In recent years a big increase in interest in constitutive models of biological tissues based on their microstructure was noticed. Biological tissues comprise a large number of different cells, matrix proteins and bonding elements. For effective development of structural constitutive models, good understanding of internal structure and organization of the material is necessary.

According to [3], the gross mechanical response of soft tissues is attributed to the mechanical properties and geometrical arrangement of the tissues components: fiber families (collagen and elastin) and ground substance. The fibers are oriented in different directions and

have different undulation (waviness) in the tissue. Upon loading, the fibers lose their waviness and start to carry a load [1]. It is assumed that gradual recruitment of collagen fibers under a deformation leads to a typical non-linear behavior of soft tissues.

A number of investigators have analyzed the fiber orientation and crimp distribution to implement them into structural mechanical models [1, 3, 6, 9]. This paper deals with histomorphometrical analysis of internal structure of the vein wall. Dominant directions and distribution of undulation of collagen fibers were investigated in histological sections from media and adventitia layer of human vena cava.

2 METHODS – COLLAGEN FIBERS ORIENTATION

Histological sections were obtained from abdominal vena cava inferior. The orientation of sections and the definition of collagen fiber angle β are shown in Fig. 1. Specimens were routinely fixed in 10% buffered formaldehyde, embedded in paraffin, cut, and stained with orcein. Digitalized images were evaluated by in house developed software BinaryDirections with implemented algorithm of the *Rotating Line Segment* (RoLS).

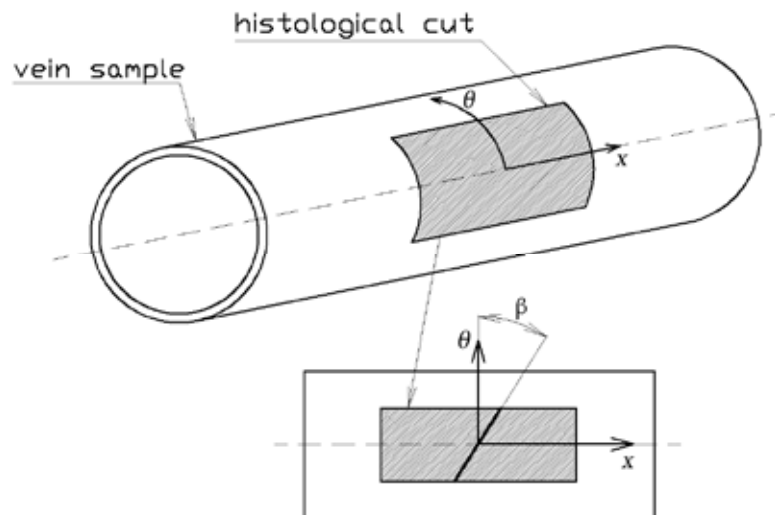

Figure 1: Definition of the angle β .

Digital images were converted to binary pixel maps by thresholding of RGB filter which transforms stained collagen to white (logical unity) pixels and non-collagen components to black (logical zero) pixels. Binary conversion was realized by software NIS-Elements (NIKON INSTRUMENTS INC., USA, New York). Final orientations were obtained by averaging results from 5 histological sections from each layer (media and adventitia).

2.1 ROLS Algorithm

Exact mathematical formulation of the *Rotating Line Segment* (RoLS) was described in details in [2]. Histological section converted to binary pixel map can be viewed as the matrix with elements uniquely corresponding to pixels. Elements are equal to either zero or unity depending on the pixel color. The algorithm explores neighborhood of each non-zero pixel

(called target pixel) in the image using the rotating line segment. The neighborhood of the target pixel is a square represented by $N \times N$ submatrix \mathbf{M} , where N is an odd integer. Now, imaginary line segment is rotated step by step around the midpoint of the neighborhood. Each rotating step, β , of the line segment is represented via additional $N \times N$ matrix, say \mathbf{L}^β . \mathbf{L}^β has only non-zero elements in positions corresponding to the rotated line segment.

The aim of RoLS is to find dominant directions in an image. This procedure is based on so-called matching coefficient, $C(\beta)$. The matching coefficient is normalized number of non-zero pixels shared with the line segment and neighborhood of target pixel at given rotating step β :

$$C(\beta) = \frac{\sum_{i=1}^N \sum_{j=1}^N M_{ij} \cdot L_{ij}^\beta}{Nl} \quad (1)$$

$$l = \sum_{i=1}^N \sum_{j=1}^N L_{ij}^\beta \quad (2)$$

Normalization procedure is related to length of square neighborhood N and number of pixels creating the line segment, l .

There are two ways how to obtain relevant information about directional frequency of non-zero (collagen) pixels in the neighborhood of target pixel. First, one can reduce information from pixels neighborhood to the most frequent angle (rotation step with the greatest $C(\beta)$) and create histogram over the entire image (all target pixels). The second way is to consider $C(\beta)$ as a function of β in each pixel and averaged these functions through all target pixels. Obtained results may depend on N , therefore analyses should be repeated with different values of N and the N should be chosen with respect to characteristic dimensions of structures observed in images (eyes of expert are the best optimization tool, as usually).

Image-based determination of tissue architecture may employ many kinds of algorithms and mathematical methods. Presented algorithm, RoLS, is similar to the so-called volume orientation (VO) method which operates with point grid and seeks for the longest intercept in target volume. VO was first described in Odgaard et al. [4]. It was found to be suitable within an analysis of bone architecture. Interested reader can track details in [5] or recent review [7].

2.2 Test images

Test binary images were evaluated by BinaryDirections before processing histological sections to verify that this software is a suitable instrument for fibers orientation analysis. Selected tested images and results are shown in Fig. 2.

Evaluating of testing images showed that software BinaryDirection is convenient for determining dominant directions in binary image.

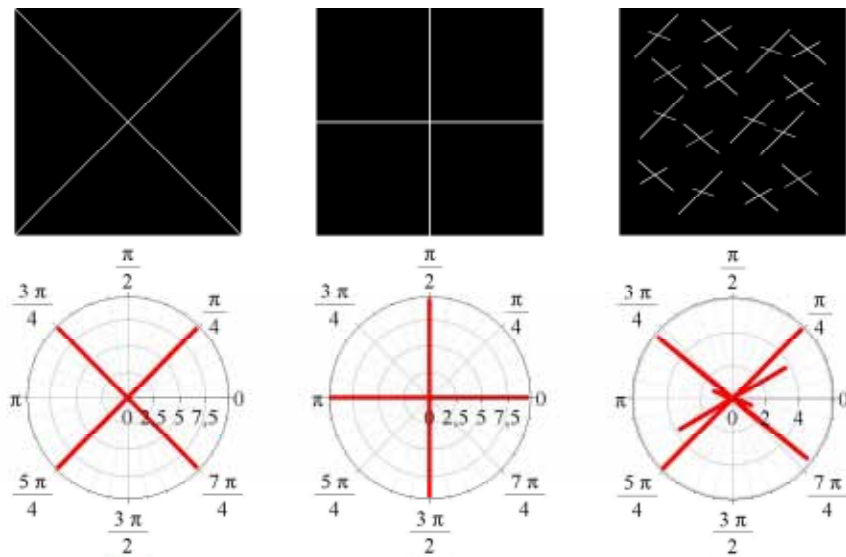

Figure 2: Tested binary images and empirical probability density for evaluated images.

3 METHODS – COLLAGEN FIBERS UNDULATION

The fiber waviness was characterized statistically by a probability density function for the strain ε_s necessary to straighten a crimped fiber, Fig. 3.

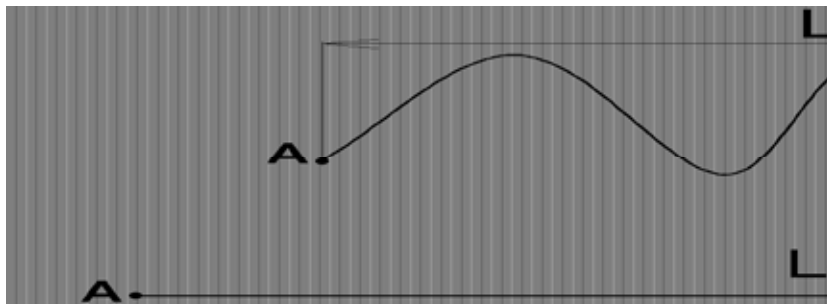

Figure 3: Axial fiber strain ε_s .

Strain ε_s is defined:

$$\varepsilon_s = \frac{L_s}{L_o} - 1, \quad (3)$$

where L_o is end-to-end length of the fiber, and L_s is the contour length of the fiber.

Computer analysis of the end-to-end and contour length was performed manually using NIS-Elements (NIKON INSTRUMENTS INC., USA, New York), Fig. 4.

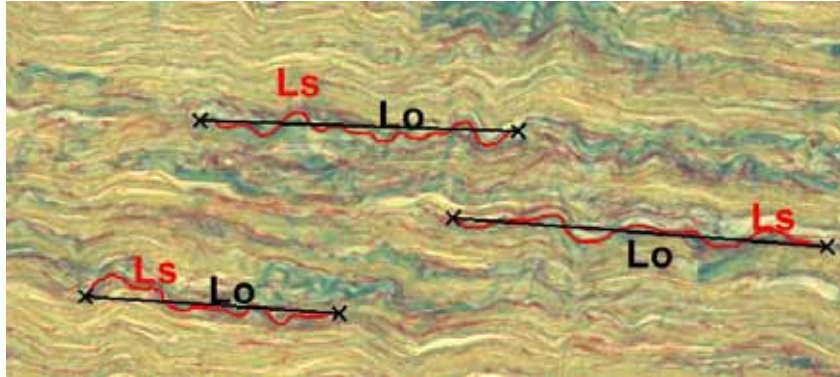

Figure 4: Digital image from media. Measuring of lengths L_o and L_s by Nis-Elements.

Statistical computations were performed in Maple 13 (Maplesoft, Canada, Waterloo). The aim was to find out suitable statistical model for ε_s probability distribution. Following distributions were considered:

Weibull distribution

$$f(\varepsilon_s; \lambda, k) = \frac{k}{\lambda} \left(\frac{\varepsilon_s}{\lambda} \right)^{k-1} e^{-\left(\frac{\varepsilon_s}{\lambda} \right)^k}, \quad (4)$$

where $k > 0$ is the shape parameter and $\lambda > 0$ is the scale parameter of the distribution.

Beta distribution

$$f(\varepsilon_s; \alpha, \beta) = \frac{\varepsilon_s^{\alpha-1} (1-\varepsilon_s)^{\beta-1}}{B(\alpha, \beta)}, \quad (5)$$

where B is Beta function and $\alpha, \beta > 0$ are shape parameters.

Gamma distribution

$$f(\varepsilon_s; k, \theta) = \varepsilon_s^{k-1} \frac{e^{-\frac{\varepsilon_s}{\theta}}}{\theta^k \Gamma(k)}, \quad (6)$$

where Γ is Gamma function, $k > 0$ is the shape parameter and $\theta > 0$ is the scale parameter. In all distributions $\varepsilon_s > 0$.

4 RESULTS

4.1 Collagen fibers orientation

Fig. 5 – Left panel shows an example of digital image from media and definition of angle β . The same image converted to a binary pixel map is in Fig. 5 (Right panel). The sensitivity

of the results to the length of rotating line segment is shown in Fig. 6. It was found that the usage of different lengths of the rotating segment $N \in \{61 \text{ pix}, 121 \text{ pix}, 181 \text{ pix}, 201 \text{ pix}\}$ have not significant effect on the distribution of angle β . Final results for images processed in BinaryDirections from media and adventitia are shown in Fig. 7.

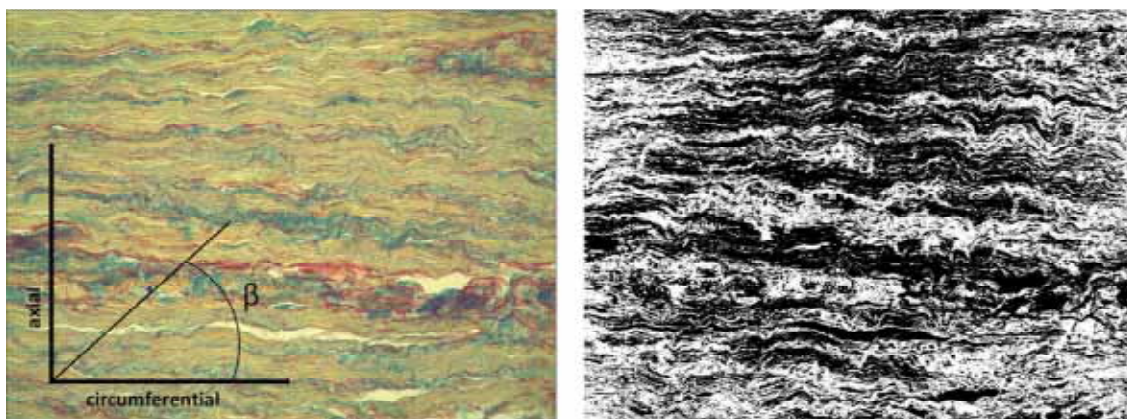

Figure 5: **Left:** Histological section from media layer stained with orcein. Collagen fibers are stained in blue. **Right:** Binary pixel map created from histological image in left panel. White color represents collagen fibers.

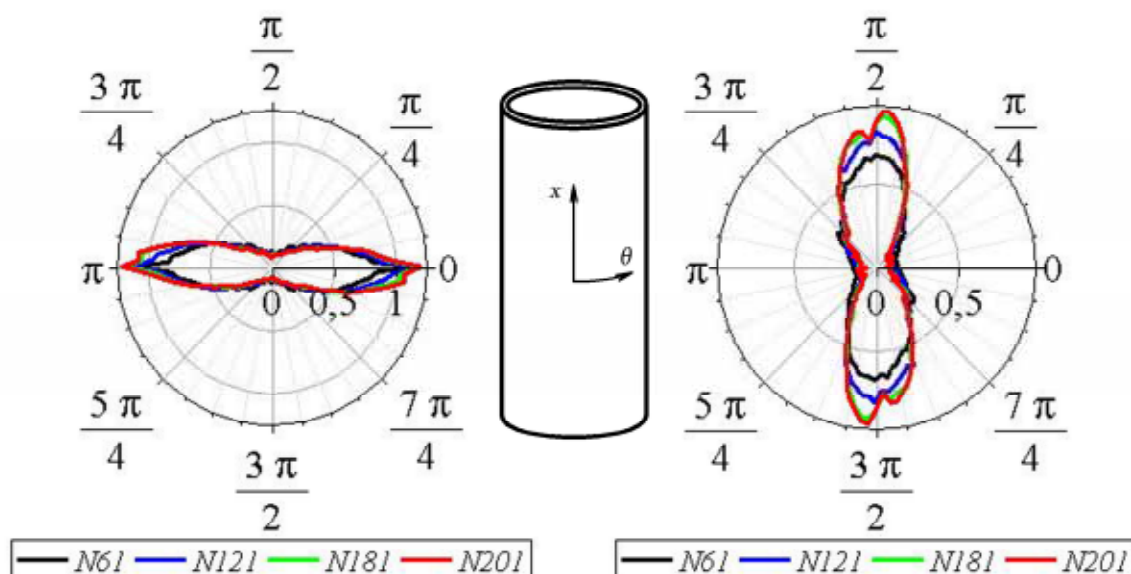

Figure 6: **Left:** Empirical probability density function for selected section from media for 4 lengths of line segment. **Right:** Empirical probability density function for selected section from adventitia for 4 lengths of line segment.

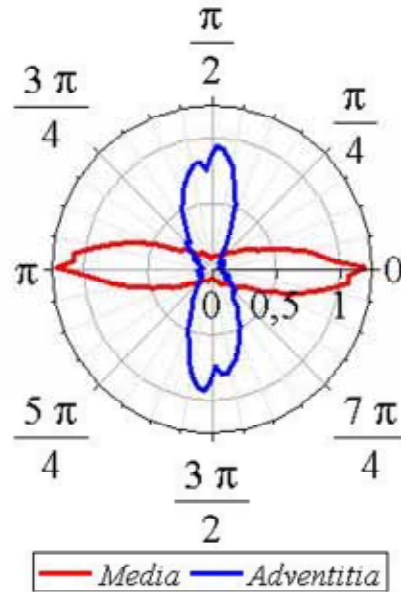

Figure 7: Resulting averaged empirical probability density function for axial cut from media (red) and adventitia (blue).

It was found that collagen fibers in media are aligned in circumferential direction. Contrary to that fibers in adventitia are oriented in longitudinal direction.

4.2 Collagen fibers undulation

Strains ε_s were evaluated for media and adventitia separately. The Chi-Square Goodness-of-fit test was performed to decide if the data may be considered as drawn from one statistical sample. The test suggested that it is possible to merge the data from media and adventitia together (P -value = 0.74).

The histogram of obtained strains necessary for the straightening and the fit of experimental data by the Weibull, Beta and Gamma probability distribution, Fig. 9. The average value of straightening strain is $\varepsilon_s = 0.24 \pm 0.1$ (\pm SD). It was found that all three probability distributions fit experimental strains very well. The best fit was achieved with the Beta distribution ($\alpha = 4.20$, $\beta = 12.58$).

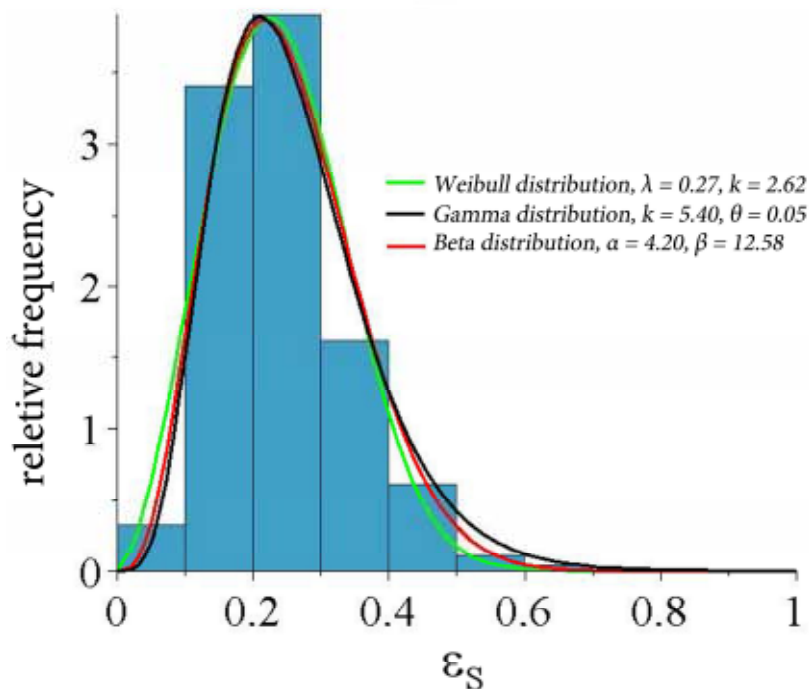

Figure 8: Fitting of obtained strains ε_s (from media and adventitia) by Weibull, Beta and Gamma probability distribution.

5 DISCUSSION

The analysis of the histological images from human abdominal vena cava showed that collagen fibers in media are oriented in the circumferential direction with very compact organization of the collagen. Conversely, in adventitia collagen is aligned with the longitudinal direction with sparse arrangement of fibers.

This arrangement of components within the vein wall differs from arrangement for example in aorta. This may be a consequence of another type of loading, where skeletal muscles are helping venous return mechanism. There is also lower blood pressure in veins than in arteries. Our results suggest that collagen fiber form unidirectional structure in each layer of the vein.

The distribution of undulation of collagen fibers in human vena cava can be fitted by all three considered statistical distributions. The Beta distribution fits the best. The statistical analysis suggests that the waviness of collagen fibers is identical in media and adventitia. It was found that the average strain necessary for straightening collagen fibers is 0.24. These results differ from findings by Sokolis [8], who investigated the waviness of medial collagen in vena cava inferior in New Zealand rabbits (averaged $\varepsilon_s = 0.57$). It suggested species-dependent waviness.

ACKNOWLEDGEMENTS

This work has been supported by the Czech Ministry of Education project MSM6840770012; Czech Science Foundation GA106/08/0557; and Grant Agency of the Czech Technical University in Prague SGS10/247/OHK2/3T/12.

REFERENCES

- [11] De Vita, R. Structural constitutive models for knee ligaments. Dissertation thesis, University of Pittsburgh (2005)
- [2] Horny, L., Hulan, M.; Zitny, R.; Chlup, H.; Konvickova, S.; Adamek, T. Computer-Aided Analysis of Arterial Wall Architecture. *IFMBE Proceedings*, vol. 25/4, World Congress on Med. Phys. & Biomed. Eng., Munich, Germany (2009) 1494–1497
- [3] Lanir, Y. Constitutive equations for fibrous connective tissues. *Journal of Biomechanics* (1983) **16**:1–12
- [4] Odgaard, A.; Jensen, E.B.; Gundersen, H.J.G. Estimation of structural anisotropy based on volume orientation. A new concept. *Journal of Microscopy* (1990) **157**:149-162
- [5] Odgaard, A. Three-dimensional methods for quantification of cancellous bone architecture. *Bone* (1997) **20**:315-328
- [6] Sachs, M.; Sun, W. Multiaxial Mechanical Behavior of Biological Materials. *Annual Review of Biomedical Engineering* (2003) **5**:251-284
- [7] Sander, E.A.; Barocas, V.H. Comparison of 2D fiber network orientation measurement methods. *Journal of biomedical materials research. Part A* (2009) **88A**:322-331
- [8] Sokolis, P. D. Passive mechanical properties and constitutive modeling of blood vessels in relation to microstructure. *Med Biol Eng Comput* (2008) **46**:1187–1199
- [9] Zullinger, M.; Fridez, P.; Hayashi, K.; Stergiopoulos, N. A strain energy function for arteries accounting for wall composition and structure. *Journal of Biomechanics* (2003) **37**:989-1000