

# DESIGN OF ON-FARM RESERVOIR FOR IRRIGATION WATER SUPPLY IN KARKATA (JHARKHAND, INDIA)

**Mireia López Pérez**

Amrita Id: CB.EN.P2SCE17062

**Supervisor:** Dr B. Soundharajan

Master's dissertation submitted in order to obtain the academic degree of Master of Industrial Engineering from the Polytechnic University of Catalonia, UPC.

**Live-in-Labs**<sup>®</sup>  
AN INITIATIVE BY AMRITA UNIVERSITY

Department of Civil Engineering  
Amrita Vishwa Vidyapeetham  
Coimbatore  
Academic year 2018-2019





## ACKNOWLEDGEMENTS

This section of my thesis is of great importance to me because this project would remain incomplete if I don't thank everyone who helped me sail through it.

For sure I should start with thanking my university, Polytechnic University of Catalonia (UPC), for offering me a mobility place like this in India and, secondly, to Amrita Vishwa Vidyapeetham University, for letting me do a project like this in the Live-in-Labs program, under the guidance of Dr B. Soundharajan, who always allowed this thesis to be my own work, but guided me in the right direction whenever needed. All his knowledge, orientation and way of working have been fundamental to be able to throw this project forward.

I would also like to thank Mr Souresh Cornet, from Live-in-Labs program, for all the support that I have always obtained from him, not only with the project but also with all the matters that I have needed during my stay in India. And to Mr Krishna Nandan, from Live-in-Labs also, who helped us during our stay at Karkata and was a great support during the first phase of the project.

To Mr Deepak Suresh Varma, Mr Sidharth K A, Mr Aswin R Raj and Mr Vishakh Raja, the biggest thank you for letting me be part of this project and, above all, your team and families. I have felt like at home since the first day and, although it has not always been easy, we have managed to move forward this project together. Best of luck and success for all the work that is yet to come.

This would be incomplete without expressing my love and respect for my family, who were a constant source of motivation and energy, and especially to Lluís, who from the other side of the world has been an unconditional support every day. They were unfailing encouragement throughout my project work and I couldn't be more thankful.

I would like to express my humble gratitude to each and everyone whom I could work with during this project.

## ABSTRACT

This project tries to solve the **water crisis** that is suffering the village of **Karkata**, in Jharkhand, especially during the summer season. Getting a good understanding of the problem that most of the inhabitants of the village are suffering is the first and most important point that has to be reached, and this will be achieved by doing a visit to the village and undertaking several **co-design** workshops, a participatory technique that allows the requirements to be obtained directly from the main users so that they can remain at the centre of the solution.

Once the problem has been defined, it is intended to design the best solution to improve this situation of water for **irrigation** at Karkata. For this purpose, the first thing that has been done is a detailed study of the physical characteristics of the area, a very important point since it allows us to better understand all its resources and how they can be sustainably exploited. In addition, a detailed study of the different crops has been carried out, mostly those which are available in the region, in order to obtain their water irrigation needs.

As a result of all these studies, a first proposal of design is given in order to solve this problem, based on a **rainwater harvesting** system. In order to be a totally sustainable proposal and according to the villager's capacities and needs, the design includes all the sizing of the installation for both the tank that is going to be used for storing the rainwater and the hydraulic and electrical systems.

In addition to this study of the design, this project includes a detailed budget including consumables, permanent equipment and manpower, among others. It has been considered that the investment should be made to implement **2 tanks** in different regions of Karkata, to be able to prove that the design works under different conditions.

Although this budget may seem initially high, it must be taken into account that the **Government of India** is investing in the improvement of the conditions of farmers in the rural areas of the country. Specifically, Scheme n°6 of the Agricultural Engineering Schemes under Agricultural Engineering Department "Rain Water Harvesting and Runoff Management Program", provides benefits of 100% grants on the cost of works taken in land communities. That is why it is believed that when it comes to making this project, the fact of being able to benefit from the aid that the Government of India is granting is of great importance.

Keywords: *water crisis, Karkata, co-design, irrigation, rainwater harvesting, 2 tanks, Government of India.*

## TABLE OF CONTENTS

ACKNOWLEDGEMENTS .....	- 2 -
ABSTRACT .....	- 3 -
1. INTRODUCTION.....	- 6 -
1.1. MOTIVATION .....	- 8 -
1.2. OBJECTIVES .....	- 9 -
1.3. CONTEXTUALIZATION OF THE PROJECT .....	- 10 -
1.3.1. Country: India .....	- 10 -
1.3.2. State: Jharkhand .....	- 11 -
1.3.3. District: Ranchi / Village: Karkata.....	- 11 -
2. CASE STUDY .....	- 13 -
2.1. CURRENT SITUATION .....	- 13 -
2.1.1. Education.....	- 14 -
2.1.2. Water .....	- 15 -
2.2. OBJECTIVE SITUATION .....	- 19 -
2.2.1. Crops study.....	- 20 -
2.3. PHYSICAL CHARACTERISTICS OF THE AREA .....	- 22 -
2.3.1. Temperature .....	- 22 -
2.3.2. Rainfall .....	- 23 -
2.3.3. Solar radiation .....	- 24 -
2.3.4. Wind.....	- 26 -
2.3.5. Soil .....	- 27 -
3. DESIGN ALTERNATIVES .....	- 29 -
3.1. RUNOFF WATER.....	- 30 -
3.2. IRRIGATION WATER NEEDS .....	- 31 -
3.2.1. Effective precipitation (Pe) .....	- 32 -
3.2.2. Crop water needs (ET <sub>crop</sub> ) .....	- 33 -
3.2.3. Irrigation water needs (IN).....	- 37 -
3.3. SIZING OF INSTALLATION.....	- 40 -
3.3.1. Water tank + wall .....	- 43 -
3.3.2. Hydraulic System .....	- 44 -
3.3.3. Electric System.....	- 51 -

3.4. TANK 3D DESIGN AND INSTALLATION DIAGRAM.....	- 56 -
4. BUDGET.....	- 58 -
5. CONCLUSIONS.....	- 60 -
6. FUTURE WORK.....	- 62 -
REFERENCES.....	- 63 -
ANNEXES.....	- 65 -
I. Field Journal.....	- 66 -
Target group specifics.....	- 66 -
Daily activities.....	- 67 -
Output.....	- 77 -
II. Irrigation water needs Excel.....	- 79 -
III. Water tank + wall drawing.....	- 80 -

## 1. INTRODUCTION

A scarce natural resource, **water** is fundamental to life, livelihood, food security and sustainable development. India has more than 18% of the world's population but has only 4% of world's renewable water resources and 2.4% of world's land area, and there are further limits on utilizable quantities of water owing to uneven distribution over time and space [1].

In addition, there are challenges of frequent floods and droughts in one or the other part of the country. With a growing population and rising needs of a fast developing nation as well as the given indications of the impact of climate change, availability of utilizable water will be under further strain in future with the possibility of deepening water conflicts among different user groups.

There is a low consciousness about the scarcity of water and its life-sustaining and economic value results in its mismanagement, wastage, and inefficient use, as also pollution and reduction of flows below minimum ecological needs. In addition, there are inequities in distribution and lack of a unified perspective in planning, management and use of water resources.

The present scenario of water resources and their management in India has given rise to several concerns, important amongst them are:

- Large parts of India have already become water stressed. Rapid growth in demand for water due to population growth, urbanization and changing lifestyle pose serious challenges to water security.
- Issues related to water governance have not been addressed adequately. Mismanagement of water resources has led to a critical situation in many parts of the country.
- There is wide temporal and spatial variation in the availability of water, which may increase substantially due to a combination of climate change, causing deepening of a water crisis and incidences of water-related disasters, i.e., floods, increased erosion and increased frequency of droughts, etc.
- Access to safe water for drinking and other domestic needs still continues to be a problem in many areas.
- Groundwater, though part of the hydrological cycle and a community resource, is still perceived as an individual property and is exploited inequitably and without any consideration to its sustainability leading to its over-exploitation in several areas.
- Water resources projects, through multidisciplinary with multiple stakeholders are being planned and implemented in a fragmented manner without giving due consideration to optimum utilization, environment sustainability and holistic benefit to the people.

- Grossly inadequate maintenance of existing irrigation infrastructure has resulted in wastage and under-utilization of available resources. There is a widening gap between the irrigation potential created and utilized.
- Growing pollution of water sources, especially through industrial effluents, is affecting the availability of safe water besides causing environmental and health hazards. In many parts of the country, large stretches of rivers are both heavily polluted and devoid of flows to support aquatic ecology, cultural needs and aesthetics.
- Access to water for sanitation and hygiene is an even more serious problem. Inadequate sanitation and lack of sewage treatment are polluting the water sources.
- Low consciousness about the overall scarcity and economic value of water results in its wastage and inefficient use.
- The lack of adequate trained personnel for scientific planning, utilizing modern techniques and analytical capabilities incorporating information technology constraints good water management.
- The public agencies in charge of taking water-related decisions tend to take these on their own without consultation with stakeholders, often resulting in poor and unreliable service characterized by inequities of various kinds.
- Characteristics of catchment areas of streams, rivers and recharge zones of aquifers are changing as a consequence of land use and land cover changes, affecting water resource availability and quality.

In this scenario, this project will try to solve this situation in the village of Karkata.



## 1.1. MOTIVATION

Live-in-Labs is a multidisciplinary experiential learning program that breaks classroom and lab barriers by applying learned theory in real-world settings, and this has been the main reason why I wanted to be part of this program.

Being able to apply all my knowledge acquired during all my years of studies carried out so far in a project that has a direct final application like this, is what boosts my motivation to give my 100%. Having the opportunity to directly live in a rural community like Karkata and co-design a solution with the help of the villagers to develop a change in their daily lives is truly fulfilling.

Finally, doing a project like this in India was a goal that I wanted to achieve, not only academically but also personally. Being able to live in a country like India, being so different to Spain, understanding the culture and traditions and, above all, understanding the way of working in the country, is something that I wanted to accomplish during my stay here.

## 1.2. OBJECTIVES

The main aim of this project is to understand the key problem of Karkata in relation to water through co-design workshops and develop the most appropriate solution for the identified problem.

The specific objectives of the project are:

- To conduct the co-design workshops at Karkata with the villagers in order to identify the key water problem of their livelihood.
- To study the basic features of agroclimate and current situation of the Karkata village.
- To develop the feasible alternatives to solve the irrigation water scarcity during the post-monsoon and summer seasons.
- To identify the most appropriate solution (in this study, on-farm reservoir has been found to be the best alternative for Karkata) and develop the detailed design along with budget estimate.

The structure of the thesis will follow the order mentioned in the specific objectives of this project, in order to follow a clear and understandable arrangement throughout the report.

## 1.3. CONTEXTUALIZATION OF THE PROJECT

### 1.3.1. Country: India

India is a country in South Asia, bounded by the Indian Ocean on the south, the Arabian Sea on the southwest and the Bay of Bengal on the southeast. It shares land borders with Pakistan to the west, China, Nepal and Bhutan to the northeast, and Bangladesh and Myanmar to the east.



Figure 1. Contextualization of India

With its more than 1.3 billion inhabitants, it is the second country in the world by population, with a life expectancy of 68.89 years [2]. India is composed of 29 states and 7 union territories, with its National Capital Territory, Delhi, with an estimated population of 18.6 million. The country's surface is of 3,287,263 km<sup>2</sup>, which places it in the seventh place among the most extensive countries of the planet.

Water resources in India include precipitation, surface water, and groundwater. The average annual rainfall in India is about 1,170 mm but this can vary considerably both temporarily and spatially because significant proportion of the annual rainfall occurs during the monsoon season (June-September), necessitating the creation of large storages for maximum utilization of the surface run-off.

Despite extensive river system, safe clean drinking water, as well as irrigation water supplies for sustainable agriculture, is in shortage across India, in part because it has, as yet, harnessed a small fraction of its available and recoverable surface water resources.

This project is focused on one of these 29 states, specifically, the state of Jharkhand, in the northeast of the country.

### 1.3.2. State: Jharkhand

Jharkhand is a state located in the north-eastern part of the country, with the capital of Ranchi, bordered by the states of Bihar to the north, Uttar Pradesh to the northwest, Chhattisgarh to the west, Odisha to the south and West Bengal to the east.



Figure 2. Contextualization of Jharkhand

This state has an area of 79,710 km<sup>2</sup> and a total population of 32,988,134 inhabitants, of whom 75% live in rural areas (32,988,134 inhabitants) and the other 25% live in urban areas.

Jharkhand has immense mineral resources, ranging from iron ore, coal, copper, mica, etc. Agriculture is another sector in the economy of Jharkhand which helps the livelihoods of the farmers. In this state, farmers produce several crops such as rice, wheat, maize, pulses, potatoes, and vegetables. The other important industries in this state are cottage industry and IT.

Within the state of Jharkhand, this project is focused on the village of Karkata, in the district of Ranchi.

### 1.3.3. District: Ranchi / Village: Karkata

This project is carried out in Karkata, a medium-sized village located in the district of Ranchi, with a total of 111 families residing. Karkata village has a total of 533 inhabitants, of which 276 are males and 257 are females [3]. The population of children with age 0-6 is 74, which makes up 13.88% of the total population of the village. Karkata has lower literacy rate compared to Jharkhand. In 2011, Karkata's literacy rate was 66.01% compared to 66.41% of Jharkhand and

compared also to 93.91% of Kerala, a southern state of India with the highest literacy rate of the country.

In Karkata village, out of the total population, 295 are engaged in agricultural work. 99.66% of the workers describe their work as Main Work (Employment or Earning more than 6 months) while 0.34% were involved in marginal activities providing a livelihood for less than 6 months. Nearly all of the villagers (99%) are owners or co-owners of agricultural lands of the village, where they cultivate crops, mainly paddy.

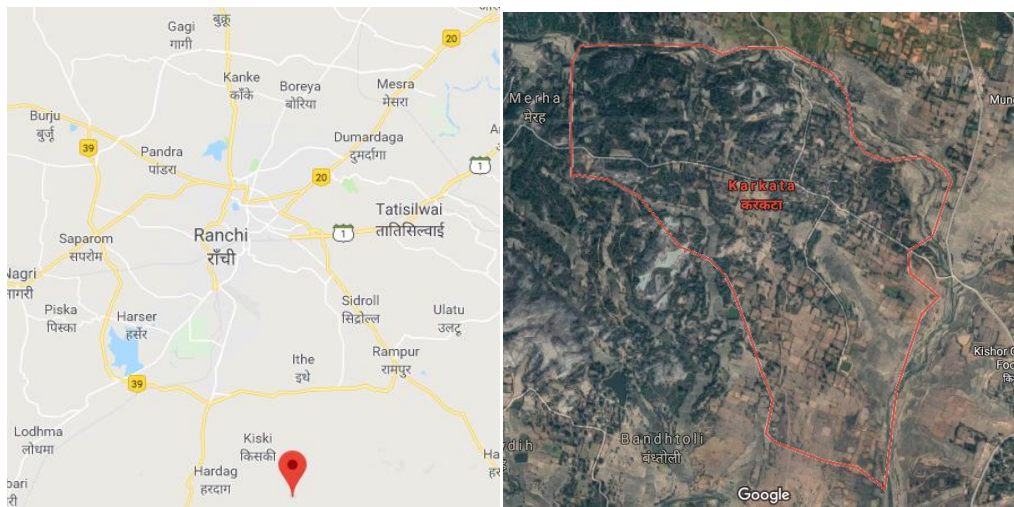

**Figures 3 and 4. Contextualization of Karkata**

Located about 25 kilometres away from Ranchi in Jharkhand, Karkata is a tribal village that rests on top of a hill. Predominantly a farming community, the people of Karkata is warm and welcoming. The village itself is part of a cluster of villages and is quite diverse in culture. On taking a walk through the village, one can see a beautiful marriage of old culture and new technology. Surrounded on two sides by the Tunju and Siri rivers respectively, the rest is covered by a rather dry forest.

Weather at Karkata is quite extreme. They experience intense heat during summers with temperatures peaking at 40 degrees Celsius and with the onset of monsoon (June to September), they receive an annual rainfall ranging between 110 centimetres to 140 centimetres.

## 2. CASE STUDY

### 2.1. CURRENT SITUATION

After spending a week in the village of Karkata during the month of March 2019, I feel I can describe in detail which is the current situation that the inhabitants of this village have to face. The field journal of the visit of Karkata has been added in the annex of this report ([Annex I](#)).

During the week that we spent in Karkata, we did several workshops as part of co-design. Co-design is a participatory technique that allows getting the requirements directly from the main users so that they can remain at the centre of the solution. This technique enables a wide range of people to make a creative contribution to the formulation and solution of a problem, and that is exactly what we did in Karkata.

The main purpose of carrying out co-design is to ensure that the stakeholders are on the same page as the researchers. In a project of this type, one of the main reasons why it might not succeed without co-design is because the researchers or developers might not understand the problem correctly or not take into account the end-user when designing the solution. If this happens, villagers, who have been living for decades dealing with this situation, may not find the utility to the solution provided and don't use it at all, which would lead to a total unsuccessful project and investment.

With these workshops that were carried out in Karkata, we understood which were the main problems that the villagers had to face in their everyday lives and we reached, together, a possible solution in a very conceptual phase, needing a deeper analysis and designing. With different tools such as mind map, group sketching, journey map and character profiles, we understood which problems the villagers were facing, which could be separated in water and education. Within the problems with water, they were separated into 2 types also: drinking water and water for agriculture.



Figures 5 and 6. Images of villagers of Karkata in the Tuition Centre while doing the co-design workshops

After understanding and getting detailed data and information from the villagers, we jointly came up to the conclusion that the main problem they had, and that is what this project will try to solve, is water for agriculture. Over 90% of the villagers work in agriculture and, during the harsh summer months and some winter months too, when the rainfall is in shortage, they are forced to take up daily wage jobs which include working on construction sites to support their household. This is mainly because of the lack of water resources during the summer season, when the climate is hot and the crops dry up under the sun, without proper irrigation.

This is a problem that affects the vast majority of the inhabitants of Karkata and has a direct effect on all the other problems detected beforehand. If they don't have water for agriculture, they don't have any job and they are forced to go to the city to find daily wage jobs, in which they earn very little amount of money each day, they have to pay for the transport themselves and, sometimes, they even don't find work and have to come back having paid for the transport. This type of situations leads them to a large number of hours out of their houses and away from their families, which they totally dislike, and leads them with lesser income in their household, which has a direct effect on their everyday lives and education of their children.

### **2.1.1. Education**

The villagers of Karkata are very much aware of the importance of good quality education for their children but the framework of the educational system in this village is not satisfactory. There is a government school located on the way to the village which provides elementary education for the kids. There are five classes in the school from first standard to fifth standard and the school has 31 students, but only two teachers are employed by the government to take care of these kids.

As one can notice, the student-teacher ratio is poor. It is very difficult for just two teachers to manage five classes and the villagers are not happy with the quality of education rendered in the school. That is the main reason why some of them (the ones that can afford it, which is a small part of the inhabitants) send their kids to other private schools which are located far away. Some of them even stay in hostels in nearby towns to study in private English schools. Once the students complete primary education there is no scope for continuing higher education in the village as Karkata lacks higher secondary schools. Nearest high school is in Tunju which is 7 km from the village.

The subjects taught in the primary school in Karkata include Hindi, English, Maths, Science and Social studies. The school was started 12 years ago and over the years the number of dropouts has been increasing, especially when it comes to girls. The students are provided with study materials and uniform, and they also get mid-day meals which are a part of the government

scheme. The classrooms are quite spacious and ventilated and toilets facilities are also provided. There is also one Tuition Centre inside the village which was set up by Mata Amritanandamayi Math and tuitions for classes 5-9 are taken. There is only one teacher, named Govind, who is a volunteer of Amrita Seva.



Figures 7 and 8. On the left, image of the government school. On the right, image of a class we attended in the Tuition Centre

### 2.1.2. Water

The village of Karkata faces numerous issues when it comes to its water resources. When temperatures soar, water levels in wells get lower and the river dries up even further. The extreme heat and dryness leading to a drought-like condition where dehydration is at large. Out of the many wells in the village, only three provide water suitable for drinking. The other wells in the village contain water which is unfit to drink but can be used for other purposes.

#### a) *Drinking water*

These drinking water wells are spread throughout the village and villagers need to walk long distances, carrying pots on their heads, to collect water. The ladies of the house are usually the ones who are sent out to collect water. An average family in Karkata (6 people) would require seven to eight pots of drinking water which would amount to about 60 litres of water a day. This would mean that the lady of the house would have to make at least four trips to the drinking water well, carrying pots of water, daily. Such physically demanding work tends to add extra strain to the ladies. These wells do not have pulleys and hence the women are forced to bend down and use up all their strength to draw water.





**Figures 9 and 10. Images of ladies of the village taking water from the well and transporting the pots in their heads**

Karkata has a number of hand pumps throughout the village but the water that comes from these pumps is usually muddy and unfit to drink. One of the hand pumps in the village has even been fitted with what looks like a fluorine filter but it has been out of commission for a while. When enquired, the villagers claim that they do not like the taste of water that comes from those bore wells. These hand pumps are used for other activities like washing utensils, bathing and even washing clothes.

The village of Karkata is bordered by rivers on two sides, the Tunju and the Siri rivers. Despite this being the case, these rivers don't have a lot of water all year long due to poor water management. The water from these rivers tends to just wash away or percolate into the ground, rendering the river with just pools of water. The villagers use the river for bathing and washing purposes because that murky water cannot be drinkable by human beings.

#### *b) Water for agriculture*

More than 90% of the people in Karkata depend on agriculture as their primary source of income. They grow a variety of crops, with paddy taking up a large share during the rainy season, and some vegetables during winter/summer season. Crops are sown prior to the monsoon months and harvested later in the year. Most of their produce is used up by the villagers themselves. At the event of a surplus, however, the produce is sold off at the city market.

During the harsh summer months, the villagers are forced to take up daily wage jobs which include working on construction sites to support their household. This is mainly because of the lack of water resources during the summer season. The climate is hot and the crops dry up under the sun, without proper irrigation. Furthermore, the people are not able to feed their cattle fresh fodder and tend to let their cattle roam free. These free animals graze on fertile lands, laying

waste to the crops sown in the area. Lacking proper storage facilities, the villagers consume most of what is produced and the remaining is sold off later. The nearest storage facility is in Nagin, located about 20 kilometres from Karkata. Due to this, farmers are forced to sell off their produce during periods where there is no demand for it, at much lower profits.

### 2.1.2.1. Water resources

The geographical locations of the major water resources of Karkata is shown below, which include: ponds, wells and rivers.

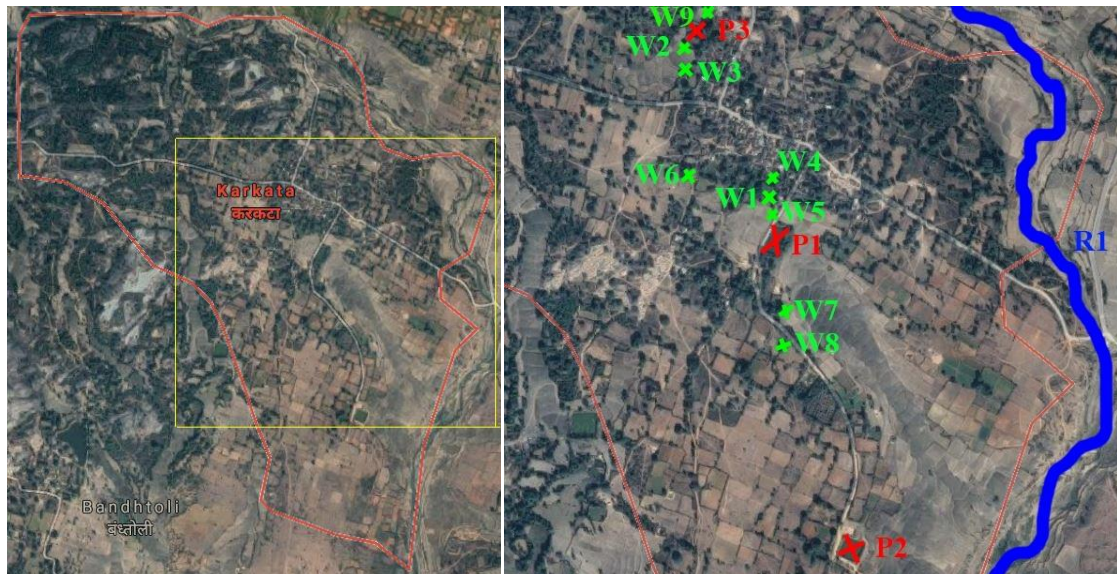

Figures 11 and 12. On the left, map of Karkata with a squared zoom in the region of study. On the right, the squared region zoomed in order to localize the water resources (blue: river, red: ponds, green: wells)

In order to get a better idea of the water resources that the village of Karkata currently has, a detailed explanation has been done, apart from the localization of all of them in the map (Figure 12).

- RIVERS:** The village of Karkata is bordered by rivers on two sides, the Tunju (**R1** in Figure 12) and the Siri. Tunju River is near the village, making it possible for the villagers to go to the river to have bath and washing clothes, as well as drinking water for the cattle. Siri River, although is in the surroundings of Karkata, is too far from the village and no one goes there, which makes it nearly non-existent in the eyes of the inhabitants.

Despite having the Tunju River near the village, this river doesn't have a lot of water all year long. It starts to dry up during the month of February and it doesn't have water again until the rainy season. The water tends to wash away or percolate into the ground,

rendering the river with just pools of water, making it impossible to use for any purpose during those months of summer.



**Figures 13 and 14. On the left, image of the Tunju River with some kids taking a bath. On the right, image of pond P1**

- **PONDS:** throughout Karkata, there are 3 ponds distributed; 1 in the East part of the village (**P3**) and 2 in the West (**P1** and **P2**). These ponds have a very shallow depth and, during summer months, water dries up and lets them nearly empty.

In addition to this, the inhabitants explained us, during the workshops that were carried out during our stay, that in the past there were fish in these ponds, which gave them more variety to their meals. However, nowadays, with the evaporation of nearly all the water on them, and having the ponds almost empty for several months, almost all these fish have died and they were no longer can afford to have fish in their meals.

- **WELLS:** there are several wells distributed throughout the village, especially throughout the part where all the houses are located, next to the main street of the village. Among all these wells, there are 3 of them that have potable water; the rest has contaminated water which makes it impossible to use that water to drink, cook or even clean.

The wells that have drinkable water are **W1**, **W2** and **W3** (Figure 12). People who live in the East part of the village go to wells **W2** and **W3** and people who live in the West part of the village go to fetch water to well **W1**. However, villagers told us that well **W2** and **W3** dry up completely during the summer season and the whole village has to go to fetch water to the well **W1**.

During our stay in the village, in March 2019, we measured the quantity of water there was in **W1** and **W3** wells in case we need that data in the future:

- **W1:** Total depth: 940 cm. Water height: 580 cm. Inner diameter: 182 cm

$$V = \frac{\pi}{4} \cdot D^2 \cdot h = \frac{\pi}{4} \cdot 182^2 \cdot (940 - 580) = 9,365,590 \text{ cm}^3 = \mathbf{9,365 \text{ liters}}$$

- **W3:** Total depth: 530 cm. Water height: 286 cm. Inner diameter: 280 cm

$$V = \frac{\pi}{4} \cdot D^2 \cdot h = \frac{\pi}{4} \cdot 280^2 \cdot (530 - 286) = 15,024,352 \text{ cm}^3 = \mathbf{15,024 \text{ liters}}$$

The rest of the wells (**W4** to **W9**) are sometimes used for cleaning or agriculture. However, most of them dry up during summer season and are completely empty, which, again, makes it impossible to take water from them and use it for anything.



**Figures 15 and 16. On the left, well W5, with contaminated water. On the right, well W1, with drinkable water**

## 2.2. OBJECTIVE SITUATION

As it was said in the previous point regarding the current situation, there are 3 main problems detected in the village of Karkata:

1. EDUCATION
2. DRINKING WATER
3. WATER FOR AGRICULTURE

All of them present a serious situation for the village and a solution is necessary, but this project will be focused on the problem of water for agriculture since it is believed to be the main problem of the village, which brings the most obstacles to the inhabitants of Karkata. Added to that, I strongly believe that if this problem is solved, part of the other ones could be solved too, with the social and economic impact that could be extracted with this.

This is the main reason why this project seeks to reach an objective situation in which all the inhabitants of Karkata who work on agriculture are able to enjoy a stable employment situation throughout the year, obtaining a stable economic remuneration for their work, have a quality standard of living, and are able to invest their money in the education of their children. With this situation in mind, I firmly believe that the problem of education could begin to be solved too.

Although this project will try to achieve this objective situation where farmers do not have problems with water to grow their crops, it is considered highly important to optimize this water and don't waste it in vain. That is why it is believed to be very important to study the different crops, their water needs, effective rainfall, and irrigation water needs, among others.

### 2.2.1. Crops study

All field crops need soil, water, air and light to grow. The soil gives stability to the plants, and stores the water and nutrients which the plants can take up through their roots; the sunlight provides the necessary energy for plant growth, and the air allows the plant to "breathe". Without water, crops can't grow. If there is too much rain, the soil will be full of water, there will not be enough air, and excess water must be removed by drainage methods. On the other hand, if there is too little rain, water must be supplied from other sources and irrigation will be needed. The amount of irrigation water that is needed depends not only on the amount of water already available from rainfall but also on the total amount of water needed by the various crops.

As a conclusion, the two major factors which determine the amount of irrigation water needed are the total water needs of the various crops and the amount of rainwater that is available to the crops.

#### a) Crop water needs

The crop water needs mainly depends on: the climate (for example, in a sunny and hot climate crops need more water per day than in cloudy and cool climate), the crop type (crops like rice or sugarcane need more water than crops like beans and wheat), and the growth stage (grown crops need more water than crops that have just been planted).

In order to have an idea on values of the seasonal water needs for the most important field crops, the following table gives approximate standards:

Table 1. Approximate values of seasonal crop water needs [4], Chapter 2]

CROP	Crop water needs (mm/total growing period)	Total growing period (days)
Alfalfa	800-1,600	100-365
Banana	1,200-2,200	300-365
Barley/Oats/Wheat	450-650	120-150
Bean	300-500	75-90

Cabbage	350-500	120-140
Citrus	900-1,200	240-365
Cotton	700-1,300	180-195
Maize	500-800	800-110
Melon	400-600	120-160
Mung Bean	350-550	65-90
Onion	350-550	70-95
Peanut	500-700	130-140
Pea	350-500	90-100
Pepper	600-900	120-210
Potato	500-700	105-145
Ragi	400-450	95-120
Rice (paddy)	450-700	90-150
Sorghum/Millet	450-650	120-130
Soybean	450-700	135-150
Sugarbeet	550-750	160-230
Sugarcane	1,500-2,500	270-365
Sunflower	600-1,000	125-130
Tomato	400-800	135-180

However, a deeper calculation of the water needs for the various months during which the crop is grown will be done in Section [3.2.2](#) of this project.

#### *b) Effective rainfall*

As one can imagine, not all rainwater which falls on the soil surface can indeed be used by the plants. Part of the rainwater percolates below the root zone of the plants and part of the rainwater flows away over the soil surface as runoff. In other words, part of the rainfall is not effective and the remaining part is stored in the root zone and can be used by the plants. This remaining part is the so-called effective rainfall. The factors that influence which part is effective and which part is not effective are the climate, the soil texture, the soil structure and the depth of the root zone.

Another factor which needs to be taken into account when estimating the effective rainfall is the variation of the rainfall over the years. Especially in low rainfall climates, the little rain that falls is often unreliable; one year may be relatively dry and another year may be relatively wet.

The following table can be used to obtain a rough estimate of the effective rainfall:

Table 2. Precipitation (P) and effective precipitation (Pe) in mm/month [4], Chapter 3]

P (mm/month)	Pe (mm/month)	P (mm/month)	Pe (mm/month)
0	0	130	79
10	0	140	87
20	2	150	95
30	8	160	103
40	14	170	111
50	20	180	119
60	26	190	127
70	32	200	135
80	39	210	143
90	47	220	151
100	55	230	159
110	63	240	167
120	71	250	175

However, deeper calculations of effective precipitation (Pe) will be done in Section 3.2.1 of this project.

## 2.3. PHYSICAL CHARACTERISTICS OF THE AREA

Studying the physical characteristics of an area is key in order to have the correct energy development of isolated communities. Access to the electricity grid or to fossil fuels is limited and expensive, so the engineering designs should use renewable energies from natural resources.

Although the area of study is the village of Karkata, there is no historical record of the weather conditions in this particular point. Therefore, it has been taken all the data from the nearest point with historical records, in this case, the capital of Jharkhand: Ranchi, 20 Km away from the village of Karkata. Due to its proximity to the village, it is considered representative and the study will be done considering the data shown below.

### 2.3.1. Temperature

The study of the temperatures in Ranchi has been done by taking the average temperatures of

each month for 10 years, taking two variables: maximum and minimum temperatures per month. This evolution of temperatures will allow us to see the climatic conditions.

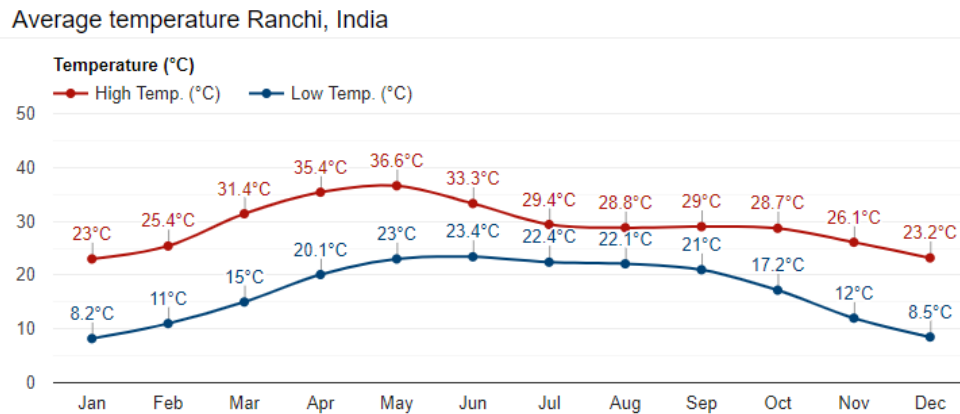

Figure 17. Average temperatures at Ranchi, Jharkhand. Data provided by [Weather Atlas India](#) [5]

As can be seen in Figure 17, temperatures are quite stable around 25°C. The hottest months are from March to June, with maximum temperatures of 36.6°C on average. The coldest months are from November until February, with lowest temperatures 8.2°C on average.

With this figure, we can see the distribution of the different climatological seasons in this region:

- **October to February:** winter season.
- **March to June:** summer season.
- **July to September:** monsoon season (in the following section all the data of rainfall will be shown).

### 2.3.2. Rainfall

The water resource from rainfall is increasingly used in India, as there are several months of monsoon (heavy rains) and this water could be used for a better purpose instead of letting it runoff. Installing a rainwater collection system is an investment that is worthwhile to perform if the conditions of the area are adequate, and that is why a study of precipitation in the area is required.



Average rainfall Ranchi, India

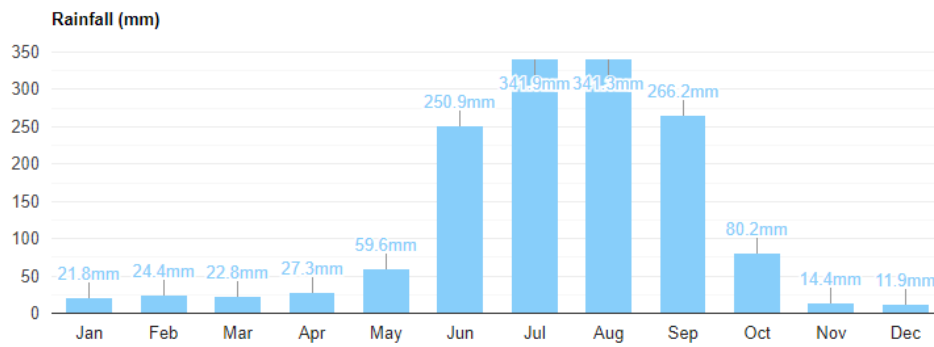

Figure 18. Average precipitations at Ranchi, Jharkhand. Data provided by *Weather Atlas India* [5]

As it can be seen in the previous figure, the precipitations range from 11.9 l/m<sup>2</sup> (11.9 mm) on the month of December to 341.9 l/m<sup>2</sup> on the month of July.

It can also be seen in this graph that rainfall in this region is limited to 4 months with heavy rains and the rest of the year it almost doesn't rain, with very intermittent rains from time to time. Due to this, storing rainwater for several months will be compulsory in order to supply the months without rainfall.

This rainfall values distributed throughout the year will be necessary for doing the calculations of runoff water in Section 3.1 of this project.

### 2.3.3. Solar radiation

Renewable energy from the sun is a resource commonly used in rural or isolated communities with difficult access to the electricity grid. In order to determine the incident solar radiation in the village of Karkata, it has been used the program "Photovoltaic Geographical Information System (PVGIS)" [6]. This program allows, by entering the coordinates of the area (23°12'21.3" N, 85°21'15.8" E), determining the incident radiation levels and the optimal angle of inclination of the solar panels, in order to maximize the energy.

The following considerations have been taken into account when doing this study with the software. If any of these parameters change in the future, the calculations obtained below should be replicated:

- **PV technology:** Crystalline silicon
- **Installed peak PV power:** 1 kWp
- **Estimated system losses:** 14%
- **Mounting position:** Free-standing

These parameters have been chosen because they are the standard ones and it is a good start to obtain some basic results.

**Table 3. Distribution of solar irradiation throughout the year**

MONTH	OPTIMAL IRRADIATION [W·h/m <sup>2</sup> /day]	OPTIMAL ANGLE [°]
January	6,170	51
February	6,740	42
March	7,220	28
April	6,730	11
May	6,180	-3
June	4,740	-9
July	4,300	-5
August	4,440	4
September	4,700	18
October	5,860	36
November	6,320	48
December	6,100	53
<b>Annual Average</b>	<b>5,780</b>	<b>27</b>

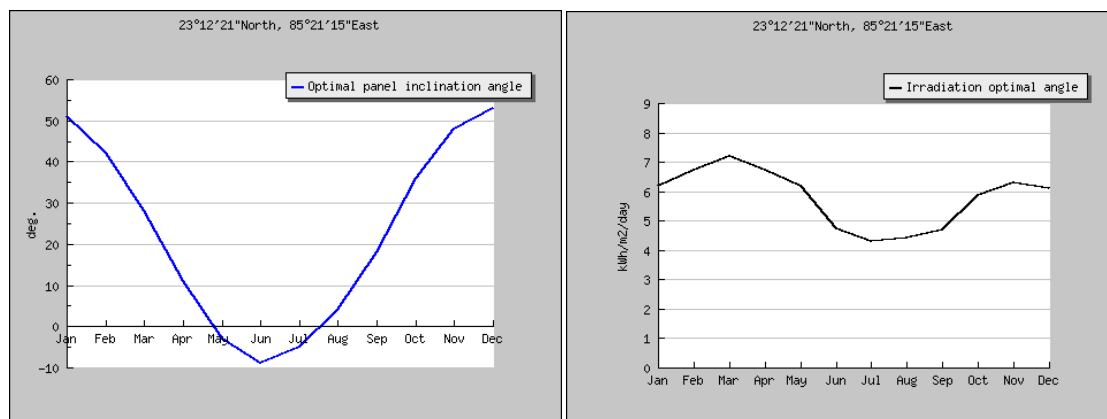

**Figures 19 and 20. Optimal panel inclination angle (°) respect the horizontal axis and optimal irradiation depending on the month (W·h/m<sup>2</sup>/day)**

The previous table and figures show the incident irradiation levels on the earth’s surface throughout the year (W·h/m<sup>2</sup>/day) with an optimum angle (°), which varies throughout the year according to the sun’s position.

In this case, the irradiation that reaches the village of Karkata is, on average, of **5,780 W·h/m<sup>2</sup>/day**, if the axis of the photovoltaic panel is fixed at the optimum angle considered by the PVGIS software of **27°** respect the horizontal axis.

### 2.3.4. Wind

Wind energy is another renewable energy resource that has to be studied in order to see if it can be used somehow. The following figure shows the wind speed (in km/h) in Ranchi.

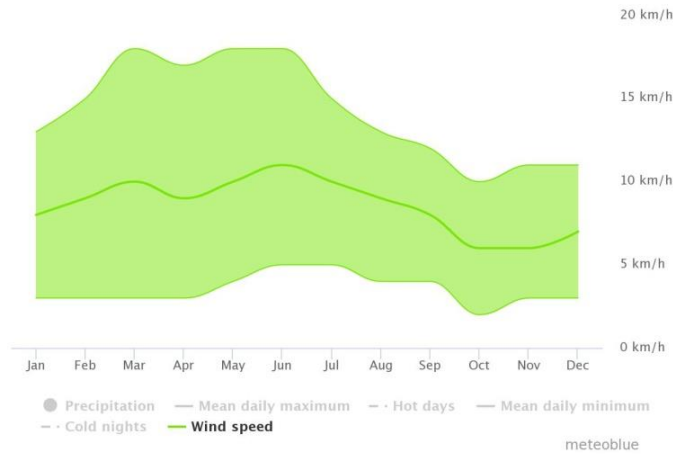

Figure 21. Wind speed (km/h) [7]

As can be seen in Figure 21, the strongest winds are recorded during the months of March to June, with maximum speeds of 18 km/h. However, there is an annual average of 6-10 km/h.

Although Figure 21 gives the wind speed in km/h units, the most widely used system to measure wind speed today is the Beaufort scale. It has twelve levels, plus 0 for “no wind” and can be converted to other units of wind speed too, such as km/h, as it can be seen in the following table.

Table 4. Beaufort scale with conversion to km/h [8]

BEAUFORT NUMBER	DESCRIPTION	WIND SPEED [km/h]	BEAUFORT NUMBER	DESCRIPTION	WIND SPEED [km/h]
0	Calm	< 2	7	High wind	50-61
1	Light air	2-5	8	Gale	62-74
2	Light breeze	6-11	9	Strong gale	75-88
3	Gentle breeze	12-19	10	Storm	89-102
4	Moderate breeze	20-28	11	Violent storm	103-117
5	Fresh breeze	29-38	12	Hurricane force	≥ 118
6	Strong breeze	39-49			

In order to produce wind energy, the area should have an average wind speed greater than 2 in the Beaufort scale throughout the year, which means an annual average greater than 11 km/h. However, and as it can be seen in Figure 21, the intensity of the village of Karkata isn't enough, since it has an annual average around 6-10 km/h, which leads this renewable energy not optimal for this project.

### 2.3.5. Soil

Although while being in the village we took three soil samples, these samples won't be analyzed until the end of the summer season of India, due to lack of time from the students that have to do the analysis.

However, one former team of Live-in-Labs program went last year to the village of Dewgain, 2 km away from Karkata, and did some soil investigation tests. We will use those results in order to understand the soil characteristics like its field capacity, wilting point and particle size distribution from this region.

The following tests were carried out: jar test, sieve analysis, wet sieve analysis and a hydrometer testing. The results are shown below:

Table 5. Observation of the experimental field [9]

AB-3							
OBSERVATIONS				CALCULATIONS			
sl.no	elapsed time	hydrometer reading	temperature	corrected reading	height, He	particle size, D	% finer
	(min)		(degree)	$R_h = R_h' + C_m$	(cm)	(mm)	
1	0.25	5	25	5.005	16	0.1033	16
2	0.5	5	25	5.005	16	0.0731	16
3	1	4	25	4.005	17.3	0.0537	12.81
4	2	4	25.5	4.005	17.3	0.038	12.81
5	4	3.5	25.5	3.505	17.5	0.027	11.21
6	8	3.5	26	3.505	16.1	0.0183	11.21
7	16	4	26	4.005	15.6	0.0128	12.81
8	32	3	26	3.005	15.1	0.0089	9.61
9	64	2.5	26	2.505	15.9	0.0064	8.01
10	128	1	26	1.005	16.6	0.0047	3.21
11	256	1	26	1.005	16.6	0.0033	3.21
12	1440	1	26	1.005	16.6	0.0014	3.21

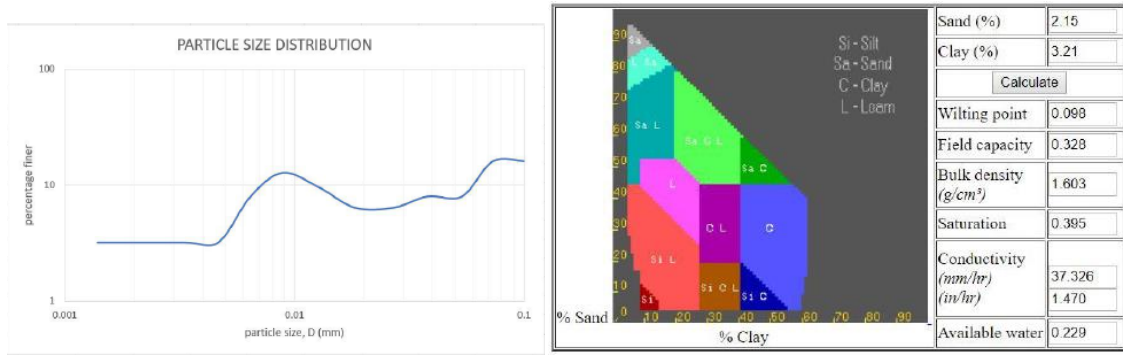

Figures 22 and 23. On the left, particle size distribution. On the right, pedo-transfer chart (Soil Hydraulic Properties Calculator)

With these figures and table, we can see that 2.15% of soil is sand, 3.21% is clay and the rest is silt. The wilting point, the minimal amount of water up to which the plant can take water from the soil is 9.8%, the field capacity (maximum water holding capacity of the soil) is 32.8% and the available water (difference between the field capacity and wilting point) is 22.9%.

### 3. DESIGN ALTERNATIVES

As it has been detailed in Section [2.1](#) of the project, during the visit to the village, a co-design workshop was done in order to understand the problem and have the first idea of the type of solution that was needed in Karkata. Moreover, after doing the contextualization of the project and studying the case, regarding the current and objective situation and doing a deep study of the physical characteristics of the area, it has been decided to construct a tank to collect rainwater.

Rainwater harvesting (RWH) is a simple method by which rainfall is collected for future usage. The collected rainwater may be stored and utilized in different ways directly or used for groundwater recharge purposes.

In this project, as it was stated in the objective situation section of this report (Section [2.2](#)), this rainwater will be used for irrigation. Rainwater harvesting for irrigation has significant potential to increase crop production in the arid/dry areas by supplying harvested rainwater through drip irrigation, sprinkler system and many such. Rainwater harvesting is beneficial, eco-friendly and it is an economic practice as well. In irrigation sector, rainwater harvesting has significant potential to provide environmental and economic benefits such as: improve your farm soil and the environment, increase soil fertility and reduce the need of chemical fertilizers, increase well water and replenish groundwater, utilize all the water falling in the farm and, finally, effectively increase crop production.

In this section of the project, a study of the design of this rainwater harvesting tank will be carried out. The following methodology will be followed:

- Firstly, the runoff water of the area will be calculated to determine the amount of water that could be stored throughout the year from the adjacent fields to the tank. For this point, and subsequently, for the rest too, we will have to make a first hypothesis: the area that we want to use to construct the tank.
- The second step is to calculate the irrigation water needs. For this second step, a second hypothesis will be made: the crop or crops that are going to be grown.
- Taking into account the values obtained in the first and second steps, the third step will be the sizing of the installation (water tank, wall, hydraulic system and electrical system), considering all the materials available in the area.
- And, finally, the last step to be carried out is to create a 3D model of the tank with SolidWorks software and draw a diagram of the hydraulic and electrical systems.

### 3.1. RUNOFF WATER

The first thing that has to be calculated is the runoff potential of the agricultural field. This value will give us an idea of the amount of water that can be harvested from runoff in the study area. For this reason, the following method has to be followed in order to have the final values.

Considering the hydrologic soil group of Karkata as type B, the land use pattern as small grain, the treatment/practices adopted as straight row and the hydrologic condition as good, it gives a total value of 75% for the curve number (CN) [\[10\]](#), [\[Table 8\]](#).

The potential maximum retention of the soil (S) is determined by selecting the curve number for different land uses in a catchment. The CN and S are related by the following Equation (1) [\[10\]](#):

$$CN = 75\% = \frac{25,400}{254 + S} \quad (1)$$

This gives a total value of potential maximum retention of the soil (S) of 84.66 mm.

For red soils, the Equation (2) becomes:

$$CQ = \frac{(P - Ia)^2}{P - Ia + S} \quad (2)$$

Where:

- Q = Runoff depth, mm
- P = Rainfall, mm
- S = Potential maximum retention of soil, mm
- Ia = Initial abstraction, mm

Ia is related to S for different soil types and for red soils  $Ia = 0.3 \cdot S$ . Equation (2) becomes (3):

$$Q = \frac{(P - 0.3 \cdot S)^2}{P + 0.7 \cdot S} \quad (3)$$

As it was stated above, a first hypothesis has to be made: the area that we want to cover with our tank. It has been chosen to take an area of  $A = 1 \text{ acre} \approx 4,000\text{m}^2$ . This value has been taken since it is believed to be a good example of the reality and a good value from which to start off this project.

Regarding the different values of the precipitation in Karkata (detailed in Section [2.3.2](#)) the total values of runoff water are shown in the following table (following Equation (3)).

**Table 6. Month rainfall [mm], Runoff depth [mm] and runoff water [m<sup>3</sup>] per 1 acre**

	Jan	Feb	Mar	Apr	May	Jun	Jul	Aug	Sep	Oct	Nov	Dec
<b>Rainfall [mm]</b>	21.8	24.4	22.8	27.3	59.6	250.9	341.9	341.3	266.2	80.2	14.4	11.9
<b>Runoff depth [mm]</b>	0.15	0.01	0.08	0.04	9.84	163.95	249.70	249.13	178.16	21.53	1.64	2.56
<b>Runoff water [m<sup>3</sup>/acre]</b>	<b>0.63</b>	<b>0.04</b>	<b>0.32</b>	<b>0.16</b>	<b>39.36</b>	<b>655.80</b>	<b>998.83</b>	<b>996.54</b>	<b>712.65</b>	<b>86.13</b>	<b>6.56</b>	<b>10.24</b>

The previous table gives the total amount of runoff water in m<sup>3</sup> that can be collected in 1 acre surface. This gives a total value of **3,507.32 m<sup>3</sup>** throughout the year, taking into account that nearly all of this runoff water will be collected during the rainy season (June to September).

### 3.2. IRRIGATION WATER NEEDS

In Section [2.2.1](#) of this project, it has been explained that the amount of irrigation water which is needed depends not only on the amount of water already available from rainfall but also on the total amount of water needed by the various crops. It can be summarized in the following equation:

$$IN = ET_{crop} - P_e \quad (4)$$

Where:

IN = Irrigation needs (mm/month)

ET<sub>crop</sub> = Crop water need (mm/month)

Pe = Effective precipitation (mm/month)

In this fragment of the project, the calculation of the effective precipitation of the area of Karkata will be done, and also the calculation of the crop water needs (taking into account the second hypothesis that will be carried out regarding the crop that is going to be used), and with these two values, we will be able to obtain the final irrigation water needs.

This procedure of calculation that is hereby followed has been taken from FAO (Irrigation Water Management – Irrigation Water Needs. Training Manual no.3 [\[11\]](#)).



### 3.2.1. Effective precipitation (Pe)

When rainwater ((1) in Figure 24) falls on the soil surface, some of it infiltrates into the soil (2), some stagnates on the surface (3), while some flows over the surface as runoff (4).

When the rainfall stops, some of the water stagnating on the surface (3) evaporates to the atmosphere (5), while the rest slowly infiltrates into the soil (6). From all the water that infiltrates into the soil ((2) and (6)), some percolates below the root zone (7), while the rest remains stored in the root zone (8).

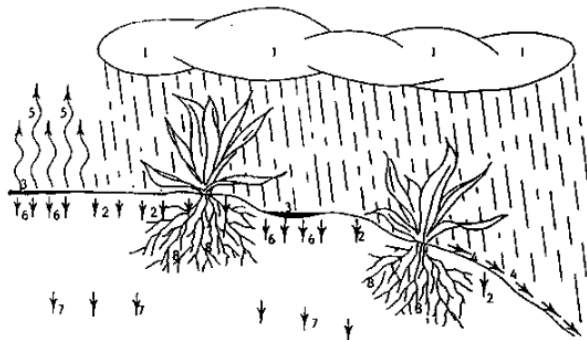

Figure 24. Effective rainfall: (8) = (1) – (4) - (5) - (7)

In other words, the effective rainfall (8) is the total rainfall (1) minus runoff (4) minus evaporation (5) and minus deep percolation (7); only the water retained in the root zone (8) can be used by the plants, and represents what is called the effective part of the rainwater. The term effective rainfall is used to define this fraction of the total amount of rainwater useful for meeting the water need of the crops.

These formulae can be applied in order to obtain the total value (per month) of effective precipitation:

$$P_e = 0.8 \cdot P - 25 \quad \text{if } P > 75\text{mm/month} \quad (5)$$

$$P_e = 0.6 \cdot P - 10 \quad \text{if } P < 75\text{mm/month} \quad (6)$$

Where:

P = Rainfall or precipitation (mm/month)

Pe = Effective rainfall or effective precipitation (mm/month)

Using the Formulae (5) and (6) when needed, the following values of effective precipitation throughout the year have been calculated:

**Table 7. Month rainfall [mm/month], Effective rainfall [mm/month]**

	Jan	Feb	Mar	Apr	May	Jun	Jul	Aug	Sep	Oct	Nov	Dec
<b>Rainfall [mm]</b>	21.8	24.4	22.8	27.3	59.6	250.9	341.9	341.3	266.2	80.2	14.4	11.9
<b>Effective rainfall [mm]</b>	<b>3.08</b>	<b>4.64</b>	<b>3.68</b>	<b>6.38</b>	<b>25.76</b>	<b>175.72</b>	<b>248.52</b>	<b>248.04</b>	<b>187.96</b>	<b>39.16</b>	<b>0</b>	<b>0</b>

The total value of effective precipitation is **942.94 mm** of water throughout all the year, but the values that we will use to calculate the irrigation water needs are the monthly values shown in Table 7.

### 3.2.2. Crop water needs (ET<sub>crop</sub>)

The crop water need (ET<sub>crop</sub>) is defined as the depth (or amount) of water needed to meet the water loss through evapotranspiration. In other words, it is the amount of water needed by the various crops to grow optimally.

The crop water need always refers to a crop grown under optimal conditions, i.e. a uniform crop, actively growing, completely shading the ground, free of diseases, and favourable soil conditions (including fertility and water). The crop thus reaches its full production potential under the given environment.

The crop water needs mainly depend on:

- a) The climate: in a sunny and hot climate, crops need more water per day than in a cloudy and cool climate.
- b) The crop type: crops like maize or sugarcane need more water than crops like millet or sorghum.
- c) The growth stage of the crop; fully grown crops need more water than crops that have just been planted.

The crop water needs mainly depend on two factors (K<sub>c</sub> and ET<sub>o</sub>), as can be described in the following formula:

$$ET_{crop} = K_c \cdot ET_o \quad (7)$$

Where:

K<sub>c</sub> = Crop factor

ET<sub>o</sub> = Reference crop evapotranspiration (mm/day)

### 3.2.2.1. Reference crop evapotranspiration ( $ET_o$ )

$ET_o$  is the rate of evapotranspiration from a large area, covered by green grass, 8 to 15 cm tall, which grows actively, completely shades the ground and which is not short of water.

There are several methods to determine the  $ET_o$ : experimental (using an evaporation pan) or theoretical, using measured climatic data, e.g. the Blaney-Criddle method, which is the method that is going to be used in this project and can be summarized with the following equation:

$$ET_o = p \cdot (0.46 \cdot T_{mean} + 8) \quad (8)$$

Where:

$ET_o$  = Reference crop evapotranspiration (mm/day) as an average for 1 month

$T_{mean}$  = Mean daily temperature ( $^{\circ}C$ )

$p$  = Mean daily percentage of annual daytime hours (%)

For calculating the  $T_{mean}$  (mean daily temperature) the following table has been created in order to get the monthly value (values taken from Section [2.3.1](#)):

**Table 8. Minimum, maximum and mean monthly temperatures**

	Jan	Feb	Mar	Apr	May	Jun	Jul	Aug	Sep	Oct	Nov	Dec
Tmin [ $^{\circ}C$ ]	8.2	11	15	20.1	23	23.4	22.4	22.1	21	17.2	12	8.5
Tmax [ $^{\circ}C$ ]	23	25.4	31.4	35.4	36.6	33.3	29.4	28.8	29	28.7	26.1	23.2
Tmean [ $^{\circ}C$ ]	<b>15.6</b>	<b>18.2</b>	<b>23.2</b>	<b>27.75</b>	<b>29.8</b>	<b>28.35</b>	<b>25.9</b>	<b>25.45</b>	<b>25</b>	<b>22.95</b>	<b>19.05</b>	<b>15.85</b>

For calculating the mean daily percentage of annual daytime hours ( $p$ ), what is needed is the latitude of Karkata, which is:  $23^{\circ}12'21.3''$  N, and can be approximated to  $25^{\circ}$  North.

Table 9. Mean daily percentage (p) of the annual daytime hour for different latitudes

Latitude	North	Jan	Feb	Mar	Apr	May	June	July	Aug	Sept	Oct	Nov	Dec
	South	July	Aug	Sept	Oct	Nov	Dec	Jan	Feb	Mar	Apr	May	June
60°		.15	.20	.26	.32	.38	.41	.40	.34	.28	.22	.17	.13
55		.17	.21	.26	.32	.36	.39	.38	.33	.28	.23	.18	.16
50		.19	.23	.27	.31	.34	.36	.35	.32	.28	.24	.20	.18
45		.20	.23	.27	.30	.34	.35	.34	.32	.28	.24	.21	.20
40		.22	.24	.27	.30	.32	.34	.33	.31	.28	.25	.22	.21
35		.23	.25	.27	.29	.31	.32	.32	.30	.28	.25	.23	.22
30		.24	.25	.27	.29	.31	.32	.31	.30	.28	.26	.24	.23
25		.24	.26	.27	.29	.30	.31	.31	.29	.28	.26	.25	.24
20		.25	.26	.27	.28	.29	.30	.30	.29	.28	.26	.25	.25
15		.26	.26	.27	.28	.29	.29	.29	.28	.28	.27	.26	.25
10		.26	.27	.27	.28	.28	.29	.29	.28	.28	.27	.26	.26
5		.27	.27	.27	.28	.28	.28	.28	.28	.28	.27	.27	.27
0		.27	.27	.27	.27	.27	.27	.27	.27	.27	.27	.27	.27

Taking the value of the above Table 9 from the Irrigation Water Management training manual no.3 [11] regarding the values of p for different latitudes, we can find the final monthly value of ETo following Formula (8):

Table 10. Tmean (°C), p and ETo (mm/day)

	Jan	Feb	Mar	Apr	May	Jun	Jul	Aug	Sep	Oct	Nov	Dec
Tmean [°C]	15.6	18.2	23.2	27.75	29.8	28.35	25.9	25.45	25	22.95	19.05	15.85
P [%]	0.24	0.26	0.27	0.29	0.30	0.31	0.31	0.29	0.28	0.26	0.25	0.24
ETo [mm/day]	3.64	4.25	5.04	6.02	6.51	6.52	6.17	5.71	5.46	4.82	4.19	3.66

### 3.2.2.2. Crop factor (Kc)

The crop factor, Kc, mainly depends on the type of crop, the growth of the crop and the climate. For this calculation of the crop factor, the second hypothesis of the project has to be done: choosing a certain crop/s as a real example of utilization of the lands in Karkata.

As it has been explained in the current situation of the project, the main crop that they use is paddy. They sow it in June and they harvest it in December, and with the rain of those months (it includes monsoon season), they can correctly cultivate this crop.

The problem comes during the other months of the year (including summer season) that they don't have enough water to cultivate any crop and they basically leave their village seeking for daily wage jobs, as agriculture in Karkata during those months is inexistent. The solution that we propose is to harvest water during the rainy season and use it from January to June when a second crop could be cultivated.

Regarding the water needs of the main crops available in the area of Ranchi (Table 1), it has been decided to use **mung beans, sorghum or ragi (finger millet)** as the second crop cultivated

in the village of Karkata. We have chosen 3 different crops in order to give several options to the villagers. These 3 crops have been chosen for the following reasons: they do not require a large quantity of water (compared to other crops), they can grow in rather dry areas and hot weather, there is high availability in the area and they are crops that have been cultivated in the past at some points, so the villagers know them and know how to work with these crops.

In the case of **mung beans**, the following values can be given for the different stages of growth of the crop:

**Table 11. Duration and Kc values for the different stages of growth of MUNG BEANS**

	Initial stage	Crop development stage	Mid season stage	Late season stage
Duration [days]	8	22	25	10
Kc	0.58	0.95	1.2	0.47

Considering the sowing date January 15<sup>th</sup>, and the total growing period of 65 days, the harvesting day should be March 20<sup>th</sup>. After that date, farmers should leave the lands rest for some time and then prepare the fields for cultivating paddy in June.

In the case of **sorghum**, the following values can be given for the different stages of growth of the crop:

**Table 12. Duration and Kc values for the different stages of growth of SORGHUM**

	Initial stage	Crop development stage	Mid season stage	Late season stage
Duration [days]	20	35	40	30
Kc	0.35	0.75	1.1	0.65

Considering the sowing date January 15<sup>th</sup>, and the total growing period of 125 days, the harvesting day should be May 19<sup>th</sup>. After that date, farmers should leave the lands rest for some time and then prepare the fields for cultivating paddy in June.

In the case of **ragi**, the following values can be given for the different stages of growth of the crop:

**Table 13. Duration and Kc values for the different stages of growth of RAGI**

	Initial stage	Crop development stage	Mid season stage	Late season stage
Duration [days]	25	35	40	20
Kc	0.45	0.65	0.99	0.7

Considering the sowing date January 15<sup>th</sup>, and the total growing period of 120 days, the harvesting day should be May 14<sup>th</sup>. After that date, farmers should leave the lands rest for some time and then prepare the fields for cultivating paddy in June.

### 3.2.3. Irrigation water needs (IN)

The irrigation water needs of a certain crop, as per Formula (4), is the difference between the crop water need and that part of the rainfall which can be used by the crop (the effective rainfall).

For the 3 crops selected, the irrigation water needs have been calculated and the results are the following (using Formula (4)):

**Table 14. Crop water needs (ET<sub>crop</sub>), effective precipitation (Pe) and irrigation water needs (IN) of MUNG BEAN**

	Jan	Feb	Mar	Total
ET <sub>crop</sub> [mm/month]	44.58	143.45	84.18	272.22
Pe [mm/month]	3.08	4.64	3.68	11.4
IN [mm/month]	41.50	138.81	80.51	260.82
<b>IN [m<sup>3</sup>/month] x 1 acre</b>	<b>166</b>	<b>555.25</b>	<b>322.05</b>	<b>1,043.30</b>

This gives a total value of **1,043.30 m<sup>3</sup>** that would be needed as irrigation water needs (IN) for the crop of **mung bean** if the sowing date is January 15<sup>th</sup>.

**Table 15. Crop water needs (ET<sub>crop</sub>), effective precipitation (Pe) and irrigation water needs (IN) of SORGHUM**

	Jan	Feb	Mar	Apr	May	Total
ET <sub>crop</sub> [mm/month]	20.40	92.16	163.09	159.28	59.26	494.19
Pe [mm/month]	3.08	4.64	3.68	6.38	25.76	43.54
IN [mm/month]	17.32	87.52	159.41	152.90	33.50	450.65
<b>IN [m<sup>3</sup>/month/acre]</b>	<b>69.27</b>	<b>350.07</b>	<b>637.64</b>	<b>611.59</b>	<b>134.01</b>	<b>1,802.58</b>

This gives a total value of **1,802.58 m<sup>3</sup>** that would be needed as irrigation water needs (IN) for the crop of **sorghum** if the sowing date is January 15<sup>th</sup>.

**Table 16. Crop water needs (ET<sub>crop</sub>), effective precipitation (Pe) and irrigation water needs (IN) of RAGI**

	Jan	Feb	Mar	Apr	May	Total
ET <sub>crop</sub> [mm/month]	26.22	78.11	129.01	172.59	63.82	469.75
Pe [mm/month]	3.08	4.64	3.68	6.38	25.76	43.54
IN [mm/month]	23.14	73.47	125.33	166.21	38.06	426.21
<b>IN [m<sup>3</sup>/month] x 1 acre</b>	<b>92.58</b>	<b>293.88</b>	<b>501.32</b>	<b>664.82</b>	<b>152.25</b>	<b>1,704.85</b>

This gives a total value of **1,704.85 m<sup>3</sup>** that would be needed as irrigation water needs (IN) for the crop of **ragi** if the sowing date is January 15<sup>th</sup>.

An Excel file has been created in order to calculate automatically all these values considering all the main crops and their characteristics, sowing date and area covered with the crop. This document has been attached to this master thesis as an annex ([Annex II](#)).

An adequate water supply is important for plant growth. When rainfall is not sufficient, the plants must receive additional water from irrigation. Various methods can be used to supply irrigation water to the plants. Each method has its advantages and disadvantages, and these should be taken into account when choosing the method which is best suited to the local circumstances [\[12\]](#).

There are three commonly used methods: surface irrigation, sprinkler irrigation and drip irrigation.

a) Surface irrigation

Surface irrigation is the application of water by gravity flow to the surface of the field. Either the entire field is flooded (basin irrigation) or the water is fed into small channels (furrows) or strips of land (borders).

- *Basin irrigation:* Basins are flat areas of land, surrounded by low bunds. The bunds prevent the water from flowing to the adjacent fields. Basin irrigation is commonly used for rice grown on flat lands or in terraces on hillsides. In general, the basin method is suitable for crops that are unaffected by standing in water for long periods (e.g. 12-24 hours).
- *Furrow irrigation:* Furrows are small channels, which carry water down the land slope between the crop rows. Water infiltrates into the soil as it moves along the slope. The crop is usually grown on the ridges between the furrows. This method is suitable for all row crops and for crops that cannot stand in water for long periods (e.g. 12-24 hours). Irrigation water flows from the field channel into the furrows by opening up the bank of the channel, or by means of siphons.

- *Border irrigation*: Borders are long, sloping strips of land separated by bunds. They are sometimes called border strips. Irrigation water can be fed to the border in several ways: opening up the channel bank, using small outlets or gates or by means of siphons.

b) Sprinkler irrigation

Sprinkler irrigation is similar to natural rainfall. Water is pumped through a pipe system and then sprayed onto the crops through rotating sprinkler heads.

c) Drip irrigation

With drip irrigation, water is conveyed under pressure through a pipe system to the fields, where it drips slowly onto the soil through emitters or drippers which are located close to the plants. Only the immediate root zone of each plant is wetted. Therefore this can be a very efficient method of irrigation.

Drip irrigation is a type of micro-irrigation system that has the potential to save water and nutrients by allowing water to drip slowly to the roots of plants, either from above the soil surface or buried below the surface. The goal is to place water directly into the root zone and minimize evaporation. Drip irrigation systems distribute water through a network of valves, pipes, tubing, and emitters. Depending on how well designed, installed, maintained, and operated it is, a drip irrigation system can be way more efficient than the other types of irrigation systems.

Studies on the field confirm that with drip irrigation a large amount of the water used can be saved, due to the low evaporation of the water that is provided to the crop, which gives the highest efficiency. Studies detail that up to 50% of water can be saved [13] [14], and this is what we will consider to size our project.

For this reason, it has been decided to use a **drip irrigation system** for this project, which will give savings of **50%** of the amount of water. Thus, the total irrigation water needs considering a drip irrigation system are shown in the following table:

**Table 17. Irrigation water needs with a drip irrigation system**

<b>CROP</b>	<b>TOTAL IRRIGATION WATER NEEDS</b>	<b>IRRIGATION WATER NEEDS (with drip irrigation system)</b>
Mung bean	1,043.30 m <sup>3</sup>	521.65 m <sup>3</sup>
Sorghum	1,802.58 m <sup>3</sup>	901.29 m <sup>3</sup>
Ragi	1,708.85 m <sup>3</sup>	854.42 m <sup>3</sup>



### 3.3. SIZING OF INSTALLATION

Although this irrigation water needs values for the different 3 options (521.65 m<sup>3</sup>, 901.29 m<sup>3</sup> and 854.42 m<sup>3</sup>) could be easily reached thanks to harvesting all the runoff water of the 1 acre area (3,507.32 m<sup>3</sup>), there are some space constraints that have to be taken into account in order to design the water tank.

For this reason, in this project and with these 3 different options of crops, deficit irrigation will be implemented.

Deficit irrigation (DI) is a watering strategy that can be applied by different types of irrigation application methods. The correct application of DI requires a thorough understanding of the yield response to water (crop sensitivity to drought stress) and of the economic impact of reductions in the harvest. In regions where water resources are restrictive, it can be more profitable for a farmer to maximize crop water productivity instead of maximizing the harvest per unit land.

Increasing the productivity of water in agriculture can be achieved by producing more agriculture output with the same amount of water resources to crops. Many irrigation experiments involving different irrigation levels showed that deficit irrigation usually has higher WP than full irrigation. For example, 2/3 of full irrigation increases WP by 19–28% for wheat crop and 8% for corn [15].

As has been explained above, we have some space restrictions and all the water that is needed won't be able to be supplied. That is why we opt for deficit irrigation, supplying 2/3 of the water needed for each crop. This value of 2/3 of the total water needed is proved to be the optimal number for crop yield response to water.

Taking this deficit irrigation into account, the irrigation water needs for the three different options of crops that are being studied are:

**Table 18. Irrigation water needs with deficit irrigation**

CROP	TOTAL IRRIGATION WATER NEEDS	IRRIGATION WATER NEEDS (with deficit irrigation)
Mung bean	521.65 m <sup>3</sup>	344.29 m <sup>3</sup>
Sorghum	901.29 m <sup>3</sup>	594.85 m <sup>3</sup>
Ragi	854.42 m <sup>3</sup>	563.92 m <sup>3</sup>

Having in mind these values of water needs for the three different options of crops that we are









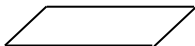

studying, we consider that with a capacity of 600 m<sup>3</sup> we could meet the needs of water in these 3 cases. Thus, our tank will need to have a capacity of this value ( $V = 600 \text{ m}^3$ ).

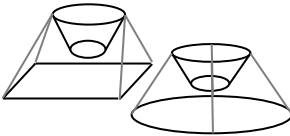

For reaching this total capacity value of 600 m<sup>3</sup>, many alternatives of design of the tank have been considered, and in this following table we are going to discuss them all, separating them into 3 different categories:

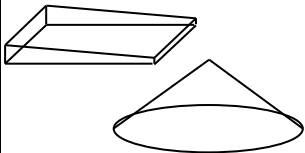
a) Shape

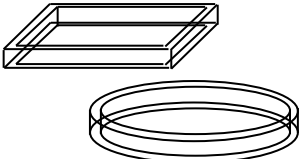
Regarding the shape of the tank, the first thing to be considered is the shape of its surface. The two different options are: rectangular and circular. Moreover, there are diverse options that have been studied concerning the shape of the tank, including adding a funnel structure, a roof, a retaining wall and adding an incision angle to the construction.

**Table 19. Design alternatives regarding the shape**

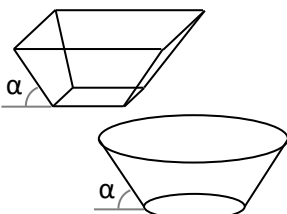
OPTION	DESCRIPTION	PROS	CONS	Option selected
<b>Rectangular</b>		· Easy to construct	· Requires detailed design · Requires more construction materials (compared to circular cross section for the same capacity)	
<b>Circular</b>		· Less usage of construction materials and land area	· Difficult to construct	
<b>Funnel</b>		· Precise catchment area	· Difficult construction · High price	
<b>Roof</b>		· Prevent evaporation · Use the water collected from the roof for drinking purposes	· High price · Impossible to build on such a large scale (too big dimensions)	
<b>Wall</b>		· Prevents water contamination · Helps to control the inlet and outlet of water	· Cost	



<b>Incision angle (frustum shape)</b>		<ul style="list-style-type: none"> <li>· If constructed with only soil, this provides better stability compared to all the above options</li> </ul>	<ul style="list-style-type: none"> <li>· Covers more surface area compared to vertical walled tanks</li> </ul>	
---------------------------------------	---	---	--	---

Thus, in terms of shape, the design of the tank will have a **circular surface** with a certain angle of incision (**frustum cone shape**). In addition, it will have a **retention wall** to prevent the contamination of the water and better control of the water entering and leaving the tank.

b) Size and number

Regarding the size and number, it has been attempted to contemplate the option of reducing the size of the tank and increasing the number of tanks.

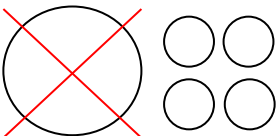
Table 20. Design alternatives regarding the size and number





OPTION	DESCRIPTION	PROS	CONS	Option selected
Increasing the number of tanks and reducing their size		<ul style="list-style-type: none"> <li>· Building a roof for smaller tanks is possible: prevent evaporation</li> <li>· The tanks will not be too deep: easier construction and pumping</li> </ul>	<ul style="list-style-type: none"> <li>· The surface occupied is much bigger than with only 1 big tank</li> <li>· Higher cost: the materials used (i.e. pumps) would be multiplied by the number of tanks</li> </ul>	

c) Materials

As for the materials, those that have been studied as possibilities of use for the tank are cement, soil, rocks and tarpaulin sheet. For the wall, the following materials are being contemplated: cement, bricks, soil and rocks.

Table 21. Design alternatives regarding the materials

OPTION	Used in	PROS	CONS	Option selected
Cement concrete	Tank & wall	<ul style="list-style-type: none"> <li>· Long lifetime</li> <li>· Great resistance to natural</li> </ul>	<ul style="list-style-type: none"> <li>· High initial construction cost</li> </ul>	

		disasters (e.g. earthquake)		
Soil	Tank & wall	· Zero cost	· Only a viable option if the soil has +40% of clay: not the case of Karkata's soil (Section <a href="#">2.3.5</a> ) · Shorter life span	
Rocks masonry's	Tank & wall	· Locally available stones for construction · Relatively low cost	· Less resistance to natural disasters (e.g. earthquakes) · Need skilled workmanship to construct	
Tarpaulin sheet	Tank	· High availability · Flexibility	· High cost · Relatively short lifespan	
Brick masonry's	Wall	· High availability	· Relatively high cost · Need for plastering	

Thus, we will contemplate two options of materials for the tank and two options also for the wall (**tank: tarpaulin sheet and rocks masonry's, walls: brick and rocks masonry's**). In the budget section (Section [4](#)) both options will be discussed and a final material will be selected.

### 3.3.1. Water tank + wall

The capacity of the water tank is mainly given by the irrigation water needs of the crop, provided there is enough water in the tank coming from runoff. In this case, as shown in Chapter [3.3](#), using deficit irrigation, the water needs that we want to cover are 600 m<sup>3</sup> for the three options of different crops that we mentioned above. Thus, we will design a tank with a total volume of 600 m<sup>3</sup>.

As has been detailed in Table 19, the shape of the tank will be a frustum cone. And, in order to know which will be the dimensions of the tank, first we must take into account three restrictions:

- The construction of the tank should never exceed 5% of the total area that is being covered by it. As we are covering an area of 1 acre  $\approx$  4,000 m<sup>2</sup>, this would give us a maximum surface value of the tank of  $S = 0.5 \cdot 4,000 = 200$  m<sup>2</sup>.
- The tank can't have a height bigger than 4 m to avoid land demolition.
- For the exact same reason, to avoid land demolition, the tank must have a certain angle of incision. This angle must be between 30° and 60°.

Having all these restrictions into account, the radius values are automatically given:  $R = 8\text{m}$ ,  $r = 5.7\text{ m}$ , and all the dimensions of the tank are now fixed.

Moreover, and as it was explained in Table 21, the materials of the tank can be rocks and tarpaulin sheet, due to the high price that would involve doing all the construction with cement and the impossibility of using only the soil, as it only has a 3.21% of clay (Section [2.3.5](#)). At the moment, these two options will be taken as valid and they will be checked at the budget chapter (Chapter [4](#)) in order to see which one is the most viable and economical option.

Regarding the wall that we want to build, as detailed in Table 21, two possible options of materials are being contemplated, which are: bricks + plaster and rocks + plaster. With both options, the following design measures are being into consideration:

- Height (h): 0.5 m
- Width (w): 0.25 m
- Inlet: 5 inlet holes, diameter: 0.2 m
- Outlet: 2 outlet holes, diameter: 0.2 m

### 3.3.2. Hydraulic System

The irrigation water system will be composed mainly of two parts: the hydraulic and electrical subsystems. The hydraulic system will be in charge of supplying the water needs to the crops of study, whereas the electrical system will be the one that supplies the electricity to the pump and sensors installed in the field.

In this section, then, it will be defined how the irrigation water system will perform to supply the needs of water. To tackle with this study it will be designed the irrigation system as drip irrigation, as it was detailed in Section [3.2.3](#), which is one of the oldest and most used technologies to irrigate crops around the world.

The drip irrigation supplies drops close to the root of the crop, which makes this mode much more efficient and controllable than the other methodologies existing in the current market. The water is supplied by emitters that are directly connected to the water pump through a piping system. According to manuals of irrigation water systems, each emitter can provide, on average, 4 litres per hour of water to the roots of the crops.

Figure 25 shows the main parts that make up this system, in order to get an idea of how this method of irrigation works:

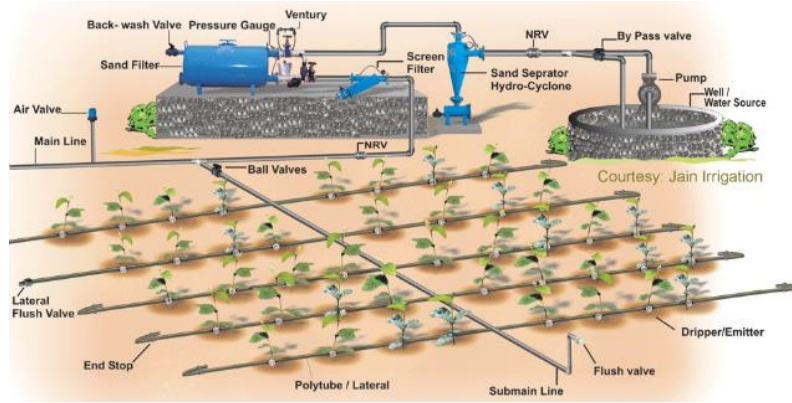

Figure 25: Overview of a drip irrigation water supply system

In this case, as it has been explained in the previous Chapter 3.3, the water source will be a rainwater tank of 600 m<sup>3</sup> of capacity, to supply water to 4,000 m<sup>2</sup> of field.

Moreover, some assumptions are made in order to tackle this study. First of all, it has been considered a squared field of dimensions 64 x 64 meters. Secondly, each row of the crops will be located 2 meters away from its closest row. Finally, emitters will be located 18” apart from each other, which is around 450 mm of distance.

On this basis, the assumptions mentioned imply that the case study will be configured with 32 rows of pipes with 140 emitters per pipe. This implies that the irrigation system will have 4,480 emitters per 4,000 m<sup>2</sup>, or what is the same, 1.12 emitters per m<sup>2</sup>. Considering an average of 4 l/hour, the whole system has to be able to provide a total flow rate of 17,920 l/h, which is 17.92 m<sup>3</sup>/h.

Further considerations to be taken into account are the vertical distance the water has to go through the piping. It has been considered a slope of 15% of the field, which represents a total value of 16.53 meters (h), and the location of the pump will be 3 meters underground (d).

Having all of these concepts clear, the following step is to design the hydraulic system in order to select a pump that complies with the requirements.

The maximum area of the piping will be given with the maximum velocity (v) of 1.2 m/s. Therefore:

$$A = \frac{Q}{v} = \frac{0.004977 \frac{m^3}{s}}{1.2 \text{ m/s}} = 0.004147 \text{ m}^2 \quad (9)$$

This section implies a radius of the pipe of 36.34 mm. However, this section doesn't exist in the

market, so it has to be chosen one realistic dimension. In this case, it has been chosen 1.5” as a radius of the pipe, which is 3” of diameter of the main pipe (D).

All piping can be estimated following this calculation: 32 rows x 64 m/row + 64 m of the main pipe. The total sum results in a value of 2,112 meters of the total piping (L) for the 4,000 m<sup>2</sup>.

In order to calculate the pressure loss of the fluid, it will be used the Darcy-Weisbach methodology. The first value needed is the Reynolds number, which can indicate if the flow is turbulent or laminar.

$$Re = \frac{\rho \cdot D \cdot v}{\mu} = \frac{1000 \cdot 0.0762 \cdot 1.2}{0.0011} = 83,127 \tag{10}$$

The flow, then, can be considered totally turbulent, and the Darcy–Weisbach equations to calculate the pressure losses are the following ones.

$$Hf = \frac{f \cdot 8 \cdot L \cdot Q^2}{g \cdot \pi^2 \cdot D^5} \tag{11}$$

The coefficient of losses (f) has to be calculated in the Moody diagram. The input parameters are the Reynolds number, already calculated, and the relative roughness divided by the diameter, which depends on the material used. In this case, it has been considerate HPDE as a material for all the piping with a relative roughness of 0.007 meters.

Therefore, the input in the Moody diagram (Figure 26) will be  $Re = 83,127$  and the relative roughness of 0.0001. Following the diagram, the coefficient of friction f is 0.02.

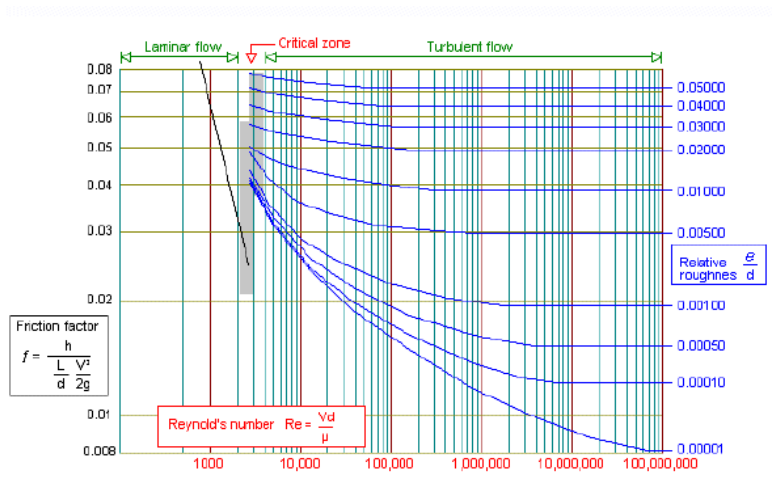

Figure 26: Moody diagram

Now all the parameters are defined to use the Darcy-Weisbach equation:

$$H_f = \frac{f \cdot 8 \cdot L \cdot Q^2}{g \cdot \pi^2 \cdot D^5} = 33.68 \text{ meters of water column (wc)} \quad (12)$$

The following step, then, is to calculate all the singular losses of the system. In this case, it has been considered the following fittings plotted in Figure 27.

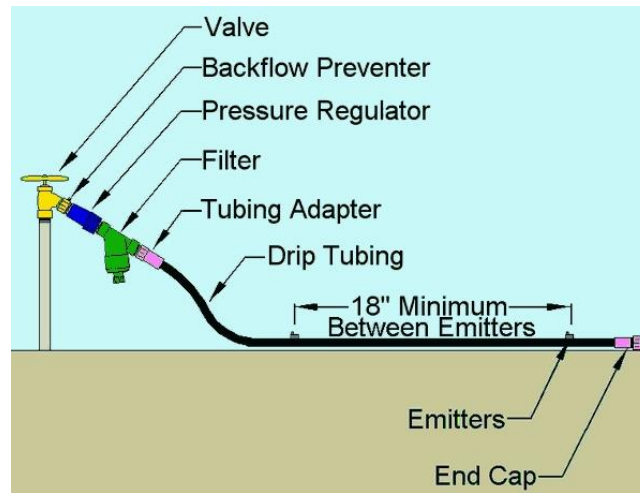

Figure 27: Fittings of the drip irrigation system

Following the procedure plotted in Figure 27, it has been counted all the fittings for the whole installation and the results are the following ones:

Table 22. Calculation of singular losses

Elements	K	N°	Result
Ball valve	0.2	97	19.4
Non return valve	0.2	1	0.2
Filter	0.5	1	0.5
90° elbow or “T”	1	36	36
Diffuser	0.5	1	0.5
<b>Total [<math>\Sigma(K \cdot N) \cdot v^2 / (2 \cdot g)</math>]</b>			<b>4.15</b>

They have been considered 97 ball valves (3 for each row (32) plus 1 for the main pipe), 1 non return valve (installed after the pump), 1 filter (installed before the pump), 36 90° elbows or “T” (32 for each row plus 3 extra ones for the main pipe) and 1 diffuser (the losses for getting the water from the pump to the pipes).

In addition, we will install some cap ends at the end of each pipe, in case we want to increase the size of our installation in the future (2 for each row plus 2 for the main pipe: 64 cap ends).



As Table 22 shows, the singular losses ( $H_v$ ) are 4.15 meters of water column, to add at the linear losses of 33.68 meters of water column.

Moreover, it has been considered a pressure ( $P$ ) of 20 kPa at the exit of the emitters, in order to guarantee the correct operation of the system. This value converted into meters of water column is 2.03 m.

Considering all the parameters calculated until now, the total head the pump has to provide is the following one:

$$H = H_f + H_v + h + d + P = 33.68 + 4.15 + 16.53 + 3 + 2.03 = 59.44 \text{ m of wc} \quad (13)$$

Therefore, the pump has to operate in the following state:  $Q = 17.92 \text{ m}^3/\text{h}$  and  $H = 59.44$  meters of wc.

### 3.3.2.1. Pump selection

One of the main worldwide suppliers of water pumps is Grundfos, which offers a wide range of products for all kinds of applications in the industry [16].

One of its main products is the Submersible Pump (SP) family, which are groundwater pumps for irrigation applications. These kinds of pumps present high efficiency and reliability in the entire operation curve Q-H. They are made of stainless steel and offer high resistance to sand, abrasives, motor burnout and are able to be maintained easily. It can be seen an example in Figure 28:



Figure 28: Grundfos irrigation water pump

The pump which best fits the requirements of this irrigation water supply system is the one called Grundfos pump SP17-8, which is able to operate at  $Q = 18.31 \text{ m}^3/\text{h}$  and  $H = 59.44$  meters of wc, quite close to the calculated operation point.

The curve Q-H is presented in the following Figure 29:

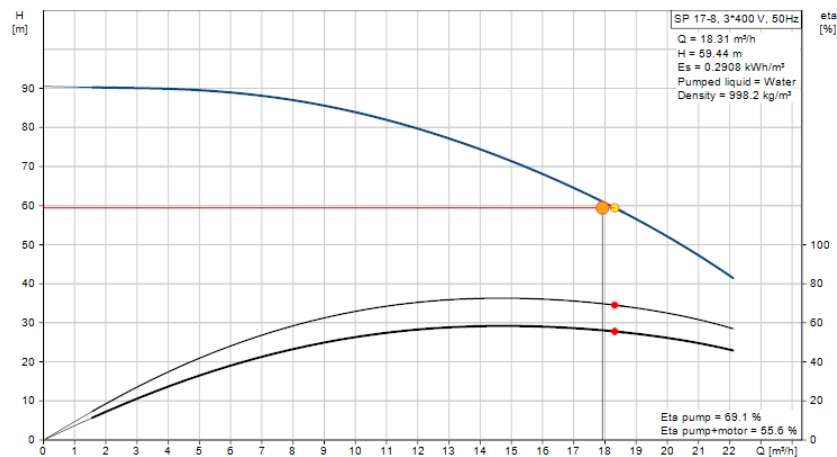

Figure 29: Q-H curve of the pump SP17-8

The total efficiency of the pump in this operating point is 55.60%, useful value to calculate the energy to power it. In this case, the power needs are 5.323 kW, which will be studied in the following Chapter 3.3.3, where the electrical system study will be done.

For this case, the NPSH value is around 4.8 meters, but it will not be used as the pump will be completely submerged in the water tank.

### 3.3.2.2. Water tank control

Having the hydraulic system dimensioned, the next step is to design the control of the water tank, to avoid the pump working without load. The first thing to design is the control with level switches. This technology uses two buoys that are floating in the tank, in such a way that one of the buoys is the switch that closes the circuit, whereas the other one closes it. The details of this methodology can be seen in the following Figure 30.

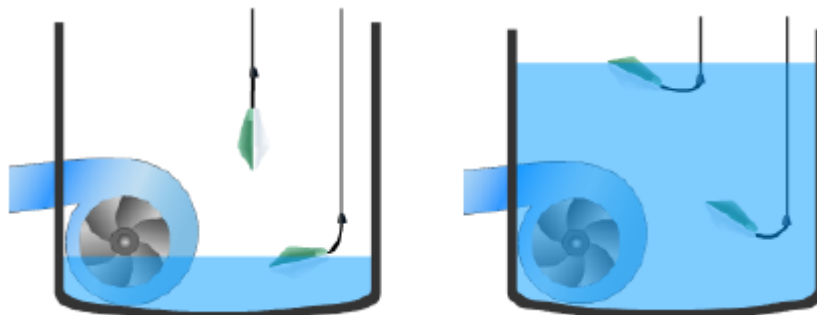

Figure 30: Level switches by using two buoys

Even though the fabricant Grundfos guarantees an NPSH of 4.80 meters, which means that the pump can indeed work without being in contact with water, the level switches will be used to ensure the pump operating conditions.

The buoys locations will be set to 3 and 0.2 meters from the surface inside the water tank to ensure that the system can always operate properly. It is a system quite simple to install and maintain, and it will be located between the pump and the electrical load regulator, in order to guarantee the automated control.

Both switches will be connected in series, as the pump will only operate when both of them are closing the electrical circuit.

Apart from that, the farmer will be in charge to regulate the pump. Another switch will also be connected in series with the level switches, to let the farmer turn on or off the pump whenever wanted.

Finally, the pump itself contains a variable frequency drive (VFD) which will allow the farmer to regulate the velocity of the pump. The system is set to operate at  $Q = 18.31 \text{ m}^3/\text{h}$  and  $H = 59.44$  meters of water column but the farmer will have the possibility to modify the rpm of the pump to increase or decrease the water flow rate manually.

To sum up, the pump control will be composed by two level switches, one on/off switch that the farmer can manually activate and one VFD to change the mass flow rate by increasing/decreasing the angular speed (rpm) of the pump.

Below it is added a summary of all the hydraulic system, in order to have a clear idea of its main components:

- **1 pump** (Grundfos pump SP17-8), that operates at  $Q = 18.31 \text{ m}^3/\text{h}$  and  $H = 59.44 \text{ m}$ .
- **32 rows** of pipes (x 64m/row) + **1 main** pipe (64 m) = 2,112 m of piping, with a **diameter** of 3". Each row is 2 m apart from each other.
- **140 emitters** per row = **4,480 emitters** (18" apart from each other).
- **97 ball valves**.
- **36 T-elbows**.
- **1 non-return valve**.
- **1 filter**.
- **64 cap ends**.
- **2 control switches** (buoy system).

### 3.3.3. Electric System

The design of the electrical system is also an essential part of this work since the pump will be electrically fed from photovoltaic panels that provide direct current (DC), and the pump requires alternating current (AC).

To implement it at Karkata, a solar pack will be purchased with photovoltaic panels, inverter, batteries and charge regulators. It is true that in order to simplify the system you could dispense with the batteries and feed directly from the solar panel. However, what is certain is that the inverter that transforms DC to AC needs constant energy to make a good conversion, and it is difficult for solar panels to provide it as it gives fluctuating energy. Aside from that, it is not appropriate for the pump to switch on and off every time a cloud passes by, since if alternating the on-off state many times it will decrease the lifespan of the system. For these reasons, it is advisable to use a battery of solar energy storage to ensure that the system works with good conditions. On the other hand, if a battery is installed, a charging regulator must be installed in order to prevent the battery from being charged or unloaded to the maximum, thus lengthening its life.

The first thing to do is, then, to calculate the amount of energy that the pump needs. In this case, the pump is a device of variable use, and the energy that it consumes is not given by the manufacturer, as it can be calculated as the product of its power multiplied for the estimated operating time.

Taking into account that we have to supply 600 m<sup>3</sup> of water to the crop during a period of 125 days (this is the most unfavourable case, with sorghum), this gives a value of 0.26 h of irrigating a day.

$$E_{total} = 5,323 (W) \cdot 0.26 \left( \frac{hours}{day} \right) = 1,425 \left( \frac{W \cdot h}{day} \right) \quad (14)$$

This is the energy that will be consumed every day during the non-raining period.

On the other hand, the nominal operating voltage of the installation must be determined. In general, it is recommended to use the following:

- 12 V: for power values less than 1.5 kW
- 24 V: for power values between 1.5 and 5 kW
- 48 V: for power values exceeding 5 kW

In this case, it is intended to supply a power larger than 5 kW, and therefore the nominal operating voltage should be 48 V ( $V_{nom} = 48$  V).

Therefore, the total net consumption of the photovoltaic installation is:

$$c_{total} = \frac{E_{total}}{V_{nom}} = 29.68 \frac{Ah}{day} \quad (15)$$

The energy losses that are generated in the connections of the cables can be taken as a 10% of the total net consumption and, thus, it is considered a loss of energy of 2.96 Ah/day.

Then, the total energy required is:

$$c_{req} = c_{total} + c_{loss} = 29.68 + 2.96 = 32.64 \frac{Ah}{day} \quad (16)$$

On the other hand, they have to be considered also all the possible losses of the photovoltaic installation. The global efficiency of the installation can be calculated using the following formula:

$$K_T = [1 - (K_B + K_C + K_R + K_X)] \cdot \left[1 - \frac{K_A \cdot D_{auto}}{P_D}\right] \quad (17)$$

Where:

- $K_T$  = Global performance
- $K_A$  = Loss due to auto-discharge
- $K_B$  = Loss due to battery performance
- $K_C$  = Loss due to inverter performance
- $K_R$  = Loss due to regulator performance
- $K_X$  = Loss due to the Joule effect
- $D_{auto}$  = Battery autonomy days
- $P_D$  = Depth of battery discharge (%)

As we still don't know what characteristics of solar panels will be implemented, we will take the typical standard parameters that are used to do this calculation of the global performance of the photovoltaic installation:  $K_A = 0.5\%$ ,  $K_B = 5\%$ ,  $K_C = 5\%$ ,  $K_R = 10\%$ ,  $K_X = 10\%$ ,  $D_{auto} = 1$  day and  $P_D = 60\%$ . Therefore, using Formula 17, the total value of the global efficiency of the photovoltaic installation is 0.65 (65%).

Having calculated the global efficiency of the installation, the total consumption required taking into account all the losses can be calculated as:

$$c'_{req} = \frac{c_{req}}{K_T} = 50.22 \frac{Ah}{day} \quad (18)$$

Once we know the total consumption required (taking into account all the losses of the installation), now we can design the installation of the solar panels.

The solar irradiation that reaches Karkata in the worst case is 4.3 kWh/m<sup>2</sup>/day at an optimal angle of 5° during the month of July, and, as an average, an optimal angle of 27° is required, according to Table 3 in Section 2.3.3. As a result, the minimum irradiation that will be obtained is:

$$I_{min} = 4.3 \frac{kWh}{m^2 \cdot day} \cdot \cos(27) = 3.83 \frac{kWh}{m^2 \cdot day} \quad (19)$$

However, only 94% of this irradiation will be able to get captured, the rest are losses. Consequently, the minimum design irradiation will be: 3.60 kWh/m<sup>2</sup>/day.

Having calculated the minimum design irradiation, now we can calculate the number of panels in parallel that can be placed in order to provide this energy:

$$n_{pp} = \frac{c'_{req}}{\aleph \cdot I_{mp} \cdot HSP} \quad (20)$$

Where:

- $n_{pp}$  = Number of panels in parallel
- $c'_{req}$  = Total consumption required
- $\aleph$  = Efficiency of the photovoltaic module
- $I_{mp}$  = Current that supplies the panel at the peak power point
- HSP = Peak solar hours

The efficiency of the photovoltaic module ( $\aleph$ ) is the efficiency that must be considered due to the dirt deposited on the glass and reflection and opacity losses. It is usually taken a value of 94%. The current that supplies the panel at the peak power point ( $I_{mp}$ ) can be taken as 8 A. And, finally, the peak solar hours (HSP), which is the number of hours that it should be an irradiation of 1,000 W/m<sup>2</sup> in order to equal the incident solar energy per day in a specific point of the planet, has the value of 4.02.

Therefore, using Formula 20,  $n_{pp} = 3.46$ . This leads to a total number of panels in parallel needed of 4.

The number of panels in series can be calculated as follows:

$$n_{ps} = \frac{V_{nom}}{V_{mp}} \quad (21)$$

Where:

- $n_{ps}$  = Number of panels in series  
 $V_{nom}$  = Nominal voltage  
 $V_{mp}$  = Voltage at the maximum power point

$V_{nom}$ , as explained above, is 48 V, whereas  $V_{mp}$  depends on the panel and it will be taken a value of 60 V. As a result, as per Formula 21, the number of panels in series needed is 1 ( $n_{ps} = 0.8$ ).

Hence, the total number of panels needed in this installation is:  $n_{pt} = n_{pp} \cdot n_{ps} = 4$ . Taking into account that each panel occupies a total area of 1.5 m<sup>2</sup>, all the set of panels will occupy an area of 6 m<sup>2</sup>.

Now that the number of photovoltaic panels has been calculated, we can proceed to calculate the battery, inverter and regulator.

For the calculation of the battery, the following parameters must be determined: duration of discharge, discharge current, operating temperature and voltage.

First, we must size the duration of discharge. In a permanent regime, the system will have to pump water for 0.26 hours a day, supposing the crop requires constant irrigation. However, as there might be cloudy days, the capacity of the battery will have a capacity for 2 days, which corresponds to 0.52 hours of duration. However, when water is not needed, the circuit will be opened and the pump will not receive more electricity.

Therefore, the storage capacity is:

$$c_e = \frac{c'_{req} \cdot D_{auto}}{P_D} \cdot 100 = \frac{50.22 \cdot 2}{0.6} \cdot 100 = 167.40 \text{ Ah} \quad (22)$$

The depth of battery discharge is advisable to be 60-70%, since if the battery is discharged even more; its lifetime will be decreased.

After this, now we can calculate the number of batteries that are needed. If we choose a basic battery, from *Luminous* supplier to put an example, with a capacity of  $c_{bat} = 150$  Ah and voltage of  $V_{bat} = 12$  V, we can calculate the number of needed batteries as follows:

- Number of batteries in parallel:  $n_{bp} = \frac{c_e}{c_{bat}} = \frac{326,55}{150} = 2.11 = 3$  battery in parallel.
- Number of batteries in series:  $n_{bs} = \frac{V_{nom}}{V_{bat}} = \frac{48}{12} = 4$  batteries in series.

Therefore, the total number of batteries needed is  $n_{bt} = n_{bp} \cdot n_{bs} = 12$ .

Now that the battery system has already been sized, we should determine which charge regulator should be used. The charge regulator (or charge controller) is the element that controls the charge and discharge process of the battery.

The regulator is the element that is located between the panels and the inverter that connects with the pump. Hence, it will be designed according to the intensity that has to bear:  $I_g = 1.2 \cdot n_{pp} \cdot I_{mp} = 1.2 \cdot 4 \cdot 8 = 38.4 A$ .

The consumed current by the pump:

$$I_L = \frac{P_{bomba}}{\eta_{inv} \cdot V_{nom}} = \frac{5,323}{0.95 \cdot 48} = 116.73 A \quad (23)$$

A security factor of 20% should be applied to the provided current by the photovoltaic installation and we should take a 95% for the inverter's yield. Therefore, the minimum current that the charge regulator should bear is 116.73 A ( $I_{reg} = \max\{I_g; I_L\} = 116.73 A$ ).

On the other hand, we need to design the inverter, which transforms the direct current into alternating current. As mentioned before, the inverter's yield is 95% and, thus, the inverter's power can be calculated like this:

$$P_{inv} = \frac{P_{bomba}}{\eta_{inv}} = \frac{5,323}{0.95} = 5,603.15 W \quad (24)$$

It has to be chosen a sinusoidal-wave inverter of 50 Hz (the pump requires it) with a minimum power of 5,604W. In addition, it is considered an ideal power factor close to  $\cos(\varphi)=1$  because the pump will only consume active power.

Below it is added a summary of all the electric system, in order to have a clear idea of its main components:

- **4 solar panels** with  $I_{mp} = 8 A$  and  $V_{mp} = 60 V$ .
- **12 batteries** with  $C_{bat} = 150 Ah$  and  $V_{bat} = 12 V$ .
- **1 regulator** with a minimum current of 116.73 A.
- A minimum 5,604 W **power inverter** that converts the DC into a pure sinusoidal-wave frequency of 50Hz.



### 3.4. TANK 3D DESIGN AND INSTALLATION DIAGRAM

In this section of the project, a 3D design of the tank has been done with SolidWorks, a solid modelling computer-aided design (CAD) and computer-aided engineering (CAE) computer program.

With this software we have been able to create a 3D model of the tank and wall, with all the measures that have been described in Section [3.3.1](#), that can be summarized in the following table:

**Table 23. Summary of the final measurements and details of the tank and wall in order to do the 3D model**

TANK	WALL
<ul style="list-style-type: none"> <li>- Shape: frustum cone</li> <li>- Volume (V): 600 m<sup>3</sup></li> <li>- Surface (S): 200 m<sup>2</sup></li> <li>- Height (H): 4 m</li> <li>- External radius (R): 8 m</li> <li>- Internal radius (r): 5.7 m</li> <li>- Angle (<math>\alpha</math>): 60°</li> </ul>	<ul style="list-style-type: none"> <li>- Height (h): 0.5 m</li> <li>- Width (w): 0.25 m</li> <li>- Inlet: 5 inlet holes, diameter: 0.2 m</li> <li>- Outlet: 2 outlet holes, diameter: 0.2 m</li> </ul>

With all these measures in mind, a 3D model has been designed in order to have a better idea and understanding of how is going to be the design of the solution.

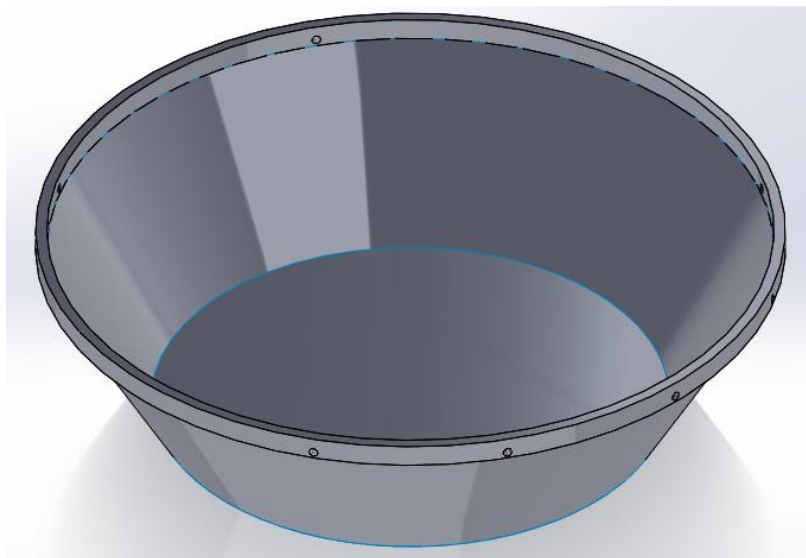

**Figure 31. Isometric view of the tank + wall and all its details**

In Figure 31 it can be seen the isometric view of the tank and wall with all its details of inlet and outlet holes. And in [Annex III](#), it has been added the drawing of this design in order to show all the measurements and exact details of the model.

Finally, and as a summary of everything that has been detailed in this Section 3 regarding the design of the installation, the following figure shows the diagram of the electrical and hydraulic systems, joint with the tank, in order to understand how the entire installation of the project works properly.

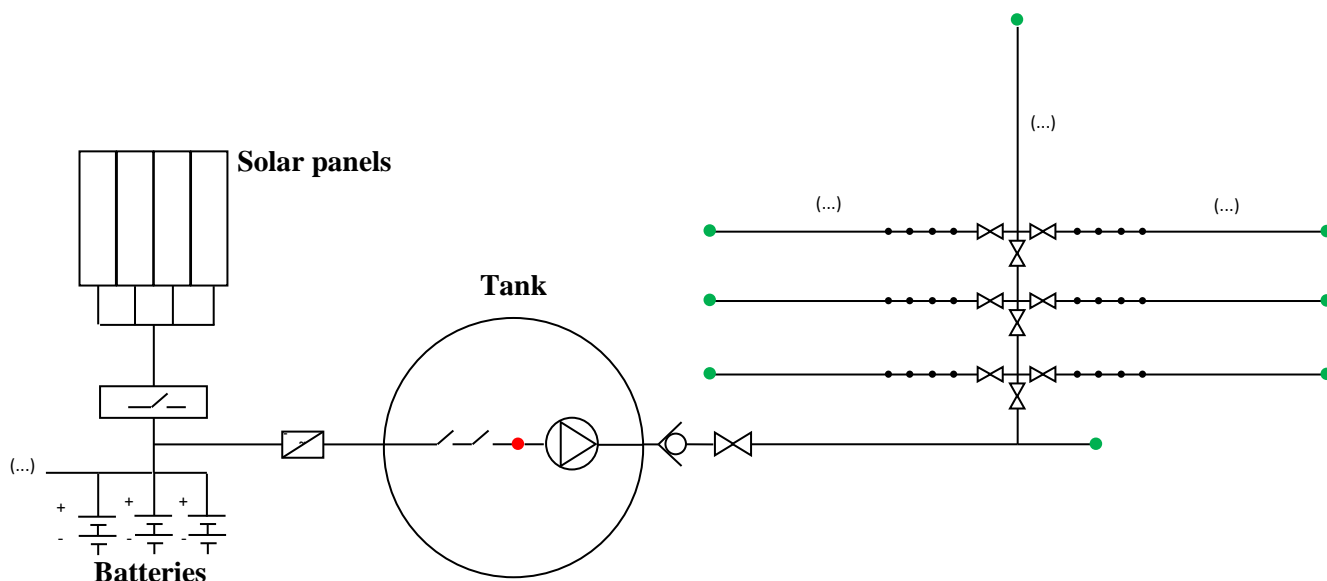











Figure 32. Hydraulic and electric diagram

In the following table, it has been added the legend of every item that has been included in this diagram, in order to have a clear understanding of each part of the installation.

Table 24. Legend of the hydraulic and electric diagram

Legend	
	Pump
	Ball valve
	Non-return valve
	Filter
	Cap end
	Control switches
	Regulator
	Power inverter
	Emitters

## 4. BUDGET

In this chapter of the project, it will be detailed the total budget of the whole installation of the proposed design. In this first table added below (Table 25) are shown all the prices of the materials (permanent equipment), including the tank, wall, hydraulic system and electric system.

Table 25. Budget for permanent equipment (\*)

USED IN	Item	Details	Number and unit	Supplier	Price x unit	Total price
<b>TANK</b>	Water reservoir	$V = 600 \text{ m}^3$	1	-	₹ 300,000	₹ 300,000
<b>HYDRAULIC SYSTEM</b>	Pump	$Q = 18.31 \frac{\text{m}^3}{\text{h}}$ $H = 59.44 \text{ m}$	1 unit	Grundfos	₹ 27,300	₹ 27,300
	Pipes	$\phi = 3''$	2,112 m	Finolex	₹ 16	₹ 33,792
	Ball valves	-	97 units	Gokul Plast	₹ 17	₹ 1,649
	“T”-elbow	-	36 units	Vision Agritech	₹ 1	₹ 36
	Non return valve	-	1 unit	Super Fasteners Industries	₹ 250	₹ 250
	Filter	-	1 unit	Ecoaqua Engineering System	₹ 500	₹ 500
	Cap ends	$\phi = 3''$	64 units	Gokul Plast	₹ 0.45	₹ 16.2
	Control switches	-	2 units	D.B Instruments & Controls	₹ 550	₹ 1,100
<b>ELECTRIC SYSTEM</b>	Solar panels	$I_{mp} = 8 \text{ A}$ $V_{mp} = 60 \text{ V}$	4 units	Luminous	₹ 12,200	₹ 48,800
	Batteries	$c_{bat} = 150 \text{ Ah}$ $V_{bat} = 12 \text{ V}$	12 units	Luminous	₹ 14,500	₹ 174,000
	Regulator	$I_{reg} = 116.73 \text{ A}$	1 unit	Luminous	₹ 1,990	₹ 1,990
	Power inverter	$P_{inv} = 5,604 \text{ W}$	1 unit	Luminous	₹ 8,400	₹ 8,400
<b>Total budget for permanent equipment</b>						<b>₹ 597,833</b>

(\*) As per June 2019

In addition to permanent equipment, it has to be taken into account other expenses such as manpower, consumables, travel and accommodation, contingencies, etc.

In the following table, it is shown a summary of the final detailed budget for each of these expenses, separated in recurring and non-recurring.

**Table 26. Detailed budget of the project (\*)**

Type	Item	Total
<b>Recurring</b>	1) Manpower (5 manpower)	₹ 30,000
	2) Consumables (cement, wires, stationary)	₹ 309,000
	3) Travel and accommodation (project logistics, field activities, village travel, others)	₹ 93,000
	4) Contingencies (maintenance equipment, others)	₹ 30,000
	5) Other	₹ 20,000
	6) Overheads	₹ 49,620
<b>Non-recurring</b>	1) Permanent equipment (Table 25)	₹ 597,833
	2) Construction of work shed/structure	₹ 10,000
<b>Grand Total</b>		<b>₹ 1,139,453</b>

(\*) As per June 2019

It has been thought that for the implementation, 2 tanks should be implemented in different parts of the village. In this way, it will be possible to test that this design works correctly in two different locations (one closer to the river and the other one farther). This would imply a total value for the implementation of  $₹ 1,139,453 \times 2 = ₹ 2,278,906$ .

Although this total value for the installation of two tanks and all their installation might seem big, Government of India is giving several subsidies for water management issues. In particular, Scheme n° 6 of the Agricultural Engineering Schemes under Agricultural Engineering Department [17] “Rain Water Harvesting and Runoff Management Programme”, gives benefits of 100% grants on the cost of works taken up in community lands. Beneficiaries are required to contribute 10% of the cost of works in cash which will be deposited in the name of the Village Development Association / Watershed Association for future maintenance of the assets created.

Being this the case, we should apply for this subsidy regarding Scheme n° 6, and the investment that should be done would be 10% of the total amount.

Total investment:  $10\% \cdot ₹ 2,278,906 = ₹ 227,890$ .

## 5. CONCLUSIONS

As a conclusion, and to finalize this project, the results that have been obtained in each section of this thesis will be analyzed and a final joint assessment will be made.

The first thing that was done in this project was to locate the village of Karkata geographically in order to focus the study.

Once the village was located, it was described the current situation of Karkata in terms of education and water, mainly thanks to the visit that we made last March and all the co-design workshops that we carried out, tools that I really find very interesting and useful in order to understand the real problems of the inhabitants. In addition to this, it was set out a detailed description of the objective situation that we want to reach with this project, a very important point in order to guide the thesis on the right track.

Moreover, it was also interesting to analyze all the physical characteristics of the area, which would later provide support for all the analysis of the design alternatives and the different ways of obtaining energy, considering solar energy as the source of power for our final solution.

As a result of all these studies, a design was given in order to solve this problem, based on a rainwater harvesting system. In order to be a totally sustainable proposal and according to the villager's capacities and needs, the design includes all the sizing of the installation for both the tank that is going to be used for storing the rainwater and the hydraulic and electrical systems.

In addition to this study of the design, this project includes a detailed budget including consumables, permanent equipment and manpower, among others. It has been considered that the investment should be made to implement 2 tanks in different regions of Karkata, to be able to prove that the design works under different conditions.

Although this budget may seem initially high, it must be taken into account that the Government of India is investing in the improvement of the conditions of farmers in the rural areas of the country. Specifically, Scheme n°6 of the Agricultural Engineering Schemes under Agricultural Engineering Department "Rain Water Harvesting and Runoff Management Program", provides benefits of 100% grants on the cost of works taken in land communities. That is why it is believed that when it comes to making this project, the fact of being able to benefit from the aid that the Government of India is granting is of great importance.

Finally, and as a personal conclusion, this project has been a challenge for me, as each step that we wanted to move forward many alternatives of design were opened, which made it more difficult to have a final concessive solution. In the end, however, I was able to satisfactorily

complete a good design and hydraulic calculation, complemented with a small dimensioning of an electrical solar installation.

This thesis has been carried out within Live-in-Labs program, which has several projects going on. Although I have taken this project in a very early phase, doing basically a theoretical study, I hope that this is only the start of the project and it will be continued to finally meet its final objective, help improving the lives of the inhabitants of Karkata. I really hope to have contributed to achieve this.

## 6. FUTURE WORK

After having completed the project, the following step would be the implementation of this design in the village of Karkata. However, there could be an intermediate step that could make the design even better by reducing all the possible errors made during the design process.

This intermediate step should be the creation of a small scale prototype that would allow verifying the correct functioning of the design, both the shape and measurements of the tank and the wall, as well as the entire hydraulic and electrical system.

Creating a prototype would allow to test the design and confirm the hypotheses taken during the project, which would lead to a reduction of the possible errors when making the final implementation. Although one might think that the fact of making a prototype is an investment in vain since it won't have any other use than testing, the fact of finding errors in the small scale prototype allows not repeating the errors in the implementation phase, in a large scale, which can significantly reduce all its costs.

## REFERENCES

- [1] World Vision India. (2016). *NO WATER AND NO WILL, An analysis of the impact of drought on India's children*. Available:  
[https://www.worldvision.in/CMSAdmin/Uploads/09022017011254572wv\\_drought\\_report2016.pdf](https://www.worldvision.in/CMSAdmin/Uploads/09022017011254572wv_drought_report2016.pdf)  
[Accessed: 03-06-2019]
- [2] United Nations, Department of Economic and Social Affairs, Population Division. (2017). *World population prospects*. Available:  
<https://population.un.org/wpp/Download/SpecialAggregates/Ecological/>  
[Accessed: 27-03-2019]
- [3] CENSUS 2011. (2011). *Karkata Population – Ranchi, Jharkhand*. Available:  
<https://www.census2011.co.in/data/village/373999-karkata-jharkhand.html>  
[Accessed: 27-03-2019]
- [4] Brouwer, C. & Heibloem, M. (1986). *Irrigation water management, Training manual no. 3*. Chapter 2. FAO 1986. Available:  
<http://www.fao.org/3/s2022e/s2022e02.htm#TopOfPage>  
[Accessed: 05-04-2019]
- [5] Weather Atlas. (2002-2019). *Monthly weather forecast and Climate: Ranchi, India*. Available: <https://www.weather-ind.com/en/india/ranchi-climate>  
[Accessed: 01-04-2019]
- [6] Joint Research Centre (JRC), European Commission. *Photovoltaic Geographical Information System (PVGIS)*. Available:  
<http://re.jrc.ec.europa.eu/pvgis/apps4/pvest.php?map=africa>  
[Accessed: 01-04-2019]
- [7] Meteoblue. (2006-2019). *Climate Ranchi*. Available:  
[https://www.meteoblue.com/en/weather/forecast/modelclimate/ranchi\\_india\\_1258526](https://www.meteoblue.com/en/weather/forecast/modelclimate/ranchi_india_1258526)  
[Accessed: 01-04-2019]
- [8] Wikipedia, The Free Encyclopedia. *Beaufort scale*. Available:  
[https://en.wikipedia.org/wiki/Beaufort\\_scale](https://en.wikipedia.org/wiki/Beaufort_scale)  
[Accessed: 05-04-2019]
- [9] Live-in-Labs program group, guided by Dr Soundharajan. *Soil sample testing*.



- [10] Barikar, U. (2012). *FARM PONDS: A Climate Resilient Technology for Rainfed Agriculture. Planning, Design and Construction*. Available:  
[https://www.researchgate.net/publication/289524632\\_FARM\\_PONDS\\_A\\_Climate\\_Resilient\\_Technology\\_for\\_Rainfed\\_Agriculture\\_Planning\\_Design\\_and\\_Construction](https://www.researchgate.net/publication/289524632_FARM_PONDS_A_Climate_Resilient_Technology_for_Rainfed_Agriculture_Planning_Design_and_Construction)  
[Accessed: 05-05-2019]
- [11] Brouwer, C. & Heibloem, M. (1986). *Irrigation water management, Training manual no. 3*. FAO 1986. Available: <http://www.fao.org/3/s2022e/s2022e00.htm#Contents>  
[Accessed: 05-05-2019]
- [12] Brouwer, C. & Heibloem, M. (1986). *Irrigation water management, Training manual no. 5*. FAO 1986. Available: <http://www.fao.org/3/s8684e/s8684e00.htm#Contents>  
[Accessed: 07-05-2019]
- [13] Kisekka, I. & Oker, T. & Nguyen, G. & Aguilar, J. & Rogers, D. (2017). *Revisiting precision mobile drip irrigation under limited water*. Available:  
<https://link.springer.com/article/10.1007/s00271-017-0555-7>  
[Accessed: 29-05-2019]
- [14] Climate Technology Centre & Network (CTCN). *Drip Irrigation*. Available:  
<https://www.ctc-n.org/technologies/drip-irrigation>  
[Accessed: 29-05-2019]
- [15] Zhang, H. (2002). *Managing water productivity in semi-arid areas*. Available:  
[www.iwmi.cgiar.org/assessment/files/word/proposals/abstracts/paperhepingNEW.doc](http://www.iwmi.cgiar.org/assessment/files/word/proposals/abstracts/paperhepingNEW.doc)  
[Accessed: 09-05-2019]
- [16] Grundfos. *SP submersible groundwater pump*. Available:  
<https://au.grundfos.com/products/find-product/sp.html#overview>  
[Accessed: 24-05-2019]
- [17] TNAU AGRITECH PORTAL. *Agriculture Engineering schemes under Agriculture Engineering Department*. Available:  
[http://agritech.tnau.ac.in/agricultural\\_engineering/agriengg\\_govt\\_schemes.html](http://agritech.tnau.ac.in/agricultural_engineering/agriengg_govt_schemes.html)  
[Accessed: 10-06-2019]

# ANNEXES

## I. Field Journal

The main purpose of this visit was conducting a **co-design** workshop. Co-design is a participatory technique that allows getting the requirements directly from the main users so that they can remain the centre of the solution. Co-design helps in deeply understanding the problem, trial solutions and to gauge effectiveness. This technique enables a wide range of people to make a creative contribution to the formulation and solution of a problem, and that is exactly what we did in Karkata.

The steps involved in co-design include:

1. Problem definition: a clear definition of the problem from the user perspective
2. Recruitment: hiring labour force from among the beneficiaries
3. Planning: detailed planning alongside the important stakeholder members
4. Mock trials: generate prototypes of the proposed plan in order to generate awareness and to best understand the effectiveness of the solution proposed
5. Synthesis: analyze the data obtained from the prototype to further develop modifications and changes to the solution to enhance the idea

The main purpose of carrying out co-design is to ensure that the stakeholders are on the same page as the researchers or developers. In a project of this type, one of the main reasons why it might not be a successful project is because the developers might not understand the problem correctly or not take into account the end-user when designing the solution. If this happens, villagers, who have been living for decades dealing with this situation, may not find the utility to the solution provided and don't use it at all, which would lead to a total unsuccessful project and investment.

The different tools used for successful co-design workshops include poster cards, mind map, role play, journey map, storytelling, design games, character profiles, group sketching, and modelling/rough prototyping. This group used some of these tools during this second visit to the village and the description of each one of them will be explained below.

### Target group specifics

Our target group was mainly the women of the village, as they are basically the ones who work the most in the house and go fetch water from the wells, apart from working in the fields during the rest of the day.

From the beginning, we thought that women of Karkata could be the perfect target for our co-design workshops in order to get the maximum information about the problem with water of the village, their own daily experience with it and get a better understanding together of how it could be solved.

### Daily activities

As it was detailed above, our second visit to the village was in March 2019. We left Ettimadai Campus in March 14<sup>th</sup> around 3 am and we came back on March 23<sup>rd</sup> at 1 pm. Although we had 10 days of travel, only 5 of them were useful days in the village, the rest were travelling days to reach Jharkhand by train, days that we used to plan even more things for the visit to Karkata.

Below will be explained with detail the activities that were carried out daily during our stay in the village:

#### DAY 1

Our first day was used for getting familiar with the village and the villagers. We took some walks around Karkata, we introduced ourselves to the locals, we met some social change agents, and we arranged everything for the following day. We were told that around 50 women would come the following day and we should meet them around 9 am.



Figures 1, 2 and 3. From left to right: Road to the village of Karkata, non-drinkable water well, drinkable water well

We also used that afternoon to go to the outskirts of Ranchi to buy all the material that we needed for doing all the activities, which was: chart papers, crayons, markers, zeal, balloons, and some sweets to give to the people who came to the workshops.

#### DAY 2

Day 2 was the first day of the co-design workshop and around 40 people came to the Tuition Centre, where we were planning to do the activities. Most of them were women, but some men

of the village came too, which gave some diversity to the group, including the head of the village.

The first thing that one has to do when starting any activity with a group of people that one barely knows is using an icebreaker, and that is what we planned to do every day before starting the workshop activities. That first day of the workshop we played a game that consisted of seating on the floor in a circle and pass the balloon while the music was on. If the music stopped and you had the balloon on your hands, then you had to sing a song in front of the whole group. It is true that at first was a bit difficult, but the icebreaker made its effect because it became easier with time. We sang some songs in different languages like Hindi, Malayalam, and Spanish, and some of the women sang in groups if they were too shy to do it alone.

Once the icebreaker made its effect and we all felt more comfortable with each other, the workshop itself started. That day we planned to use the **mind map** tool, with which we believed that we could get a lot of information regarding the inhabitants' problems with water.

We separated all the participants in 4 small groups and we explained to them what the initial idea from where to start off the mind map activity was. The idea in which they had to think was an ideal situation in which they had water throughout the year and they did not have any restrictions to use it.

Before the activity even started, we already thought about the main topics that we wanted to get out of this activity (agriculture, pain points, education, time-management, money and specific use of water). We believed that it is very important to always keep in mind what path you want to take, in case you need to redirect the activity, you can focus on the points that you want to extract from that. However, it is very important also that all those points come from them and you don't influence their answers. That is why we let them say whatever came up to their minds and most of those points were brought up to the conversations.



Figures 4 and 5. On the left, all the participants playing the icebreaker with the balloon. On the right, the villagers doing the mind map activity

We detail below all the ideas that they brought up to the conversations regarding all these topics:

1. Agriculture was the first point that came up to their minds when thinking about water. If they had more water, they would use it for cultivating more vegetables and other crops during all the year. It would make them more self-dependent, they would get more money and they would spend that money on the education of their children.
2. In summer, only 1 drinkable-water well is usable, all the other ones dry up. They use that well for drinking, bathing, and cleaning. If there were different places to take water instead of just 1 during the summer season, it would be easier and faster for them.
3. In the past, they used to have fish in the ponds. However, nearly all of the ponds dried up completely, which made all the fishes die. They said that if they had enough water during all the year in the ponds, they would love to have fish there in order to get more nutritious food for them and their families.
4. They told us that if they had more water and could cultivate more crops throughout the year, that would give them more money. Some of that money they would spend it in the education of their children, as it was detailed above, and they would want to save the rest. That shows sustainable thinking in the villagers.
5. They proposed some ideas for having more water: water storage, sumps, more profound ponds, check dams, and rainwater harvesting. This is a very important point because it means that they believe that a solution to the problem can be reached.
6. They said that if they didn't have to spend all that amount of time to go fetch water from the wells, they would spend that time for doing better things, being with their families, etc.
7. They detailed some pain points: in rainy season the wells get polluted and the villagers have some diseases (fever and diarrhoeas), in the summer season they have to go to the city and get daily wage jobs in which they earn less money and they have to spend long hours, the water that comes from hand pumps is muddy and non-drinkable, they don't drink water from the river because it is polluted (others use it for bathing, washing clothes, defecating, etc), the path to the main drinking well is not in a good state, among others.

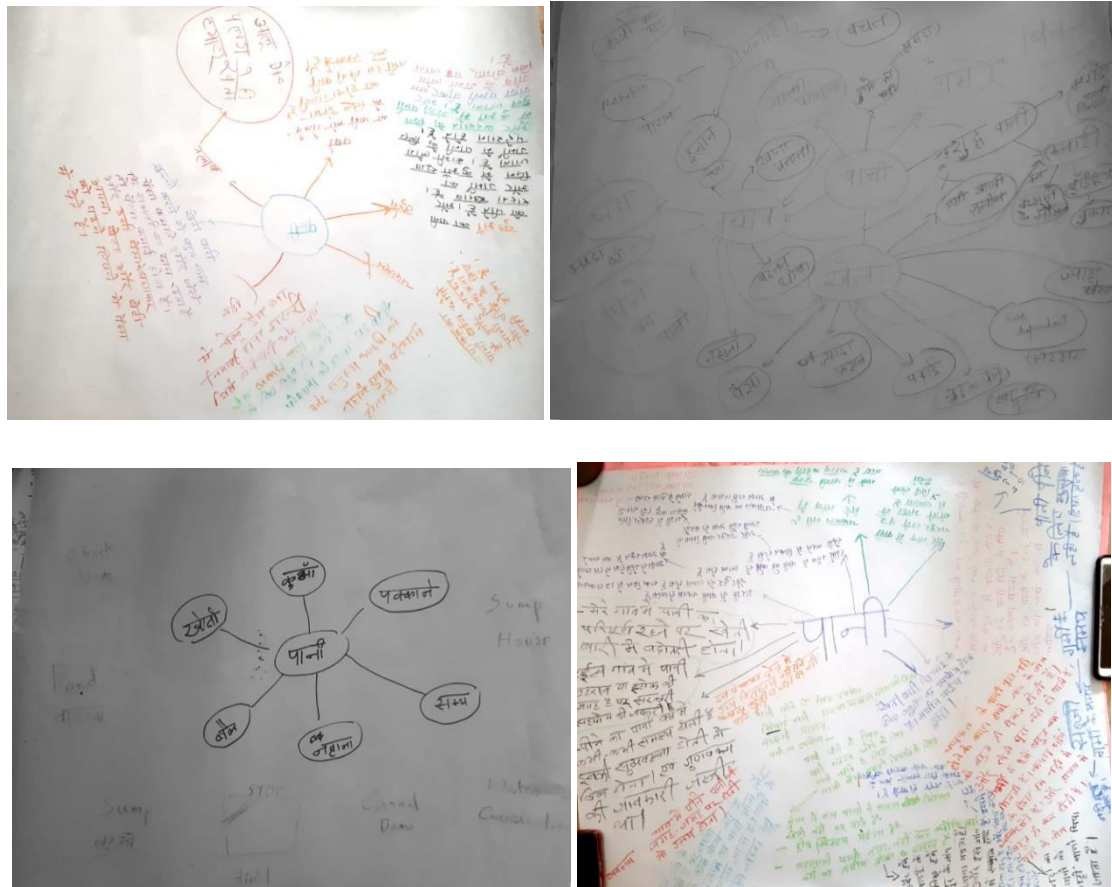

Figures 6, 7, 8 and 9. Chart papers with the final information from the mind map activity of the 4 groups

Overall, that activity was very successful as we got a lot of ideas coming from them. They opened up to us, detailed all the problems that they have regarding water, and showed us their willingness to have a change and their beliefs that it can be solved.

After the first day of the workshop which lasted around 2-3h, we returned to have lunch to Dewgain, a little village 2km away from Karkata where we were staying. That afternoon it started raining heavily and we stayed in the school of Dewgain, putting together all the information extracted from the different groups, and planning what we would be doing the following day in the next activity of the workshop.

### DAY 3

Day 3 was the second day of the workshop and, just like the day before, everything started with an icebreaker. That day we planned a different icebreaker which consisted on walking around the room with the music on and when the music stopped, someone would say a number and you had to join a group with that number of people. If someone was left without a group, that person (or more than one) should sing in front of the others. Like the day before, we sang songs in different languages, and the vast majority sang in groups to overcome the shyness.

Once we did the icebreaker, we separated the participants in the same groups as the day before. That day didn't come all the participants from day 2, but most of them were there and we could perfectly do the second activity with the same groups as the day before.

Our second activity of the workshop consisted of **group sketching**. At first, we wanted them to do 2 different sketches that consisted on drawing the village on a normal summer day and, the second one, drawing the village in an ideal summer day. We wanted them to do both in order to see the differences and see how they would consider an ideal village in an ideal situation.

However, things don't always go as planned and we couldn't do what we initially wanted. When we separated into different groups, some groups had problems to start the activity. There were people who did not participate at all, didn't draw and didn't know how to start. That is why the activity took longer than expected initially and we only had time to do the first sketch. In several groups, we had to join them, draw and paint with them so that they felt more comfortable doing it.

Although we only had time to do the first sketch, we extracted some good information from the different groups regarding a normal summer day in the village of Karkata:

1. In a regular summer day, you will find empty fields, empty wells and empty school.
2. The river is completely dried up; it only has small pools of water.
3. They have to use umbrellas and the shadows of trees to protect themselves from the sun and high temperatures.
4. The hand pumps have muddy water and not usable at all during that season.
5. Most of them have to take an auto to go to the city to find a daily wage job.
6. They sometimes dig a hole in the river and use the percolated water for drinking.







Figures 10, 11, 12 and 13. Chart papers with the final information from the group sketching activity of the 4 groups

Although that morning didn't go as planned and we couldn't do what we were thinking initially, some good information was extracted and we learned even more about all their problems regarding water during the summer season.

After having lunch, we went back to Karkata to collect some data from the village. We separated into 2 groups and we did a **resource map** from East and West part of the village.

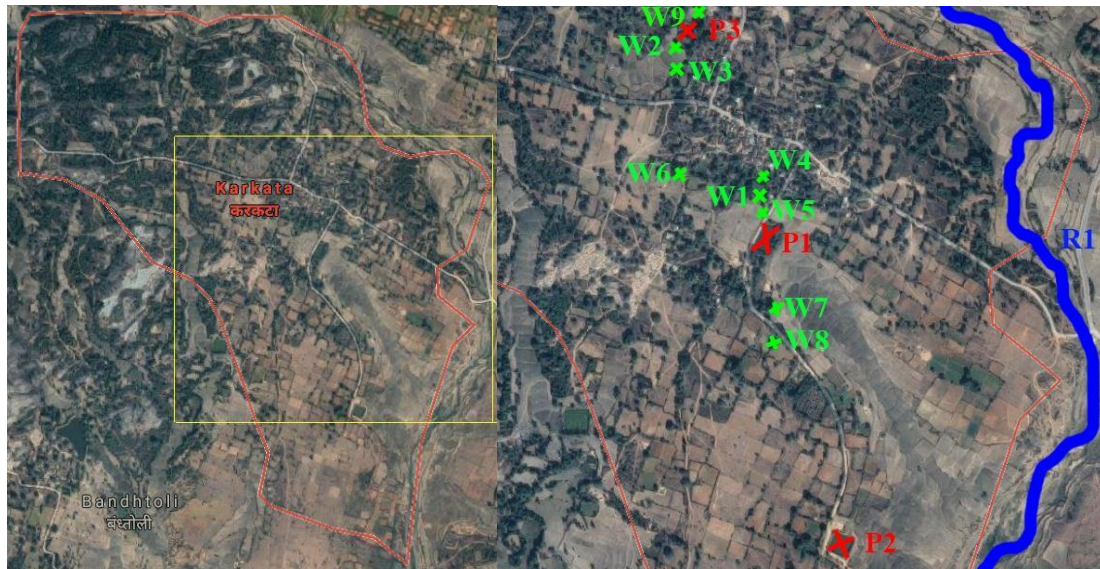

Figures 14 and 15. On the left, the map of Karkata with a squared zoom in the region of study. On the right, the squared region zoomed in order to localize the water resources (blue: river, red: ponds, green: wells)

#### DAY 4

Day 4 started with a new icebreaker that consisted of sitting in a circle, facing the entire group and no smiling. If you smiled for some reason, you "lost" and you had to sing in front of the others. This was a fun icebreaker because we made them laugh a lot and the icebreaker made its effect rapidly.

The activity that we did that day was **storytelling**. We separated all the participants in the same groups as the previous days and we asked them to write in a paper some stories that came up to their minds about some problems they had, their families, neighbours or others, related to water. With this activity we wanted to know first-hand real stories that the inhabitants of Karkata had to face in the past, to see if they usually had the same problems, if we think that they could be solved with our proposals in some way, etc.

It must be said that in the state of Jharkhand the literacy level is 66.01% [1] and some of the participants of the groups did not know how to write, especially the older ones. At first, we told them to think about what they wanted to say and we would write it down for them. However, we realized that they were more confident telling all those stories to people from the village instead of us, so that is exactly what we did. We asked the participants who did know how to write, to write the stories of those who couldn't, and we came to a very good situation in which everyone wrote all their stories.

This activity let them free to express what they felt it was important, which was pretty good in some way, but this freedom made us have lots of stories not related at all with water too. Although it may seem that this activity wasn't very successful, some interesting stories were detailed:

1. One man named *Budu Boukat* explained that several years ago there was a very dry summer and they didn't have any water in the village. He detailed in his story that kids cried all day for that reason and people had to go to the river, dig a hole in the soil and drink percolated water from there.
2. A woman named *Anima Lakra* explained that in 2010 none of the crops sown sprout because of the lack of water throughout that year. People got dehydrated and many animals died.
3. Another woman named *Vinita Vakla* detailed in her story that in 2018 there wasn't any water and they couldn't work on agriculture, there was no rice to eat and no money to buy nearly anything. Some children couldn't go to school because of that.
4. Finally, another girl named *Muni Thirki* wrote that she had to go to the city every summer to find daily wage jobs, she had to be there for several hours and some days she didn't even find a job and she had to return home, having to pay for the travel expenses.

That afternoon we stayed at Dewgain to share all the information we had and see, among all, what was the possible solution that we could extract from all that.

We separated the different problems in 2 types: education and water. And inside the problem of water, there were 2 more types: drinking water and water for agriculture.

All of those problems present a serious situation for the village and a solution is necessary, but this project will be focused on the problem of water for agriculture since it is believed to be the main problem of the village, which brings the most obstacles to the inhabitants of Karkata. Added to that, we strongly believe that if this problem is solved, part of the other ones could be solved too, with the social and economic impact that could be extracted with this.

With that in mind, we came up with the idea of a tank for harvesting rainwater. We knew that there are some tanks in the market for harvesting rainwater but we wanted to do it special and totally functional: use some mechanism for opening and closing the tank in order to prevent evaporation, put some IoT sensors to know when the tank should be opened (weather conditions), use some kind of filters and pipes in order to collect runoff water from neighbouring fields, among others.

That was our first idea but, of course, that should come from the villagers themselves and all together come to a final idea for a solution.

## **DAY 5**

Day 5 was the final day of the workshop and we, again, did a new icebreaker that consisted on passing the balloon with just one hand, and if the balloon fell to the floor, you had to dance.

The last day of the workshop, once the icebreaker was done, began with a summary of everything we had learned from the previous days. We explained in detail what the problem that they had transmitted to us was, and everything that we extracted from each activity done in the previous workshop days.

After making this brief summary of everything done thus far, we all sat down to do a brainstorming about possible solutions. They quickly reached the rainwater harvest solution and they felt that it was absolutely necessary. We used that moment to explain to them our idea, which consisted basically of harvesting rainwater and having a mechanism for opening/closing to prevent evaporation. We didn't want to give more details because we didn't know exactly how the final solution would be, so we didn't want to give a lot of details and maybe have another thing at the end. The first thing that we wanted to ensure was the trust of the villagers.



**Figures 16 and 17. On the left, our group sat down with the villagers looking for some possible solutions and doing some sketches. On the right, the final sketch that we did to show how the water tank would work**

They also told us that they thought it would be a very good idea to collect water from the river in order to irrigate the fields. However, taking water from the river involves other impediments that should be solved beforehand, such as requesting authorization from the authorities. In addition to that, the worst water problems are always in the summer season and, at that time, the river also dries up and this could not be a viable option for this time of drought.

When the workshop finished, they were the ones that surprised us. They sang a song to us, gave us some flowers, painted our faces and gave us some sweets. It was a very special and emotional moment in which they showed us that they really appreciated what we were doing there. It was very exciting to see that our work there was being valued by the inhabitants of Karkata.



**Figures 18 and 19. On the left, the villagers singing a song to us. On the right, our team with the flowers that the villagers gifted us**

That afternoon, and we explain this as an anecdote since it has nothing to do with the co-design workshop, we went to Karkata again. We went to the Tuition Centre because every afternoon some of the children from the village went there to take classes. We stayed there for about 2

hours and we played with them, sang, danced, and painted. It was an unforgettable experience that made us feel even closer to the inhabitants of Karkata.



Figures 20 and 21. Photos of us in the Tuition Center playing and painting with some kids from Karkata

### DAY 6

Although the 6<sup>th</sup> day was travelling day, we used that morning to collect some final data from the village. We went again to the village and collected some soil samples in order to do some testing once we arrived at the college.



Figure 22. Location of the 3 soil samples

As can be seen in Figure 22, we took 3 soil samples from different places. We took these 3 samples because they were from three completely different sites regarding the location, altitude, and distance to the river, being the soil sample number 3 the closest to the Tunju River.

In addition, and we explain this as a mere anecdote too, that day was March 21<sup>st</sup> and in the North of India, they celebrated the Holi Festival. Children from Dewgain and Karkata played with us and painted our faces, a fact that made our last day in the villages even more special.



Figures 23 and 24. Kids playing Holi

### Output

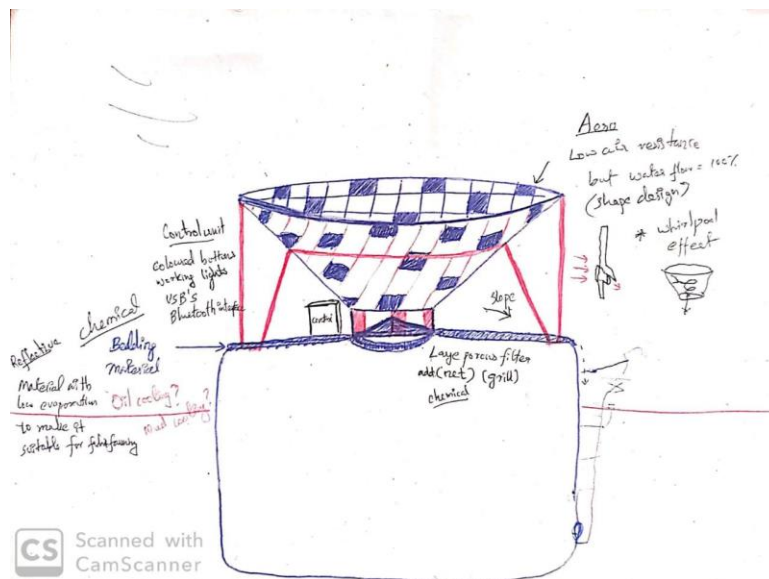

Figure 25. Final sketch of the rainwater harvesting tank

The final idea of the tank solution for harvesting rainwater is shown in Figure 25. We want it to include:

- Water catchment area directly from the rain. It will have a conical shape and some holes to allow the wind to pass, in case there are strong bursts.
- Control panel.
- Mechanism of operation and closure of the tank to avoid evaporation.

- Sensors with IoT that allow to see the prediction of the weather and open the mechanism if necessary.
- Runoff water catchment area of adjacent fields.
- Filters and pipes to bring this water to the tank.
- A pump to extract the water from the tank and pumping it into the fields.
- Solar panels to feed all the mechanisms that need electricity.

The main idea is to create a tank which can hold water for about 7-8 months. This water will be used for irrigation and not drinking. During the rainy season, the tank will be programmed to open its catchment area and collect the rainwater. This will then be used to irrigate the fields via solar pumps whence required. These tanks will be installed in one corner of the field such that the entire field can be irrigated.

## II. Irrigation water needs Excel

The Excel file *Annex II. Irrigation water needs* has been attached to this master thesis for future use of this thesis in case someone wants to do a similar calculation for different crops, different location, different sowing dates or different areas of study.

The use of this file is simple and intuitive as it has 2 main tabs that are going to be used:

1. **Data INTRO:** this tab includes the details of the location, details of the crops and 3 macros that will be explained below.

- **Details of the location.** One should add the following information: name of the village, latitude (in °), latitude (N or S), relative humidity in % (optional information) and wind speed in m/s (optional information). Moreover, it should be added also all the data of temperature (min and max) and precipitation from the location.
- **Details of the crops.** It can be added 3 different crops and the following information has to be given: name of the crop (within a list), area that one wants to cover with it, planned sowing date and total growth period (within a list).
- **Macros.** Three macros have been created and introduced in three different buttons in order to simplify the use of this tab:
  1. **Get results of water irrigation needs.** If you press this button, the macro will do all the calculations in order to obtain the results of the irrigation water needs of the crops introduced and will open the “RESULTS” tab to show them.
  2. **Delete data.** If you press this button, all the data that has been added in this tab will be eliminated. It is a “reset” button to start all over again.
  3. **Intro data from Karkata.** As this project and Excel file have been created for using it in the village of Karkata, this macro adds all the details of the location (Karkata) in their correct cells, so that you can quickly get all the data from the village.

2. **RESULTS:** This tab shows the results of irrigation water needs for the different crops introduced in the “Data INTRO” tab. These results will have a significant variation according to the type of crop introduced, the area that we want to cover and the sowing date, one of the most determinant points.

The results of irrigation water needs are given month by month, with its start being the sowing date, and in 3 different units:  $\frac{mm\ of\ water}{month}$ ,  $\frac{l}{month}$ ,  $\frac{m^3}{month}$ .

These are the only 2 tabs that have to be used, as the rest are just intermediate tabs that do all the calculations step by step. These steps are being explained in Section [3.2](#) of this project.



### III. Water tank + wall drawing

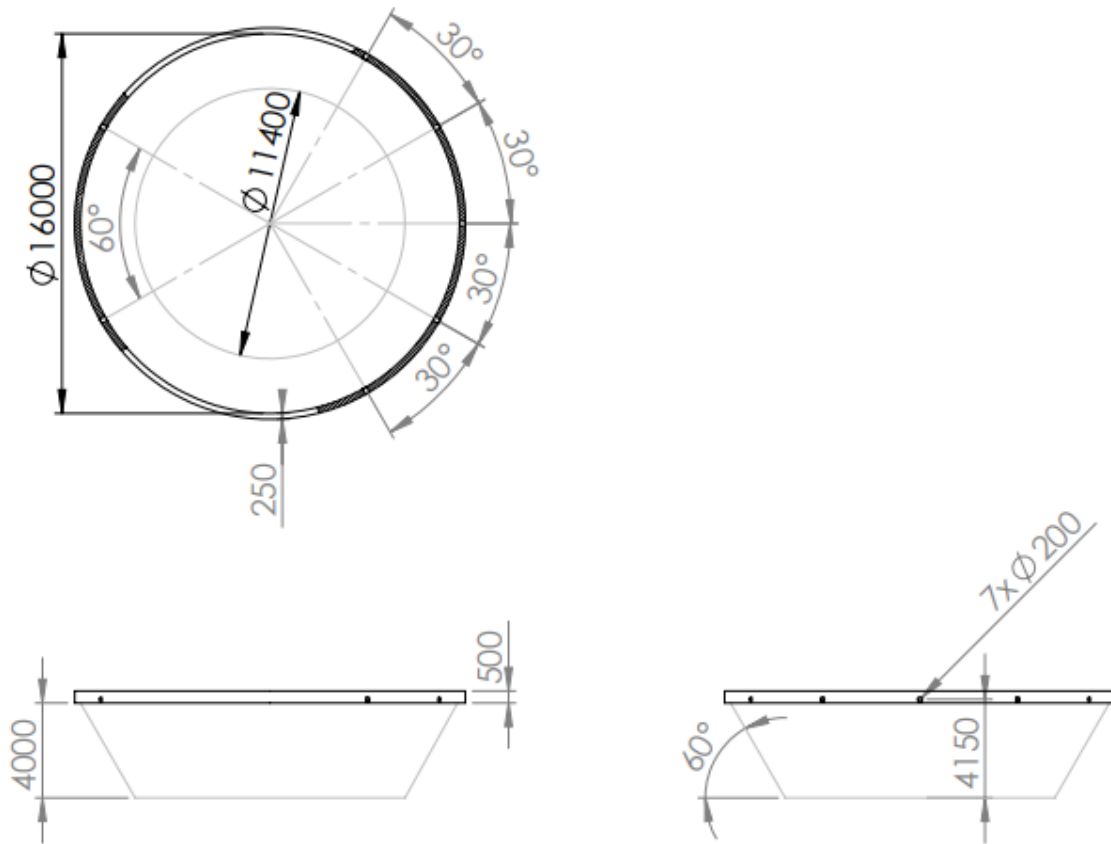

Figure 26. Drawing of the tank + wall (all measures are in millimetres)