



**UCC Library and UCC researchers have made this item openly available.
Please [let us know](#) how this has helped you. Thanks!**

Title	Vibration characterisation for fault detection and isolation in linear synchronous motor based conveyor systems
Author(s)	Walsh, Michael; O'Flynn, Brendan; Torres, Javier
Publication date	2019-04
Original citation	Walsh, M., O'Flynn, B. and Torres, J. (2019) 'Vibration Characterisation for Fault Detection and Isolation in Linear Synchronous Motor based Conveyor Systems', 2019 International Conference on Automation, Computational and Technology Management (ICACTM), London, United Kingdom, 24-26 April. pp 500-504. doi: 10.1109/ICACTM.2019.8776825
Type of publication	Conference item
Link to publisher's version	https://ieeexplore.ieee.org/document/8776825 http://dx.doi.org/10.1109/ICACTM.2019.8776825 Access to the full text of the published version may require a subscription.
Rights	© 2019 IEEE. Personal use of this material is permitted. Permission from IEEE must be obtained for all other uses, in any current or future media, including reprinting/republishing this material for advertising or promotional purposes, creating new collective works, for resale or redistribution to servers or lists, or reuse of any copyrighted component of this work in other works.
Item downloaded from	http://hdl.handle.net/10468/10000

Downloaded on 2020-05-26T23:57:58Z

Vibration Characterisation for Fault Detection and Isolation in Linear Synchronous Motor based Conveyor Systems

Michael Walsh
Wireless Sensor Networks Group
Tyndall National Institute
University College Cork
Cork, Ireland
michael.walsh@tyndall.ie

Brendan O' Flynn
Wireless Sensor Networks Group
Tyndall National Institute
University College Cork
Cork, Ireland
brendan.oflynn@tyndall.ie

Javier Torres
Wireless Sensor Networks Group
Tyndall National Institute
University College Cork
Cork, Ireland
javier.torres@tyndall.ie

Abstract— Linear synchronous motor (LSM) based transport systems are increasingly deployed in automated manufacturing environments. The aim of the study is to establish the feasibility of employing low power and low cost vibration sensing cyber physical systems to perform near real-time fault detection and isolation for passive LSM vehicles. Empirical data capture was conducted on an LSM test-bed where vehicle velocity was varied to determine how changes in velocity would impact the vibration profile of the LSM vehicle. The recorded data was analysed and peak accelerations were examined for each of the velocities under study. Frequency domain analysis was conducted on the collated accelerometer data and frequencies of interest were identified. The findings are shown to concur with the manufacturer's operating specifications (0-30 Hz). A relationship between LSM vehicle speed and vibration frequency was established. The results presented provide the basis for the establishment of low cost condition based preventative maintenance, deployed to a LSM based transport system for high volume manufacturing.

Keywords— Fault Detection and Isolation, Cyber Physical System, Linear Synchronous Motor, Vibration Analysis.

I. INTRODUCTION (HEADING 1)

Linear motors have the capacity to provide linear motion under high speed with low power conditions, without the requirement for rotational to translation conversion mechanisms such as gears or linkages. Linear motors are therefore the propulsion method of choice for many emerging transportation systems [1]. A linear synchronous motor (LSM) is a linear motor, where the moving part (vehicle) is driven by a synchronous mobile magnetic field. The technology can enable precision vehicle movement and positioning when coupled with closed loop feedback position sensing and control techniques [2].

An LSM is comprised of two central components typically referred to as the primary and secondary components. The primary part is generally a poly-phase electromagnet which is linearly arranged such that a travelling magnetic field is produced in the air gap between the primary and secondary components. The primary part is usually static and embedded in a track to enable seamless movement. The secondary part is generally an array of permanent magnets (PM) arranged in an alternating configuration and typically co-located with the load under transport. An LSM can be configured as double sided or single sided, slotted or slot-less, iron-cored or air-cored [3]. Applications for LSMs include maglev train transportation [3], rope-less hoist systems [4] and cable free elevators [5].

With the advent of the fourth industrial revolution or Industry 4.0 a number of applications for LSM technology have emerged as digital technologies seek to make manufacturing more agile, flexible and responsive [6].

Fig 1 illustrates a conceptual diagram of an LSM transport system designed for use in automated high volume manufacturing. The technology depicted is based on the Magnemotion QuickStick® 100 (QS 100) LSM transport system [7]. The system comprises of passive vehicles and reconfigurable modules measuring one meter in length that are deployed to implement a desired path for the factory process line. Each module contains the primary motor components, as well as position sensors and a digital controller. Serial communications is employed to enable feedback control linking the primary motor to a network with the node and host controller. This in turn allows the feedback loop to accurately regulate speed, acceleration, deceleration, direction of movement, vehicle traffic, and vehicle positioning [8].

Vehicles must be grounded to the guide way using conductive materials as illustrated in Fig. 2. There is typically a physical gap of approximately 3mm between the vehicle's magnet array and the motor. This gap is maintained by the vehicle wheels, or a set of rollers and enables seamless acceleration and deceleration of the LSM vehicle, as raw materials and product are transported through the manufacturing process [7]. Wear and tear of these components can result in mechanical failure and production downtime. This risk is currently addressed by employing periodic preventative maintenance to reduce the probability of a fault occurring. However as equipment ages failure rates typically increase and the reliability of the maintenance planning decreases. The results is an increase in costs to the manufacturing process. Smart manufacturing applications have identified cyber physical systems (CPSs) as a useful tool for monitoring and controlling machinery and equipment in near real time. This in turn enables the remote detection and isolation of faults, triggering maintenance only when a potential failure is about to take place [9]. A number of such CPS implementations have been reported in the literature, incorporating sensors such as microelectromechanical based accelerometers, to monitor the vibration of mechanical components for example bearings [10] and for milling processes [11]. These solutions work on the basis that breakdown of the mechanical component under study manifest as changes in vibration resonance, which can be calculated employing frequency domain analysis of the accelerometer data.

Supported by H2020 ECSEL-JU-737453, via the IMECH project ('Intelligent Motion Control Platform for Smart Mechatronic Systems) and by the Science Foundation Ireland funded Centre CONFIRM..

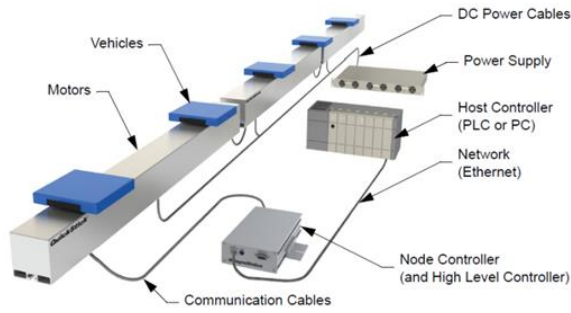

Fig. 1. Simplified View of the QuickStick 100 Transport System [4]

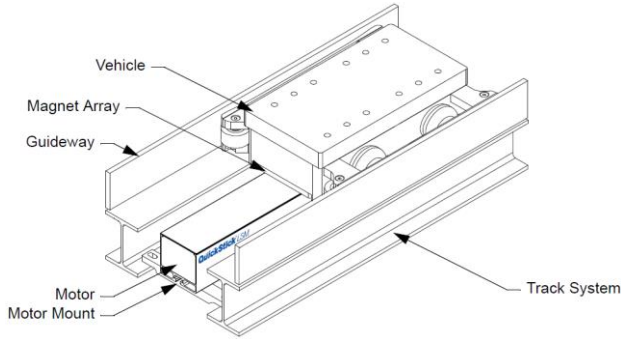

Fig. 2. LSM vehicle for QuickStick 100 Transport System [4]

Wireless communications can further enable CPS technologies to provide distributed, low cost and easily deployable solutions satisfying a broad range of industrial applications [12]. The goal of this paper is to employ CPSs, incorporating vibration sensing, to determine the feasibility of providing remote detection and isolation of faults for passive LSM vehicles. The vehicle is deemed passive in that there is no cabling to implement communication to the primary backbone nor is an onboard power source available. For this reason, the proposed CPS sensing technology when integrated in the vehicle is required to be wireless and battery powered.

The paper is organized in the following manner. Section II provides an overview of a CPS implementation designed to capture and wirelessly transmit vibration information from the mobile LSM vehicle to a central repository. A description of the LSM vehicle instrumentation is provided. Finally an explanation of the data analysis methodology employed as part of the study is outlined. A description of the experimental methodology is included in Section III. Empirical results captured from the QS 100 test-bed are presented and a discussion surrounding the key findings is detailed. Conclusions and future work are included in Section IV.

II. METHODOLOGY

A. Cyber Physical System Wireless Sensor Platform

As mentioned previously the mobile LSM vehicle under study is passive in that it not wired for communications and has no onboard power source. In order to facilitate communications a lithium ion powered wireless CPS platform has been implemented.

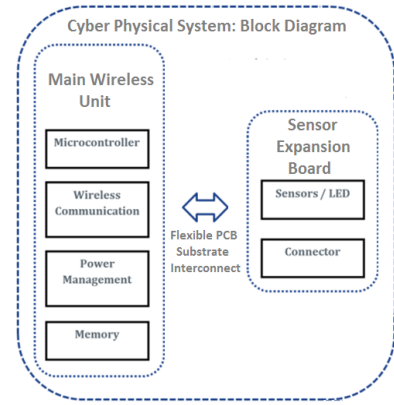

Fig. 3. CPS Sensor Platform Block Diagram

TABLE I. CPS WIRELESS SENSOR PLATFORM SPECIFICATIONS

Parameter/Component	Specification	
Wireless Main Unit	MCU RAM	2 MB
	MCU FLASH	256 KB
	MCU Speed	Max 180 MHz
	MCU Core	ARM® Cortex®-M4-based 32 bits architecture
	MCU Other	Built-in Single Precision Floating Point Unit
	Wireless Protocols	Wi-Fi: IEEE 802.11 a/b/g/n
	Wireless Protocols	Dual mode 4.0 (Classic and BLE)
	Wireless Throughput	MCU@56 MHz & Wi-Fi 4.4 Mbps
	Onboard Memory	EEPROM 512KBIT
	Battery & Charging	Standard Li-ion / Li-Polymer
Sensor Expansion Board	Inertial Sensor MPU 9250	3-axis Accelerometer
		3-axis Magnetometer
		3-axis Gyroscope

Fig. 3 shows a block diagram of the platform. The main wireless unit integrates the core technology as detailed in Table I. The system includes a 32 bit microcontroller unit (MCU) with an inbuilt digital signal processing core and floating point hardware unit to enable edge processing applications. A wireless interface is provided enabling both WiFi and Bluetooth Low Energy (BLE) communications. The unit also houses onboard power management and embedded memory as well as USB connectors for communication with the plug-in expansion sensor boards.

Up to 5 sensor expansion boards can be interfaced simultaneously via USB connectors enabling low end to end latency at speeds up to 4.4 Mbps. The sensor expansion board employs flexible printed circuit board (PCB) substrate interconnect as illustrated in Fig. 4. This configuration allows for instrumentation of remote locations where the owing to size restrictions the main wireless unit cannot be mounted. Each sensor expansion has an onboard microelectromechanical (MEMs) based inertial sensor (MPU-9250 from Invensense) with inbuilt 3 axis accelerometer to enable vibration information to be gathered in near real-time.

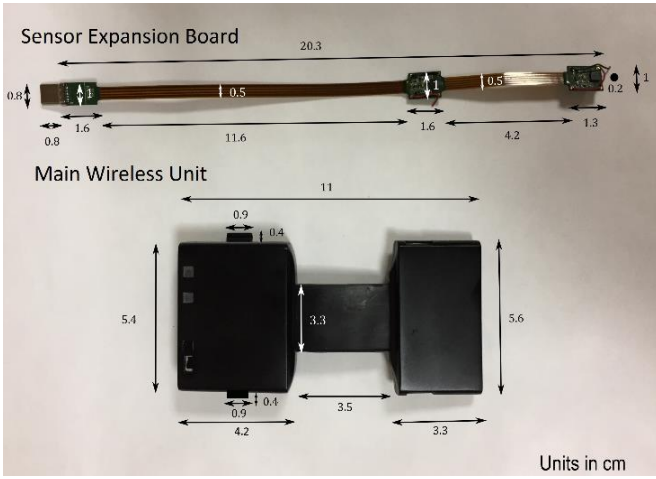

Fig. 4. CPS wireless sensor platform housed highlighting the flexible PCB substrate interconnect.

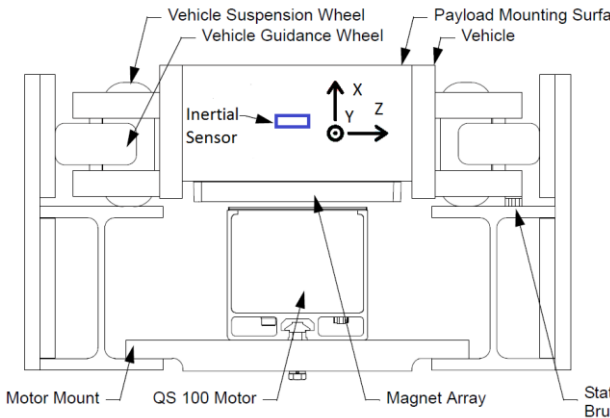

Fig. 5. LSM vehicle on Guideway [4] with highlighted sensor placement and movement reference frame.

B. LSM Vehicle Instrumentation

The LSM vehicle under investigation was instrumented with the CPS platform described in the previous section and a sensor expansion board was deployed as illustrated in Fig. 5. The sensor was mounted as close as possible to the center of the vehicle. The orientation of the inertial sensor was aligned with the established movement reference plane as indicated in Fig. 5.

C. Frequency Domain Analysis Methodology

Time-frequency analysis techniques are one of the most common methods for detecting faults [13]. A relevant review of vibration monitoring techniques and condition in time and frequency domains and their results have been presented in [14]. The fast Fourier transform (FFT) has been shown to enable fault detection and isolation for applications where there is a risk of bearing degradation [10]. The FFT for vector X of length n can be defined as:

$$Y(k) = \sum_{j=1}^n X(j)W_n^{(j-1)(k-1)} \quad (1)$$

(1)

Where:

$$W_n = e^{(-2\pi i)/n} \quad (2)$$

Linear motors such as the system under study that incorporate an iron core to increase thrust (equivalent to torque in a traditional rotary motor) exhibit cogging forces. A key difference between rotary and linear motors is that in linear motors the generated forces are periodic as a function of distance versus angle. For linear motors the forces will pull the vehicle forward or backward along the motor [2]. As per the manufacturers technical information the QS 100 LSM transport system should, when deployed as recommended in a practical application, exhibit vibrations in the range of 0 to 30 Hz as a result of motor cogging [7]. One of the goals of this work is to establish how this frequency will vary as a result of increases or decreases in velocity. Deviation from the expected resonance frequency for a given velocity can in turn be employed to detect and isolate faults for the LSM vehicle.

III. EXPERIMENTAL RESULTS AND DISCUSSION

The experimental test-bed employed in the study comprised of three meter length modules of the Magnemotion QS 100 LSM transport system. An experimental test-plan was established in which three vehicle velocities (0.5, 1 and 1.5 m/s) were selected based on the requirements of the process application under study. Each velocity was measured employing the CPS wireless platform and for each experiment accelerometer data was recorded in real-time and transmitted wirelessly to a central server repository for further analysis.

A single measurement comprised a full traverse of the 3 modules of the QS 100 LSM transport system test-bed. The experiments were repeated 3 times for each investigated LSM vehicle velocity. A sampling frequency of 150 Hz was selected for the experiments on the basis of the expected vibration frequency information (0-30 Hz) provided by the manufacturer of the LSM system [4].

A. Accelerometer Data Statistical Analysis

An example 3 axis accelerometer dataset is presented in Fig 6. The data illustrated has been adjusted to account for the gravity vector. The three QS 100 LSM transport system modules are clearly identifiable from the recorded information. It is also possible to highlight the change in vibration profile as the LSM vehicle transitions from one QS 100 LSM transport system module to the next. This is in agreement with the technical specification for the system which indicates that Vehicles are subjected to increased cogging as they move from module to module [7].

Root mean square (RMS) and maximum acceleration values for each of the velocities under study are presented in Table II. As the experimental velocity of the LSM vehicle is increased there is an associated increase in observed RMS and maximum accelerations. This is in agreement with the operating principals of the LSM technology whereby an increase in velocity should manifest as an increase in the levels of motor cogging in the system.

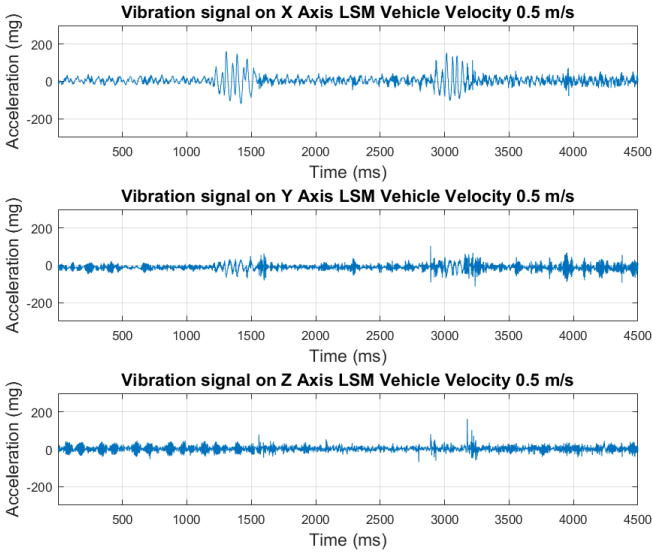

Fig. 6. 3 axis accelerometer data for LSM vehicle velocity 0.5 m/s. The data has been adjusted to account for the gravity vector.

TABLE II. LSM VEHICLE STATISTICAL INFORMATION FOR VARYING VELOCITIES

LSM Vehicle Velocity	RMS Acceleration (mg)	Maximum Acceleration (mg)
X Axis LSM Velocity 0.5 m/s	57.07	228.69
X Axis LSM Velocity 1 m/s	136.18	390.35
X Axis LSM Velocity 1.5 m/s	148.27	554.12

B. Frequency Domain Analysis

As illustrated by Fig. 6 three axis accelerometer data was recorded for each experiment, however as can be observed the predominant vibration component is present on the X axis measurement. This axis was therefore selected for further frequency domain analysis. For each of the three velocities under study (0.5, 1 and 1.5 m/s) an FFT was calculated as per (1) and (2) above.

Fig. 7 displays a single sided FFT spectrum for LSM vehicle velocity of 0.5 m/s. The maximum peak appears with a center frequency of 10.2 Hz. Results for LSM vehicle velocity 1 m/s is presented in Fig. 8. There is a maximum peak with a center frequency at 20.5 Hz. In Fig. 9 the single sided FFT for LSM velocity 1.5 m/s highlights a peak with center frequency of 30.5 Hz.

The power spectral density (PSD) for each of the three experiments is included with maximum peaks occurring at frequencies 10.2, 20.5 and 30.5 Hz for LSM vehicle velocities 0.5, 1 and 1.5 respectively. The FFT and PSD analysis shows a linear relationship between LSM vehicle velocity which can be expressed with the following formula:

$$y = 20.3x + 0.1 \quad (3)$$

Where y is the maximum peak centre frequency FFT response in Hz for LSM vehicle velocity x which is measured in m/s.

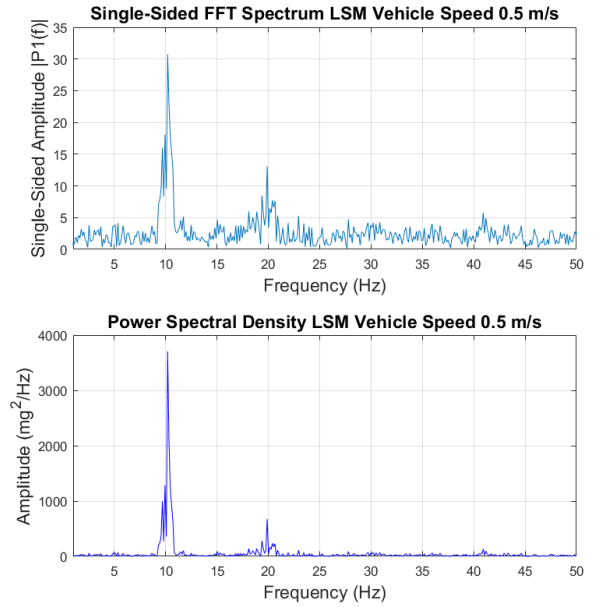

Fig. 7. A single sided FFT spectrum for LSM vehicle velocity of 0.5 m/s. The maximum peak appears with a center frequency of 10.2 Hz.

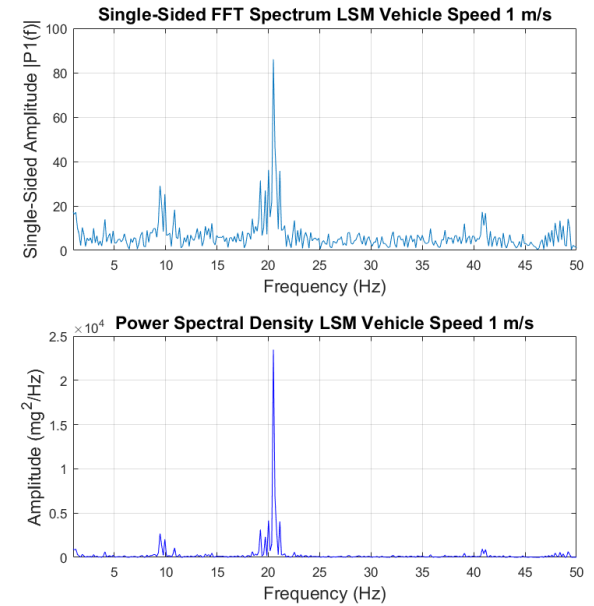

Fig. 8. A single sided FFT spectrum for LSM vehicle velocity of 1 m/s. The maximum peak appears with a center frequency of 20.5 Hz

The results of the frequency domain analysis are summarised in Table III. The frequencies successfully identified as part of this analysis are in agreement with the expected motor cogging resonance (0 to 30 Hz) outlined by the LSM manufacturer [7]. With increases in LSM vehicle velocity there is an associated increase in the maximum peak centre FFT frequency. A relationship between LSM vehicle velocity and maximum peak centre FFT frequency has been established. There is potential to exploit the relationship presented in (3) to enable fault detection and isolation associated with mechanical breakdown of the LSM vehicle components.

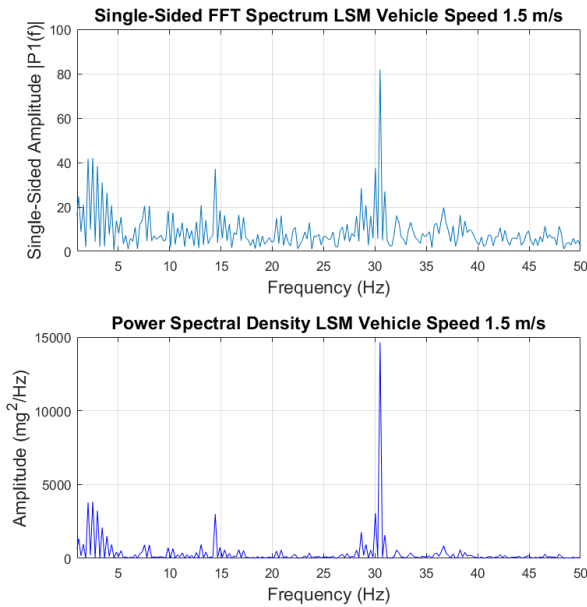

Fig. 9. A single sided FFT spectrum for LSM vehicle velocity of 1.5 m/s. The maximum peak appears with a center frequency of 30.5 Hz.

TABLE III. FFT AND PSD PEAK MAXIMUM CENTRE FREQUENCIES FOR VARYING LSM VEHICLE VELOCITIES

<i>LSM Vehicle Velocity</i>	<i>FFT Maximum Amplitude (Hz)</i>	<i>PSD Maximum Amplitude (Hz)</i>
X Axis LSM Velocity 0.5 m/s	10.2	10.2
X Axis LSM Velocity 1 m/s	20.5	20.5
X Axis LSM Velocity 1.5 m/s	30.5	30.5

IV. CONCLUSION

The goal of this paper was to establish the feasibility of employing low power and low cost vibration sensing cyber physical systems to perform near real-time fault detection and isolation. A cyber physical system wireless sensing platform was presented and instrumented to an LSM vehicle. An empirical data capture was conducted on an LSM test-bed where vehicle velocity was varied to determine how changes in velocity would impact the vibration profile of the LSM vehicle. Frequency domain analysis was conducted on the recorded accelerometer data and maximum peak center frequencies of interest were identified for each of the LSM vehicle velocities under study. The results were shown to concur with the manufacturer's specification. A linear

relationship between LSM vehicle speed and vibration frequency has been established. Future work will explore the potential to exploit this relationship to enable fault detection and isolation associated with mechanical breakdown of the LSM vehicle components. The results presented provide the basis for the establishment of low cost condition based preventative maintenance, deployed to a LSM based transport system for high volume manufacturing.

REFERENCES

- [1] R. Hellinger and P. Mních, "Linear Motor-Powered Transportation: History, Present Status, and Future Outlook", Proceedings of the IEEE, vol. 97, no. 11, pp. 1892-1900, 2009.
- [2] J. Gieras, J. Gieras and Z. Piech, Linear synchronous motors. Boca Raton, Fla: CRC Press, 1999.
- [3] H. Lee, K. Kim and J. Lee, "Review of maglev train technologies," IEEE Transactions on Magnetics, vol. 42, no. 7, pp. 1917-1925, July 2006
- [4] X. Wang, H. Feng, B. Xu and X. Xu, "Research on Permanent Magnet Linear, Synchronous Motor for Rope-less Hoist System", JCP, vol. 7, no. 6, 2012.
- [5] T. Sakamoto and T. Hanamoto, "Modeling and Robust Control System Design of a Ropeless Elevator Driven by LSM", IEEJ Trans. IA, vol. 130, no. 6, pp. 760-767, 2010.
- [6] P. Bédard-Maltais "Industry 4.0: The New Industrial Revolution" BDC study, 2017.
- [7] Magnemotion., "QuickStick® 100 User's Manual" 2013 - 2016 MagneMotion, Inc.
- [8] P. G. Ranky, "MagneMotion's linear synchronous motor (LSM) driven assembly automation and material handling system designs", Assembly Automation, vol. 27 Issue: 2, pp. 97-102, 2007.
- [9] D. Cantanzo, B. O'Flynn and M. Walsh, "On the use of Wireless Sensor Networks in Preventative Maintenance for Industry 4.0", 12th International Conference on Sensing Technology, Limerick, Ireland, Dec 2018
- [10] V. Jagannath and B. Raman, "WiBeaM: Wireless bearing monitoring system," 2nd International Conference on Communication Systems Software and Middleware, Bangalore, India: IEEE, 2007.
- [11] P. Wright, D. Dornfeld, and N. Ota, "Condition monitoring in end-milling using wireless sensor networks (WSNs)," Transactions of NAMRI/SME, vol. 36, pp. 177-183, 2008.
- [12] K. Tan, S. Huang, Y. Zhang, and T. Lee, "Distributed fault detection in industrial system based on sensor wireless network," Computer Standards & Interfaces, vol. 31 (3), pp. 573-578, 2009.
- [13] J. T. Broesch: Mechanical vibration and shock measurements, Brüel & Kjaer, second edition, printed in denmark: K. Larsen & Son a/s. DK-2860, ISBN 87 87355 34 5, 1984.
- [14] R. B. Randall: Vibration – based condition monitoring (Industrial, Aerospace and automotive Applications), Wiley edition, ISBN 9780470747858 / 0470747854, 2011