

March 2018

THE IMPACT OF ATRIUMS ON THERMAL AND DAYLIGHTING PERFORMANCE

Kareem S. Galal

Assistant Professor, Faculty of Architecture - Design and Built Environment, Beirut Arab University, Lebanon., kareem.jalal@bau.edu.lb

Follow this and additional works at: <https://digitalcommons.bau.edu.lb/apj>



Part of the [Architecture Commons](#), [Arts and Humanities Commons](#), [Education Commons](#), and the [Engineering Commons](#)

Keywords: AtriumTop, materials, Daylight distribution, Heat gain, Lebanese coastal zone

Recommended Citation

Galal, Kareem S. (2018) "THE IMPACT OF ATRIUMS ON THERMAL AND DAYLIGHTING PERFORMANCE," *Architecture and Planning Journal (APJ)*: Vol. 24 : Iss. 1 , Article 4.
Available at: <https://digitalcommons.bau.edu.lb/apj/vol24/iss1/4>

THE IMPACT OF ATRIUMS ON THERMAL AND DAYLIGHTING PERFORMANCE

Abstract

The energy crisis is one of the main focuses of attention across the world. Atrium spaces have become a main part of most public buildings all over the world, regardless of their environmental aspects. The arguments of a good space, the psychological atmosphere and the impact on energy consumption are the main problems that face any designer, environmental designers in particular. In atrium design, there is more than one aspect to be considered; architectural, functional, economic, environmental, construction and psychological aspects are the main aspects that should be considered in the early design stage. The environmental aspect is the most important of all; this is affected by several factors, such as the daylighting and thermal performance. Much research has studied this aspect in relation to a certain location, case, factor or multiple factors; these results might thus be limited. The complication and contradiction of these factors leads to the necessity of studying and analysing them. The question that this research aims to answer is how a building can benefit from daylighting with or without excess heat gain according to the climatic conditions, through determining the main factors that should be studied and their impacts on the design of atrium space.

Keywords

AtriumTop, materials, Daylight distribution, Heat gain, Lebanese coastal zone

THE IMPACT OF ATRIUMS ON THERMAL AND DAYLIGHTING PERFORMANCE

*K. S. GALAL*¹

ABSTRACT

The energy crisis is one of the main focuses of attention across the world. Atrium spaces have become a main part of most public buildings all over the world, regardless of their environmental aspects. The arguments of a good space, the psychological atmosphere and the impact on energy consumption are the main problems that face any designer, environmental designers in particular. In atrium design, there is more than one aspect to be considered; architectural, functional, economic, environmental, construction and psychological aspects are the main aspects that should be considered in the early design stage. The environmental aspect is the most important of all; this is affected by several factors, such as the daylighting and thermal performance. Much research has studied this aspect in relation to a certain location, case, factor or multiple factors; these results might thus be limited. The complication and contradiction of these factors leads to the necessity of studying and analysing them. The question that this research aims to answer is how a building can benefit from daylighting with or without excess heat gain according to the climatic conditions, through determining the main factors that should be studied and their impacts on the design of atrium space.

1. INTRODUCTION

“Atrium has become a significant architectural form over the past 30 years in that it can help resolve many environmental issues” (Rezwan, 2015). The atrium was originally the old courtyard that appeared in ancient Egyptian, Roman and Islamic houses, and it was not covered over in most of these ancient examples. Its functions were as a place to gather the building’s activities, as a social gathering space, and for intimate and environmental purposes, like ventilation and cooling/heating.

Since the building of Crystal Palace, the atrium’s main function has changed (Hung, 2003); this example was covered with a light construction and transparent materials, such as glass and metals. The atrium became a main part of a public building, used to provide an indoor environment connected with the outdoor spaces. The aim of atriums was to provide a psychological effect, create universal space and to create the most daylighting and heat gain in a cold environment to imitate the greenhouse mechanism.

Now shopping malls, hotels, educational buildings and most public buildings use this feature for the same purposes, such as solving the deep plan cases and balancing between old and new connected portions; however, the main problem is the widespread practice of using atriums with the same treatment in any climatic zones, without any respect for the environmental aspects of the atrium design. It can be noticed that atrium spaces have been constructed in some hot and dry countries such as the gulf countries; the argument is how the buildings can benefit from the daylighting with or without excess heat gain, according to the climatic conditions. The benefits of the atrium are complicated, and some of these contradict others, so atrium design decisions are not a simple process.

The world’s concerns now relate to energy conservation and sustainability, which can be noticed in the environmental assessment systems such as LEED and BREEAM standards. The LEED v4 has

¹ Kareem S. Galal

Assistant Professor, Faculty of Architecture - Design and Built Environment, Beirut Arab University, Lebanon.

new potential in atrium design by changing the rating system to respect the daylighting and the view (Sarah Ward, 2014). An atrium constructed to BREEAM standards could be part of the Health and Wellbeing, Energy, and Materials categories (Barlow S, 2011).

2. RESEARCH AIMS AND METHODOLOGY

This research aims to study those atrium aspects that affect the daylighting and thermal performance, by analysing the previous research carried out in this field and summarizing the results. Therefore, it will focus on the effective aspects and their approximate weight, to highlight those aspects that should be of concern in the daylighting and thermal performance of atrium design, so an element of the sustainable approach will be achieved.

2.1 Atrium Aspects

The design of an atrium is generally based on architectural experiments, climatic conditions, expected levels of thermal comfort, and the functions of the building (Moosavi, Mahyuddin, Ab Ghafar & Azzam Ismail, 2014).

The different architectural uses of the atrium lead to the architectural aspects that can be categorized as: the site and historical background of the building and place; the importance of gathering spaces for the internal, interactive functions such as events, shows and exhibitions areas (human, social and culture); creating an intimate and relaxing atmosphere; a visual connection hinge; a functional distribution area; and matching between inner spaces and outdoor spaces.

There are also construction aspects in the atrium design that should be taken into consideration, especially the universal structure system, light construction, wind resistance, integration with daylighting necessary, ventilation and the rain drainage system.

Some buildings, such as public buildings in general and office buildings in particular, force the designer to create an atrium space.

The economic aspects of the atrium are related to the function aspect, thermal comfort and the energy consumption factor. Market studies show that atrium buildings are more attractive and have higher occupancy rates (Tabesh & Sertyesilisik, 2015).

2.2 Environmental Aspects

The environmental aspects can be divided into the indoor quality control elements: daylighting, thermal performance (including ventilation) and acoustic behaviour. The atrium can have great potential for thermal and daylighting performance, by decreasing the electrical lighting costs, making the maximum use of passive energy and decreasing the dependence on mechanical conditioning and ventilation systems (Tabesh & Sertyesilisik, 2015).

There are many aspects that affect the daylight and thermal distribution in atriums. Some studies have covered this aspect, beginning with Saxon (1986), in his book *Atrium Buildings Development and Design*, until the present day. The researchers mainly focused on specific factors that affect the daylighting and thermal performance: atrium type, orientation, Well Index (WI), roof aperture type, tops materials, atrium materials and climatic zone.

Light is perceived by our eyes as a narrow wavelength-band of electromagnetic radiation (from about 380 nm to 780 nm) (Szokolay, 2014). There are three factors of daylighting that should be measured to achieve the necessary quality and quantity requirements: human needs, architecture and economics, and the environment; all of these can support visual performance and visual comfort (Rea & IESNA, 2011).

The main two factors can be described as follows:

Visual performance is a function of time required to see an object in unit time; it depends on the contrast sensitivity of the eye, visual acuity or sharpness of vision, and the task illuminance (Szokolay, 2014). The quantity and distribution of light could be measured by using the daylight factor (DF) or lighting level. Another indicator is the dynamic daylight metrics, which can be divided into two indicators: Spatial Daylight Autonomy (sDA), the percentage of the floor area that meets certain illuminance levels for a specified number of annual hours, and Annual Sunlight Exposure (ASE), calculating the percentage of the space that exceeds a certain illuminance level for more than a specified number of annual hours (Beckers, 2013).

Visual comfort depends on certain factors such as flicker, shadow, colour appearance/rendering, directionality of light, veiling reflections and glare, which is the main





factor for the comfort mechanism (Rea & IESNA, 2011; Szokolay, 2014). Glare can be caused by a saturation effect or by excessive contrast. According to the USA standards, there are two methods to measure it: the Visual Comfort Probability (VCP) system and the Discomfort Glare Rating (DGR) method (Szokolay, 2014).

The thermal performance is affected by external (temperature, solar radiation and wind), internal (internal heat load, expected comfort level and necessary fresh air) and ventilation variables (Moosavi et al., 2014). Thermal transfer occurs using conduction, convection and radiation mechanisms, so the U-value, time-lag and thermal mass storage are the main thermal factors in relation to the heat loss/gain performance. On the other hand, the wind dynamic force, thermodynamic rules and stack effect are the main role players in terms of the ventilation performance.

2.2.1 Atrium Types

Atrium type as an expression refers to the atrium plan placement in the building. Mostly, it is classified into four main types: centralized, semi-enclosed, attached and linear (Hung, 2003; Modirrousta & Boostani, 2016) (Table 1). Some references assume the corner atrium as being the fifth atrium type as shown in figure (1). (Wurm, 2007)

Table 1: The four types of Atria (Modirrousta & Boostani, 2016)

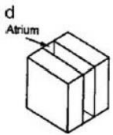
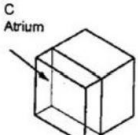
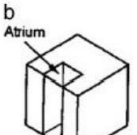
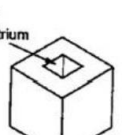
General Forms of Atrium	Linear Atrium	Attached Atrium	Semi-Enclosed Atrium	Centralized Atrium
Atrium in Plans				
Atrium in Volume				

Atrium type is the main factor that determines potential environmental advantages of atria in a building (Moosavi et al., 2014). Each form of atrium has a particular environmental advantage, according to the expected heat gain, ventilation and daylight performance.

The heat-gain and daylighting factors work in addition to the climate zone and its parameters with the glazing surface area of the atrium type; we can notice that the greater the glassing area is, the greater the amount of heat gain and daylight will be. According to the atrium type, the centralized atrium has one glazing face on the top, while the attached, corner and linear types have three glazing faces, varying in their areas, and the semi-enclosed type has two glazing faces.

For temperate climates, in order to have more solar heat gain in winter time and a more attractive view during different seasons, attached, semi-enclosed and corner atrium are used as a glazed façade. For hot and humid climates, centralized and linear atria are the most effective types in minimizing temperature fluctuations during hot and moderate seasons (Moosavi et al., 2014).

Ventilation as a part of thermal performance is used for two main purposes:

1. to remove some internal heat when $T_o > T_i$.
2. to promote heat dissipation from the skin (physiological cooling) (Szokolay, 2014).

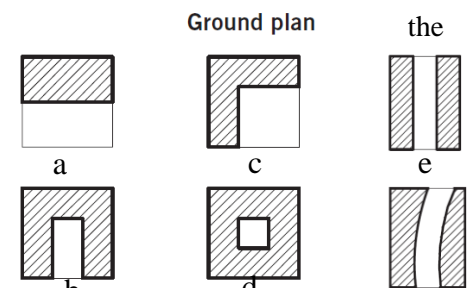

Fig .1 Atrium types classification according to (Wurm, 2007): a- Attached b- Semi-enclosed c- Corner d- Centralized e- Linear in two shapes straight and curved.

The openings and fenestration locations are the main factors in allowing cross-ventilation through the adjacent spaces in particular and through the whole building more generally.

As a heat gain factor, the area of glazing also affects the ventilation of the atrium. In the cross-section of the centralized, semi-enclosed or linear atrium types, there are two sides with adjacent spaces, while the main location of the glazed surface is the top; in warmer seasons, the ventilation plan will be closed to keep the heat inside the spaces, while in the cooler seasons, the cross-ventilation, according to the stack effect or air flow power, will be the suitable solution as in Figure (2).

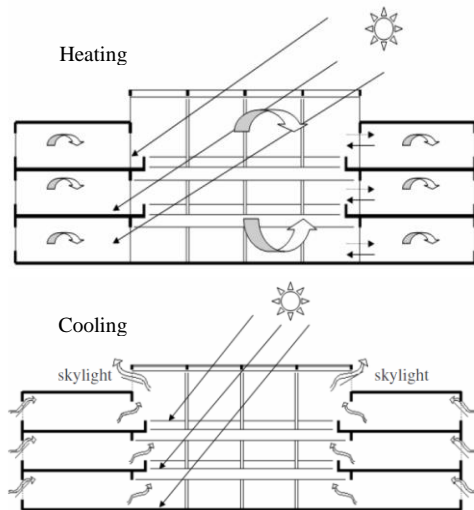

Fig .2 Centralized, Semi-enclosed or Linear Atrium type and adjacent spaces' energy strategy in heating and cooling seasons (Göçer, Tavil, & Özkan, 2006)

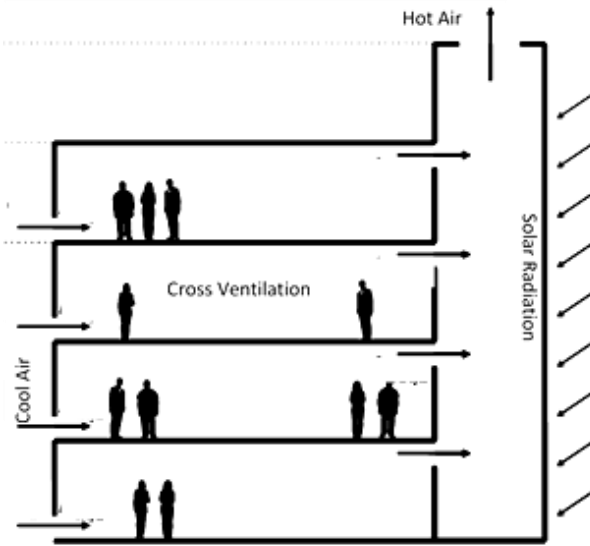

Fig .3 Schematic in elevation of a naturally ventilated Attached, Semi-enclosed, corner or Linear Atrium type and adjacent spaces' (Acred & Hunt, 2013)

The attached, semi-enclosed, corner or linear atrium types differ in the location of the glazed surfaces; they are mainly located on the top and a minimum of one side. As a result, the stack effect will be the main factor in the natural ventilation mechanism as indicated in Figure (3).

2.2.2 Orientation

An assumptive factor related to the atrium type, and one of the most important design considerations, is orientation in general, and orientation of glazed surfaces in particular, which mainly affects thermal behaviour/distribution, energy conservation, daylighting and ventilation in the atrium and adjacent spaces (Bajracharya, 2013).

The different building surfaces don't receive the same amount of irradiance; the roof receives a larger amount during the whole of the daytime. In the northern hemisphere, the southern façade receives the greater amount of irradiance as an average of the daytime, then the west–east façades and then finally the north façade; this works vice versa in the southern hemisphere as shown in Figure (4). In some different climatic zones, such as the composite climate in India, the east orientation may be higher than west as indicated in Table (2) and figure (5).

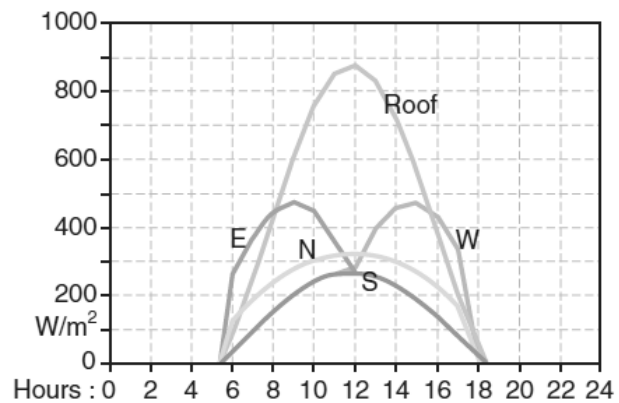

Fig .4 Irradiance on building faces: The top curve is roof, the next two (symmetrical ones) are for east and west, the next down is north and the lowest one for south walls (example for Townsville, latitude - 19°) (Szokolay, 2014)

Solar heat gain through glazed surfaces provides the most powerful passive control, so the larger surfaces should face the direction with the least solar exposure to reduce the solar heat gain, and vice versa according to the climatic zone.

Table 2 Average solar radiation intensity on various facades of a building in composite climate in India (Dates, 2015)

Average Solar radiation Intensity on various facades of a building		
Facade Orientation	Solar Radiation Intensity (W/m ²)	Month of maximum solar intensity
North Facing	100	June (in morning hrs)
South Facing	700	December (winters)
East Facing	600	April-May
West Facing	400	April-May

In hot climates, the southern and western façades are not recommended for the glazed surface of the atrium; the south orientation receives maximum solar radiation and the west is a critical orientation due to the high intensity of solar radiation during summer, when the internal gains are also at their peak (Dates, 2015).

Ventilation heat flow is also influenced by the orientation of fenestrations and other openings to the windward and leeward orientations, by their closing mechanisms, and generally by the air-tightness or wind permeability of the envelope (Szokolay, 2014).

The impact of orientation is far more important for some atrium types than others, according to the glass area ratio–location and building proportions (Bajracharya, 2013). The linear atriums are affected by the orientation more than square atriums, while atriums located inside buildings would provide a more steady temperature (Hung, 2003); so attached, semi-enclosed, corner and linear atriums are more affected by orientation than the centralized type.

On other hand, the atrium can act as a solar collector and distributor, and the facing glazed wall can be used to collect low-angle solar radiation in a cool, temperate climate; therefore, east- and west-facing would be never be recommended in a hot climate since their low angle means that sunlight is difficult to avoid (Hung, 2003).

Orientation may also affect the daylight, depending upon the same factors as heat gain, according to the sun path; south is the main direction for the sun movement in the northern hemisphere, so a northern orientation provides the best daylighting without glare in most of the daylight hours, and vice versa in the southern hemisphere.

As can be seen in Figure (6), daylighting from the south provides the larger amount in all roof aperture types and in different sky conditions; with the default roof aperture type

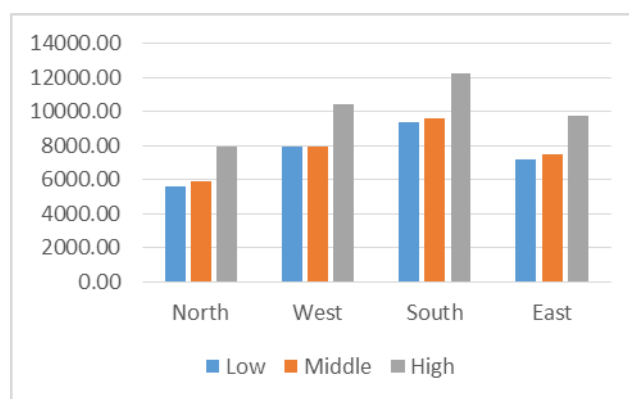

Fig .5 Average Illuminance Level on centralized atrium's floor level (Low) and vertical walls. Chart derived from numerical table of (Yunus, Ahmad, & Zain-ahmed, 2011)

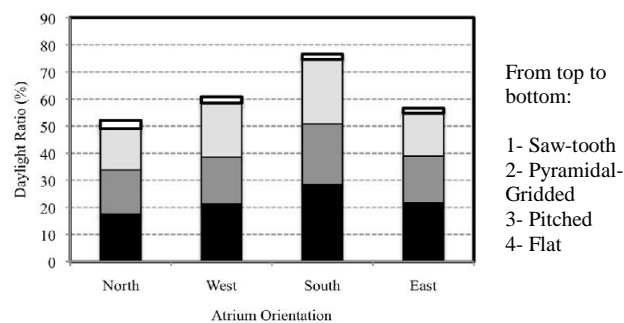

Fig .6 Daylight Ratio at different atrium vertical wall orientation under overcast skies for different roof aperture types (Yunus et al., n.d.)

(flat roof) and an overcast sky, the southern façade provides 8% more than western and eastern, and 12% more than northern façades.

2.2.3 Well Index (WI)

The relation between the plan shape and the atrium’s height is also one of the main aspects, referred to as the Well Index (WI) factor. Mainly, it is a measurement tools for atrium proportions, used to analyse the impact of well geometry and surface reflectance on vertical daylight levels under a CIE-standard overcast sky (Rezwan, 2015). It describes the three-dimensional proportions of an atrium, and can be calculated using the following equation (Calcagni & Paroncini, 2004):

$$WI = \frac{\text{height} (\text{width} + \text{length})}{2 \times \text{width} \times \text{length}}$$

The Well Index can also be used to analyse the energy performance/consumption, heat flow and ventilation (stack effect). The Well Index’s amount increases as the atrium’s height increases, and decreases as the atrium’s width and length increase.

Generally, an atrium’s low sectional aspect ratio and high plan aspect ratio are more appropriate for daylighting, passive heating and radiative cooling (Bajracharya, 2013).

There are many researchers who have studied this point. We can notice in these studies of lighting levels

in the adjacent spaces for different (WI) Well Indexes that a high amount of WI leads to low lighting levels, especially in the adjacent spaces in the low floor levels (Rezwan, 2015) as shown in Figure (7).

With similar results, another study applied a comparison between different heights (same width) and considered the light level/daylight factor (Mabb, 2001) (Table 3). Another study compared the different reflectance values of the atrium walls (10–90%) with the WI (0–1.6); the results emphasized that the higher the wall reflectance is, the more the daylight factor will be, and the more the WI is, the less the daylight factor will be shown in Figure (8) (Calcagni & Paroncini, 2004).

The ratio between the height of the clerestory window from the roof and the height of

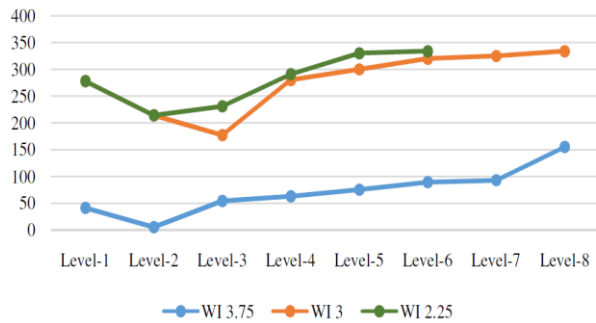

Fig .7 Average Illuminance Level on centralized atrium’s floor level (Low) and vertical walls. Chart derived from numerical table of (Yunus, Ahmad, & Zain-ahmed, 2011)

Table 3. Comparison between DF and well index for a plain glazing Aperature type (Mabb,2001)

Width	Height	WI	light level	DF%
80	300	3.8	135	3.9
	280	3.5	150	4.3
	240	3.0	180	5.1
	200	2.5	220	6.3
	160	2.0	267	7.6
	120	1.5	350	10.0
	80	1.0	463	13.2
	40	0.5	772	22.1
	8	0.1	1042	30.0

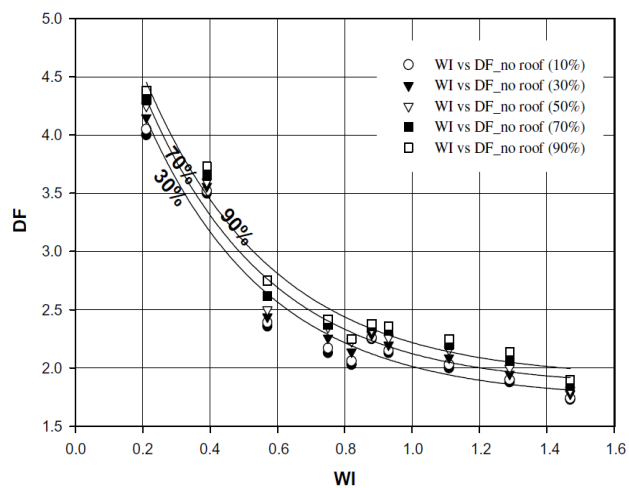

Fig .8 DF curves for different reflectance values of the atrium walls (atrium without roof). (Calcagni & Paroncini, 2004)

the atrium affects the daylighting level.

According to Ghasemi et al.'s (2015) study, the h/H ratio affects the ADF (average daylight factor); the higher the ratio is, the more the ADF will be (Figures 9 and 10). The study also made a comparison between the atrium width and the h/H ratio in relation to ADF%; the result was that the ADF increases when the atrium width increases until the point at which the width is equal to the height, and then it starts decreasing (Ghasemi, Noroozi, Kazemzadeh & Roshan, 2015).

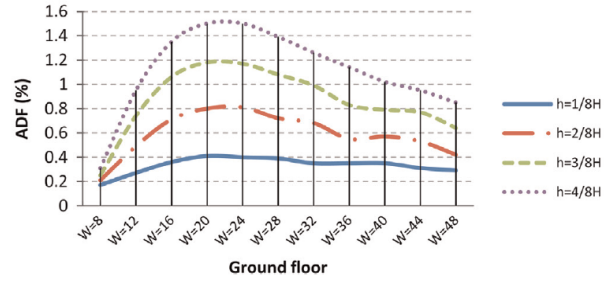

Fig .9 The variations of ADF in ground floor of atria with different h/H ratio. ADF: average daylight factor; W: width of atrium. (Ghasemi et al., 2015)

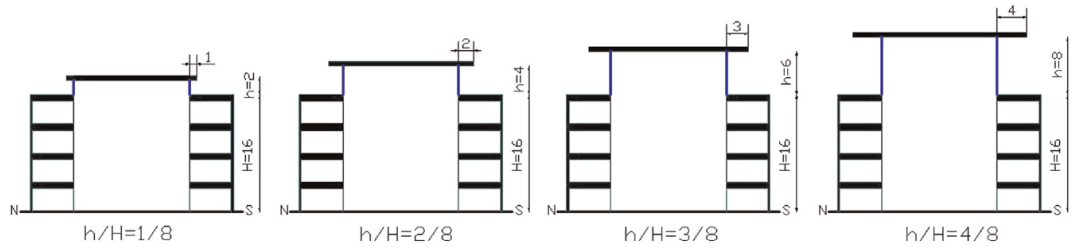

Fig .10 Schematic diagram of different atrium clerestories. H: height of atrium; h: height of clerestory window (Ghasemi et al., 2015)

The atrium space works as a solar energy collector and a main ventilation processor (due to the stack effect), so the atrium's thermal performance control could regulate the thermal performance for all buildings' spaces.

The stack effect occurs when the air inside a vertical stack is warmer than the outside air, and it also occurs within a room of significant height (a high-level outlet and a low-level inlet) (Szokolay, 2014); this definition explains the strong relationship between an atrium's Well Index and the stack effect.

Atriums with high sectional aspect ratios are subject to greater temperature stratification, causing a high stack effect (Bajracharya, 2013); the more the height (h) is, the more the stack effect will be seen in Figures (11) and (12), and greater outlet and inlet temperature differentiation raises the air velocity (for 1 m/s air velocity: $dT = 3.8$ K and for 1.5 m/s: $dT = 5.1$ K) (Szokolay, 2014).

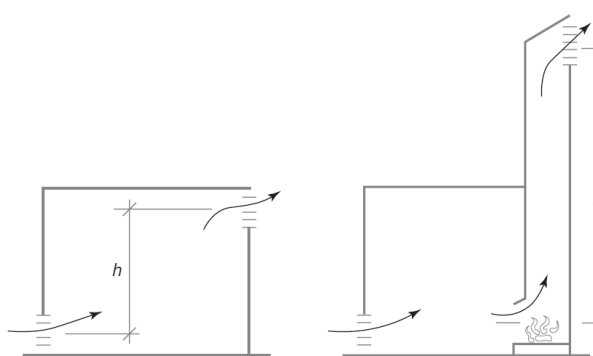

Fig .11 Stack effect in a room and in a chimney affect by the distance between the inlet and the outlet (h) (Szokolay, 2014) (Ghasemi et al., 2015)

The mechanical work of the wind also has a strong effect on the role that the atrium plays as a ventilation chimney; so, to get a good result, the inlet openings should face the preferred windward

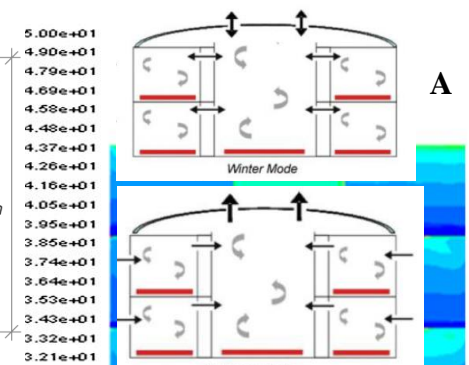
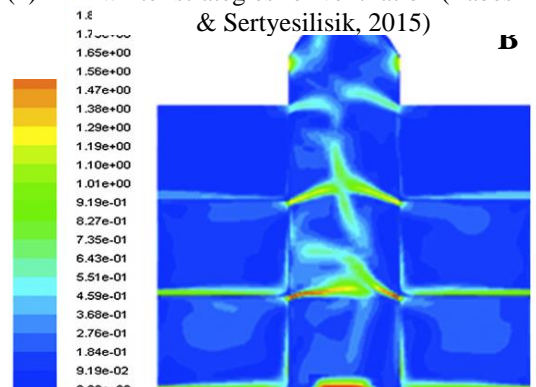

Fig .12 Comparison of the summer and winter strategies for ventilation (Tabesh & Sertyesilisik, 2015)



direction, and the outlets face the opposite direction. Some researchers have studied this point, such as Karava, Athienitis, Stathopoulos & Mouriki (2012), who studied an atrium located in Montreal, Canada to evaluate night cooling strategies for heat removal from concrete (thermal mass) floor slabs. As indicated in Figures (13) and (14), the result showed that the inflowing air stream at lower temperatures had increased cooling capacity, resulting in higher amounts of cooling stored in the thermal mass.

Another study (Woods, Fitzgerald & Livermore, 2009) concluded that there are two strategies for the atrium ventilation processes: the summer strategy involves air entering through the windows of the building, and then venting through the offices into the central atrium space, while in winter, the mixing ventilation (natural and warmed in the atrium space) enables the cold winter air to be pre-heated naturally and at lower energy costs than passing this incoming air through a pre-heat system. On the other hand, there is a strong relationship between the Well Index and the energy stored in the atrium space, which reflects on the energy consumption for cooling or heating according to the building's climatic zone location.

In one study conducted in a cold climate, China (Wang, Huang, Zhang, Xu & Yuen, 2017), it was found that the more the height is, the more the total energy consumption will be (generally speaking). The heating energy utilization index is the major factor in this cold climate, so the stored solar energy decreases with a narrow and high atrium and increases with a wide and short atrium, which therefore increases the cooling energy consumption. There is an optimum point that should be specified in order to obtain the lowest energy consumption level as shown in Figure (15).

Fig.13 Velocity contour (m/s), B: Temperature contour (K) (Hussain & Oosthuizen, 2012)

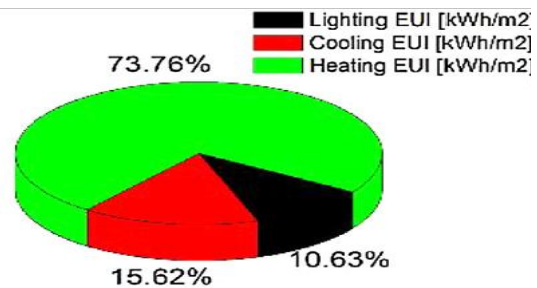

Fig. 14 Annual energy cost composition of atrium buildings 4*4 m² in cold climates, China (Wang et al., 2017)

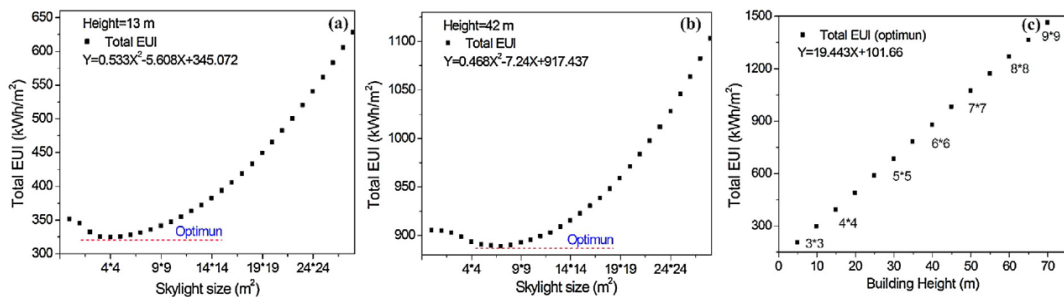

Fig. 15 Optimum skylight sizes for various atrium heights in cold climates, China (EUI: The energy utilization index) (Wang et al., 2017)

2.2.4 Roof aperture types:

Another aspect is the roof aperture type, which differs in shape and shading treatments; generally, top lighting includes a roof monitor/clerestory, saw-tooth roof and skylights (dome, vault, pitched and flat panels) (“Green Building Tech – Daylight Utilization,” n.d) as seen in Figures (16) and (17).

The different aperture types affect the incidence of the daylight factor on the atrium floor surface, along with ventilation and heat gain. The roof monitor allows the sun's rays to reach the inner space from the sides and allows them from the top. On the other

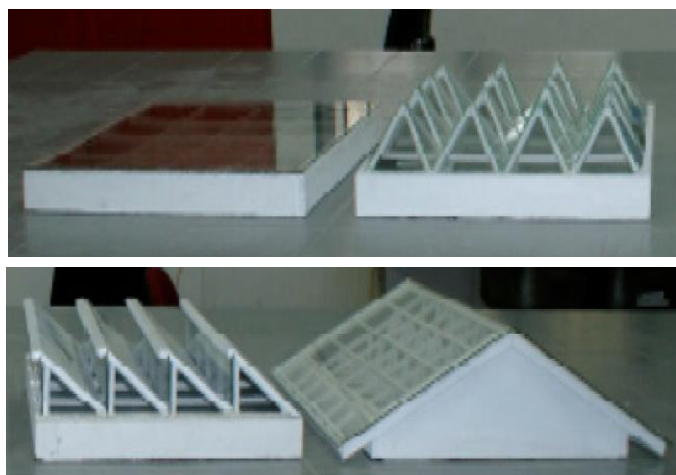

Fig. 16 Sample of aperture roof types from left top to right bottom: Flat, Pyramids skylights, Saw tooth, and Pitched (Yunus et al., 2011)

hand, the skylight types allow the maximum amount of sun rays to reach the inner space, according to the skylight aperture percentage from the roof. According to research from Yunus, Ahmad & Zain-ahmed (n.d.), each roof aperture type has a different effect on the daylight ratio in the atrium space. The flat roof type was found to have the maximum daylighting (average 19%), while the pitched roof type had 16%, the pyramidal-gridded type had 15% and the minimum daylighting was found for the saw-tooth type (2%). In addition, the heat gain matched strongly with the daylighting factors, so the flat roof type will get the maximum heat gain and the saw-tooth type the minimum.

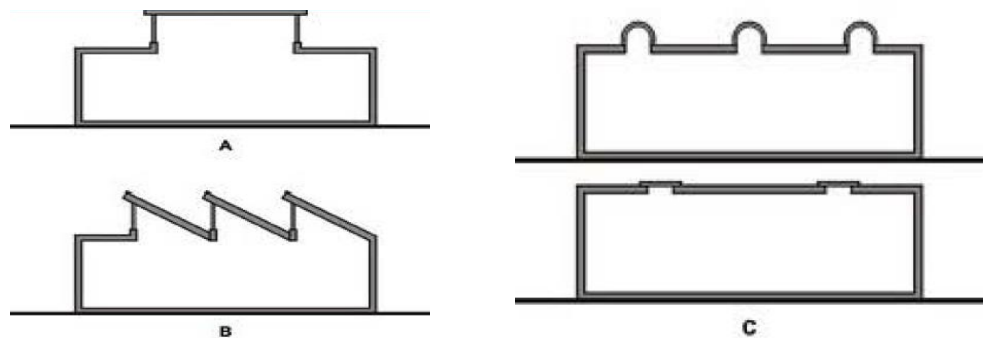

Fig. 17 Different types of top lights: a-Roof monitors; b-Saw tooth roof; c-Skylights (“Green Building Tech - Daylight Utilization,” n.d.)

The orientation and proportion factors also affect the daylighting and heat gain percentages, especially for saw-tooth and pitched roof types (Figures 18, 19, 20, & 21).

Ventilation also matches with the orientation factor; it works as a wind catcher in pitched and saw-tooth roof types. According to the preferred wind orientation, the inlet openings should be located and integrated with the outlets to achieve the maximum ventilation rates.

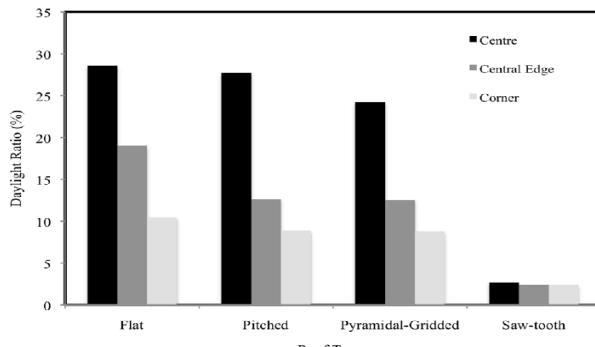

Fig. 18 Daylight Ratio at atrium floor level for overcast skies (Yunus et al., n.d.)

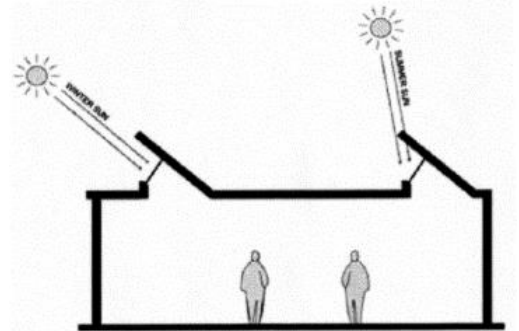

Fig. 19 Steeply sloped skylights collect more winter light than summer light (Rights & Architecture, 2016)

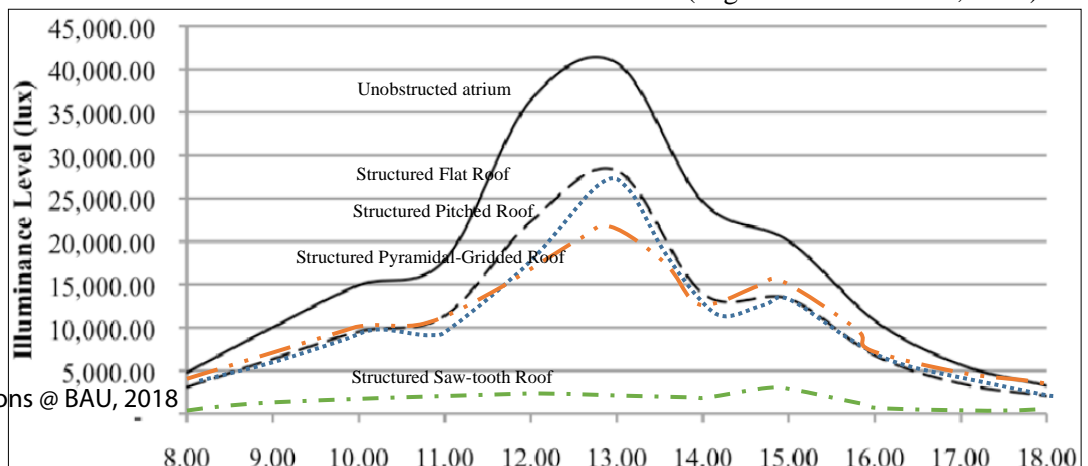

Fig. 20 Daylight levels at the centre of floor level for (from top to bottom) Unobstructed atrium, Structured Flat Roof, Structured Pitched Roof, Structured Pyramidal-Gridded Roof and Structured Saw-tooth Roof (Yunus et al., 2011)

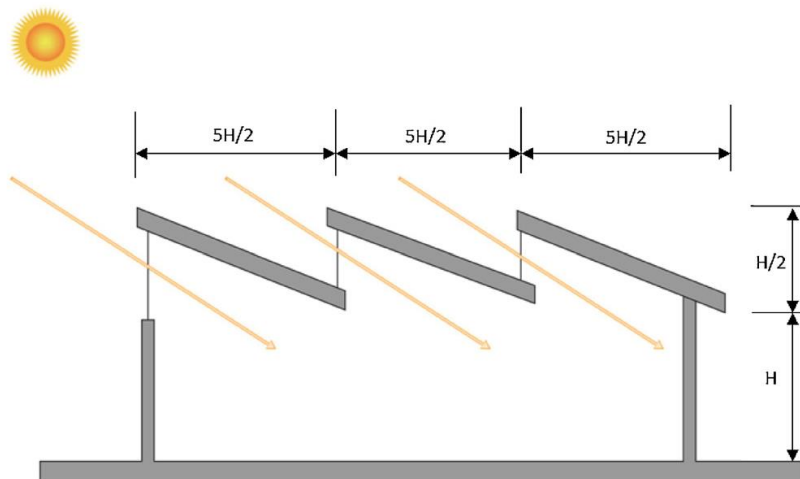

Fig. 21 A single-sided Saw-tooth system provides directional distribution of daylight inside the room (Shi & Chew, 2012)

2.2.5 Tops Materials:

Material properties for the atrium's top and vertical surfaces are one of the main environmental aspects, and mainly affect the heat gain and daylighting levels. The main materials used for atriums are glass (different types and compositions), GRP, polycarbonate/LCP and ETFE. Glass in the general sense is an amorphous solid made from inorganic raw materials. The constituents of glass as a building material are 75% silicon dioxide (SiO_2), 12% calcium oxide (CaO) and 13% sodium oxide (Na_2O). Some additives might be included for particular specifications, such as magnesium oxide (MgO) and aluminum oxide (Al_2O_3) (Hegger, 2006). Glass as a building material, referred to as architectural glass, can be used in façades or in construction (roofs and skylights are part of the construction element) (Figure 22). The architectural glass types can be classified into three main types: annealed glass (float), which is the basic flat glass product that is the first result of the float process; heat-strengthened glass, which has at least twice the strength and resistance to breakage from wind loads or thermal stresses compared to annealed glass; and fully-tempered glass/toughened glass, which provides at least four times the strength of annealed glass (Savic, Djuric-Mijovic & Bogdanovic, 2013).

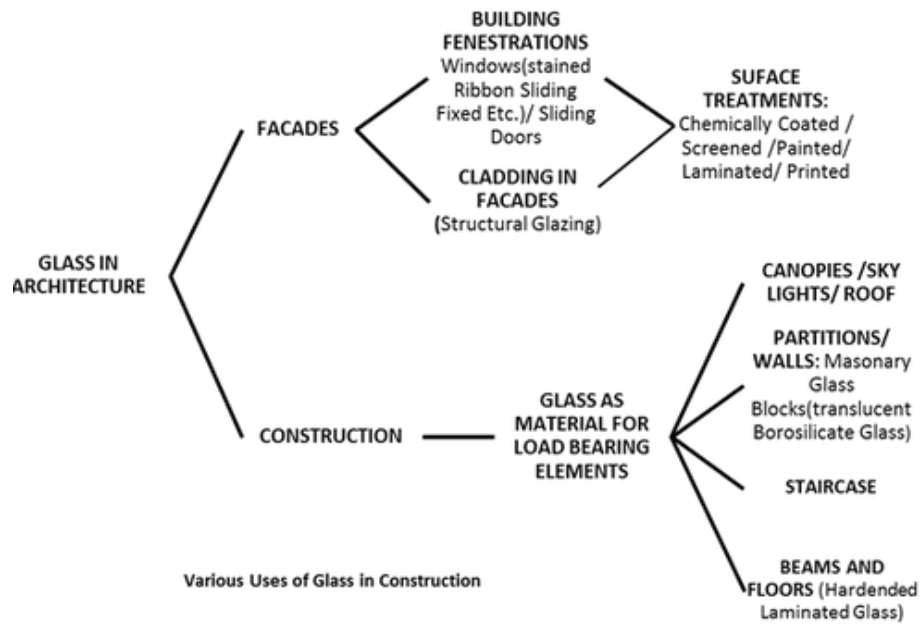

Fig. 22 Various uses of glass in construction (Popa, n.d.)

Table 4 Light transmittance values for float sheet glass (Schittich et al., 2007)

Glass thickness	Min. Value
3 mm	0.88
4 mm	0.87
5 mm	0.86
6 mm	0.85
8 mm	0.83
10 mm	0.81
12 mm	0.79
15 mm	0.76
19 mm	0.72
25 mm	0.67

Table 5 Transmittance data for a variety of glass types are used in daylighting systems. (*Includes single glass, double glazed units, and laminated assemblies. Consult manufacturer's material for specific values.)(Rea & IESNA, 2011)

Polished Plate/Float Glass	80-90
Heat Absorbing Plate Glass	70-80
Heat Absorbing Sheet Glass	70-85
Tinted Polished Plate	40- 50
Figure Glass	70- 90
Corrugated Glass	80-85
Glass Block	60-80
Translucent Sandwich Panels	2-67
Double Glazed-2 Lights Clear Glass	77
Tinted Plus Clear	37-45
Reflective Glass*	5-60

Clear Plastic Sheet	80-92
Tinted Plastic Sheet	42- 90

Transmittance is the main factor affecting glass daylighting and heat gain; Table 4 shows that transmittance decreases when the glass thickness increases for float glass. The glass type also affects the transmittance, according to the manufacture components, texture and special treatment; Table 5 shows the transmittance differentiations for different glass types. It can be noticed that some treatments, such as polishing, tinting, translucence and reflection, are very effective in decreasing the transmittance. Also noticeable is that the more layers there are, the less the transmittance will be. As shown in Table 4, the addition of colour to the glass drops the transmittance by approximately 50%; photochromic, electrochromic and polymer dispersed liquid crystal (PDLC) glass are smart materials examples for this application. Prismatic glass is a good example of the effectiveness of texture in reducing the transmittance by diffusing the light rays (Figure 23).

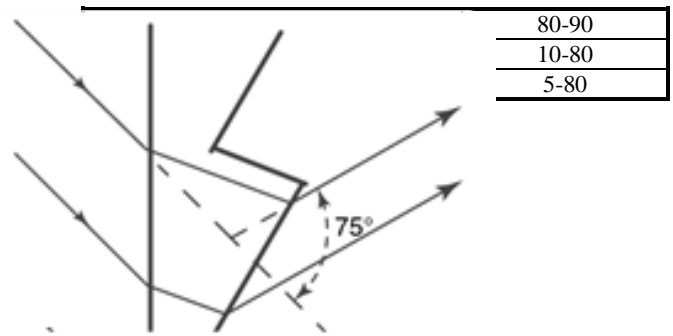

Fig. 23 The Prismatic glass and diffusing light rays (Szokolay, 2014)

Thermal transmittance (the U-value) also affects the heat gain performance; insulating glass with a cavity between its layers is a good example. The thermal transmittance value (U-value) of an insulating glass unit consisting of two float glass panes and a 12mm cavity is 3.0 W/m²K. If the cavity is enlarged to 20mm, then the value drops to 2.8 W/m²K. If a glass layer is added to the first composition with the same cavity of 12mm, the U-value will be reduced to 2.2 W/m²K. Combinations of thermal insulation coatings and gas fillings can result in U-values of approximately 0.5–0.8 W/m²K (Schittich, Balkow, Schuler & Sobek, 2007).

Table 6 Transmittance data for a variety of plastic types are used in daylighting systems.(Rea & IESNA, 2011)

Table 7 Comparison between DF and well index with normal and LCP glazing in 2D well.(Mabb, 2001)

Width	Height	WI	Plain Glaze		LCP Glaze	
			light level	DF%	light level	DF%
80	300	3.8	135	3.9	220	6.3
	280	3.5	150	4.3	250	7.2
	240	3.0	180	5.1	300	8.5
	200	2.5	220	6.3	350	10.0
	160	2.0	267	7.6	430	12.3
	120	1.5	350	10.0	550	15.7
	80	1.0	463	13.2	720	20.6
	40	0.5	772	22.1	1060	30.3
8	0.1	1042	30.0	1632	46.6	

Some types of glass have got thermal insulation in their composition, such as low-e glass; this has at least one coated surface in the cavity (the thermal transmittance values are in the region of 1.0 and 2.2 W/m²K).

Table 6 shows different plastic types that are used in daylighting systems and their transmittances. It can be noticed that GRP (glass-reinforced polyester) has the minimum transmittance of 5–80%, where translucence reduces the transmittance to 10–80. The tinting also affects the transmittance; it decreases by about 50%, even though the texture (pattern) decreases only by about 2%.

Polycarbonates/LCP (liquid crystalline polymers) are another type of common rooftop daylighting material. Table 7 shows the difference

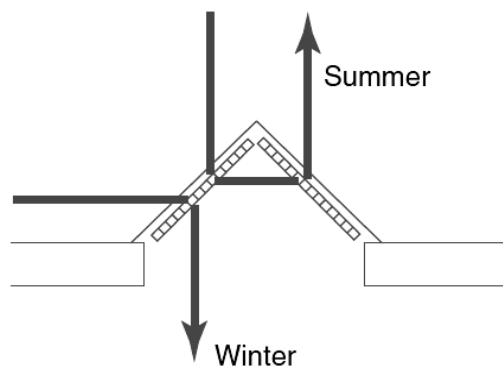

Fig. 24 Laser-grooved roof light: at low angle the sun is admitted, at high angle excluded.(Szokolay, 2014)

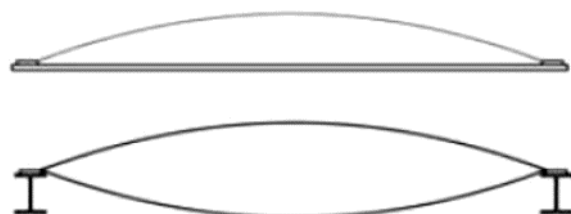

Fig. 25 Common ETFE Foil Configurations (Bessey, 2012)

between light levels of plain glass and LCP; it can be noticed that LCP allows 61–64% of light levels in comparison to plain glass. Some types of polycarbonate, such as laser-grooved acrylic sheets, clearly affect the transmittance by diffusing the sun rays according to the season; its effects are suitable for the pyramid and pitched skylight types shown in Figure (24).

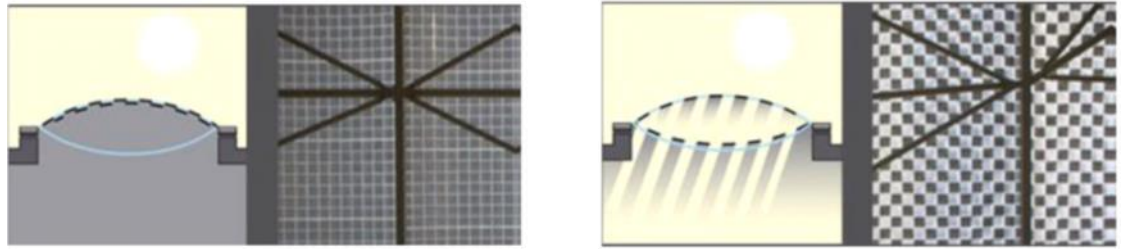

Fig. 26 Section view of the 3 layers cushions system: “When the pressure in the bottom chamber increases the foil layer inverts and presses up on the top layer thus blocking out light and controlling the building’s solar heat gain” (Bessey, 2012)

Ethylene tetra fluoro ethylene (ETFE) is the rooftop material of the future; it can be extended more than the glass span (2–4 m) to reach 11–17m, and the large span reduces the supporting frames, especially in the ETFE cushions system, therefore reducing the thermal gain. There are two configuration systems of ETFE: the single layer membrane or the inflated into cushions system (Figure 25). The cushions system is more insulating for heat gain and direct sun rays; by changing the cushion pressure, the heat gain/daylighting can be controlled (Figure 26).

The transmittance of the ETFE membrane is the highest compared to glass and polycarbonates, even though ETFE could be the material with the lowest heat gain, due to the insulating cushion and the capability of the surface’s dot-printings and the resistance to UV, which reduces and controls the heat gain (Figure 27).

A standard three-layer cushion has a U-value of around 1.95 W/m²K; by using low-E coating, this U-value could be reduced to 0.6 W/m²K (Bessey, 2012).

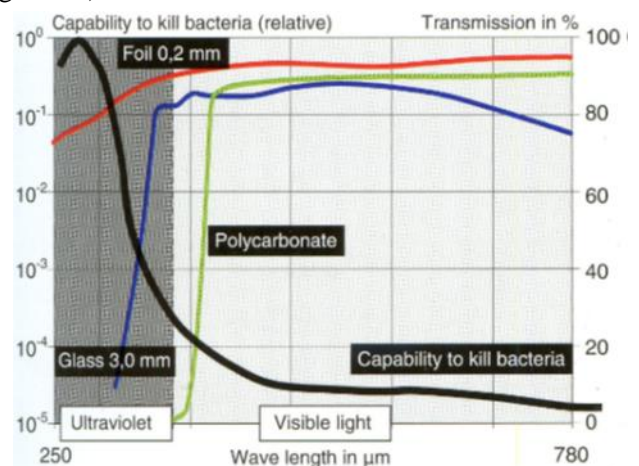

Fig. 27 Light transmittance of ETFE and other glazing materials (Bessey, 2012)

2.2.6 Atrium materials:

The atrium materials are the structural wall materials, wall finishes and floor materials. The main factor affecting the structural wall materials and wall finishes is the U-value, which affects the thermodynamic transfer between outdoor and indoor spaces and between the indoor spaces. It also affects the time-lag, which is the main factor for material selection, especially in hot-dry climates, to treat the large differentiation between day and night temperatures; therefore, the U-values of walls, finishes and floor materials are the main cause of the capacity of the thermal mass storage.

According to a study carried out by Moosavi et al. (2014) in a cold climate (Canada), the thermal mass storage is very important to store the heat when there is solar energy and thus releases in the overcast periods.

The insulation also affects the thermal performance of atrium materials; the buoyancy-driven flow rate reduces when there is no insulation.

The textures and types of the wall and floor finishes affect the reflection, absorption and transmittance factors, which are the main role-players in terms of light diffusion and glare. The glare rate should not exceed 10 (some sources suggest 15) to fulfil the necessary visual requirements (Szokolay, 2014).

2.2.7 Climatic zone:

Many classifications for climate zones are in use, but the most popular is that of Köppen, the Geiger classification, which classifies 25 climate zones under an umbrella of four main climate zones: cold, temperate, hot-dry and warm-humid (Szokolay, 2014).

From the graphs in Figure (28), it can be seen that there is a variation between the four basic types. The temperature, radiation and sunshine factors are the top characteristics of the hot-dry and warm-humid climate zones, with a very small seasonal variation in the warm-humid zone; these characteristics are the main role-players in the atrium design aspects that reflect on the heat gain and the energy consumption.

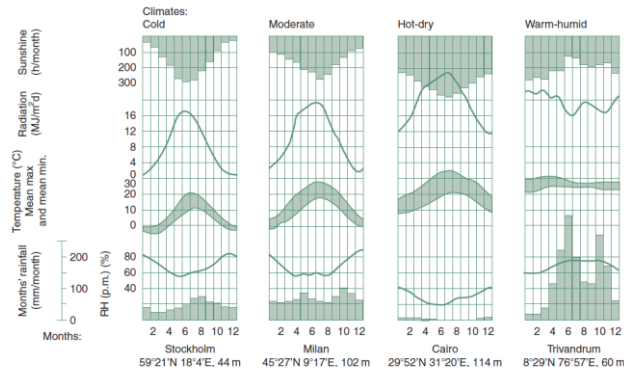

Fig. 28 Composite (simplified) climate graphs for the four basic types (Szokolay, 2014)

As shown in Figure (29), the experimental research by Aldawoud (2013) studied four different model types (WI-Model 1 is used as a reference): total energy consumption using single clear glass and a 30% glazing ratio was tested in the four basic climate zones. It was noticed that the warm-humid/dry climates had the most total energy consumption (cooling and heating) in comparison to the remaining climatic zones, by approximately 2–7%. As a result of all the above, the atrium space is a critical solution, especially in hot-dry and warm-humid climate zones; it should be treated carefully to fulfil the maximum daylighting with minimum heat gain.

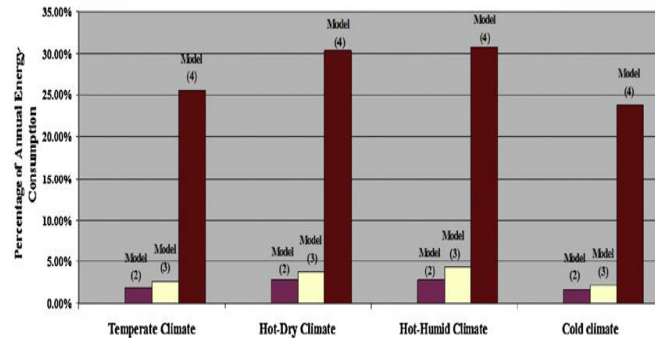

Fig. 29 Total energy consumption using single clear glass and 30% glazing ratio. (Model-1: the ratio of Length to width 1:1, Model-2: 1.25:0.8 Model-3: 1.66:0.6 Model-4: 2.5:0.25 (Aldawoud, 2013)

3. CONCLUSIONS

The researchers mentioned above have studied various atrium environmental aspects, some of these focused on the thermal and daylighting behaviours either separately or together in the same research. The main factors affecting this are atrium type, Well Index, roof aperture type, tops material and climatic zones. There are also two sub-factors: orientation and atrium materials.

Some of the research has studied the relationship between daylighting and heat gain as a general factor in the atrium design in any location but for one influencing factor only, while some have done the same but with certain climatic conditions.

The weight of the factors is not the same for the three main points discussed – daylighting, heat gain and ventilation (part of thermal behaviour). Some of the factors, such as atrium materials, do not have a clear effect on the ventilation performance, and a small effect can be found by changing the tops material through the thermodynamic mechanism.

Some of the atrium types are not suitable for some climatic zones, such as the attached type in a hot zone; this has a wide glass area, which collects more solar radiation, especially with a west or south orientation.

The aperture type and its materials and orientation have a big effect on all of the previous points; therefore, this should be taken strongly into consideration.

In some climatic regions, especially hot-dry and warm-humid zones, the atrium design decision must be made carefully. The heat gains in these zones have a great effect on the energy consumption, especially on the cooling load.

An overall view does not clearly exist in this field, due to the complications and contradictions between many of the factors that have been explained. Therefore, a simulation for each climatic zone or for each case could be an accurate solution for these cases. Using a simulation for certain climate zones with certain factors, such as atrium type, top materials, etc., will give the designer an overall view of the design decision before the simulation stage. Research like this can be demonstrated in work by Aldawoud (2013), Yunus et al. (2011), Hussain & Oosthuizen (2012) and Ghasemi et al. (2015).

REFERENCES

- Acred, A., & Hunt, G. R. (2013). Passive Ventilation in Multi-Storey Atrium Buildings: a First-Order Design Guide. 34th Annual AIVC Conference, (September 2013).
- Aldawoud, A. (2013). The influence of the atrium geometry on the building energy performance. *Energy and Buildings*, 57, 1–5. <https://doi.org/10.1016/j.enbuild.2012.10.038>
- Bajracharya, S. (2013). Challenges and Opportunities in Atrium Buildings : A Review. *Journal of the Institute of Engineering*, 9(1), 65–68.
- Barlow S. (2011). Guide to BREEAM. London: RIBA Publishing. Retrieved from <https://doi.org/10.1007/978-0-85729-439-5>
- Beckers, B. (2013). Solar Energy at Urban Scale. *Solar Energy at Urban Scale*. New York: John Wiley & Sons, Inc.
- Bessey, R. P. (2012). Structural Design of Flexible ETFE Atrium Enclosures, (December), 1–112.
- Calcagni, B., & Paroncini, M. (2004). Daylight factor prediction in atria building designs. *Solar Energy*, 76(6), 669–682.
- Dates, F. B. Y. (2015). Solar Passive Design Studio. (HPCB) High Performance Commercial Buildings in India, 1–5. Retrieved from <http://high-performancebuildings.org/>
- Ghasemi, M., Noroozi, M., Kazemzadeh, M., & Roshan, M. (2015). The influence of well geometry on the daylight performance of atrium adjoining spaces: A parametric study. *Journal of Building Engineering*, 3, 39–47. <https://doi.org/10.1016/j.jobee.2015.06.002>
- Göçer, Ö., Tavil, A., & Özkan, E. (2006). Faculty of Engineering and Architecture , Beykent University , Istanbul , Turkey Faculty of Architecture , Istanbul Technical University , Istanbul , Turkey. *Sim*, 33–40.
- Green Building Tech - Daylight Utilization. (n.d.). Retrieved June 12, 2017, from <http://gbtech.emsd.gov.hk/english/minimize/daylight.html>
- Hegger, M. (2006). *Construction Materials Manual* (1st ed.). Germany: Birkhäuser Architecture.
- Hung, W. Y. (2003). Architectural aspects of atrium. *International Journal on Engineering Performance-Based Fire Codes*, 5(4), 131–137.
- Hussain, S., & Oosthuizen, P. H. (2012). Numerical investigations of buoyancy-driven natural ventilation in a simple atrium building and its effect on the thermal comfort conditions. *Applied Thermal Engineering*, 40, 358–372. <https://doi.org/10.1016/j.applthermaleng.2012.02.025>
- Karava, P., Athienitis, A. K., Stathopoulos, T., & Mouriki, E. (2012). Experimental study of the thermal performance of a large institutional building with mixed-mode cooling and hybrid ventilation. *Building and Environment*, 57, 313–326. <https://doi.org/10.1016/j.buildenv.2012.06.003>
- Mabb, J. a. (Queensland U. of T. (2001). Modification of Atrium Design To Improve Thermal and Daylighting Performance, (December), 294.
- Modirrousta, S., & Boostani, H. (2016). Analysis of Atrium Pattern, Trombe Wall and Solar Greenhouse on Energy Efficiency. *Procedia Engineering*, 145, 1549–1556.
- Moosavi, L., Mahyuddin, N., Ab Ghafar, N., & Azzam Ismail, M. (2014). Thermal performance of atria: An overview of natural ventilation effective designs. *Renewable and Sustainable Energy Reviews*, 34, 654–670. <https://doi.org/10.1016/j.rser.2014.02.035>
- Popa, C. (n.d.). Structural glass. Retrieved June 21, 2017, from <http://www.understandconstruction.com/glass.html>
- Rea, M. S., & IESNA. (2011). *The IESNA Lighting handbook*. (D. L. Dilaura, K. W. Houser, R. G. Mistrick, & G. R. Steffy, Eds.) (10th ed.). New York: Illuminating Engineering Society.

- Rezwan, S. M. (2015). Impact of Atrium Proportions on the Distribution of Daylight Level on the Adjacent Space in the Shopping, 4(3), 944–954.
- Rights, A. P., & Architecture, L. (2016). Improving Daylight Illumination and Energy Efficiency Using an Atrium in a Mixed-Use Building In Partial Fulfillment of the Requirements of the Degree of In the Graduate College of.
- Sarah Ward. (2014). Atriums That Inspire for LEED Daylight and Views. Poplar Network. Retrieved from <https://www.poplarnetwork.com/news/11-atriums-inspire-leed-daylight-and-views>
- Savic, J., Djuric-Mijovic, D., & Bogdanovic, V. (2013). Architectural glass: Types, performance and legislation. *Facta Universitatis - Series: Architecture and Civil Engineering*, 11(1), 35–45.
- Saxon, R. (1986). *Atrium buildings development and design* (2nd ed.). London: The Architectural Press.
- Schittich, C., Balkow, D., Schuler, M., & Sobek, W. (2007). *Glass construction manual*. Recherche (Vol. 67). Retrieved from <http://www.lavoisier.fr/livre/notice.asp?id=2LXWK2AS36OOWQ>
- Shi, L., & Chew, M. Y. L. (2012). A review on sustainable design of renewable energy systems. *Renewable and Sustainable Energy Reviews*, 16(1), 192–207. <https://doi.org/10.1016/j.rser.2011.07.147>
- Szokolay, S. V. (2014). *Introduction to Architectural Science-The Basis of Sustainable Design* (3rd ed.). London, United Kingdom: Taylor & Francis Ltd.
- Tabesh, T., & Sertyesilisik, B. (2015). Focus on Atrium Spaces Aspects on the Energy Performance, 54–59.
- Wang, L., Huang, Q., Zhang, Q., Xu, H., & Yuen, R. K. K. (2017). Role of atrium geometry in building energy consumption: The case of a fully air-conditioned enclosed atrium in cold climates, China. *Energy and Buildings*, 151, 228–241. <https://doi.org/10.1016/j.enbuild.2017.06.064>
- Woods, A. W., Fitzgerald, S., & Livermore, S. (2009). A comparison of winter pre-heating requirements for natural displacement and natural mixing ventilation. *Energy and Buildings*, 41(12), 1306–1312. <https://doi.org/10.1016/j.enbuild.2009.07.030>
- Wurm, J. (2007). *Glass structures: design and construction of self-supporting skins*.
- Yunus, J., Ahmad, S. S. H., & Zain-ahmed, A. (n.d.). Evaluating Daylighting of Glazed Atrium Spaces through Physical Scale Model Measurements under Real Tropical Skies Condition, 122–127.
- Yunus, J., Ahmad, S. S., & Zain-ahmed, A. (2011). Analysing the Impact of Roof Obstructions on Daylight Levels in Atrium Buildings: Physical Scale Model Measurements under Real Sky Conditions, 6, 279–284.