

# We are IntechOpen, the world's leading publisher of Open Access books Built by scientists, for scientists

4,800

Open access books available

122,000

International authors and editors

135M

Downloads

Our authors are among the

154

Countries delivered to

TOP 1%

most cited scientists

12.2%

Contributors from top 500 universities



WEB OF SCIENCE™

Selection of our books indexed in the Book Citation Index  
in Web of Science™ Core Collection (BKCI)

Interested in publishing with us?  
Contact [book.department@intechopen.com](mailto:book.department@intechopen.com)

Numbers displayed above are based on latest data collected.  
For more information visit [www.intechopen.com](http://www.intechopen.com)



# Urban Heat Island Effects in Tropical Climate

*Luz E. Torres Molina, Sara Morales and Luis F. Carrión*

## Abstract

This paper reviews some of the characteristics of urban climates and the causes and effects of urban heat island (UHI) issues in the tropical climate. UHI effect is a kind of heat accumulation phenomenon within the urban areas due to urban construction and human activities. It is recognized as the most evident characteristic of urban climate. The increase of land surface temperature in San Juan, Puerto Rico, caused by the UHI effect was influenced by the change of land use and material types in construction. The impacts of daily temperature, surface albedo, evapotranspiration (ET), and anthropogenic heating on the near-surface climate are discussed. Analyzed data and field measurements indicate that increasing albedo and vegetation cover can be effective in reducing the surface and air temperatures near the ground. Some mitigation and prevention measures are proposed for the effects of UHI, such as a flash flood warning system.

**Keywords:** urban heat island (UHI), albedo effects, evapotranspiration, anthropogenic heat

## 1. Introduction

When people talk about the climate, the urban heat island (UHI) is not a new terminology. This began to be relevant decades ago when the cities began to be megacities built without any environmental planning and when the trees and grass were converted to concrete and asphalt. According to the United States Environmental Protection Agency, an urban heat island is created in developed areas where the built surfaces absorb and retain radiation from the sun. The impacts of UHI include increased energy consumption, higher concentration of air pollutants, and increase of air temperature level and flash flood.

Temperature is the most significant atmospheric parameter in researches about the effects of heat island. Studies have documented that urban areas have air and surface temperatures that are, on average, 1.8–5.4°F higher than temperatures in surrounding rural areas and there is potential for up to a 22°F difference in more extreme situations [1]. According to the Intergovernmental Panel on Climate Change (IPCC), global average temperatures have risen by 0.6°C (1.1°F) since 1970 and can be expected to rise another 1–4°C (1.8–7.2°F) by the end of the twenty-first century, depending on future societal practices and the amount of greenhouse gas emissions released into the atmosphere. The 2009 US Global Change Research Program report entitled “Global Climate Change Impacts in the United States”

illustrated that the average mainland US temperature has increased by 1.1°C (2°F) since about 1960, precipitation has increased by 5%, and the frequency of heavy precipitation has also increased by a factor of two [2].

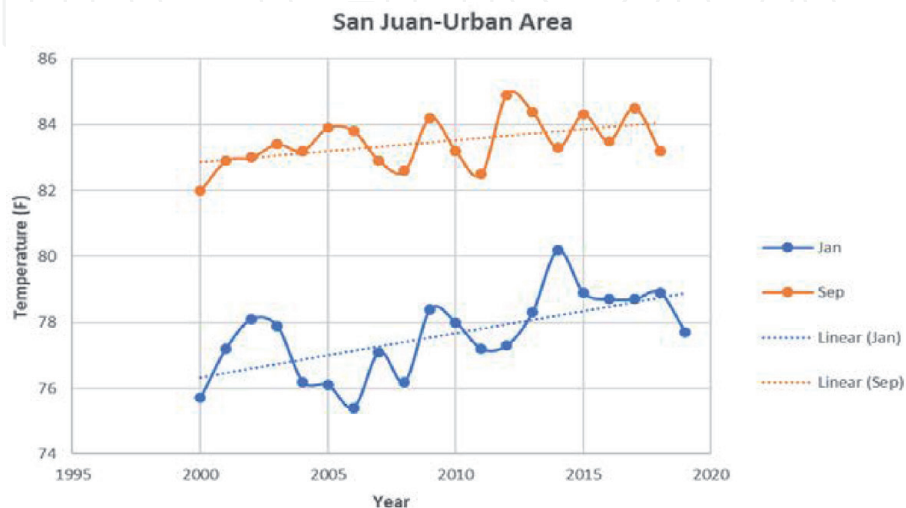
Another important aspect to be studied is evapotranspiration (ET) because the increase of impervious surfaces prevents the movement of air and water which are key in the cooling processes of evaporation and transpiration and creates a typical “heat urban islands” of warmer temperatures, while the green vegetation in the surrounding rural areas better regulate surface temperatures.

This could be evident with the analysis between cities such as San Juan, Puerto Rico (urban), and Gurabo, Puerto Rico (rural). A decrease of evapotranspiration energy from the rural area to the suburbs and finally to the urban area is expected. This change will coincide with a decrease in vegetation coverage. Without the immediately available energy outlet of evaporation, urban and suburban areas must store more energy during the day. The stored energy is subsequently released to the atmosphere at night, primarily through higher radiant emissions and to a lesser extent via increased convection [3].

The flash flood is a consequence of an urban heat island effects. Most people consider that sudden floods are the product of weather phenomena such as tropical waves through even hurricanes. Previous studies have shown that most of flash floods are caused by anthropogenic behavior generally named anthropogenic heat, which is generated by human activity and comes from many sources, such as buildings, industrial processes, and change in land use from pervious to impervious.

## 2. Local climate

The climate of the Caribbean is characterized as subtropical with relatively dry winters and wet summers [4]. The dominant large-scale atmospheric influence on the climate is the North Atlantic subtropical high (NAH). The average temperature at the San Juan, Puerto Rico, station last year was 80.74°F. **Figure 1** shows the annual temperature between the years 2000 and 2018 for the months of January and September [5]. On the other hand, the amount of rainfall varies considerably throughout the study area. Most of the rainfall occurs during the month of August with 7.15 inches on average for the last 20 years. The month of February is considered the dry season with 2.32 inches.



**Figure 1.** San Juan, Puerto Rico, annual temperature (°F) pattern for 2000–2019.

### 3. Study locations

The study UHI is based on the premise that significantly warmer surface temperatures exist in urban settings as opposed to their surrounding rural areas. To make sure that this premise is correct for the Puerto Rico case, seven locations have been selected, which cover the island (see **Figure 2**).

The research began with the use of historical temperature data taken from the southeast regional climate center webpage. The website has the advantage of having historical data such as temperature and precipitation of at least 50 years. For this research, the temperature was the parameter for defining the problem. Data with more than five decades were used to study the changes in temperature between the urban area and the rural area.

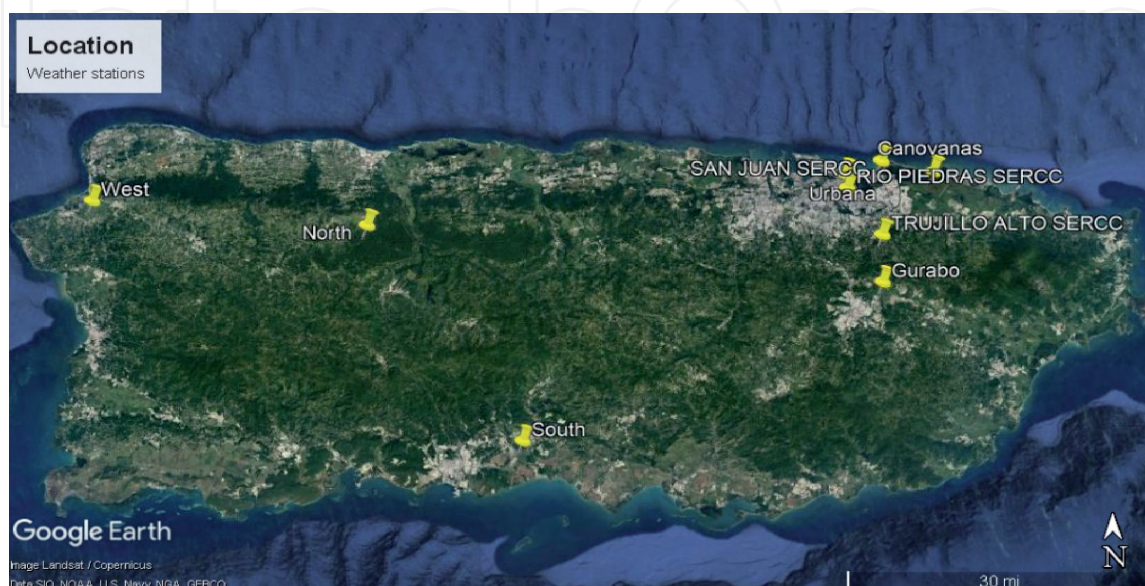
The city of San Juan, Puerto Rico (18.44, -66, geographic coordinates in decimal degrees latitude and longitude), is designated as an urban area, and it is the capital city of Puerto Rico. The number of residents in the city is declining from 428,800 in 1957 to 321,000 in 2019. The city designated as a rural area is Gurabo, Puerto Rico (18.25, -66, geographic coordinates in decimal degrees latitude and longitude), located at 20 km from San Juan, Puerto Rico. In 1957 it was estimated that it had 16,600 inhabitants, and in 2019 it has 46,000 residents [6].

**Figure 3** shows the difference in temperature between urban and rural areas. The data was taken from 1957 to 1967 at each station and displays a difference in temperature on average of 2.62°F. Furthermore, the same comparative analysis was carried out for the years between 2008 and 2018 (see **Figure 4**). For this case, the difference between temperature increases was around 3.46°F.

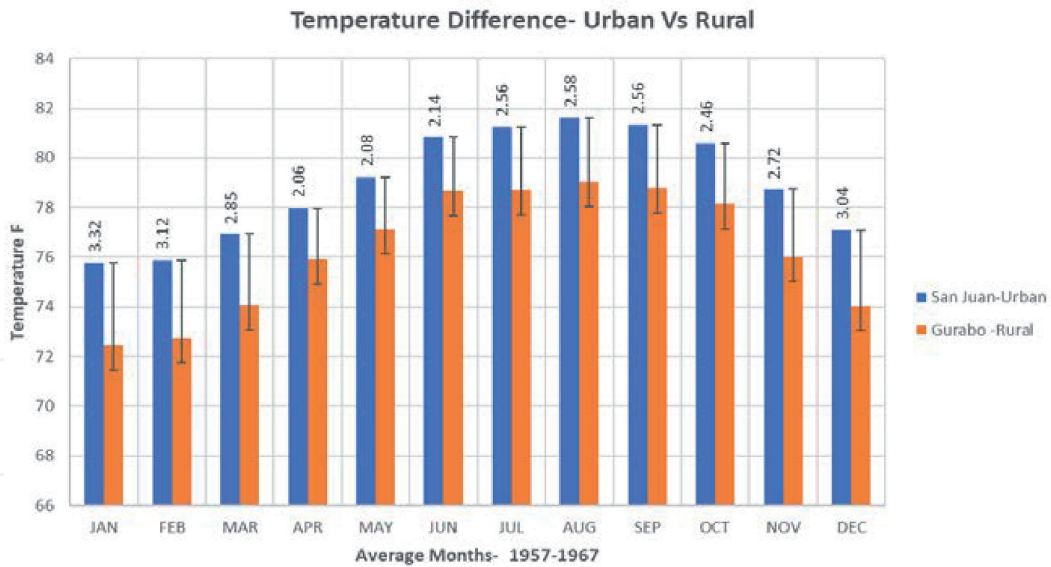
Stations located in San Juan, Puerto Rico, and Gurabo, Puerto Rico, show that both period 1957–1967 and period 2008–2018 temperatures are on the rise in heavily urbanized areas where there is a conversion of natural vegetation to urban dwellings.

A NASA study found that in the summer months, the temperature in New York was on average 4°C higher than in the surrounding area. Studies from the 1960s already pointed to the phenomenon of heat island, but the effect is becoming more intense due to climate change.

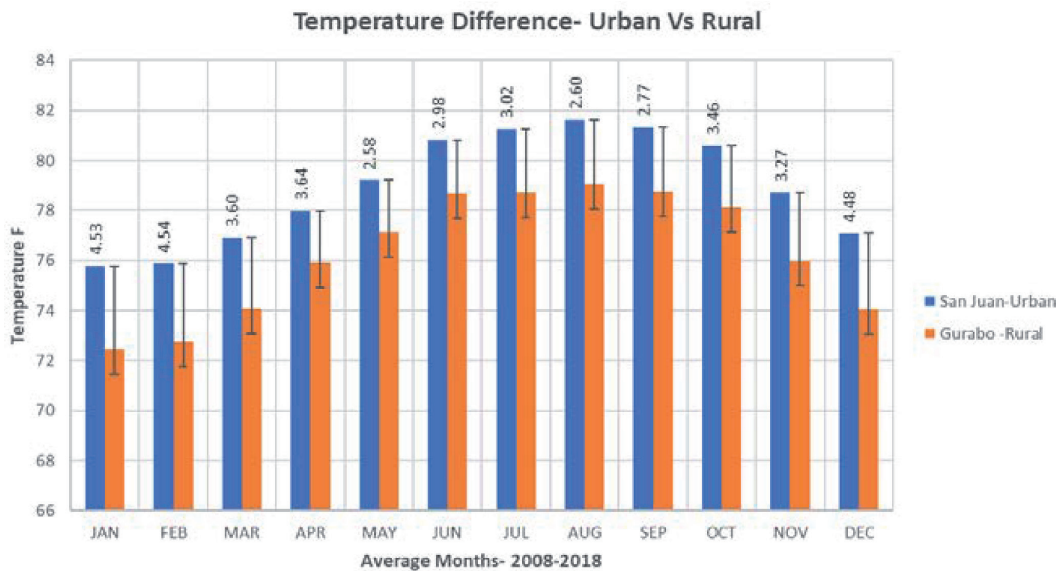
Another way to verify the existence of heat islands is to make a parallel analysis of urban area temperature behavior as it moves away from its center and approaches a rural area. As shown in **Figure 5**, the first station away from the urban location is



**Figure 2.**  
*Study locations, Puerto Rico.*



**Figure 3.** Difference of temperature (°F) between urban and rural areas (1957–1967).

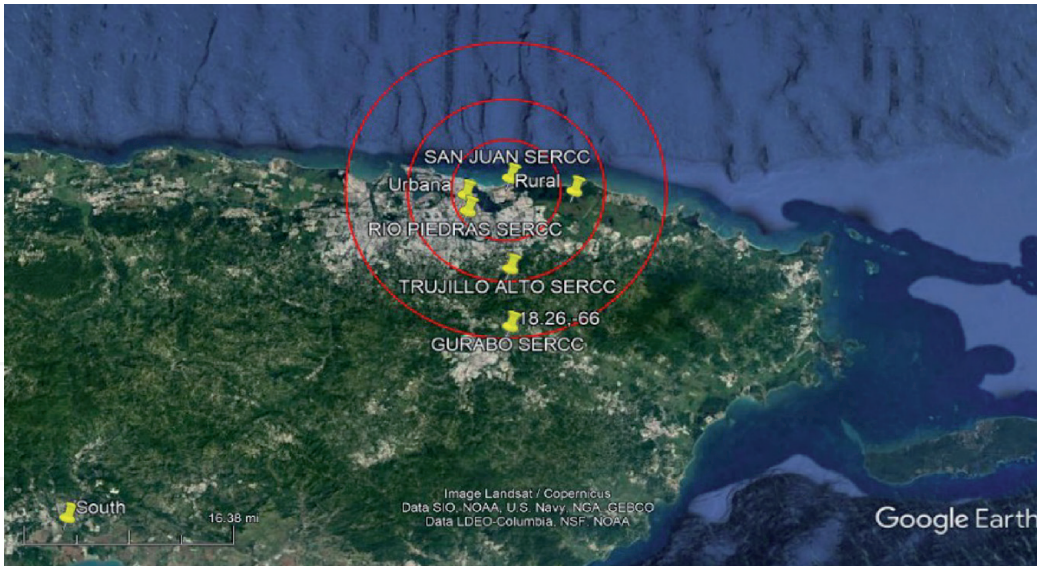


**Figure 4.** The difference of temperature (°F) between urban and rural areas (2008–2018).

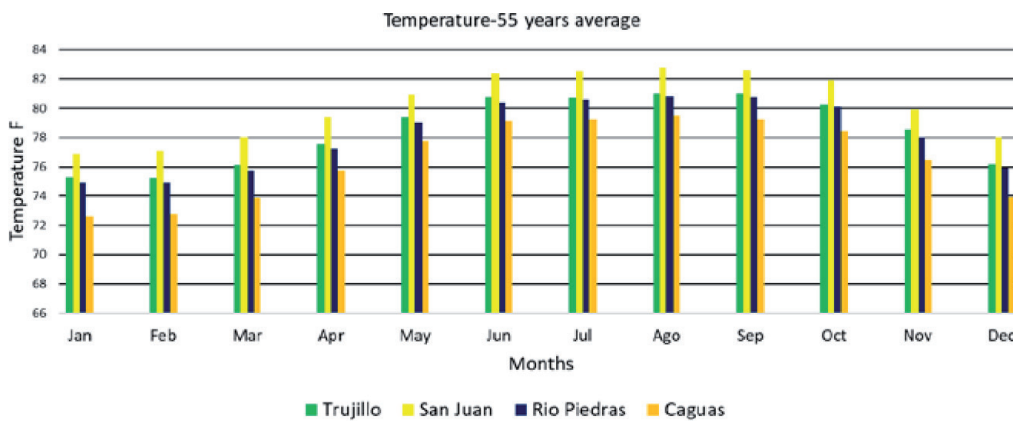
Rio Piedras, located at 6 km; the next station is Trujillo Alto, located at 12 km from San Juan, Puerto Rico; and the last is Gurabo, Puerto Rico, considered as a rural area located at 20 km from San Juan, Puerto Rico.

Considering the temperature average during the last 55 years in the urban area (San Juan, Puerto Rico) for all months, this shows the highest values compared to the other stations, during the 12 months of the year. It is observed that the coldest months during the period studied are the months of January and February and those with the highest temperatures are August and September. The latter matches with the peak of the hurricane season, where the temperature on the surface of the Atlantic Ocean is at its highest and optimum level for the formation of more powerful hurricanes (see **Figure 6**).

Stations located in San Juan, Puerto Rico, show that both January (minimum) and September (maximum) are on the rise in heavily urbanized areas where there is a conversion of natural vegetation to urban dwellings. This theory was before validated by Gonzalez and Comarazamy in 2009 [7]. Urban data analysis also found

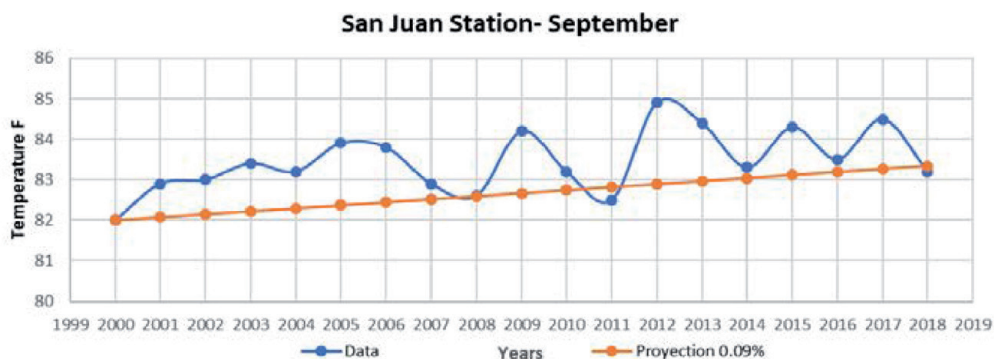


**Figure 5.**  
 Location of stations: San Juan, Rio Piedras, Trujillo Alto, and Gurabo, Puerto Rico.



**Figure 6.**  
 Average temperature (°F) using data of 55 years in four different stations.

warming in the San Juan, Puerto Rico area, with a trend of 0.09%/year. from 1957 to 2012. This result was obtained when estimating the delta of change of all the months of the year from 1957 to 2012. **Figure 7** shows the projection for the warmer month (September). Using the 0.09% growth (obtained from 1957 to 2012) and the recent data (2000–2019), it is observed that, although there is a difference in some years, after each decade this projection must be more accurate.



**Figure 7.**  
 San Juan data station (°F) and projection data with 0.09% increase yearly.

Rosenzweig et al. [8] analyzed the New York city heat island effect model by taking six case study areas and tested the mitigation strategies. They found that vegetation helps to keep surfaces cool more effectively than increasing the albedo. But they suggested that in order to reduce the temperature in New York city, replacement of low-albedo materials with high-albedo light-colored materials will work great as 64% of the surface area of the city can be replaced easily.

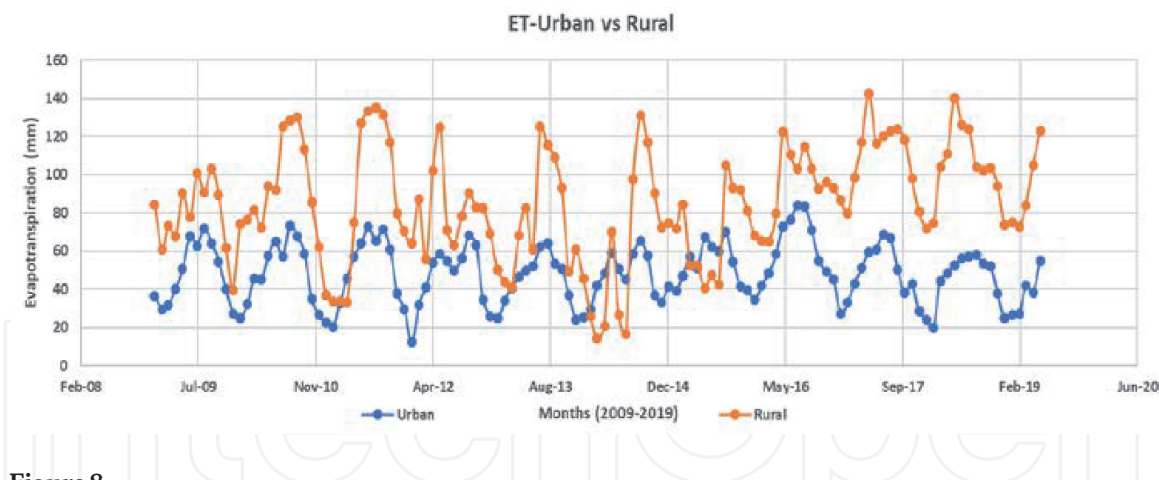
Sailor [9] describes that the urban heat island effect mitigation can be done in two ways. One is by increasing the albedo of the urban surface, and the other is by increasing evapotranspiration. On the other hand, white materials which have albedo greater than 0.60 instead of black materials having albedo of 0.05–0.10 can be used as roofing materials. They found that the roof temperature dropped by 25°C for 0.60 albedo compared to that of 0.20 albedo. More solar radiation could be reflected if the road and highway pavements were of high-albedo materials. White cement mixtures can be made for which the albedo should be higher than the most reflective gray cement mixtures. However, use of high-albedo materials for roads and highway pavement may not be so much effective because of the sky view factor. Even if, it is used, some of the reflection will be intercepted by the buildings surrounding it.

#### 4. Evapotranspiration and net radiation

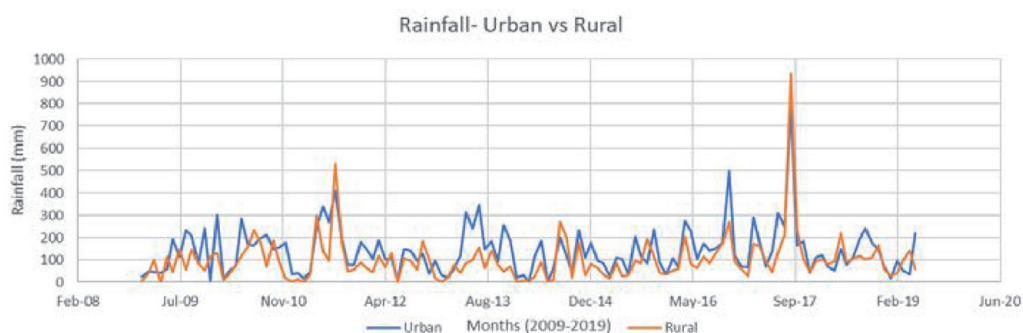
Some of the characteristics can be sorted into the four main causes of heat island formation: reduced evapotranspiration, increased heat storage, increased net radiation, and increased anthropogenic heat. The lack of vegetation and increase of surface impervious cause a reduction in evapotranspiration. Low solar reflectance and increased levels of air pollution foment increases in net radiation. Evapotranspiration is energy transmitted away from the Earth's surface by water vapor, and this is a process plants use to keep themselves cool, and it increases when there is more moisture available. On the other hand, net radiation encompasses four separate radiation processes taking place at the Earth's surface. Net radiation = Incoming solar – Reflected solar + Atmospheric radiation – Surface radiation. The first term in the equation is related with the amount of energy radiating from the sun. This varies in Puerto Rico mainly according to the time of the day, the amount of cloud cover, and the atmospheric pollution levels. The second term, reflected solar, is directly related with the “albedo,” which is the amount of solar energy that bounces off a surface. The higher albedo, the greater is the amount of reflected energy. The third term is heat emitted by particles in the atmosphere, such as clouds, pollution, and Sahara dust and the last term, surface radiation, is heat radiated from a surface itself. A relatively warmer surface radiates more energy to its surroundings, which is the case of San Juan city in north Puerto Rico area. In 2002, the north area city had approximately 70% impervious surface cover, 13% grass area, and 16% tree areas [10].

A comparative study for evapotranspiration and net radiation was successfully accomplished, as part of the evidence to determine the heat island effect. Using GOES satellite data, the ground level, 1 km resolution net radiation, evapotranspiration, and rainfall parameters became available in Puerto Rico in March 2009 [11]. **Figure 8** shows that during the last 10 years, evapotranspiration measures have been higher in the area designated as rural, the difference between rural and urban is very significant, and this evidences a tendency to a separation that increases with time.

In the case of precipitation between the urban and rural areas, using 10-year historical data, it is observed that rainfall has been greater in the urban center (**Figure 9**), under conditions of similar land use. It would be assumed that the amount of precipitation increases evapotranspiration. But this is not the case when there is an UHI phenomenon.



**Figure 8.**  
*Evapotranspiration (mm) urban vs. rural data (2009–2019).*



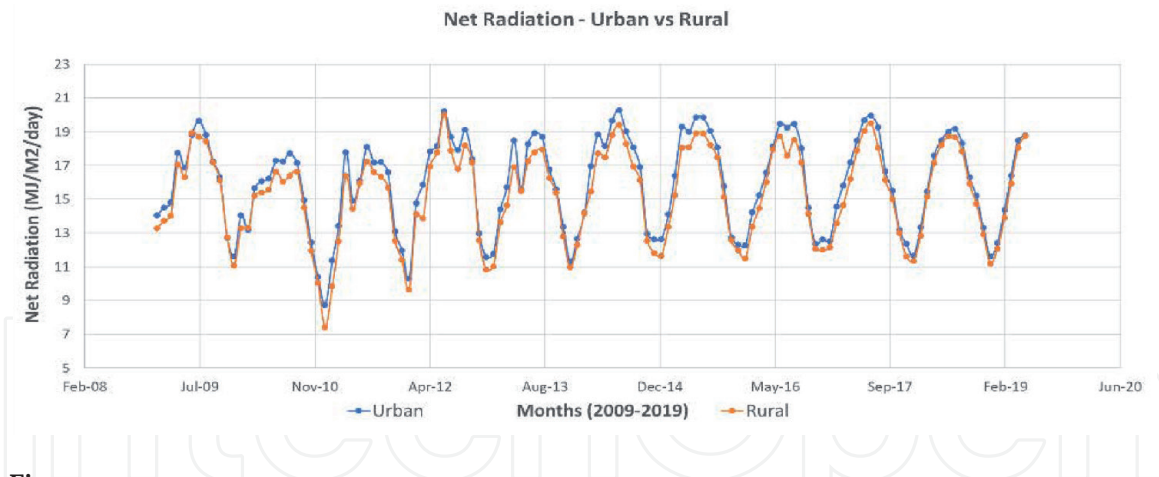
**Figure 9.**  
*Rainfall (mm) urban vs. rural data (2009–2019).*

The earth in natural conditions absorbs rain, which is evaporated by the sun's rays on hot days and released to the atmosphere, cooling the environment. The lack of vegetation in the cities contributes to the heat island effect. But in the cities, the rain ends up in the sewage systems. The urban centers usually also have few trees. Vegetation plays a crucial role due to evapotranspiration.

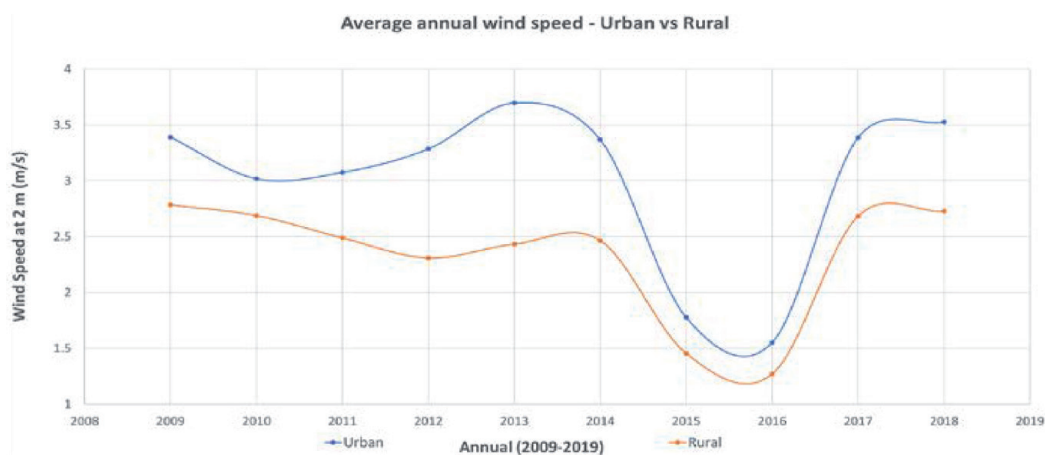
Another valid theory is that the net radiation collected by an urban setting is generally greater than that collected in a rural area. The difference is due to many factors, such as, for the Puerto Rico case, lower solar reflectance of urban materials and restrictive urban geometries. Another significant factor, even though it occasionally happens, is the pollutant due to Sahara dust. However, the difference in net radiation between urban and rural areas is not significant. A possible little difference is observed in **Figure 10** where the urban area has higher values. During the 10 years of study, an average of 0.6656 MJ/m<sup>2</sup>/day represents the difference in net radiation.

Another main characteristic of the climate is wind speed. Physical characteristics of urban climate such as tall buildings, paved streets, and parking lots affect wind flow. The differences of urban climate and rural climate are attributable in large part to the altering of the natural terrain through the construction of artificial structures and surfaces. In theory, the center of a city is warmer than the outlying areas. Monthly minimum temperature readings at related urban and rural sites frequently show that the urban site is 3–4°F warmer than the rural site, for this case. Two primary processes influence the formation of this “heat island.” During summer, urban masonry and asphalt absorb, store, and reradiate more solar energy per unit area than vegetation and soil typical of rural areas. Furthermore, a small amount of this energy can be used for evaporation in urban areas, which characteristically exhibit greater precipitation runoff from streets and buildings. At night,





**Figure 10.**  
Net radiation urban vs. rural data (2009–2019).

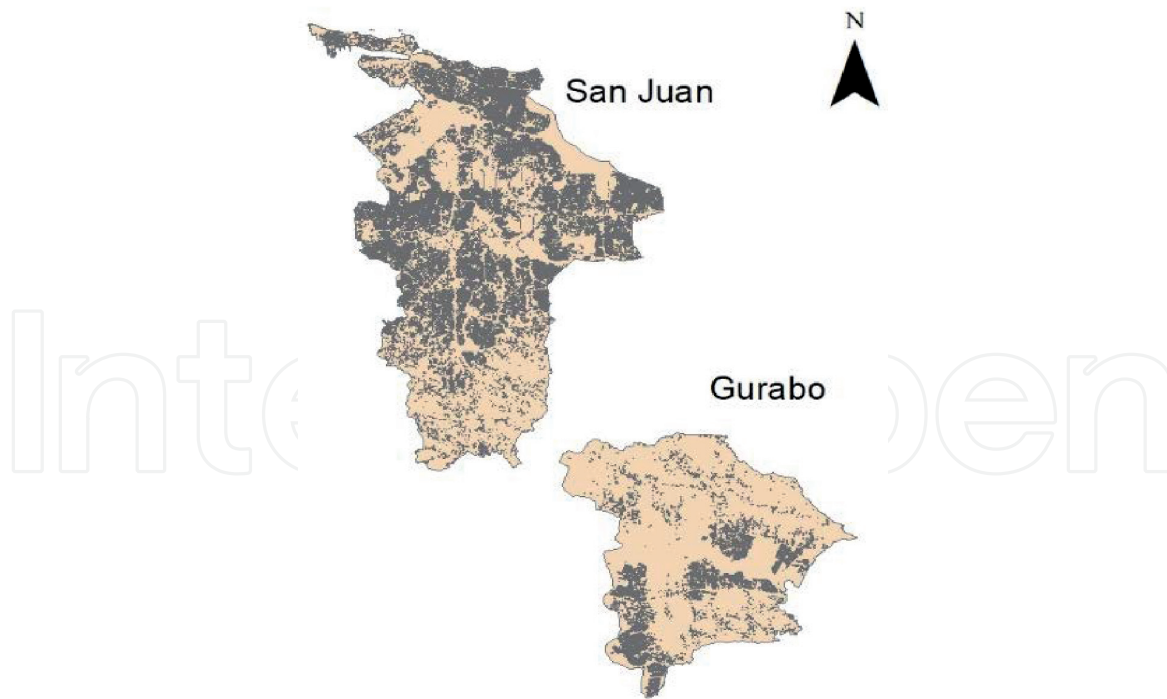


**Figure 11.**  
Average annual wind speed - urban vs rural area.

radiative losses from urban buildings and street materials keep the city's air warmer than that of rural areas. For this case, it is important to consider the location of the urban site and rural site. San Juan is located on the NE coast of the island of Puerto Rico. It is surrounded by waters of the Atlantic Ocean. The climate is tropical marine, slightly modified by insular influence when land breezes blow. San Juan is representative of most of the coastal localities on the island. That proximity to the coast makes wind speeds higher than in the rural area (see **Figure 11**).

## 5. Surfaces and materials

Buildings' volume, orientation, and the aspect ratio of the spaces between them affect the exposure of urban surfaces to the solar radiation. The concentration of concrete structures without green surfaces between them increases the air temperature of urban areas. In this case study, the concentration of buildings is significantly higher in San Juan than in Gurabo, Puerto Rico (see **Figure 12**). The gray plots indicate the building structures in each city. At a first glance, it is observed that there is a greater amount of building structures in the city of San Juan. The city of San Juan has three times more building structures than the city of Gurabo. The city of San Juan has 127.98 km<sup>2</sup> of the surface area of which 15.89 km<sup>2</sup> are of building structures. On the other hand, the city of Gurabo has 73.22 km<sup>2</sup> of the surface area of which 3.33 km<sup>2</sup> are of buildings.



**Figure 12.**  
*Building structures San Juan vs. Gurabo, Puerto Rico.*

The complex heat exchange between buildings' mass and adjacent air changes the intensity and patterns of airflow in urban canyons where wind patterns are also affected by the canyon-like structure of streetscapes surrounded by tall buildings. Urban surface materials' thermal characteristics (specific heat, mass, conductivity, and diffusivity), color, texture, and coverage alter heat exchange in urban settings and are important to determine UHI.

Some construction materials have properties that tend to exacerbate the heat island problem. Two material properties are important to heat storage: thermal conductivity and heat capacity. Materials with high thermal conductivity tend to conduct heat into their depths. Materials with high heat capacity can store more heat in their volume. A combination of these properties, called thermal diffusivity, is an important indicator of how easily heat can penetrate a material. Thermal diffusivity is calculated by dividing a material's thermal conductivity by its heat capacity. Rural areas tend to be composed of materials of lower thermal diffusivity, while urban areas have higher diffusivities. This enhances the storage of heat during the day and its slow release at night [12].

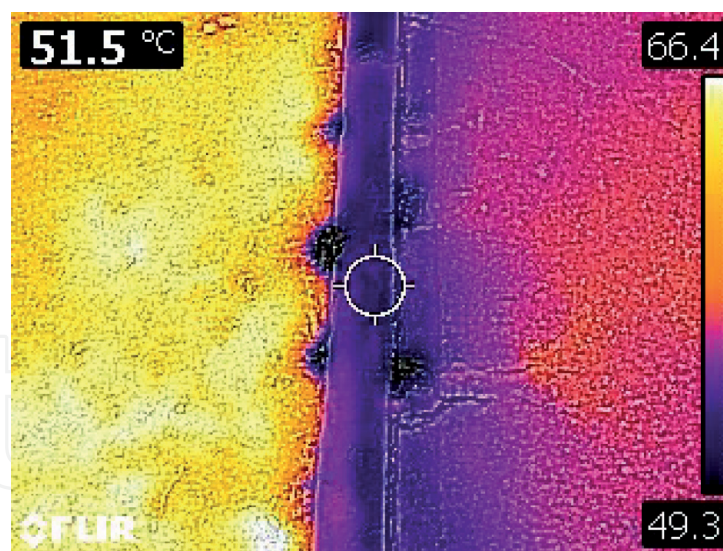
Thermal diffusivity ( $\text{mm}^2/\text{seg}$ ) is given by the following relationship:

$$\alpha = \frac{k}{\rho C} \quad (1)$$

where  $k$  is thermal conductivity ( $\text{W/mK}$ ),  $\rho$  is density ( $\text{kg/m}^3$ ), and  $C$  is specific heat ( $\text{J/kgK}$ ).

Another significant material characteristic is the albedo. Urban areas are considered with a low albedo, while rural areas are considered with higher albedos. Most urban materials reflect less incoming solar energy than materials commonly found in rural areas. **Figure 13** shows differences of temperature between two widely used materials in Puerto Rico, such as asphalt and concrete, at 14:00 hours on a spring day.

The asphalt shows temperatures that reach  $61^\circ\text{F}$ , compared to the temperature of the concrete that decreases by almost  $20^\circ\text{C}$ . This demonstrates that under normal conditions, in a country like Puerto Rico where the solar radiation received



**Figure 13.**  
Asphalt (left) vs. concrete (right) temperatures ( $^{\circ}\text{C}$ ).

throughout the year is constantly high, the roads built on asphalt should be changed to another material such as concrete, where heat emissions decrease considerably.

Commonly in urbanized places, two prominent materials have low values of solar reflectance: asphalt paving and built-up roofing (black roofs). The prevalent use of these materials lowers the overall solar reflectance of communities. Some of the characteristics of the materials commonly found in urban and rural areas are presented in **Table 1**, where the specific heat capacity and albedo are important features when reference is made to UHI.

In addition to the materials used in structures, road, and roofs, detailed computational and wind tunnel study shows that building packing density or how packed buildings are erected in a unit area also affects the movements of polluted and heated air from the pedestrians' levels, which eventually affects UHI. Reda et al. [13] performed computational fluid dynamics (CFD) simulations using OpenFOAM as well as ran experiments using blocks in wind tunnel using the Kuala Lumpur City Center, at five different locations representing different building densities. The results show that the more packed buildings are spaced, the harder for the incoming winds to clear the polluted and heated air trapped at low levels. Based on further details of the CFD simulations and atmospheric-scaled measurements, there are complex interactions such as vortices and large-scale features in the bulk movements of air and the more static air at near the grounds [14].

One of the characteristics of cities with UHI effects is the increase in impervious areas, where there is change in land use, i.e., grass or trees have been converted to parking lots and roads. These changes have increased flash floods in cities, leading

Material	Thermal diffusivity ( $\text{mm}^2/\text{s}$ )	Albedo
Asphalt	1.017	0.04
Concrete	0.677	0.22–0.55
Wood	0.26	0.15
Grass	—	0.25

**Table 1.**  
Material characteristics.

to major economic disasters and human losses. A personal flood alert system is being proposed as a mitigation method for this type of event, and these are shown in the following topic.

## 6. Flood alert system

One of the effects of UHI is flash floods, which is a consequence of the increase of the impervious areas. Floods are the most frequent disaster type and cause more humanitarian needs than other natural disasters. The use of new technologies with higher accuracy, covering areas missed by radars, is important for flood warning system efforts and for studying and predicting atmospheric phenomena [15]. Almost 90% of all-natural disasters in the United States lead to flooding, and 20% of all flooding claims happen in low to moderate flood risk areas [16].

This information is important when judging where to live. Home insurance does not cover anything that is not attached to the house. Insurance policies for cars, for example, that are the most affected by flooding since most of them are outside must have specific insurance called comprehensive insurance. This system not only can save a family's pocket and vehicle, but it can also save lives by notifying them of the flash flood occurring in the area. In addition, it can help gather information about the flood in the area of the disaster.

Many people lose their vehicles due to flash floods at parking lots. A way to avoid such disasters is by creating a flood alarm system that detects flood levels from their own cars making this alert more specific depending on individual cases. The system must be able to do the following: detect and measure water elevation considering the type of vehicle and its size. The alarm will function via phone call or text. As an alternative method, if there is no signal in the area, the cars' alarm system will alarm the owners instead of a phone call or text. Giving security to any of these two methods to notify the affected person.

How the system works is indicated in **Figure 14**. Once the system detects the sudden rise in water level, it will alert the owner through phone call or text. As a final step, the owner of the vehicle will move the car to a safer location if it is possible.



**Figure 14.**  
*Diagram of the process for a flood alert system.*

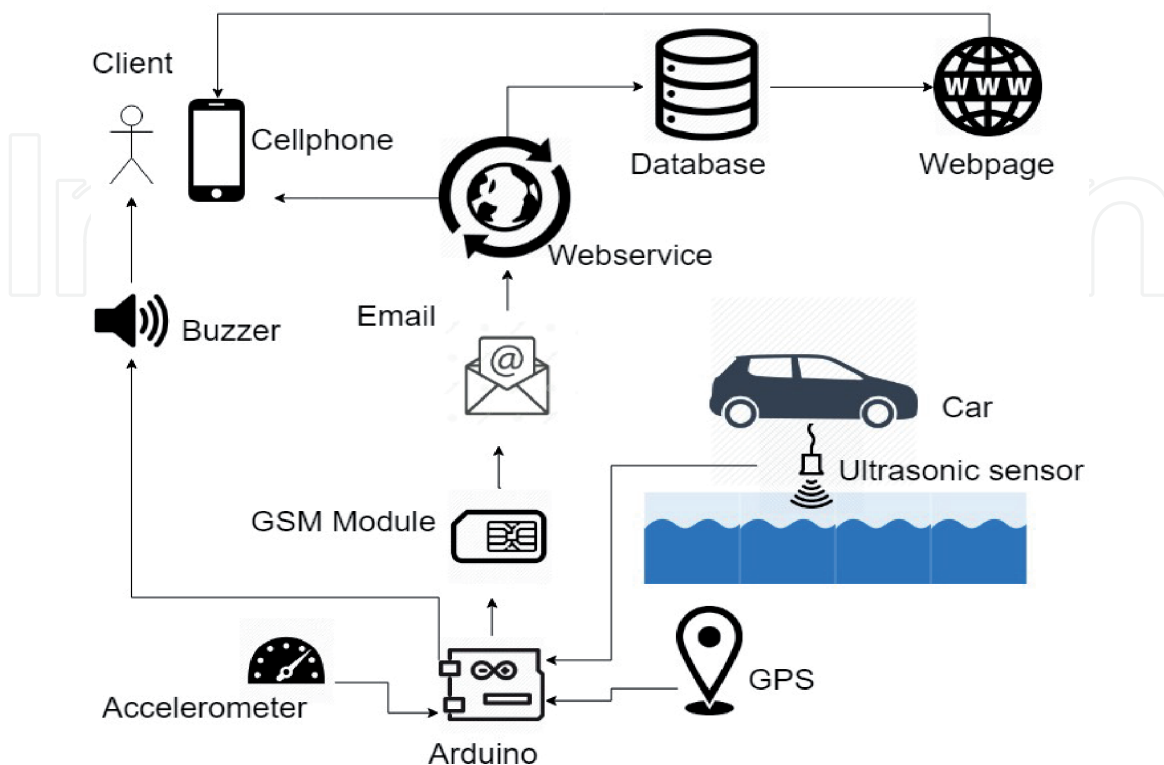
## 7. Proposed system

The proposed system alerts the client when the water level is a threat to the vehicle. This system includes a set of sensors that will perceive different measurements in water level and vehicle acceleration. If the water level increases to a threatening level, it will alert the client via web service through a text message which notifies about a sudden flood every 10 seconds. When for any reason there is no signal, the system has the option to send a notification so that the vehicle horn starts to go off; this functions as another alternative. In case that the car is in motion, it will notify the client by an audible notification. The collected data will be used to report flooded areas in real time through a web service.

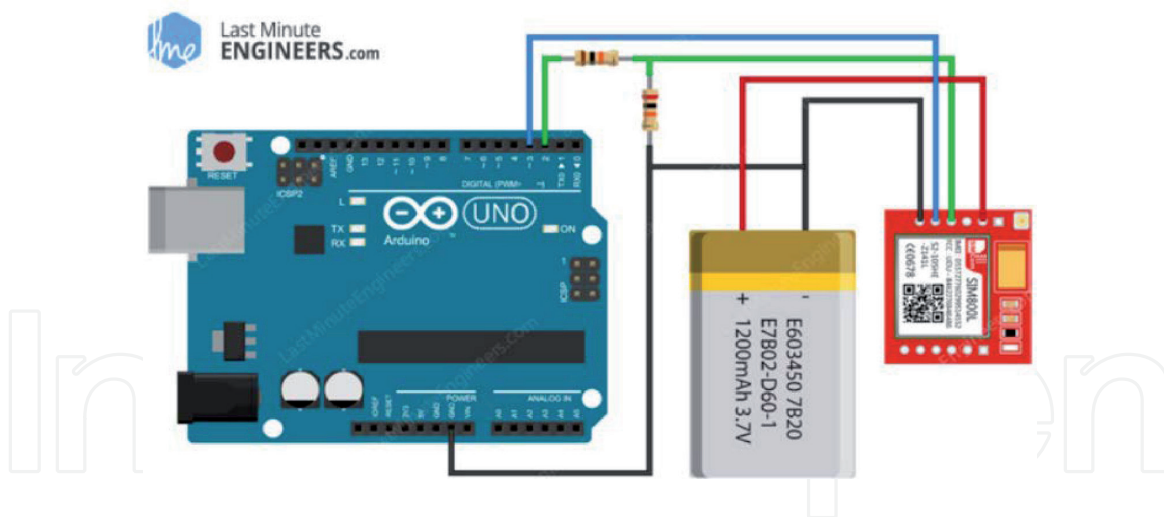
The system is located inside the car, close to each of its four tires. The Arduino will receive data from the accelerometer, ultrasonic, and the GPS module. Once the data has been processed, the device will detect if the water level has risen to a threatening level. There are two forms of operation. In the first one, when the vehicle is moving, the client will be alerted by an audible notification located inside the car. And in the second one, if the vehicle is stationary, the client will receive a text message sent by the web service. The web service stores the information received in our database and will provide information that the client may see from their devices. **Figure 15** presents interaction of the system, client, and webpage.

This system consists of the following components: ultrasonic sensors, the GSM module, and the accelerometer. Each of these components plays an essential part in the contraction of this prototype. A breadboard is used as an intermediary for the connection from the Arduino mega to each component. An ultrasonic sensor is used to measure the distance between the ground or water and the sensor. It contains four pins: VCC, trig, echo, and GND. In order to function, it needs a power of 5 V which can be found in the Arduino. They emit and receive sound waves in order to detect how far the object is. It does not measure the distance, but rather the time of emission and receiving [17].

A GSM module's operating voltage is between 3.4 and 4.4 V, and an external battery must be used to supply the power to the module. This module includes an individual antenna called helical antenna that is connected such as a button and a net pin. In addition, at the back of the module is a micro SIM card slot. The module is used to connect to the cellular network in order to notify the owner of the vehicle via email, website, or text message. The module has an LED light that indicates the status of the cellular network. When blinking every 1 second, the module is running and looking for a network, when blinking every 2 seconds the GPRS data connection requested is active, and for every 3 seconds, the module has successfully connected to the network. To make the module work, it is necessary to connect the pins accordingly such as in **Figure 16** since the module only handles 3.4–4.4 V.



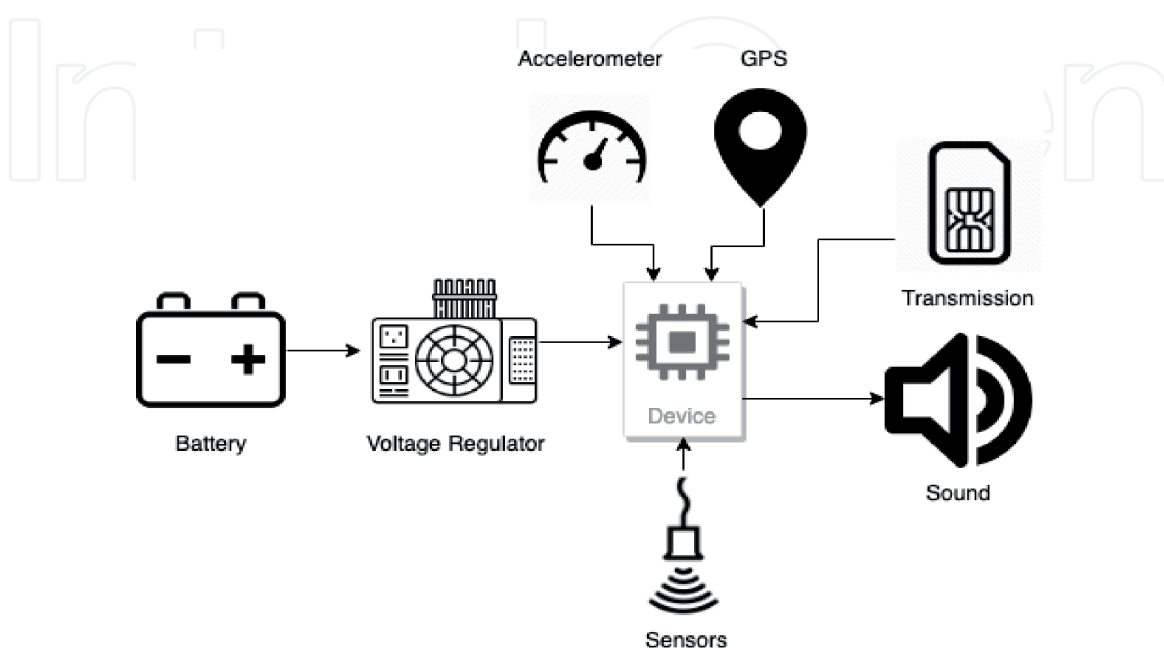
**Figure 15.**  
*Interaction of the system, client, and webpage.*



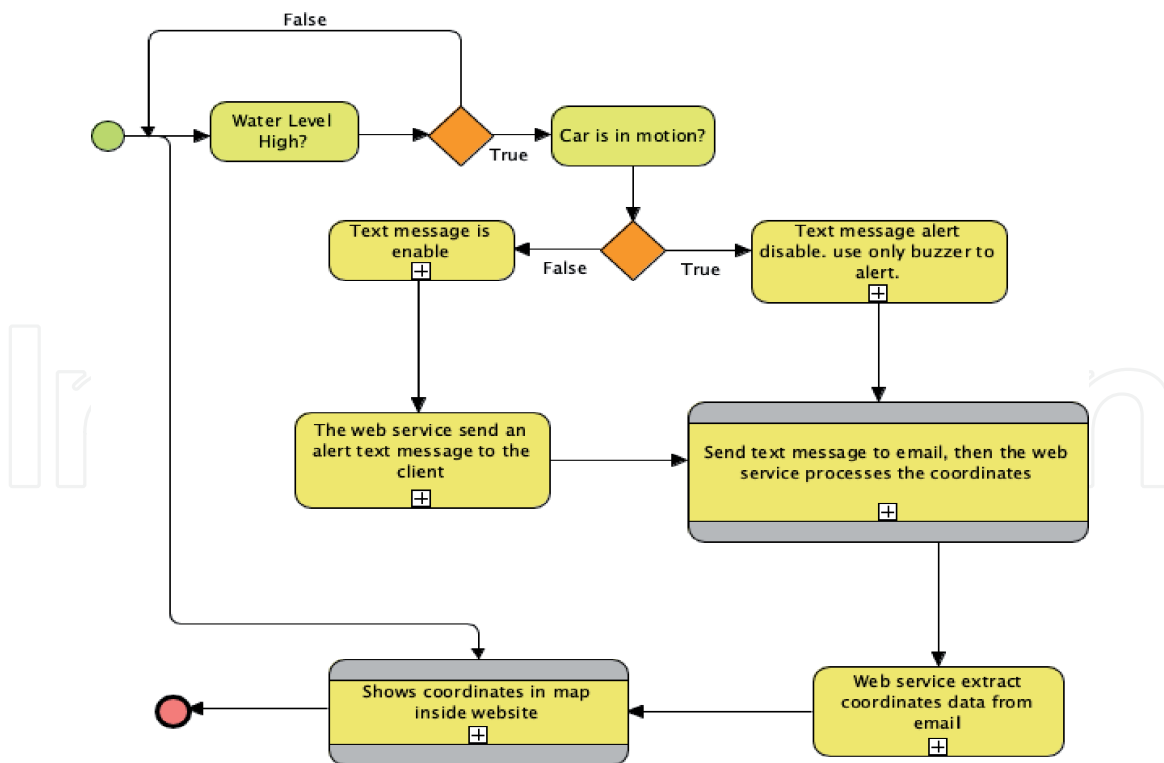
**Figure 16.**  
*Circuit assembly for GSM module.*

An accelerometer is used to detect if the car is in motion. It works by sensing the acceleration of gravity [18]. This sensor has several pins. For this case four were used: the VCC, which needs 3.3 V to be powered, GND, serial clock line (SCL), and serial data line (SDA). **Figure 17** shows the interaction of the devices. The car battery shall be connected to a voltage regulator next to the Arduino in order to protect it. The Arduino is connected to the sensors that are responsible for obtaining the readings for when the water level is rising. It will also have an accelerometer connected in order to know when the car is in movement. There will also be a GPS module (to recognize the coordinates of the vehicle), an alarm (to notify the client when the car is moving), and a GSM module (to be able to send a message of the coordinates to an email for the web service to extract its information and process the data to store it in the database).

Once the accelerometer detects that the car is not in motion, the ultrasonic sensors start measuring the distance between the ground and itself. If there is a sudden rise in water level, using conditions established in the program, the ultrasonic sensors detect it, and the GSM module will send a warning message to notify of the sudden rise.



**Figure 17.**  
*Devices schematic diagram and interactions.*



**Figure 18.**  
System work diagram.

The software of the program consists of conditions based on thresholds, distances, and a counter. The first question is whether the vehicle is moving. This is where the accelerometer detects its movement using the Cartesian plane of  $x$ ,  $y$ , and  $z$ . In the process diagram, in **Figure 18**, the first step is to detect if the water level is high. If the level is low, it shall keep checking if there is any change. If not, the vehicle shall proceed to check if the vehicle is in motion. If the car is in motion, then the text message alert will be disabled, and the client will be alerted through an audible notification. On the contrary, a text message will alert the client. Once the movement is detected, and the condition is established, a text message will be sent to the web server email containing the coordinates. The data is processed, and the web service extracts the coordinates from the email. After extracting the coordinates, a signal is made on the map shown on the web site where there are flooding areas.

## 8. Conclusion

Based on historical data and remote sensing technology, research on atmospheric characteristics and environmental effects of UHI has been conducted in the city of San Juan, Puerto Rico, providing a theoretical reference that evidenced the increment of UHI in the capital city. Based on analyses of temperature, solar radiation, evapotranspiration, and albedo data, it was found that the city of San Juan, Puerto Rico, is the most representative zone where the UHI is present in the last 20 years. The consequences of this effect have increased more rapidly in the last 10 years. In conclusion using high-albedo materials and pavements, having green vegetation and green roofs, implementing urban planning, and preserving pervious pavements, shade trees, and water bodies in city areas are the potential UHI mitigation strategies [19]. When urban planning is mentioned, a flood alert system is included. This paper represents the first time that water level technology has been used for hydrologic analyses, specifically for flash floods which are events caused by

UHI. The proposed system sends flood SMS alerts to the inhabitant of such zones for necessary action. The flood monitoring system can be expanded to cover a wider area than the one under study due to the protocol capabilities. In addition, this model can be used in flash floods, parking lots, streets prone to flooding, and other zones with a high probability of flood. Furthermore, UHI effects that develop in the city were also discussed, and through strategies such as the improvement of energy efficiency, urban landscape optimization, green roof construction, high reflectivity material utilization, and green land cultivation, UHI effects could be significantly mitigated.

## **Acknowledgment**

The authors would like to thank CIESESE and Universidad Ana G Méndez (UAGM) for giving them the opportunity to participate in the PREC 2019.

## **Author details**


Luz E. Torres Molina<sup>1\*</sup>, Sara Morales<sup>2</sup> and Luis F. Carrión<sup>2</sup>

<sup>1</sup> Civil Engineering Department, Universidad Ana G Méndez, Gurabo, Puerto Rico

<sup>2</sup> Engineering Department, Universidad Ana G Méndez, Gurabo, Puerto Rico

\*Address all correspondence to: [torresl6@uagm.edu](mailto:torresl6@uagm.edu)

## **IntechOpen**

© 2020 The Author(s). Licensee IntechOpen. This chapter is distributed under the terms of the Creative Commons Attribution License (<http://creativecommons.org/licenses/by/3.0>), which permits unrestricted use, distribution, and reproduction in any medium, provided the original work is properly cited. 



## References

- [1] EPA. Reducing Urban Heat Island; 2010
- [2] Parry ML, Canziani OF, Palutikof JP, van der Linden PJ, Hanson CE, editors. Climate Change 2007: Impacts, Adaptation and Vulnerability. Contribution of Working Group II to the Fourth Assessment Report of the Intergovernmental Panel on Climate Change. United Kingdom: Working Group 3 Report: Society and Economy Cambridge University Press; 2007
- [3] Gartland L. Heat Islands. 1st ed. London: Routledge; 2008. DOI: 10.4324/9781849771559
- [4] Taylor M, Alfaro E. Climate of Central America and the Caribbean. In: Oliver JE, editor. Encyclopedia of World Climatology. Netherlands: Springer; 2005. pp. 183-189
- [5] The United States National Weather Service. 2019. Available from: <http://www.weather.gov>
- [6] Geological maps, Department of Geology, Puerto Rico. Available from: <http://www.gis.pr.gov>
- [7] González JE, Comarazamy DE. Climate Impacts of LCLU Changes on a Tropical Coastal Region under a Changing Climate. 2nd International Conference on Countermeasures to Urban Heat Island. Berkeley, CA: Environmental Energy Technologies Department, E.O. Lawrence Berkeley National Laboratory; 2009
- [8] Rosenzweig C, Solecki W, Slosberg R. Mitigating New York City's Heat Island with Urban Forestry, Living Roofs, and Light Surfaces. A Report to the New York State Energy Research and Development Authority; 2006
- [9] Sailor DJ. Mitigation of Urban Heat Islands—Recent Progress and Future Prospects. Paper Presented at the Paper presented on American Meteorological Society 6th Symposium on the Urban Environment and Forum on Managing Our Physical and Natural Resources; 2006
- [10] Ramos-González OM. The green areas of San Juan, Puerto Rico. Ecology and Society. 2014;**19**(3):21. DOI: 10.5751/ES-06598-190321
- [11] Puerto Rico Agricultural Water Management. Available from: <https://pragwater.com/>
- [12] Subhrajit G. A review of Heat Islands: Understanding and mitigating heat in urban areas. Journal of the American Planning Association. 2013;**79**(3):256-257. DOI: 10.1080/01944363.2013.811377
- [13] Reda E, Zulkifli R, Harun Z. Large Eddy simulation of wind flow through an urban environment in its full-scale wind tunnel models. Journal of Mechanical Engineering Science. 2017;**11**(2):2665-2678
- [14] Lotfy ER, Abbas AA, Zaki SA, Harun Z. Characteristics of turbulent coherent structures in atmospheric flow under different shear–buoyancy conditions. Boundary-Layer Meteorology. 2019;**173**:115-141
- [15] Torres M. Flood alert system using sensor networks in flood prone zone. In: 16th LACCEI International Multi-Conference for Engineering, Education, and Technology: Innovation in Education and Inclusion, 19-21 July 2018. Lima, Peru; 2018
- [16] Consumer Reports. Why flooded-out cars are likely total losses. Available from: <https://www.consumerreports.org/car-insurance/why-flooded-out-cars-are-likely-total-losses/>
- [17] Latha A. Distance sensing with ultrasonic sensor and Arduino.

International Journal of Advance  
Research, Ideas and Innovations in  
Technology. 2016;2(5)

[18] Kosobitsky P, Ferens R. Statistical  
analysis of noise measurement system  
based on accelerometer-gyroscope  
GY-521 and Arduino platform.

In: 14<sup>th</sup> International Conference  
the Experience of Designing and  
Application of CAD Systems in  
Microelectronics (CADSM). Ukraine:  
Lviv-Polyana; 2017. pp. 405-407

[19] Nuruzzaman M. Urban Heat  
Island: Causes, effects and mitigation  
measures - a review. International  
Journal of Environmental Monitoring  
and Analysis. 2015;2(3):67-73. DOI:  
10.11648/j.ijema.20150302.15

IntechOpen