

We are IntechOpen, the world's leading publisher of Open Access books Built by scientists, for scientists

4,800

Open access books available

122,000

International authors and editors

135M

Downloads

Our authors are among the

154

Countries delivered to

TOP 1%

most cited scientists

12.2%

Contributors from top 500 universities



WEB OF SCIENCE™

Selection of our books indexed in the Book Citation Index
in Web of Science™ Core Collection (BKCI)

Interested in publishing with us?
Contact book.department@intechopen.com

Numbers displayed above are based on latest data collected.
For more information visit www.intechopen.com



Chapter

Analysis of Outdoor Lighting Control Systems Applied to the New Smart City Models

*Eduardo Ruiz Vela, Blas Ogáyar Fernandez,
Andrés López Valdivia and Hermoso-Orzáez Manuel Jesús*

Abstract

Lighting accounts for more than 19% of the world's electricity consumption. Simply replacing existing lighting systems with other LED technology would reduce energy consumption by up to 40%, and if we also use lighting controls, the figure can reach 80%. The transition to efficient lighting technologies (LEDs) is economically one of the most realistic and simple energy efficiency initiatives. Control systems play an important role in the world of lighting. Wherever you have exterior lighting, there will be a need for control. The systems that have been used so far have precedents that date back more than 35 years and allow control and monitoring functions of groups of light points, i.e. not individually. One of the major drawbacks of these systems is that they do not have flexibility, since they do not allow the individualization of the point of light, and in addition the orders that can emit are of generic character and affect the group, obtaining a rather inaccurate information of the installation. Complete telemanagement systems are currently being developed to meet the needs of different application segments. Experience shows that it is necessary to work with open systems so that the lighting management system works and communicates with other systems such as air treatment, safety systems, etc. Intelligent lighting, in addition to its control and energy management functions, also contributes to reducing the excess of artificial light to which our cities are subject, making them more livable.

Keywords: lighting control, outdoor lighting, smart city, energy efficiency

1. Introduction

Lighting accounts for more than 19% of the world's electricity consumption. Simply replacing existing lighting systems with other LED technology would reduce energy consumption by up to 40%, and if we also use lighting controls, the figure can reach 80%. The transition to efficient lighting technologies (LED) is economically one of the most realistic and simple energy efficiency initiatives. Control systems play an important role in the world of lighting. Wherever you have exterior lighting, there will be a need for control [1].

The management of a lighting installation has two functions: control and surveillance. Control refers to operations related to switching on, switching off and reducing the light level of light sources and always refers to external factors,

such as natural light, traffic density or traffic speed. As far as the monitoring of the installation is concerned, it will basically be related to the knowledge of the state of the light source, i.e. whether it is on or off, whether it is at the maximum or reduced level and whether it has any malfunction. By extending this surveillance to the rest of the installation, consideration is also given to the status of the network, whether a control centre has been accidentally or voluntarily opened, knowledge of the number of operating hours of each and every one of the installation components, electrical parameters, etc. When this management is carried out with a centralization in a certain point and from this point these functions are carried out, by transmission of data and remote orders, the system is called telemanagement [2].

The systems that have been used so far have precedents that date back more than 35 years and allow control and monitoring functions of groups of source of light, i.e. not individually. One of the major drawbacks of these systems is that they do not have flexibility, since they do not allow the individualization of the point of light, and in addition the orders that can emit are of generic character and affect the group, obtaining a rather inaccurate information of the installation.

Complete telemanagement systems are currently being developed to meet the needs of different application segments. Experience shows that it is necessary to work with open systems so that the lighting management system works and communicates with other systems such as air treatment, safety systems, etc. [3].

Integral light management systems (connected) that use communication nodes and optical sensors to detect the movement and regulate the intensity of light can be considered on demand systems that are integrated into a global lighting management platform.

Intelligent lighting, in addition to its control and energy management functions, also contributes to reducing the excess of artificial light to which our cities are subject, making them more livable [4].

2. Methodology

In the last decade, numerous lighting control systems have proliferated in the market. In a first approximation, we can divide these systems into three types: outdoor, indoor and architectural. With the adoption of a lighting control system, we optimize reliability and reduce maintenance costs, allowing us to efficiently manage the lighting system.

The objective of this work is to carry out an analysis and classification of the existing control systems in the market and then to carry out a small comparative study. For this purpose, we will analyze the existing documentation from the point of view of its general functional characteristics, without going into depth into connectivity architectures, which may be the object of other work.

We have excluded outdoor lighting control systems for discharge lamps, since the appearance of LED technology has relegated them to the background, since efficiency and flexibility are condemned to their disappearance.

For the analysis we have considered the different variables that generally define a control system, functionality, connection and driver options, in order to make a classification that helps us to apply them correctly according to the most appropriate needs and environments. For this, in each of the classified systems, we have listed their main characteristics. The energy savings that can be obtained have also been analyzed in general; for this we have based on the case studies provided by the manufacturers.

Finally, we have discussed the different systems classified to conclude on a future projection.

3. Types of outdoor lighting control systems

In the city it is possible to combine different models of lighting control and connectivity that adapt to the idiosyncrasy of each area, all of them controlled from a platform. It is necessary that this is simple, starting with a progressive control of electrical panel parameters and group regulation that can be scalable to the future needs of the city (Figure 1) [5, 6].

3.1 Luminaires

The luminaire is a device that serves as support and connection to the electrical network of the light source. It is necessary to comply with a series of optical, electrical and mechanical characteristics, among others. In terms of optics, the luminaire is responsible for the control and distribution of the light emitted by the light source. The electrical connection between the LED module and the power supply is established via a mechanism called a driver. Stability in the power supply current is necessary to guarantee correct operation of the system, avoiding fluctuations in luminous flux.

Drivers can have each of the following functions or several at a time:

3.1.1 Fixing output current

If the level of light required in a specific solution falls midway between the light packages offered by the standard LED types, it is possible to customize the power level of the LED by setting the output current.

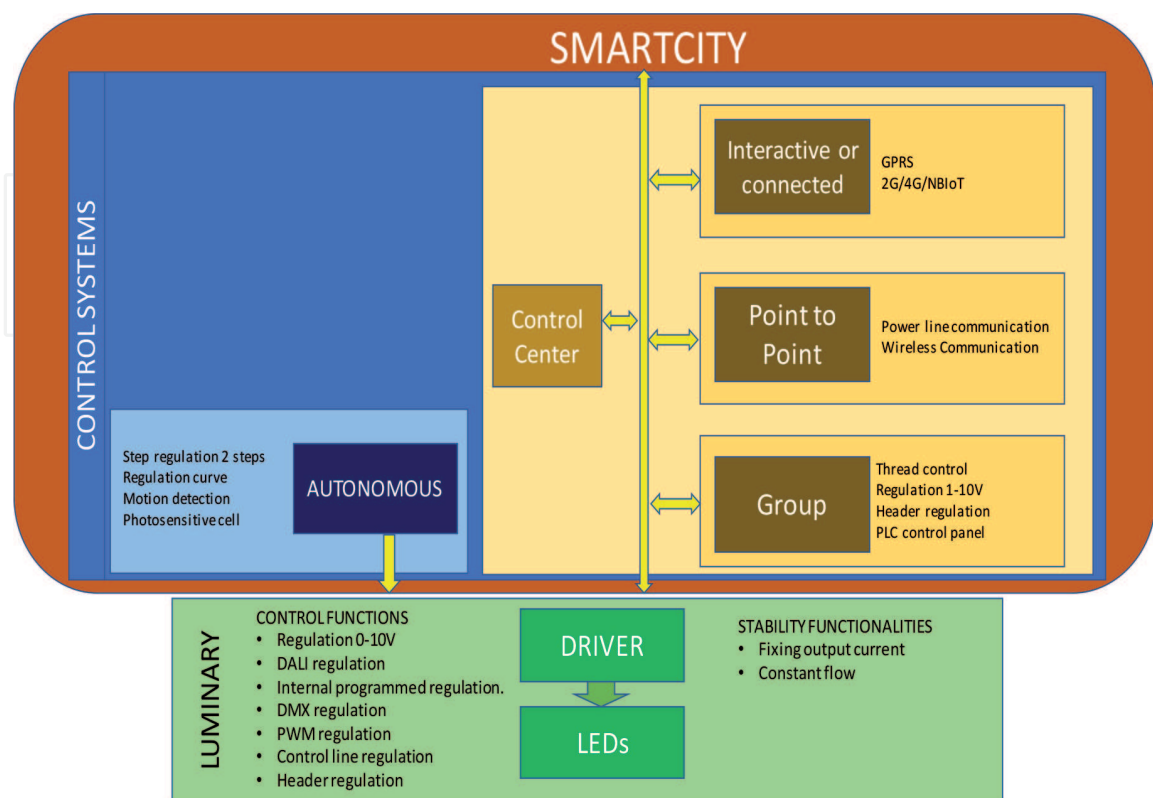

Figure 1.
Types of outdoor lighting control systems.

3.1.2 Regulation 1–10 V

The 1–10 V functionality allows the regulation of the luminous flux around 1% (1 V signal) and 100% (10 V control signal), from an analogue signal that reaches the equipment through a control line, taking into account its polarity. By means of the control line, only regulation can be carried out; switching on and off must be carried out with a relay or switch placed on the supply line of the circuit.

If the level of light required in a specific solution falls midway between the light packages offered by the standard LED types, it is possible to customize the power level of the LED by setting the output current.

3.1.3 Regulation 1–10 V

The 1–10 V functionality allows the regulation of the luminous flux around 1% (1 V signal) and 100% (10 V control signal), from an analogue signal that reaches the equipment through a control line, taking into account its polarity. By means of the control line only regulation can be carried out; switching on and off must be carried out with a relay or switch placed on the supply line of the circuit.

3.1.4 DALI regulation

The Digital Addressable Lighting Interface, or DALI, is a very popular protocol in the lighting industry [7]. Voltages on DALI cables are usually 16 V without polarity. DALI cables can run close to power cables, and the maximum current is limited to 250 mA. Using this protocol we can send regulation orders for 256 power levels. The advantage of this technology is the bidirectionality of the system (**Figure 2**).

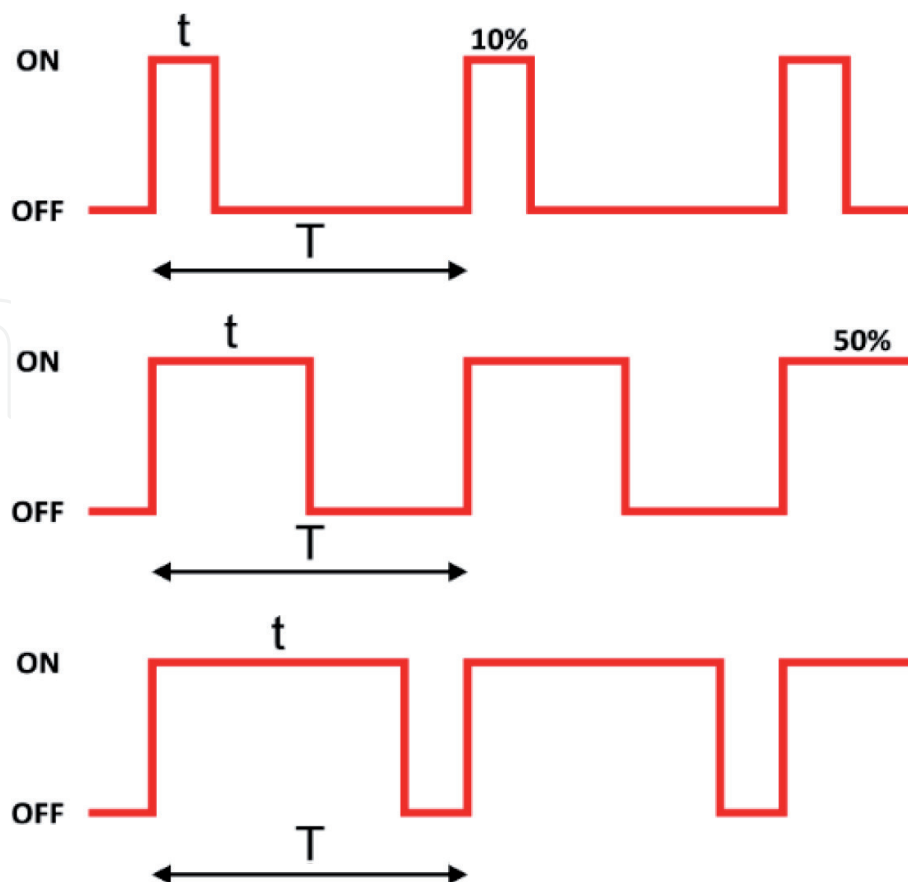

Figure 2.
PWM regulation.

3.1.5 Pulse width modulation

The concept of pulse width modulation of analogue or digital signals known as PWM is a technique used for various applications, and among these is lighting. Basically what it does is to vary the working cycle of the LED by turning it on and off very quickly. If the brightness of the LED is analyzed, it depends on the power, whose value in turn is dependent on the voltage and the current applied to it ($P = V.I$). If we want to reduce the brightness, we will have to reduce the average power delivered to the LED; for it we have to control some of the variables involved (voltage or current).

3.1.6 Control line regulation

This functionality supports signals from a control wire.

3.1.7 Header regulation

This function detects the decrease of the mains voltage.

3.1.8 Constant luminous flux

Light sources experience light depreciation, i.e. a decrease in luminous flux over time. In order to ensure the minimum levels required when the end of the light source cycle is approaching, most designs are calculated based on the level produced at the end of life normally LB70: 70% of the initial lumens. This means that the system consumes more than necessary and loses 15% of energy during its service life. The constant luminous flux functionality compensates for this light loss and ensures that the required level is always delivered. Taking into account light depreciation, the driver can be programmed to start at an attenuated level in a new luminaire and gradually increase the power over the life of the light source. With this function we save energy and extend the life of the system (**Figure 3**).

3.1.9 Internal programmed regulation

This functionality allows simple, preprogrammed attenuation. Programmable drivers offer an integrated version of this feature. This integrated programmer

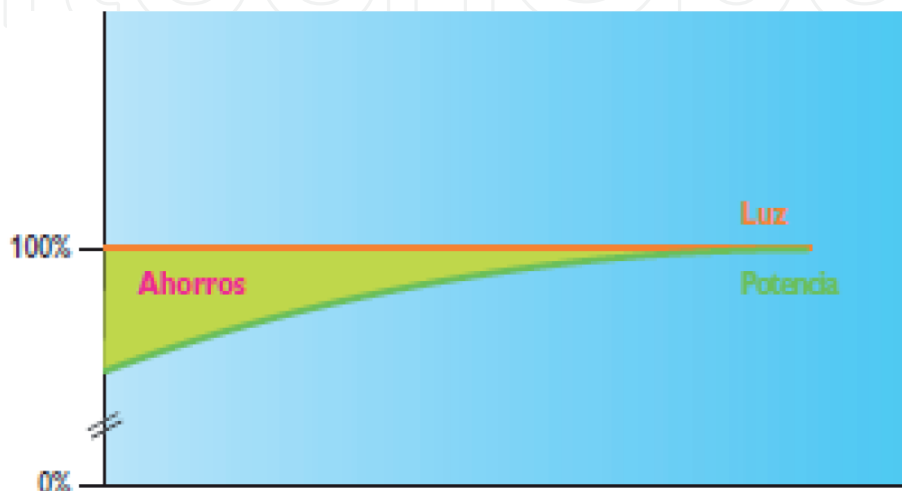

Figure 3.
Energy saving with constant luminous flux.

allows you to regulate predefined light levels based on nighttime operating time and lighting levels.

3.1.10 DMX regulation

The high-speed DMX control protocol makes this the ideal solution for dynamic installations of spectacular lighting, including video playback [6, 8–10].

3.2 Autonomous control systems

Autonomous systems are closely related to the functionalities of the drivers described above. These devices operate independently from the luminaire itself and are normally integrated at or near the same light point. Both operation and configuration are usually simple and generally require no maintenance except for battery-powered devices. Some use presence detection or sensors, so the user can interact. They are very easy to install and have no recurring costs, and energy savings are guaranteed.

3.2.1 Double-level control

It is an autonomous dimming solution that automatically reduces the power of the light source from 100% to 50–60%, according to the predefined model, providing energy savings without extra investment in the control infrastructure.

After synchronizing the hours of off and on of the installation, the functionality of the driver determines automatically the central point of the night. The first option will provide full light up to the central point of the night and then be adjusted 6 or 8 hours before setting the 100% level (**Figure 4**).

3.2.2 Internal programmed regulation by regulation curve

It is a functionality that the equipment has integrated to control the lighting in an autonomous way. They use regulation curves that represent the level of light output depending on the time of day.

The control levels are programmed with a PC via a computer tool. If the lighting requirements change over time or if the established regulation is to be improved, they can be updated (**Figure 5**).

The controller does not have a real clock; instead, it runs a virtual clock, determined by the duration of the night operating hours.

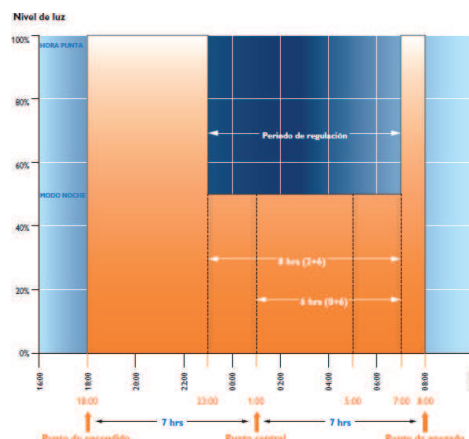

Figure 4.
Double-level control.

3.2.3 Autonomous control system with motion detection

This system is based on the level of activity in the street and not on timetables. It detects and communicates with neighboring luminaires, anticipating pedestrian movements. Generally, the detector can control several drivers with 1–10 V or DALI functionality. It is a unique solution providing light on demand that can be adapted to the needs of each application (**Figure 6**).

Since it detects pedestrians, cyclists or cars at a speed of less than 30 km per hour, it is.

3.3 Networked control systems

Grid control systems interconnect several pieces of equipment within the same public lighting control panel.

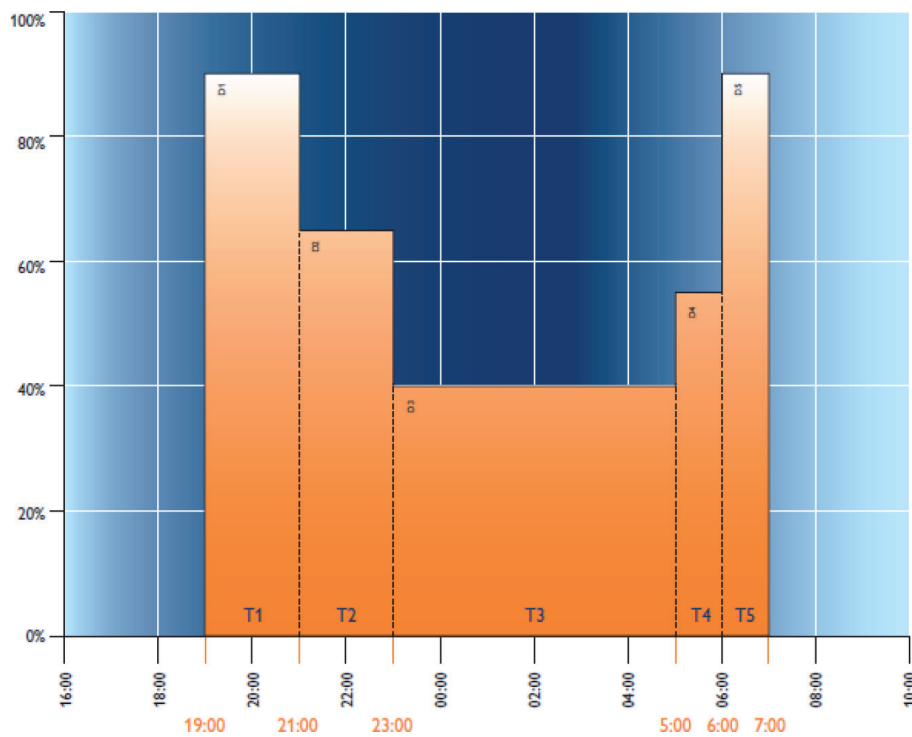

Figure 5.
Dimming curve.



Figure 6.
Dimming by motion detection.

3.3.1 Group control system

Group management systems allow centralized control of a group of light points. This type of system requires additional wiring for the transmission of the control signal, and it is also possible to transmit data over the power line [11, 12].

3.3.1.1 Command thread

The control wire system is a step control solution that allows groups of light points to be controlled up to a predetermined level via an additional control circuit. A cabinet controller feeds the driver through the control line and changes the light level of all luminaires connected to that cabinet [13].

3.3.1.2 Regulation by means of 1–10 V

LED drivers can incorporate 1–10 V regulation. They provide continuous dimming, can reduce luminous flux 100–10% and save a substantial amount of energy during off-peak hours. This system is unidirectional since the information flows in a single direction: from the controller to the lighting equipment. On the other hand, it does not allow the equipment to be routed, and the creation of wired groups has to be carried out.

3.3.1.3 Header regulation

Mains regulation with electromagnetic ballasts has been used for more than 15 years. By lowering the mains voltage, the luminous flux is reduced proportionally. The same advantage is available on LED drivers thanks to their integrated functionality. A cabinet controller sends a signal to the driver to attenuate the luminous flux by reducing the amplitude of the mains voltage. The driver interprets the lower amplitude as a signal to reduce light levels (**Figure 7**).

3.3.1.4 Table regulation by the feeding line (PLC)

The main system controller (CPU), placed on the control panel, monitors and controls all other modules. With this system, the luminaires can be adjusted from the control panel. The communication between the control panel hardware and the luminaire groups is carried out through a specific communication protocol that

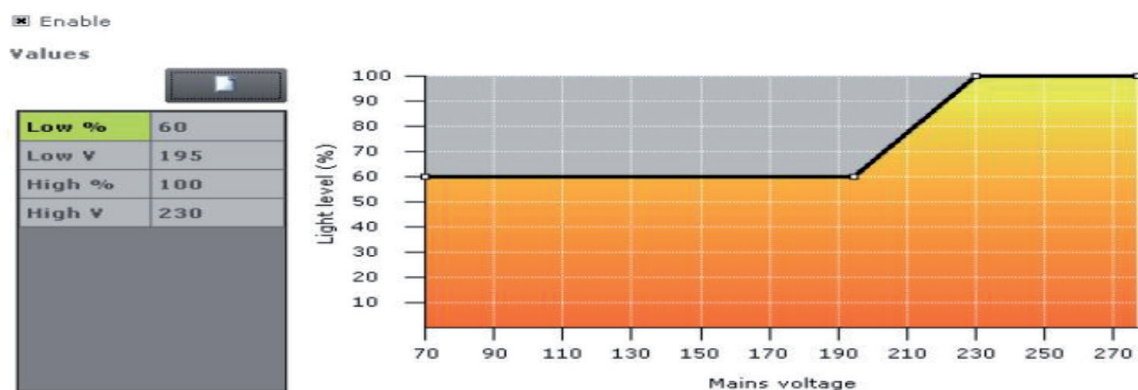

Figure 7.
Headland adjustment.

makes use of the electrical network as a means of transmission. The luminaires have a special driver that includes a receiver to perform the corresponding encoding of the orders received. We use the existing infrastructure. If there were problems in the regulation, we would obtain a system alarm. The CPU also serves as a communication node and as a data hub module. Bidirectional communication with the central server is done through GPRS connectivity.

The main system controller (CPU) monitors and controls all other hardware modules. With this system, the luminaires can be dimmed from the control panel. The communication between the control centre hardware and the luminaire groups is carried out through a specific communications protocol that uses the electrical network as a means of transmission. The luminaires have a special driver that includes a receiver to carry out the corresponding regulation. If there were problems with the regulation, we'd get a system alarm (**Figure 8**).

The data collected by the system is sent to the central server, where they are stored and remain accessible to prepare reports, correct anomalies, perform load balancing and generate emergency responses in case of accident, flood and the like.

The data collected by the system is sent to the central server. Where they are stored and remain accessible to prepare reports, correct anomalies, balance loads and generate emergency responses in the event of an accident, flood or similar.

From the central server, we can make a remote management of the lighting levels of the control panel luminaires and a control of the real state of the light points, with automatic notifications of failures and real energy measurements with complete history that provides instruments of measurement and verification.

This system is associated to a platform that will allow a remote management of the lighting levels of the luminaires of the panel, a control of the real state of the points of light, with automatic notifications of failures and measures of real energy with complete historical that proportions instruments of measurement and verification.

3.3.2 Point-to-point control system

The point-to-point control systems individually control and supervise the light points associated with a lighting control panel, allowing remote diagnosis of each of the light points.

Energy savings are obtained by switching and regulating individual points according to a time model or in response to information received from an atmospheric sensor or a traffic meter. In turn, light points can be grouped according to their specific location so that they respond at the same time.

Associated to the system is a platform of services; it extracts useful information for the control and monitoring of the lighting that the user will be able to use for the maintenance and the energetic consumption, as well as to improve the lighting service (**Figure 9**) [14].



Figure 8.
Table adjustment per supply line.

3.3.2.1 Point-to-point communication

It is based on a powerline protocol. The system applies advanced repetition technology allowing any point of light to replicate orders whenever required. Thus, it guarantees the arrival of all instructions at their destination even under adverse communication conditions (**Figure 10**).

3.3.2.2 Wireless point-to-point control system

The outdoor luminaire controller (OLC) is located on top of the luminaire housing. The OLC unit communicates with the controller wirelessly and securely over a distance of up to 300 meters (**Figure 11**) [15].

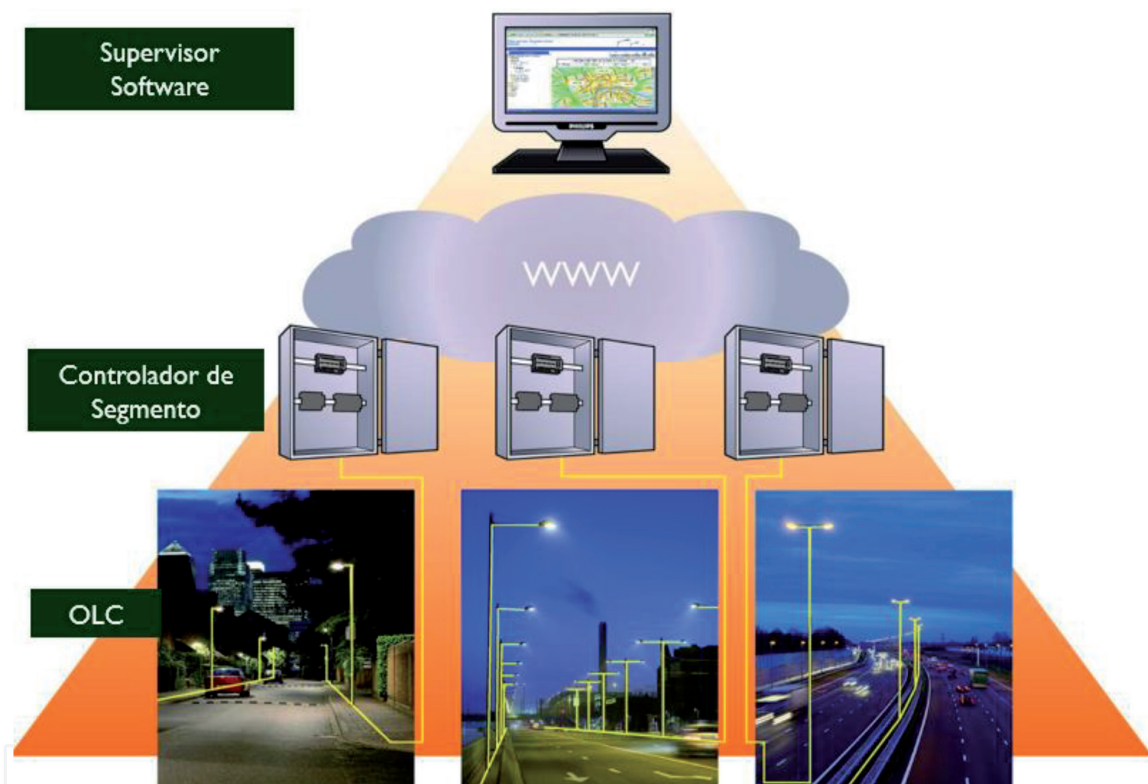

Figure 9.
Point-to-point control system.

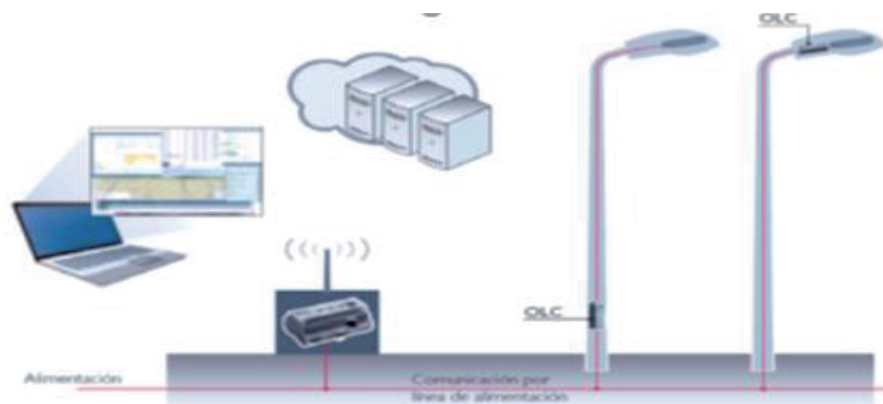

Figure 10.
Point-to-point control system and power line communication.

The segment controller (SC) controls up to 400 OLCs and collects them for storage on the central server over the Internet, usually via GPRS. Installed on a DIN rail in a control centre, the SC can be used as an interface with other devices: traffic counters, atmospheric sensors, etc.

3.4 Lighting switched on

LED luminaires are digital devices that together with the Internet of Things (IoT) create a new concept of public lighting focused on greater efficiency, less environmental and economic impact [16].

The GPRS network is used for communication and control of the luminaires, without the need to install any element in the control centres nor a separate wiring from the power supply of the light points. All luminaires are managed from the GPRS network of a mobile operator (**Figure 12**).

The only control device of the system is the OLC installed in each of the luminaires to allow communication with the platform's servers. The luminaires also incorporate an adjustable driver. These will be connected to the electrical network in the same way as in a conventional installation. To access the system, you need a PC with an Internet connection.

The platform associated to this system has the following characteristics:

- It is a cloud with easy access from a standard browser.
- No software installation required.
- It includes storage, processing and backup of application data.



Figure 11.
Wireless point-to-point control system.



Figure 12.
Connected.

- It is secure and scalable to be able to implement modules according to the needs of each territory or intelligent city.

It is safe and scalable to be able to implement modules according to each territory or smart city needs.

4. Comparison of control system

The autonomous systems reduce the consumption of electrical energy, with respect to the traditional lighting, 15–20%, those of network in box 15–35%, those of network point to point 45–50% and those connected 50–60%. The autonomous motion detection can reach up to 70%, since when there is no occupation that tends to reduce the flow of the light source to 10% normally (**Table 1**).

These systems control the flow of LED modules in different ways. Within the self-employed, the double-level regulation has two states: normal and reduced operation. The internally controlled programming is governed by a curve that can be modified with a specific software and usually has several steps. The ones with control wires, regulation in headboard and 1–10 V do it presenting some determined values in the driver. The control panel regulated through the power supply line of the luminaires modifies the curve in the corresponding drivers of the luminaires of the control centre; previously this curve is configured from the associated platform and is transmitted through the power line. Point-to-point systems work like the above only that they can vary the dimming curve of a luminaire, without having to do it simultaneously in all the luminaires in the table. The connected system can change the regulation parameters of

	Control system	Functionality	Driver Options	Characteristics
I o T	Connected	For complete control and monitoring of each individual light point	DALI	*Automatic start-up *Energy measures *Automatic luminaire location *Automatic data loading *Detection and notification of faults. *Adjustment of lighting levels. *Energy savings of 50-60%.
R E D	Point to point	For complete control and monitoring of each individual light point	DALI	*Needs start up *Continuous regulation *Provides detailed information about the equipment * Location of luminaires *Average energy savings of 45-50%.
			1-10 V	
	Chart	For monitoring and controlling groups of light points	PLC (codificador)	*Needs start up *Geographical location of table. *Table Level Adjustments *Measurement of panel energy parameters *Driver with decoder or out of it *Average Energy Savings 30-35%
			1-10 V	*Continuous regulation. *Energy savings of 15-20%.
			Regulation in Header	*Simple regulation by reducing the mains voltage. *Average energy savings of 15-20%.
			Control wire	*Adjustment by means of an additional control line *Average energy savings of 15-20%.
A U T O N O M O U S	Autonomous	Regulation	Motion detection	*Adjustment by means of a motion detector *Average energy savings of up to 70%.
			Internal programmed regulation	*Automatic regulation programmable several steps *Average energy savings of 20-25%
			Double level regulation	*Automatic regulation 1 step *Average energy savings of 15-20%

Table 1.
Summary outdoor lighting control system.

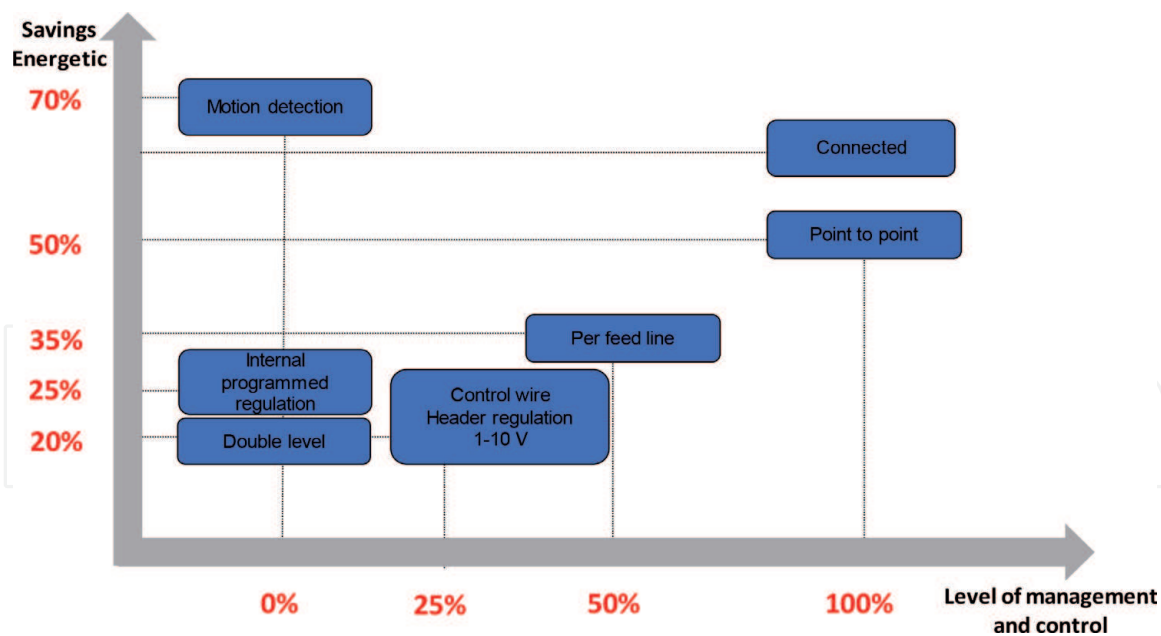

Figure 13.
 Energy saving depending on the level of management.

an individual light source, directly from the platform, without having to pass the signal through any element placed in the panel or from any sensor connected to the communication node of the luminaire (OLC): presence detector, traffic density, etc. [17, 18].

Implementation is the process of programming and field verification of system elements. In the autonomous it is not necessary, as in the network of control wire, 1–10 V and regulation in head; however, it must be carried out in the network: PLC and point to point. The plug-in is a plug and play and does not require commissioning.

In all the analyzed systems, it is necessary to place, in the control panel of the public lighting, the necessary controllers in order to control the sources of light; in the autonomous and connected, it is not necessary.

The PLC box system, the point-to-point network system and the connected system are associated to a platform that acts as an interface with the user. This may be related to others at a higher level.

The monitoring of light source status, network status, operating hours, energy consumption, faults, etc. is carried out by the PLC network system, the point-to-point network system and the connected system.

The connectors used in the connected system allow power and control to be independent without special operations, integrating communication nodes, sensors, photocells, etc.

As we can see in **Figure 13**, as we increase the supervision, we increase the potential energy saving, and the exception is the autonomous with motion detection for the reasons above [19, 20].

5. Discussion

The implementation of the appropriate control system depends on several factors: investment, management and energy saving.

Autonomous control systems are the best option for complying with existing legislation and starting to reduce energy consumption immediately, without the need for major changes or investments in infrastructure. They operate independently the rest of the installation and control or regulate the light according to specific sensors or programs.

The networked group management systems allow a centralized control of a group of light points, so they are aimed at finding a more advanced solution. This type of system requires additional wiring for the transmission of the control signal or the luminaires' own power supply. However, if you already have the necessary infrastructure, these solutions are very easy to install offering immediate monitoring and control over groups of light points.

Point-to-point network control systems not only control and monitor the lighting but also remotely diagnose each of the light points. These solutions achieve greater volume savings while providing maximum flexibility.

Connected or integrated light management systems are the easiest to install and can be integrated with different networked control systems. In this way, it is not only possible to control and supervise the lighting but also to remotely diagnose each of the points of light. This is possible thanks to sensors, control nodes, gateways, communications, etc. These solutions achieve the greatest volume of energy savings while providing maximum flexibility.

It is possible to combine different control systems that adapt to each area of the city, all controlled from a single platform. From there, it was possible to carry out the transformation of the city. This platform, which operates vertically and autonomously, can be integrated with the horizontal platform of the city and integrated with other services, forming part of the connected city. This concept has a high potential, with the exploitation and correlation of collected data that open the possibility of using advanced analytical methods and big data treatments, which help to make strategic decisions.

6. Conclusion

The adoption of LED technology enhances the renewal of lighting infrastructure, enabling the growth of innovations in cities and technology based on a safe lighting system, reliable and connected with a wide range of products and associated services.

New intelligent digital technology plays a key role in responding to the demands of cities and citizens. Improved lighting infrastructure supports connectivity and reduces maintenance operating costs in an environmentally sustainable manner. Intelligence is the logical step to make tomorrow's city more efficient, save more energy, adapt to new situations and be always prepared for the future, equipped with systems that can be controlled and monitored remotely in real time.

Connected lighting is an integral solution that allows municipal authorities to offer a better lighting service. Other systems or platforms can be connected through APIs to the lighting platform (vertical). It is essential to integrate all the information generated by the services, in this case lighting, in an open, standard and interoperable horizontal platform, which is, as a technological element, responsible for a unified management.

IntechOpen

Author details

Eduardo Ruiz Vela¹, Blas Ogáyar Fernandez^{2*}, Andrés López Valdivia²
and Hermoso-Orzáez Manuel Jesús³

¹ Departamento de Ingeniería Eléctrica, Escuela Politécnica Superior de la
Universidad de Córdoba, Spain

² Departamento de Ingeniería Eléctrica, Escuela Politécnica Superior de la
Universidad de Jaén, Spain

³ Departamento de Ingeniería Gráfica Diseño y Proyectos, Escuela Politécnica
Superior de la Universidad de Jaén, Spain

*Address all correspondence to: bogayar@ujaen.es

IntechOpen

© 2020 The Author(s). Licensee IntechOpen. Distributed under the terms of the Creative Commons Attribution - NonCommercial 4.0 License (<https://creativecommons.org/licenses/by-nc/4.0/>), which permits use, distribution and reproduction for non-commercial purposes, provided the original is properly cited. 

References

- [1] Brock K, Den Oden E, Van Der Klaus K, Podoyntsyna K, Langerak F. Technological forecasting & social change light the way for smart cities: Lessons from Philips lighting. *Technological Forecasting and Social Change*. 2019;**142**(2028):194-209
- [2] Ordendaal N. Information and communication technology and local governance: Understanding the difference between cities in developed and emerging economies. *Computers, Environment and Urban Systems*. 2003;585-607
- [3] Sittoni D, Brunelli D, Macii D, Tosato P, Petri D. Street lighting in smart cities: A simulation tool for the design of systems based on narrowband PLC. In: 2015 IEEE First International Smart Cities Conference (ISC2), Guadalajara. 2015. pp. 1-6
- [4] Karlicek R, Sun CC, Zissis G, Ma R. *Handbook of Advanced Lighting Technology*. 2017. pp. 1-1185
- [5] Lighting P, Dynalite E. *Sistemas de Control de Alumbrado (CTE) Philips Lighting Controls*. 2015
- [6] Alumbrado PL. *Sistemas de control Dynatile. Manual técnico*. 2016
- [7] Domingo-Pérez F, Gil-De-Castro A, Flores-Arias JM, Bellido-Outeiriño FJ, Moreno-Muñoz A. Lighting control system based on DALI and wireless sensor networks. In: 2012 IEEE PES Innovative Smart Grid Technologies (ISGT). 2012. pp. 1-6
- [8] Hung NM, Lee C-H. Design of Bi-directional RDM-DMX512 converter for LED lighting control. *International Journal of Fuzzy Logic and Intelligent Systems*. 2013;**13**(2):106-115
- [9] Yoowattana S, Nantajiwakornchai C, Sangworasil M. A design of embedded DMX512 controller using FPGA and XILKernel. In: 2009 IEEE Symposium on Industrial Electronics and Applications, ISIEA 2009. Vol. 1. 2009. pp. 73-77
- [10] Yang H, Ahmad AW, Shahzad G, Lee C. Real time bidirectional wireless digital multiplexer (WiDMX512). In: *International Conference on Advanced Communication Technology (ICACT)*. Vol. 2015. 2015. pp. 109-114
- [11] Varghese SG, Kurian CP, George VI. A study of communication protocols and wireless networking systems for lighting control application. In: *International Conference on Renewable Energy Research and Applications (ICRERA) 2015*. Vol. 5. 2015. pp. 1301-1306
- [12] Piromalis D, Arvanitis KG, Papageorgas PG, Tseles DI, Psomopoulos CS. Sensors & transducers LEDWIRE: A versatile networking platform for smart LED lighting applications using LIN-bus and WSNs. *Sensors & Transducers*. 2016;**200**(5):50-59
- [13] F.R. Trejo-macotela and A. Garcia-barrientos. *Controlador Digital Mediante el Protocolo DMX-512*. 2013
- [14] Color and K. Led. *Remotely Monitor and Manage Dynamic Cloud-Hosted Connected Lighting Software*. 2013
- [15] Newton S. Art-net and wireless routers. In: 2005 Asia-Pacific Conference on Communications. Vol. 2005. 2005. pp. 857-861
- [16] Carrino F, Mugellini E, Khaled OA, Ouerhani N, Ehrensberger J. *iNUIIT: Internet of things for urban innovation. Future Internet*. 2016;**8**(2):1-21
- [17] Hu W. *Effects of Resolution of Lighting Control Systems*. 2018

[18] Zotos N et al. Case study of a dimmable outdoor lighting system with intelligent management and remote control. In: 2012 International Conference on Telecommunications and Multimedia (TEMU). Vol. 1. 2012. pp. 43-48

[19] Hermoso-Orzáez MJ, Gago-Calderón A, Rojas-Sola JI. Power quality and energy efficiency in the pre-evaluation of an outdoor lighting renewal with light-emitting diode technology: Experimental study and amortization analysis. *Energies*. 2017;**10**(7)

[20] Radulovic D, Skok S, Kirincic V. Energy efficiency public lighting management in the cities. *Energy*. 2011;**36**(4):1908-1915

IntechOpen