

We are IntechOpen, the world's leading publisher of Open Access books Built by scientists, for scientists

4,800

Open access books available

122,000

International authors and editors

135M

Downloads

Our authors are among the

154

Countries delivered to

TOP 1%

most cited scientists

12.2%

Contributors from top 500 universities



WEB OF SCIENCE™

Selection of our books indexed in the Book Citation Index
in Web of Science™ Core Collection (BKCI)

Interested in publishing with us?
Contact book.department@intechopen.com

Numbers displayed above are based on latest data collected.
For more information visit www.intechopen.com



CO₂-EOR/Sequestration: Current Trends and Future Horizons

Erfan Mohammadian, Badrul Mohamed Jan, Amin Azdarpour, Hossein Hamidi, Nur Hidayati Binti Othman, Aqilah Dollah, Siti Nurliyana Binti Che Mohamed Hussein and Rozana Azrina Binti Sazali

Abstract

The use of carbon dioxide (CO₂) as an improved oil recovery (IOR) method has been a common practice in petroleum engineering. In this chapter, various technical aspects of application of CO₂ to increase oil recovery are discussed. From the required laboratory tests prior to field applications to postinjection monitoring of injected plume, the required onshore and offshore facilities, the environmental considerations, and challenges concerning the application of CO₂ for EOR purposes have been covered in this chapter. Moreover, the emerging methods and industry trends in applications of CO₂ for EOR will be discussed. The second part of this chapter is dedicated to CO₂ sequestration as a method to mitigate CO₂ emitted due to the anthropogenic activities. CO₂ sequestration is the injection of large quantities of CO₂ into underground reservoirs (oil and gas, aquifers, and coal deposits) where it can be securely and permanently stored.

Keywords: improved oil recovery, enhanced oil recovery, CO₂ sequestration, CO₂-EOR, CO₂ miscibility

1. Introduction

Current dilemma faced by the United States in lowering the dependency on foreign energy source and curbing emissions of greenhouse gases has brought light to carbon dioxide (CO₂)-enhanced oil recovery (EOR) method [1]. Oil recoveries using natural (primary) mechanisms rarely exceed 20% of the original oil-in-place (OOIP) [2]. Secondary methods of recovery often add few percentages to the above figure [2]. Hence, companies would welcome any methods that could lead to an increase in the production of the postwater/gas injection trapped oil in the reservoir. Injecting CO₂ into oil reservoirs to improve the recovery of oil on commercial (field) scales has been practiced since nearly half a century ago. The idea of CO₂ flooding first emerged in 1930s, and more laboratory and field studies were conducted between 1950s and 1970s. Most of these implementations have been in North America. However, some small-to-large scale CO₂ injection projects have been reported in other parts of the world [3, 4].

In this method, CO₂ is usually injected as a supercritical fluid. When injected at or above the critical point of pressure and temperature, supercritical CO₂ can

maintain the properties of a gas while having the density of a liquid. In this state, oil could be more efficiently mobilized from the depleted reservoir due to the improved volumetric efficiency. Conventionally, CO₂ injection method is usually applied to the reservoirs with oil gravity less than 25 [5]. As CO₂ is injected into the reservoir, the miscible CO₂ will blend thoroughly with the oil in a manner that the interfacial tension between these two fluids becomes zero. The other mechanisms of CO₂ by which the oil recovery is improved are the dissolution of CO₂ in oil, swelling of oil, and eventually reduction of the viscosity of oil.

Since 2002, as a consequence of Kyoto protocol and imposing of the carbon tax, CO₂ sequestration as a method to mitigate the high concentration of CO₂ in the atmosphere has received a lot of attention [6, 7]. However, the lack of economic incentives has been the biggest hindrance to industrial field-scale application of CO₂ sequestration. Emerging in the last decade, CO₂-EOR was proposed as a method to add economic benefits of CO₂ injection to mature oil fields to the environmental merits of CO₂ sequestration [6]. Therefore, considering the large amounts of research dedicated to CO₂-EOR, it is expected that in the near future, more field applications of this technology will be implemented globally. In this chapter, the phase behavior and hydrocarbon miscibility of CO₂ is discussed in detail.

2. Hydrocarbon miscibility

With decline in overall production levels from mature oil fields, oil companies have turned to enhanced oil recovery (EOR) techniques as a way of maximizing output. The more commonly applied technique is gas injection or miscible flooding. Miscible flooding is a commonly used term used to describe gas injection processes. This involves the displacement of oil that aids in maintaining original reservoir pressures by reducing the interfacial tension that exists between the oil and gas phases. This acts by removing the interphase between the two fluid phases, and commonly used gases include CO₂, natural gas, and nitrogen, with CO₂ being the most prominently used gas. Research on the use of CO₂ has been ongoing since the 1950s, continuing into the 1960s [8–10]. And the advantage that CO₂ injection brought about was noticed as the increase in reservoir pressure that resulted in higher oil production due to the driving force provided by it. In its infancy, research on CO₂ showed it to be immiscible with oil at reservoir pressures, but it was later discovered that under certain conditions of temperature, pressure, and oil composition, the carbon dioxide becomes enriched and becomes miscible with oil [11]. The pressure required for CO₂ gas to attain miscibility in oil is also much lower than methane gas. The term “miscible flooding” has been adopted as the conventional phrase used to describe the process of gas injection.

The main advantages of using CO₂ in this process include the following:

- The miscibility of CO₂ with oil as highlighted earlier.
- It is a cheaper source of gas than other alternatives.
- By injecting it back, CO₂ capture is also achieved.

From review of various literatures, an indication of the suitability of CO₂ as an excellent solvent for EOR in onshore fields of Canada and the USA can be deduced. And from experience garnered worldwide by operators, CO₂ flooding increases oil extraction by between 7 and 15% of oil initially in place. And also, it reduces the amount of CO₂ in the atmosphere and greenhouse gases in general [12].

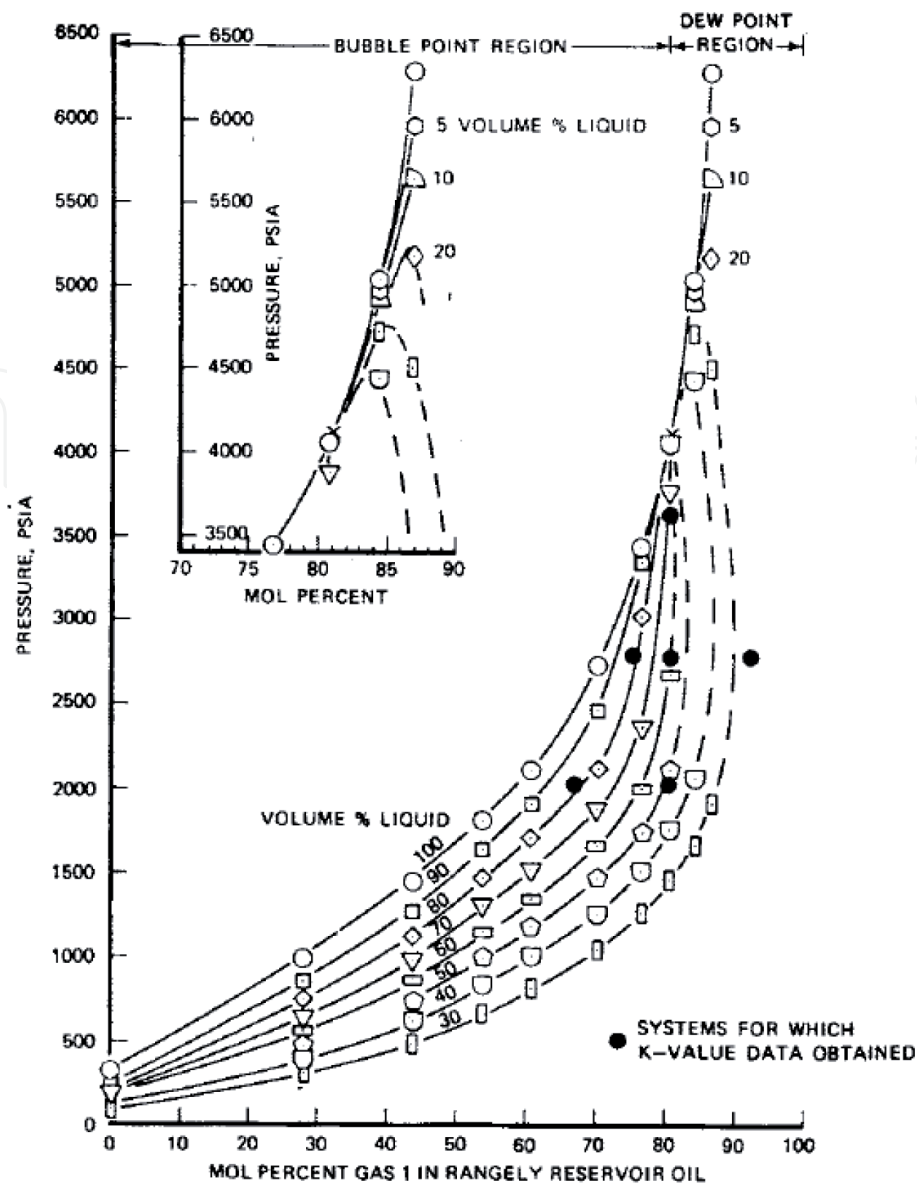

Figure 1.
 Pressure composition diagram—gas 1 system for Rangely oil: 95% CO₂ and 5% CH₄ gas at 160°F [13].

Challenges associated with CO₂-driven EOR include technological, economical, and supply. For example, a long pipe network is usually required to transmit CO₂ from source to the field. High-pressure compressors are also another essential requirement in the injection process. Therefore, all these factors have to be assessed and weighed in relation to the extra oil recovered to determine if it is profitable.

In recent times, newer techniques such as water alternating CO₂ injection and simultaneous water and CO₂ injection have been developed, and they are determined to increase efficiency of oil recovery at lower costs.

A recent study commissioned by the Congressional Research Service shows that, theoretically, carbon-capture technology could remove as much as 80–90% of CO₂ from emissions.

The minimum miscibility pressure (MMP) of CO₂ and NGL for conventional reservoirs are few hundreds psia higher compared to unconventional reservoir due to difference in pore size according to a study by Teklu et al. [13].

2.1 MMP in nanopores, fluid properties, and phase behavior

The deviation between the nanopore phase behavior from bulk (PVT cell) properties was studied [14–16]. The bubble point and dew point pressure, interfacial

tension (IFT), and minimum miscibility pressure (MMP) between injection and reservoir fluid change in nanopores due to small pore confinement effect [13]. MMP was calculated by including capillary pressure and critical property shifts in confined pores using multiple mixing cell (MMC) algorithm of Ahmadi and Johns [17].

Phase behavior is important in the design of a variety of EOR processes, for example, surfactant/polymer processes and gas injection processes. The process of reducing interfaces between oil and displacing phase and hence removing effect of capillary forces between injected fluid and the oil is called miscible displacement. During the gas injection process, the required miscible-displacing fluid is generated by mixing the injected fluid with oil in the reservoir. Phase behavior of gas/oil systems is summarized in the pressure-composition (p-x) diagram. A work by Graue and Zana [18] summarizes the result for CO₂ injection in the Rangely field, Colorado. The physical property data was obtained from constant composition expansion (CCE) to determine the phase envelope (bubble point and dew point envelope) and vapor/liquid equilibrium experiment (VLE) to yield vapor/liquid equilibrium constant (K-values). The phase behavior of Rangely reservoir oil with different gases' composition at reservoir temperature of 160°F showed that critical and saturation pressures of the injected gas/reservoir oil system were increased substantially by 10 mol% N₂ in the injected gas. The phase behavior data showed solid phase precipitation that amount for 2–5% of the reservoir oil [18]. **Figure 1** illustrates the pressure composition diagram of Rangely oil containing considerable amounts of CO₂.

3. CO₂ miscible injection method

The oil displacement process is classified into two types depending on the method on which miscibility is achieved. These are classified as first-contact miscible (FCM) and multiple-contact miscible (MCM). In the FCM process, a small quantity of a primary slug that is miscible with the oil is initially injected; afterwards, a larger quantity of a less expensive slug is injected. The size of the slugs injected is determined by the costs. Under ideal conditions, the two injected slugs should be miscible; thus, at both the leading and trailing edges of the primary slug, the phase behavior has to be monitored. In the case of these slugs being immiscible, a residual saturation of the primary material will be trapped in the displacement process. While during the MCM displacement process, miscibility in the reservoir is generated through in-situ composition changes due to multiple-contacts and mass transfer between the injecting fluid and oil present. These MCM processes are classified as displacements using vaporizing gas (lean gas), condensing and condensing/vaporizing gas (enriched gas), and CO₂.

3.1 Vaporizing gas drive mechanism

A relatively lean gas is gas containing a little low molecular weight hydrocarbon (or inert gases like nitrogen) and methane making up the rest of the composition. The schematic of the CO₂ (**Figure 2**) miscible process shows the transition zone between the injection and production well [19].

After injection, its composition gets changed as it moves through the reservoir in the process becoming miscible with the original reservoir oil. This means that through multiple-contact the composition of the injected fluid is enriched, and intermediate components are vaporized into the injected gas. And at some point under the appropriate conditions, the enrichment reaches a level where the injected gas becomes miscible with oil in the reservoir. It is from this stage of the process, under ideal conditions, that displacement is said to occur [20–22].

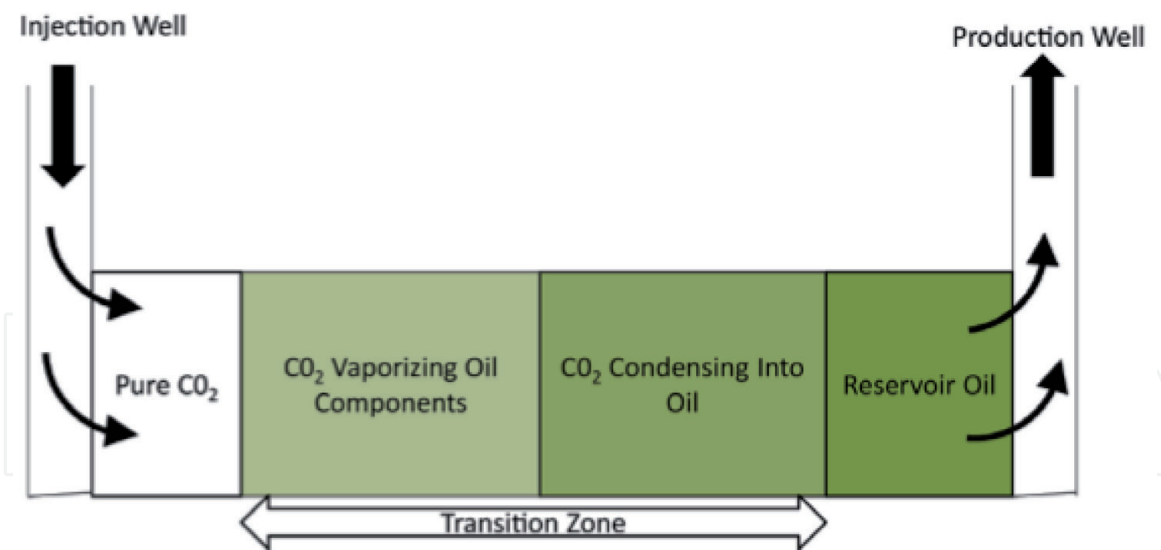

Figure 2.
Mechanisms of CO₂ injection for EOR [19].

When using a condensing or enriched gas as the injecting fluid, the process is more expensive because the fluid tends to contain a high concentration of intermediate-molecular-weight hydrocarbons. This process entails enrichment of the reservoir oil that first comes in contact with the injection fluid. Thereafter, hydrocarbon components from the fluid are condensed into the oil, giving it the name condensing process. Under ideal conditions, this oil is sufficiently changed in composition such that it becomes miscible with increased fluid injection and miscible displacement thus occurs. This process can be operated at a lower pressure than the vaporizing process [23–26].

It has been a long held notion that the enriched-gas process is operated mechanically, as highlighted in the previous paragraph. However, it has now been discovered that it is more often a combination of condensing and vaporizing mechanisms. The lighter components of the injected gas (C₂ through C₄) tend to condense into the reservoir oil as previously highlighted. While the middle intermediate components (C₄+) become vaporized from the oil and absorbed into the gas phase, this prevents the development of miscibility between fresh injected gas and enriched oil at the entry point of the injection process (the oil becomes heavier). Further into the injection process, the light intermediates in the gas condensate into the oil, and this leads to the oil becoming saturated. As for the middle intermediate, vaporization continues due to the slight enrichment of the injected gas. When the condensation/vaporization process proceeds further downstream, the gas becomes more enriched due to contact with the oil. And the enrichment is said to occur at the point where the gas “nearly” becomes miscible with the original reservoir oil, ensuring a more efficient displacement process, even though miscibility is never fully developed (i.e., the two phases are never fully miscible in all proportions) [20, 27–29].

CO₂ is not miscible with most crude oils at first contact under normal reservoir conditions. However, at some ideal conditions of temperature, pressure, and composition, miscibility is expected to occur through multiple contacts. Overall, the process behavior is analogous to the vaporizing process. Under some conditions, the phase behavior can be more complex, having two liquid phases, or two liquid phases in addition to a vapor phase.

3.2 CO₂-EOR injection consideration

There are two main groups of considerations for CO₂-EOR, namely technical and economical (fiscal) considerations. CO₂-EOR injection technical consideration

involves a complex engineering and differs from reservoir to reservoir. A detailed description of reservoir field and prospect of miscibility must be taken into account before considering CO₂-EOR injection. Usually, the key parameters used in the technical consideration are remaining oil in place, minimum miscibility pressure, reservoir depth, oil API gravity, and formation dip angle.

In offshore fields, there are more factors that need to be considered. Firstly, the separation of CO₂ from the produced gas is the ideal choice if the CO₂ source is not in the vicinity of the field. Next, at high CO₂ concentrations, there is a need for the facilities and operation to process the gas [21]. This is because CO₂ becomes acidic as it is injected into the (formation) water and causes corrosion of the equipment in the offshore environment. If the fields are using CO₂-WAG processes, then the facilities need to be compatible with acid that could be generated so that the corrosion in the facilities could be prevented [20–22].

Verma et al. [29] studied the parameters that affect the efficiency for increasing the production of methane gas on Marcellus shale and concluded that the gas production can be increased by 7% with the optimal spacing between injection and production well. It can be concluded that the natural fracture permeability is the dominant factor to improve the production of methane. As the fracture half-length increases, the methane production increases and the possibility of CO₂ breakthrough also increases. The down side of this process is the cost as well as a high risk of leakage and the field pollution. This is due to the fact that the injecting of CO₂ can degrade the gas production as a result of the mixing initial gas in place with the injected CO₂ [30]. Due to the miscibility of CO₂ and the natural gas, their physical properties were potentially ideal for reservoir re-pressurization. For instance, CO₂ has higher density and lower mobility ratio compared to methane. Hence, CO₂ will sink in the reservoir; this can stabilize the displacement process between the injected CO₂ and the methane initially in place.

Reservoir heterogeneity and solubility of CO₂ in formation brine could also play a major role in causing early CO₂ breakthrough to the production wells. The latter could be delayed, by re-pressurizing the reservoir [26, 31]. Generally, due to the benefits of CO₂ injection to gas reservoir, CO₂-EGR could be potentially efficient and therefore an attractive option in spite of a bigger investment required as compared to CO₂ injection into oil reservoirs. Nevertheless, it can extract more hydrocarbons as compared to oil reservoirs.

The reservoirs must be subsequently screened for economic consideration based on standardized capital costs and operation expenses that are representative of the reservoirs under consideration. Wei et al. [27] found that the total crude oil recovery potential along with CO₂ storage resource and net income for enterprises can be increased if the price of crude oil is high and the price of CO₂ and tax is low. The cumulative cost-effective oil production varied between 0.3 and 1.3 billion tons (2.1 and 9.1 billion barrels). This is consistent with research reported from Appalachian basin region, which suggests that CO₂-EOR may be economically feasible in the study area when oil prices are \$70/STB or higher [28, 32]. However, the economics of onshore CO₂-EOR will face an undesirable impact due to complex geological properties, high viscosity of crude oil, high royalty rates, technology limitations, and the lack of incentives for CO₂-EOR projects. Overall, a miscible CO₂-EOR process is preferred considering all the technical and economical evaluations as detailed as possible.

4. The CO₂ injection and sequestration facilities

In this chapter, the facilities that are required for CO₂ injection and CO₂ sequestration application both in the offshore and onshore environment are discussed.

4.1 Onshore surface facilities

For CO₂-EOR, the facilities required are almost the same with those that are required in water-flooding process that includes gas phase (CO₂ and natural gases) gathering lines, CO₂ metering, and distribution lines that are also required in the designing of the facilities for the CO₂-EOR operations [33, 44]. However, there are three basic elements that differentiate the two processes. They are as follows:

1. Extraction: CO₂ gas is extracted from the increasingly rich CO₂ separator gas due to its breakthrough in producing wells.
2. Processing: It is the process of purifying of CO₂ down to specification upon extraction from the separator gas and CO₂ undergoing dehydration prior to compression.
3. Compression: CO₂ undergoes compression to raise its pressure for injection.

One of the preliminary considerations for CO₂ EOR facilities is the incorporation of the flue gas CO₂ recovery plants, CO₂ compression/dehydration unit, CO₂ pipelines, CO₂ injection wells, and a facility for separating CO₂ from associated gas as can be seen in **Figure 3**. Macon extensively discussed the details of Levelland Texas, which is one of the earliest projects of CO₂ injection, from aspects of the design and operation of the facilities [33, 34].

4.1.1 CO₂ transport, storage, and refrigeration

CO₂ transport is the first operational aspect to take into consideration in a CO₂ injection project. CO₂ transportation by trucks or rail cars may be deemed inefficient and costly if the supply source is far away from the injection site [34]. Moreover, since CO₂-EOR requires millions and billions of tons of CO₂, such methods of transportation are simply impractical. In the later projects, the CO₂ is transported via pipeline system as a dry gas, separated from any existing water injection system.

The CO₂ will be stored in liquid form at approximately -18°C and ~ 300 psi and this can be achieved by utilizing a refrigeration unit that consists of skid mounted compressors and refrigerant condensers. The refrigeration system when added with heavy insulation will minimize the cost of the product normally lost through relief valves as the liquid warms during prolonged storage. The CO₂ gas is dehydrated as its dew point is lowered to a temperature lower than 0°C and compressed up to its critical pressure before being fed to the reservoirs via a CO₂ pipeline [35, 36].

4.1.2 CO₂ distribution and injection

In most cases, CO₂ is distributed throughout the system and facilities as a dry gas through a trunkline system [33, 35, 37] using bare carbon steel systems as there is no concern for corrosion when the pumping pressure is set at around 1800–2400 psi [37]. However, precautions should be taken by moving the flange valve and tying the valve above ground to avoid leaks and the dry ice formation if loose. Blowdowns consisting of a buried flanged blowdown valve, a blowdown stack, and a line blind are installed (refer **Figures 3** and **4**) to remove excess CO₂ impurities in the pipe.

Special consideration should be taken into account for Christmas tree if water alternating gas (WAG) method is applied. If water and CO₂ are alternately injected, the part of the system will be vulnerable to corrosion as high-pressured CO₂ will come into contact with water and form an acidic solution [36].

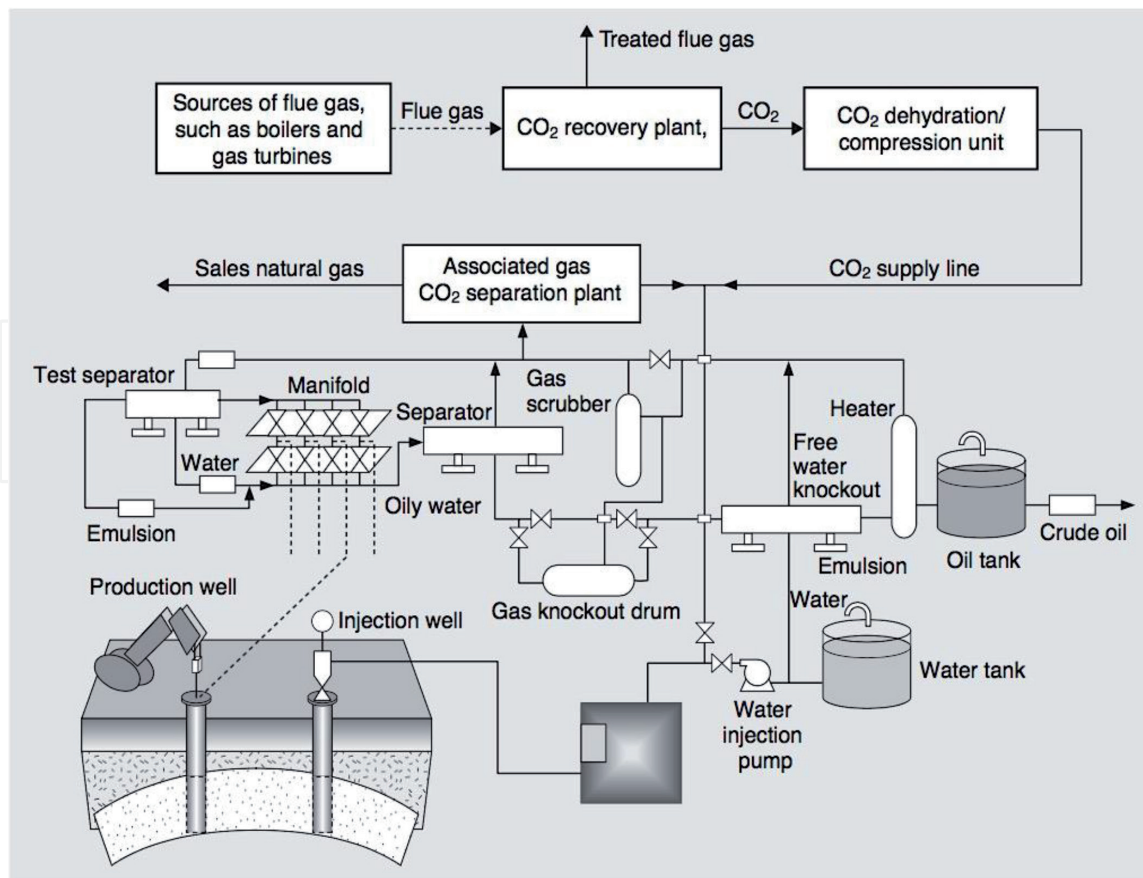

Figure 3.
A typical system utilized in CO₂-EOR [4].

At the CO₂ well head, an additional tee is necessary to be installed, which allows the high-pressure CO₂ stream to be closed off away from the well head, which in turn will increase the safety of workovers and similar operations (refer **Figures 5 and 6**). No modifications are required in terms of artificial lift equipment or the well head equipment during the implementation of the CO₂ project mainly due to economic reasons and uncertainties of design parameters [37].

Injected CO₂ eventually recycles back. The recycled stream may contain H₂S [43]. While this may raise a cause for a higher possibility for stress cracking, unlike most systems, the recycle stream will be sufficiently dehydrated, so the need for protection can be minimized through mill analysis and inspection.

4.1.3 Field production facilities

Modifications to the well head were implemented in the ADCO's Wasson ODC Unit, which include 80 nipples, 2000 psi-rated ball valves on the tubing head, and new elastomers in both the secondary seal and tubing slip seal. For beam pumped wells, the blowout preventer elastomers are also changed. For electrical submersible pumps, the tubing valve is being replaced with a 2000 psi-rated gate valve. Many equipment changes and tests are being conducted with respect to all artificial lift equipment. Pre-CO₂ injection flowlines are to be replaced with higher pressure rated fiberglass pipes to increase line capacity, and not for corrosion resistance [38].

4.1.4 Remote production headers

The remote headers and satellite battery headers are responsible to collect, or centralize, production from numerous wells and to provide individual well test

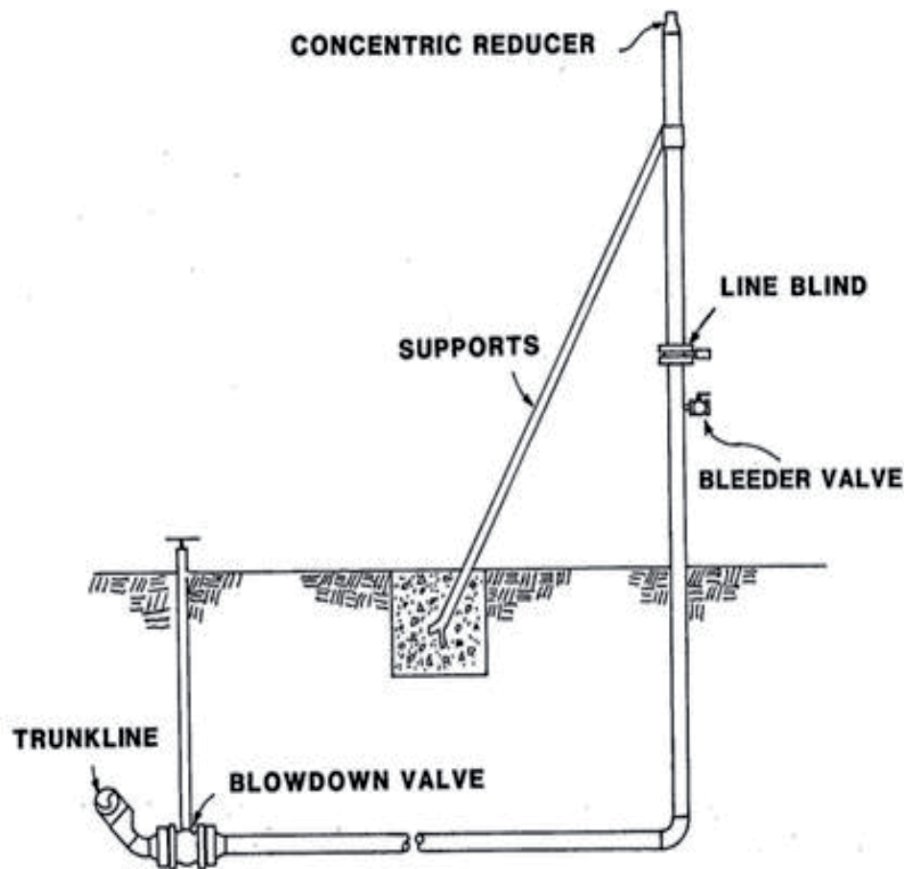

Figure 4.
 CO₂ trunkline blowdown station [5].

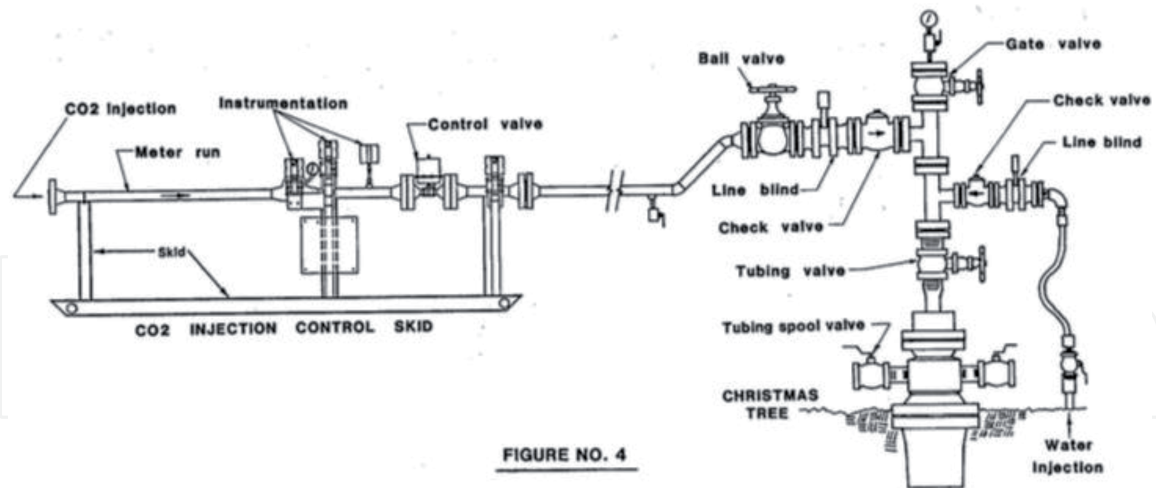

Figure 5.
 CO₂ injection well head [5].

facilities for oil, water, hydrocarbon gas, and CO₂ gas production. Remote headers are operated at pressure range of 30–35 psi, while the satellite batteries' headers operate from 25 to 30 psi, whereas satellite batteries are to remove the majority of the hydrocarbon and CO₂ gas from the produced fluids and to pump liquids to the fluid gathering, and obtain well tests [39]. Each satellite battery includes a header, test separator, production separator, and transfer pumps.

The specific design criteria for satellite batteries include the following:

1. Minimum of two phase production separators per satellite

2. A pump from separator system
3. Three phase test separators per ten wells

4.1.5 Separation process

Surface facilities in CO₂-EOR requires recovery of CO₂ and reinjecting it back to the well, with which CO₂ release to the atmosphere can be minimized as well as purchasing cost of additional CO₂ can be reduced. Typical surface facilities for CO₂-EOR are gas separation. Water treatment of CO₂ compression and injection and also dehydration can be seen in Figure 7.

Dehydration column removes the moisture content of the gas stream by using the contact with lean glycol in the upper part of the 14 tray column and the gas must be cooled first by the air cooler. Rich glycol is extracted from the bottom of the

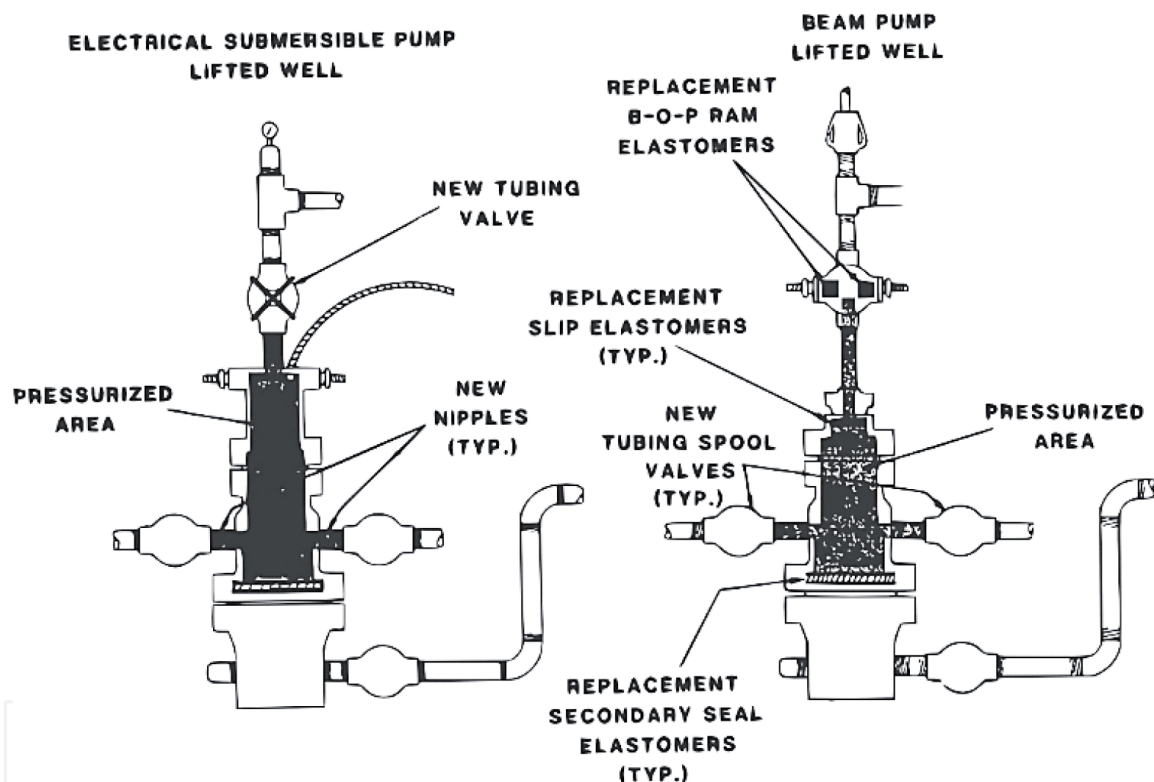

Figure 6. Modifications on CO₂ production well head [5].

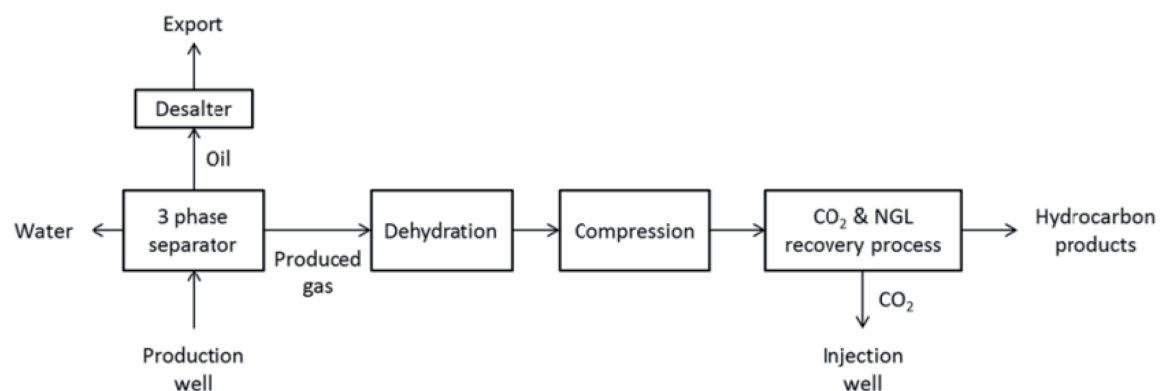

Figure 7. Typical surface facilities for CO₂-EOR [21].

column and directed to the regeneration system, and dry gas passes through from the top to the compressor package.

A slug catcher is to catch any water as water will be continuously dropping, which may unload in slugs. Then, three-stage reciprocating compressor is used to increase the pressure of CO₂ from 700 kPa(g) to approximately 10,000 kPa(g). At the first stage reciprocating compressor at 3000 kPa the CO₂ is dehydrated. Afterwards, CO₂ liquid is trucked to the site to supplement injection requirement and stored in refrigerated bullet. Then, the cryogenic triplex pumps are used to pump the CO₂ liquid to injection pressure. After that, the liquid and compressed gaseous CO₂ are commingled in a mixer [40]. A minimum well head temperature must be maintained so as not to freeze the inhibited water in the well annulus. Should the injection compressor be shut in, liquid CO₂ is warmed by a trim heater.

4.2 Offshore CO₂-EOR facilities

The majority of CO₂-EOR projects are all similar in terms of facilities to those in the offshore. The following sections discuss the various equipment and facilities required at different phases of a typical offshore CO₂ injection project.

4.2.1 Pig launcher and steel pipeline

Depending on the CO₂ stream composition, weight, temperature, and pressure, the outline of pig launcher ought to be in certain standards and suitable measures (e.g., DNV OSF-101). Pigging is usually used for dispatching new or re-appointing existing pipelines. A reconditioned or new pipeline needs to be hydrotested to guarantee pressure integrity. Frequent inspection for any degradation and verification of the effects of dry CO₂ stream on the pipeline must be done. In any case, since the CO₂ will be exceptionally dry, it is likely that future pigging operations will be less successive due to subsea situation. Normally, the pig traps are not fitted; thus, portable pig traps can be considered in the design [40].

Piping diameters and thickness are the main concern in designing the facilities in which for the purpose of CO₂-EOR the pipeline could have two diverse design requirements. If the storage complex is already pressurized over the required level to keep the CO₂ as fluid in injection wells, then the project may pick to utilize high-pressure liquid pipe. In other cases, for instance, the Hewitt Field model [11], the pressure inside the field would bit by bit be expanded using gaseous CO₂ in the transport system until the field pressure can maintain liquid CO₂ in the injection wells. During that time, the transport system would be changed over to a higher pressure fluid pipeline.

The pipeline system in onshore system is typically below 120 atm (1740.45 psi) and logically the pressure in the offshore CO₂ pipeline is higher. In offshore frameworks, the CO₂ is being pumped under long distances; thus, there is much pressure loss due to friction. With trunkline pressure between 150 and 250 atm, the CO₂ may be injected into geological formation without further boosting of pressure. The pressure will be affected by the distance of onshore facilities and offshore storage complexes, which may affect the wall thickness and pipeline diameters [21, 41].

Due to the danger of transporting high-pressure liquid CO₂, the transportation will be done in liquid and subcritical. To diminish the risk in onshore pipelines, it is likely that these will be at pressure lower than the required for offshore transport and ought to be expanded at a coastal booster station before going to offshore [42–44]. Besides, offshore pressure booster may be required if there is excessive pressure drop between onshore booster station and offshore storage complexes or if the pressure is inadequate to inject directly into reservoir [45].

Injection rate	Pressure	Temperature	CO ₂ phase
Range: 10–48 t/day	Well head 1015.26 to 1595.42 psi	Well head 32°C	Kept to be “supercritical phase” (at well bottom)
Ordinary rate: 20 to 40 t/day	Well bottom max. 2755.72 psi	Well bottom 48°C	

Table 1.
Operation conditions of injection facilities in Nagaoka, Japan [42].

To avoid two-phase flow that leads to critical damage and cavitation, the pressure downstream of an offshore booster pump should be over bubble point [46].

4.2.2 CO₂ injection

CO₂ might be injected directly into the reservoir if the pipeline pressure is adequate. However, it is likely to bring CO₂ onto platform for control pressure or to lift its pressure; certain design considerations should be considered. Below are the injection facilities’ operation conditions and the process flow diagram of field test of CO₂ injection in Nagaoka, Japan [43]. Some operation details of injection facilities in Nagaoka are summarized in **Table 1**.

4.2.3 Risers, emergency shut down valve (ESDV), compressors, and pumps

Risers are the piping that transports the fluid between the offshore platform and the seabed. Flexible risers are used especially on floating production installations. ESDV is placed between the moving pipe infrastructure and the riser to the platform as a safeguard gadget to guarantee no leakage of CO₂ when there is failure in platform. It is likely found on the seabed where there is the possibility of heavy things to be dropped on the pipeline underneath during the lifting operation work. Moreover, it is designed to counter any structural failure on the platform and any upstream failure where it will cause the valve to close.

Pressure issue related to CCS projects may require extra pumping units due to higher pressure required over long distance. In the event that the pressure drops along offshore pipeline, usually pumps would be placed on an offshore platform [44].

4.2.4 Fluid separation

Due to the nature of CO₂-EOR patterns, the water production is high, thus leading to the need for large separation capacity with inlet separators dominated with water rather than oil. Moreover, separation is harder because of scale, emulsion, ESP or gas lifting, and asphaltenes. A large CO₂ reinjection compressors are needed due to high CO₂ production that resulted from back produced CO₂ in the system.

5. CO₂ sequestration

Since the industrial revolution, concentration of CO₂ and other greenhouse gases increased due to burning of fossil fuels. The measured atmospheric concentrations of CO₂ are 100 ppm higher than preindustrial levels [46]. According to report published by the Global Monitoring Division (formerly CMDL) of the National Oceanic and Atmospheric Administration, concentration of CO₂ in the atmosphere has increased by 26% from less than 320 ppm in 1960 to 405 ppm in 2017 [47]. Fossil

fuels provide 86% of the world's energy and this amount is responsible for around 91% of CO₂ emissions. There is almost a global agreement about taking responsible actions in implementing energy sources in the years to come [48].

Subsurface CO₂ sequestration is one of the various options for reducing the CO₂ concentration in the atmosphere resulting from anthropogenic activities. CO₂ sequestration potentially provides around 25% of the required mitigation to global emissions, which can delay global warming to an acceptable extent [48]. Subsurface sequestration captures CO₂ at the point of its emission and injects large amounts of it deep into subsurface formations where it can be stored permanently [49].

5.1 CO₂ sequestration repositories

Several types of subsurface repositories may be utilized for sequestration of CO₂. CO₂ could be safely sequestered in subsurface formations such as deep saline aquifers, coal bed methane (CBM), and depleted hydrocarbon reservoirs. Due to known geological formation and existence of seal traps, CO₂ may be more safely sequestered in depleted oil and gas reservoirs as compared to saline aquifers and coal bed methane reservoirs. On the other hand, the abundance and higher storage capacity are two major motivations for sequestration of CO₂ in saline aquifers. **Figure 8** illustrates CO₂ sequestration in various underground repositories. International Energy Agency (IEA) estimated global geological sequestration (storage) potential of 400–10,000 Gt for saline formations and 900 Gt for depleted oil/gas fields [50]. CO₂ sequestration requires comprehensive knowledge of characterization and behavior of CO₂, rock and fluid interactions, as well as operation conditions in the geological formation of interest.

5.2 Mechanisms of sequestration

There are several mechanisms involved in the sequestration processes. In a typical CO₂ sequestration, some of the injected gas dissolves in the formation water (solubility trapping), some may be trapped as residual gas saturation (nonwet trapping), and some may react with host minerals to precipitate carbonate, i.e., mineral trapping.

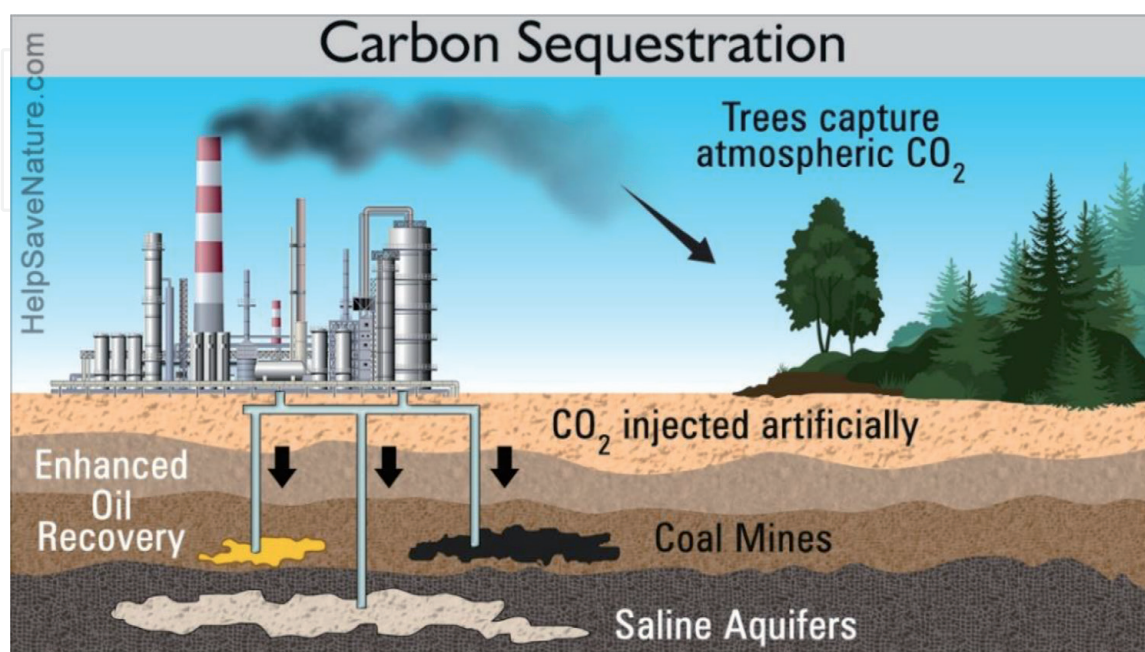

Figure 8.
CO₂ sequestration in various geological settings [from helpsave-nature.com].

In trapping mechanism, the injected CO₂ is trapped in reservoirs in a manner similar to natural gas. Further vertical movement of natural gas (similar to CO₂) is hampered by cap rock, which is impermeable. Although combination of all of the sequestration mechanisms render CO₂ immobile in the geological repositories, the structural/stratigraphic and residual fluid mechanisms have the most dominant and imminent effect on trapping or retaining CO₂ in aquifers [51]. This mechanism is mainly governed by density of injected CO₂. The density difference between the injected CO₂ and brine determines further movement of CO₂ plume to rise or sink.

In nonwet trapping, once the supercritical CO₂ is injected into the formation, it relocates fluid as it passes through the porous rock. As CO₂ continues to move, some of the CO₂ is left as disconnected droplets in the interstices due to interfacial forces. This process occurs when relative permeability to nonwet phase, i.e., CO₂, becomes zero; nonwet phase therefore is rendered immobile assuming the formation is water-wet. Just like trapping of oil droplets (as nonwetting phase) in the pores containing wetting-phase (being brine), CO₂ fills the interstices between pores and is trapped as discontinuous phase. The phenomenon is largely dominated by interfacial tension between the phases and wetting characteristics of the surface [52, 53].

Dissolution of CO₂ in water is another important process responsible for sequestration of 20–60% injected CO₂ in the geological formations. Dissolution mechanism occurs during migration of CO₂ along its pathway in the injected formation. Over time, the injected CO₂ dissolves into the formation brine, increasing its density. As a result, CO₂-saturated brine sinks slowly and does not reach the surface. Moreover, the dissolution of injected high-pressure CO₂ in the formation brine acidifies the indigenous formation water [10]. Estimating capacity of this mechanism requires reservoir simulation and knowledge of CO₂ supply ratio and injection rate, rock/fluid properties, and reactions [54].

In CO₂ mineralization, CO₂ reacts with minerals in rock to form stable components such as carbonates and aluminosilicate. It occurs along the migration pathway of CO₂ into reservoir. Both rate and magnitude of reaction are dependent on the presence of reactive minerals [52] and formation water chemistry [55, 56]. Effective time for mineralization may vary from 500 to 1000 years. However, mineralization can give rise to precipitation of certain minerals and it leads to blockage of pore throat, thereby reducing permeability leading to loss of injectivity. The process is very slow and confined CO₂ becomes immobile. The amount of CO₂ sequestered by this mechanism can be significant. Knowledge of mineralogy of a rock is the main requirement in predicting the behavior of CO₂ in this mechanism.

5.3 CO₂ sequestration capacity

The estimation capacity can be calculated using:

$$G_{CO_2} = A \times h \times \Phi \times \rho \times E \quad (1)$$

where G is the volume of CO₂, A is the area, h is the thickness, Φ is the porosity, and E is the efficiency factor for the CO₂ sequestration operation. The abovementioned parameters are mostly in the following range: mostly within the following range in physical parameters:

- Areal extent of worldwide sedimentary basins (A): 70–80 million km²
- Aquifer thickness (h): 50–400 m

- Porosity (Φ): 0.05–0.30
- CO₂ solubility (S): 20–80 kg/m³; efficiency factor (Es): 0.01–0.5 (*0.0001–0.01)
- CO₂ density (ρ): 400–800 kg/m³; efficiency factor (Ef): 0.01–0.03 (*0.0001–0.0006)

• Eq. (1) can be further modified to account for CO₂ sequestration capacity that is coming from each trapping mechanism [51].

6. CO₂ injection in unconventional reservoirs

Conventional reservoirs are oil and gas reserves that could be found in discrete accumulation of pools. Therefore, the hydrocarbon can be easily recovered through classic exploration techniques and vertical or deviated wells. Unconventional reservoirs on the other hand could be defined as a reservoir that requires out-of-the-ordinary and hence complicated techniques of recovery as compared to the conventional oil and gas reservoirs [57, 58]. The main reasons why such reservoirs are getting considerable attention are the depletion of conventional sources and huge energy demand. **Figure 9** shows the unconventional reservoirs that can be potentially produced for recovery of hydrocarbon. Tight-gas sands, gas and oil shales, coalbed methane, heavy oil, tar sands, and gas-hydrate deposits are among the most anticipated reservoirs. These reservoirs often necessitate complex recovery

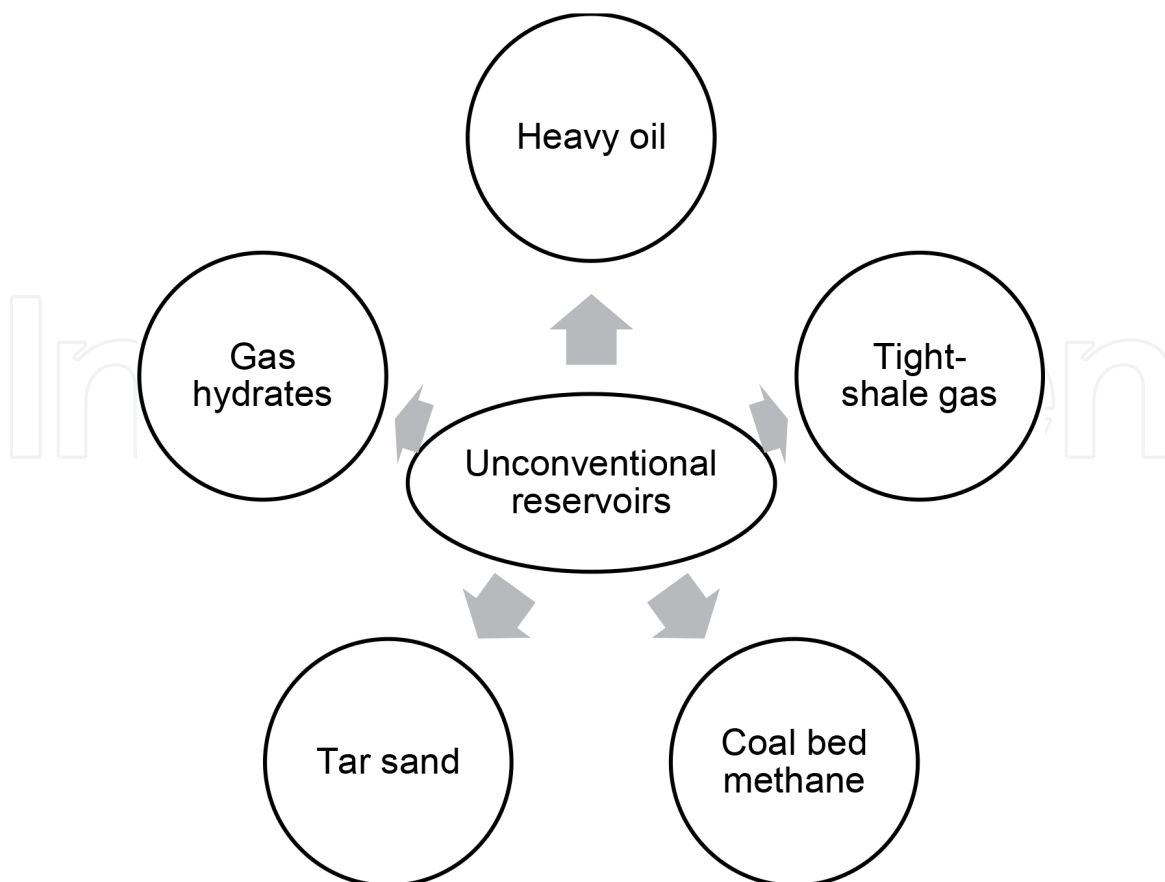

Figure 9.
Common unconventional hydrocarbon reservoirs.

solutions such as stimulation treatments or thermal recovery methods and particular process facilities. Moreover, those requirements should be technically and more importantly economically viable [59].

6.1 Shale reservoirs

Shale gas reservoir is referring to unconventional reservoirs that produce natural gas. Shale gas reservoir has received a lot of attention due to the potential reservoir in supplying clean burning energy and the way it copes with the depletion of conventional reservoirs [58]. However, at a certain time, the production of shale gas well decreases rapidly; thus, an enhanced gas recovery method has been aiming to improve the recovery from shale gas reservoirs.

In shale reservoir, methane (CH_4) is adsorbed initially onto the surfaces of matrix particles and natural fracture faces and is stored in the matrix limiting its effective extraction [59]. Although large amounts of adsorbed gas exist, the ultra-low permeability of the shale matrix limits its effective extraction. CO_2 injection is one of the methods that are largely implemented for EOR purposes due to the availability of CO_2 , the economics of operation, specific properties of CO_2 gas, and positive environmental impact. CO_2 can be used for enhanced gas recovery as well [60]. The process of EGR (enhanced gas recovery) using CO_2 is mainly dominated by pressurizing effect. The pressurizing effects can cause CO_2 injection to increase the rock permeability. The amount of CO_2 injected into the well will be divided into two amounts; about 1% of injected CO_2 will be produced, while 99% of injected CO_2 will be stored in the reservoir. Therefore, tight shale gas reservoirs potentially make excellent repositories for CO_2 sequestration purposes as well [60].

Various factors affect the recovery from tight shale reservoirs such as matrix porosity and permeability, hydraulic fracture half-length, and well spacing [61]. CO_2 injection in shales is often conducted using huff and puff method. The supercritical carbon dioxide injection repressurizes the reservoir after the initial production period. Once the injected gas soaks from the fractures into the shale's organic matrix through diffusion and convection, methane is released by the competitive adsorption since the shale has a stronger affinity for carbon dioxide than for methane. Then, during the second production period, the methane partial pressure is lowered and the shale gas production rate increases [62].

One example of such reservoirs is Chattanooga shale in Missouri, USA. The main objective of this project was to inject 500 tons of CO_2 to survey the injection and storage potential of CO_2 in a natural shale development while checking for enhanced gas recovery. The roads leading up to the wellpad were regraveled and graded to facilitate CO_2 delivery by truck to the injection site. The wellpad was cleared and graveled prior to moving equipment on site. A 70-ton CO_2 storage vessel was located permanently on site and refilled periodically by 20-ton tankers. The skid pump with all the controls and meters, as well as the propane tank and heater to heat the CO_2 , was also located on site (**Figure 10**). The well head of the injection well was converted to accommodate the CO_2 injection by adding a gate valve, an inlet for the CO_2 line, as well as a tee for additional tests and monitoring [63].

The injection of 510 tons of CO_2 during this test exhibits the first successful injection of CO_2 in an organic shale formation to monitor for storage and enhanced gas recovery potential in Central Appalachia. This productive injection and monitoring of a CO_2 infusion in an organic shale reservoir are extraordinary



Figure 10.
Injection well site layout [63].

achievements and points of reference for CO₂-EGR and additionally geologic CO₂ storage in unconventional reservoirs. Once the well was brought back online after the soaking period, a significant increase in gas production occurred. During the first month of flowback, the average daily production rate was ~124 Mcf/day, which is over 8 times the average production for the last month before the well was taken offline for injection [64]. After 2 years of flowback, the well was still flowing at an increased production rate but is close to the projected historical production rate. The similar behavior of the injection well has been reported for modeling CO₂ ‘huff-and-puff’ test in shale-oil reservoirs. The CO₂ concentration in the product gas has steadily declined during the flowback of the injection well and 41% of the injected CO₂ had been produced by the end of 2015 (17 months after flowback started). If the rate held constant, it would take over 8 years to produce all of the CO₂ injected [63, 64].

6.2 Tight oil reservoir

The tight oil reservoir is a type of unconventional oil reservoir that is hard to produce due to the low permeability. In recent years, the exploitation of tight oil reservoir increased due to advanced technologies in the production industry and high demand for the energy. Two main technologies that need to be increased are horizontal drilling and multi-stage hydraulic fracturing. U.S. Energy Information Administration reported that tight oil production will increase from 33% of total lower 48 onshore oil production to 51% in 2040 [59, 60]. However, the decline curves of primary production are steep due to low permeability [60, 66]. CO₂-EOR is utilized more commonly as compared to water flooding in case of tight oil reservoirs due to the poor sweep efficiency of water flooding and low injectivity of water in tight oil reservoirs. Moreover, in case of the reservoirs with a higher wetting tendency toward oil (oil-wet), water flooding would be less effective. CO₂-EOR could be implemented as continuous CO₂ injection or huff and puff technique. Hydraulic fracturing is one of the most important mechanisms in recoveries from tight oil reservoirs. The geometry, the number, and the spacing of the fracture can affect the recovery from the tight oil reservoirs. Bakken reservoir in the US is one of the largest unconventional tight oil reservoirs that has been produced since early 1950s. Through years of production and study of the reservoir, engineers decided that the following strategies are suitable for this field as shown in **Table 2**.

The followings outcomes were observed during the simulation of CO₂-EOR for the period of 30 years on Bakken Field:

1. Oil recovery factor increases with the increasing number of cycles of CO₂ huff and puff, and the incremental oil recovery factor at a 30-year period is 2.43% corresponding to three cycles in this case study.
2. Lower permeability, longer fracture half-length, and more heterogeneity are much favorable for the CO₂ huff and puff process.
3. The CO₂ diffusion mechanism is more pronounced than the convention mechanism for the reservoir with lower permeability during the CO₂ huff and puff process.

6.3 Heavy oil reservoir

Some of the world's largest reserves are heavy oil reservoirs. With oil in place equal to the largest conventional oil fields in the Middle East, these large reserves are found in more than thirty countries around the globe, but few of these deposits have been developed extensively. One of the problems in the heavy oil reservoir is asphaltenic oil precipitate in the reservoir. Asphaltene is a component in petroleum, especially heavy oils. The asphaltene content could be defined by its solubility. Basically, any component that dissolves in toluene and precipitates in alkane is considered as asphaltene [65]. Various strategies and possible action to oil recoveries are summarized in **Table 2**.

Overall, heavy oil reservoirs are considered not favorable for CO₂ flooding compared to light oil reservoir due to lack of sweep efficiency. The considerable viscosity difference between heavy oil and the injected CO₂ results in poor sweep efficiency from heavy oil reservoirs. Moreover, there is a possibility of asphaltene precipitation during miscible displacement; therefore, the compatibility of fluids is an important parameter to consider when designing EOR process for heavy oil reservoirs.

Strategies	Actions
Development of CO ₂ -EOR techniques for unlocking resources in tight oil formations	<ul style="list-style-type: none"> • CO₂ injection may be the most suitable technique for recovery. • Develop pragmatic and sustainable techniques in order to unlock resources in tight oil formations via this injection.
Tight formation characterization and multistage fracturing optimization	<ul style="list-style-type: none"> • For tight formations, the fracture systems are required such natural and hydraulic fracture. • The results can be used to optimize the well spacing and fracturing strategies.
Unlocking Bakken potential through CO ₂ huff and puff	<ul style="list-style-type: none"> • Efficient in fractured reservoirs. • Potential to use mixtures such as CO₂/field gas, CO₂/methane, or CO₂/propane to improve the oil recovery under different conditions.
Optimum CO ₂ and water-based oil recovery processes for Bakken formations	<ul style="list-style-type: none"> • To examine the oil recovery mechanisms and to evaluate the overall performance of WAG, GAW, and SWAG processes, in comparison to CO₂ flooding under miscible conditions. • Aim to determine the proper timing and also the slug sizes for different CO₂ and water-based oil recovery processes, including their effects on total oil recovery.

Table 2. Strategies and action that could efficiently lead to increase in the recovery.

7. Future horizons of CO₂-EOR and sequestration

The potential effect of CO₂-EOR is not so much a matter of whether but of when. The science of the process is known to the experts, and there are plenty of CO₂ emitters from different sources available and many oil reservoirs to host these CO₂ from these emitters. The key point is the economic decision that depends primarily on several factors. Oil price, capital cost of infrastructures, tax policies on CO₂ emission, cost of CO₂ capture from CO₂ emitters, and the speed of technology developments are the key parameters for economic decisions. These parameters could be hard to predict; however, developing a platform to facilitate the decision-making could speed up CO₂-EOR and sequestration significantly.

Author details

Erfan Mohammadian^{1*}, Badrul Mohamed Jan², Amin Azdarpour³,
Hossein Hamidi⁴, Nur Hidayati Binti Othman¹, Aqilah Dollah¹,
Siti Nurliyana Binti Che Mohamed Hussein¹ and Rozana Azrina Binti Sazali¹

¹ Faculty of Chemical Engineering, Universiti Teknologi Mara (UiTM), Shah Alam, Malaysia

² Department of Chemical Engineering, University of Malaya, Kuala Lumpur, Malaysia

³ Department of Petroleum Engineering, Marvdasht Branch, Islamic Azad University, Marvdasht, Iran

⁴ School of Engineering, King's College, University of Aberdeen, Aberdeen, UK

*Address all correspondence to: erfan.723@gmail.com

IntechOpen

© 2019 The Author(s). Licensee IntechOpen. This chapter is distributed under the terms of the Creative Commons Attribution License (<http://creativecommons.org/licenses/by/3.0>), which permits unrestricted use, distribution, and reproduction in any medium, provided the original work is properly cited. 

References

- [1] National Energy Technology Laboratory (NETL). Carbon Dioxide Enhanced Oil Recovery (Untapped Domestic Energy Supply and Long Term Carbon Storage Solution) [Internet]. 2010. Available from: <http://www.netl.doe.gov/index.html>
- [2] Stalkup FI. Miscible Displacement, SPE Monograph No. 8. New York: Society of Petroleum Engineering of AIME; 1983
- [3] Stalkup F. Miscible Displacement, Second Printing. Dallas, New York: Society of Petroleum Engineers of AIME; 1984
- [4] Kokal S, Al-kaabi A. Enhanced Oil Recovery: Challenges & Opportunities. World Petroleum Council: Official Publication; 2010
- [5] Stosur GJ. EOR: Past, present and what the next 25 years may bring. In: SPE Paper 84864, Presented at the SPE IOR Conference in Asia Pacific; October 20-21, 2003; Kuala Lumpur, Malaysia 2003
- [6] Thomas S. EOR—An overview. Oil and Gas Science and Technology. Revue de l'IFP. 2008;63(1):9-19
- [7] IPCC AR5 WG2 A. Field CB et al., editors. Climate Change 2014: Impacts, Adaptation, and Vulnerability. Part A: Global and Sectoral Aspects. Contribution of Working Group II (WG2) to the Fifth Assessment Report (AR5) of the Intergovernmental Panel on Climate Change (IPCC). Cambridge University Press, Archived from the original on 28 April 2016. Archived; 2014
- [8] Saxon J Jr, Breston JN, MacFarlane RM. Laboratory tests with carbon dioxide and carbonated water as flooding mediums. Production Monthly. 1951;16:8
- [9] Beeson DM, Ortloff GD. Laboratory investigation of the water-driven carbon dioxide process for oil recovery. Transactions of AIME. 1959;216:388-391
- [10] Holm LW, Josendal VA. Effect of oil composition on miscible-type displacement by carbon dioxide. Society of Petroleum Engineers Journal. 1982;22(2):87-98
- [11] Kane A. Performance review of a large scale CO₂-WAG enhanced recovery project. SACROC Unit-Kelly Snyder Field. Journal of Petroleum Technology. 1979;31(2):217-231
- [12] Mathiassen OM. CO₂ as Injection Gas for Enhanced Oil Recovery and Estimation of the Potential on the Norwegian Continental Shelf. Stavanger: NTNU—Norwegian University of Science and Technology; 2003
- [13] Teklu TW, Alharthy N, Kazemi H, Yin X, Graves RM. Hydrocarbon and non-hydrocarbon gas miscibility with light oil in shale reservoirs. Society of Petroleum Engineers. 2014. DOI: 10.2118/169123-MS
- [14] Morishige K, Fujii H, Uga M, Kinukawa D. Capillary critical point of argon, nitrogen, oxygen, ethylene, and carbon dioxide in MCM-41. Langmuir. 1997;13(13):3494-3498
- [15] Travallonia L, Castierb M, Tavaresa FW, Sandler SI. Critical behavior of pure confined fluids from an extension of the Van der Waals equation of state. Journal of Supercritical Fluids. 2010;55(2):455-461
- [16] Zarragoicoechea GJ, Kuz VA. Critical shift of a confined fluid in nanopore. Fluid Phase Equilibria. 2004;221(2004):7-9
- [17] Ahmadi K, Johns RT. Multiple mixing cell method for

MMP calculation. SPE Journal. 2011;**16**(4):733-742

[18] Graue DJ, Zana ET. Study of a possible CO₂ flood in the Rangely Field, Colorado. Journal of Petroleum Technology. 1981;**1981**:1312

[19] Verma BMK, Jewell S, Survey USG. Fundamentals of Carbon Dioxide-Enhanced Oil Recovery (CO₂-EOR)—A Supporting Document of the Assessment Methodology for Hydrocarbon Recovery Using CO₂-EOR Associated with Carbon Sequestration. 2015

[20] Friedmann SJ. Carbon Capture and Sequestration Technologies: Status and Future Deployment. UCRL-BOOK-235276. 2007

[21] Kang P, Lim J, Huh C. Screening criteria and considerations of offshore enhanced oil recovery. Energies. 2016;**9**(1):44. DOI: 10.3390/en9010044

[22] Bachu S. Sequestration of CO₂ in geological media in response to climate change: Roadmap for site selection using the transform of the geological space into the CO₂-phase space. Energy Conversion and Management. 2002;**43**:87-102

[23] Webster CM, Zhang Y, Park D, Gibbons K. Workflows & Considerations for CO₂ Injection in a Highly Depleted Gas Field in the Southern North Sea. In Offshore Europe. Society of Petroleum Engineers; 2011

[24] Kalantari-dehghani A, Gholami V, Moghadasi J, Abdi R. Formation Damage Through Asphaltene Precipitation Resulting From CO₂ Gas Injection in Iranian Carbonate Reservoirs. SPE SPE-99631-PA. 2008. ISBN 1930-1855

[25] Chadwick RA, Williams GA, Williams JDO, Noy DJ. Measuring

pressure performance of a large saline aquifer during industrial-scale CO injection: The Utsira sand. International Journal of Greenhouse Gas Control. 2012;**10**:374-388. ISSN 1750-5836

[26] Zagreb. Design and mechanical integrity of CO₂ injection. Wells. 2011;**23**:1-8

[27] Wei N, Li X, Dahowski RT, Davidson CL, Liu S, Zha Y. Economic evaluation on CO₂-EOR of onshore oil fields in China, International Journal of Greenhouse Gas Control. 2015;**37**:170-181. DOI: 10.1016/j.ijggc.2015.01.014

[28] Fukai I, Mishra S, Moody MA. Economic analysis of CO₂-enhanced oil recovery in Ohio : Implications for carbon capture, utilization, and storage in the Appalachian Basin region. International Journal of Greenhouse Gas Control. 2016;**52**:357-377. DOI: 10.1016/j.ijggc.2016.07.015

[29] Verma BMK, Jewell S, Survey USG. Fundamentals of Carbon Dioxide-Enhanced Oil Recovery (CO₂-EOR)—A Supporting Document of the Assessment Methodology for Hydrocarbon Recovery Using CO₂-EOR Associated with Carbon Sequestration

[30] Webster CM, Zhang Y, Park D, Gibbons K. Workflows & Considerations for CO₂ Injection in a Highly Depleted Gas Field in the Southern North Sea. Offshore Europe: Society of Petroleum Engineers; 2011

[31] Chadwick RA, Williams GA, JDO W, Noy DJ. Measuring pressure performance of a large saline aquifer during industrial-scale CO injection: The Utsira Sand, Norwegian North Sea. International Journal of Greenhouse Gas Control. 2012;**10**:374-388. ISSN: 1750-5836

[32] Macon BR. Design and Operation of the Level Land Unit CO₂ Injection Facility SPE Annual

- Technical Conference and Exhibition. SPE-8410-MS
- [33] Saadawi H. Design of Surface Facilities for a High-Pressure Miscible Gas Injection Pilot Scheme Macintyre. 1989
- [34] Alderman D, McFarland R, McIntyre J, Minissale J. Field facilities for CO₂ tertiary floods—a conceptual design. In: 57th Annual Fall Technical Conference and Exhibition of the Society of Petroleum Engineers of AIME. 1982. pp. 1-7
- [35] Iwasaki S, Kamijo T, Takashina T, Tanaka H. Large scale flue gas CO₂ recovering/CO₂ cost and total system for CO₂ enhanced oil recovery. Technical Review. 2004;**41**(4):1-6
- [36] Linn. CO₂ Injection and Production Field Facilities Design Evaluation and Considerations. 1987
- [37] Macintyre KJ. Design considerations for carbon dioxide injection facilities. Petroleum Society of Canada. 1986. DOI: 10.2118/86-02-09
- [38] Research report: Hazard Analysis for Offshore Carbon Capture Platforms and Offshore Pipelines. London: Energy Institute and Global CCS Institute; 2017
- [39] Donghyun YK, Yi HS, Dong-Hun K, Jin-Kuk K. Feasibility study and process development of CO₂ EOR surface facilities. 2015
- [40] IEAGHG. Effects of Impurities on Geological Storage of CO₂. 2011
- [41] Kikuta K, Hongom S, Tanase D, Ohsumi T. Field test of CO₂ injection in Nagaoka, Japan. In: 7th International Conference on Greenhouse Gas Control Technologies. 2004
- [42] Goodyear SG, Koster MP, Marriott KA, Paterson A, Sipkema AW, Young IM, Production BV. Moving CO₂ EOR Offshore. 2011
- [43] Verma MK. 2015 Fundamentals of carbon dioxide-enhanced oil recovery (CO₂-EOR)—A supporting document of the assessment methodology for hydrocarbon recovery using CO₂-EOR associated with carbon sequestration: U.S. Geological Survey Open-File Report 2015-1071. 19 p. DOI: 10.3133/ofr20151071
- [44] ISSN 2331-1258 (online) IPCC (2014). International panel on Climate Change. Berlin, Germany: Intergovernmental Panel on Climate Change. 11th Assessment Report; IPCC Secretaria; 2014
- [45] Allen MR et al. Framing and context. In: Masson-Delmotte VP, Zhai H-O, Portner D, Roberts J, Skea PR, Shukla A, et al, editors. Global Warming of 1.5°C. An IPCC Special Report on the Impacts of global Warming of 1.5°C above Pre-Industrial Levels and Related Global Greenhouse Gas Emission Pathways, in the Context of Strengthening the Global Response to the Threat of Climate Change, Sustainable Development, and Efforts to Eradicate Poverty. Geneva, Switzerland: World Meteorological Organization; 2018. pp.49-91
- [46] Da Silva PR, Ranjith PG. A study of methodologies for CO₂ storage capacity estimation of saline aquifers. Journal of Fuel. 2011;**93**:13-27
- [47] Bradshaw J, Bachu S, Bonijoly D, Burruss R, Holloway S, Christensen N. CO₂ storage capacity estimation: Issues and development of standards. International Journal of Greenhouse Gas Control. 2007;**1**(1):62-68
- [48] IEA Energy Technology Essentials. IEA Annual Report. Paris, France: 2012

- [49] Hassanzadeh H. Mathematical Modeling of Convective Mixing in Porous Media for Geological CO₂ Storage [PhD thesis]. Canada: University of Calgary; 2006
- [50] Zou CN, Zhu RK, Liu KY. Tight gas sandstone reservoirs in China: Characteristics and recognition criteria. *Journal of Petroleum Science and Engineering*. 2012;**88-89**:82-91
- [51] Gozalpour F, Ren SR, Tohidi B. 2005 CO₂ EOR and storage in oil reservoirs. *Oil and Gas Science and Technology. Revue de l'IFP*. 2005;**60**(3):537-546
- [52] Rogala A, Ksiezniak K, Jan K, Jan H. Carbon dioxide sequestration during shale gas recovery. *Physicochemical Problems of Mineral Processing*. 2014;**50**(2):681-692
- [53] Senger K, Tveranger J, Alvar B, Olaussen S, Ogata K, Larsen L. CO₂ storage resource estimates in unconventional reservoirs: Insights from a pilot-sized storage site in Svalbard, Arctic Norway. *Environment and Earth Science*. 2014;**73**(8):3987-4009. DOI: 10.1007/s12665-014-3684-9
- [54] Cudjoe S, Vinassa M, Henrique Bessa Gomes J, Barati RG. A comprehensive approach to sweet-spot mapping for hydraulic fracturing and CO₂ huff-n-puff injection in Chattanooga shale formation. *Journal of Natural Gas Science and Engineering*. 2016;**33**:1201-1218. DOI: 10.1016/j.jngse.2016.03.042
- [55] Louk K, Ripepi N, Luxbacher K, Gilliland E, Tang X, Keles C, et al. Monitoring CO₂ storage and enhanced gas recovery in unconventional shale reservoirs: Results from the Morgan County, Tennessee injection test. *Journal of Natural Gas Science and Engineering*. 2017;**12**:2355-2388. DOI: 10.1016/j.jngse.2017.03.025
- [56] Jong EC, Restrepo JA, Luxbacher KD, Kirsch PA, Mitra R, Hebblewhite BK, et al. Risk management: Adapting riskgate for underground coal mines in the United States. *Mining Engineering*. 2016;**68**(3):51-57. DOI: 10.19150/me.6502
- [57] U.S. Energy Administration. Monthly crude oil and natural gas production. *Monthly Report*. 2017.
- [58] Zuloaga-Molero P, Yu W, Xu Y, Sepehrnoori K, Li B. Simulation study of CO₂-EOR in tight oil reservoirs with complex fracture geometries. *Scientific Reports*. 2016;**6**: Article number: 33445
- [59] Pilcher RS, McDonough Ciosek J, McArthur K, Hohman JC, Schmitz P. Ranking production potential based on key geological drivers—Bakken case study. *International Petroleum Technology Conference*. 2011. DOI: 10.2523/IPTC-14733-MS
- [60] Dechongkit P, Prasad M. Recovery factor and reserves estimation in the Bakken petroleum system (analysis of the antelope, Sanish and Parshall fields). *Society of Petroleum Engineers*. 2011. DOI: 10.2118/149471-MS
- [61] Kumar S, Hoffman T, Prasad M. Upper and lower Bakken shale production contribution to the middle Bakken reservoir. In: *Unconventional Resources Technology Conference*. 2013
- [62] Huang T, Yang H, Liao G, Zeng F. Optimization of CO₂ flooding strategy to enhance heavy oil recovery. In: *Paper Presented at the Society of Petroleum Engineers—SPE Canada Heavy Oil Technical Conference 2015, CHOC 2015*. 2015. pp. 980-999
- [63] Rojas GA, Zhu T, Dyer SB, Thomas S, Ali SF. Scaled model studies of CO₂ floods. *Society of Petroleum Engineers Reservoir Engineering*.

1991;6(2):169-178. DOI: 10.2118/
18083-PA

[64] Chukwudeme EA, Hamouda AA.
Enhanced Oil Recovery (EOR) by
Miscible CO₂ and Water Flooding of
Asphaltenic and Non-Asphaltenic Oils.
2009

[65] Liao Z et al. Discussion on the
structural features of asphaltene
molecules. *Energy & Fuels*.
2009;23(12):6272-6274

[66] National Energy Technology
Laboratory. Carbon Dioxide
Enhanced Oil Recovery Report. USA:
U.S. Department of Energy; 2010

IntechOpen