

We are IntechOpen, the world's leading publisher of Open Access books Built by scientists, for scientists

5,300

Open access books available

130,000

International authors and editors

155M

Downloads

Our authors are among the

154

Countries delivered to

TOP 1%

most cited scientists

12.2%

Contributors from top 500 universities



WEB OF SCIENCE™

Selection of our books indexed in the Book Citation Index
in Web of Science™ Core Collection (BKCI)

Interested in publishing with us?
Contact book.department@intechopen.com

Numbers displayed above are based on latest data collected.
For more information visit www.intechopen.com



Synthesis and Functionalization of Nanoparticles in Supercritical CO₂

Ludmila Otilia Cinteza and Daniela Bala

Abstract

A review of recent results on fabrication of inorganic and organic nanoparticles in supercritical carbon dioxide will be presented, with particular emphasis on the metallic and polymeric nanoparticles used in biomedicine. The use of the water-in-scCO₂ microemulsion in the synthesis of metal nanoparticles will be also discussed. The recent progress in preparation of polymeric nanoparticles with desired size and porosity obtained through processing methods in scCO₂ as drug delivery systems will be described. The efficiency of the drug encapsulation in organic and inorganic nanoparticles using supercritical CO₂ as dissolving media is another topic of interest. Various methods to achieve surface functionalization of nanoparticles in supercritical and subcritical CO₂ will be evaluated, considering the challenges and limitations in efficiency, scalability, and development of new applications.

Keywords: supercritical CO₂, nanoparticles, drug delivery, biomedicine

1. Introduction

The pharmaceutical industry has a major problem concerning the production of active pharmaceutical ingredients, which have a low water solubility and bioavailability. Therefore an appropriate technology for producing these active components is needed with certain properties like particle size (smaller than 1000 nm, typically under 500 nm), solubility, efficacy, state transition (polymorphism and crystallization), cost-effectiveness, etc.

In many nanomedical applications used in nanomedicine, processes based on supercritical fluids (SCFs) can be applied because they allow controlled fabrication of biological active nanostructured microparticles, nanoparticles, and nanoporous/nanostructured materials. Supercritical carbon dioxide (scCO₂) as a green solvent that possesses many beneficial properties (it is nonflammable, nontoxic, biocompatible, cost-effective, and abundant) has gained huge interest in the food and pharmaceutical industries; it is considered environmentally benign and one of the few solvents not regulated as a volatile organic compound (VOC) by the US Environmental Protection Agency.

There are several methods for the manufacturing of solid particles scaled from micron to nanosize, divided into bottom-up, top-down, and combination approaches of these [1].

Bottom-up techniques produce nanosized particles by precipitation from a supersaturated drug solution. Precipitation by addition of liquid antisolvent is made by simple mixing methods (using a static mixer) or by modified mixing methods (sonoprecipitation or high gravity controlled precipitation). Other bottom-up

techniques involve supercritical fluids, rapid expansion of supercritical solution (RESS), and supercritical antisolvent technique (SAS) or solvent removal by nano-spray dryer and spray freezing into liquid techniques. These methods have some disadvantages which include the size of particles that cannot be properly controlled in the non-sized range, but using of some additives (excipients, surfactants, etc.) can produce the stabilization nanocrystals or nanoparticles regarding the morphological properties and the crystallized polymorphic form [2]. Bottom-up techniques showed some advantages because they are low-energy processes and less expensive than the other methods, and obtained particles have narrow size distribution. In order to obtain smaller particles, these methods have been used in combination with top-down techniques [1].

Top-down techniques are used for particle size reduction of drugs to the nanometer size range by application of friction, involving high-energy processes such as media milling (wet bead milling) and high-pressure homogenization techniques (Dissocubes homogenization and NanoPure technology). These methods have some disadvantages which include a limited control of crystal size and surface properties and thermal or mechanical degradation generated by intensive energy of mixing [3]. These techniques are used in the last decade, but few nanocrystals under 100 nm have been obtained. Drug particles with smaller size than 100 nm have novel physical properties and better permeation through different biological barriers [4] and improved bioavailability of poorly aqueous soluble drugs, having different routes of administration such as oral, ocular, dermal, buccal, and pulmonary.

Supercritical fluids and their mixtures have specific properties like very fast mass transfer, near zero surface tension, and effective solvent elimination. The liquid-like and/or gas-like properties of SCFs and the possibility to modify several process parameters (temperature, pressure, and surface tension) can be benefits to produce several medical products at nanoscale. Several SCF-based processes are applied to nanomedicine applications: supercritical antisolvent precipitation (SAS), rapid expansion of supercritical solutions, supercritical emulsion extraction (SEE), supercritical assisted phase separation, supercritical gel drying, supercritical assisted liposome formation (SuperLip), supercritical assisted atomization (SAA), electrospinning in $scCO_2$, supercritical assisted injection in a liquid antisolvent (SAILA), and depressurization of an expanded solution into aqueous media (DESAM) [5].

scCO ₂ method	Nanoparticles	Temperature (K)	Pressure (MPa)	References
RESS	Drug micro-/nanoparticles Polymeric micro-/nanoparticles Drug encapsulated in polymeric microparticles	313–373	8–25	[6, 7]
SAS	Drug micro-/nanoparticles Inorganic nanoparticles	303–323	9–15 MPa	[8]
SEE	Drug encapsulated in lipid or polymeric nanoparticles	308–323	8–10 MPa	[5, 9, 10]
SAA	Drug nanoparticles	343–353	7–9	[11]
SAILA	Drug nanoparticles	343–353	7–10	[5]
RESOLV	Drug nanoparticles Polymer-stabilized drug NPs	308–318	10–20	[12]

Table 1. Reaction conditions (temperature and pressure) in $scCO_2$ -assisted synthesis of nanoparticles.

Numerous methods for nanoparticle fabrication and functionalization using supercritical carbon dioxide have been proposed, in various reaction conditions. In **Table 1**, some examples of temperature and pressure range frequently used for the preparation of nanoparticulated materials are summarized, with particular emphasis on drug or drug delivery systems.

The selection of the temperature and pressure condition is crucial for the particle size and drug encapsulation efficiency, and the specific values are chosen according to the characteristics of the active substance, such as solubility in scCO₂ phase, thermal stability, etc.

In this chapter, we present several applications of supercritical carbon dioxide (scCO₂) for preparation of polymeric nanoparticles as drug delivery systems, active principle encapsulation, water-in-scCO₂ microemulsion in the synthesis of metal nanoparticles, and various methods for surface functionalization of nanoparticles in supercritical and subcritical CO₂.

2. Applications of scCO₂ for preparation of polymeric nanoparticles as drug delivery systems

2.1 Supercritical fluids and their properties

SCFs can bring their contributions in different fields for certain applications as chromatography, fluid extractions, and micro- and nanoparticle formation. There are several compounds that can be used as supercritical fluids. Among them, hydrocarbons are toxic and inflammable, water has high critical parameters, but carbon dioxide has appropriate critical temperature and pressure, being suitable to be used as a green solvent.

2.2 Rapid expansion of supercritical solution

Methods using supercritical fluids (SCFs) can produce particles with narrow size distribution. Because of their special properties, SCFs can be applied to micronization of several types of compounds: drugs, biopolymers, polymers, food, coloring matters, explosives, etc. Pharmaceutical micronizations using supercritical fluids have some advantages due to the absence of organic solvent, and the particle size distribution could be controlled by process parameters. During the micronizations by SCFs methods, the dissolution rate is increased. The use of scCO₂ provides several advantages in comparison with the previous conventional techniques. The scCO₂ can be used as a solvent, antisolvent, and extracting agent for the organic phase of oil-in-water emulsions or at particle formation from gas saturated solution and improve the spraying process in different techniques [13].

The RESS process is based on the saturation of the supercritical medium with a solute (polymer) followed by a rapidly depressurization of the solution through a heated nozzle at high speed. During the pressure drop, the system passes from supercritical to atmospheric conditions, the solvent power decreases, and a fast nucleation of the solute in the form of very small particles with uniform size takes place. The properties of the obtained particles are influenced by its solubility in scCO₂; state parameters from precipitation vessel (temperature and pressure); size, length, and shape of the nozzle; distance of the jet stream; and impact angle onto the surface. A schematic representation of this process is presented in **Figure 1**.

The RESS technique has several advantages like the simple control of process parameters, the absence of organic solvents, and easy implementation on lab-scale when a single nozzle is used. RESS has also disadvantages as difficulty in scaling-up,

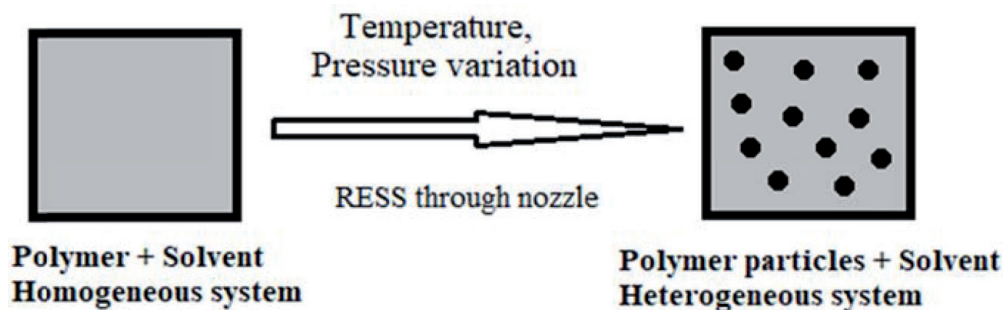

Figure 1.
Schematic representations of the RESS process.

the possible particle aggregation and/or nozzle blockage, using an important amount of carbon dioxide, and low solubility of most pharmaceutical compounds in supercritical CO₂. But, the scCO₂ solvent power can be increased by using of a co-solvent.

2.3 Rapid expansion of supercritical solution into a liquid solvent (RESOLV)

RESOLV represents a variation of RESS. This technique can reduce the particle aggregation during the jet expansion. In this process the supercritical solution is depressurized through a nozzle into a collection chamber containing an aqueous solution at room temperature. Different types of water-soluble polymers or surfactants can be added to the aqueous medium in order to stabilize the obtained nanoparticle suspension [12]. Biocompatible polymer nanoparticles composed of biodegradable polymers such as polylactic acid (PLA), poly(lactic-co-glycolic) acid (PLGA), and poly(ϵ -caprolactone) (PCL) are drawing a considerable interest in the scientific community because they can be used in medicine as biodegradable support materials and drug delivery vehicles. There are studies focused on the generation of polysaccharide particles. Polysaccharides are biobased polymers used in a lot of domains such as nutrition, energy, health care, and materials science, with large applications in the industry. An example of this family is chitosan, an amino-polysaccharide derived from chitin, being the second most biosynthesized polymer after cellulose. Because chitosan is biocompatible and biodegradable (mucoadhesive with antibacterial and cytocompatible), it can be used in pharmaceuticals and biomedical applications, cosmetics, food packaging, agriculture, water treatment, etc. Another polysaccharide is alginate that can be used in several areas like drug delivery, tissue engineering, and wound dressing. For these purposes and due to its essential functional groups (hydroxyl and carboxyl), alginates can be transformed to hydrogels, porous scaffolds, and micro- and nanoparticles [14].

2.4 Nanoparticles and porous scaffolds obtained by high-pressure CO₂ processing

In order to obtain microparticles, an experimental apparatus equipped with a high-pressure cell having a capillary nozzle was used. The scheme of this handmade experimental setup is presented in **Figure 2**.

Biopolymeric microparticles were prepared in our laboratory by rapid expansion of high-pressure CO₂-chitosan solution in sodium bis-(2-ethylhexyl) sulfosuccinate solution. At pressures higher than 2 MPa, ultrafine particles were formed, while under this value, wires were obtained (**Figure 3**). The Chi/AOT ultrafine particles are instantaneously formed when 2 mL Chi solution 2% (wt/wt), preheated 1 hour at 40°C, is sprayed using CO₂ at different pressures into 20 mL AOT 0.03 M aqueous solution through a stainless steel capillary nozzle of 30 mm length and 0.4 mm

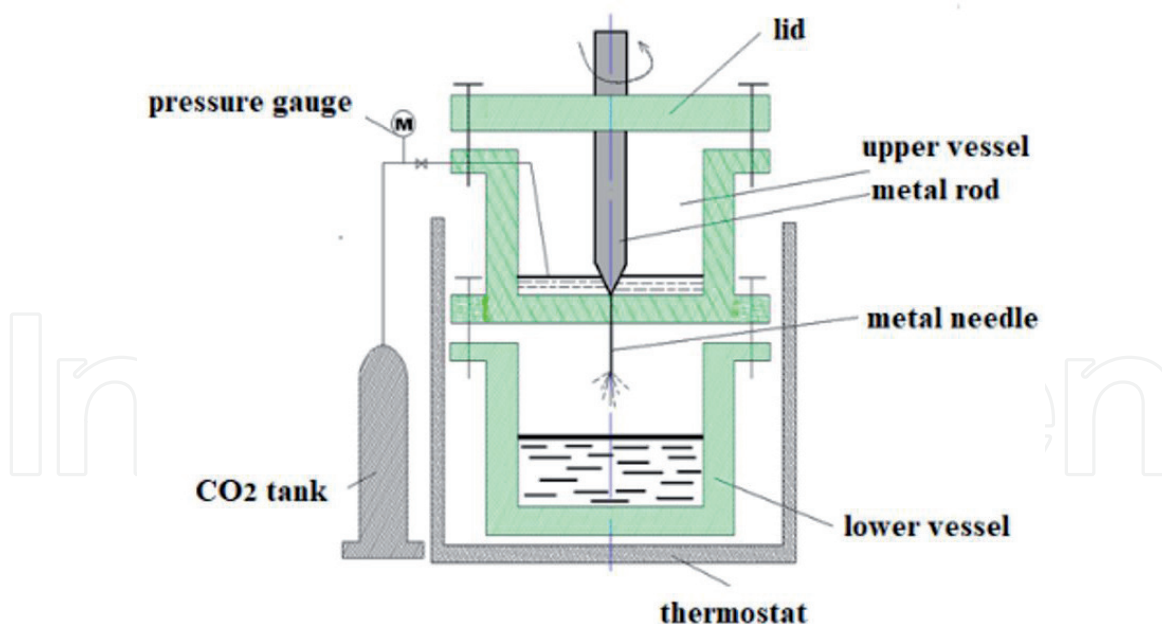

Figure 2.
Experimental setup for RESS technique.

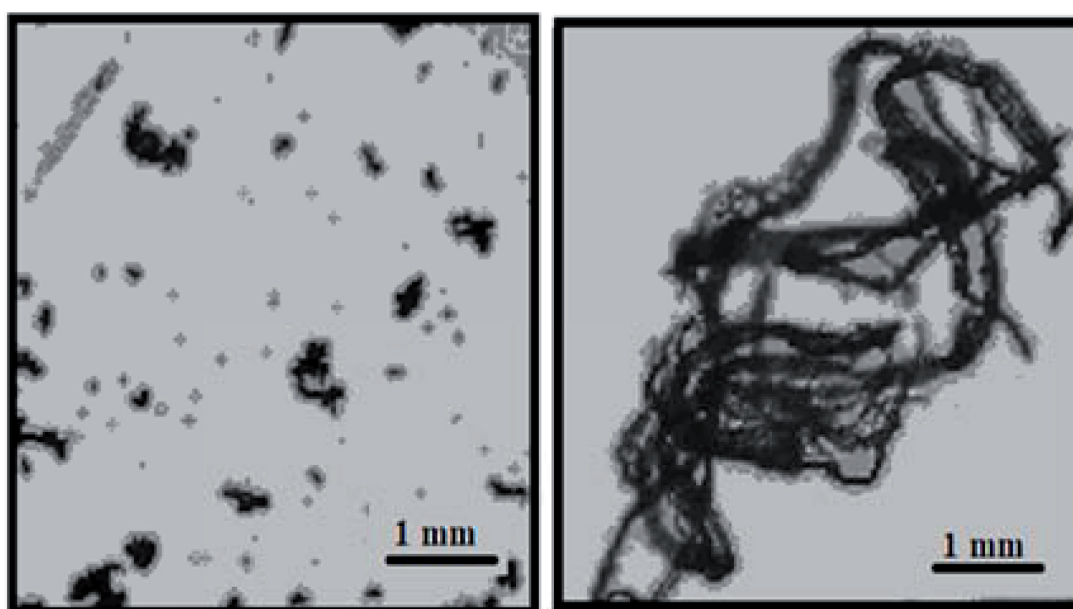

Figure 3.
Optical images of CO₂-chitosan (chi)/bis-(2-ethylhexyl) sulfosuccinate (AOT) microparticles and wires.

diameter. The pre-expansion pressure was 1–5 MPa, and the distance from the nozzle tip to surfactant solution interface was of about 20 mm. We observe that with increasing the spraying pressure of polymer, the size of the particles decreases. The microparticles obtained at high pressure are quasi-spherical in aqueous medium and irregular with many pores and a rough surface after freeze-drying. The morphology of synthesized particles recommends them for possible applications in adsorption of organic and inorganic substances from aqueous medium. The Chi/AOT microparticles were an effective adsorbent for removal of phenol and o-cresol from aqueous solution [15].

Porous alginate matrices were obtained using sub- and supercritical carbon dioxide. Calcium alginate matrices had uniform porous texture generated by high-pressure CO₂ as foaming agent without co-solvents. Sodium alginate solutions were processed in high-pressure CO₂, with freezing. After depressurization, the frozen

samples were ionically cross-linked with calcium ions with and without glycerol. The effects of the presence of glycerol as plasticizer, carbon dioxide pressure, temperature, and processing time (20 minutes and 5 hours) on the structure of the obtained calcium alginate matrices were investigated. The porosity of alginate matrices increased with CO₂ pressure, processing time, and glycerol adding. The plasticizer, glycerol, improves mechanical properties and texture for scaffolds.

Poly(ϵ -caprolactone) is another polymer with potential application in the biomedical field due to its properties such as good solubility, low melting point (59–64°C), and very good blending compatibility. PCL is suitable for controlled delivery of drug because it has high permeability for several drugs and excellent biocompatibility and it can be completely eliminated from the body. Due to the low melting point and good rheological and mechanical properties, PCL can be used as a biomaterial in cardiovascular and bone tissue engineering.

Microparticles of poly(ϵ -caprolactam) were obtained by rapid expansion in water of the PCL polymeric solution (with a cosolvent, methanol or dimethylformamide) saturated with high-pressure carbon dioxide, in experimental setup presented in **Figure 3**. The solution was denoted by P1 – PCL in methanol (1 g/mL) and P2 – PCL in dimethylformamide (1 g/mL). The working temperature was 70°C and pressure 6.5 and 8.5 MPa. In **Table 1** and **Figure 4**, values for pressure are expressed in bar. Depending on the nature of the cosolvent, temperature, and pressure, poly(ϵ -caprolactam) particles of spherical shape and variable dimensions (particles diameter 1.4–6.7 μ m) were obtained.

The morphological changes of PCL solutions in sub- and supercritical carbon dioxide and the addition of cosolvent were revealed by Boethius microscopy.

The interactions between CO₂ and the carbonyl groups in the PCL molecules led to the lower melting temperature of the P1 and P2 samples treated with sub- and supercritical CO₂ (**Table 2**).

The presence of high-pressure CO₂ influences the stretching vibration in the group C=O (carbonyl). For P1, once the carbon dioxide pressure increases, the maximum absorption of the carbonyl group moves to higher values than P2 where the maximum absorption decreases with increasing pressure. This displacement reaches a limit at the highest pressures as a result of increased carbon dioxide mobility. The integral area of the carbonyl peak decreases linearly with increasing pressure for the P1 system (data consistent with those in the literature) and varies

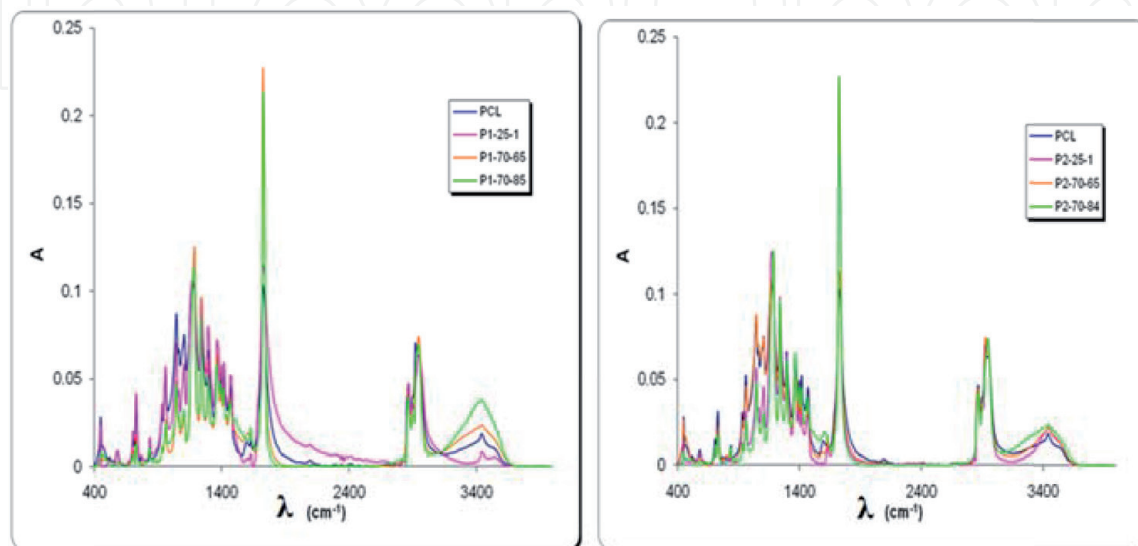

Figure 4.
FTIR spectra for PCL, P1, and P2 and different temperatures and pressures.

System	Melting point (°C)	Observations
PCL	60.3–61.9	White crystals
P1-25-1	55.8–57.5	White crystals
P2-25-1	57.1–58.9	White crystals
P1-70-85	55.5–57.6	Amorphous
P1-70-65	58.7–59.8	White crystals
P2-70-85	58.4–60.3	White crystals
P2-70-65	57.0–59.3	Amorphous

Structural changes of PCL were evidenced by the FTIR technique (Figure 4).

Table 2.
 Melting point of high-pressure samples of PCL.

nonlinearly for the P2 system. It has been observed that with the decrease of carbon dioxide pressure, the frequency of the C-O-C stretching vibration moves to higher values. At higher temperatures (70°C) and higher pressures (6.5 and 8.5 MPa), the polymer melts and recrystallizes after expansion in a semicrystalline or amorphous state, resulting in melting temperatures below PCL. For the samples treated at high pressures, we observe a shift of the maximum attributed to the crystallinity to smaller wave numbers, so a decrease of the crystallinity produces a decrease of melting temperature for the PCL samples treated under high-temperature and high-pressure conditions.

3. Drug encapsulation using scCO₂

In the last decade, drugs loaded in porous biodegradable polymeric foams have found to have important applications in tissue engineering and delivery systems. These polymeric porous scaffolds with an open-pore structure can ensure and increase seeding, attachment, growth of cells, extracellular matrix production, vascularization, and tissue growth. Supercritical CO₂ is an excellent choice to produce impregnated polyester foams in a one-step process creating porosity, without residual solvent in the products. After polymer scaffold degradation, obtained tissue would not contain synthetic polymer. The rate degradation of the scaffold should be similar or slower than the rate of tissue formation; therefore, it is important to elucidate the mechanism of this degradation process.

Some examples of polymers used as porous scaffolds were poly(D,L-lactide) (PLA) and poly(D,L-lactide-co-glycolide) (PLGA), respectively, and poly(methyl methacrylate), PMMA, PMMA/poly(ε-caprolactone), PCL, etc. Such polymers are harmless to the growing cells and can be removed from the organism by normal metabolic pathways. They also can be used in other in vivo applications, such as resorbable sutures [16].

Encapsulation of drugs within colloidal-sized polymeric matrix is largely used to improve the sustained release, reduce the side effect of the drugs, and increase the bioavailability of the drug from the pharmaceutical formulations. Polymeric beads for the controlled release of the drugs are most often used as the best solution due to easy preparation procedure and high drug-loading efficiency.

The special properties of scCO₂ made it a good transport vector for solid matrix impregnation. This process depends on the partition of interest substance between the supercritical fluid phase and matrix (such as porous polymers) used for impregnation. First the substance is mixed with high-pressure carbon dioxide and then is

placed in contact with matrix used as support. Because scCO_2 has a good diffusion capacity into porous scaffolds, inducing a swelling and/or plasticization, impregnation of a lot of materials could be possible. Among them were polymers as swellable matrices or silica as non-swellable matrices [17].

The controlled release of the very hydrophilic drugs is still a challenge due to the difficulties to encapsulate the drug in a suitable drug delivery system able to control the rate of the release and to ensure a minimum retention of the active substance inside the pharmaceutical vehicles, but with a good control of the particle size and surface properties, nanoparticles may be directed to specific sites for targeted drug delivery.

The encapsulation of active substances can be improved by impregnation in the presence of compressed fluids like carbon dioxide [18], at temperatures and pressures near or above critical point (CO_2 , $p_{cr} = 7.382 \text{ MPa}$; $t_{cr} = 31.04^\circ\text{C}$).

In a typical experiment in our laboratory, 2-pyridinealdoxime methochloride (PAM) was chosen as a hydrophilic drug model, with a high solubility in water. PAM is an acetylcholinesterase reactivator used as an antidote in poisoning with organophosphoric substances characterized by high solubility in water. Due to its hydrophilicity, PAM is rapidly eliminated from the body. Consequently, PAM is relatively short acting, and repeated doses may be needed. The encapsulation of PAM in alginate beads (used as sustained drug release system) was tested.

Alginate is a water-soluble linear polysaccharide extracted from brown seaweed, and it is composed of alternating blocks of 1–4 linked α -L-guluronic (G) and β -D-mannuronic (M) acid fragments. Alginate is a biocompatible and a hydrophilic biopolymer. These properties and its relatively low cost have recommended it for pharmaceutical applications [19]. The anionic biopolymer has the ability to bind multivalent cations, leading to the formation of insoluble hydrogels with “egg box”-type structure [19]. In the formation of water-insoluble gels, a specific interaction occurs between calcium ions (Ca^{2+}) and $-\text{COO}^-$ and $-\text{OH}$ groups of the guluronic acid fragments in a simple procedure of dripping a sodium alginate aqueous solution into a calcium chloride solution [20]. The drug can be encapsulated in alginate beads by two methods. A first method consists in dripping the aqueous solution of alginate/PAM mixture in calcium chloride solution. The deficiency of this method is the elimination of PAM outside the beads during the ionically cross-linking of alginate with calcium ions. A second method consists in immersing and soaking the polymeric beads into the solution of drug. In this case the impregnation efficiency is low.

A certain number of calcium alginate beads were immersed in the $3 \times 10^{-3} \text{ wt}\%$ solution of PAM. The impregnation of PAM in calcium alginate beads was carried out in a high-pressure cell, in the presence of compressed carbon dioxide. The impregnation was performed at different pressures (2.5, 5.0, 7.5 MPa) and temperatures (20, 40, 60°C) and also at atmospheric conditions (0.1 MPa, 20°C). The impregnation time was 30 minutes. The samples are designated p/t , where p and t represent the pressure and the temperature of impregnation.

The efficiency of PAM impregnation at various temperatures and pressures is presented in **Figure 5**.

The results showed that the efficiency of PAM impregnation increases with temperature at 2.5 MPa and the interaction between the cationic drug and active sites of biopolymer are favored by high pressure. Both state parameters influence the encapsulation of the ionic drug in the polymeric beads. The encapsulation of PAM in calcium alginate beads at 2.5 MPa depends on temperature. Adsorption or/and absorption of PAM are the main processes which take place between 20 and 40°C . At 60°C , the dissociation constants of polyelectrolyte and ionic drug increase and electrostatic interactions between the polymer and drug molecules are promoted. At higher pressure (5.0 and 7.5 MPa), the impregnation efficiency varies in the same way like ratio of CO_2 density to viscosity versus temperature and pressure.

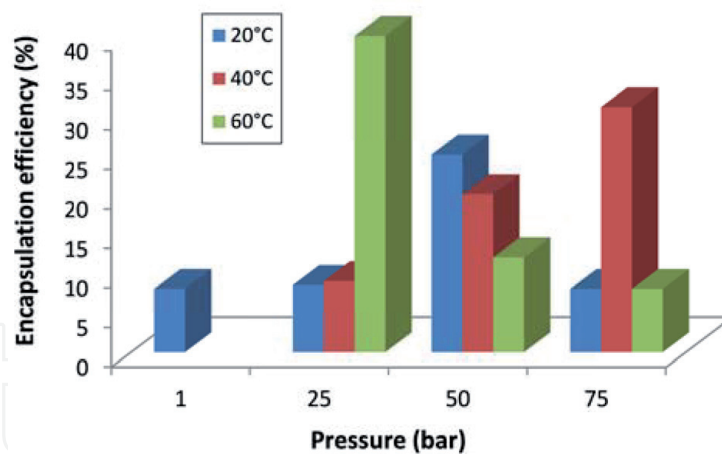

Figure 5.
 Efficiency of encapsulation of PAM in alginate microbeads at different pressures and temperatures.

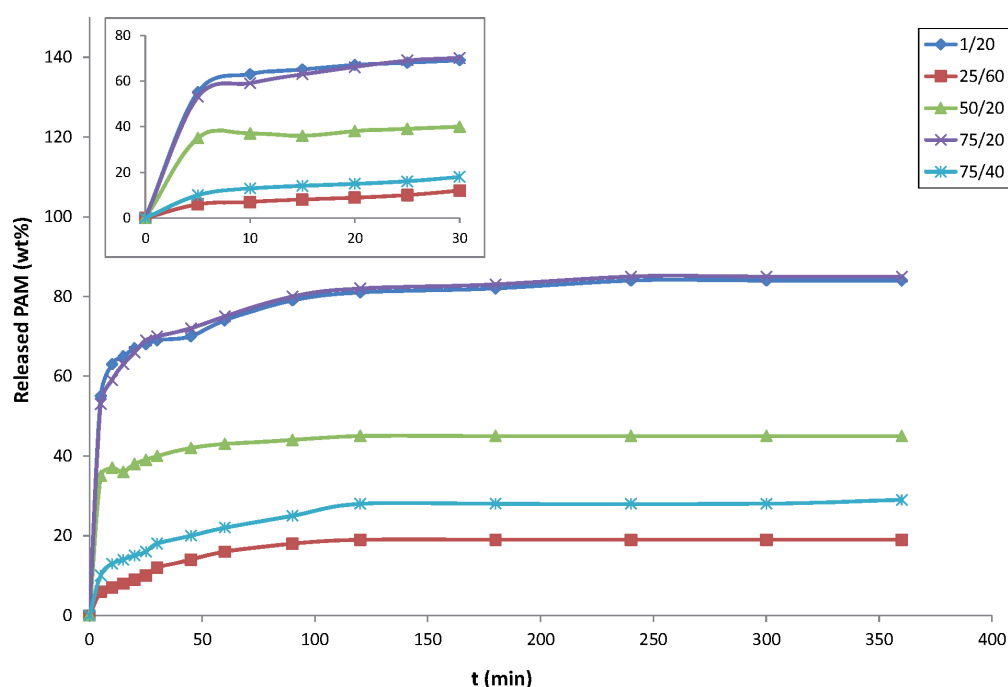

Figure 6.
 PAM release profiles from impregnated alginate beads; inset, the release curves in the first 30 minutes.

3.1 In vitro release studies

The release curves for sample 1/20 and for samples with higher encapsulation efficiency are presented in **Figure 6**. The release curves for samples 0.1/20, 7.5/20, and 5.0/20 show a “burst effect”; the encapsulated PAM is released in the first 15 minutes. The sustained release of PAM is observed for samples 7.5/40 and 2.5/60. The maximum amount of released PAM is lower than 50% for samples 7.5/40, 2.5/60, and 5.0/20. The observed initial burst release profiles may be an indication that the impregnated drug was mainly located at the polymer surface for the sample impregnated with PAM at 20°C and different pressures. The kinetic data were fitted by first-order, Weibull, and Korsmeyer-Peppas kinetic equations. The experimental concentration values of the active substance released as a function of time were processed for establishing the release kinetics.

The kinetic parameters offer information about the encapsulation mechanism which can take place by adsorption on the surface of the beads or by interactions

between drug and polymer inside the alginate beads. The PAM release curves show that the release mechanism depends on the drug impregnation conditions.

The encapsulation of PAM in alginate beads was improved by impregnation in the presence of compressed carbon dioxide at high temperature. The release of ionic drug from drug delivery beads obtained by impregnation of PAM in supercritical CO_2 (7.5 MPa, 40°C) is controlled by diffusion of active substances. The alginate beads with encapsulated PAM in subcritical conditions (7.5 MPa, 40°C) release PAM according to swelling and erosion of an amorphous biopolymer.

The release of PAM from alginate beads can be controlled by changing the initial conditions of impregnation in the presence of CO_2 .

4. Synthesis of nanoparticles in scCO_2 -based microemulsions

Nanoparticles with tunable size and high monodispersity present great interest for biomedical application, in particular to be used in bioimaging or as drug delivery systems. Synthesis of inorganic and organic NPs in scCO_2 as green alternative to the physical and chemical traditional methods suffer from the same difficulties in controlling the nanoparticle growth step and to ensure narrow size distribution of the final product. One of the most efficient routes developed to fabricate monodisperse nanoparticles is the synthesis performed in heterogeneous media, i.e., in microemulsions or in blue emulsions, in order to ensure the nucleation and growth of nanoparticles in the restricted domain of liquid nanoreactors (oil or aqueous droplets). Microemulsions, as liquid-liquid colloidal systems consisting of nanometric droplets with size ranging from few nanometers to 100, stabilized with surfactant and cosurfactant mixture, are considered the most suitable reaction media for the synthesis of organic and inorganic nanoparticles with tunable size and morphology. Oil-in-water microemulsions are usually used for the fabrication of hydrophobic polymeric nanoparticles, while water-in-oil ones are used as reaction media for inorganic nanoparticles, especially for metal NPs obtained from reduction of metallic salt. All advantages of the controlled synthesis in water-in-oil microemulsions could be preserved using water-in scCO_2 microemulsions, since the general structure of the colloidal system is the same (**Figure 7**).

However, the stabilization of miniemulsions and the formation of thermodynamically stable microemulsions in supercritical CO_2 are challenging tasks, due to the specific properties of carbon dioxide. Supercritical carbon dioxide possesses peculiar properties such as very high diffusivity and low viscosity, different from usual oily phases in the microemulsion composition; thus special requirements are

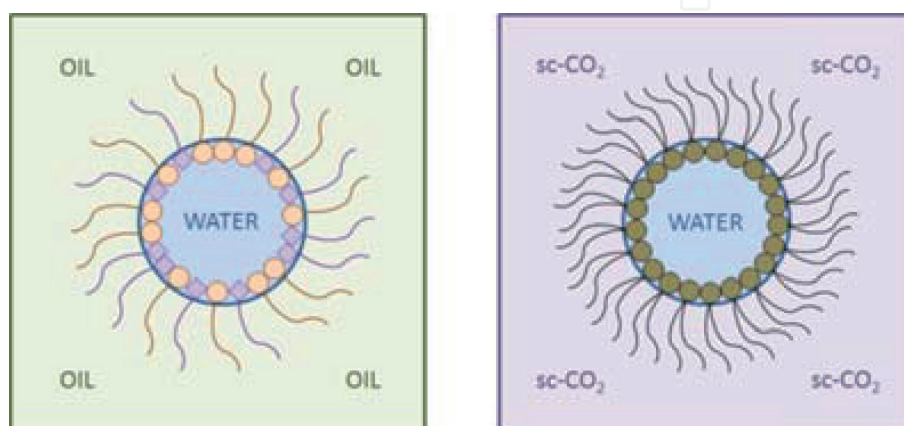

Figure 7. The schematic view of structure and stabilization of water droplets in W/O and W/ scCO_2 microemulsions.

needed for the surfactants that enable the formation of W-in-scCO₂ microemulsion: (i) enhanced absorbability at water/scCO₂ interface, (ii) enhanced surface activity in lowering water/scCO₂ interfacial tension, and (iii) strong repulsive interaction (steric effect) between CO₂-philic groups, which reduces the probability of droplet aggregation and leads to the stabilization of microemulsion [21].

Many researches have been performed addressing the problem of surfactant solubility in supercritical and dense CO₂, in order to evidence their ability to stabilize water-in-CO₂ microemulsions, and surfactants with special designed molecular structure were synthesized for this purpose [21].

The early studies [22] conclude that conventional theories in molecular design for surfactant with superior efficiency in lowering interfacial tension at W/O interfaces are inapplicable to the W-scCO₂ ones, because CO₂-philicity could not be directly compared with oleophilicity. Considerable efforts have been made to find the most favorable chemical structures able to ensure adequate solubility of the surfactant in supercritical CO₂, together with better adsorption at W-scCO₂ interface. Highly branched hydrocarbon surfactants were found to possess good solubility, but unfortunately they are not efficient enough as stabilizer, compared to AOT sodium salt, a commercially available cost-effective common surfactant widely used for the formulation of water-in-oil microemulsions. The typical surfactants exhibit very different Hildebrandt solubility parameters for carbon dioxide; thus their solubility in CO₂ is very low, explaining their lack in stabilizing supercritical CO₂ emulsions and microemulsions.

Based on the data evaluated [22], an interesting family of surfactants were synthesized as AOT analogues AO-VAc bearing vinyl-acetate oligomeric chains and AOK bearing *t*-butyl and carbonyl groups, grafted to promote CO₂-philicity. Those syntheses are very demanding, and the difficult fabrication of industrial scale quantities limits the extension of the new compounds in application such as preparation of W/scCO₂ microemulsions as reaction media. Sagisaka et al. [23] conducted a systematic study on the influence of the hydrophobic tail structure on the efficiency of fluorinated surfactants to stabilize water-in- supercritical CO₂ microemulsions. Since anionic hydrocarbon surfactant AOT sodium salt is the most successful surfactant in obtaining W/O microemulsions, fluorinated surfactants with similar structures were investigating, and the results suggest that fluorinated analog bis(1*H*,1*H*,2*H*,2*H*-heptadecafluorodecyl)-2 sulfosuccinate sodium salt is the most effective in the formulation of water-in-scCO₂ microemulsion, allowing a water solubility up to W^c₀ = 32 (W^c₀ is the maximum water-to-surfactant molar ratio in W/O or W/scCO₂ microemulsions).

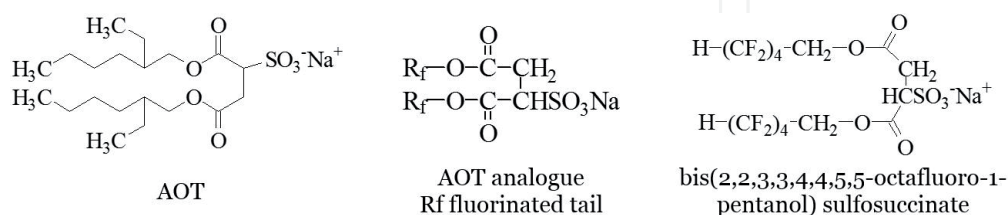

In order to increase the region of microemulsion in the phase diagram of the water-supercritical CO₂-surfactant system, novel amphiphilic compounds were synthesized with a more flexible molecule due to the presence of linkers. A series of fluorocarbon derivatives having different fluorocarbon chain lengths F(CF₂)_n with n = 4,6,8, and 10 and oxyethylene groups (CH₂CH₂O)_{m/2} (where m = 2 and 4) introduced into the molecule as spacers were developed [23]. The analysis of phase diagram of quaternary systems water-scCO₂-*n*FS(EO)_m surfactants suggests that an

optimum length of the fluorocarbon tail is required for the formation of W/scCO₂ microemulsion with increased amount of water included. The maximum water/surfactant ratio W_0 is obtained for the CO₂-philic tail with 12–14 Å length, corresponding to the surfactants with eight carbon atoms and two oxyethylene groups or six carbon atoms and four oxyethylene groups.

These fluorinated surfactants with specific chemical structure are quite difficult to obtain, and their use is restricted in the “green chemistry” methods due to the high toxicity. In this respect, other classes of surfactants were investigated, in particular polymeric derivatives. Block copolymers have been extensively studied regarding their ability to act as stabilizer of water droplets in scCO₂ since J. de Simone reports for the first time in 1994 the solubility of fluorinated polymers in liquid and scCO₂. Chemicals such as fluoropolymers, polysiloxanes, and some poly(vinyl esters) derivatives prove to be CO₂-philic polymers but with reduced surface activity. In the last decades, the progresses in the synthesis techniques allow the fabrication of a large variety of block copolymers with CO₂-philic moieties and specially designed structures, such as amphiphilic block, amphiphilic comb copolymers, or gradient copolymers bearing linear or branched chains, such as poly(1,1,2,2-tetrahydroperfluorooctyl methacrylate)-based copolymers with either poly(N,N-dimethylaminoethyl methacrylate) (PDMAEMA) or poly(oligo(ethylene glycol) methacrylate) (POEGMA) as hydrophilic blocks or 1,1,2,2-tetrahydroperfluorodecyl tetrahydroperfluorodecyl acrylate and vinyl benzoic phosphonic acid [24]. A remarkable strategy to enhance the surfactant efficiency in scCO₂ media is based on the synergistic effect obtained by ion-pairing cationic and anionic surfactants. Sagisaka et al. [25] report the properties of short tail, unbranched fluorinated surfactants with sulfate ionic groups and their cationic analogues synthesized by Verdia [26].

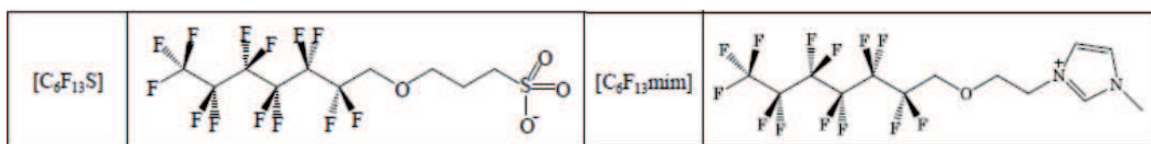

Individual compounds, for example, [C₆F₁₃S] and [C₆F₁₃mim], both exhibit very low solubility in CO₂ and produce limited water solubility; even in water they have modest surface activity. The anionic and cationic pair of surfactants with similar hydrophobic tail used together in adequate molar ratio produces a spectacular synergistic effect, which enable the formulation of water-in-scCO₂ microemulsion with significant water content (W_0 max up to 50).

Metal nanoparticles (Ag, Au, and Cu) are particularly interesting for many industrial applications, due to their size- and shape-dependent unique optic and electric properties. In the last decades, applications of metal nanoparticles in nanomedicine, in emerging fields such as in vivo bioimaging, innovative cancer therapy, and diagnostics evolve in solution with enormous positive impact in the health-care system. The large-scale applicability of these nanomaterials is still restricted due to the concern about their intrinsic biocompatibility and the difficulties to remove toxic residual precursors and solvents during the synthesis, in particular regarding synthesis in W/O microemulsion as heterogeneous reaction media. Thus, new methods to synthesize metal or metal oxide nanoparticles using “green chemistry” approach as alternative to classic technologies have been investigated. The first reported synthesis of silver nanoparticles in CO₂ microemulsion was reported in the late 1990s. The results were promising in terms of the quality of the nanopowder obtained, with additional advantage of fine-tuning the nanoparticle size. W/O microemulsions, as heterogeneous reaction media allow the synthesis of

nanoparticles with desired average size through the specific mechanism of precipitation in arrested environment, are defined by the water droplets. The radius of the water nanoreactor could be tuned in a facile way by changing water/surfactant ratio (W_0^c) in the composition of microemulsion. Fernandez et al. [27] demonstrated that the use of $scCO_2$ microemulsion as reaction media exhibits additional advantage in continuous tuning of the Ag nanoparticle size. The nanoparticles were prepared in $scCO_2$ microemulsion with different water/surfactant molar ratios (W_0^c), that is, different water nanopool dimensions, stabilized with surfactant AOT fluorinated analogue at 10 mM concentration. The change of fluid phase density is obtained by simply adjusting temperature and pressure conditions. For the $scCO_2$ microemulsion with lower water content ($W = 6$) very fine tuning was achieved, producing silver nanoparticles with average size ranging from 1.9 to 9.3 nm for a variation of density from 0.96 up to 0.80 g/mL.

The same strategy is used to obtain tunable size of quantum dots, cadmium sulfide and zinc sulfide [28]. Similarly, Cu nanoparticles have been obtained [29] by reduction of the copper precursor (copper nitrate) dissolved in the water droplets of microemulsion after injection of CO_2 -soluble reducing agents such as *N,N,N,N*-tetramethyl-*p*-phenylenediamine or sodium cyanoborohydride. The $scCO_2$ microemulsion used as reaction media was formulated with a mixed surfactant system consisting in 12.8 mM AOT and 25.3 mM fluorinated derivative (perfluoropolyether-phosphate) at a water-to-surfactant ratio $W([H_2O])/[AOT] = 12$. Nanoparticles with average size of 5–15 nm were obtained, according to the type of the reduction agent and rate of the reagent addition.

Polymeric nanoparticles could also be obtained through polymerization processes in $scCO_2$ microemulsion, using adapted strategy from emulsion/microemulsion polymerization with common oily phases. The preparation of polyamide nanoparticles was reported by Ohde et al. [30], using a $scCO_2$ microemulsion stabilized with a mixture of commercially available hydrocarbon and fluorinated surfactants (AOT and perfluoropolyether-phosphate PFPE- PO_4). The NPs were prepared by using polymerization of acrylamide monomer in the presence of potassium persulfate, both dissolved in the water core of $scCO_2$ microemulsions with identical composition. The reaction is performed in homemade interconnected high-pressure vessels that allow the equilibration of separate $scCO_2$ microemulsions containing monomer and initiator and mixing them at the desired time. The polymerization was completed very quickly, in less than 1 minutes at 25°C, 20 MPa, and in less than 30 s at 50°C, 15 MPa.

Metallic nanoparticles deposited on the surface of the graphenes or carbon nanotubes are hybrid material with particular interest in various domains, for example, catalysis, energy saving, modified electrodes in biosensing, etc. The classic methods employed suffer from various drawbacks, from high amount of organic reagents to the lack of dimension control. Deposition of metal nanoparticles on the carbon nanotubes using $scCO_2$ microemulsion as reaction media was proposed as green alternative to wet chemistry or other technologies of deposition using physical methods.

Shimizu et al. [31] report the preparation of hybrid electrocatalyst consisting in Pt NPs deposited on multiwalled carbon nanotubes in three different media: water-in-supercritical CO_2 microemulsion, supercritical CO_2 fluid, and water-in-hexane microemulsion.

As it is shown in **Figure 8**, the reaction in $scCO_2$ microemulsion leads to a better dispersion of Pt NPs on the surface of nanotubes that is obtained in homogeneous $scCO_2$ phase and conventional W/O microemulsion.

Among the many techniques of processing and synthesis in fluid carbon dioxide phases, the use of water-in- $scCO_2$ microemulsions is one of the most effective in

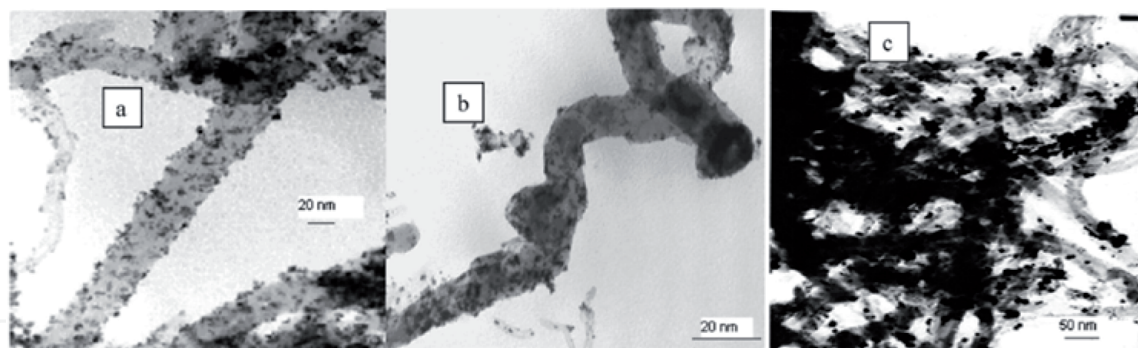

Figure 8. TEM images of hybrid catalyst Pt-CNT synthesized in various media by (a) water-in-supercritical CO_2 microemulsion, (b) water-in-oil microemulsions, (c) direct deposition in supercritical CO_2 (adapted with permission from ref. [31]).

terms of control on the size, size distribution, and shape of the final product. The stabilization of such reaction media with low amount of affordable and nontoxic surfactants remains the major bottleneck and limits the extension of this method.

5. Functionalization of nanoparticles in scCO_2

The modification of nanoparticle surfaces, either in solutions or as layers deposited on various surfaces, is a key issue in many processes to fabricate functional materials, in many applications. Commonly used methods for the modification of nanoparticles such as quantum dots, graphene, metallic nanoparticles, etc. are based on solution processing involving organic solvents, which makes the whole process very difficult to implement as eco-friendly technology. For biomedical applications in particular, the proper functionalization of the surfaces in synthesis that involve green solvents is particularly encouraged. Industrial or large-scale processes for the modification of surfaces by vapor-related physical methods suffer from huge limitations due to the high-cost and energy-consuming devices. On the other hand, liquid-related chemical methods have an additional drawback: the solvent removal after the reaction is completed on the targeted surface. Due to the variety of roles that can be attributed to carbon dioxide, i.e., solvent, antisolvent, reaction medium, respectively, unique flexibility for surface engineering is obtained using scCO_2 .

A variation of RESS method can be applied for coating processes, with the condition that coating material dissolves in scCO_2 . The solution is introduced via a nozzle in another chamber that contains the solid support to be functionalized. During the rapid depressurization, the density of CO_2 changes significantly, and consequently a supersaturation followed by precipitation of the material forming a coating occurs. For example, superhydrophobic coatings on paper were obtained from alkyl ketene dimer (AKD) dissolved in scCO_2 by this modified RESS technique.

Surface modification of silica particles with organomodified silane derivatives for highly hydrophobic films has been reported by Purcar et al. [32]. The formation of silica nanoparticles using sol-gel synthesis in various conditions of temperature and pressure of CO_2 was investigated, both in subcritical and supercritical phases. Tetraethoxysilane (TEOS) was used as the particle precursor and octyltriethoxysilane (OTES) as the co-precursor for coating. The dynamic light scattering measurements show that the higher CO_2 pressure leads to larger diameters of coated particles. The agglomeration of the silica nanoparticles was found to be dependent

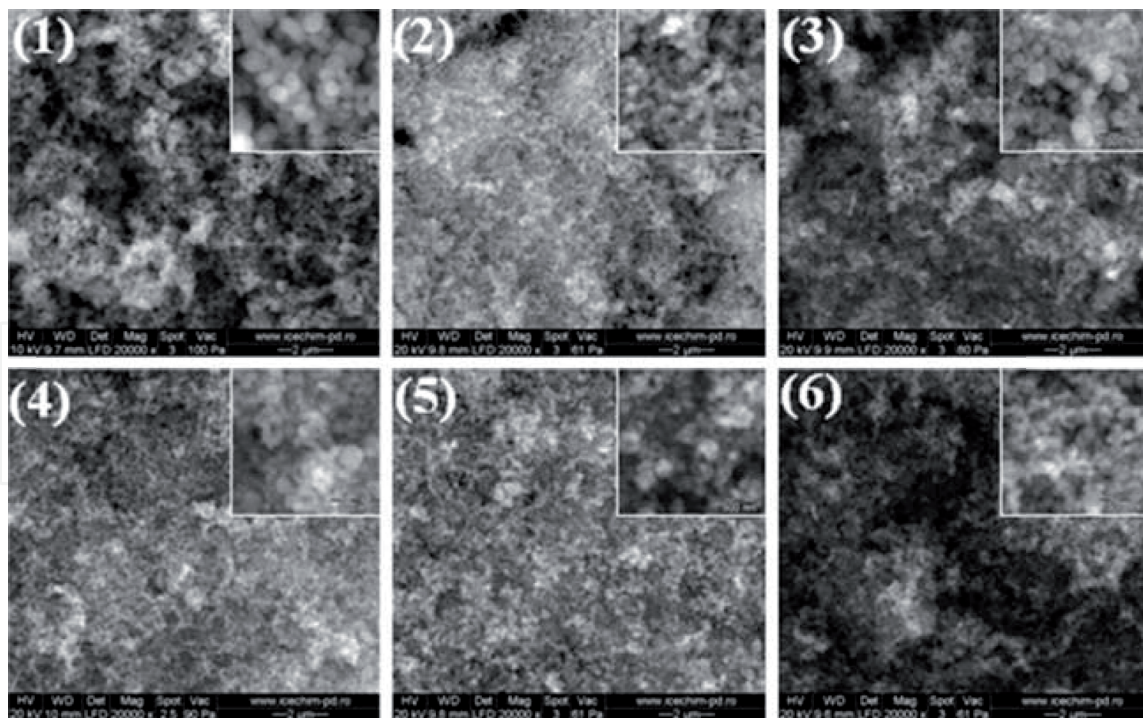

Figure 9. SEM images of coated silica nanoparticles prepared in CO₂ in various conditions of temperature and pressure. (1 = 25°C, 6 MPa; 2 = 40°C, 6 MPa; 3 = 60°C, 6 MPa; 4 = 25°C, 7.5 MPa; 5 = 40°C, 7.5 MPa; 6 = 60°C, 7.5 MPa). Reprinted with permission from Ref. [32].

on the temperature and pressure of the CO₂ reaction media. The SEM images confirm the tendency of aggregation and differences in the size of silica nanoparticles coated with octyl-modified derivative (**Figure 9**).

The size of the resulting silica particles is around 100–250 nm when the CO₂ pressure is 6 MPa and decreases up to 150 nm when the CO₂ pressure increases to 7.5 MPa. It was observed that the higher CO₂ pressure gives narrower size distributions. The thin films obtained by the as-prepared silica nanodispersions deposited on glass substrate show high contact angle values, ranging from 127 to 145°.

The NP processing using scCO₂ as solvent leads not only to the adequate modification of the surface but, sometimes, also to the decrease of the aggregates and better dispersibility and interaction with polymeric matrix. Wei et al. [33] reported recently the silane modification of graphene nanoparticles for the fabrication of composite polymeric films with superior barrier properties. The obtained graphenes functionalized with silane exhibit a fluffy appearance with small size of sheets. The graphene surface was silanized through the hydrolysis and condensation of different organomodified silane derivatives: aminopropyl triethoxysilane, glycidylxypropyltrimethoxysilane, and methacryloxy propyl trimethoxysilane. The reaction was conducted in scCO₂ for 2 hours at 40°C and 20 MPa. The successful formation of SiO₂ coating on graphene sheets was proven by FTIR spectra and thermogravimetric analysis and supports the enhanced dispersibility of modified GNs in polymeric membrane, together with a significant exfoliation.

Nanoparticle surface functionalization with polymeric shells is an important issue in preparation of biocompatible colloidal vectors in drug delivery that allow further attachment of bioactive ligands. The transfer of such synthesis in scCO₂ for the functionalization of nanoparticles used as drug delivery systems in pharmaceutical formulations benefits from the absence of many posttreatment steps that are generally required to remove remaining solvents or undesirable by-products generated in wet chemistry methods. Marre et al. [34] demonstrated the feasibility

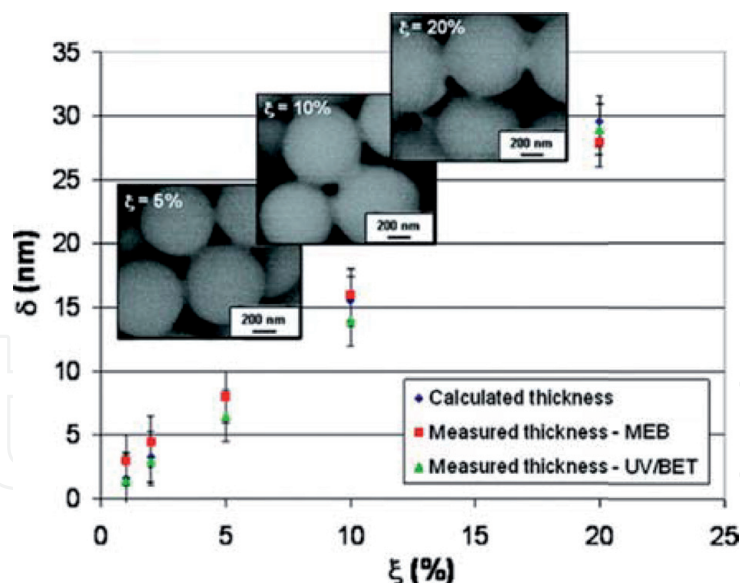

Figure 10.

The variation of polymeric shell thicknesses on nanoparticles as a function of the initial mass fraction of polymer in the initial solution (reprinted with permission from ref 34).

of a versatile method for coating silica particles used as model substrates, with either a hydrophilic (polyethylene glycol PEG) or hydrophobic polymer (hydroxyl-terminated polybutadiene, HTPB) using a supercritical antisolvent process (**Figure 10**).

The principle of the precipitation from compressed antisolvent PCA techniques is allowing the contact of the polymeric solution with the scCO_2 as antisolvent, when a succession of different phenomena governed by hydrodynamic, precipitation kinetics, thermodynamic, and mass-transfer effects result eventually in the precipitation of an organic shell on the nanoparticles dispersed previously in the polymeric solution. According to the polymer used (PEG or PBHT) and the reaction conditions, various sizes of the deposited polymeric shell have been obtained, from 3 to 28 nm, by simply modification of polymer concentration in the initial solution (**Figure 10**).

In order to effectively exploit the advantages of “green” processing in scCO_2 , Roy et al. describe the successful grafting of a model drug (salicylic acid, SA) on TiO_2 nanoparticles [35]. The chosen active compound could react with the nanoparticle surfaces through the carboxylic and hydroxyl groups. The functionalization of the TiO_2 surface was performed in mild conditions, at 40°C and 16 MPa for a short period of time, up to 2 hours. The thermogravimetric analysis shows a calculated amount of drug SA deposited on TiO_2 nanopowder of approximately 8 wt%, and the SEM images of coated samples do not reveal rod-like crystals specific for solid salicylic acid, which confirm the absence of residual drug other than the coating deposited on nanoparticles.

In the last decades, methods to perform functionalization of nanoparticles using scCO_2 were reported, as viable alternative to classical synthesis and showing remarkable advantage of reduced impact on the environment.

6. Conclusion

The recent works in supercritical fluids demonstrate the multiplicity of advantages in synthesis of nanomaterials, either organic or inorganic. Complex synthesis of hybrid materials consisting in nanoparticles deposited on other structures (carbon nanotubes) or core-shell nanoparticles was also developed in scCO_2 .

An important problem that requires further research, especially for fine-tuning the nanoparticle size, is design and fabrication of CO₂-philic surfactants that enable the formation of water-in-scCO₂ microemulsion as reaction media. The successful synthesis of nontoxic and cost-effective surfactants will open the opportunity to extend this method to many nanoparticles used as drug delivery vehicles, where the size and size distribution control are a key issue.

Another domain which is expected to benefit from further research in order to advance this technology is the development of novel strategy for surface functionalization, especially for scalable processes.

Acknowledgements

This work was supported by grants of the Romanian National Authority for Scientific Research and Innovation, CCCDI - UEFISCDI, project number PN-III-P1-1.2-PCCDI-2017-0743/P5, and PN-III-P1-1.2-PCCDI-2017-0428/P2 within PNCDI III.

Conflict of interest

The authors have no conflict of interest to declare.

Nomenclature

p	pressure, MPa
T	temperature, K
t	time, s
W	maximum water content in microemulsion, expressed as water-to-surfactant molar ratio [H ₂ O]/[surfactant]
δ	polymeric shell thicknesses on nanoparticles, nm
λ	wavelength, cm ⁻¹
ξ	initial mass fraction of polymer, %
cr	critical

Acronyms

AKD	alkyl ketene dimer
AOT	sodium bis-(2-ethylhexyl) sulfosuccinate
Chi	chitosan
DESAM	depressurization of an expanded solution into an aqueous medium
DSC	dynamic light scattering
FTIR	Fourier-transform infrared spectroscopy
GNs	graphene
NPs	nanoparticles
OTES	octyltriethoxysilane
PAM	2-Pyridinealdoxime methochloride
PBHT	polybutadiene hydroxy terminated
PCL	poly(ϵ -caprolactone)
PDMAEMA	poly(N,N-dimethylaminoethyl methacrylate)
PEG	polyethylene glycol
PLA	polylactic acid
PLGA	poly(lactic-coglycolic)
PMMA	poly(methyl methacrylate)
POEGMA	poly(oligo(ethylene glycol) methacrylate)

RESOLV	rapid expansion of supercritical solution into a liquid solvent
RESS	rapid expansion of supercritical solution
SAA	supercritical assisted atomization
SAILA	supercritical assisted injection in liquid antisolvent
SAS	supercritical antisolvent technique
scCO ₂	supercritical carbon dioxide
SCFs	supercritical fluids
SEE	supercritical emulsion extraction
SEM	scanning electron microscopy
TEOS	tetraethoxysilane
VOC	volatile organic compound
W/O	Water-in-oil
W-scCO ₂	water-in-supercritical CO ₂

IntechOpen

Author details

Ludmila Otilia Cinteza* and Daniela Bala
Department of Physical Chemistry, Faculty of Chemistry, University of Bucharest,
Bucharest, Romania

*Address all correspondence to: ocinteza@yahoo.com

IntechOpen

© 2019 The Author(s). Licensee IntechOpen. This chapter is distributed under the terms of the Creative Commons Attribution License (<http://creativecommons.org/licenses/by/3.0>), which permits unrestricted use, distribution, and reproduction in any medium, provided the original work is properly cited. 

References

- [1] Long B, Ryan KM, Padrela L. From batch to continuous—New opportunities for supercritical CO₂ technology in pharmaceutical manufacturing. *European Journal of Pharmaceutical Sciences*. 2019;**137**:104971. DOI: 10.1016/j.ejps.2019.104971
- [2] Pfund LY, Price P, Frick JJ, Matzger AJ. Controlling pharmaceutical crystallization with designed polymeric Heteronuclei. *Journal of the American Chemical Society*. 2015;**137**:871-875. DOI: 10.1021/ja511106j
- [3] Lehocký R, Pěček D, Štěpánek F. Scale-up from batch to flow-through wet milling process for injectable depot formulation. *European Journal of Pharmaceutical Sciences*. 2016;**95**: 122-129. DOI: 10.1016/j.ejps.2016.08.043
- [4] Sinha B, Müller RH, Möschwitzer JP. Bottom-up approaches for preparing drug nanocrystals: Formulations and factors affecting particle size. *International Journal of Pharmaceutics*. 2013;**453**(1):126-141. DOI: 10.1016/j.ijpharm.2013.01.019
- [5] Campardelli R, Baldino L, Reverchon E. Supercritical fluids applications in nanomedicine. *The Journal of Supercritical Fluids*. 2015;**101**:193-214. DOI: 10.1016/j.supflu.2015.01.030
- [6] Elizondo E, Veciana J, Ventosa N. Nanostructuring molecular materials as particles and vesicles for drug delivery, using compressed and supercritical fluids. *Nanomedicine*. 2012;**7**(9): 1391-1408. DOI: 10.2217/nnm.12.110
- [7] Samei M, Vatanara A, Fatemi S, Rouholamini Najafabadi A. Process variables in the formation of nanoparticles of megestrol acetate through rapid expansion of supercritical CO₂. *Journal of Supercritical Fluids*. 2012;**70**:1-7. DOI: 10.1016/j.supflu.2012.05.011
- [8] Kalani M, Yunus R. Application of supercritical antisolvent method in drug encapsulation: A review. *International Journal of Nanomedicine*. 2011;**6**:1429. DOI: 10.2147/IJN.S19021
- [9] Campardelli R, Cherain M, Perfetti C, Iorio C, Scognamiglio M, Reverchon E, et al. Lipid nanoparticles production by supercritical fluid assisted emulsion–diffusion. *Journal of Supercritical Fluids*. 2013;**82**:34-40. DOI: 10.1016/j.supflu.2013.05.020
- [10] Porta GD, Campardelli R, Falco N, Reverchon E. PLGA microdevices for retinoids sustained release produced by supercritical emulsion extraction: Continuous versus batch operation layouts. *Journal of Pharmaceutical Sciences*. 2011;**100**(10):4357-4367. DOI: 10.1002/jps.22647
- [11] Porta GD, De Vittori C, Reverchon E. Supercritical assisted atomization: A novel technology for microparticles preparation of an asthma-controlling drug. *AAPS PharmSciTech*. 2005;**6**(3):421-428. DOI: 10.1208/pt060352
- [12] Pathak P, Meziani MJ, Desai T, Sun Y-P. Nanosizing drug particles in supercritical fluid processing. *Journal of the American Chemical Society*. 2004;**126**(35):10842-10843. DOI: 10.1021/ja046914t
- [13] Esfandiari N. Production of micro and nano particles of pharmaceutical by supercritical carbon dioxide. *The Journal of Supercritical Fluids*. 2015;**100**:129-141. DOI: 10.1016/j.supflu.2014.12.028
- [14] Venkatesan J, Anil S, Singh SK, Kim S-K. Preparations and applications of alginate nanoparticles. In:

- Venkatesan J, Anil S, Kim S-K, editors. *Seaweed Polysaccharides*. BV, Amsterdam: Elsevier; 2017. pp. 251-268. DOI: 10.1016/b978-0-12-809816-5.00013-x
- [15] Peretz S, Florea-Spiroiu M, Anghel D-F, Bala D, Branzoi F, Moreno J-C. Chitosan/anionic surfactant microparticles synthesized by high pressure spraying method for removal of phenolic pollutants. *Open Chemistry*. 2012;**10**(6):1969-1979. DOI: 10.2478/s11532-012-0126-y
- [16] Cabezas LI, Gracia I, de Lucas A, Rodríguez JF. Novel model for the description of the controlled release of 5-Fluorouracil from PLGA and PLA foamed scaffolds impregnated in supercritical CO₂. *Industrial and Engineering Chemistry Research*. 2014;**53**(40):15374-15382. DOI: 10.1021/ie404028t
- [17] García-Casas I, Crampon C, Montes A, Pereyra C, Martínez de la Ossa EJ, Badens E. Supercritical CO₂ impregnation of silica microparticles with quercetin. *The Journal of Supercritical Fluids*. 2019;**143**:157-161. DOI: 10.1016/j.supflu.2018.07.019
- [18] Manna L, Banchemo M, Sola D, Ferri A, Ronchetti S, Sicardi S. Impregnation of PVP microparticles with ketoprofen in the presence of supercritical CO₂. *The Journal of Supercritical Fluids*. 2007;**42**(3):378-384. DOI: 10.1016/j.supflu.2006.12.002
- [19] Chan LW, Jin Y, Heng PWS. Cross-linking mechanisms of calcium and zinc in production of alginate microspheres. *International Journal of Pharmaceutics*. 2002;**242**:255-258. DOI: 10.1016/S0378-5173(02)00169-2
- [20] Peretz S, Cinteza O. Removal of some nitrophenol contaminants using alginate gel beads. *Colloids and Surfaces A: Physicochemical and Engineering Aspects*. 2008;**319**(1-3):165-172. DOI: 10.1016/j.colsurfa.2007.06.012
- [21] Sagisaka M, Ogiwara S, Ono S, James C, Yoshizawa A, Mohamed A, et al. New class of amphiphiles designed for use in water-in-supercritical CO₂ microemulsions. *Langmuir*. 2016;**32**(47):12413-12422. DOI: 10.1021/acs.langmuir.6b01670
- [22] Eastoe J, Gold S, Steytler DC. Surfactants for CO₂. *Langmuir*. 2006;**22**(24):9832-9842. DOI: 10.1021/la060764d
- [23] Sagisaka M, Ono S, James C, Yoshizawa A, Mohamed A, Guittard F, et al. Effect of fluorocarbon and hydrocarbon chain lengths in hybrid surfactants for supercritical CO₂. *Langmuir*. 2015;**31**(27):7479-7487. DOI: 10.1021/acs.langmuir.5b01737
- [24] Ribaut T, Oberdisse J, Annighofer B, Stoychev I, Fournel B, Sarrade S, et al. SANS study of the self-organization of gradient copolymers with ligand groups in supercritical CO₂. *Soft Matter*. 2009;**5**(24):4962. DOI: 10.1039/B912268K
- [25] Sagisaka M, Saito T, Yoshizawa A, Rogers SE, Guittard F, Hill C, et al. Water-in-CO₂ microemulsions stabilized by fluorinated Cation-anion surfactant pairs. *Langmuir*. 2019;**35**(9):3445-3454. DOI: 10.1021/acs.langmuir.8b03942
- [26] Verdia P, Gunaratne HQN, Goh TY, Jacquemin J, Blesic M. A class of efficient short-chain fluorinated catanionic surfactants. *Green Chemistry*. 2016;**18**(5):1234-1239. DOI: 10.1039/C5GC02790J
- [27] Fernandez CA, Wai CM. Continuous tuning of silver nanoparticle size in a water-in-supercritical carbon dioxide microemulsion. *Small*. 2006;**2**(11):1266-1269. DOI: 10.1002/smll.200600222
- [28] Fernandez CA, Wai CM. Continuous tuning of cadmium sulfide and zinc sulfide nanoparticle size in a water-in-supercritical carbon dioxide

microemulsion. *Chemistry—a European Journal*. 2007;**13**(20):5838-5844. DOI: 10.1002/chem.200601259

[29] Ohde H, Hunt F, Wai MC. Synthesis of silver and copper nanoparticles in a water-in-supercritical-carbon dioxide microemulsion. *Chemistry of Materials*. 2001;**13**(11):4130-4135. DOI: 10.1021/cm010030g

[30] Ohde H, Wai CM, Rodriguez JM. The synthesis of polyacrylamide nanoparticles in supercritical carbon dioxide. *Colloid & Polymer Science*. 2006;**285**:475-478. DOI: 10.1007/s00396-006-1582-8

[31] Shimizu K, Cheng IF, Wang JS, Yen CH, Yoon B, Wai CM. Water-in-supercritical CO₂ microemulsion for synthesis of carbon-nanotube-supported Pt Electrocatalyst for the oxygen reduction reaction. *Energy & Fuels*. 2008;**22**(4):2543-2549. DOI: 10.1021/ef800052b

[32] Purcar V, Cinteza O, Donescu D, Bala D, Ghiurea M, Petcu C, et al. Surface modification of silica particles assisted by CO₂. *Journal of Supercritical Fluids*. 2014;**87**:34-39. DOI: 10.1016/j.supflu.2013.12.025

[33] Wei J, Peng S, Xue B, Yang Z, Qin S, Yu J, et al. Effect of silane functionalized graphene prepared by a supercritical carbon dioxide process on the barrier properties of polyethylene terephthalate composite films. *RSC Advances*. 2019;**9**(38):21903-21910. DOI: 10.1039/C9RA02479D

[34] Marre S, Cansell F, Aymonier C. Tailor-made surface properties of particles with a hydrophilic or hydrophobic polymer Shell mediated by supercritical CO₂. *Langmuir*. 2008;**24**:252-258. DOI: 10.1021/la702154z

[35] Roy C, Vega-González A, García-González CA, Tassaing T, Domingo C, Subra-Paternault P. Assessment

of scCO₂ techniques for surface modification of micro- and nanoparticles: Process design methodology based on solubility. *Journal of Supercritical Fluids*. 2010;**54**(3):362-368. DOI: 10.1016/j.supflu.2010.05.018

