

We are IntechOpen, the world's leading publisher of Open Access books Built by scientists, for scientists

4,800

Open access books available

122,000

International authors and editors

135M

Downloads

Our authors are among the

154

Countries delivered to

TOP 1%

most cited scientists

12.2%

Contributors from top 500 universities



WEB OF SCIENCE™

Selection of our books indexed in the Book Citation Index
in Web of Science™ Core Collection (BKCI)

Interested in publishing with us?
Contact book.department@intechopen.com

Numbers displayed above are based on latest data collected.

For more information visit www.intechopen.com



Solar Rectennas: Analysis and Design

Ahmed M.A. Sabaawi and Oras Ahmed Al-Ani

Abstract

There is a growing interest in recent years on developing solar cells and increasing their conversion efficiency. This interest was motivated by the demand on producing clean and inexpensive energy, where the current solar cell technology failed to fulfill the market demand due to its low efficiency obtained. Thus, an efficient alternative is highly required to overcome the drawbacks of current photovoltaic technologies. In this chapter, the concept and operation of solar rectennas will be introduced as an efficient energy-harvesting technology and as a better alternative to conventional solar cells. Nanoantennas are used for receiving solar radiation at both visible and infrared regions as AC electromagnetic signals. The received power is then passed to a nanodiode that acts as a rectifier to convert the power from AC to DC form. Nanoarrays are utilized often to increase the captured energy and decrease the number of rectifiers of the entire system. The biggest challenge is how to design an efficient nanoantenna integrated efficiently into a nanodiode in order to maximize the overall efficiency. State-of-the-art designs for nanoantennas and nanodiodes will be highlighted in this chapter mentioning the figure of merits used to compare between one design and another.

Keywords: energy harvesting, solar rectennas, nanoantennas, nanorectifiers, THz detection

1. Introduction

The increasing demand on clean and inexpensive energy has led to the emergence of solar cells in the early 1950s, where the main source of the world's power is fossil fuels. The creation of photovoltaics (PV) has opened a new era on exploiting solar radiation for the production of electricity. However, the development of the PV industry is not sufficient to cover the market demand on solar panels due to their low efficiency. Therefore, cheaper and higher-efficiency technologies are required for the solar power market. These requirements have induced the researchers to find an alternative solution by replacing the current solar cells with optical antennas integrated to diodes forming a rectifying antenna (rectenna) using the wave nature of light [1, 2]. Most of the recent researches are focused on developing solar rectennas to convert the visible region of solar spectrum efficiently to electric power and exploiting the unused portion of solar radiation (i.e., infrared region) [3]. The proposed solar rectennas are expected to exhibit higher efficiency (theoretically 100% for monochromatic

illumination) than current solar cells [4]. Rather than the low efficiency, solar rectennas overcome the other drawbacks of PVs which include the dependence on the bandgap energy and the narrowband operation (visible region only). However, several challenges contribute to make the actual conversion efficiency much lower than expected such as the poor coupling between the optical antenna and the diode [5].

Each photon in semiconductor solar cells produces electron hole pair to generate electrical power. However, the device absorbs only those photons that have energy higher than the band gap energy. This limits the conversion efficiency to 44% or even less in real devices. On the other hand, classical rectifiers receive the electromagnetic energy and convert it into DC power with a conversion efficiency reaching 100%. Solar rectennas are designed to operate in a similar way with the expectation to obtain very high efficiencies at a wide range of the electromagnetic spectrum. The field of solar rectennas appears to be promising and attractive due to the fact that high efficiency is theoretically obtainable and the material used is inexpensive and available.

Why solar rectennas?

- Solar rectennas can achieve as high as the efficiency of solar cells or even higher.
- The material of solar rectennas is widely available in the form of thin films, and the fabrication process is inexpensive compared to conventional solar cells.
- Solar rectennas demonstrate versatility over PV devices by exceeding efficiency during the day.
- Other forms of infrared such as waste heat can also be harvested by solar rectennas rather than the solar irradiation.

In contrast, there are several drawbacks and challenges associated with solar rectennas such as [6]:

- When converting visible light, the time constant must be in the range of 0.1 fs, which is hard to achieve using the planar MIM diodes.
- The leakage current of the diode must be as small as 1 μA , which is quite challenging.
- A strong matching between the antenna impedance and the diode's to ensure maximum power transfer and hence higher efficiency.

It is obvious that the technology of solar rectennas is still young in the early stage of research and faces numerous challenges and limitations. Thus, in this chapter, the theoretical understanding is presented highlighting the development of each part of a solar rectenna.

2. History of rectennas

In the last century, the story of solar rectenna begun when electrical power has been transferred without the use of wires. This technique is called wireless power

transmission (WPT). It is worth to mention that all the rectenna systems conceived at that time were working at microwave frequencies with efficiencies exceeding 80% at a single frequency.

A brief historical background on this technique is presented here:

- Early experiments on WPT return to the work of Hertz and Tesla which was implemented by exploiting a giant coil and a 3-ft-diameter copper ball to transport the electromagnetic wave with low frequency from one point in space to another one. Later, the idea of power transmission has been developed by researchers particularly after the significant progress that witnessed in microwave technology [7].
- In 1963, the first rectenna has been invented by Raytheon Co., which was constructed from 28 half-wave dipole antennas. Each one terminated with a bridge rectifier. The overall efficiency of this design was 40%. The rectenna has then been developed by the same company to use as a power source for a microwave-powered helicopter.
- In 1972, Bailey proposed an idea to use the rectennas to generate electricity from solar power. This idea was based on using a pair of pyramids or cones as a modified dipole, which is similar to rod antennas. The pair is connected to a load via a diode (half-wave rectifier) [1].
- In 1984, arrays of crossed dipoles (**Figure 1**) have been proposed by Marks, where an insulating sheet with fast full-wave rectification is used [9].
- In contrast, Bailey proposed a conventional broadside array antenna, in which the output signal is collected after passing in several dipoles. The latter is used to feed a transmission line in which the signals are transferred to a rectifier. Combined signals are used in that approach to add in-phase.
- In 1996, Lin et al. achieved the first experimental work [10] that based on the absorption of light by fabricated metallic resonant nanostructures and rectification at light frequency. The device that used this technique uses dipole antenna array that connected in parallel and constructed on a silicon substrate. The device components also include a p-n diode as a half-wave rectifier.
- In 2003, infrared (IR) rectenna structure-based metal-insulator-metal (MIM) diodes have been designed by Berland [11]. It has been designed using dipoles, operating at 10 μm wavelength. The overall recorded efficiency, however, was very low (<1%) [11].
- In 2010, spiral nanoantenna for solar energy has been designed and fabricated to collect energy at mid-IR region [12]. Kotter et al. demonstrated the progress related to this technique.
- In 2011, a monopole antenna has been designed by Midrio et al., where nickel is used as the main material to fabricate the reception of thermal radiation. This type of antenna is overlapping with the ground plane. MIM

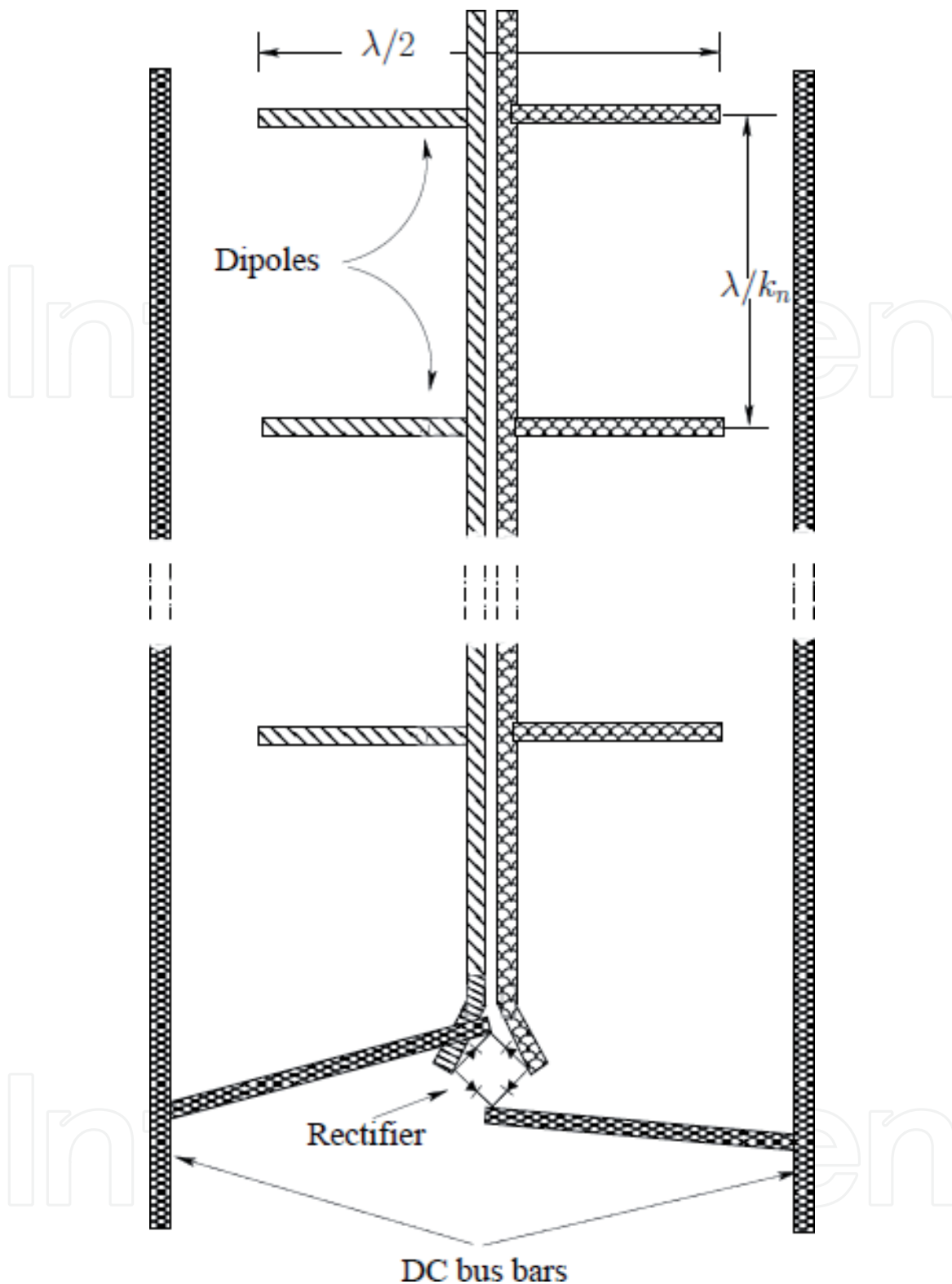

Figure 1.
The first optical rectenna proposed by mark [8].

that consists of nickel-nickel oxide-nickel diode is used to convert terahertz fields into electrical current. Furthermore, other research studies [13] are interested to study the impacts of geometrical parameters on the antenna performance.

After that, there was a significant interest by researchers to study nanoantennas coupled to MIM diode for solar power-harvesting applications or THz sensing, which cannot be covered here due to space limitations.

3. Basics of solar rectennas

The structure and the operation theory of nanoantennas have been presented in this section. The same as the response of the conventional RF antenna to the electromagnetic wave, nanoantenna responds to the visible light and IR. Induced AC current, which is formed on the surface of the antenna, interacts with the incident wave and oscillates with it in the same frequency. The presence of a feeding gap in the antenna can help to collect the solar power, and then DC power is produced by rectifying the oscillated AC current with the aid of a specific diode-based rectifier.

Based on the theory of boundary conditions, the tangential electric field vanishes on the antenna surface and is equal to zero ($E_t = 0$). This is fundamental to the traditional RF antenna, where metals are considered to have ideal electrical conductivity. In other words, $E_s = -E_i$, where E_s and E_i are scattered electric and incident electric fields, respectively.

In contrast, the operation of nanoscale antennas is based on the optical and IR regimes. In this case, metals are considered to be non-ideal conductors since they exhibit lower conductivity. Thus, the expression E_t has to be taken into account. This expression can be presented by multiplying the value of surface impedance by the value of the surface current.

Figure 2 shows the block diagram of a typical optical rectenna, in which the solar antenna receives the electromagnetic wave within a proper frequency band to deliver it to the low-pass filter (LPF) [8]. The latter, which is placed between the antenna and diode (rectifier), is used to prevent the reradiation of the higher harmonics that generated from the rectification process by the nonlinear diode. Generally, power losses result in from this reradiation.

Furthermore, the LPF matches the impedance between the antenna and the subsequent circuitry. The DC LPF smoothly delivers the rectified signal to DC and then passes it to the external load. In general, MIM diode is considered being the most common rectifier in the solar rectenna system; based on the electron tunneling process, the rectification is generally occurring through the insulator layer.

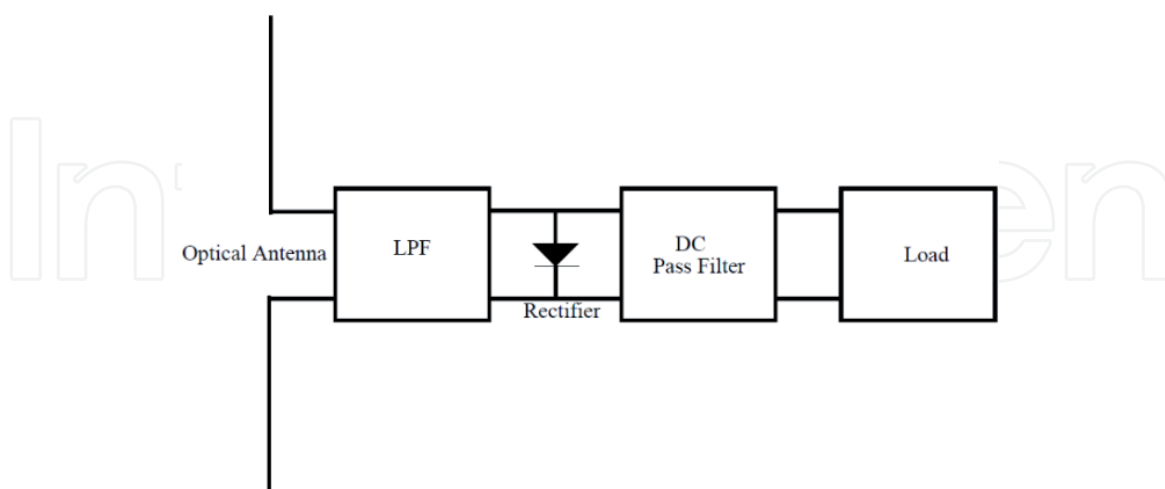

Figure 2.
Block diagram of optical rectenna [8].

4. Nanoantennas

Mirrors and lenses are usually utilized to control light propagation. However, they are unable to concentrate the light in a tiny area (smaller than $\lambda/2$), whereas antennas can easily confine the electromagnetic wave in subwavelength (beyond the

diffraction limit). The urgent need to localize the light beyond the diffraction limit has motivated the researchers and helped toward the development of nanoantennas. With the rapid growth of nanotechnology techniques, scientists are now able to fabricate nanoantennas in the order of 10 nm using E-beam lithography [14, 15]. The dimensions of nanoantenna must be in the order of the incident light wavelength to ensure efficient performance. Light/matter interaction has been exploited extensively in many applications such as photovoltaics, microscopy, and THz sensing.

The main role that nanoantenna plays in solar rectennas is to receive external fields and confine the energy at its feed gap to be rectified by a nanodiode. The technological advances in the development of a new generation of nanodiodes such as point-contact diodes have contributed significantly to the emergence of solar rectennas in its modern form [16]. **Figure 3** demonstrates numerous fabricated nanoantennas for various applications.

The performance of nanoantennas in solar rectennas is measured by their ability to efficiently concentrate the received solar energy at the feed gap of the antenna.

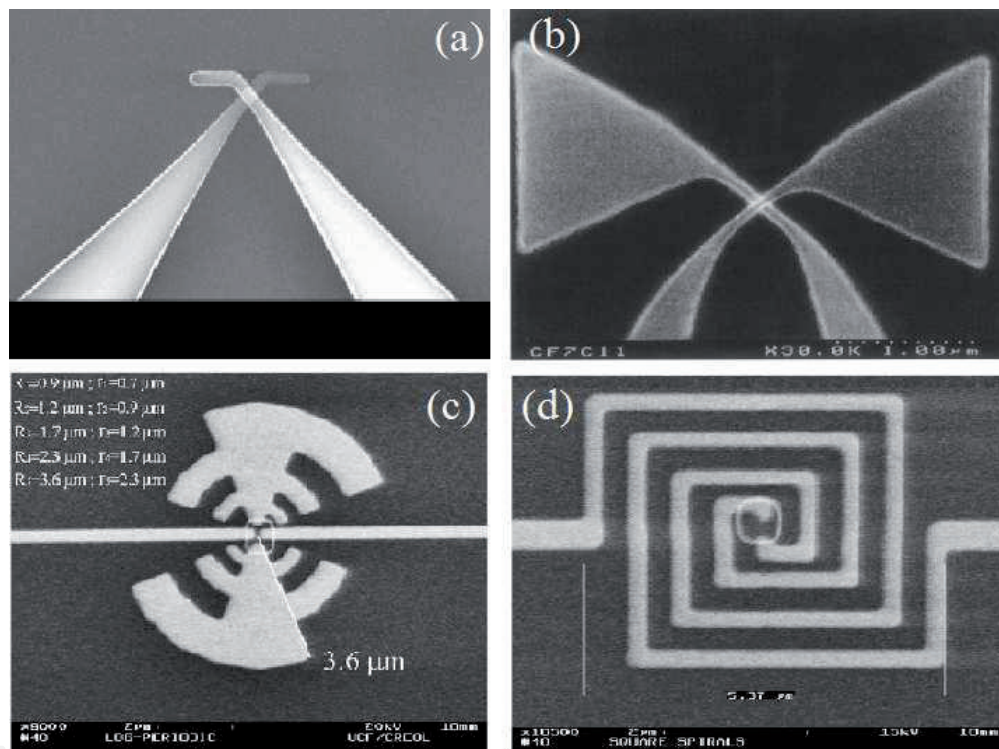

Figure 3. Fabricated nanoantennas: (a) dipole, (b) bowtie, (c) log-periodic, and (d) spiral.

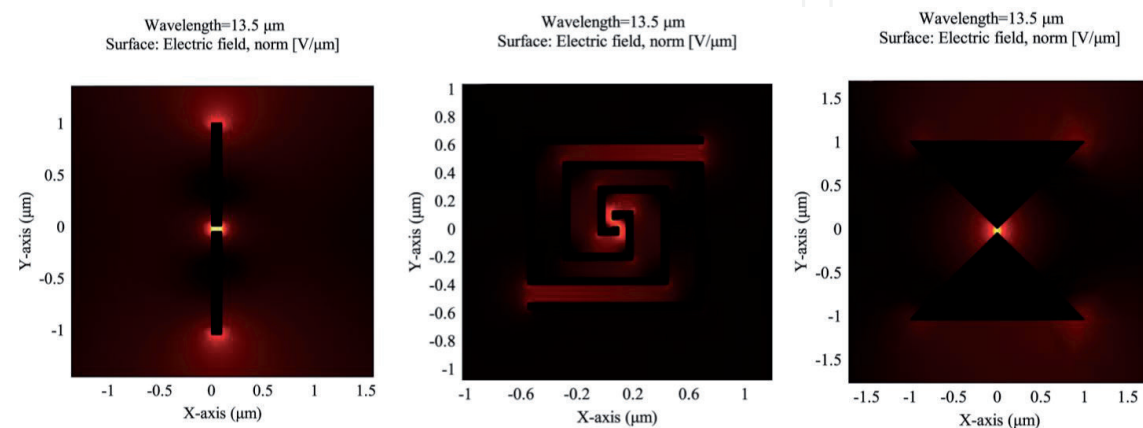

Figure 4. Concentration of the electric field at the feed gap of different nanoantennas [17].

The electric field generated at the feed gap varies from one type of antenna to another depending on the characteristics of the antenna itself. Thus, the confined electric field can be enhanced by choosing the proper antenna type for this application or by gathering a number of antennas in one rectenna system forming an antenna array. A comparison between different types of nanoantennas is presented in **Figures 4** and **5**, where the figure of merit is the value of the received electric field at the antenna's gap [18].

Another way to increase the captured electric field is to arrange several antenna elements in an array form. **Figure 6** shows an eight-element bowtie nanoarray as suggested in [19], where the concentration in the feed gap is also illustrated, while **Figure 7** shows the variation of the electric field with increasing the wavelength. The nanoarray exhibits multiple resonances with maximum capturing at longer wavelengths.

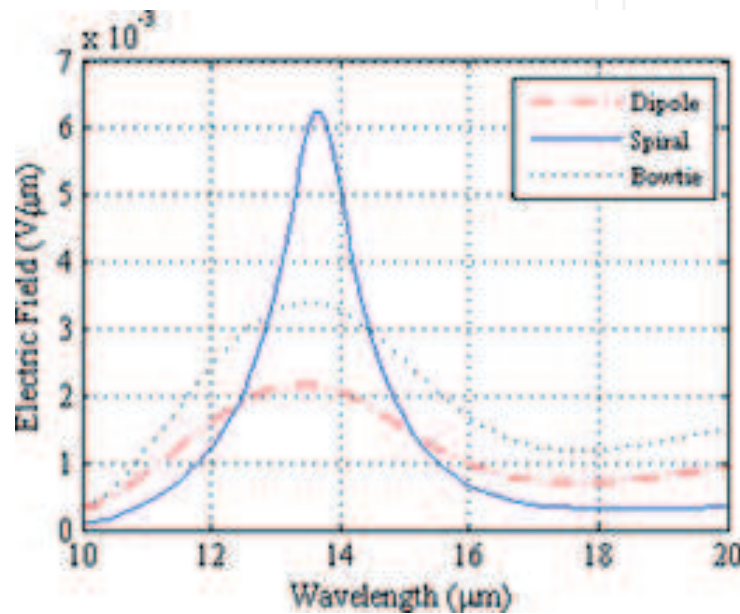

Figure 5.
 Electric field variation versus wavelength for different nanoantennas [17].

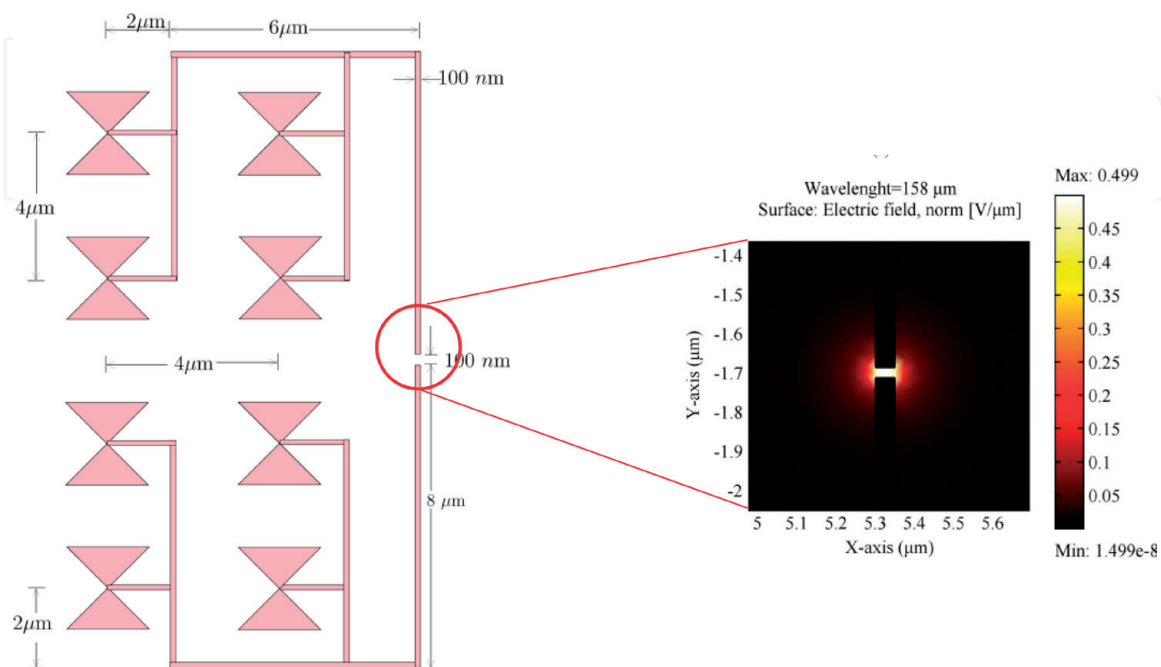

Figure 6.
 Bowtie nanoarray configuration [19].

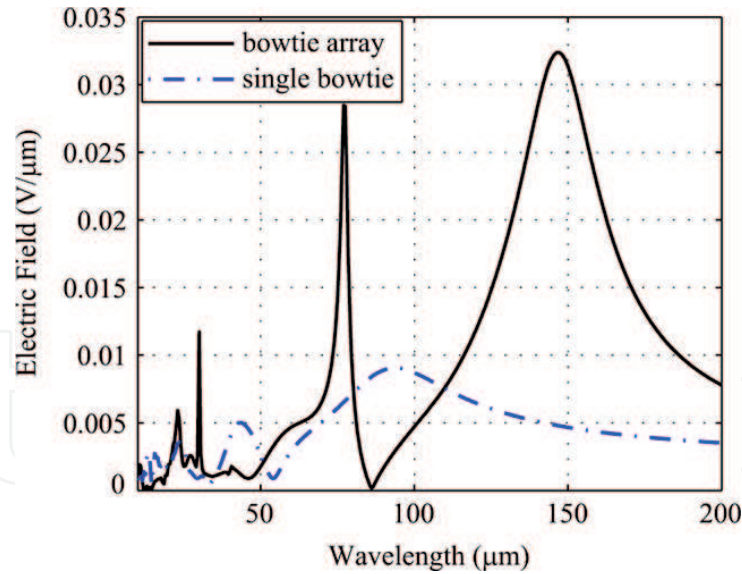

Figure 7. Electric field variation with wavelength for bowtie nanoarray and single bowtie of the same footprint area [19].

5. Nanodiodes

The most commonly used nanodiodes in solar rectennas are metal-insulator-metal diodes, which act as a promising rectifying element in solar rectennas. MIM diodes are made of thin insulator layer sandwiched between metal electrodes and depend on the tunneling mechanism. Work functions of metals and the electron affinity of insulators play an important role in MIM diodes by making a barrier at the interface between metal and insulator. **Figure 8** shows a typical MIM diode where a difference between metal work function is clearly indicated to ensure efficient electron transport across the insulator. The quantum-mechanical tunneling of electrons governs the charge transport mechanism through the barrier. Electron tunneling in MIM diodes is ultrafast, and this makes them operate at THz frequencies. A thin insulator layer (few nanometers) is required to ensure the tunneling of electrons through the diode layers.

Recent years have witnessed tremendous lithographical efforts to reduce the size of MIM diodes. To this end, the insulator layer is grown by oxidizing metal films to achieve the desired thickness. The second metal is then deposited, where this method helps to avoid vacuum break at the barrier and reduce the contamination. It is worth mentioning that controlling the roughness of the insulator layer as well as the metal films is very important during the fabrication process.

5.1 MIM diode characterization

The major obstacle in using MIM at optical frequencies is the high RC time constant. The diode resistance and capacitance must be well controlled through the fabrication techniques and processes in order to reduce it. In this section, the most important parameters of the MIM diode will be discussed:

- **Resistance:** The diode resistance (R_D) can be obtained directly from the I-V characteristics of the diode. Since the antenna impedance is low (in the order of 100 Ohm), the diode impedance must be low as well to achieve a reasonable impedance matching and hence ensure a maximum power transfer between the antenna and the diode.

- **Responsivity:** The responsivity of MIM diodes is a measure of the diode rectification efficiency. It is the second derivative of the diode's I-V curve over the first derivative. The responsivity represents the DC power generated by the incident AC power on the diode. The larger I-V curvature, the higher responsivity obtained, and hence the higher DC power generated. High curvature is associated directly with high barrier diodes.
- **Asymmetry:** The ratio of the forward current to the reverse current represents the diode asymmetry, which is another measure of the diode's rectification

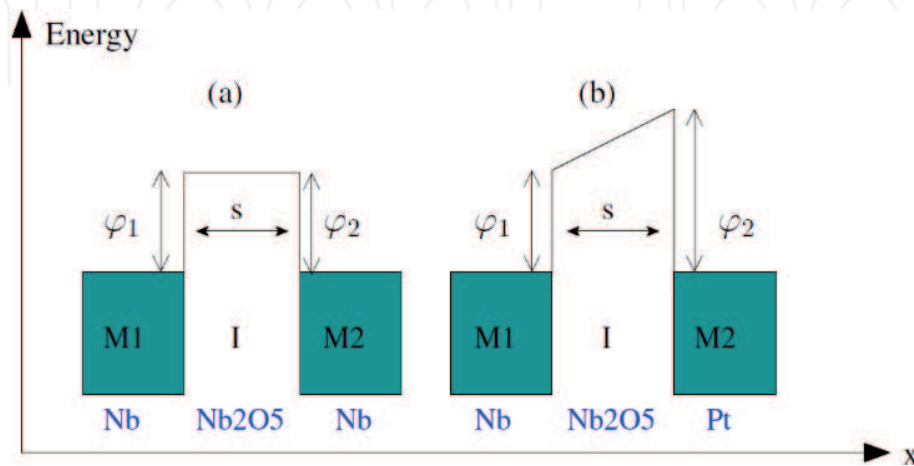

Figure 8. Equilibrium band diagram of (a) symmetric Nb/Nb₂O₅/Nb diode and (b) asymmetric Nb/Nb₂O₅/Pt diode [20].

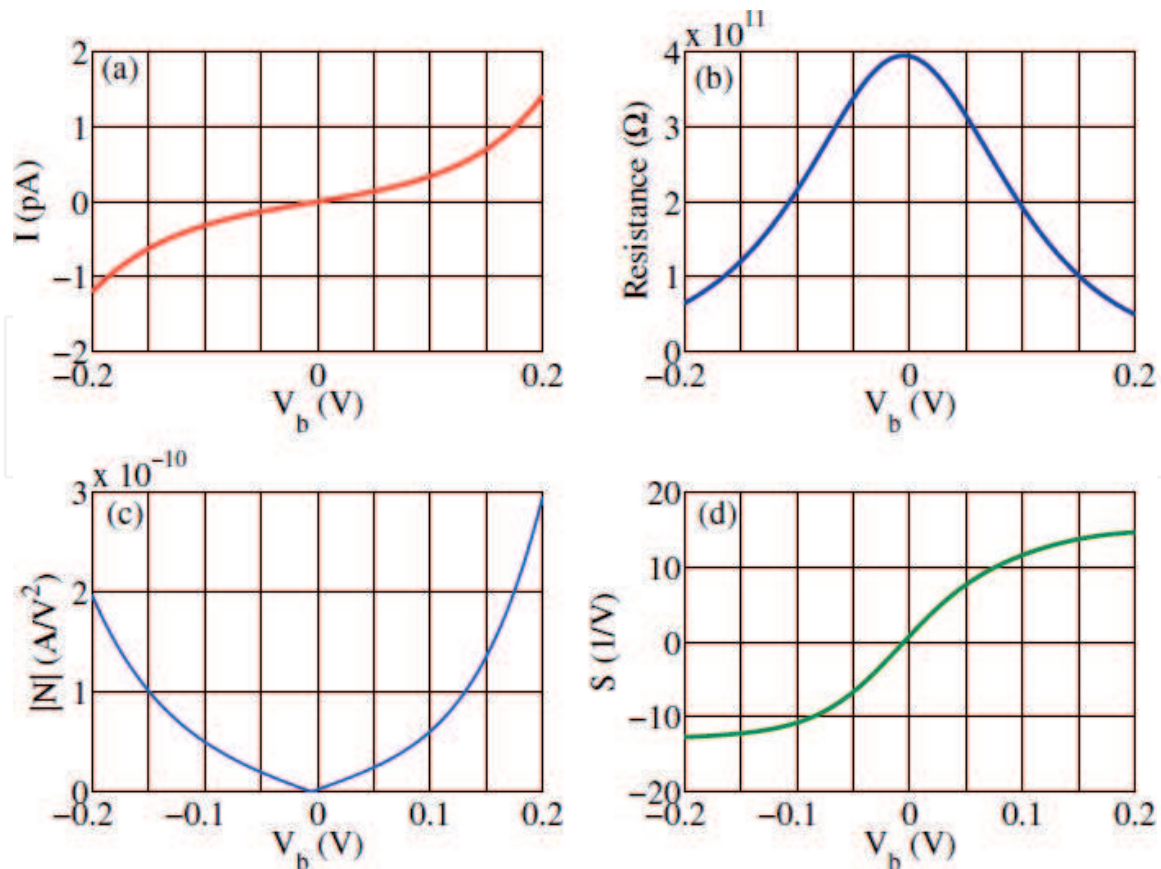

Figure 9. Current versus biasing voltage for the asymmetric MIM diode with insulator thickness $s = 5 \text{ nm}$ and barrier heights $\phi_1 = 0.4 \text{ eV}$ and $\phi_2 = 1.75 \text{ eV}$ [20].

efficiency. High asymmetry can be obtained by employing different metals on both sides of the diode with a difference in their work functions.

Most of the MIM diode parameters are extracted directly from the I-V characteristics, which is the key factor in the characterization of MIM diodes. **Figure 9** demonstrates typical MIM diode parameters.

6. Semiconductor nanoantennas

In this section, a comparison between the performance of nanoantennas fabricated by different materials will be presented. The characteristics of the designed dipole nanoantennas have been obtained by solving Hallen's integral equation numerically. Obtained results show that carbon exhibits very low conductivity compared with other types of proposed semiconductors like Si and Ge.

This is because of the fact that carbon has a relatively wide energy gap, which is the main reason to enhance carbon nanoantenna performance. In contrast, creating extra defect states by phosphor or iron doping in the narrow band gap of Si and Ge can increase the conductivity and, thus, the efficiency of the host material.

The calculated efficiencies of these heavily doped semiconductor nanoantennas are unity. This is because of the high conductivity of these materials. Moreover, obtained results show that these materials behave like a perfect electric conductor at the wavelength range of interest. In addition, the performance of these semiconductor nanoantennas is compared with nanoantennas made of gold that showed approximately similar performance.

To investigate the impact of the conductivity (σ) on the antenna parameters, pure and heavily doped semiconductor materials are used instead of metal in designing nanoantennas. Since plasmonic materials like gold are being used to fabricate metallic nanoantenna, a modeling comparison between the metallic and heavily doped semiconductor antenna is proposed to study the impact of the material on the performance of nanoantenna to exploit the mid-IR to generate presentable power.

Furthermore, the mid-IR radiation provides very low penetration depths for the electromagnetic fields. Generally, most studies on this area were focused on operating system with 10 μm wavelengths, which may provide a wide range of energies [12].

To solve Hallen's integral equation, which is numerically used to evaluate the input impedance of the cylindrical dipole nanoantennas [21], method of moments (MOM) is generally used for this purpose. A study has been conducted to investigate the effect of replacing gold in plasmonic nanoantennas at mid-IR by heavily phosphorus-doped germanium on the antenna operation [22]. In this study, however, carbon nanotube semiconductor material is extended to heavily doped silicon by iron as common unavoidable contamination in Si. In both cases, the characteristics of the gold center-fed cylindrical dipole antenna that is used in this study include $L = 0.47\lambda$, $N = 51$, and $a = 50 \text{ nm}$ for $\lambda = 10 \mu\text{m}$, where L is the total length of the dipole, N is the number of segments, and a is the radius of dipole. In addition to that, for the delta-gap source, MoM is used to solve Hallen's integral equation. An approximate kernel can only be utilized since the ratio $a/\lambda \leq 0.01$, and in this example, a ratio of 0.005 is used which gives an acceptable approximation.

One of the methods used to increase the efficiency of nanoantenna is by developing the quality of materials that are used to fabricate the nanoantenna. In this work, heavily doped Ge with phosphorous and heavily doped Si with Fe have been proposed as an alternative to carbon. The value of the

frequency-dependent dielectric constant of heavily doped Ge with a doping concentration of $2.23 \times 10^{19} \text{ cm}^{-3}$ has been given somewhere else [23]. On the other hand, the values of heavily doped Si with a doping concentration of $1 \times 10^{20} \text{ cm}^{-3}$ have been obtained by another study [24]. The interaction between Fe and Si has been studied and reported in [25].

The dielectric constant (ϵ_r) has frequency-dependent real and imaginary parts, in which the metal conductivity (σ) at IR wavelengths can be obtained as the following equation [26]:

$$\sigma = i\omega\epsilon_0(\epsilon_r - 1) \quad (1)$$

The complex form of material conductivity at IR wavelengths is illustrated as real and imaginary parts in **Figures 10** and **11**, respectively. Both figures show that heavily doped semiconductors exhibit considerably high conductivity at a range of wavelength between 5 and 15 μm . Consequently, both of the heavily doped semiconductors behave like perfect electric conductor [22].

It is found that the conduction-dielectric efficiencies at the wavelength 10 μm for both Ge and Si are 100% as what is expected to having the same behavior as the

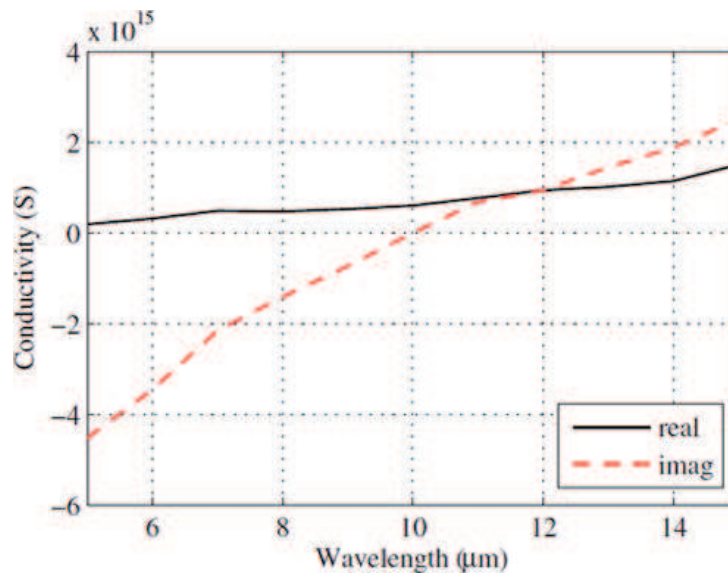

Figure 10.
 Real and imaginary parts of Ge conductivity versus wavelength [22].

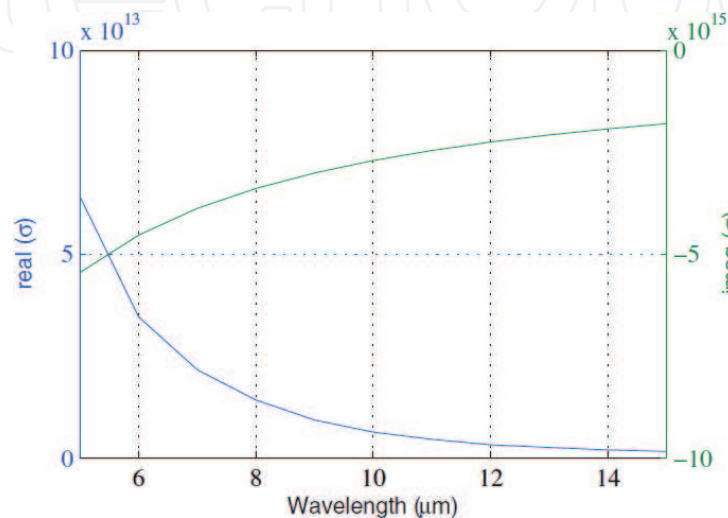

Figure 11.
 Real and imaginary parts of Si conductivity versus wavelength [22].

perfect electric conductor. In contrast, the relatively low conductivity of gold yield decreases in the efficiency to around 90% at wavelengths of interest.

7. Conversion efficiency

The figure of merit in solar rectennas is the conversion efficiency, which depends on several factors related to both the antenna and the MIM diode. The conversion efficiency, η_t , of a solar rectenna can be described as [27].

$$\eta_t = \eta_r \eta_s \eta_q \eta_c \quad (2)$$

where η_r is the antenna radiation efficiency, η_s is the efficiency that related to the losses inside the antenna, η_q is the quantum efficiency that is responsible for the rectification of the received power, and η_c is the coupling efficiency between the antenna and the diode. It is worth noting that the term $\eta_r \eta_s$ in (2) depends on the antenna type and its characteristics and is referred, in this chapter, to as antenna-dependent efficiency of solar rectenna. On the other hand, the term $\eta_q \eta_c$ relates strongly to the diode parameters and is referred to as the diode-dependent efficiency.

For solar energy conversion, each efficiency factor is required to be optimized and maximized. Recent works have focused on improving only the quantum efficiency [28] or the diode-dependent efficiency by assuming a perfect antenna (i.e., do not include antenna efficiency limits) [4]. The analysis of the complete conversion efficiency in one single work gives the reader a close physical insight on how the IR solar rectenna works, including the parameters that affect its performance. In the following sections, we will investigate each term of (2) individually with a detailed description of its main parameters and how to compute them. After finding the optimum values of each efficiency term in (2), the overall conversion efficiency will then be calculated and plotted.

7.1 Antenna-dependent efficiency

As mentioned in Section 7, the antenna-dependent efficiency is represented by the term $\eta_r \eta_s$. This section demonstrates how to find this efficiency numerically, which depends totally on antenna parameters. The calculation of antenna efficiency should take into account the losses that relates to reflection, conduction, and dielectric inside the antenna. The reflection losses will be represented by the coupling efficiency, η_c , and will be discussed in details in the following section. Thus, this section will be dedicated to the calculation of the conduction and dielectric losses inside the antenna structure. Since it is very difficult to compute and separate these losses individually, they will, therefore, be lumped together to form the conduction-dielectric efficiency, η_{cd} , which can be defined as [29].

$$\eta_{CD} = \frac{R_r}{R_r + R_l}; \quad (3)$$

where R_r is the radiation resistance of the antenna and R_l represents the conduction-dielectric resistance, which can be written as [29]

$$R_l = 2 \frac{L}{P} R_s; \quad (4)$$

where L is the antenna length, P is the cross-section perimeter of the wire antenna of radius a , and R_s is the conductor surface resistance that can be calculated as follows

$$R_s = \sqrt{\frac{\omega \mu_0}{2\sigma}}; \quad (5)$$

where ω is the angular frequency, μ_0 is the free-space permeability, and σ is the metal conductivity. It is worth mentioning here that Eq. (4) is valid for the case of a uniform current distribution.

Before starting the calculation of the conduction-dielectric efficiency, it is important to recall that metals are no longer perfect electric conductors at optical and infrared frequencies [30]. Consequently, the DC bulk conductivity of metal cannot be utilized in (5). Instead, the frequency-dependent conductivity at optical frequencies should be calculated.

7.2 Diode-dependent efficiency

The two terms of the diode-dependent efficiency are the coupling efficiency, η_c , and quantum efficiency, η_q . In this chapter, we will set $\eta_q = S h \omega / e$, where S is the MIM diode responsivity, which will be explained more explicitly later in this section, h is Plank's constant, and e is the charge of the electron. In contrast, the coupling efficiency can be written as [5].

$$\eta_c = \frac{4R_a R_D / (R_a + R_D)^2}{1 + \left(\omega \left(\frac{R_a R_D}{R_a + R_D} \right) C_D \right)^2}; \quad (6)$$

where R_a is the antenna resistance, ω is the angular frequency, R_D is the diode resistance, and C_D is the diode capacitance. For simplicity of analysis, the reactance of the antenna was assumed to be negligible; however, for the antenna in this work, this approximation is more realistic for the wavelength between 8 and 12 μm where a low reactance part of the impedance is noticed. The value of R_D depends on the I-V characteristics of the MIM diode, whereas the C_D can be given by

$$C_D = \frac{\epsilon_0 \epsilon_r A}{s}; \quad (7)$$

where ϵ_r represents the relative permittivity of the insulator layer of the MIM diode, ϵ_0 is the free-space permittivity, A is the diode junction area (overlapping area), and s is the thickness of insulator layer. It is clearly evident that the MIM diode parameters play a significant role in determining the entire conversion efficiency of solar rectennas.

Figure 12 shows the total conversion efficiency (solid line) for an IR solar rectenna versus the wavelength. Moreover, we have added the diode-dependent efficiency (dashed line) to the same graph to show the role that the antenna plays in shaping the conversion efficiency. The total conversion efficiency has been calculated based on the terms of (2), where every single term is calculated individually and all terms are then combined together. The main reason behind this low efficiency is the mismatch between the resistance of the designed MIM diode, R_D , and the antenna resistance, R_a . This mismatch led to a lower coupling efficiency in (6), where one of the conditions to achieve unity efficiency is to have $R_D = R_a$. Although the diode characteristics have been optimized, the coupling efficiency still needs further improvement. However, this value of efficiency demonstrates an enhancement to recently reported conversion efficiencies of ($\eta_t \sim 10^{-9}$ – $\eta_t \sim 10^{-12}$) [31]. It is worth mentioning that the antenna efficiency is very high and the diode responsivity is acceptable; however, the total conversion efficiency is quite low due to the poor coupling efficiency between the antenna and the diode. Recent studies are paying attention and efforts to increase coupling efficiency. Once the coupling is improved, we would expect a high conversion efficiency, which makes solar

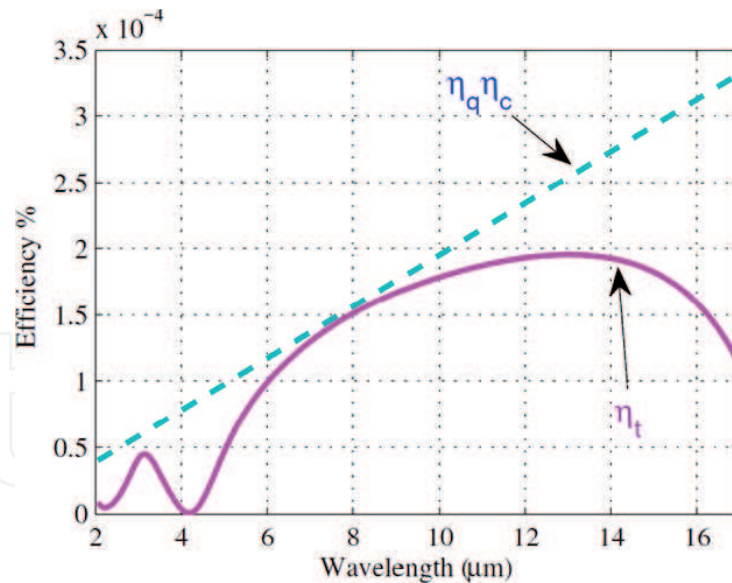

Figure 12. Total conversion efficiency and the diode-dependent efficiency of a typical IR solar rectenna [8].

antennas a promising alternative to conventional solar cells and a great addition to the renewable energy sector.

The promising features of solar rectennas have motivated the researcher recently to come up with new approaches and ideas in order to improve the total conversion efficiency. Examples of these approaches include improving the impedance matching and the coupling between the antenna and rectifier [32, 33]. Another approach is to use metasurface absorbers to enhance the performance of solar rectenna [34]. In addition, light concentrators represented by adding a layer of micro lenses lead to increase the captured electric field as demonstrated in [35] or design dual-polarized nanoantennas [36] and/or multiband nanoantennas [37] to get benefits of all received spectrum. The approach was even extended to include harvesting thermal energy at infrared wavelengths from hot bodies [38], which sometimes focuses on preselected narrow frequencies in the infrared region [39].

8. Conclusions

Researchers worldwide pay attention and effort to reduce the cost of conventional solar cells and increase their efficiency by using new materials and different approaches. However, there is no significant improvement in their conversion efficiency, which is still quite low. Breakthroughs in designing efficient nanoantennas led to rapid development in solar rectenna for harvesting solar radiation. Efficient nanoantennas were designed for receiving the solar energy as an AC signal and coupling it to a nanodiode to convert it to DC power.

The focus of this chapter was to highlight different types of nanoantennas that are commonly used in this application. The design and simulation results of four types of nanoantennas have been presented, and a comparison is made to find the best candidate. The figure of merit in the selection process was the captured electric field at the feed gap of the antenna, which is a key factor in calculating the harvested energy. As a result of the comparison, it was found that the spiral nanoantenna exhibited better performance at resonance. Furthermore, it was found that the captured electric field at the feed gap could be increased by coupling many elements in one structure.

Finally, this chapter highlighted the most important factors that influence the conversion efficiency of solar rectennas with the aim to improve and optimize it.

It was shown that even when optical antennas couple thermal radiation efficiently, the total conversion efficiency is still low. This is due to the poor matching between the diode and the antenna, where a very high diode resistance is obtained compared to the low antenna resistance, albeit the diode characteristics have been optimized.

As a summary, solar rectennas are an attractive option to replace PV cells in harvesting solar energy; however, this technique requires further developments in the rectification process.

IntechOpen

Author details

Ahmed M.A. Sabaawi^{1*} and Oras Ahmed Al-Ani²

1 College of Electronics Engineering, Ninevah University, Mosul, Iraq

2 College of Electrical Engineering Techniques, Middle Technical University, Baghdad, Iraq

*Address all correspondence to: ahmed.sabaawi@uoninevah.edu.iq

IntechOpen

© 2019 The Author(s). Licensee IntechOpen. This chapter is distributed under the terms of the Creative Commons Attribution License (<http://creativecommons.org/licenses/by/3.0>), which permits unrestricted use, distribution, and reproduction in any medium, provided the original work is properly cited. 

References

- [1] Corkish R, Green MA, Puzzer T. Solar energy collection by antennas. *Solar Energy*. 2002;**73**(6):395-401
- [2] Berland B. Photovoltaic technologies beyond the horizon: Optical rectenna solar cell. Final report, NREL/SR-520-33263. National Renewable Energy Laboratory (NREL); 2003
- [3] Biagoni P, Huang JS, Hecht B. Nanoantennas for visible and infrared radiation. *Reports on Progress in Physics*. 2012;**75**:1-76
- [4] Joshi S, Moddel G. Efficiency limits of rectenna solar cells: Theory of broadband photon-assisted tunneling. *Applied Physics Letters*. 2013;**102**:083901
- [5] Grover S, Moddel G. Applicability of metal/insulator/metal (MIM) diodes to solar rectennas. *IEEE Journal of Photovoltaics*. 2011;**1**(1):78-83
- [6] Nozik AJ, Conibeer G, Beard MC, editors. *Advanced Concepts in Photovoltaics*. Cambridge, UK: Royal Society of Chemistry; 2014
- [7] Brown WC. The history of power transmission by radio waves. *IEEE Transactions on Microwave Theory and Techniques*. 1984;**32**(9):1230-1242
- [8] Sabaawi AMA. Nanoantennas for solar energy harvesting [PhD dissertation]. Newcastle University; 2015
- [9] Marks AM. Device for conversion of light power to electric power. US Patent 4,445,050. April 24, 1984
- [10] Lin GH, Abdu R, Bockris JOM. Investigation of resonance light absorption and rectification by sub nanostructures. 1996;**80**:565
- [11] Berland B. Photovoltaic Technologies beyond the Horizon: Optical Rectenna Solar Cell. Golden, CO, US: National Renewable Energy Laboratory; 2003
- [12] Kotter D, Novack S, Slafer W, Pinhero P. Theory and manufacturing processes of solar nanoantenna electromagnetic collectors. *Journal of Solar Energy Engineering*. 2010;**132**(1):011014
- [13] Midrio M, Romagnoli M, Boscolo S, De Angelis C, Locatelli A, Modotto D, et al. Flared monopole antennas for 10- μm radiation. *IEEE Journal of Quantum Electronics*. 2011;**47**(1):84-91
- [14] Bharadwaj P, Deutsch B, Novotny L. Optical antennas. *Advances in Optics and Photonics*. 2009;**1**(3):438-483
- [15] Bareiß M, Köhler D, Krenz PM, Zschieschang U, Klauk H, Scarpa G, et al. Large-area fabrication of antennas and nanodiodes. In: *Rectenna Solar Cells*. Springer; 2013. pp. 297-311
- [16] Fumeaux C, Herrmann W, Kneubühl F, Rothuizen H. Nanometer thin-film Ni-NiO-Ni diodes for detection and mixing of 30 THz radiation. *Infrared Physics & Technology*. 1998;**39**(3):123-183
- [17] Sabaawi AMA, Tsimenidis CC, Sharif BS. Infra-red spiral nano-antennas. In: *Loughborough Antennas and Propagation Conference (LAPC)*; November 12-13, 2012. pp. 1-4
- [18] Sabaawi AM, Tsimenidis CC, Sharif BS. Infra-red nano-antennas for solar energy collection. In: *2011 IEEE Loughborough Antennas & Propagation Conference*. November 14, 2011. pp. 1-4
- [19] Sabaawi AM, Tsimenidis CC, Sharif BS. Planar bowtie nanoarray for THz energy detection. *IEEE Transactions on Terahertz Science and Technology*. 2013;**3**(5):524-531

- [20] Sabaawi AM, Tsimenidis CC, Sharif BS. Characterization of coupling and quantum efficiencies in solar rectennas. In: 2013 Loughborough Antennas & Propagation Conference (LAPC); November 11, 2013; IEEE. pp. 363-368
- [21] Sabaawi AM, Tsimenidis CC, Sharif BS. Analysis and modeling of infrared solar rectennas. *IEEE Journal of Selected Topics in Quantum Electronics*. 2013;**19**(3):9000208
- [22] Sabaawi AMA, Al-Ani OA. Heavily-doped semiconductor infrared antennas for solar energy harvesting. In: 2015 Loughborough Antennas & Propagation Conference (LAPC). IEEE; 2015
- [23] Baldassarre L et al. Mid-infrared plasmonic platform based on heavily doped epitaxial Ge-on-Si: Retrieving the optical constants of thin Ge epilayers. In: 39th IEEE International Conference on Infrared, Millimeter, and Terahertz Waves; IRMMW-THz; 2014
- [24] Al-Ani OA, Sabaawi AMA, Goss JP, Cowern NEB, Briddon PR, Rayson MJ. Investigation into efficiency-limiting defects in mc-Si solar cells. *Solid State Phenomena*. 2016;**242**:96-101
- [25] Oras A, Al-Ani JP, Goss NEB, Cowern PR, Briddon M, Al-Hadidi RA-H, et al. A density functional study of iron segregation at ISFs and $\Sigma 5$ -(001) GBs in mc-Si. *Solid State Phenomena*. 2016;**242**:224-229
- [26] Hanson GW. On the applicability of the surface impedance integral equation for optical and near infrared copper dipole antennas. *IEEE Transactions on Antennas and Propagation*. 2006;**54**:3677-3685
- [27] Grover S, Dmitriyeva O, Estes MJ, Moddel G. Traveling wave metal/insulator/metal diodes for improved infrared bandwidth and efficiency of antenna-coupled rectifiers. *IEEE Transactions on Nanotechnology*. 2010;**9**(6):716-722
- [28] Dagenais M, Choi K, Yesilkoy F, Chryssis AN, Peckerar MC. Solar spectrum rectification using nano-antennas and tunneling diodes. *Proceedings of SPIE*. 2010;**7605**:76050E. 11 p
- [29] Balanis CA. *Antenna Theory: Analysis and Design*. New Jersey: Wiley; 2005
- [30] Gonzalez FJ, Alda J, Simon J, Ginn J, Boreman G. The effect of metal dispersion on the resonance of antennas at infrared frequencies. *Infrared Physics and Technology*. 2009;**52**(1):48-51
- [31] Briones E, Alda J, González FJ. Conversion efficiency of broadband rectennas for solar energy harvesting applications. *Optics Express*. 2013;**21**(103):A412-A418
- [32] Di Garbo C, Livreri P, Vitale G. Optimal matching between optical rectennas and harvester circuits. In: 2017 IEEE International Conference on Environment and Electrical Engineering and 2017 IEEE Industrial and Commercial Power Systems Europe (EEEIC/I&CPS Europe); IEEE; 2017
- [33] da Costa KQ, Souza JL, Dmitriev V. Impedance matching analysis of cylindrical plasmonic nanoantennas fed by optical transmission lines. In: Barbillon G, editor. *Nanoplasmonics: Fundamentals and Applications*. Intech; 2017. p. 267
- [34] Almoneef T, Ramahi OM. Dual-polarized multi-band infrared energy harvesting using H-shaped metasurface absorber. *Progress In Electromagnetics Research*. 2017;**76**:1-10
- [35] Kashif MF, Rakos B. A Nanoantenna-MIM diode-lens device

concept for infrared energy harvesting.
In: International Conference on Global
Research and Education. Cham:
Springer; 2018

[36] Eltresy NA et al. Dual-polarized
nanoantenna solar energy collector.
In: 2016 33rd National Radio Science
Conference (NRSC). IEEE; 2016

[37] Chekini A, Sheikhaei S, Neshat M.
Multiband plasmonic nanoantenna
structure for infrared energy
harvesting based on electron field
emission rectification. *Microwave
and Optical Technology Letters*.
2017;**59**(10):2630-2634

[38] Sandeep R et al. Design of
Nanoantennas for harvesting waste
thermal energy from hot automobile
exhaust system. In: 2018 IEEE
Indian Conference on Antennas and
Propagation (InCAP). IEEE; 2018

[39] Fountain MW, Saffold GL. Thermal
rectifying antenna complex (trac). US
Patent Application No. 15/976,167; 2018