

We are IntechOpen, the world's leading publisher of Open Access books Built by scientists, for scientists

4,800

Open access books available

122,000

International authors and editors

135M

Downloads

Our authors are among the

154

Countries delivered to

TOP 1%

most cited scientists

12.2%

Contributors from top 500 universities



WEB OF SCIENCE™

Selection of our books indexed in the Book Citation Index
in Web of Science™ Core Collection (BKCI)

Interested in publishing with us?
Contact book.department@intechopen.com

Numbers displayed above are based on latest data collected.

For more information visit www.intechopen.com



Copolymer Synthesis with Redox Polymerization and Free Radical Polymerization Systems

Melahat Göktaş

Abstract

In this study, block copolymer synthesis was evaluated by combining the redox polymerization technique and different polymerization techniques. By combining such different polymerization techniques, block copolymer synthesis has recently become an important part of polymer synthesis and polymer technology. The block/graft copolymers synthesized by combining such different techniques contribute greatly to macromolecular engineering. In today's polymer synthesis, copolymer synthesis is of great interest in polymer technologies especially by using controlled radical polymerization and different polymerization techniques together. The success achieved in copolymer synthesis by using different polymerization techniques such as ATRP-ROP, RAFT-ROP, and ATRP-RAFT on the same step or different steps was achieved by combining redox polymerization with moderate polymerization conditions and controlled radical polymerization techniques as well.

Keywords: redox systems, free controlled radical polymerization, redox polymerization, copolymer, macroinitiator

1. Introduction

Since the 1980s, about 50% of the total production of synthetic polymers used as plastics worldwide has been achieved through free radical polymerization. Peroxy compounds in technical polymerization processes have played the most important role in addition to 60-year redox systems and azo initiators for nearly 100 years. For nearly 30 years, polymer synthesis with free radical polymerization reactions has attracted considerable attention technically, even though their share in total polymer production is still quite small [1].

The most important advantage of conventional free radical polymerization, which is widely used, is that many monomers can be polymerized using this method and that this polymerization can be made under moderate conditions. The most important disadvantage of this polymerization technique is that the polymer architecture and molecular weight are not controlled and also the production of polymers with large molecular weight distribution [2]. The manufacturing of polymers, of which molecular architecture and molecular weight can be controlled in recent years and which have low molecular weight distribution (polydispersity), has been made possible with controlled radical polymerization techniques. Under favor of controlled radical polymerization techniques, polymers with narrow molecular weight distribution can be produced in a

desired molecular weight and desired molecular way in a controlled and repeatable manner. Synthesis of polymers, which have the star, comb, brush, worm, or graft architecture, is provided by molecular structure and size-controlled radical polymerization techniques [3–7].

Until today, the synthesis of block copolymers has usually been made through ionic polymerization. But ionic polymerization requires strict conditions, and the number of monomers is relatively limited. To overcome these disadvantages, simpler and easier techniques have been used recently for block copolymer synthesis [8, 9]. It has been possible to be successful in block copolymer synthesis in recent years with RAFT-ROP [10], ATRP-ROP [11], and redox polymerization-ATRP methods which have many advantages compared to other popular methods and have been implemented by using different techniques together [12]. Due to the practicability of two transformations at the same time or through separate steps, it minimizes homopolymerization which causes side reactions. Combining different polymerization techniques should be an interesting method for block and graft copolymers because the presence of more than one monomer in a polymer chain has been by combining such different techniques [10, 13–15]. The new polymers may have amazing features with their various compositions and architectures. The synthesis of block and graft copolymers was successfully performed by combining controlled radical polymerization techniques and redox polymerization [16]. The synthesis of block copolymers ends with traditional radical polymerization based on the connection of functional groups of the chain and polymers. Though this strategy was effective and successful, it was difficult to test the molecular weight and architecture of the polymer which was obtained. To be able to solve this problem, controlled free radical polymerization techniques were developed quickly [17].

In this present study, the synthesis of block copolymers over separate steps or on the same step was examined with different free radical polymerization techniques and redox polymerization methods. Copolymer synthesis by combining such different techniques has recently attracted considerable attention in polymer synthesis science.

2. Redox polymerization

Redox initiator polymerization was first discovered in Germany (1937); then it attempted to remove the induction period in aqueous or emulsion polymerization by adding a reducing agent to the oxidant initiator in the USA (1945) and in England (1946). Only the increase of rate of polymerization (RP) along with the expected decrease in the induction period was observed at that rate. The main characteristic of the compounds which form a redox pair for aqueous polymerization is their solubility in water, producing active, stable, and relatively fast radicals [1, 18].

The polymerizations activated by a reaction between an oxidant and a reducing agent are called redox polymerizations. The essence of redox activation is a reduction-oxidation process. In this process, an oxidant, i.e., Ce (IV) or Mn (III), forms a complex by simply reacting organic molecules at the beginning, which then decomposes unimolecularly to produce free radicals that initiate polymerization. There are peroxides, persulfates, peroxide phosphate, and salts of transition metals among the oxidants commonly used. These oxidants form effective redox systems with various reducing agents such as alcohols, aldehydes, amines, and thiols for the aqueous polymerization of vinyl monomers. The basic properties of the components forming a redox pair for aqueous polymerization are their water solubility and the quite rapid and stable release of active radicals [19, 20]. It is easy to control the

reaction rate by changing the concentration of metal ion or peroxide, except for the use of low temperatures in redox systems [21]. There are many studies about block copolymer synthesis in the literature. Starting with a redox operation is only one method to obtain such polymers [22, 23].

The synthesis of block copolymers with redox systems provides a number of technical and theoretical advantages as compared with the other methods. Redox polymerization minimizes side reactions under favor of its applicability at low temperatures [24]. In radical polymerization, redox systems are widely used as initiators, and a result is accomplished in a very short time. When compared with the other methods, it is the main advantage of processing at a very moderate temperature (low; 30 kcal/mole for thermal start and 10–20 kcal/mole for activation energy). This shows that it can minimize possible side reactions. The Ce(IV) or permanganate initiators, which combine with a reducing agent that includes a hydroxyl or carboxyl group, are more commonly used initiators [25].

The mechanism and the speed of redox polymerization can be shown with the following equations:

For the first radical formation,

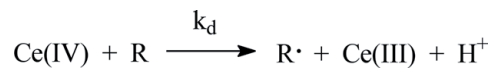

where R is the form of one or two CH₂OH functional groups converted to CH₂O and k_d is the rate constant for initiator cleavage in the redox reaction.

For initiation,

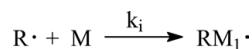

where M in the equation shows the polymerizable monomer by the redox method and k_i shows the starting rate constant.

For growing,

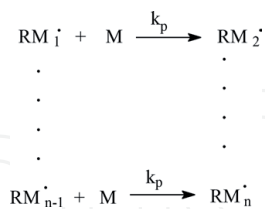

There could be three types of endings: linear, bimolecular, and oxidative termination of the first radical:

For linear termination,

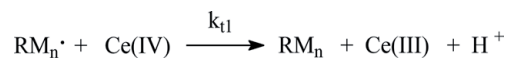

where k_{t1} is the linear termination rate constant.

For bimolecular termination,

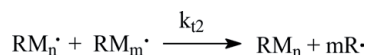

where k_{t2} is the bimolecular termination rate constant.

For oxidative termination of the first radical,

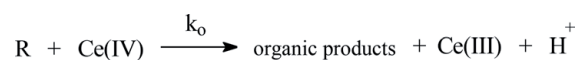

where k_o is the rate constant of the termination of the first radical.

3. Catalysts used in redox polymerization systems

Various compounds such as ceric, manganese, copper, iron, vanadium ion salts, and hydrogen peroxide were used as catalysts for the synthesis of block copolymers through redox polymerization. The ceric-based catalysts are the most widely used in these catalyst systems. The redox systems containing other catalysts were also examined. Ce(IV) or permanganate initiators, which combine with reducing agent containing a hydroxyl or carboxyl group, are the more commonly used initiators.

Ceric salts have shapes such as ceric(IV) ammonium nitrate (CAN), ceric(IV) ammonium sulfate (CAS), ceric(IV) sulfate (CS), and ceric perchlorate. As oxidation strength, ceric perchlorate > ceric nitrate > ceric sulfate were observed (1.7, 1.6, and 1.4 V), respectively, in the studies carried out with vinyl monomers [26]. A wide range of usages in the free radical production has been found by taking advantage of its amplifying properties in redox polymerization. The reduction reaction is given below.

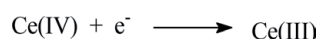

The Ce(IV) salts and the Ce(IV) salt-reducing substance system are used as initiators for vinyl polymerizations in aqueous acidic solutions [27]. Organic reductant substances most commonly used with the Ce(IV) salts are alcohols, glycols, aldehydes, ketones, and carboxylic acids [27, 28]. Ce(IV) salts are used only in acidic solutions and most preferably in 0.5 or higher acid concentrations [29]. The solution's color is yellow. The turning point can be determined even without an indicator in hot and non-dilute solutions.

It has been proven by research that Ce(IV) ion cannot initiate acrylamide polymerization alone and water is not oxidized by Ce(IV) ions [27]. So the radicals that start polymerization occur as a result of the reaction between the Ce(IV) ion and the reducing substance. A general mechanism is proposed for this.

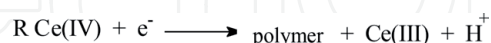

When keeping the concentration of methyl methacrylate and Azo I constant and increasing the concentration of Ce(IV) up to $6 \times 10^{-4} \text{ mol L}^{-1}$, the polymerization rate also increased proportionally with $[\text{Ce(IV)}]^{1/2}$ in the methyl methacrylate polymerization initiated by the hydroxyl functional group with a redox pair Ce(IV)-Azo I. This adherence explains the bimolecular termination. The rapid degradation of polymerization in high Ce(IV) concentrations indicates that active chains are terminated by Ce(IV) [30].

Arslan and Hazer [31] reported the polymerization of methyl methacrylate initiated by ceric ammonium nitrate (MMA) in the form of combination with polytetrahydrofuran diol (PTHF-diol) and polycaprolactone diol (PCL-diol) in aqueous nitric acid. PMMA-*b*-PTHF and PMMA-*b*-PCL block copolymers were obtained. The polymerization reactions are presented in **Scheme 1**.

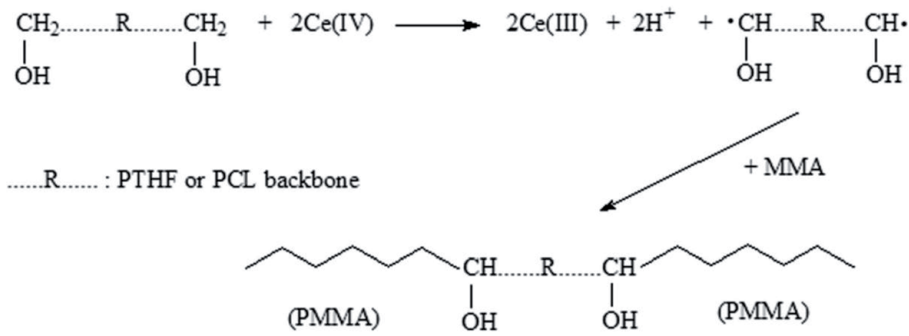

Scheme 1.
 Synthesis of PMMA-b-PCL-b-PMMA block copolymer with PCL-diol/Ce(IV) redox systems.

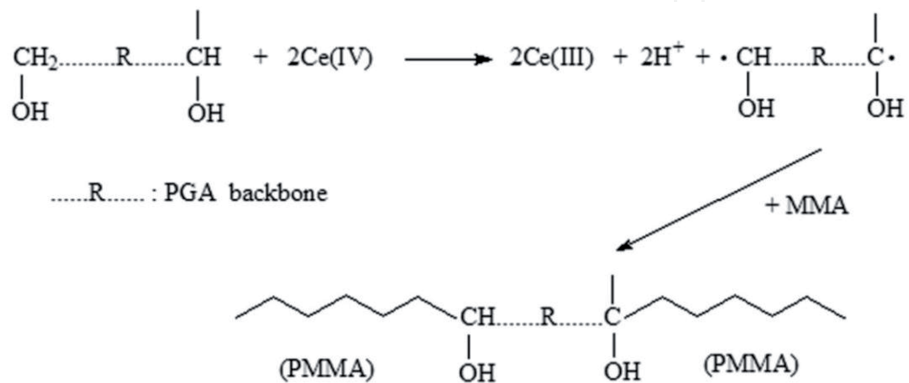

Scheme 2.
 Polymerization of methyl methacrylate initiated by ceric ammonium nitrate in combination with poly(glycidyl azide)-diol (PGA-diol).

Hazer et al. [32] searched the polymerization of methyl methacrylate initiated by ceric ammonium nitrate and poly(glycidyl azide)-diol in the aqueous nitric acid.

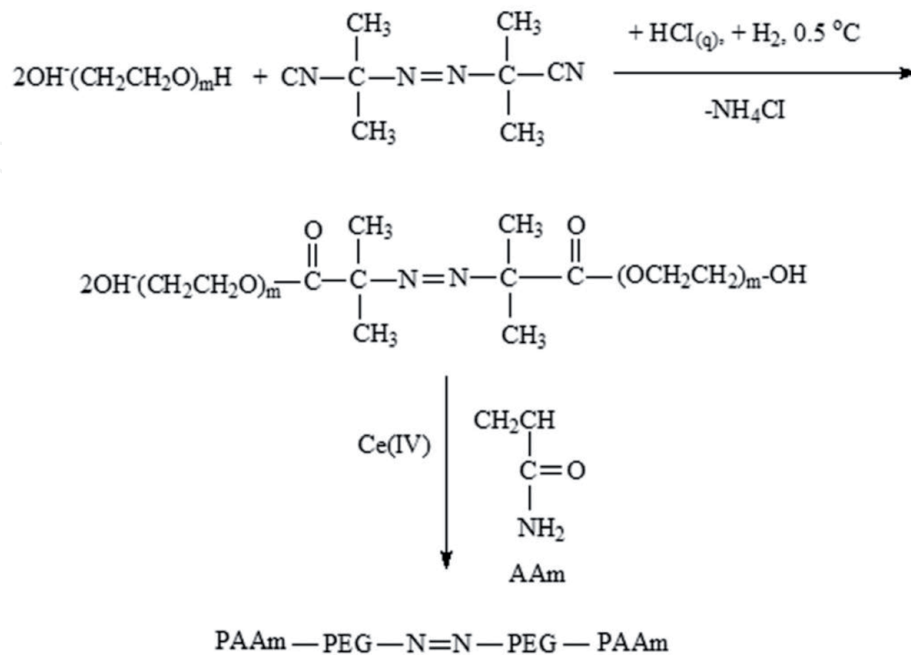

Scheme 3.
 Polymerization of acrylamide with poly(ethylene glycol)azoester/Ce⁺⁴ redox system.

Poly(methyl methacrylate)-*b*-poly(glycidyl acrylate) copolymer was obtained. The reaction mechanism is shown in **Scheme 2**.

Çakmak et al. [33] used redox reactions in the preparation of acrylamide-ethylene glycol block copolymers (PAAm-PEG) containing azo groups in the main chain. The synthesis pathway of the copolymers is shown in **Scheme 3**.

Shimizu et al. [34] synthesized redox reaction with the poly(*N*-isopropylacrylamide-*b*-ethylene glycol) [(PNIPAM)-*b*-(PEG)] thermo-responsive block copolymers in ceric ammonium nitrate catalyzer using the PEG macroinitiator. The synthesis mechanism of block copolymers is shown in **Scheme 4**.

Göktaş et al. [12] evaluated poly(methyl methacrylate)-*b*-poly(*N*-isopropylacrylamide) [PMMA-*b*-PNIPAM] block copolymers in two steps under the catalyzer of ceric ammonium (IV) nitrate (CAN) [Ce(NH₄)₂(NO₃)₆] by using 3-bromo-1-propanol initiator, suitable for both redox polymerization and atom transfer radical polymerization which is one of the controlled radical polymerization techniques. The synthesis mechanisms of the polymerization are shown in **Schemes 5 and 6**.

Zhuang et al. [16] evaluated poly(hydroxyethyl methacrylate)-branched-poly(acrylamide) (PHEMA-*branched*-PAM) polymer by combining atom transfer radical and redox polymerization methods. The synthesis mechanism of the polymer is shown in **Scheme 7**.

Göktaş et al. [35] evaluated poly(methyl methacrylate-*b*-styrene) and poly(methyl methacrylate-*b*-acrylamide) which were synthesized in two steps using a combination of the redox polymerization method and the atom transfer

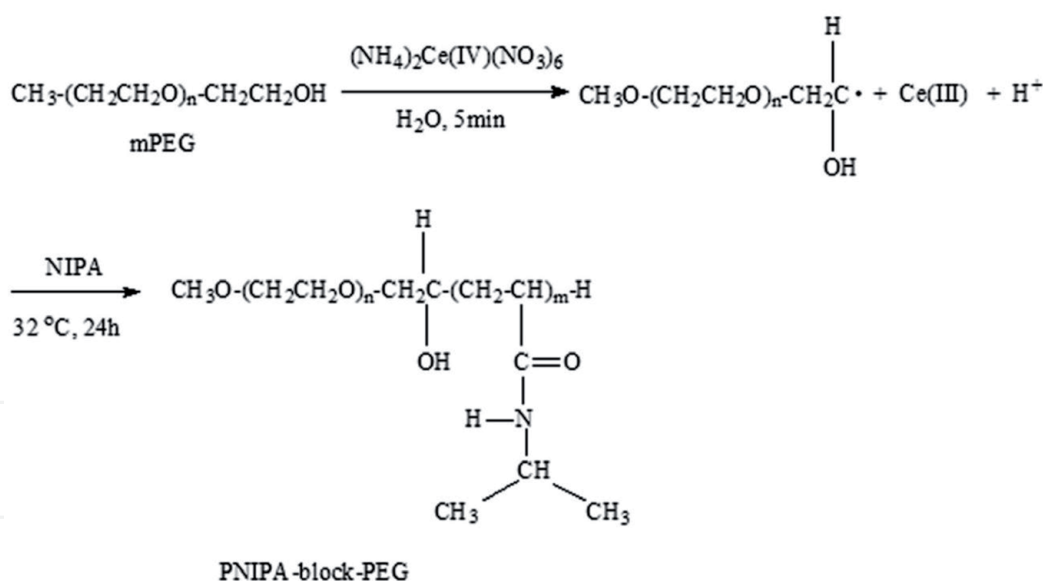

Scheme 4.

Synthesis of poly(*N*-isopropylacrylamide)-block-poly(ethylene glycol) block copolymer via poly(ethylene glycol)/Ce(IV) redox pair.

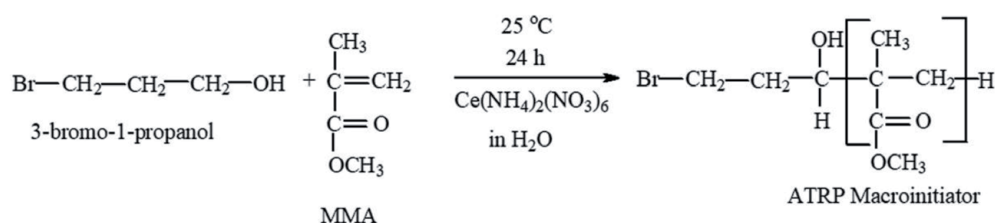

Scheme 5.

Reaction pathways in the synthesis of ATRP macroinitiator.

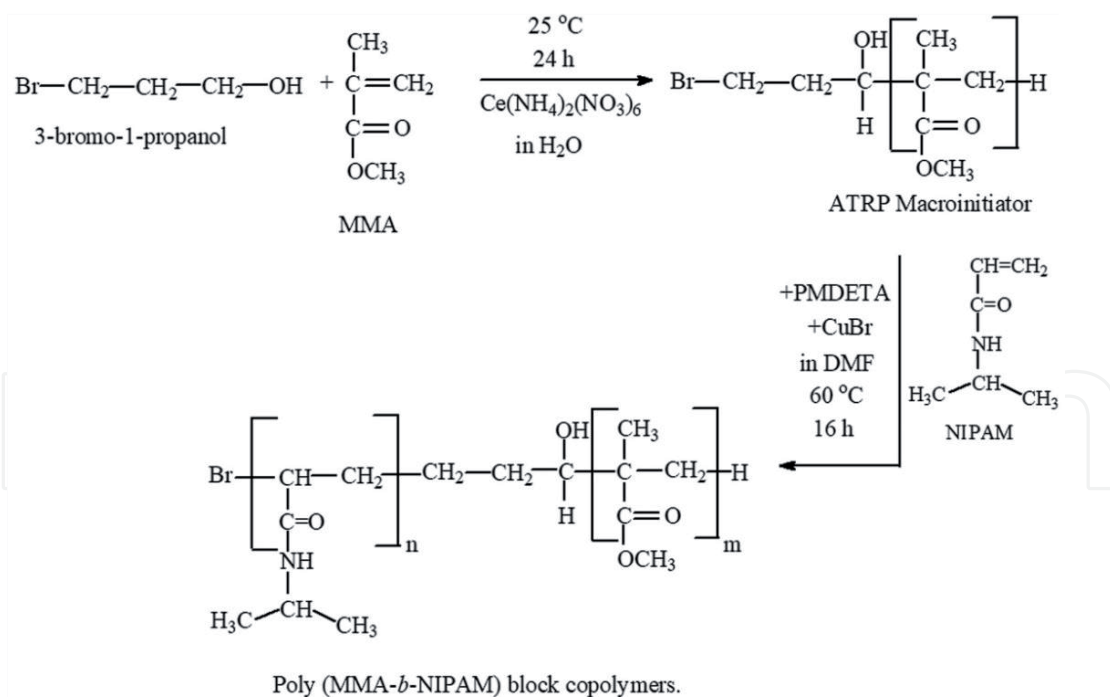

Scheme 6.
 Reaction pathways in the synthesis of PMMA-*b*-PNIPAM block copolymers.

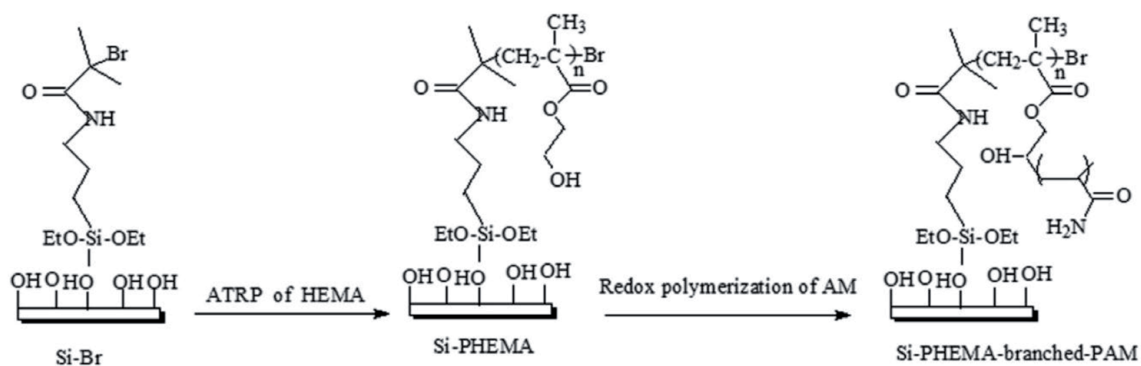

Scheme 7.
 The synthesis route of PHEMA-branched-PAM layers via ATRP and redox polymerization on silicon substrates.

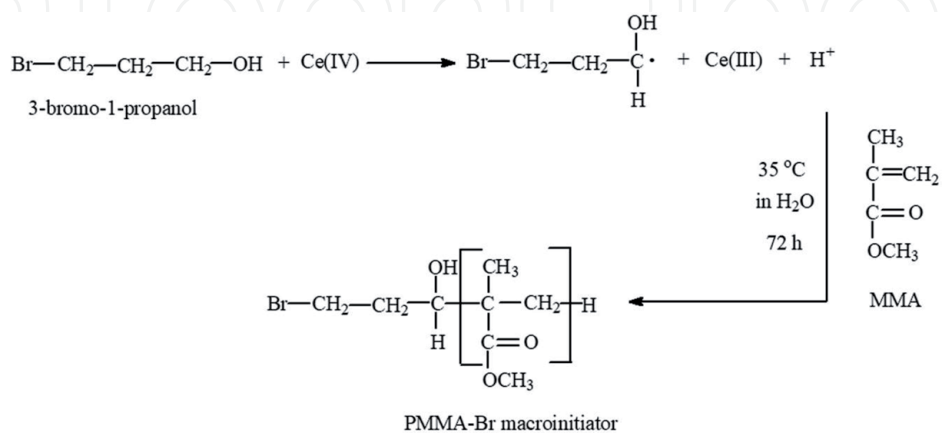

Scheme 8.
Scheme 1 Chemical synthesis of PMMA-Br macroinitiator via redox polymerization.

radical polymerization (ATRP) method. The synthesis mechanisms of the polymerization are shown in **Schemes 8** and **9**.

Çakmak et al. [24] evaluated poly(acrylonitrile)-*block*-poly(ethylene glycol) block copolymer via redox polymerization using Mn(III) as catalyzer. The synthesis pathway of the copolymers is shown in **Scheme 10**.

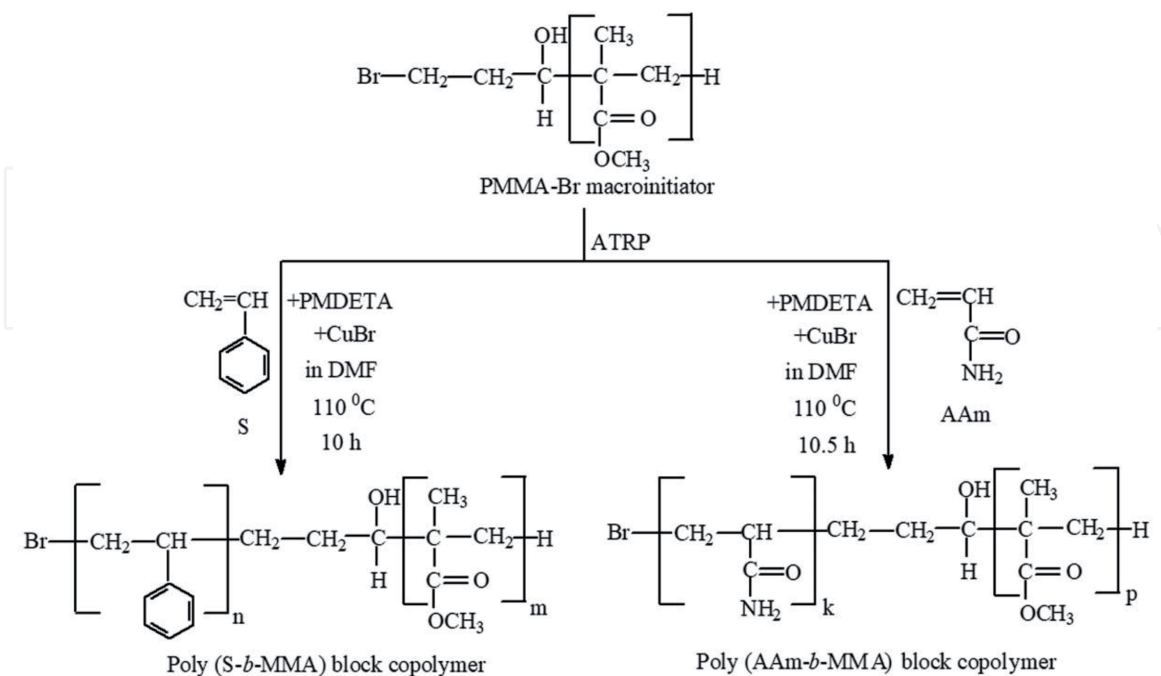

Scheme 9.

Synthetic route poly(MMA-*b*-S) and poly(MMA-*b*-AAm) for block copolymers.

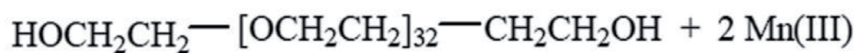

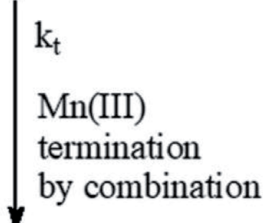
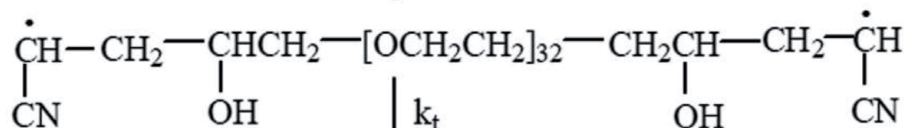
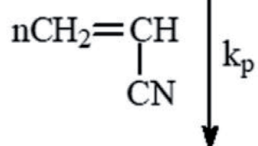
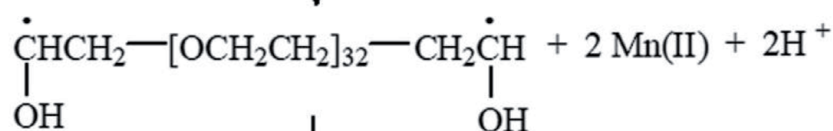
$$\downarrow k_d$$

Scheme 10.

Synthesis of poly(acrylonitrile)-*block*-poly(ethylene glycol) block copolymer via poly(ethylene glycol)/Mn(III) redox couple.

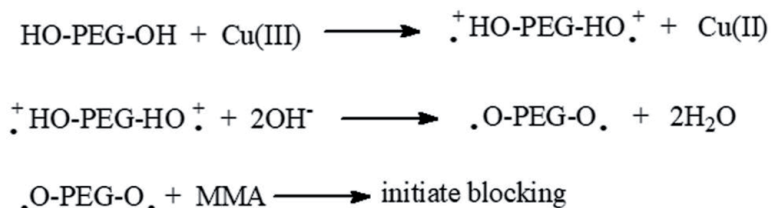

Scheme 11.

Block copolymerization of methyl acrylate (MA) and poly(ethylene glycol) (PEG) using potassium diperiodatocuprate(III)[DPC]/PEG redox system.

Liu et al. [36] evaluated methyl acrylate (MA) and poly(ethylene glycol) (PEG) block copolymers using a novel redox system-potassium diperiodatocuprate(III) [DPC]/PEG system in alkaline aqueous medium. The synthesis mechanism of the polymer is shown in **Scheme 11**.

4. Conclusion

Today, polymer materials science dominates the synthesis and design of polymers with complex architecture and advanced properties. The functional copolymers with block, graft, star, and brush structures can be prepared by controlled radical polymerization techniques. Copolymer synthesis has been important recently, especially by using controlled radical polymerizations in combination with traditional polymerization methods such as cationic polymerization and redox polymerization. This is because the homopolymer formation is minimized in block copolymer synthesis with the combination of such different techniques.

In this study, it was emphasized that block copolymer synthesis has superior properties compared to traditional polymerization methods using the redox polymerization method and different polymerization techniques, because combining different monomers in the same polymer chain in copolymer synthesis with multi-synthesis methods contributes positively to polymer material science.

Author details

Melahat Göktaş

Department of Science Education, Yüzüncü Yil University, Van, Turkey

*Address all correspondence to: melahat_36@hotmail.com

IntechOpen

© 2019 The Author(s). Licensee IntechOpen. This chapter is distributed under the terms of the Creative Commons Attribution License (<http://creativecommons.org/licenses/by/3.0>), which permits unrestricted use, distribution, and reproduction in any medium, provided the original work is properly cited. 

References

- [1] Braun D. Origins and development of initiation of free radical polymerization processes. *International Journal of Polymer Science*. 2009;**2009**:10. DOI: 10.1155/2009/893234
- [2] Misra GS, Bhattacharya SN. Polymerization of acrylamide initiated by the Ce⁴⁺/thiourea redox system. *Journal of Polymer Science: Polymer Chemistry Edition*. 1982;**8**:61-131. DOI: 10.1002/pol.1982.170200114
- [3] Okada S, Matyjaszewski K. Synthesis of bio-based poly(N-phenylitaconimide) by atom transfer radical polymerization. *Journal of Polymer Science: Polymer Chemistry Edition*. 2015;**53**:822-827. DOI: 10.1002/pola.27507
- [4] Lee IH, Discekici EH, Shankel SL, Anastasaki A, De Alaniz JR, Hawker CJ, et al. Desulfurization–bromination: Direct chain-end modification of RAFT polymers. *Polymer Chemistry*. 2017;**8**:7188-7194. DOI: 10.1039/c7py01702b
- [5] Zaremski M, Ereemeev I, Garina E, Borisova O, Korolev B. Controlled synthesis of random, block-random and gradient styrene methyl methacrylate and acrylonitrile terpolymers via nitroxide-mediated free radical polymerization. *Journal of Polymer Research*. 2017;**24**:151. DOI: 10.1007/s10965-017-1303-7
- [6] Diaz-Silvestre S, Saldivar-Guerra E, Rivera-Vallejo C, St Thomas C, Cabello-Romero J, Guerrero-Santos R, et al. Synthesis of associative block copolymers electrolytes via RAFT polymerization. *Polymer Bulletin*. 2018;**75**:891-907. DOI: 10.1007/s00289-017-2071-6
- [7] Chiefari J, Chong YK, Ercole F, Krstina J, Jeffery J, Le TPT, et al. Living free-radical polymerization by reversible addition-fragmentation chain transfer: The RAFT process. *Macromolecules*. 1998;**31**:5559-5562. DOI: 10.1021/ma9804951
- [8] Öztürk T, Göktaş M, Savaş B, Işıklar M, Atalar MN, Hazer B. Synthesis and characterization of poly(vinylchloride-graft-2-vinylpyridine) graft copolymers using a novel macroinitiator by reversible addition-fragmentation chain transfer polymerization. *E-Polymers*. 2014;**14**:27-34. DOI: 10.1515/epoly-2013-0011
- [9] Zhao M, Shi Y, Fu Z, Yang W. Preparation of PMMA-b-PSt block copolymer via seeded emulsion polymerization in the presence of 1,1-diphenylethylene. *Macromolecular Reaction Engineering*. 2014;**8**:555-563. DOI: 10.1002/mren.201300174
- [10] Göktaş M, Öztürk T, Atalar MN, Tekeş AT, Hazer B. One-step synthesis of triblock copolymers via simultaneous reversible-addition fragmentation chain transfer (RAFT) and ring-opening polymerization using a novel difunctional macro-RAFT agent based on polyethylene glycol. *Journal of Macromolecular Science, Part A*. 2014;**51**:854-863. DOI: 10.1080/10601325.2014.953366
- [11] Öztürk T, Yavuz M, Göktaş M, Hazer B. One-step synthesis of triarm block copolymers by simultaneous atom transfer radical and ring-opening polymerization. *Polymer Bulletin*. 2016;**73**:1497-1513. DOI: 10.1007/s00289-015-1558-2
- [12] Göktaş M, Deng G. Synthesis of poly(methyl methacrylate)-b-poly(N-isopropylacrylamide) block copolymer by redox polymerization and atom transfer radical polymerization. *Indonesian Journal of Chemistry*. 2018;**18**:537-543. DOI: 10.22146/ijc.28645

- [13] Öztürk T, Göktaş M, Hazer B. One-step synthesis of triarm block copolymers via simultaneous reversible-addition fragmentation chain transfer and ring-opening polymerization. *Journal of Applied Polymer Science*. 2010;**117**:1638-1645. DOI: 10.1002/app.32031
- [14] Öztürk T, Göktaş M, Hazer B. Synthesis and characterization of poly(methyl methacrylate-block-ethylene glycol-block-methyl methacrylate) block copolymers by reversible addition-fragmentation chain transfer polymerization. *Journal of Macromolecular Science, Part A—Pure and Applied Chemistry*. 2011;**48**:65-72. DOI: 10.1080/10601325.2011.528310
- [15] Öztürk T, Kaygın O, Göktaş M, Hazer B. Synthesis and characterization of graft copolymers based on polyepichlorohydrin via reversible addition-fragmentation chain transfer polymerization. *Journal of Macromolecular Science, Part A—Pure and Applied Chemistry*. 2016;**53**:362-367. DOI: 10.1080/10601325.2016.1166002
- [16] Zhuang D, Shen H, Liu G, Yu C, Yang JA. Combining signal amplification of atom transfer radical polymerization and redox polymerization for visual biomolecules detection. *Journal of Polymer Science Part A: Polymer Chemistry*. 2014;**52**:2791-2799. DOI: 10.1002/pola.27303
- [17] Jones GR, Li Z, Anastasaki A, Lloyd DJ, Wilson P, Zhang Q, et al. Rapid synthesis of well-defined polyacrylamide by aqueous Cu(0)-mediated reversible-deactivation radical polymerization. *Macromolecules*. 2016;**49**:483-489. DOI: 10.1021/acs.macromol.5b01994
- [18] Herman FM, Norman GG, Norbert MB. *Encyclopedia of Polymer Science and Technology*. New York: John Wiley & Sons; 1969. p. 10
- [19] Cakmak I. Synthesis of block copolymers by redox macro initiators. *Journal of Macromolecular Science, Part A*. 1995;**A32**:197-206. DOI: 10.1080/10601329508020328
- [20] Öztürk T, Çakmak İ. Synthesis of block copolymers via redox polymerization process: A critical review. *Iranian Polymer Journal*. 2007;**16**:561-581
- [21] Stewens PM. *Polymer Chemistry: An Introduction*. 3rd ed. New York: Oxford University; 1999. p. 550
- [22] Nagarajan S, Srinivason KSV. Redox polymerization process: An efficient tool for the synthesis of block copolymers. *European Polymer Journal*. 1994;**30**:113-119. DOI: 10.1002/pola.1995.080331710
- [23] Wodka TJ. Studies on the synthesis of block copolymers of acrylonitrile and ethylene oxide. *Applied Polymer Science*. 1993;**47**:407-416. DOI: 10.1002/app.1993.070470304
- [24] Cakmak I. Preparation of multiphase block copolymers by redox polymerization process 2: Polymerization of acrylonitrile by the manganese(III)-poly(ethylene glycol) redox system. *Die Angewandte Makromolekulare Chemie Banner*. 1993;**211**:53-60. DOI: 10.1002/apmc.1995.052240105
- [25] Erbil C. Blok copolymerization and chain extension by using PAAm prepolymer initiated with Ce(IV)-malonic acid. *European Polymer Journal*. 1999;**35**:1747-1754. DOI: 10.1016/S0014-3057(98)00282-1
- [26] Sarac AS. Redox polymerization. *Progress in Polymer Science*. 1999;**24**:1149-1204

- [27] Yagcı C, Yıldız U. Redox polymerization of methyl methacrylate with allyl alcohol 1,2-butoxylate-block-ethoxylate initiated by Ce(IV)/HNO₃ redox system. *European Polymer Journal*. 2005;**41**:177-184. DOI: 10.1016/j.eurpolymj.2004.08.008
- [28] Mino G, Kaizerman S, Rasmussen E. The polymerization of acrylamide initiated by ceric nitrate-3-chloro-1-propanol redox systems. *Journal of Polymer Science*. 1959;**38**:393. DOI: 10.1002/pol.1959.1203813410
- [29] Öz N, Akar A. Redox initiation system of ceric salt and dihydroxy poly(dimethylsiloxane)s for vinyl polymerization. *Journal of Applied Polymer Science*. 2006;**102**:2112-2116. DOI: 10.1002/app.24103
- [30] Tunca U, Serhatli IE, Yagcı Y. Polymerization of acrylamide initiated by the redox system Ce(IV)-4,4'-azobis(4-cyano pentanol). *Polymer Bulletin*. 1989;**22**:483-488. DOI: 10.1007/BF00718923
- [31] Arslan H, Hazer B. Ceric ion initiation of methyl methacrylate using polytetrahydrofuran diol and polycaprolactone diol. *European Polymer Journal*. 1999;**35**:1451-1455. DOI: 10.1016/S0014-3057(98)00221-3
- [32] Arslan H, Eroğlu MS, Hazer B. Ceric ion initiation of methyl methacrylate from poly(glycidyl azide)-diol. *European Polymer Journal*. 2001;**37**:581-585. DOI: 10.1016/S0014-3057(00)00126-9
- [33] Cakmak I, Hazer B, Yagcı Y. Polymerization of acrylamide by the redox system ceric (IV) with poly(ethylene glycol) with azo groups. *European Polymer Journal*. 1991;**27**:101-103. DOI: 10.1016/0014-3057(91)90134-A
- [34] Shimizu H, Yokohara T, Wada R, Okabe M. Influence of preparation conditions of poly(ethylene glycol)/poly(N-isopropylacrylamide) block copolymers on their properties. *Kōbunshi Rombun Shū*. 2004;**61**:640-642. DOI: 10.1295/koron.61.640
- [35] Göktaş M. Synthesis and characterization of various block copolymers using PMMA-Br macroinitiator. *Chemical Papers*. 2019;**73**:2329-2339. DOI: 10.1007/s11696-019-00785-y
- [36] Liu Y, Bai L, Zhang R, Li Y, Liu Y, Deng K. Block copolymerization of poly(ethylene glycol) and methyl acrylate using potassium doperiodatocuprate(III). *Journal of Applied Polymer Science*. 2005;**96**:2139-2145. DOI: 10.1002/app.21594