

We are IntechOpen, the world's leading publisher of Open Access books Built by scientists, for scientists

4,800

Open access books available

122,000

International authors and editors

135M

Downloads

Our authors are among the

154

Countries delivered to

TOP 1%

most cited scientists

12.2%

Contributors from top 500 universities



WEB OF SCIENCE™

Selection of our books indexed in the Book Citation Index
in Web of Science™ Core Collection (BKCI)

Interested in publishing with us?
Contact book.department@intechopen.com

Numbers displayed above are based on latest data collected.
For more information visit www.intechopen.com



Aldosterone Regulation of Protein Kinase Signaling Pathways and Renal Na⁺ Transport by Non-genomic Mechanisms

Warren Thomas and Brian Harvey

Abstract

Aldosterone is the key regulating hormone of whole-body fluid and electrolyte homeostasis. Perturbations in aldosterone synthesis and over-activation of the mineralocorticoid receptor (MR) can lead to excess salt reabsorption and hypertension. The cortical collecting duct (CCD) is the main site of action in the kidney for aldosterone regulation of whole-body sodium homeostasis through actions on the epithelial sodium channel (ENaC) and the Na/K-ATPase (Na/K pump). Aldosterone stimulates ENaC trafficking into the apical cell membranes in the CCD and enhances channel stability and open probability, as well as activating the basolateral membrane Na/K pump to produce an overall increase in the transepithelial reabsorption of sodium. Aldosterone/MR regulates the activity of ENaC in the CCD through both rapid non-genomic (secs-mins) and latent genomic (hours-days) signaling pathways. These rapid and slow responses of renal Na⁺ transport pathways to aldosterone are often treated as distinct and separate events. However, recent evidence points to a close integration between genomic and non-genomic responses to aldosterone to regulate ENaC and Na/K pump activity via protein kinase signaling pathways. Here, we review the integration of aldosterone membrane-initiated non-genomic and nuclear genomic regulations of renal sodium transport via protein kinase signaling pathways and in particular via protein kinase D isoforms.

Keywords: aldosterone, non-genomic, protein kinase D, ENaC, Na/K pump, renal Na⁺ transport

1. Introduction

The distal nephron of the kidney is the principal site for salt conservation in the body, and the dysregulation of Na⁺ homeostasis can contribute significantly to the development of hypertension [1]. Aldosterone is the major salt conservation hormone, and increased circulating levels of the hormone in low Na⁺ diet, salt-wasting, or hypovolemia such as in hemorrhage produce increased sodium reabsorption in target epithelial tissues of the kidney, distal colon, and sweat gland to restore whole-body salt homeostasis and extracellular fluid volume. The kidney and cardiovascular systems are the principal organs for aldosterone action to regulate blood pressure. Rapid non-genomic and latent genomic actions of aldosterone on both renal and cardiac functions

have been described. The main ion transport targets for the natriuretic actions of aldosterone in the kidney are the epithelial sodium channel ENaC and the Na/K-ATPase pump. Aldosterone can also affect other epithelial ion transport systems such as potassium and hydrogen ion secretion by activating the ROMK K⁺ channel and the H⁺-ATPase pump, respectively [2]. Aldosterone regulates sodium transport in the kidney through its actions on ENaC activity in the distal nephron principal cells of the cortical collecting duct (CCD) as well as activating the basolateral membrane Na/K pump, to produce an overall increase in the transepithelial uptake of sodium. Aldosterone also stimulates K⁺ recycling at the basolateral membrane through activation of inwardly rectifying K_{ATP} channels which serves to maintain a favorable cell membrane hyperpolarization for sustained Na⁺ influx via ENaC, in addition to matching K⁺ recycling rate with Na/K-ATPase pump activity to preserve epithelial cross talk (maintaining equilibrium between apical and basolateral ionic permeabilities) [3].

Aldosterone acts on ENaC via its receptor MR to produce rapid (non-genomic) effects on intermediate cell signaling molecules (protein kinases, MAP kinases, SGK, Ca²⁺, pH, etc.) to enhance ENaC membrane trafficking, channel activity, and stability followed by a latent (genomic) phase to increase the expression of ENaC channel subunits and further stabilization of active channels in the apical membrane [4]. For the past 25 years, it was thought that aldosterone and its receptor MR modulated renal sodium reabsorption principally by preventing the membrane retrieval and degradation of ENaC in the cortical collecting duct via serum glucocorticoid kinase (SGK) [5]. However mouse models deficient in or over-expressing SGK did not show alterations in blood pressure or renal Na⁺ excretion, pointing to SGK redundancy or other regulatory ENaC pathways more potent than SGK [6]. A novel aldosterone signaling pathway acting through protein kinase D isoforms (PKD) was discovered over a decade ago [7] which is pivotal in transducing aldosterone/MR regulation of ENaC subcellular trafficking and channel activity in CCD, both by rapid non-genomic and latent genomic signaling mechanisms [2, 4]. The role of rapid aldosterone/MR signaling responses in modulating renal sodium reabsorption and whole-body electrolyte balance is still poorly understood; however, recent observations demonstrate that PKD1 activation by aldosterone rapidly regulates ENaC trafficking, one of the earliest physiological responses to the hormone [8]. This review focuses on non-genomic aldosterone regulation of ENaC and renal sodium transport by protein kinase signaling pathways and the impact of rapid kinase signaling, in particular protein kinase D, on the latent genomic responses to influence renal sodium reabsorption in the CCD.

1.1 Non-genomic actions of aldosterone on ion transporters

Aldosterone tightly regulates epithelial ion transport in the renal CCD by both genomic and non-genomic processes (**Figure 1**). Aldosterone diffuses across the basolateral membrane of the CCD cell and binds to MR in the cytosol inducing receptor dimerization and the translocation to the nucleus. The hormone-receptor complex can bind to GRE response elements and subsequently recruit other transcription factors. During genomic regulation of ion transport, the aldosterone/MR complex acts as a ligand-dependent transcription factor that can induce the expression of several genes including ENaC, Na⁺/K⁺-ATPase, ROMK, and SGK [9–11]. The binding of aldosterone to MR in the cytosol can also stimulate protein kinase signaling pathways. The rapid activation of certain protein kinases such as MAPK and PKD occurs through the transactivation of EGFR [12, 13].

Rapid activation of signal transduction cascades is amplified via aldosterone-stimulated non-transcriptional responses. Current available evidence indicates that aldosterone non-genomic responses in CCD are dependent on the interaction of aldosterone with cytosolic MR and not via a nonclassical membrane-bound

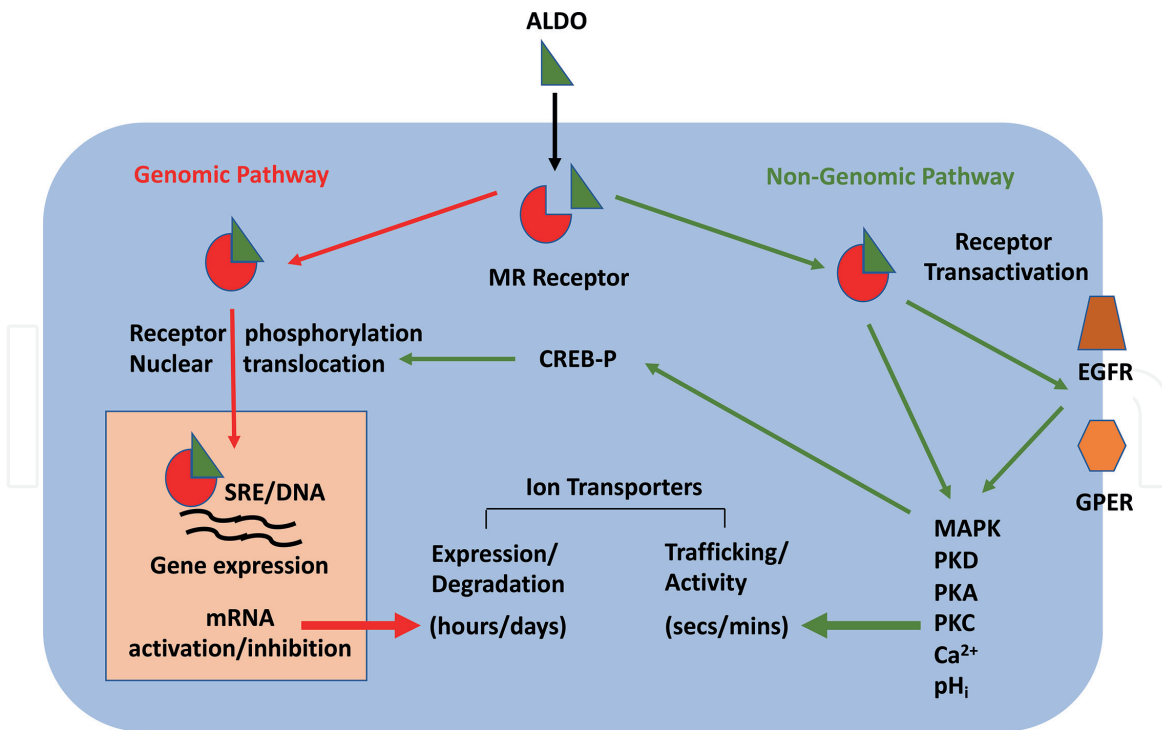

Figure 1.

Genomic and non-genomic actions of aldosterone on epithelial ion transport. In both pathways, aldosterone enters the cytoplasm to bind with MR. A rapid non-genomic signaling pathway is initiated within secs-mins (green arrows) which transactivates the EGFR receptor to produce phosphorylation activation of protein kinases such as MAPK and PKD. Aldosterone may also interact with other receptors such as GPER or directly with specific kinases (PKC and PKA) to modulate intracellular Ca²⁺ or pH. The non-genomic effects of aldosterone result in rapid activation of various ion transporters (ENaC, Na/K pump, Na/H exchanger, K⁺ channels, and H⁺-ATPase pumps). Genomic responses occur on a longer time scale of hours-days (red arrows) and are the result of aldosterone/MR translocation to the nucleus, interaction with DNA steroid response elements, mRNA activation/inhibition, and the delayed expression or degradation of ion transporter proteins. Cross talk exists between genomic and non-genomic pathways in both directions. The rapid activation of protein kinases primes the epithelial cells for the latent genomic response by enhancing the trafficking and membrane localization of ion transporters. In addition, non-genomic MAPK and ERK1/2 signaling can activate transcription factors such as CREB which facilitates nuclear translocation of MR and gene transcription to cause expression of protein kinase signaling intermediates [2, 4].

aldosterone receptor [14]. The signaling cascades which are rapidly activated through the interaction of MR and aldosterone can be inhibited by MR-specific antagonists, for example, spironolactone or eplerenone [15, 16]. There is also strong evidence that, under certain conditions, aldosterone/MR can transactivate other receptors such as the epithelial growth factor receptor EGFR and G-protein estrogen receptor GPER [12, 13, 17].

Non-genomic renal responses to aldosterone have long been described in various experimental animal and cell models. A primary focus of non-genomic aldosterone research has been the rapid actions of aldosterone on the reabsorption of sodium in the distal nephron, in particular rapid regulation of Na⁺ uptake through ENaC and basolateral extrusion of Na⁺ via the Na/K pump [2, 4, 29, 30]. The active sodium transport target for aldosterone was first demonstrated in amphibian urinary bladder [31]. One of the earliest reports of rapid actions of aldosterone on sodium transport in the kidney was in 1957 when Cole described the rapid effect of aldosterone administration for 30 min to cause a reduction in urinary loss of Na⁺ and increased reabsorption by the renal tubules in response to intravenously administered saline in adult male rats [18]. It has also been documented that aldosterone infusion into aldosterone-suppressed rats (by adrenalectomy or infusion with sodium bicarbonate) resulted in the rapid increase in urinary Na⁺ excretion [19]. The rapid non-genomic actions of aldosterone in vivo were further demonstrated in the intact rat when aldosterone induced a rapid increase in urinary Na⁺ excretion within 15 min [20].

Aldosterone has been shown to regulate epithelial K^+ channels involved in transepithelial K^+ secretion and K^+ recycling. In the frog skin epithelium which shares similar functional properties to CCD, aldosterone rapidly activated ATP-sensitive K^+ (K_{ATP}) channels which generate the favorable electrical driving force for apical Na^+ entry via ENaC, through an increase in the open probability of K_{ATP} channels within 15 min of stimulation by hormone [21]. The stimulatory effect of aldosterone on K_{ATP} channels was caused by activation of a Na^+/H^+ exchanger shifting intracellular pH to more alkaline values at which the K_{ATP} channel open probability was highest [22]. The non-genomic effects of aldosterone on K_{ATP} channels and Na^+/H^+ exchanger were very rapid in the frog skin epithelium and renal A6 CCD cells (within 10 min) [23].

The regulation of intracellular pH in epithelia such as the renal CCD occurs via the Na^+/H^+ exchanger family (NHE) which is responsible for the exchange of intracellular H^+ for extracellular Na^+ . NHE, specifically the NHE1 isoform, is expressed in the basolateral membrane in polarized epithelial cells where it plays a role in the regulation of cell volume and cytoplasmic pH. Aldosterone rapidly activates NHE isoforms by non-genomic signaling to promote alkalinization of the cytoplasm within 20 min in the kidney of amphibians [24]. In MDCK cells, the aldosterone-dependent increase in pH_i is linked to the activation of NHE [25]. The rise in pH_i is also dependent on the activation of ERK1/2 along with the rapid increase in $[Ca^{2+}]_i$ that occurs within 1 min of treatment with aldosterone [26]. Other studies using M1-CCD cells showed that aldosterone induced a NHE-dependent increase in the recovery of pH_i from an acid load within 5 min of hormone treatment. The rapid pH recovery response to aldosterone was reduced by $PKC\alpha$ inhibition or by the activation of MAPK [27]. NHE also has a role in regulating cell volume as well as the induction of proliferation and cell growth. In fact, one of the first pieces of evidence for non-genomic actions of aldosterone on the Na^+/H^+ exchanger was reported for cell volume regulation in leukocytes [28].

Another ion transporter target of non-genomic aldosterone signaling in the CCD is the V-type H^+ pump (H^+ -ATPase) which is expressed in intercalated cells of the CCD and is the major mechanism for aldosterone-regulated acid secretion in the kidney. Aldosterone enhances urinary acidification by stimulating H^+ efflux via the H^+ -ATPase pump. This response was first described in turtle bladder [32]. It was later shown in whole-cell patch clamp recordings of mitochondria-rich cells of the frog skin that aldosterone treatment resulted in the rapid exocytotic insertion of H^+ -ATPase pumps into the luminal membrane within 10 min of hormone stimulation [33]. The rapid insertion of H^+ pumps into the membrane was sensitive to PKC inhibition and disruption of the cytoskeleton. In the kidney, the reabsorption of bicarbonate coupled with the release of H^+ into the renal ultrafiltrate in the distal nephron accounts for acid-base regulation. Aldosterone has a crucial role in regulating the renal H^+ -ATPase through non-genomic signaling responses. For example, stimulation with aldosterone for 15 min resulted in the MR-dependent increase in the excretion of H^+ from acidic type A intercalated cells of the outer medullary collecting ducts of mice [34]. These responses in the kidney were similar to that observed in the frog skin whereby the increase in H^+ pump activity was dependent on the Ca^{2+} -induced activity of PKC [33]. Moreover, mice injected with aldosterone displayed an increase in the expression of H^+ -ATPase in the apical membrane of type A intercalated cells [34] further strengthening the evidence for aldosterone in regulating the trafficking of H^+ -ATPase pumps in the maintenance of acid-base homeostasis.

In the renal CCD, K^+ enters the principal cells through the Na^+/K^+ -ATPase in the basolateral membrane and is then secreted into the lumen via K^+ channels along

the apical membrane [35]. The main K⁺ secreting channel in the kidney is ROMK which is expressed in the apical membrane of cells in the ASDN [36]. The function of ROMK is regulated by aldosterone through SGK1 activity which was found to regulate cell surface expression of the channel [37]. K⁺ can also enter the cell through K⁺ channels located in the basolateral membrane of the CCD [38] which may occur due to the stimulation of Na⁺/K⁺-ATPase by mineralocorticoids [39]. ATP-dependent K⁺ channel (K_{ATP}) activity in A6 CCD renal cells was rapidly stimulated by aldosterone (15 min), and this activation modulated the open probability of the channel [21]. Aldosterone has also been shown to produce a non-genomic inhibition of Ca²⁺-dependent intermediate conductance channels (IK_{Ca}) located in the basolateral membrane of colonic crypt cells, and this effect was PKC-dependent [40, 41]. Additionally, aldosterone can also activate Na⁺/H⁺ exchange through Ca²⁺- and PKC-dependent signaling pathways that results in an upregulation of K_{ATP} and an inhibition of IK_{Ca} channels [42]. Taken together, it is evident that aldosterone can induce rapid signaling responses that impact upon several membrane ion transporter targets by modulating intrinsic biophysical and electrophysiological properties of ion channels, pumps, and exchangers.

1.2 Non-genomic actions of aldosterone on protein kinase signaling pathways

Non-genomic effects of aldosterone produce rapid phosphorylation of a wide range of protein kinases such as extracellular stimulus-regulated kinase (ERK) 1/2, protein kinase C (PKC isoforms), cAMP-dependent protein kinase A (PKA), and protein kinase D isoforms (PKD) (**Figure 2**) [2, 4, 29, 42–47]. It is vital to understand how aldosterone stimulation of these signaling cascades augments the activity of sodium ion transporters ENaC and Na⁺/K⁺-ATPase pump in order to establish the physiological relevance of non-genomic signaling for transepithelial Na⁺ reabsorption processes that are instigated in advance of transcriptional control. For the past 25 years, it was thought that aldosterone and the mineralocorticoid receptor modulated renal sodium reabsorption principally by activating the epithelial Na⁺ channel ENaC in the cortical collecting duct via serum glucocorticoid kinase (SGK) [5]. However, mouse models deficient in or over-expressing SGK do not show alterations in blood pressure or renal Na⁺ excretion [6], pointing to redundancy or other regulatory ENaC pathways more potent than SGK.

Aldosterone has been shown to exert rapid non-genomic effects on the activation of several kinase families including PKC, PKD, ERK1/2, and MAPK through the transactivation of EGFR via the non-receptor tyrosine kinase c-Src [2, 4]. The most widely documented mechanism underlying the rapid responses to aldosterone is the activation of protein kinase signaling cascades. Several research groups have investigated the role of ERK1/2 activation in aldosterone-sensitive models such as Madin-Darby canine kidney (MDCK) cells [25], M1-CCD cells [27], vascular smooth muscle cells (VSMC) [48], cardiac myocytes [49], and the mesangial cells of the glomerulus [50]. The activation of ERK1/2 is linked to the variation of cell growth which can occur through hypertrophy [49] or by promoting proliferation [51]. The activation of ERK1/2 is modulated by the simultaneous activation of other signaling cascades. In MDCK cells, the activation of ERK1/2 occurs within 5 min and can be sustained over a period of hours (96). However, in M1-CCD cells, ERK1/2 activation is linked to the transactivation of EGFR and subsequent activation of PKD1 which has been shown to be necessary to maintain the cyclical activation of ERK1/2 beyond 5 min [25]. Additionally, PKD1 involvement in stabilizing ERK1/2 activation occurs in response to growth factors and does not require the direct phosphorylation of ERK1/2 by PKD1 [52]. Aldosterone can also stimulate

Aldosterone-MR Signaling Kinases in Renal CCD

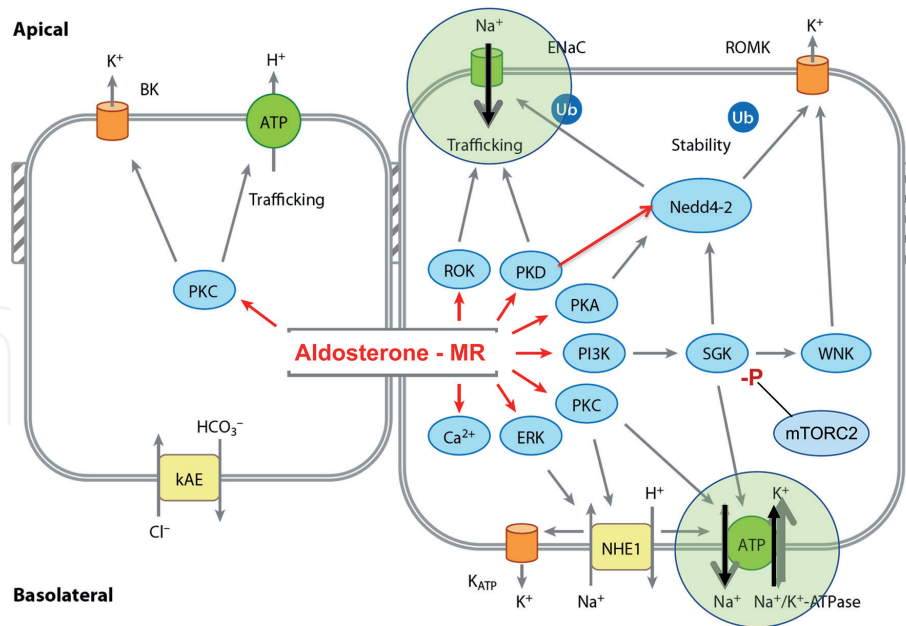

Figure 2.

Aldosterone-induced protein kinase signaling and their modulation of membrane ion transporters in renal CCD. Fundamental signaling intermediates such as protein kinase A (PKA), protein kinase C (PKC), protein kinase D (PKD), phosphoinositide 3-kinase (PI3K), serum- and glucocorticoid-activated kinase (SGK), Rho-activated kinase (ROK), the with no lysine family kinases (WNKs), and the extracellular stimulus-regulated kinase (ERK) are rapidly phosphorylated following treatment with aldosterone. Once activated, these signaling intermediates modulate the activity of ENaC, ROMK, ATP-sensitive K⁺ channels (K_{ATP}), Na⁺/H⁺ exchanger-1 (NHE1), and the Na⁺/K⁺-ATPase in the principal cells of the collecting duct. Aldosterone induces rapid stimulation of H⁺-ATPase pumps in the A-type intercalated cells via PKC-dependent trafficking of the proton pump into the apical membrane. Large-conductance K⁺ (BK) channel activity is modulated by aldosterone and is involved in the shift of kidney anion exchanger (kAE) activity from the basolateral membrane to the apical membrane (modified from [4]).

the prolonged activation of ERK1/2 in CCD cells as this process is coupled to Ki-RasA expression where aldosterone can also stimulate Ki-RasA GTPase activity within 15 min of treatment [53]. Another non-genomic kinase signaling target of aldosterone is the p38 MAPK subfamily. The biphasic activation of p38 in vascular smooth muscle cells (VSMC) can occur within 1 min of aldosterone treatment [54], which is followed by a second activation phase measurable after 30 min. The p38 response in VSMC is dependent on the co-activation of MR and c-Src and links p38 to the pro-fibrotic effects of aldosterone on VSMC via the regulation of NADPH. Furthermore, MR-dependent activation of p38 in glomerular podocytes from rats is also promoted by aldosterone, and this p38 activation contributes to the induction of apoptosis [55].

PKC isoforms have diverse roles and regulate critical cellular processes such as proliferation and trafficking. The PKC family of kinases are well-established targets of rapid aldosterone non-genomic responses [2, 4, 43]. For example, aldosterone can promote the activation of PKC α in renal collecting duct cells within 2–5 min after treatment. This activation appears to occur in an MR-independent manner [56, 57] and involves aldosterone binding directly to the kinase [58] along with a simultaneous rise in intracellular Ca²⁺. Additionally, PKC δ and PKC ϵ can also be rapidly activated in response to aldosterone; however, this does not involve the direct binding of the hormone to the kinase but is coupled to MR through EGFR transactivation [12]. The protein kinase D isoform PKD1 activation by aldosterone follows a similar pattern and has been implicated in the induction of proliferation in M1-CCD cells following aldosterone treatment [59] as well as in the stimulation of hypertrophy in cardiac myocytes [60].

Aldosterone can also upregulate serum glucocorticoid kinases; although this activation can be rapid within 20 min, it does not appear to be a non-genomic response but rather dependent on genomic expression of the kinase. ENaC activity is regulated by the aldosterone-targeted kinase serum glucocorticoid kinases which is present in all eukaryotes and exists in multiple isoforms, for example, SGK1, SGK2, and SGK3. All isoforms have been shown to promote ENaC activity with SGK1 and SGK3 being the most potent stimulators of this activity when they have been co-expressed in *Xenopus* oocytes [61, 62]. Aldosterone and other glucocorticoid hormones induce the transcription of SGK1 by acting via nuclear receptors that bind to the response elements in the SGK1 gene. The subsequent rapid increase in SGK1 at both the protein and mRNA level stimulated ENaC-mediated Na⁺ currents in the epithelium of several tissues such as the kidney, lung, colon, and ocular epithelial cells [5, 63–65]. A rapid increase in ENaC activity by elevation in the channel density at the membrane has been linked to the rapid vesicle trafficking that is coupled to the activation of the RhoA small GTPase [66].

Aldosterone can also promote the activation of second messenger responses such as mobilization of intracellular Ca²⁺, the biosynthesis of cAMP, and the release of nitric oxide. There are many studies documenting the rapid non-genomic rise in intracellular Ca_i²⁺ in response to aldosterone including in CCD cells [67], vascular smooth muscle [68], colonic crypts [42], and the brain [69]. The mechanism by which Ca²⁺ influx occurs in both the colon and the renal nephron has not been fully described; however, Ca²⁺ entry into CCD cells was not sensitive to spironolactone, and Ca²⁺ entry into colonic crypt cells was PKC-dependent via L-type voltage gated channels [70].

The rapid transient activation of cAMP-PKA signaling by aldosterone has been shown in CCD cells, and the phosphorylation of CREB following aldosterone treatment was found to be PKA-dependent [71]. Some research groups have reported aldosterone inducing the activation of PKA; however, they also describe an inhibitory effect between the physiological response stimulated by the cAMP activator forskolin and that stimulated by aldosterone. There is also evidence suggesting that suppressing CREB-dependent transcription occurs via the upregulation of protein phosphatase 2β (PP2β) activation by aldosterone [72]. This could be due in part to the separate activation of isoforms of adenylate cyclase and PKA by forskolin and aldosterone which could result in subcellular compartmentalized signaling. These observations point to a negative feedback loop that is intrinsic to aldosterone signaling thus making cells more refractive to further PKA stimulation after the initial aldosterone-induced response.

1.3 Transduction of non-genomic aldosterone responses through the MR

As MR is at present the only widely recognized receptor that is specific to aldosterone, considerable effort has been put in to understand how nuclear receptors such as MR can initiate rapid non-genomic protein kinase signaling cascades, in particular in concert with the transactivation of membrane-associated receptors EGFR and GPER [13, 17, 73]. A number of strands of evidence point to MR as being the receptor responsible for initiating the aldosterone-induced non-genomic rapid signaling cascades in the CCD [74]. The activation of protein kinases such as PKD and ERK1/2 by aldosterone can be inhibited with the use of MR-specific antagonists such as spironolactone and eplerenone [12, 74]. Moreover, rapid actions of aldosterone in MR-null cells can be conferred through exogenous expression of the receptor in Chinese hamster ovarian (CHO) and human embryonic kidney (HEK) cells [74]. MR can be considered to be a multifunctional receptor. If recombinant MR, which lacks its DNA-binding and coactivator-binding domains, is expressed,

signaling events can be instigated by a rapid response to aldosterone independent of transcriptional activity [75]. In terms of the intermediate phases that couple the aldosterone-MR interaction with the rapid activation of protein kinases, there are still some questions to be addressed.

Aldosterone/MR can activate non-genomic signaling pathways which regulate renal sodium transport and cell proliferation via transactivation of the membrane-bound epidermal growth factor receptor EGFR [12, 59, 76–79]. Several groups have shown a rapid (<5 min) increase in the phosphorylation of EGFR following the treatment with aldosterone which induces ERK1/2 activation and an increase in intracellular Ca^{2+} [12, 81]. A major signaling pathway that is known to mediate MR transactivation of EGFR is the cytosolic tyrosine kinase c-Src pathway [81, 82]. When c-Src is activated, it phosphorylates EGFR to activate ERK1/2 signaling, and when c-Src is inhibited, the rapid effect of aldosterone is completely abolished indicating that aldosterone transactivation of EGFR and MAPK pathways occurs via c-Src. Phosphorylated ERK1/2 can provoke several cellular responses that range from the activation of Na^+/H^+ exchange to cell proliferation [83, 84]. The transactivation of EGFR is not unique to aldosterone and is typically an intermediate step in the transduction of rapid non-genomic membrane-initiated signaling responses stimulated by other steroid hormones such as estrogen [85] and G-protein-coupled receptor agonists [86, 87]. Although it is now well established that the transactivation of EGFR is a fundamental step in linking the initiation of the non-genomic aldosterone/MR signal to aldosterone-responsive downstream kinase signaling intermediates, it has yet to be determined by which molecular mechanism EGFR and its activation are coupled to MR, but it is thought to be ligand-independent EGF. EGFR is phosphorylated by c-Src, within 5 min of treatment with aldosterone, and c-Src phosphorylation could be a significant transducing signal [82]. Cytoplasmic Aldo/MR is recruited into a complex of several proteins including heat shock protein 90 (Hsp90); this complex dissociates on MR activation allowing c-Src phosphorylation of EGFR. The aldosterone-induced phosphorylation of EGFR by c-Src can be blocked by antagonizing Hsp90 interactions with other proteins using the geldanamycin analogue 17-AAG. Inhibiting Hsp90 also suppresses EGFR-dependent downstream signaling events initiated by aldosterone which include the activation of protein kinase D1 [12] and the ERK1/2 mitogen-activated protein (MAP) kinase [25]. The ErbB family of receptor tyrosine kinases (including its member EGFR) can also be activated independently of ligand binding via phosphorylation of specific residues that are distinct from autophosphorylation sites. For example, EGFR can be phosphorylated at Tyr845 by Src tyrosine kinases which result in the activation of EGFR without requiring binding of the receptor to EGF [78, 80, 88].

Other receptors have been implicated in transducing the non-genomic aldosterone actions on protein kinases including stimulation at the membrane that could be initiated via GPCRs, tyrosine kinases, or an as yet “unknown” membrane-associated aldosterone receptor [89]. There is also evidence for direct activation of specific protein kinases by steroid hormones such as vitamin D binding to catalytic domains on the kinase [90], and this appears to be also relevant for aldosterone activation of $\text{PKC}\alpha$ [91]. Aldosterone can bind directly to the C2 domain of $\text{PKC}\alpha$, with a binding affinity of between 0.5 and 1 nM, which results in the autophosphorylation of $\text{PKC}\alpha$ [58]. There have also been numerous reports proposing GPER (GPR30), a G-protein-coupled estrogen receptor, as a novel non-genomic aldosterone receptor [17, 92, 93]. Some rapid responses to aldosterone in smooth muscle have been linked to GPER-coupled signaling pathway in which the expression of GPER is required for the MR-independent rapid effects of aldosterone [94]. However, the specificity of GPER to bind selectively to steroid hormone ligands remains controversial [95].

2. Protein kinase D signaling

Protein kinase D (PKD) is a serine/threonine kinase that includes three isoforms: PKD1/PKC μ , PKD2, and PKD3/PKC ν [96]. PKD isoforms contain a tandem repeat of zinc finger-like cysteine-rich motifs at the N-terminus that exhibit a strong affinity for diacylglycerol (DAG) or phorbol ester as well as a pleckstrin homology domain and a C-terminal catalytic domain that has a similar homology with calmodulin-dependent kinases. While the PKD family contain a homologous catalytic domain, each isoform varies with respect to their subcellular localization, expression, and regulation. PKD isoforms are DAG and PKC effectors that facilitate the actions of growth factors, hormones, and other stimuli that can activate phospholipase C (PLC). PKDs have a pair of C1 domains that bind to DAG and phorbol esters. Membrane-associated DAG can bind to and subsequently activate PKD and in turn recruit PKD via its C1 domains. PKC phosphorylates Ser744 and Ser748 in the activation loop of PKD. DAG-stimulated PKCs (δ , ϵ , θ , and η) have been shown to be PKD dominant activators. However, Ca⁺- and DAG-activated PKCs α , β i, and β ii have also been demonstrated to activate PKD.

PKD isoforms are known to modulate the relative activity of both the ERK and JNK pathways whereby they can attenuate the c-Jun phosphorylation and JNK activation in response to the activation of EGFR while stimulating the ERK and Ras pathways. The PKD family of kinases can regulate budding of secretory vesicles from the trans-Golgi network, and this process is required for locomotion and localization and activity of the Rac1-dependent leading edge in fibroblasts. In addition to a major regulatory role in cell trafficking and motility, PKD also stimulates the recruitment of integrin to newly formed focal adhesions as well as the invasion of cancer cells. Moreover, PKD has been shown to have a role in the regulation of apoptosis, the differentiation of T cells in transgenic models, and reintroduction of DNA synthesis that can be induced by phorbol esters and regulatory peptides that act through Gq-coupled receptors and cardiac hypertrophy [97]. PKD has been implicated as a facilitator of stress and multiple disease states, for example, human hypertrophic cardiomyopathy, the activation of NF κ B which is induced by Bcr-Abl in human myeloid leukemia and in oxidative stress responses. PKD isoform involvement in facilitating a wide array of both normal and abnormal biological actions in different subcellular compartments is most likely to be dependent on dynamic alterations in the isoform spatial and temporal localization in combination with their substrate specificity. This is particularly relevant for understanding the physiological role of non-genomic aldosterone activation of PKD in the regulation of renal Na⁺ transport [2, 4].

Previous studies have shown the PKD isoforms undergo rapid subcellular redistribution in response to cellular stimulation. For example, PKD can be phosphorylated and activated by novel PKC isoforms PKC ϵ and PKC η . We have demonstrated that the aldosterone activation of PKD1 in CCD cells is PKC ϵ dependent [7, 12].

Both PKD1 and PKD2 are known to translocate from the cytosol to DAG-containing microenvironments in the plasma membrane which is followed by PKC-dependent reverse translocation from the membrane to the cytosol where they subsequently accumulate in the nucleus [98]. In contrast to the first two isoforms, PKD3 constantly shuttles between the cytoplasm and the nucleus [99]. The PKD family members can pool and localize at the Golgi complex and the mitochondria. Additionally, PKD1 and PKD2 contain short PDZ-binding motifs in their COOH termini, namely, VSIL in PKD1 and ISVL in PKD2, which can form complexes with regulatory factors in multiple subcellular locations, thereby controlling various cellular activities. The PKD family of kinases are potent regulators of many biological processes such as cell proliferation, polarity, migration, differentiation, reorganization of

the actin cytoskeleton, membrane trafficking, vesicle fission, gene expression, inflammation, and hypertrophy [97]. PKD isoforms are also important players in several pathologies associated with both the cardiovascular and renal systems. For example, PKD1 has been implicated in cardiac hypertrophy, while PKD1 and PKD2 activations have been associated with the proliferation of endothelial cells and angiogenesis.

2.1 Regulation of cell polarity and trafficking by PKD

The establishment and the maintenance of cell polarity are essential for the functions of several cell types including epithelial cells. In polarized epithelial cells, PKD1 and PKD2 regulate the production of TGN carriers that are intended to locate to the basolateral membrane which suggests that PKD isoforms may have a key role in the generation of epithelial polarity [100].

PKD has been implicated in the many facets of the regulation of subcellular trafficking either by maintenance of the structure in the Golgi or by the regulation of fission at the trans-Golgi network (TGN) [101, 102]. PKD can also regulate Golgi to membrane vesicle trafficking by activating phosphatidylinositol (PtdIns) 4-kinase (PI4KIII β) and phosphatidylinositol 4-phosphate 5-kinase (PI4P5K). PKD1 phosphorylates PI4KIII β at the Golgi which in turn promotes vesicle fission and subsequently the rate of protein transport to the plasma membrane.

Activated PKD1 phosphorylates and activates phosphatidylinositol 4-kinase IIIb (PI4KIIIb) at the cis- and trans-Golgi promoting the synthesis of phosphatidylinositol-4-phosphate (PI4P) in the Golgi membrane. Ceramide transport protein is released from the endoplasmic reticulum and binds to PI4P, so transporting lipid from the ER to the Golgi. Ceramide is processed at the Golgi to produce sphingomyelin and diacylglycerol. DAG recruits PKD1 and novel PKC isoforms as well as multiple proteins recruited to sites of PI4P biogenesis in the Golgi. These include the arfaptin family proteins. These proteins contain a BAR (Bin/Amphiphysin/Rvs) domain with a concave anionic surface that interacts with negatively charged lipid membranes to facilitate vesicle fission. Other known substrates for PKD1 include actin cytoskeleton regulatory proteins such as cofilin, LIM kinase (LIMK), and rhotekin that contribute to actin-dependent intracellular vesicle trafficking.

2.2 Non-genomic aldosterone signaling through protein kinase D pathways

Aldosterone/MR signaling via PKD signaling pathways has been shown to be a key regulator of the transduction of non-genomic responses to the hormone [2, 4]. In renal CCD cells, PKD1 acts as a potent regulator of ENaC and Na⁺/K⁺-ATPase trafficking and activity under basal and aldosterone-stimulated conditions [102]. The activation of PKD1 at the trans-Golgi network (TGN) by aldosterone is an important regulatory mechanism of ENaC trafficking. Aldosterone rapidly (<5 min) induces the interaction between PKD1 and PI4KIII β which regulates the signaling of protein kinases and the lipid modification that is essential for vesicle fission. The rapid phosphorylation activation of PKD1 by aldosterone primes the CCD cells for subsequent transcriptional events which increase the expression of ENaC channel subunit proteins. Vital roles of other PKD isoforms including PKD2 and PKD3 in the CCD are emerging with the identification of novel substrates for this kinase family that include other kinases and transcription factors responsible for modulating gene expression and intracellular trafficking. All three PKD isoforms are highly expressed in renal CCD cells and were found to be localized to principal cells in mouse and rat CCD using AQP1 co-localization immunofluorescence assays (**Figure 3**). Rats fed a low Na⁺ diet for 2 weeks showed increased expression of PKD1 in the CCD principal cells. Confocal immunohistochemistry microscopy revealed the basal expression of PKD1 to be

mainly in the trans-Golgi network and cytosolic compartment; PKD2 was localized almost exclusively at the apical membrane, whereas PKD3 was mainly localized in the cytosol and nucleus (**Figure 3**).

The different PKD isoforms exhibit distinct differences in terms of their subcellular localization, which is also influenced by cell type [103]. We have established that PKD1 is expressed throughout the cytosol of principal cells in the renal CCD cells with accumulation in the trans-Golgi network proximal to the nucleus (266). This structure was identified as the TGN with the use of a specific marker, TGN38. PI4KIII β is phosphorylated by PKD1 at the TGN with subsequent upregulation in vesicle fission, and we found that PI4KIII β was also localized to the TGN in M1-CCD cells [8]. The TGN association of PI4KIII β was not affected by the suppression of PKD1 expression. Treatment with aldosterone did not affect the distribution of PKD1 or PI4KIII β at the TGN but did promote the formation of an immunoprecipitable complex between these two kinases within 5 min. This complex remained stable for at least 30 min, consistent with the sustained autophosphorylation of PKD1 detectable following treatment with aldosterone [7]. The interaction between these two kinases was also observed following the long-term aldosterone stimulation ranging between 1 and 24 h.

2.3 Integration of aldosterone genomic and non-genomic actions through PKD signaling pathways

Recent work has focused on the physiological role of non-genomic actions of aldosterone, its consequences for genomic responses, and the integration or cross

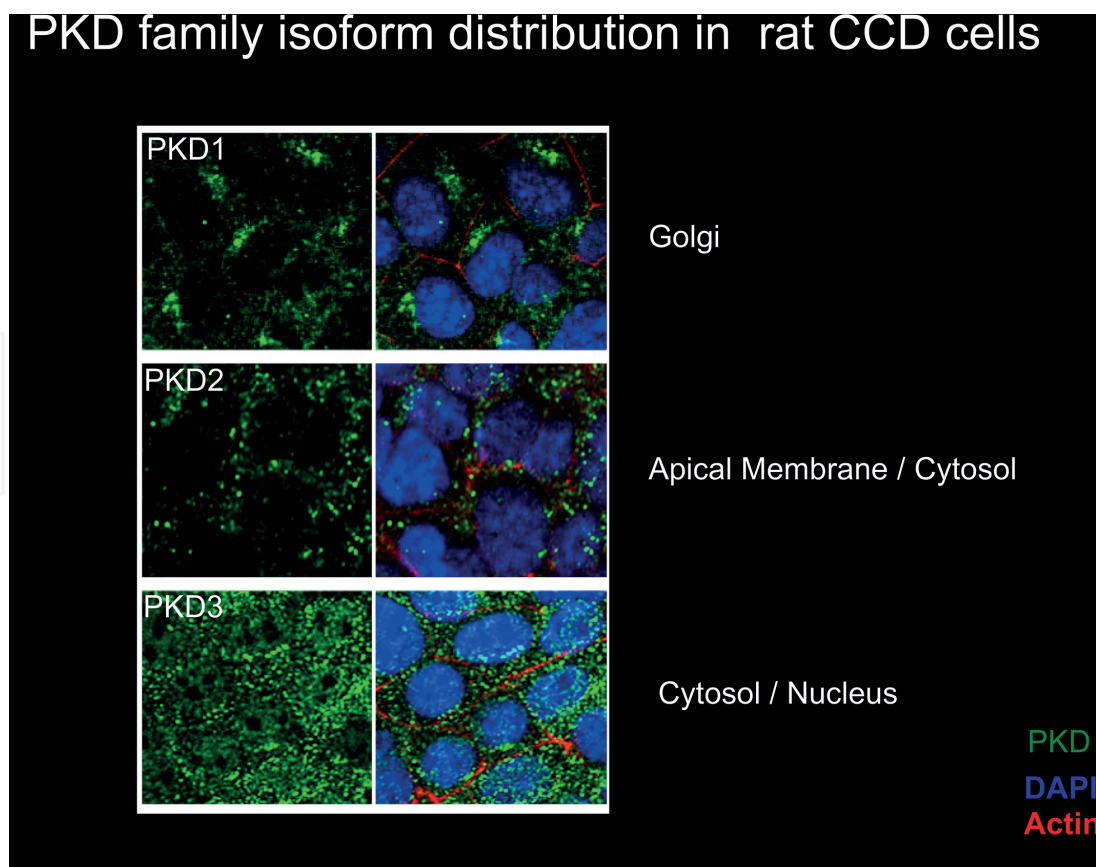

Figure 3. Subcellular distribution of PKD isoforms in rat renal CCD cells. The PKD isoforms are stained with isoform-specific fluorescence antibodies in green, the nucleus with DAPI stain in blue, and the plasma membrane with actin in red. Following aldosterone treatment, PKD1 rapidly (10 min) localized to apical and basolateral plasma membranes, PKD2 moved out of the apical membrane into the cytosol, and PKD3 became concentrated in the nucleus.

talk between rapid and latent hormone responses for regulating renal Na⁺ reabsorption [2, 4, 104, 105].

The activity of crucial rapid signaling intermediates such as PKD, Rho-activated kinase (ROK), protein kinase A (PKA), phosphoinositide 3-kinase (PI3K), PKC, ERK, SGK, and with no lysine family kinases (WNK) can be modulated by aldosterone. Aldosterone activates some or all of these signaling pathways to modulate ENaC channel activity along with other transporters involved in transepithelial sodium reabsorption such as the ATP-sensitive K⁺ channel and Na⁺/K⁺ pump in principle cells of the CCD. The activation of aldosterone/MR also leads to a suppression of Nedd4-2 ubiquitin ligase activity via SGK which promotes ENaC abundance in the apical membrane [5]. Aldosterone stimulates transcriptional changes in promoting SGK-1 thus inactivating Nedd4-2. This inactivation of Nedd4-2 leads to an increase in ENaC abundance possibly by inhibiting degradation of the channel rather than by membrane insertion or stabilization of the channel complex.

The rapid non-genomic signaling responses induced by aldosterone affect multiple protein kinase signaling pathways, either by directly affecting their activity or indirectly through the modulation of MR-dependent transcription. Both PKC δ and PKC ϵ can be rapidly activated in response to aldosterone; however, this is not reliant on the direct binding of aldosterone to the kinase. The rapid activation is instead coupled to MR via the transactivation of EGFR (109). The rapid activation of PKD1 in response to aldosterone is now known to be a substrate for novel, Ca²⁺-independent PKC isoforms (nPKCs), for example, PKC δ and PKC ϵ . In renal CCD cells, aldosterone stimulates PKD1 activation in the same manner as aldosterone-induced activation of nPKC isoforms. The rapid activation of PKD1 is coupled to MR through the transactivation of EGFR [12].

Aldosterone (rapidly <5 min) activates (phosphorylation) PKD1 in CCD cells through MR transactivation of the EGF receptor involving downstream PKC δ and PKC ϵ and ERK signaling. Aldosterone activation of PKD1 caused translocation of ENaC and Na/K-ATPase pump subunits from the trans-Golgi network to apical and basolateral membrane domains, respectively, within 15 min, via the PKD1-PI4KIII β trafficking signaling pathway. Knockdown of PKD1 resulted in a 50% reduction in the basal transepithelial Na⁺ transport rate concomitant with mislocalization of ENaC to basolateral membranes and Na/K pumps to apical membranes. PKD1 knockdown prevented the genomic response of aldosterone-stimulated transepithelial Na⁺ reabsorption as measured by the amiloride-sensitive short-circuit current (SCC) in Ussing chambers [8].

Protein kinase D2 is also rapidly activated by aldosterone to modulate ENaC membrane abundance and stability. CCD epithelia in which PKD2 was knocked down showed an increased localization and stabilization of ENaC in apical membranes and an increased basal SCC of fivefold above control levels in wild-type CCD after 24 h. Paradoxically, aldosterone treatment inhibited SCC by 40% after 24 h in PKD2 null M1 cells. However, the SCC levels following aldosterone treatment in PKD2 null CCD epithelia were still 30% higher than the SCC levels observed in aldosterone-treated wild-type CCD. In addition, PKD2 knockdown has revealed a novel inhibitory pathway for aldosterone regulation of ENaC activity which may have a physiological function to “brake” over-stimulation of renal Na reabsorption in the CCD [109].

The protein kinase D3 isoform appears not to mediate non-genomic aldosterone responses. Knockdown of PKD3 in CCD cells did not affect the non-genomic responses to aldosterone on ENaC trafficking but reduced the genomic response to the hormone to increase the expression of ENaC alpha subunits and SGK [109].

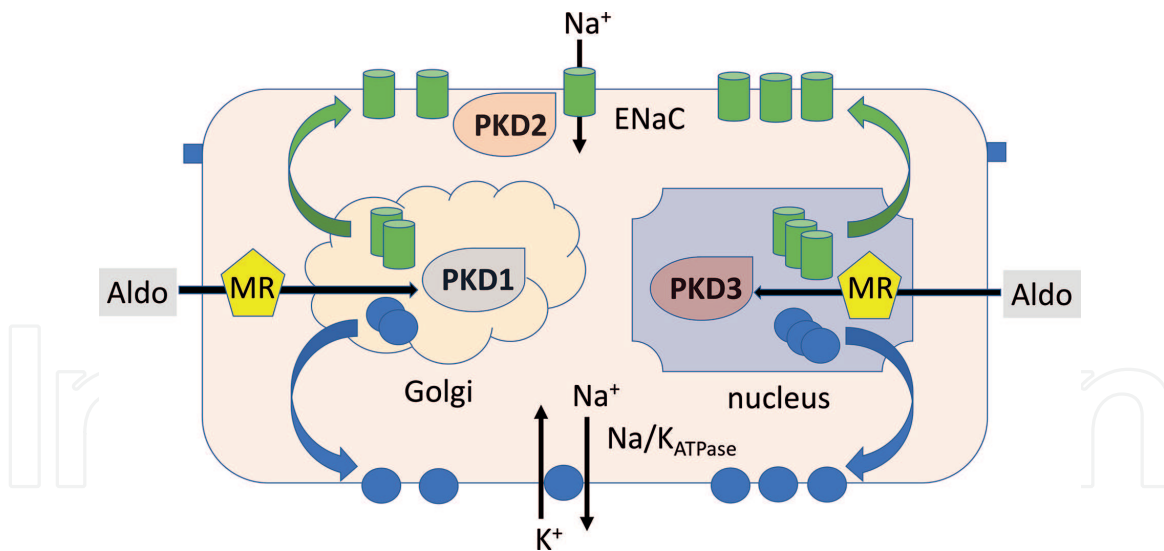

Figure 4. PKD isoforms regulate ENaC and Na/K pump activity by both non-genomic and genomic aldosterone/MR signaling in the CCD. PKD signaling integrates non-genomic and genomic responses to aldosterone through non-genomic PKD1-stimulated ENaC and Na/K pump trafficking from the trans-Golgi network to apical and basolateral membranes, respectively, and PKD2-dependent ENaC membrane stabilization, and genomic PKD3-stimulated ENaC subunit expression.

PKD isoforms are a major critical and essential signal transduction pathway for the transduction of both non-genomic and genomic aldosterone/MR regulation of Na⁺ transport in the CCD. PKD signaling integrates non-genomic and genomic responses to aldosterone through PKD1-stimulated ENaC and Na/K pump trafficking, PKD2-dependent ENaC membrane stabilization, and PKD3-stimulated ENaC subunit expression (Figure 4).

2.4 Mechanisms of PKD activation by aldosterone

PKD isoforms are downstream targets for active PKCs and can be activated by agonists of G-protein-coupled receptors. Aldosterone induces both rapid phosphorylation and activation of PKD1 [12]. It has been shown that aldosterone activation of PKD1 in CCD cells is PKCε-dependent via aldosterone/MR transactivation of the EGF receptor. The molecular mechanisms of aldosterone activation/phosphorylation of PKD2 and PKD3 isoforms are currently unknown.

2.5 The mineralocorticoid receptor is a non-genomic receptor for aldosterone PKD signaling

A number of strands of evidence point to MR as being the receptor responsible for initiating the aldosterone-induced rapid activation of PKD signaling cascades. The activation of protein kinases such as PKD and ERK1/2 by aldosterone, for example, can be inhibited with the use of MR-specific antagonists such as spironolactone and eplerenone. MR can be considered to be a multifunctional receptor. If recombinant MR which lacks its DNA-binding and coactivator-binding domains is expressed, signaling events can be instigated by a rapid response to aldosterone independent of transcriptional activity. The aldosterone/MR-induced phosphorylation of PKD1 via EGFR transactivation by c-Src can be blocked by antagonizing Hsp90 interactions using the geldanamycin analogue 17-AAG. This suppresses EGFR-dependent downstream PKD1 signaling events initiated by aldosterone that include the activation of ENaC trafficking and the ERK1/2 mitogen-activated protein (MAP) kinase [7, 8].

3. Aldosterone regulation of ENaC activity via PKD signaling pathways

Our research group has published a series of papers describing the molecular mechanisms of PKD1 modulation of ENaC Na⁺ channel trafficking and function by aldosterone [2, 4]. Non-genomic aldosterone signaling mainly regulates ENaC activity by stimulating ENaC trafficking from the cytosol to the apical membrane and by enhancing membrane abundance and membrane stability of functional channels. Aldosterone treatment rapidly stimulates the apical translocation of ENaC α , ENaC β , and ENaC γ subunits in wild-type M1-CCD via PKD1 signaling, but in PKD1 knockdown cells, aldosterone treatment fails to increase ENaC subunit abundance at the apical membrane which remains localized in the cytoplasm. Thus the trafficking process of ENaC α , ENaC β , and ENaC γ to the apical membrane is defective in CCD cells suppressed in PKD1 expression and indicates a critical role of this protein kinase in regulating subcellular trafficking of ENaC subunits by aldosterone. The rapid effects of aldosterone on ENaC subcellular redistribution precede the genomic increase in the Na⁺ transport rate through ENaC in CCD cells which is normally detected between 2 and 4 h following treatment with aldosterone and peaks between 16 and 24 h. We have previously reported that the formation of membrane-bound structures that were found to be rich in ENaC subunits was observed following aldosterone stimulation for 5 min. It has been proposed that an ER-Golgi intermediate compartment could be the initial site for the post-ER sorting of proteins. This is consistent with the subcellular redistribution of ENaC channel subunits observed within 2 min of aldosterone stimulation. Previous studies on ENaC-related acid-sensing ion channel (ASIC) suggested that a functional heterodimeric ENaC assembles in the endoplasmic reticulum prior to it undergoing posttranslational modifications as it passes through the Golgi. ENaC is found in vesicles throughout the cytoplasm of cells under high Na⁺ where its depletion or exposure to aldosterone results in the subsequent translocation of ENaC to the apical membrane without undergoing transcriptional changes [106]. The rapid surface translocation of ENaC and its increased activity has been reported in response to agonists; for example, a twofold increase in the amiloride-sensitive short-circuit current (SCC, transepithelial Na⁺ current) was observed after 25 min of treatment with forskolin in CCD cells [107]. This increase in SCC coincided with an increase in the apical membrane expression of ENaC. Aldosterone/MR controls the transcription of ENaC α in renal cells, while the remaining subunits, ENaC β and ENaC γ , are expressed constitutively. We have previously shown that the long-term treatment with aldosterone increases the localization of ENaC α and ENaC β at the apical membrane in M1-CCD cells which is dependent on PKD1 expression and activation [7]. Further studies showed that aldosterone induces the rapid translocation of ENaC β and ENaC γ to the plasma membrane within 30 min of treatment and that this translocation, in common with PKD1 activation, was MR-dependent [8].

Aldosterone also induces a rapid phosphorylation (activation) and redistribution of PKD2 from the apical membrane into the cytosol of CCD cells. Genetic suppression of PKD2 in renal CCD cells results in an increase in the abundance of ENaC γ at the apical membrane under both basal and aldosterone-treated conditions. The abundant expression of ENaC at the apical membrane is associated with very high basal Na⁺ currents through ENaC in PKD2 knockdown CCD epithelia and reveals a tonic inhibition of ENaC function by PKD2 under basal conditions [109]. In its inactive state, PKD2 stimulates the retrieval of the ENaC γ channel subunits out of the apical membrane back into the cytosol thus de-stabilizing ENaC membrane expression and activity. Aldosterone treatment removes this tonic endocytosis of ENaC by phosphorylating PKD2 causing the kinase to be removed from the membrane and inhibiting the retrieval of ENaC γ into the cytosol. In contrast, when PKD2 expression

was suppressed by siRNA, the tonic retrieval of ENaC from the apical membrane was removed and ENaC expression was stabilized and enhanced at the membrane resulting in very large basal ENaC-mediated Na⁺ currents. Moreover, a paradoxical inhibitory effect of aldosterone on ENaC Na⁺ currents was observed in PKD2 knock-down CCD cells. Given that ENaC activity is a balance between membrane expression and retrieval, the overall regulation of transepithelial sodium transport under basal and aldosterone-stimulated conditions is under the influence of the relative effects of PKD1, PKD2, and SGK1 on ENaC stability in the membrane (**Figure 5**).

3.1 Molecular mechanisms of ENaC trafficking regulated by PKD1

Membrane-localized ENaC is subject to constant recycling. The inclusion of ENaC into the apical membrane is a prerequisite for its ubiquitination and retrieval into the subapical pool or its degradation by the proteasome. Nedd4-2 interacts with ENaC through a C-terminal PY internalization motif to facilitate ENaC ubiquitination. The surface expression of ENaC may be equally regulated by deubiquitination by DUBs and ubiquitination by Nedd4-2. However, only PKD1 and PKD2 isoforms provide the composite signaling pathway for the basal control and acute stimulatory effect of aldosterone that influences cellular trafficking dynamics controlling ENaC and Na/K pump membrane targeting, insertion, stabilization, and retrieval (**Figure 6**).

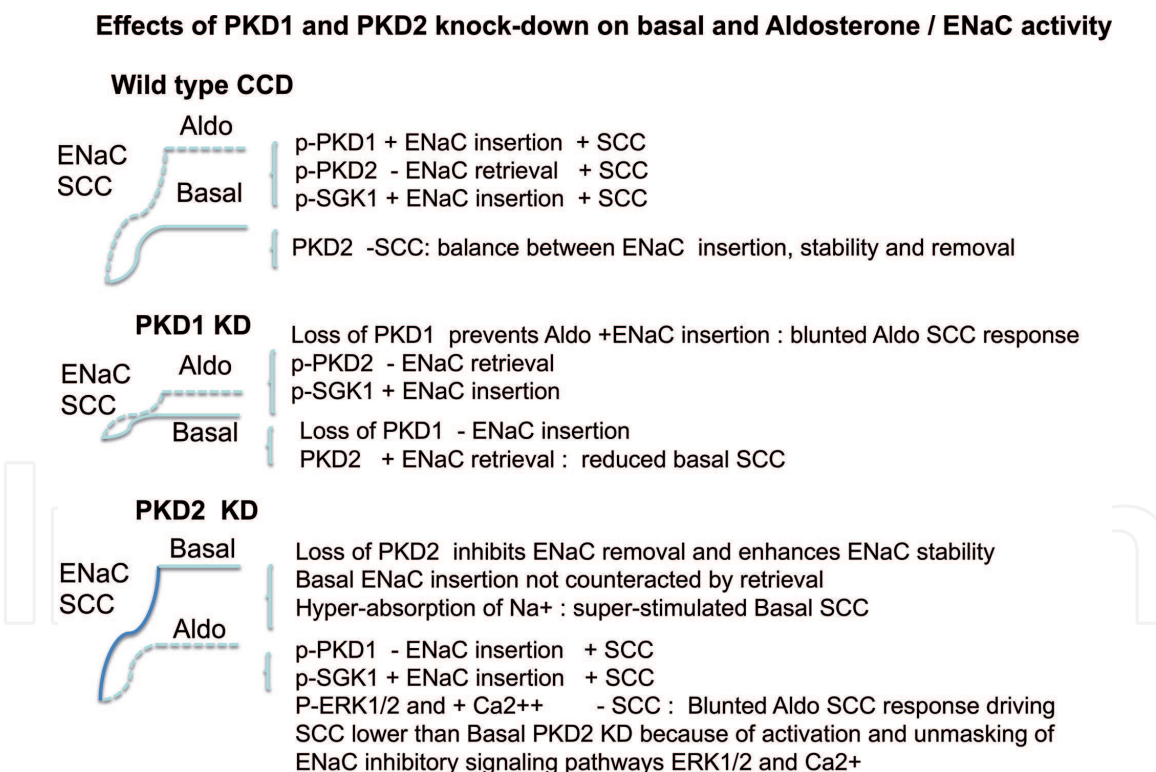

Figure 5. Effects of PKD1 and PKD2 knockdown on basal and aldosterone-regulated ENaC activity. In wild-type CCD cells, aldosterone induces an increase in the ENaC-dependent transepithelial sodium transport measured by the amiloride-sensitive short-circuit current (*I_{sc}*) in M1-CCD epithelia mounted in Ussing chambers. *I_{sc}* is stimulated following aldosterone phosphorylation and activation of PKD1 and SGK1 which together stimulate and stabilize the trafficking of ENaC into the apical membrane. Aldosterone also phosphorylates PKD2 which decreases the retrieval of ENaC back into the cytosol and contributes to the increase in *I_{sc}*. When PKD1 is suppressed (PKD1 KD), ENaC membrane insertion is decreased, and both basal and aldosterone *I_{sc}* responses are suppressed. Knocking down PKD2 (PKD2 KD) in CCD cells has an inhibitory effect on the retrieval of ENaC from the apical membrane thus enhancing the stability of the channel resulting in an elevated basal *I_{sc}*. Paradoxically, hormone stimulation in PKD2 knockdown CCD inhibits *I_{sc}* and produces a blunted *I_{sc}* response compared to aldosterone-treated wild-type CCD. Thus PKD2 KD unmasks an inhibitory aldosterone signaling pathway which reduces functional ENaC activity.

ENaC and Na/K pump membrane targeting is under the control of PKD1

PKD1 knock-down inverses the membrane sorting of ENaC and Na/K pump

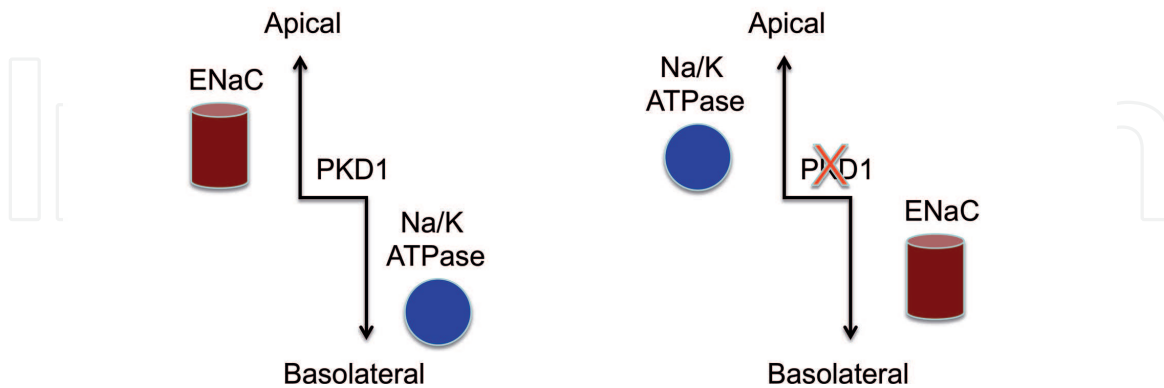

Figure 6.

ENaC and Na/K pump membrane targeting under the control of PKD1. PKD1 regulates the correct targeting of ENaC and Na⁺/K⁺-ATPase to the apical and basolateral membranes, respectively. Knocking down PKD1 expression in CCD cells results in the defective membrane sorting of ENaC and Na/K pump such that their membrane expression polarity is inverted.

3.2 Molecular mechanisms of ENaC trafficking regulated by PKD2

The rapid non-genomic activation of PKD1 by aldosterone has been demonstrated in renal CCD and the implications this has on renal Na⁺ absorption in terms of trafficking and activity of transporters such as ENaC and Na⁺/K⁺-ATPase pump. To date, less is known about the role of PKD2 in regulating basal ENaC and Na/K pump activity and aldosterone-stimulated renal Na⁺ reabsorption. There is evidence from transcriptomics studies that the *Pkd2* gene is expressed in the mouse distal convoluted tubule and the collecting duct but not in the connecting tubule [108]. PKD2 protein expression had not been described in the kidney before, and recent studies have shown the expression of PKD2 in mouse and rat distal renal tubules *ex vivo* and in M1-CCD cells *in vitro* [109]. The PKD2 isoform was found to be ubiquitously expressed along the length of the distal tubule with the highest expression in the distal convoluted tubule and the connecting tubule and lower levels of expression along the collecting duct. PKD2 was expressed primarily in the principle cells and to a lesser extent in the intercalated cells. The distribution of PKD2 was also determined in rats fed a normal Na⁺ diet and a diet poor in Na⁺ in order to elevate plasma levels of aldosterone so as to determine if high aldosterone states can cause shifts in the cellular distribution of PKD2 in the distal nephron. Under basal conditions, the PKD2 cellular distribution appeared mainly localized at the apical membrane (co-localized with AQP2) and showed the lowest expression in the cytosol and was excluded from the nucleus. A similar subcellular distribution of PKD2 was observed in confluent M1-CCD monolayers which also exhibited high PKD2 expression at the plasma membrane and low expression in the cytosol. In high aldosterone states, PKD2 translocates from the apical membrane to a cytosolic compartment. Thus PKD2 shows the opposite pattern of subcellular expression compared to PKD1 under both basal and aldosterone-stimulated conditions. The mechanism by which aldosterone produces a redistribution of PKD2 from the plasma membrane may involve PKC which is also rapidly activated by aldosterone in CCD.

The question arises if PKD2 has a role in regulating the subcellular expression and trafficking of ENaC channel subunits as has been observed for PKD1 in CCD. In other renal tissues, PKD2 has also been shown to function in the basolateral transport of proteins, and knocking down PKD2 affects the membrane trafficking of E-cadherin and β 1-integrin [100]. In polarized MDCK cells, the transient expression of a PKD2 kinase-dead mutant resulted in the co-accumulation of E-cadherin, β 1-integrin, and the PKD2 mutant at the TGN. It has also been suggested that PKD2 is unlike the other two PKD isoforms because the activation of PKD2 was not shown to induce its redistribution to the nucleus from the cytoplasm. It has also been shown that the activation of NF κ B by PKD2 occurs in response to oxidative stress and is not dependent on its catalytic activity. This suggests that PKD2 could have a distinctive regulatory property in comparison to PKD1 and PKD3.

The role of PKD2 in early rapid signaling responses to aldosterone stimulation in Na⁺ transport has become clearer. Previous work has shown that PKD1 is activated in M1-CCD cells within 5 min in response to aldosterone. A similar activation kinetics has been observed for PKD2 in M1-CCD cells where aldosterone stimulated the autophosphorylation of PKD2 within 10 min coupled with translocation of PKD2 from the cell membrane to the cytosol [109]. Moreover, under low Na⁺ diet and high aldosterone states, a similar shift in the cellular distribution of PKD2 occurs in the rat distal nephron.

Recent studies have revealed a novel role for PKD2 in the trafficking of ENaC channel subunits [109]. Under basal conditions, ENaC γ is mainly localized in the cytosol. Upon stimulation with aldosterone, ENaC γ is trafficked to the apical membrane, but this response was absent in M1-CCD cells where PKD2 expression was knocked down using siRNA. The genetic silencing of PKD2 in M1-CCD cells produced a higher basal expression of ENaC γ in the apical membrane and a corresponding stimulation of Na⁺ transport through ENaC. Paradoxically, aldosterone treatment produced a redistribution of ENaC γ out of the apical membrane into the cytosol and a suppressed Isc response in M1-CCD cells deficient in PKD2 (**Figure 5**).

Genetic knockdown of PKD2 in M1-CCD cells results in a stimulation of transepithelial Na⁺ transport under basal conditions. This increase in ENaC activity corresponds with an increase in basal expression of ENaC γ in PKD2 knockdown CCD when compared to wild-type cells. An inhibition of PKD2-dependent endocytotic retrieval of ENaC channel subunits into the cytosol may result in an increase in both the total ENaC abundance in the membrane and the increase in channel activity. Another possibility for the increase in transepithelial sodium transport in PKD2 knockdown cells could result from an increase in the PKD1-dependent trafficking of ENaC channel subunits. There is also a possibility that PKD1 activity could increase in order to compensate for the absence of PKD2 by upregulating PI4KIII β trafficking and therefore affecting ENaC membrane insertion. Unexpectedly, aldosterone treatment stimulated a retrieval of ENaC γ from the apical membrane into the cytoplasm in PKD2-deficient CCD cells. The inhibition of transepithelial Na⁺ transport by aldosterone in PKD2 knockdown CCD presents a paradox for the classical activation of ENaC by the hormone in wild-type CCD. One would presume that aldosterone could continue to stimulate ENaC activity in the absence of PKD2 in this model due to an upregulation of PKD1- and SGK-dependent ENaC trafficking and membrane stabilization. However, from these findings, we propose that PKD1 and PKD2 exert opposite effects on ENaC membrane abundance and that aldosterone, by activating PKD2 and removing it from the membrane, releases a tonic inhibition of ENaC stability exerted by unphosphorylated PKD2. The translocation and targeting of ENaC and Na/K pump to the apical membrane and basolateral membranes and their membrane stabilization are dependent on cooperative PKD1 and PKD2 non-genomic signaling that may potentiate or synergize with the latent genomic aldosterone

effects on ENaC protein expression and membrane abundance. PKD1 is a crucial regulator of the apical membrane-directed trafficking of ENaC. Furthermore, it was shown that PKD1 regulates the membrane localization of the Na⁺/K⁺-ATPase pump, and knocking down PKD1 resulted in the mislocalization of the pump β subunit to the apical membrane and bulk accumulation of the pump protein in the cytosol rather than in the basolateral membranes [8]. Similarly, aldosterone stimulation of PKD1 knockdown M1-CCD cells failed to increase the basolateral membrane abundance of the Na⁺/K⁺ pump normally seen in wild-type cells (**Figure 7**).

3.3 PKD1, PKD2, SGK1, and the regulation of ENaC membrane trafficking and stability

The upregulation of SGK1 is the earliest transcriptional and translational response that is elicited by aldosterone, whereas PKD1 and PKD2 are the earliest activated kinases in the non-genomic response to aldosterone in the regulation of ENaC trafficking and stabilization in the apical membrane stabilization. The interactions between aldosterone-stimulated PKD1, PKD2, and SGK have not been investigated; however, certain predictions to guide future research can be proposed and tested (**Figure 8**). Given that PKD1, PKD2, and SGK would be expected to enhance ENaC trafficking, insertion, and stability and to reduce ENaC retrieval and degradation following aldosterone treatment, it would be expected that some cross talk and coordination would exist between these kinases in their kinetics of activation, subcellular localization, and cooperativity. However, from previous

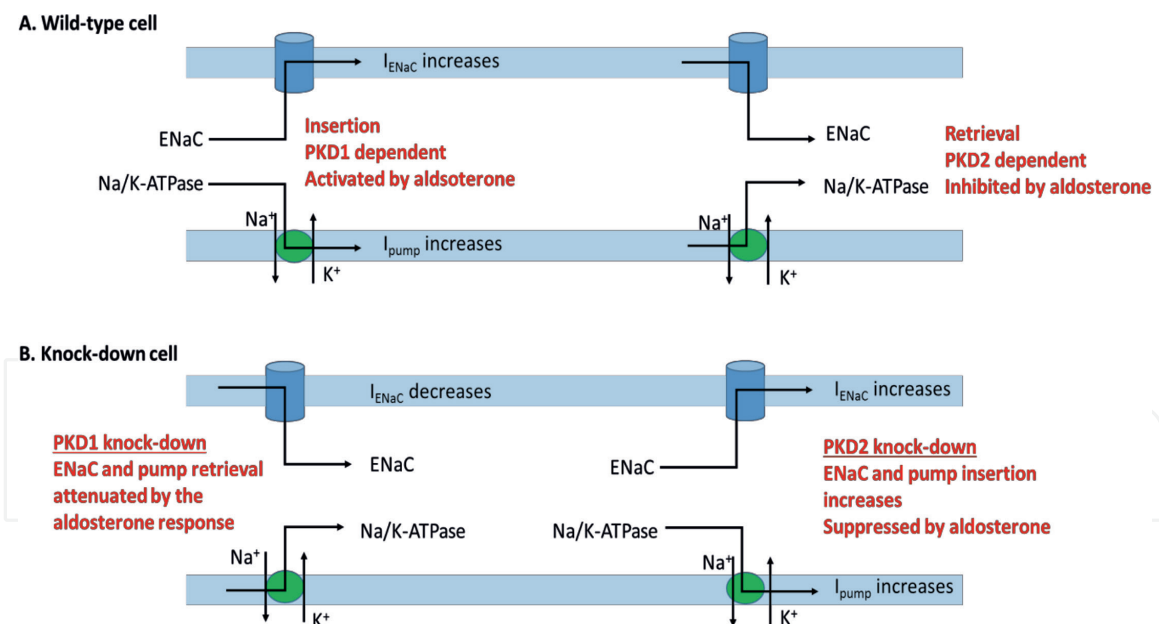

Figure 7.

PKD isoforms exert opposite effects on the membrane abundance and localization of ENaC and Na/K pump with consequences for Na⁺ transport. The PKD1 isoform regulates the insertion of ENaC channel subunits into the apical membrane of CCD cells. Aldosterone activates the PKD1-dependent trafficking of ENaC subunits to the membrane. In contrast, PKD2 exerts a tonic inhibitory effect on ENaC by stimulating the retrieval of ENaC from the apical membrane into the cytosol under basal conditions. Stimulating PKD2 with aldosterone results in the inhibition of ENaC retrieval back into the cytosol and an increased abundance of ENaC at the apical membrane along with an increase in ENaC activity. Genetic knockdown of PKD1 inhibits ENaC trafficking into the apical membrane under both basal and aldosterone conditions, whereas knockdown of PKD2 releases the tonic inhibition of ENaC activity and suppresses its retrieval by the kinase resulting in a higher abundance and membrane stability of ENaC with consequent elevated Na⁺ reabsorption (I_{ENaC} and I_{pump}). Aldosterone produces a paradoxical inhibition of ENaC membrane abundance and depresses Na⁺ reabsorption in PKD2 knockdown CCD.

ENaC membrane insertion, stability and removal regulated by PKD1:PKD2:SGK1

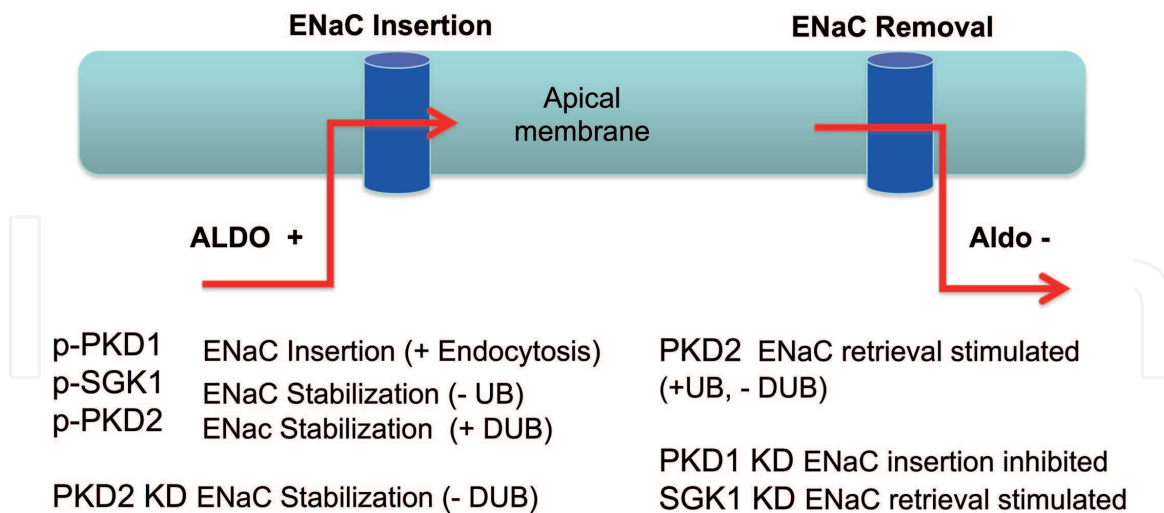

Figure 8.

ENaC membrane insertion, stability, and removal are under the control of interactions between PKD1, PKD2, and SGK1. Aldosterone activates PKD1 to stimulate the insertion of ENaC into the apical membrane. The PKD1-dependent insertion of ENaC increases endocytosis of preformed ENaC subunits into the apical membrane. Additionally, SGK1 is phosphorylated to prevent the ubiquitination of ENaC. In the basal unphosphorylated state, PKD2 tonically stimulates the retrieval of ENaC from the apical membrane. When PKD2 is phosphorylated by aldosterone, the activated PKD2 may increase deubiquitination thus stabilizing ENaC in the membrane. Genetic silencing of PKD2 results in the stabilization of ENaC in the apical membrane which may be due to a decrease in the activity of deubiquitinases. Knocking down SGK1 in CCD cells stimulates the retrieval of ENaC from the membrane while suppressing PKD1 results in the inhibition of ENaC insertion in response to aldosterone.

work it appears that SGK does not play an essential role in basal or Na⁺ deprivation-induced renal Na⁺ transport or ENaC activity, whereas PKD1 and PKD2 expression and activation are absolutely critical for the maintenance of basal and aldosterone-stimulated ENaC function and transepithelial sodium transport.

3.4 PKD3 regulation of ENaC and renal Na⁺ transport

To date, the role of PKD3 in the kidney remains unknown. PKD3 is unlike the other two isoforms whereby it is present in the nucleus as well as the cytoplasm in unstimulated cells. Currently, investigations of PKD3-dependent signaling pathways in the kidney are lacking, while studies in other tissues and cell types have been reliant on the use of non-specific pharmacological inhibitors or the use of small interfering RNA (siRNA). We have used both siRNA and CRISPR/Cas knock-down of PKD3 in M1-CCD cells to obtain some insights into a potential role for PKD3 in the renal transport of sodium. Preliminary data show that PKD3 is primarily localized in the cytoplasm and perinuclear region and translocates to the nucleus under aldosterone treatment or low Na⁺ diet [109].

PKD3 knockdown resulted in reduced genomic expression of the ENaC α subunit and SGK. Long-term treatment with aldosterone (24–48 h) produced a reduced sodium transport rate in PKD3 suppressed cells compared to wild-type CCD. Knockdown of PKD3 did not interfere with PKD1 nor PKD 2 non-genomic signaling in response to aldosterone nor did it significantly affect basal Na⁺ transport rates. It thus appears that PKD3 is a genomic signal pathway for aldosterone regulation of ENaC and SGK and may synergize and reinforce with the non-genomic PKD1 and PKD2 modulation of ENaC trafficking and membrane stabilization (**Figure 9**).

Aldosterone – PKD 1,2,3 integrate membrane-initiated MR-EGFR and nuclear MR regulation of Salt Absorption and Blood Volume

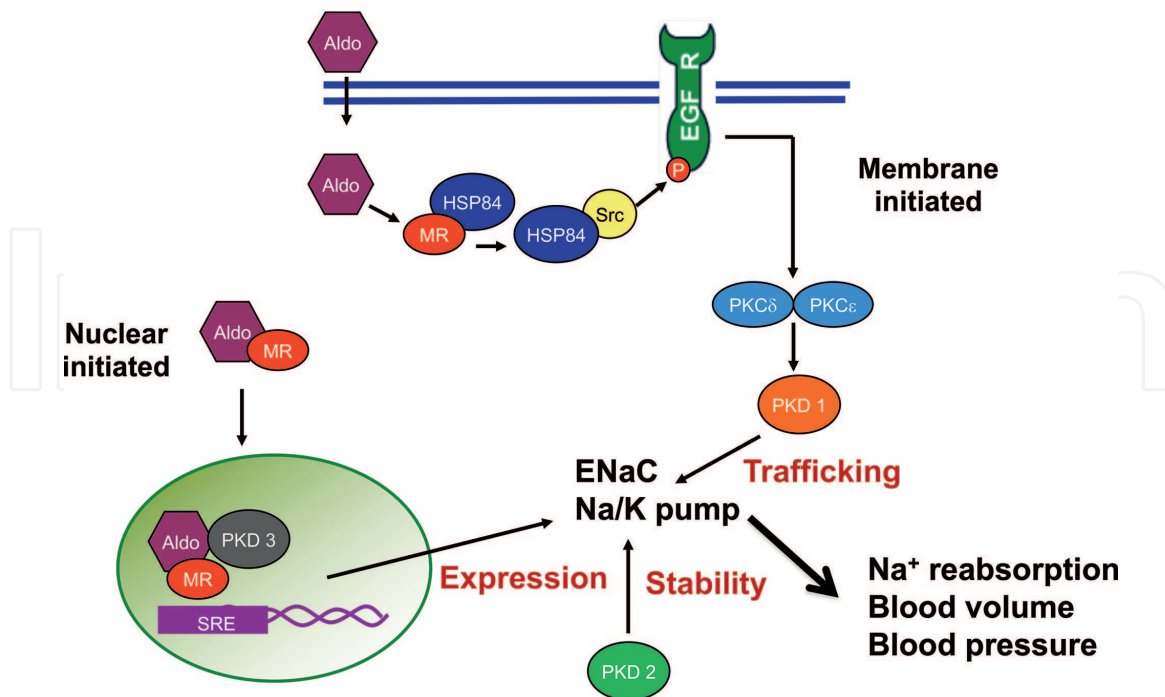

Figure 9. Regulation of ENaC and Na/K pump by protein kinase D isoforms. PKCδ and PKCε can be rapidly activated in response to aldosterone. The rapid activation of PKC is coupled to MR via the transactivation of EGFR through c-Src. PKD1 is the downstream of PKCδ and PKCε, and once activated, it is responsible for the trafficking of ENaC channel subunits from the cytosol to the apical membrane. PKD2 activation by aldosterone removes a tonic inhibition of ENaC membrane stability and increases the stability of ENaC channels in the membrane. PKD3 activation exerts a stimulatory effect on the expression of ENaC channel subunits and SGK, further amplifying and sustaining the non-genomic response to regulate renal Na⁺ reabsorption and blood volume/pressure.

4. Conclusions and perspectives

The physiological and pathophysiological roles of PKD isoforms in different biological systems are becoming better understood with the identification of novel substrates for this family of kinases that also interact with other kinases and transcription factors which modulate intracellular trafficking, membrane targeting, and stability of ion transport proteins. These PKD isoform-regulated biological processes fine-tune the aldosterone/MR-dependent transcriptional events and act as important intermediaries between rapid non-genomic signaling and latent transcriptional responses activated by aldosterone to regulate renal electrolyte homeostasis. The development of PKD isoform-specific knockdown or knockout renal CCD cell lines and animal models has the potential to reveal novel rapid non-genomic and genomic roles for PKD isoforms to regulate basal and aldosterone-stimulated ENaC and Na⁺/K⁺-ATPase pump activity in renal CCD cells.

Acknowledgements

This publication is based upon work from the EU COST Action ADMIRE BM1301 in Aldosterone and Mineralocorticoid Receptor Physiology and Pathophysiology www.admirecosteu.com.

IntechOpen

Author details

Warren Thomas^{1,2} and Brian Harvey^{1,3*}

1 Department of Molecular Medicine, Royal College of Surgeons in Ireland, Beaumont Hospital, Dublin, Ireland

2 Perdana University, PU-RCSI School of Medicine, Serdang, Selangor, Malaysia

3 Centro de Estudios Científicos CECs, Valdivia, Chile

*Address all correspondence to: brianharvey@rcsi.com

IntechOpen

© 2019 The Author(s). Licensee IntechOpen. Distributed under the terms of the Creative Commons Attribution - NonCommercial 4.0 License (<https://creativecommons.org/licenses/by-nc/4.0/>), which permits use, distribution and reproduction for non-commercial purposes, provided the original is properly cited. 

References

- [1] Pimenta E, Gordon RD, Stowasser M. Salt, aldosterone and hypertension. *Journal of Human Hypertension*. 2013;**27**(1):1-6. DOI: 10.1038/jhh.2012.27
- [2] Harvey BJ, Thomas W. Aldosterone-induced protein kinase signalling and the control of electrolyte balance. *Steroids*. 2018;**133**:67-74. DOI: 10.1016/j.steroids.2017.10.009. Epub 2017 Oct 24. Review
- [3] Urbach V, Van Kerkhove E, Maguire D, Harvey BJ. Cross-talk between ATP-regulated K⁺ channels and Na⁺ transport via cellular metabolism in frog skin principal cells. *The Journal of Physiology*. 1996;**491**(Pt 1):99-109
- [4] Thomas W, Harvey BJ. Mechanisms underlying rapid aldosterone effects in the kidney. *Annual Review of Physiology*. 2011;**73**:335-357. DOI: 10.1146/annurev-physiol-012110-142222
- [5] Pearce D. SGK1 regulation of epithelial sodium transport. *Cellular Physiology and Biochemistry*. 2003;**13**(1):13-20
- [6] Fejes-Tóth G, Frindt G, Náráy-Fejes-Tóth A, Palmer LG. Epithelial Na⁺ channel activation and processing in mice lacking SGK1. *American Journal of Physiology. Renal Physiology*. 2008;**294**(6):F1298-F1305. DOI: 10.1152/ajprenal.00579.2007
- [7] McEneaney V, Harvey BJ, Thomas W. Aldosterone regulates rapid trafficking of epithelial sodium channel subunits in renal cortical collecting duct cells via protein kinase D activation. *Molecular Endocrinology*. 2008;**22**(4):881-892. DOI: 10.1210/me.2007-0225
- [8] Dooley R, Angibaud E, Yusef YR, Thomas W, Harvey BJ. Aldosterone-induced ENaC and basal Na⁺/K⁺-ATPase trafficking via protein kinase D1-phosphatidylinositol 4-kinaseIII β trans Golgi signalling in M1 cortical collecting duct cells. *Molecular and Cellular Endocrinology*. 2013;**372**(1-2):86-95. DOI: 10.1016/j.mce.2013.03.011
- [9] Asher C, Wald H, Rossier BC, Garty H. Aldosterone-induced increase in the abundance of Na⁺ channel subunits. *The American Journal of Physiology*. 1996;**271**(2 Pt 1):C605-C611
- [10] Beesley AH, Hornby D, White SJ. Regulation of distal nephron K⁺ channels (ROMK) mRNA expression by aldosterone in rat kidney. *The Journal of Physiology*. 1998;**509**(Pt 3):629-634
- [11] Kolla V, Litwack G. Transcriptional regulation of the human Na/K ATPase via the human mineralocorticoid receptor. *Molecular and Cellular Biochemistry*. 2000;**204**(1-2):35-40
- [12] McEneaney V, Harvey BJ, Thomas W. Aldosterone rapidly activates protein kinase D via a mineralocorticoid receptor/EGFR trans-activation pathway in the M1 kidney CCD cell line. *The Journal of Steroid Biochemistry and Molecular Biology*. 2007;**107**(3-5):180-190. Epub 2007 Jun 22
- [13] Grossmann C, Gekle M. Nongenotropic aldosterone effects and the EGFR: Interaction and biological relevance. *Steroids*. 2008;**73**(9-10):973-978. DOI: 10.1016/j.steroids.2007.12.008
- [14] Dooley R, Harvey BJ, Thomas W. Non-genomic actions of aldosterone: From receptors and signals to membrane targets. *Molecular and Cellular Endocrinology*. 2012;**350**(2):223-234. DOI: 10.1016/j.mce.2011.07.019
- [15] Michea L, Delpiano AM, Hitschfeld C, Lobos L, Lavandero S, Marusic ET.

Eplerenone blocks nongenomic effects of aldosterone on the Na⁺/H⁺ exchanger, intracellular Ca²⁺ levels, and vasoconstriction in mesenteric resistance vessels. *Endocrinology*. 2005;**146**(3):973-980

[16] Miyata Y, Muto S, Kusano E. Mechanisms for nongenomic and genomic effects of aldosterone on Na⁺/H⁺ exchange in vascular smooth muscle cells. *Journal of Hypertension*. 2005;**23**(12):2237-2250

[17] Feldman RD, Limbird LE. GPER (GPR30): A nongenomic receptor (GPCR) for steroid hormones with implications for cardiovascular disease and cancer. *Annual Review of Pharmacology and Toxicology*. 2017;**57**:567-584. DOI: 10.1146/annurev-pharmtox-010716-104651

[18] Cole DF. Effect of aldosterone on renal excretion of intravenously administered saline. *Endocrinology*. 1957;**60**(4):562-565

[19] Musabayane CT, Ndhlovu CE, Forsling ML, Balment RJ. Interaction of aldosterone and oxytocin to influence renal sodium excretion in rats. *Experimental Physiology*. 1994;**79**(5):763-774

[20] Rad AK, Balment RJ, Ashton N. Rapid natriuretic action of aldosterone in the rat. *Journal of Applied Physiology*. 2005;**98**(2):423-428

[21] Urbach V, Van Kerkhove E, Maguire D, Harvey BJ. Rapid activation of KATP channels by aldosterone in principal cells of frog skin. *The Journal of Physiology*. 1996;**491**(Pt 1):111-120

[22] Harvey BJ, Ehrenfeld J. Role of Na⁺/H⁺ exchange in the control of intracellular pH and cell membrane conductances in frog skin epithelium. *The Journal of General Physiology*. 1988;**92**(6):793-810

[23] Harvey BJ, Thomas SR, Ehrenfeld J. Intracellular pH controls cell membrane Na⁺ and K⁺ conductances and transport in frog skin epithelium. *The Journal of General Physiology*. 1988;**92**(6):767-791

[24] Oberleithner H, Weigt M, Westphale HJ, Wang W. Aldosterone activates Na⁺/H⁺ exchange and raises cytoplasmic pH in target cells of the amphibian kidney. *Proceedings of the National Academy of Sciences of the United States of America*. 1987;**84**(5):1464-1468

[25] Gekle M, Freudinger R, Mildenerberger S, Schenk K, Marschitz I, Schramek H. Rapid activation of Na⁺/H⁺-exchange in MDCK cells by aldosterone involves MAP-kinase ERK1/2. *Pflugers Archiv: European Journal of Physiology*. 2001;**441**(6):781-786

[26] Gekle M, Golenhofen N, Oberleithner H, Silbernagl S. Rapid activation of Na⁺/H⁺ exchange by aldosterone in renal epithelial cells requires Ca²⁺ and stimulation of a plasma membrane proton conductance. *Proceedings of the National Academy of Sciences of the United States of America*. 1996;**93**(19):10500-10504

[27] Markos F, Healy V, Harvey BJ. Aldosterone rapidly activates Na⁺/H⁺ exchange in M-1 cortical collecting duct cells via a PKC-MAPK pathway. *Nephron. Physiology*. 2005;**99**(1):p1-p9

[28] Wehling M, Käsmayr J, Theisen K. Fast effects of aldosterone on electrolytes in human lymphocytes are mediated by the sodium-proton-exchanger of the cell membrane. *Biochemical and Biophysical Research Communications*. 1989;**164**(3):961-967

[29] Thomas W, McEneaney V, Harvey BJ. Aldosterone-induced signalling and cation transport in the distal nephron.

Steroids. 2008;**73**(9-10):979-984. DOI: 10.1016/j.steroids.2008.01.013

[30] Ruhs S, Nolze A, Hübschmann R, Grossmann C. 30 years of the mineralocorticoid receptor: Nongenomic effects via the mineralocorticoid receptor. *The Journal of Endocrinology*. 2017;**234**(1):T107-T124. DOI: 10.1530/JOE-16-0659

[31] Crabbe J. Stimulation of active sodium transport across the isolated toad bladder after injection of aldosterone to the animal. *Endocrinology*. 1961;**69**:673-682

[32] Al-Awqati Q, Norby LH, Mueller A, Steinmetz PR. Characteristics of stimulation of H⁺ transport by aldosterone in turtle urinary bladder. *The Journal of Clinical Investigation*. 1976;**58**(2):351-358

[33] Harvey BJ. Energization of sodium absorption by the H⁽⁺⁾-ATPase pump in mitochondria-rich cells of frog skin. *The Journal of Experimental Biology*. 1992;**172**:289-309

[34] Winter C, Schulz N, Giebisch G, Geibel JP, Wagner CA. Nongenomic stimulation of vacuolar H⁺-ATPases in intercalated renal tubule cells by aldosterone. *Proceedings of the National Academy of Sciences of the United States of America*. 2004;**101**(8):2636-2641

[35] O'Neil RG, Sansom SC. Characterization of apical cell membrane Na⁺ and K⁺ conductances of cortical collecting duct using microelectrode techniques. *The American Journal of Physiology*. 1984;**247**(1 Pt 2):F14-F24

[36] Kohda Y, Ding W, Phan E, Housini I, Wang J, Star RA, et al. Localization of the ROMK potassium channel to the apical membrane of distal nephron

in rat kidney. *Kidney International*. 1998;**54**(4):1214-1223

[37] Yoo D, Kim BY, Campo C, Nance L, King A, Maouyo D, et al. Cell surface expression of the ROMK (Kir 1.1) channel is regulated by the aldosterone-induced kinase, SGK-1, and protein kinase A. *The Journal of Biological Chemistry*. 2003;**278**(25):23066-23075

[38] Wang WH, Giebisch G. Regulation of potassium (K) handling in the renal collecting duct. *Pflugers Archiv: European Journal of Physiology*. 2009;**458**(1):157-168

[39] Sansom SC, O'Neil RG. Effects of mineralocorticoids on transport properties of cortical collecting duct basolateral membrane. *The American Journal of Physiology*. 1986;**251**(4 Pt 2):F743-F757

[40] Bowley KA, Morton MJ, Hunter M, Sandle GI. Non-genomic regulation of intermediate conductance potassium channels by aldosterone in human colonic crypt cells. *Gut*. 2003;**52**(6):854-860

[41] Bowley KA, Linley JE, Robins GG, Kopanati S, Hunter M, Sandle GI. Role of protein kinase C in aldosterone-induced non-genomic inhibition of basolateral potassium channels in human colonic crypts. *The Journal of Steroid Biochemistry and Molecular Biology*. 2007;**104**(1-2):45-52

[42] Maguire D, MacNamara B, Cuffe JE, Winter D, Doolan CM, Urbach V, et al. Rapid responses to aldosterone in human distal colon. *Steroids*. 1999;**64**(1-2):51-63

[43] Baines D. Kinases as targets for ENaC regulation. *Current Molecular Pharmacology*. 2013;**6**(1):50-64

[44] Thomas W, McEneaney V, Harvey BJ. Rapid responses to steroid hormones

in the kidney. *Nephron. Physiology*. 2007;**107**(1):p1-p9

[45] Thomas W, McEneaney V, Harvey BJ. Aldosterone-stimulated PKC signaling cascades: From receptor to effector. *Biochemical Society Transactions*. 2007;**35**(Pt5):1049-1051.
Review

[46] Harvey BJ, Alzamora R, Stubbs AK, Irnaten M, McEneaney V, Thomas W. Rapid responses to aldosterone in the kidney and colon. *The Journal of Steroid Biochemistry and Molecular Biology*. 2008;**108**(3-5):310-317

[47] Harvey BJ, Alzamora R, Healy V, Renard C, Doolan CM. Rapid responses to steroid hormones: From frog skin to human colon. A homage to Hans Ussing. *Biochimica et Biophysica Acta*. 2002;**1566**(1-2):116-128

[48] Manegold JC, Falkenstein E, Wehling M, Christ M. Rapid aldosterone effects on tyrosine phosphorylation in vascular smooth muscle cells. *Cellular and Molecular Biology*. 1999;**45**(6):805-813

[49] Okoshi MP, Yan X, Okoshi K, Nakayama M, Schuldt AJ, O'Connell TD, et al. Aldosterone directly stimulates cardiac myocyte hypertrophy. *Journal of Cardiac Failure*. 2004;**10**(6):511-518

[50] Nishiyama A, Yao L, Fan Y, Kyaw M, Kataoka N, Hashimoto K, et al. Involvement of aldosterone and mineralocorticoid receptors in rat mesangial cell proliferation and deformability. *Hypertension*. 2005;**45**(4):710-716

[51] Stockand JD, Meszaros JG. Aldosterone stimulates proliferation of cardiac fibroblasts by activating Ki-RasA and MAPK1/2 signaling. *American Journal of Physiology Heart and Circulatory Physiology*. 2003;**284**(1):H176-H184

[52] Sinnett-Smith J, Zhukova E, Hsieh N, Jiang X, Rozengurt E. Protein kinase D potentiates DNA synthesis induced by Gq-coupled receptors by increasing the duration of ERK signaling in swiss 3T3 cells. *The Journal of Biological Chemistry*. 2004;**279**(16):16883-16893

[53] Tong Q, Booth RE, Worrell RT, Stockand JD. Regulation of Na⁺ transport by aldosterone: Signaling convergence and cross talk between the PI3-K and MAPK1/2 cascades. *American Journal of Physiology Renal Physiology*. 2004;**286**(6):F1232-F1238

[54] Callera GE, Montezano AC, Yogi A, Tostes RC, He Y, Schiffrin EL, et al. c-Src-dependent nongenomic signaling responses to aldosterone are increased in vascular myocytes from spontaneously hypertensive rats. *Hypertension*. 2005;**46**(4):1032-1038

[55] Chen C, Liang W, Jia J, van Goor H, Singhal PC, Ding G. Aldosterone induces apoptosis in rat podocytes: Role of PI3-K/Akt and p38MAPK signaling pathways. *Nephron Experimental Nephrology*. 2009;**113**(1):e26-e34

[56] Le Moellic C, Ouvrard-Pascaud A, Capurro C, Cluzeaud F, Fay M, Jaisser F, et al. Early nongenomic events in aldosterone action in renal collecting duct cells: PKC α activation, mineralocorticoid receptor phosphorylation, and cross-talk with the genomic response. *Journal of the American Society of Nephrology: JASN*. 2004;**15**(5):1145-1160

[57] Slater SJ, Kelly MB, Taddeo FJ, Rubin E, Stubbs CD. Evidence for discrete diacylglycerol and phorbol ester activator sites on protein kinase C. Differences in effects of 1-alkanol inhibition, activation by phosphatidylethanolamine and calcium chelation. *Journal of Biological Chemistry*. 24 Jun 1994;**269**(25):17160-17165

- [58] Alzamora R, Brown LR, Harvey BJ. Direct binding and activation of protein kinase C isoforms by aldosterone and 17 β -estradiol. *Molecular Endocrinology*. 2007;**21**(11):2637-2650
- [59] McEneaney V, Dooley R, Harvey BJ, Thomas W. Protein kinase D stabilizes aldosterone-induced ERK1/2 MAP kinase activation in M1 renal cortical collecting duct cells to promote cell proliferation. *The Journal of Steroid Biochemistry and Molecular Biology*. 2010;**118**(1-2):18-28
- [60] Tsybouleva N, Zhang L, Chen S, Patel R, Lutucuta S, Nemoto S, et al. Aldosterone, through novel signaling proteins, is a fundamental molecular bridge between the genetic defect and the cardiac phenotype of hypertrophic cardiomyopathy. *Circulation*. 2004;**109**(10):1284-1291
- [61] Kobayashi T, Deak M, Morrice N, Cohen P. Characterization of the structure and regulation of two novel isoforms of serum- and glucocorticoid-induced protein kinase. *The Biochemical Journal*. 1999;**344**(Pt 1):189-197
- [62] Pao AC, McCormick JA, Li H, Siu J, Govaerts C, Bhalla V, et al. NH₂ terminus of serum and glucocorticoid-regulated kinase 1 binds to phosphoinositides and is essential for isoform-specific physiological functions. *American Journal of Physiology Renal Physiology*. 2007;**292**(6):F1741-F1750
- [63] Blazer-Yost BL, Liu X, Helman SI. Hormonal regulation of ENaCs: Insulin and aldosterone. *The American Journal of Physiology*. 1998;**274**(5 Pt 1):C1373-C1379
- [64] Gonzalez-Rodriguez E, Gaeggeler HP, Rossier BC. IGF-1 vs insulin: Respective roles in modulating sodium transport via the PI-3 kinase/Sgk1 pathway in a cortical collecting duct cell line. *Kidney International*. 2007;**71**(2):116-125
- [65] Watt GB, Ismail NA, Caballero AG, Land SC, Wilson SM. Epithelial Na⁺ channel activity in human airway epithelial cells: The role of serum and glucocorticoid-inducible kinase 1. *British Journal of Pharmacology*. 2012;**166**(4):1272-1289
- [66] Pochynyuk O, Medina J, Gamper N, Genth H, Stockand JD, Staruschenko A. Rapid translocation and insertion of the epithelial Na⁺ channel in response to RhoA signaling. *The Journal of Biological Chemistry*. 2006;**281**(36):26520-26527
- [67] Harvey BJ, Higgins M. Nongenomic effects of aldosterone on Ca²⁺ in M-1 cortical collecting duct cells. *Kidney International*. 2000;**57**(4):1395-1403
- [68] Wehling M, Ulsenheimer A, Schneider M, Neylon C, Christ M. Rapid effects of aldosterone on free intracellular calcium in vascular smooth muscle and endothelial cells: Subcellular localization of calcium elevations by single cell imaging. *Biochemical and Biophysical Research Communications*. 1994;**204**(2):475-481
- [69] Maggio N, Segal M. Cellular basis of a rapid effect of mineralocorticosteroid receptors activation on LTP in ventral hippocampal slices. *Hippocampus*. 2012;**22**(2):267-275
- [70] Doolan CM, O'Sullivan GC, Harvey BJ. Rapid effects of corticosteroids on cytosolic protein kinase C and intracellular calcium concentration in human distal colon. *Molecular and Cellular Endocrinology*. 1998;**138**(1-2):71-79
- [71] Grossmann C, Wuttke M, Ruhs S, Seiferth A, Mildenerger S, Rabe S, et al. Mineralocorticoid receptor inhibits CREB signaling by calcineurin

activation. *FASEB Journal: Official Publication of the Federation of American Societies for Experimental Biology*. 2010;**24**(6):2010-2019

[72] Christ M, Meyer C, Sippel K, Wehling M. Rapid aldosterone signaling in vascular smooth muscle cells: Involvement of phospholipase C, diacylglycerol and protein kinase C alpha. *Biochemical and Biophysical Research Communications*. 1995;**213**(1):123-129

[73] Gros R, Ding Q, Sklar LA, Prossnitz EE, Arterburn JB, Chorazyczewski J, et al. GPR30 expression is required for the mineralocorticoid receptor-independent rapid vascular effects of aldosterone. *Hypertension*. 2011;**57**(3):442-451

[74] Grossmann C, Benesic A, Krug AW, Freudinger R, Mildenerger S, Gassner B, et al. Human mineralocorticoid receptor expression renders cells responsive for nongenotropic aldosterone actions. *Molecular Endocrinology*. 2005;**19**(7):1697-1710

[75] Grossmann C, Freudinger R, Mildenerger S, Husse B, Gekle M. EF domains are sufficient for nongenomic mineralocorticoid receptor actions. *The Journal of Biological Chemistry*. 2008;**283**(11):71gekle09-71gekle16

[76] Grossmann C, Husse B, Mildenerger S, Schreier B, Schuman K, Gekle M. Colocalization of mineralocorticoid and EGF receptor at the plasma membrane. *Biochimica et Biophysica Acta*. 2010;**1803**(5):584-590. DOI: 10.1016/j.bbamcr.2010.02.008

[77] Grossmann C, Krug AW, Freudinger R, Mildenerger S, Voelker K, Gekle M. Aldosterone-induced EGFR expression: Interaction between the human mineralocorticoid receptor and the human EGFR promoter. *American Journal of Physiology*.

Endocrinology and Metabolism. 2007;**292**(6):E1790-E1800

[78] Grossmann C, Freudinger R, Mildenerger S, Krug AW, Gekle M. Evidence for epidermal growth factor receptor as negative-feedback control in aldosterone-induced Na⁺ reabsorption. *American Journal of Physiology. Renal Physiology*. 2004;**286**(6):F1226-F1231

[79] Krug AW, Grossmann C, Schuster C, Freudinger R, Mildenerger S, Govindan MV, et al. Aldosterone stimulates epidermal growth factor receptor expression. *The Journal of Biological Chemistry*. 2003;**278**(44):43060-43066

[80] Gekle M, Freudinger R, Mildenerger S, Silbernagl S. Aldosterone interaction with epidermal growth factor receptor signaling in MDCK cells. *American Journal of Physiology Renal Physiology*. 2002;**282**(4):F669-F679

[81] Krug AW, Schuster C, Gassner B, Freudinger R, Mildenerger S, Troppmair J, et al. Human epidermal growth factor receptor-1 expression renders Chinese hamster ovary cells sensitive to alternative aldosterone signaling. *The Journal of Biological Chemistry*. 2002;**277**(48):45892-45897

[82] Braun S, Losel R, Wehling M, Boldyreff B. Aldosterone rapidly activates Src kinase in M-1 cells involving the mineralocorticoid receptor and HSP84. *FEBS Letters*. 2004;**570**(1-3):69-72

[83] Gekle M, Freudinger R, Mildenerger S, Silbernagl S. Rapid actions of aldosterone on cells from renal epithelium: The possible role of EGF-receptor signaling. *Steroids*. 2002;**67**(6):499-504

[84] Quinn S, Harvey BJ, Thomas W. Rapid aldosterone actions on epithelial

- sodium channel trafficking and cell proliferation. *Steroids*. 2014;**81**:43-48. DOI: 10.1016/j.steroids.2013.11.005
- [85] Filardo EJ, Quinn JA, Bland KI, Frackelton AR Jr. Estrogen-induced activation of Erk-1 and Erk-2 requires the G protein-coupled receptor homolog, GPR30, and occurs via trans-activation of the epidermal growth factor receptor through release of HB-EGF. *Molecular Endocrinology*. 2000;**14**(10):1649-1660
- [86] Daub H, Wallasch C, Lankenau A, Herrlich A, Ullrich A. Signal characteristics of G protein-transactivated EGF receptor. *The EMBO Journal*. 1997;**16**(23):7032-7044
- [87] Guerrero J, Santibanez JF, Gonzalez A, Martinez J. EGF receptor transactivation by urokinase receptor stimulus through a mechanism involving Src and matrix metalloproteinases. *Experimental Cell Research*. 2004;**292**(1):201-208
- [88] Stirnweiss J, Valkova C, Ziesche E, Drube S, Liebmann C. Muscarinic M2 receptors mediate transactivation of EGF receptor through Fyn kinase and without matrix metalloproteinases. *Cellular Signalling*. 2006;**18**(8):1338-1349
- [89] Wehling M. Rapid actions of aldosterone revisited: Receptors in the limelight. *The Journal of Steroid Biochemistry and Molecular Biology*. 2018;**176**:94-98. DOI: 10.1016/j.jsbmb.2017.01.016
- [90] Slater SJ, Kelly MB, Taddeo FJ, Larkin JD, Yeager MD, McLane JA, et al. Direct activation of protein kinase C by 1 alpha,25-dihydroxyvitamin D3. *The Journal of Biological Chemistry*. 1995;**270**(12):6639-6643
- [91] Alzamora R, Harvey BJ. Direct binding and activation of protein kinase C isoforms by steroid hormones. *Steroids*. 2008;**73**(9-10):885-888. DOI: 10.1016/j.steroids.2008.01.001
- [92] Hermidorff MM, de Assis LV, Isoldi MC. Genomic and rapid effects of aldosterone: What we know and do not know thus far. *Heart Failure Reviews*. 2017;**22**(1):65-89. DOI: 10.1007/s10741-016-9591-2
- [93] Qiao H, Hu B, Zhou H, Yan J, Jia R, Lu B, et al. Aldosterone induces rapid sodium intake by a nongenomic mechanism in the nucleus tractus solitarius. *Scientific Reports*. 2016;**6**:38631. DOI: 10.1038/srep38631
- [94] Bhalla V, Hallows KR. Mechanisms of ENaC regulation and clinical implications. *Journal of the American Society of Nephrology: JASN*. 2008;**19**(10):1845-1854
- [95] Levin ER, Hammes SR. Nuclear receptors outside the nucleus: Extranuclear signalling by steroid receptors. *Nature Reviews. Molecular Cell Biology*. 2016;**17**(12):783-797. DOI: 10.1038/nrm.2016.122
- [96] Rozengurt E, Rey O, Waldron RT. Protein kinase D signaling. *The Journal of Biological Chemistry*. 2005;**280**(14):13205-13208
- [97] Rozengurt E. Protein kinase D signaling: Multiple biological functions in health and disease. *Physiology*. 2011;**26**(1):23-23
- [98] Rey O, Young SH, Cantrell D, Rozengurt E. Rapid protein kinase D translocation in response to G protein-coupled receptor activation. Dependence on protein kinase C. *The Journal of Biological Chemistry*. 2001;**276**(35):32616-32626
- [99] Rey O, Papazyan R, Waldron RT, Young SH, Lippincott-Schwartz J, Jacamo R, et al. The nuclear import of protein kinase D3 requires its catalytic

activity. *The Journal of Biological Chemistry*. 2006;**281**(8):5149-5157

[100] Yeaman C, Ayala MI, Wright JR, Bard F, Bossard C, Ang A, et al. Protein kinase D regulates basolateral membrane protein exit from trans-Golgi network. *Nature Cell Biology*. 2004;**6**(2):106-112

[101] Liljedahl M, Maeda Y, Colanzi A, Ayala I, Van Lint J, Malhotra V. Protein kinase D regulates the fission of cell surface destined transport carriers from the trans-Golgi network. *Cell*. 2001;**104**(3):409-420

[102] McEneaney V, Dooley R, Yusef YR, Keating N, Quinn U, Harvey BJ, et al. Protein kinase D1 modulates aldosterone-induced ENaC activity in a renal cortical collecting duct cell line. *Molecular and Cellular Endocrinology*. 2010;**325**(1-2):8-17. DOI: 10.1016/j.mce.2010.04.019

[103] Rykx A, De Kimpe L, Mikhalap S, Vantus T, Seufferlein T, Vandenhede JR, et al. Protein kinase D: A family affair. *FEBS Letters*. 2003;**546**(1):81-86

[104] Le Moëllic C, Ouvrard-Pascaud A, Capurro C, Cluzeaud F, Fay M, Jaisser F, et al. Early nongenomic events in aldosterone action in renal collecting duct cells: PKC α activation, mineralocorticoid receptor phosphorylation, and cross-talk with the genomic response. *Journal of the American Society of Nephrology*. 2004;**15**(5):1145-1160

[105] Yusef YR, Thomas W, Harvey BJ. Physiological techniques in the study of rapid aldosterone effects. *Methods in Molecular Biology*. 2014;**1204**:219-231. DOI: 10.1007/978-1-4939-1346-6_19

[106] Masilamani S, Kim GH, Mitchell C, Wade JB, Knepper MA. Aldosterone-mediated regulation of ENaC α , β , and γ subunit proteins

in rat kidney. *The Journal of Clinical Investigation*. 1999;**104**(7):R19-R23

[107] Butterworth MB, Edinger RS, Johnson JP, Frizzell RA. Acute ENaC stimulation by cAMP in a kidney cell line is mediated by exocytic insertion from a recycling channel pool. *The Journal of General Physiology*. 2005;**125**(1):81-101

[108] Lee JW, Chou CL, Knepper MA. Deep sequencing in microdissected renal tubules identifies nephron segment-specific transcriptomes. *Journal of the American Society of Nephrology: JASN*. 2015;**26**(11):2669-2677

[109] Quinn S. Aldosterone Regulation of Protein Kinase D and Sodium Reabsorption in the Renal Cortical Collecting Duct [PhD Thesis]. Dublin: Royal College of Surgeons in Ireland; 2018. Available from: <https://epubs.rcsi.ie/phdtheses/229/>