

We are IntechOpen, the world's leading publisher of Open Access books Built by scientists, for scientists

4,800

Open access books available

122,000

International authors and editors

135M

Downloads

Our authors are among the

154

Countries delivered to

TOP 1%

most cited scientists

12.2%

Contributors from top 500 universities

**WEB OF SCIENCE™**Selection of our books indexed in the Book Citation Index
in Web of Science™ Core Collection (BKCI)

Interested in publishing with us? Contact book.department@intechopen.com

Numbers displayed above are based on latest data collected.

For more information visit www.intechopen.com

Versatile Propylene-Based Polyolefins with Tunable Molecular Structure through Tailor-Made Catalysts and Polymerization Process

Xiong Wang, Xiaoyu Han and Renwei Xu

Abstract

Since the discovery of Ziegler-Natta catalysts for olefin polymerization in the 1950s, the production of polyolefins with a variety of properties has continuously grown with rapid development of catalyst technology combined with polymerization process innovation. For propylene-based polyolefin, various polyolefins with distinctive characteristic of mechanical and optical properties were made with specific catalysts in commercial industries owned especially by those large world-wide companies. In this chapter, Ziegler-Natta catalysts, metallocene catalysts, and post-metallocene catalysts for PP polymerization are discussed in detail. Gas phase, bulk, slurry, and solution polymerization processes, such as Spheripol (Basell), Hypol (Mitsui Chemicals), Unipol (Dow Chemical), Innovene (INEOS), Novelen (BASF), Spherizone (Basell), and Borstar (Borealis), developed by the industrial tycoons were reviewed. The molecular architecture of the PP-based polyolefins could be tailored precisely using specific high-performance catalyst in an appropriate polymerization process, and different types of PPs, including homopolypropylene (HPP), random copolypropylene (RPP), impact PP, PP-based block copolymer, functionalized PP, etc., are produced. The relationship between molecular structure and performance of the PP-based polyolefins is also discussed thereof.

Keywords: polymerization process, propylene-based polyolefin, polypropylene, Z-N catalyst, metallocene, post-metallocene

1. Introduction

The consumption of polyolefins has been remaining growing with continuous catalyst technology innovation since the discovery of Ziegler-Natta catalysts in the 1950s [1, 2]. Numerous technologies are adopted to improve the performance of regular homopolypropylene (HPP), such as toughness, tensile strength, and transparency, and a series of PP-based polyolefins including isotacticity polypropylene (iPP), random copolypropylene (RPP), impact PP, PP-based block copolymer, functionalized PP, etc. are successfully commercialized by tailor-made catalysts and polymerization process [3–8]. Now these PP-based polyolefins are used in a

wide range of industries such as packaging, electrical and electronics, construction, automobile, medical, equipment, and facilities industries [9, 10].

According to the statistics from IHS Chemical (2018), the total production of polypropylene worldwide was about 56 million tons in 2016, and by 2022, about 75 million tons is predicted. The biggest increases have been taking place in Asia in recent years due to their dramatic expansion of economic share with a huge supply of cheap raw materials from Gulf Coast countries. China now possesses the largest market share in PP production of above 22 million tons.

Along with this massive production was the successful development of the catalyst technology and the polymerization process innovation [11]. The Z-N catalysts were at first immobilized in a carrier such as TiCl_3 [9]. The two most significant improvements were the evolutionary use of MgCl_2 as a reactive catalyst support, which can dramatically improve the catalyst performance with excellent shape control, and the discovery of electron donors (internal electron donors and external electron donors) in the catalyst system, which can improve the catalyst activity and control the stereoregularity, and led to the dramatic growth of iPP production.

Different from the multisite Z-N catalysts, single site metallocenes have not brought much attention to the polyolefin industry until the discovery of methylaluminoxane (MAO) by Sinn and Kaminsky due to the dramatic increase of polymerization activity as a cocatalyst. Typically, single-site metallocene catalysts make it possible to fine-tune the microstructure of the produced polymer chain by ligand design in the catalyst complexes, with excellent α -olefin incorporation ability. In 1990s, two successful samples of commercialization of metallocene catalysts were realized by ExxonMobil and Dow. In 1991, ExxonMobil was the first company to put metallocene catalysts into commercial use with the new Exxpol[®] Technology. Then in 1992, Dow launched the constrained geometry catalysts (CGC) with linked half-titanocenes containing amide ligands, which are still called metallocene catalysts for convenience, to produce metallocene-based polyolefins with INSITE[™] technology [12].

Compared to the Exxpol[®] Technology developed by ExxonMobil, which is based on heterogeneous catalysts and gas-phase process, the INSITE[®] technology from Dow is based on the constrained geometry catalyst (CGC) in a solution process. The homogeneous catalyst system has the ability to control polymer microstructure with flexibility and simplicity from the homogeneous phase system. And also the relationship between the catalyst structure and the physical properties is easy to be characterized and modeled.

Polyolefin production from metallocene-based catalysts and a solution process were rapidly adopted for many applications; however, some drawbacks such as poor compression set and poor scratch resistance limited their applications. In 2004, a new post-metallocene catalyst with the pyridyl amine system was commercialized in the solution process by Dow to produce a family of propylene/ethylene copolymers called VERSIFY[™] Plastomers and Elastomers [13, 14]. This pyridyl amine-based catalyst was developed through high throughput screening technology, and was suitable for production of propylene-based copolymers with high molecular weight over a wide range of chemical composition distributions.

In 2006, Dow announced olefin block copolymers which were produced by chain shuttling polymerization technology in a solution process. As shown in **Figure 1**, this technology employs two catalysts and a chain shuttling agent, and the two catalysts have totally different incorporation ability of α -olefin, thus producing different chain block-soft and hard PE segments-by chain shuttling agent (diethyl zinc), and the produced chains are composed of at least two alternating soft and hard segments [15]. The chain shuttling polymerization is illustrated in **Figure 3**. By combining the pyridyl-amine catalyst and CGC catalyst and alkylaluminum as the chain

shuttling agent, the chain shuttling catalyst technology was also used to produce propylene-based stereoblock copolymer with a high molecular weight, at least some of which differ in irregular branching content, especially regio-irregular 2,1- and/or 3,1-monomer insertions [17], (Figure 2). Thus, the block copolymers obtain desirable properties due to the presence of alternating “soft” and “hard” blocks in the same polymer chain [11].

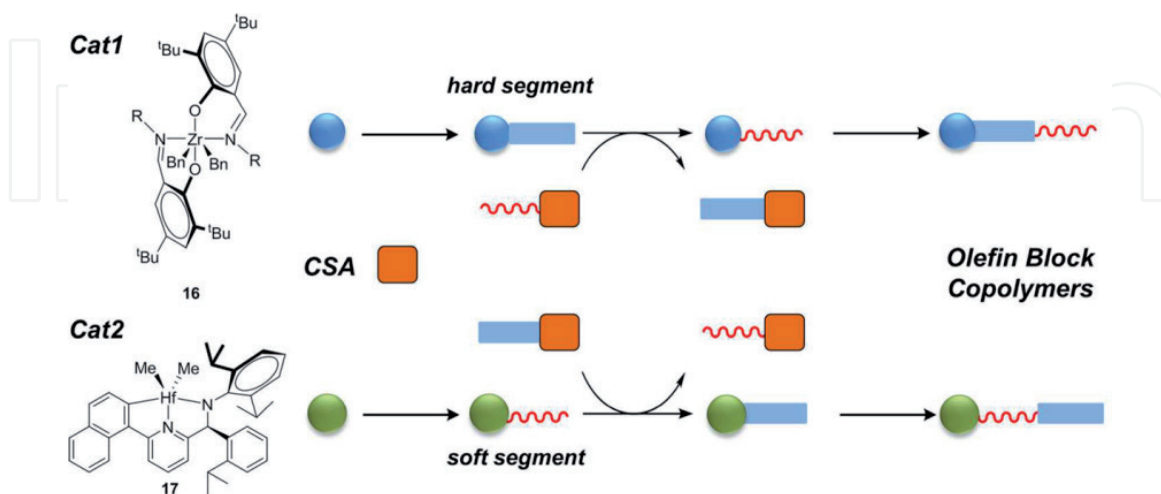

Figure 1.
Schematic illustration of chain shuttling polymerization [3].

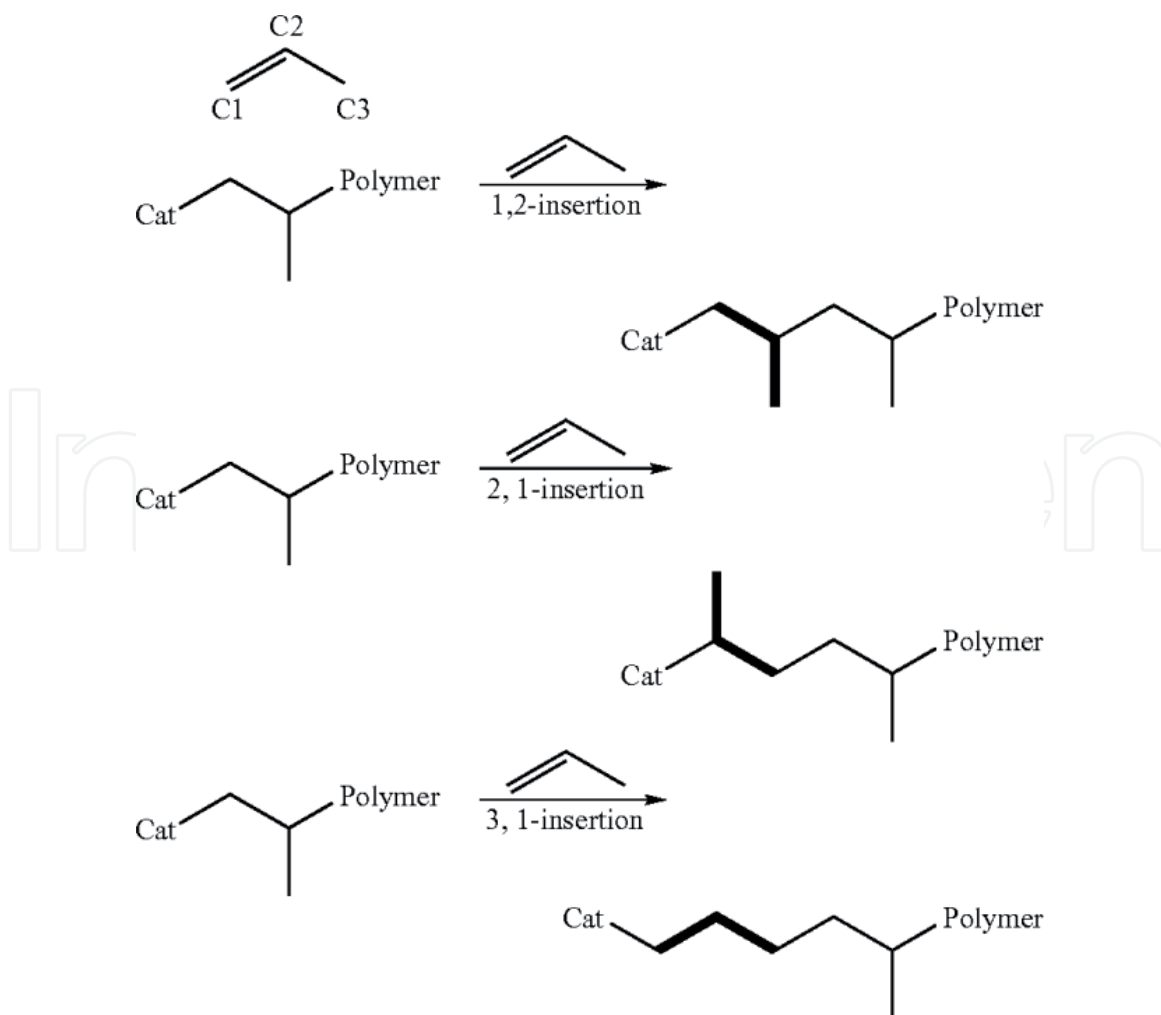

Figure 2.
Regio-irregular 2,1- and/or 3,1-monomer insertions [11].

Furthermore, numerous methods such as using polymerizable chain shuttling agents and reactive comonomers were adopted to prepare functionalized PP polymer [18] in order to improve PP's interactive performance and broaden its applications to high value-added products, in which compatibility and adhesion with other materials are needed. Other propylene-based polymers, such as ethylene propylene diene monomer (EPDM) rubber, can also be produced by catalyst design of Z-N catalysts or post-metallocene catalysts [19].

Combined with the PP catalyst technology, a series of PP polymerization processes have been developed and commercialized successfully. And the polymerization processes are highly dependent on the PP catalyst system. Typically, in a gas phase, slurry processes, such as Spheripol (Basell), Hypol (Mitsui Chemicals), Unipol (Dow Chemical), Innovene (INEOS), Novelen (BASF), Spherizone (Basell), and Borstar (Borealis), are required to meet the requirements for industrial equipment, such as shape control of products, avoiding reactor fouling with low investment and operating costs and without environmental impact, etc., and heterogenization of Z-N or metallocene catalysts. Isotactic polypropylene (iPP), random copolypropylene (RPP), impact PP can be produced in these processes, while in contrast, molecular catalysts such as CGC and post-metallocene catalysts are directly used in a solution polymerization process.

2. General structure and properties

PP is a semi-crystalline thermoplastic resin with a linear chain structure consisting of C and H elements. Similar to PE, PP has great chemical resistance toward solvents, acid, and alkali. The alignment of methyl groups attached on the chain backbone, however, may greatly influence the polymer's properties in several ways, including the introduction of a steric group and different stereostructures as shown in **Figure 3**. There are three main different stereoisomers of PP, isotactic PP (iPP), syndiotactic PP (sPP), and atactic PP (aPP) [16]. For iPP, all methyl groups are arranged on the same side of the polymer backbone, in sPP the methyl groups are located on alternating sides, while in aPP, the methyl groups are scattered randomly along the polymer chain. Compared to PE, iPP has higher melting point and modulus due to their stiffening chain and the helical crystal structure. In addition, chain scission rather than cross-linking happens in thermal and high-energy treatment due to the tertiary C atom.

Stereoregularity of the methyl group branch separates crystallizable subspecies from amorphous subspecies; the melting point and modulus strength of sPP is lower than iPP, and among them, aPP has the lowest melting point.

Similarly, copolymerization of propylene and α -olefin with various compositions can vary the crystallizing ability of the polymer chain. There are two general types of polypropylene copolymers: random copolymers and block copolymers. The

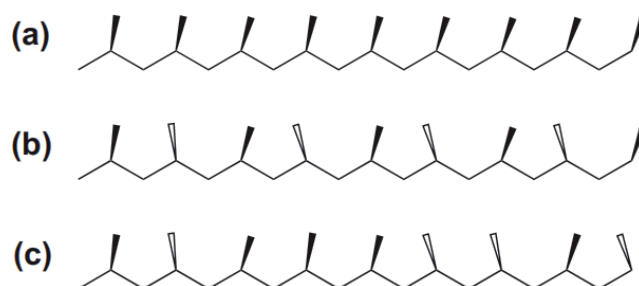

Figure 3.

Three types of stereoisomers of general PP chain: (a) isotactic, (b) syndiotactic, and (c) atactic [16].

comonomer used is typically ethylene, and in the random copolymers, the ethylene content is usually less than 7% [20]. Randomly polymerized ethylene monomer added to polypropylene homopolymer decreases the polymer crystallinity and makes the polymer more transparent. The impact copolymers of propylene-ethylene are virtually a blend of block EP rubber, HPP, and random copolymer, based on the granule reactor technology, so the impact copolymers can obtain great impact strength due to EP rubber phase spread in the PP matrix. A third comonomer can also be used as in ethylene-propylene rubber or EPDM increasing its low temperature impact strength.

3. PP catalyst development and catalyst-defined polymer design

3.1 Z-N catalysts

The massive production of PP is predominated by the use of MgCl_2 -supported Z-N catalyst systems. These systems consist of a supported catalyst composition, formed by reaction of a transition metal halide (usually TiCl_4) and an internal electron donor (ID), generally a Lewis base as a support (typically MgCl_2), an alkylaluminum cocatalyst (e.g., triethylaluminum), and an external donor (ED), generally another Lewis base (e.g., alkoxy silanes). These catalyst compositions are independently added in the process of polymerization. A timeline overview on the historical progress in the commercial research and development of Z-N catalyst systems is presented in **Table 1**.

The first major improvement in the Z-N catalysts, which is based on research by Montedison (now LyondellBasell) in Italy and Mitsui in Japan, occurred in 1968 with the discovery of the milled MgCl_2 support for ethylene polymerization. This technology was extended to the PP industry in 1970s by extra addition of internal and external electron donors to ameliorate the isotacticity of PP without inhibiting catalyst activity, which led to the third-generation of PP catalysts with high yield (15–30 kg PP/g cat), eliminating the need for catalyst residue removal ($\text{Ti} \leq 5$ ppm), but the atactic component was still inconveniently too high.

The second breakthrough came out with “the reactor granule technology” (RGT) in the 4th generation catalysts in the 1980s. This heterogeneous catalysis was based on active MgCl_2 and allowed for a real process simplification, eliminating the process for ash content and atactic removal and avoiding the occurrence of a large amount of fine powder. The particle morphology of the prepared catalyst could be replicated in the final polymer as the particles grow during the polymerization, which was called “replication phenomenon.” The catalyst can have a granular or spherical form with a higher and longer activity (20–60 kg.PP/g.cat); also, it has high stereoregularity with isotactic index typically above 95%, tunable molecular weight distribution, and so on [21].

Several routes have been employed for the preparation of granular or spherical catalysts with controllable particle size and morphology. One feasible strategy is implemented by controlled preparation of a new support material, the adducts of MgCl_2 and an alcohol, which is subsequently titanated and reacted with an internal donor to obtain supported catalyst. The archetypal example of controlled precipitation was disclosed in the work of Kashiwa and coworkers at Mitsui [22]. MgCl_2 is contacted with 2-ethylhexanol in alkane solvent, forming a homogeneous solution. The formed solution then is reacted with phthalic anhydride and TiCl_4 . The mixture is subsequently contacted with diisobutyl phthalate (DIBP) as an internal donor to form precipitated solid particles with heating. Then the particles are treated

Generation	Composition and structure	Productivity ^a (kg PP/g cat)	II (wt%)	Mw/ Mn	H ₂ response	Technology control	Process requirements
1st (1957–1970)	δ -TiCl ₃ .0.33AlCl ₃ + AlEt ₂ Cl	0.8–1.2	88–91		Low	Irregular powder	Need of purification and atactic removal
2nd (1970–1978)	δ -TiCl ₃ + AlEt ₂ Cl	10–15	94–97		Low	Irregular powder	Need of purification and atactic removal
3rd (1978–1980)	TiCl ₄ /benzoate/MgCl ₂ + AlEt ₃ + benzoate	15–30	90–95	8–10	Low	Regular/irregular powder	No purification, need of atactic removal
4th (1980) RGT	MgCl ₂ /TiCl ₄ /phthalate + AlEt ₃ /silane three-dimensional catalyst granule architecture (RGT)	20–60	95–99	6–8	Medium	Particles with regular shapes and adjustable size and PSD. Designed distribution of the different products inside each particles	No purification, no atactic removal
5th (1988) RGT	MgCl ₂ /TiCl ₄ /diester + AlEt ₃ MgCl ₂ /TiCl ₄ /diester + AlEt ₃ /silane	50–130	95–99	4–6	Very high		
(1999) RGT	MgCl ₂ /TiCl ₄ /succinate + AlEt ₃ /silane	40–70	95–99	10–15	Medium	Designed distribution of the different products inside each particles	No purification, no atactic removal
6th Phthalate replacement	MgCl ₂ /TiCl ₄ /phthalate-free donor + AlEt ₃ /silane				Very high		

^aPolymerization conditions: liquid propene, 70°C, 2 h.

Table 1.
Performance development of Ziegler-Natta catalysts for polypropylene.

with TiCl_4 again to obtain the final catalyst. Another successful example using this precipitation method is the N series of catalysts (BRICI, Sinopec). According to this method, anhydrous MgCl_2 is reacted with tributyl phosphate and epichlorohydrin in toluene to form a uniform solution. The solution is subsequently treated with phthalic anhydride and TiCl_4 . The resultant solid particles have regular spherical form; then the solid catalyst is contacted with DIBP and TiCl_4 to obtain the final catalyst [23].

The spherical $\text{MgCl}_2 \cdot n\text{EtOH}$ support is also a commercially successful example by Basell/Avant ZN range, Sinopec/BRICI DQ catalyst [24], and Brorealis [25]. Spray-drying or controlled precipitation and emulsion process can be adopted to produce the spherical $\text{MgCl}_2 \cdot n\text{EtOH}$ support. As exemplified in Avant ZN range, molten emulsions of the $\text{MgCl}_2 \cdot n\text{EtOH}$ ($n \approx 2-3$) adduct in paraffin oil are cooled rapidly to obtain spherical particles with a narrow particle size distribution. Similarly, the spherical support of $\text{MgCl}_2 \cdot n\text{EtOH}$ ($n \approx 3$) is used in the DQ catalyst [26–28]. Instead of contacting a solid support with catalyst components, the emulsion-based catalyst of Borealis is based on a liquid/liquid phase system, and the catalyst components are contained in a liquid phase.

Furthermore, $\text{Mg}(\text{OEt})_2$ has been successfully used as a starting material in SHAC and Toho Titanium THC catalyst system [29–35]. $\text{Mg}(\text{OEt})_2$ support plays a significant role in the development of the super high activity catalyst (SHAC) system, with ethylbenzoate as the internal electron donor in the early stage. The internal electron donor ethylbenzoate can be replaced easily by other donors; for example, benzoate is used in commercial SHAC 310 catalyst and phthalate in SHAC 320 catalyst. As a starting material, $\text{Mg}(\text{OEt})_2$ also could be converted to a carboxylate by contacting with CO_2 , to form a soluble Mg medium. The soluble carboxylate Mg can be reacted directly with TiCl_4 , which shapes the basis of the Amoco CD catalyst [36–38]. After reacting with a Grignard solution such as $n\text{BuMgCl}$, the $\text{Mg}(\text{OEt})_2$ could be converted to a $\text{Mg}(\text{OR})\text{Cl}$ support with controlled morphology. A catalyst based on this $\text{Mg}(\text{OEt})\text{Cl}$ support has also been mentioned by SABIC [39, 40] and Basell/Akzo Nobel [40, 41].

The 4th RGT catalysts have also promoted the revolutionary development of PP-based production processes, such as Hypol, Unipol, Spheripol, Novelen, Spherizone, Catalloy, etc., and made it possible to generate multiphase alloys and blends directly in reactors, producing high-performance materials not available from conventional technologies. First, the catalyst is the only active center, propylene polymerization takes place in the catalyst, as the polymerization goes on, the catalyst grows into a polymer particle with active site within it, so both the catalyst and the polymer particle can act as reactor during the polymerization.

For Z-N catalysts, the internal and external electron donors are very critical in tuning the chain structure, MWD of the polymer, and hydrogen response; their effect is mainly determined by the binding energy and mobility on the MgCl_2 surface, controlling the stereoregularity of the PP chain. As mentioned above, internal electron donors are added during catalyst preparation while external electron donors are used in the process of polymerization. For a given system, changing the internal donor/Ti ratio and/or Al/external electron donor might lead to a dramatic difference in the polymer structure.

The search for further catalyst improvements brought to light various novel internal donors which were not readily extracted from the support by the alkyl-aluminum cocatalyst. The diether compounds used as an internal donor in the 5th generation Z-N catalyst systems, in particular 2,2-disubstituted-1,3-dimethoxypropanes with an O–O distance in the range of 2.8–3.2 Å, which are not extracted easily due to the relatively strong interaction with the catalyst surface, when contacting the AlEt_3 cocatalyst, show high stereospecificity even without using an external

donor [42–47]. The diether compounds exhibit particularly high polymerization activity, typically giving yields exceeding 100 kg PP/g cat, good high hydrogen sensitivity, and relatively narrow MWD. Aliphatic dicarboxylic ester-based internal donor and, in particular, succinates and polyol esters have been employed by Basell [48, 49] and BRICI/Sinopec. Different from the 4th generation phthalate-based catalysts, the succinate internal donors developed by Basell produce PP with much broader MWD 10–15 using an alkoxysilane as an external donor. In addition, the succinate-based catalysts also generate ethylene-propylene copolymers with lower glass transition temperature, which enables the production of heterophasic copolymers having great balance of stiffness and toughness. Similarly, the polyol ester family developed by BRICI/Sinopec as an internal donor has a similar polymerization performance to succinate-based systems. However, unlike the succinates, this catalyst system yields high stereoselectivity even without alkoxysilane external donors [50]. In addition to this, mixed donors are also employed in many cases, for example, the mixture donor system of succinate and diether [51] or succinate and dimethoxytoluene [52].

In recent decades, numerous researches focus on finding more potent electron donors for the 6th generation Z-N PP catalysts. Despite the fact that the phthalate-based catalysts produce PP with far lower phthalate content below the 0.3 wt% (3000 mg/kg) concentration limit in the REACH Regulation (EC) 1907/2006, a totally phthalate-free solution is highly motivated and becomes a competitive advantage. As shown in **Figure 4**, there are several types of nonphthalate electron donors that are commercially used or proposed [53]. The new nonphthalate solution (Consista donors) of Dow (Now Grace), as a exemplified example 1,2-phenylene dibenzoate donors (**Figure 5**) [54–57], undoubtedly takes the vanguard in the developments of nonphthalate replacement. It is worth noting that a more complicated catalyst preparation process may be required in contact with the internal donors and TiCl_4 . In order to improve the final polymer particle morphology and catalyst performance, the process of use of ethylbenzoate or 2-methoxy ethylbenzoate as buffering to the procatalyst and TiCl_4 may be needed before adding the phenylene dibenzoate [58].

Typically, alkoxysilane compounds are used as the external donors and added in the polymerization process. The stereospecificity of the Z-N catalysts could be controllable by changing the substituents of the alkoxysilanes containing relatively bulky groups [53]. The correlations between the structure of the silanes' external donor and their polymerization performance have been discussed in detail by Härkönen and Seppala [59–65]. Silanes containing hydrocarbon substituents and oxygen atom with the appropriate size and electron density are expected to obtain PP with high isotacticity index. An industrial silane external donor typically contains at least one secondary or tertiary carbon linked to the silicon atom. It is reported that this bulky group could protect the silane against removal from the catalyst surface when contacting with aluminum alkyl [66]. By far, cyclohexyl(methyl)dimethoxysilane (donor C) and dicyclopentyl dimethoxysilane (donor D) have been most commonly used [66]. Some commercial external donors are listed in **Figure 6**. When compared to donor D of the polymerization performance, donor C gives high hydrogen sensitivity and the latter gives particularly high stereospecificity [67] and broader MWD [68].

The Mw and MWD of a PP are critical to the end-use application of the PP product. For fiber spinning applications, relatively low MW and narrow MWD are favored. In contrast, high melt-strength is required for extrusion of pipes and thick sheets; therefore, broad MWD and relatively high MW are needed. For heat-resistant PP, generally with high isotactic stereoregularity, broadening MWD is beneficial for balance between high rigidity and toughness. And choosing

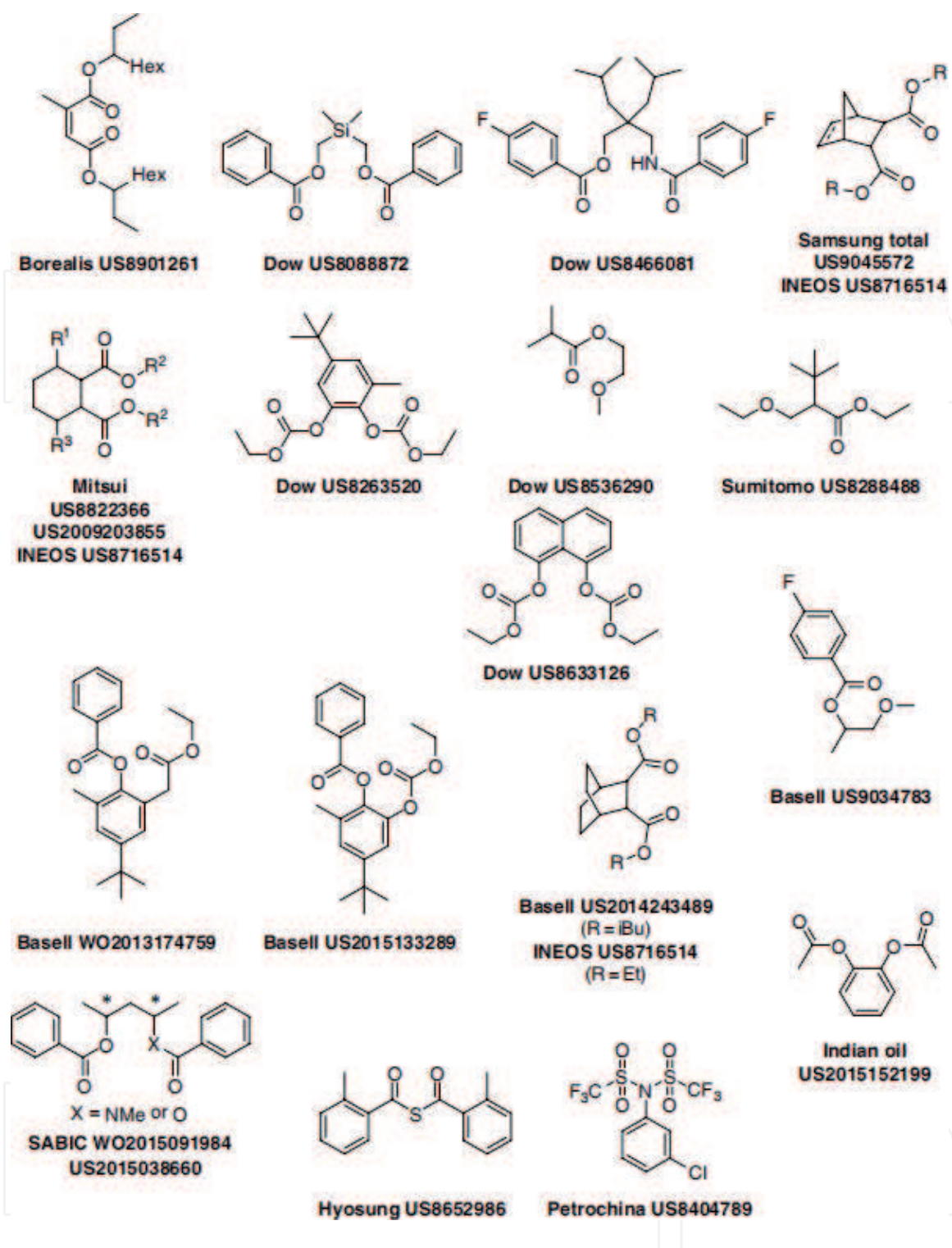

Figure 4. Recent disclosure of internal donors [53].

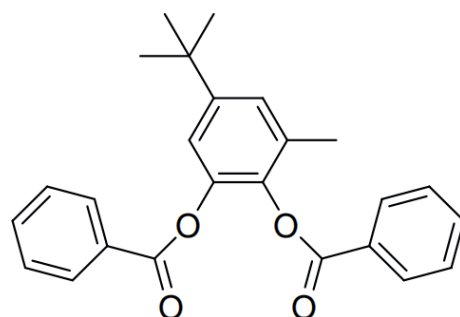

Figure 5. 1,2-Phenylene dibenzoate donors from Dow.

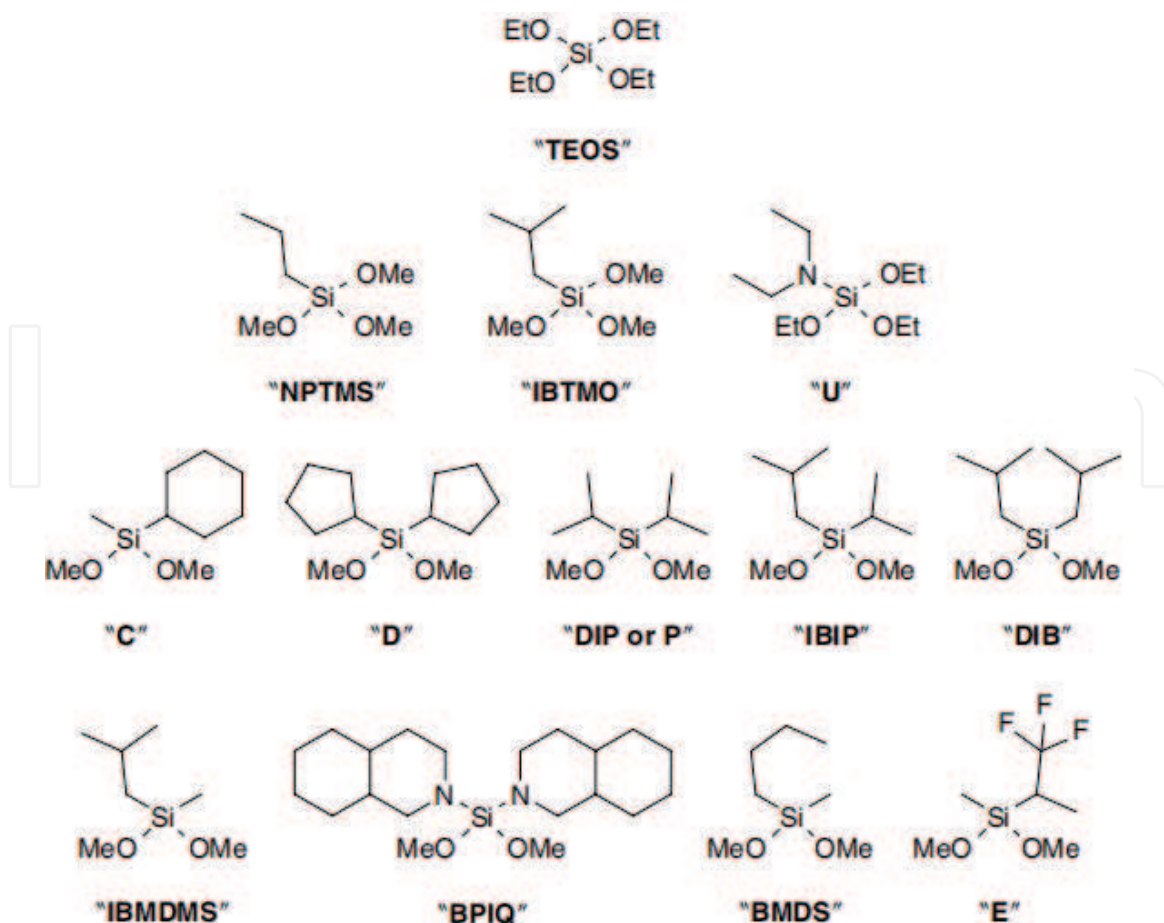

Figure 6.
Typical industrial external donors in use.

alkoxysilane external donor in the polymerization process is a convenient approach to control stereoregularity, MWD, and the H₂ response and ethylene incorporation. However, it is often the fact that a single external donor is difficult to yield desirable control over multiple properties of the final polymer. To overcome this problem, multiple external donors could be taken into consideration to tune polymer properties by mixed external donors or separate addition in different reactors. Take for example that Exxon have exploited combination of tetraethoxysilane (TEOS) and donor D in a two-stage polymerization process [69]. TEOS alone was utilized at the first stage, producing high melting index polymer; then, donor D was added at the second stage, forming resin with high isotacticity and low melt flow rate, similar to those produced by D donor alone. However, the combination of multiple donors and a two-stage process obtained a final polymer with high isotacticity, high melting index, and broader MWD. In addition, the mixed donor D and TEOS systems showed higher incorporation of ethylene and high hydrogen sensitivity in continuous copolymerization of propylene with ethylene [70]. Another case in point of combination of multiple external donors was revealed in the “self-extinguishing” catalysts concept of Dow’s SHAC™ catalyst system in the Unipol process [71]. In the process of polymerization, a mixed external donor consisting of alkyl benzoates and alkoxy-silanes is used; the catalyst systems are very active at the normal operating conditions but dramatically lose their activity at higher temperatures, and therefore prevent reactor-fouling. Further development in the “self-extinguishing” catalysts is also mentioned by combinations of NPTMS with aliphatic esters such as di-n-butyl sebacate or isopropyl myristate [72].

3.2 Metallocene catalysts

Since the discovery of MAO by Sinn and Kaminsky, single site catalysts, and metallocenes particularly, have presented significant and meaningful innovation in olefin polymerization catalysis. For commercialization of metallocene catalysts, these metallocene systems have to be compatible with the advanced process technologies, which are referred to as “drop-in catalysts.”

From a commercial perspective, iPP seems a reasonable starting point, and metallocenes suitable for iPP production generally are based on supported-zirconocenes. So far, over 900 applications since 1984 have been patented on the iPP-based metallocenes by Hoechst, Exxon, Fina, Mitsui, BASF, and so on. The typical chemical structure of the employed zirconocenes is illustrated in **Figure 7**.

The single-site metallocenes allow microstructure tailoring in the molecular level of the produced PP with narrow molecular weight distribution ($M_w/M_n = 2$). The chance to control the polymer molecular structure by metallocene complex design helped to shape a better knowledge of the basic structure-performance relations in PP. As illustrated in **Figure 8**, different molecular chains of PP with various stereoregularity can be produced by design of the metallocene catalyst structure [73–76], such as isotactic polypropylene (iPP) [77, 78], hemi-isotactic polypropylene (hiPP) [79], syndiotactic polypropylene (sPP) [80], and stereoblock polypropylene [81–83]. The correlation between the microstructure of PP and the symmetry of the metallocene complexes has been established via Ewen’s stereocontrol rules [84]. These tailor-made metallocene catalysts indicated the 2nd breakthrough in olefin polymerization followed by the discovery of MAO.

Along with the development of the tailor-made metallocenes, the homogeneous stereospecific catalysis has allowed the industrial preparation of atactic polypropylene elastomers with high molecular weight and longer iPP blocks. Several metallocene complexes have been employed for producing PP-based elastomer by designing the architectures of the metallocene catalyst. A “molecular switch” approach was reported by Waymouth and Coates, the unbridged metallocene catalyst can be changed into a dual-site catalyst by intramolecular oscillation to generate stereoblock PP without extra metallocene [85–89]. A schematic illustration is shown in **Figure 9**, and these complexes were thought to oscillate stereocontrol between their rac-like (isospecific) and meso-like (nonstereospecific) configurations during polymerization, thus producing stereoblock PP containing alternating isotactic and atactic blocks. This intriguing idea was further developed by other groups to discover other metallocenes having similar behavior of oscillating stereocontrol, such

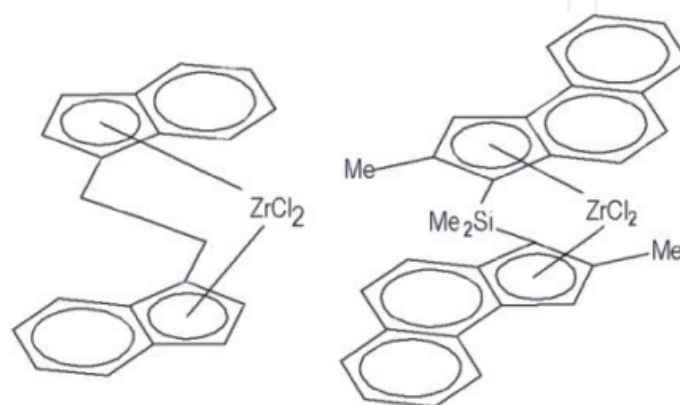

Figure 7.
Hoechst (left) and BASF metallocenes [9].

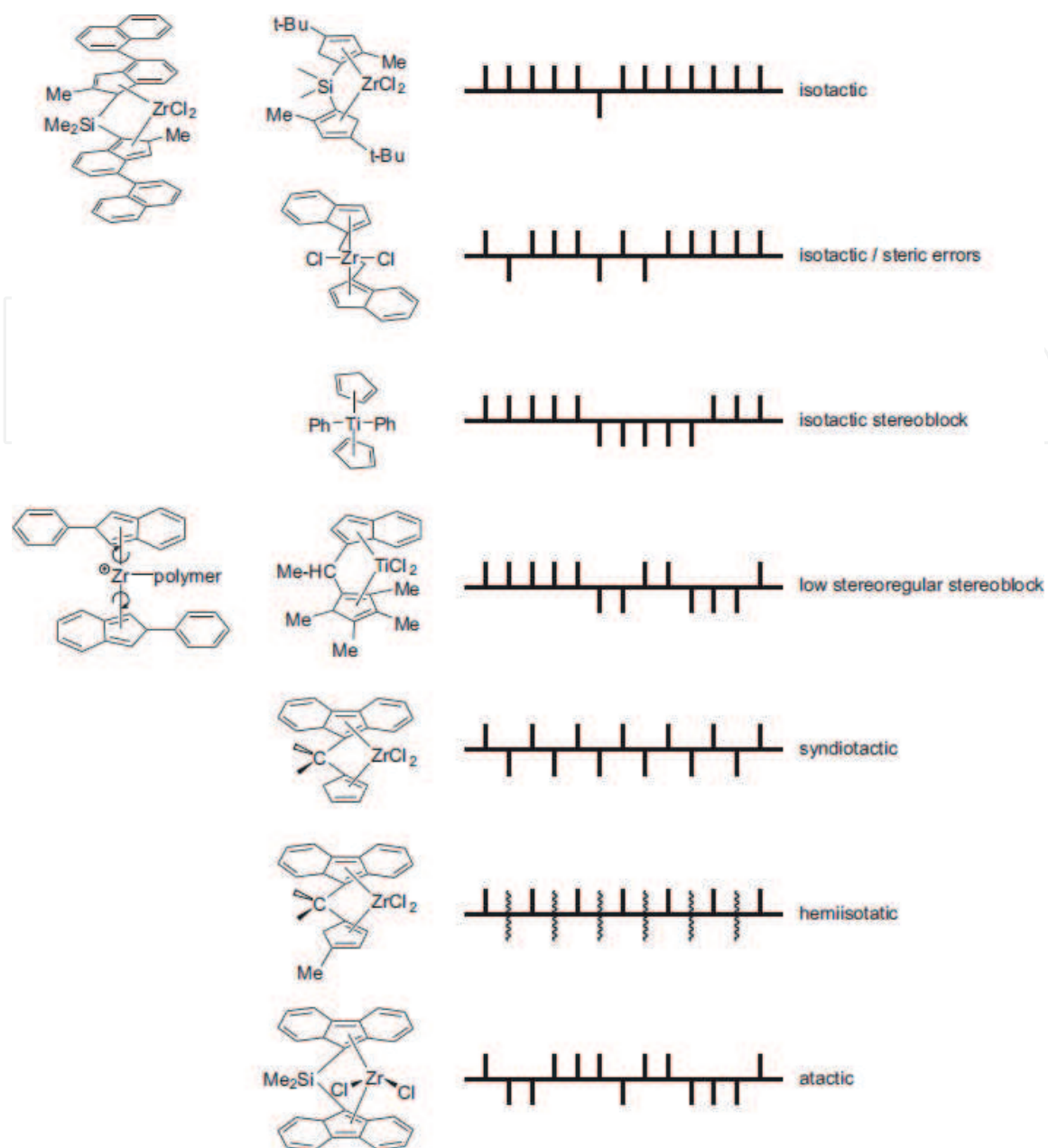

Figure 8.
Correlation between metallocene structures and polypropylene architectures.

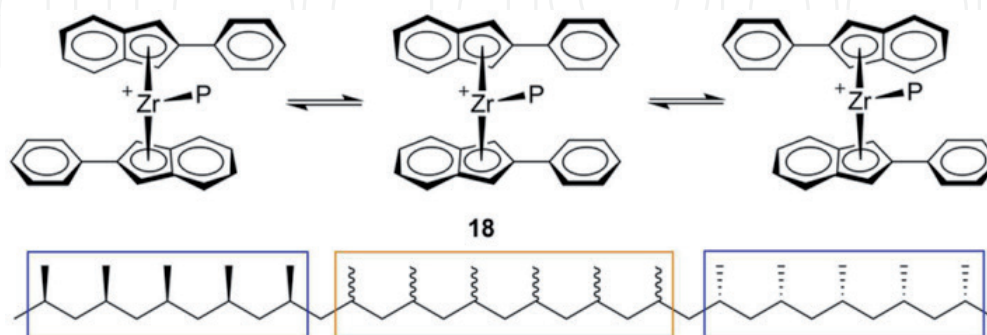

Figure 9.
Molecular switching between the two site configurations during polymerization of the unbridged metallocene catalyst.

as bis(2-aryl-indenyl) zirconocenes and hafnocenes with diverse aryl substitutions [90–92]. Moreover, the types of solvents and counterions can unfavorably limit ligand rotation; therefore, PP with complex microstructures might be produced.

By combining different stereospecific metallocenes, thermoplastic PP elastomers could also be prepared. In 1996, Chien employed a mixture of two different metallocenes, which consists of isospecific C_{2v} -symmetric metallocenes such as *rac*-ethylenebis(1-indenyl) zirconium dichloride or *rac*-dimethyl silylbis(1-indenyl) zirconium dichloride and nonstereospecific C_2 -symmetric metallocene such as ethylenebis(9-fluorenyl)zirconium dichloride, to produce PP-based elastomers by propylene homogeneous polymerization [93–95]. The combined dual-site metallocene catalysts generate a reactor blend comprising isotactic PP, atactic PP, and stereoblock PP containing alternating isotactic and atactic blocks. In the produced blends, the stereoblock PP contains immiscible isotactic and atactic PP blocks due to the chain transfer between stereospecific and nonstereospecific sites. Different from the early multisite catalysts for generating PP-based elastomer, this dual-site catalyst system, which combines two single-site metallocene catalysts, allows flexible tailoring of the elastomer properties by simply changing the molar ratio of added C_2/C_{2v} metallocenes. Surprisingly, Fink successfully synthesized iPP-*b*-sPP stereoblock PP using silica-supported MAO/dual-site metallocene catalysts that combined isospecific *rac*- $Me_2Si[Ind]_2ZrCl_2$ with syndiospecific *iPr*(FluCp) $ZrCl_2$. In another example of producing iPP-*b*-sPP stereoblock PP, Rytter and coworkers used $AlMe_3$ together with the MAO as an activator to the homogeneous dual-site catalyst system consisting of isospecific *rac*- $Me_2Si(4-t-Bu-2-MeCp)_2ZrCl_2$ and syndiospecific $Ph_2C(FluCp)ZrCl_2$ [96].

Many novel polymers can be produced by post-modification reactivity of metallocene-generated polymers. For example, vinyl-terminated PE could be incorporated onto a polypropylene backbone by a metallocene catalyst [97]. However, due to poisoning effects, polar groups should be avoided in the process of olefin copolymerizations, but protecting routes such as polar grafted PP can be employed in their incorporation [98]. Furthermore, 1,4-divinylbenzene comonomer is often used in propylene polymerization to generate styryl-capped chains that can be further functionalized at the chain ends [99]. Chain ends by chain transferring to alkyl aluminum can also be functionalized by a variety of reactions [100].

3.3 Post-metallocene catalyst

Like the single-site metallocene, the post-metallocene catalysts also possess the ability to tune the structure and properties of the prepared PP with precision, through tailoring the substitution patterns of the ligand [101–103]. Syndiotactic polypropylene (sPP) was produced by a phenoxy-imine ligand system discovered by scientists at Mitsui and simultaneously at Cornell University in New York. Subsequently, a series of researches and development focusing on post-metallocenes resulted in highly isotactic PP with high activity (**Figure 10**) [104–106].

In 2004, based on the Symyx Technologies (Symyx) using high throughput technology by Dow, VERSIFY™ Plastomers and Elastomers which are based on propylene/ethylene copolymers were developed with a pyridyl amine catalyst system (**Figure 13**, the 2nd complex). The produced VERSIFY™ Plastomers and Elastomers possess narrow molecular weight distribution, a broad chemical composition distribution compared with polymers from other single-site catalysts, and unique regio defects, which are very critical to their properties. These novel materials are the first PP-based polyolefins made in Dow's solution process, and they have excellent optical properties with high clarity and great processing performance compared to their ethylene-based counterparts. Although high temperature performance, elastic recovery, and anti-scratching and mar resistance performance are inadequate in many applications in high value fields due to their high ethylene-propylene rubber phase, they have been expanded to many new applications as new materials owing to their brilliant toughness, the optical properties, and filler compatibility.

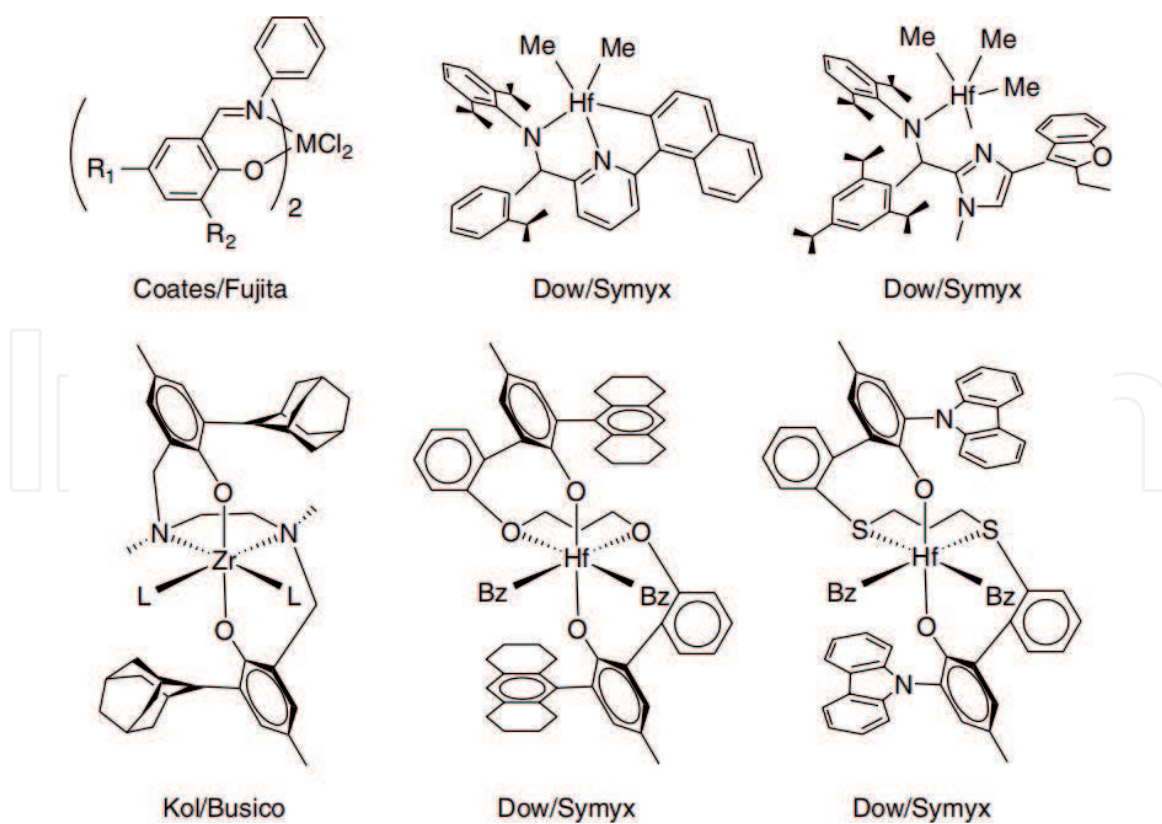

Figure 10.
Post-metallocenes for isotactic PP.

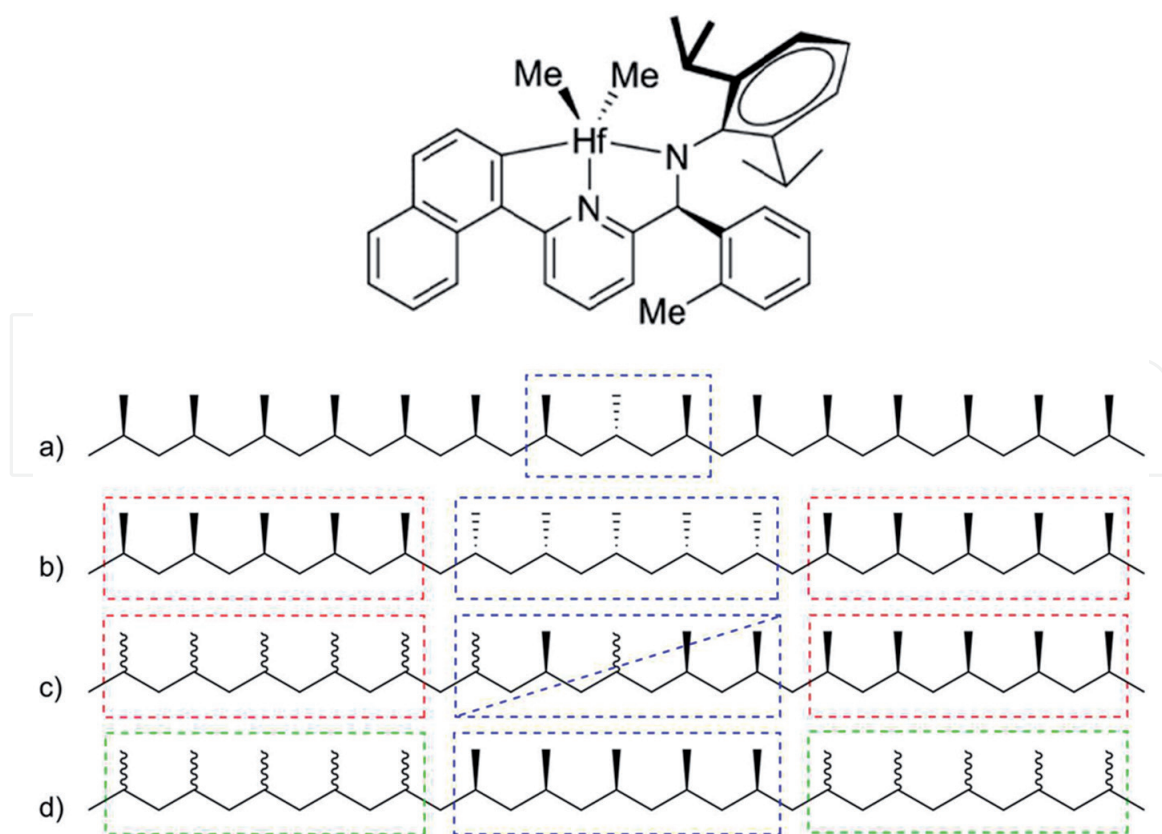

Figure 11.
Polypropylene with different stereoisomers: isotactic polypropylene with isolated stereodefects (a), isotactic stereoblock polypropylene (b), gradient (c), and stereoblock polypropylenes (d), which contain hard isotactic and flexible atactic segments [3].

Inspired by the chain shuttling technology, Dow then using the pyridyl amine catalyst system combined with alkylaluminum as chain shuttling agent provided an alternative way to make stereo-block polypropylene with narrow MWD and high molecular weight [108–110]. As illustrated in **Figure 11**, single-site racemic catalysts are used to prepare stereoblock PP, and the catalyst system actually is a dual-site catalyst containing a 50/50 mixture of the two enantiopure sites, yielding isotactic stereoblock PP. In the solution polymerization, polar solvents such as 1,2-difluorobenzene are preferred, in order to improve alkylaluminum-mediated polymeryl shuttling between the two sites, giving rise to alternating isotactic blocks with either (R) or (S) configuration [111, 112]. There are also other combined pyridyl amine catalysts with CGC or metallocene catalysts employed in the chain shuttling polymerization, to produce stereo-block polypropylene [3].

Ketimide and amidinate complexes can also be used for ethylene propylene diene monomer (EPDM) in a high temperature solution polymerization process, and the highest activities in ethylene polymerization were achieved with bis(tert-butyl)ketimide ($\text{N}=\text{C}-\text{t-Bu}_2$)-ligated titanium complexes [19]. This type of ketimide catalysts is licensed from Nova Chemicals by DSM Elastomers for the production of a new EPDM rubber product, with the trademark of Keltan ACE (referred to as “advanced catalysis elastomers”). The catalyst structure was further modified to amidinate complex 9 with the general structure $[(\text{C}_5\text{R}_5)\text{Ti}-\{\text{N}=\text{C}(\text{Ar})\text{NR}'_2\}\text{X}_2]$ ($\text{X} = \text{Me}$ or Cl) [113–116].

4. PP polymerization process

The production of PP and PP-based polymers in commercial scale is highly related to catalyst and process technology. Typically the processes could be divided into four categories: gas-phase, bulk, slurry, and solution polymerization technologies.

For homopolymer and random copolymers, bulk, slurry, and gas-phase processes can be employed. By connecting an additional gas-phase reactor to the polymerization equipment, in which the EPR is generated by ethylene-propylene copolymerization, impact PP can be produced. For the production of a polypropylene-based elastomer and most of the commercial EPDM rubbers, a solution process is required with a homogeneous catalyst system. In a slurry, bulk, or a gas-phase reactor, the polymer is generated around the heterogeneous catalyst particles. The slurry process and bulk process typically employ autoclaves or loop reactors. Gas-phase reactors generally adopt the form of fluidized-bed or stirred-bed. In fluidized-bed reactors, a gaseous stream of nitrogen and monomer is responsible for fluidizing the polymer particles and transferring the reaction heat, while in a stirred-bed reactor, mechanical stirring is employed to distribute the polymer particles and transfer heat. In a specific gas-phase stirred-bed reactor, horizontal or vertical layout can be taken. Different reactor configurations are illustrated in **Figure 12**.

The polymerization can be conducted in a single reactor or multiple reactors. Single reactors are typically employed to produce uniform composition, while multiple reactors in series can be adopted for PP with more complex microstructure and composition distribution expanding the properties of homopolymers and copolymers. Impact PP copolymers are typical examples produced in multiple reactors. The target product can be achieved in the two different steps diversifying the polymer microstructures. Isotactic polypropylene particles are formed in the first reactor by propylene homopolymerization, while a stream of mixture of propylene/ethylene is fed to the second reactor to make propylene-ethylene rubber phase copolymers, which is dispersed within the same catalyst and homopolymer particles. A schematic illustration of impact PP production is shown in **Figure 13**.

The improved impact strength attributes to the heterophasic ethylene-propylene copolymer scattered in the crystalline iPP matrix formed in the first reactor.

In the past decades, the process configuration has evolved, driven not only by economics, but mainly by product performance. Multiple reactors allow for flexible operation during polymerization to make various polymers that can be considered a blend of multiple components (reactor blends). Along with the improvement of the catalyst technology, the major worldwide companies have developed their own PP process using multiple-stage technology or combining bulk and gas-phase polymerization: Spheripol (Basell), Hypol (Mitsui Chemicals), Unipol (Dow Chemical), Innovene (INEOS), Novolen (BASF), Spherizone (Basell), and Borstar (Borealis).

4.1 Spheripol process

A typical Spheripol II process, which is one of the most employed process owned by Basell, consists of two liquid loop reactors and a gas phase reactor for

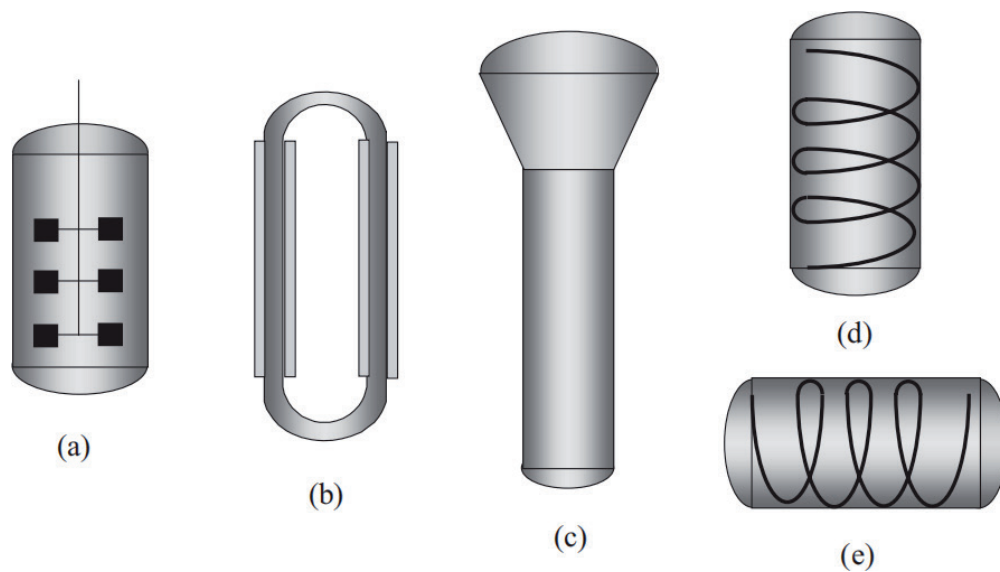

Figure 12. Reactor configurations for olefin polymerization: (a) autoclave; (b) loop; (c) fluidized-bed; (d) vertical gas-phase; and (e) horizontal gas-phase [107].

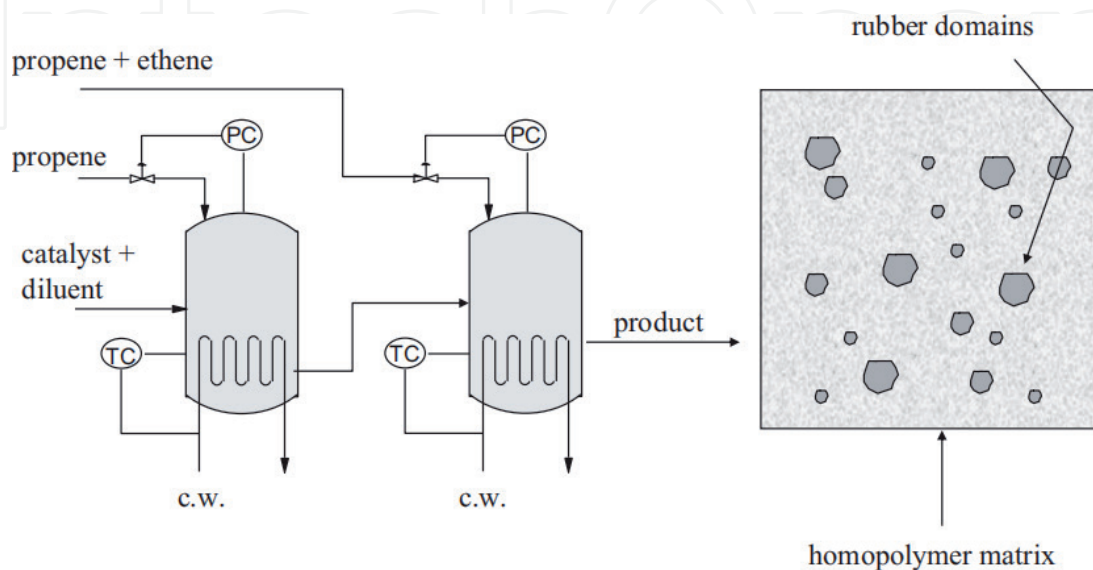

Figure 13. Process of production of impact PP [107].

producing more than 100 types of PP brands including homopolymer and random and impact copolymers with supported catalysts. The two loop reactors are typically operated under standard conditions of 70°C and 4 MPa with liquid propene circulating round the two loop reactors. An axial flow agitator is used to maintain good flowability, ensure good heat transfer, and keep substantial polymer particles from agglomerating from the slurry in each loop [35]. Typically, the PP concentration content was kept around 40 wt%.

HY/HS catalysts, together with triethylaluminum, and an external donor such as a dialkyldimethoxysilane are continuously fed into the reactor to produce PP with a specific stereoregularity. Morphology control of the HY/HS catalyst particles is very critical in the initial polymerization stage (the first several seconds to minutes). For this reason, a prepolymerization stage in which the catalyst particles react at lower temperature and monomer concentration is employed to prevent catalyst particles from generating fine powders due to rapid polymerization. The catalyst particles grow slowly in this prepolymerization stage and produce only small amounts of polymer (< 100 g/g) in the catalyst granules before this catalyst is fed into the loop reactor. Mean residence time of the polymer particles in a single loop is about 1–2 h. Multiple loop reactors can be operated in a tandem way to narrow residence time distributions, tune the polymer structure and properties, and increase productivity.

The isotactic PP particles are produced in the two loop reactors bypassing the copolymerization unit. Due to the high isotactic stereoregularity, generally, the HPP obtains high rigidity and tensile strength with high melting point. By adding propylene and ethylene and hydrogen in the two loop reactors, random copolypropylene (RPP) can be prepared; generally, the ethylene content in the RPP is below 4 wt% to avoid reactor fouling. The stereoregularity of a RPP, thus, is impaired via the insertion of the ethylene molecule; therefore, the melting point and crystalline temperature decreased, and the soluble fraction in the temperature-rising elution fraction (TREF) also increased correspondingly. However, the optical properties of the RPP could be improved dramatically with very low gloss, especially when a transparent nucleating agent is added. In the 3rd gas-phase reactor, either a vertical reactor with an agitator or a fluidized-bed reactor, mixture of propylene and ethylene, is fed to generate an ethylene-propylene rubber phase which is dispersed within the isotactic polypropylene particles already formed from the loop reactors; thus, impact polypropylene can be prepared. The EP rubber consists of polyethylene and polypropylene blocks $\{-(\text{CH}_2-\text{CH}_2)_x-[\text{CH}_2-\text{C}(\text{CH}_3)]_y-\}$, and in an industrial production, the ethylene content of the whole impact PP could be up to 15%, or the rubber phase content could be up to 30%.

4.2 Hypol process

Mitsui Petrochemical has developed a similar process using bulk polymerization with their specific supported catalysts. In a Hypol I PP process (**Figure 14**), two conventional reactors in series are employed, with reaction heat removed by evaporation of cool liquid propylene in the reactors. The slurry containing PP particles is then fed into a heated flash vessel, in which the propylene is recovered for recycling use. One or two gas-phase reactors with stirring might be added in tandem with the two bulk polymerization reactors to produce impact polypropylene. The reactors in the 2nd Hypol process of Mitsui Chemicals are replaced with two loop reactors and gas-phase fluidized-bed. Similar with Spheripol process, Hypol processes are design with innovative HY/HS supported catalysts to be able to produce HPP, RPP and impact copolymers.

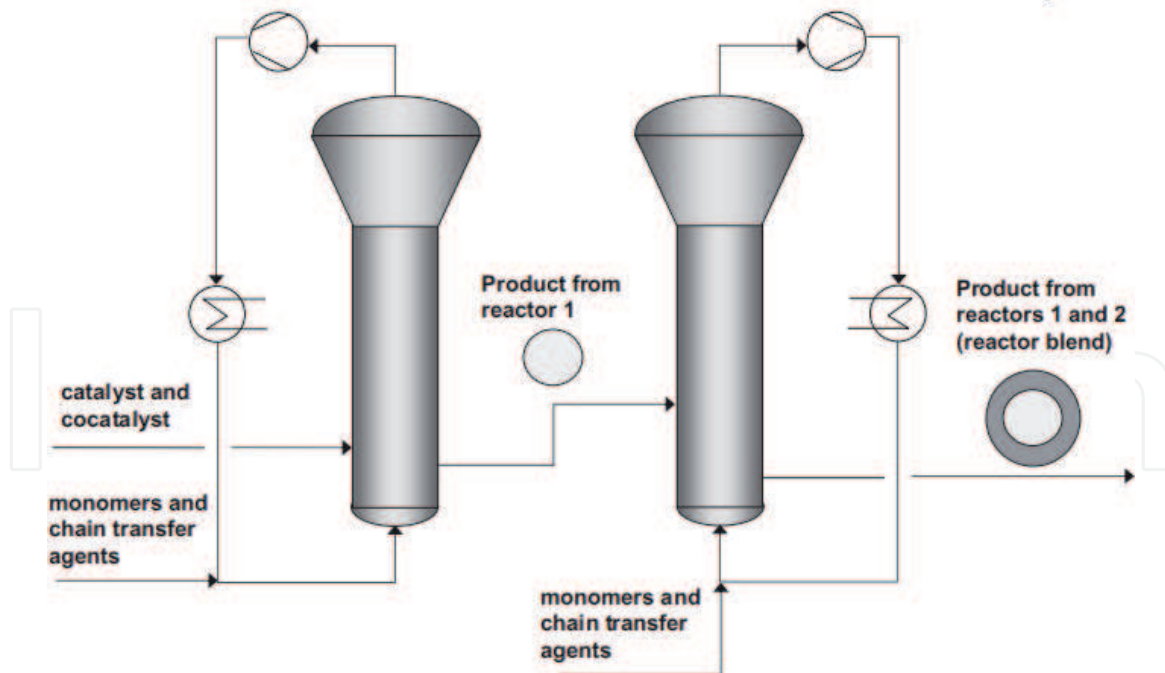

Figure 15.
Unipol gas-phase fluidized-bed process.

and produces polymer particles with excellent morphology and tunable composition in the reactor. The versatility of the Spherizone process is demonstrated by the various high-quality products that include HPP, RPP, and some special products. Due to the unique design and operation, the MZCR process is capable of providing polymers with various components within the same catalyst granule in a short residence time, making them mix at a molecular scale.

In the so-called riser (**Figure 16**), the polymer particles and monomers flow upwards in a fast fluidization state. In the top, the rising gas is separated from the solid particles, which then enters and goes downward in the so-called down-comer. The circulation of the polymer particles is handled by the pressure balance between the two zones. In the multizone circulating reactor, HPP and RPP can be produced. Optionally, the multizone circulating reactor can then be connected with another gas-phase fluidized bed reactor, where ethylene-propylene copolymerization can take place to generate high impact PP. In this reactor, the EP rubber phase is generated within the HPP matrix discharged from the first reaction stage.

4.5 Novelen process

BASF's Novelen PP process is based on two gas-phase reactor vessels equipped with vertical helical agitators, which can provide excellent agitation for catalyst particle dispersion and heat transfer, for making HPP, RPP, and impact copolymers of ethylene-propylene using their specific high activity and stereospecific catalysts. The catalysts need to be well-dispersed in the polymer particle tank to avoid agglomeration of the granule particles, and this process is operated under conditions of 70–80°C and 3–4 MPa to keep the monomer gaseous in the reactors. Reaction heat can be effectively removed from the evaporation of liquid propylene, so the temperature is controlled stably.

The primary reactor can only be used to produce HPP and random copolymers of ethylene-propylene. For impact copolymers, the EP rubber phase is produced in the 2nd vessels, by feeding propylene and ethylene into this reactor.

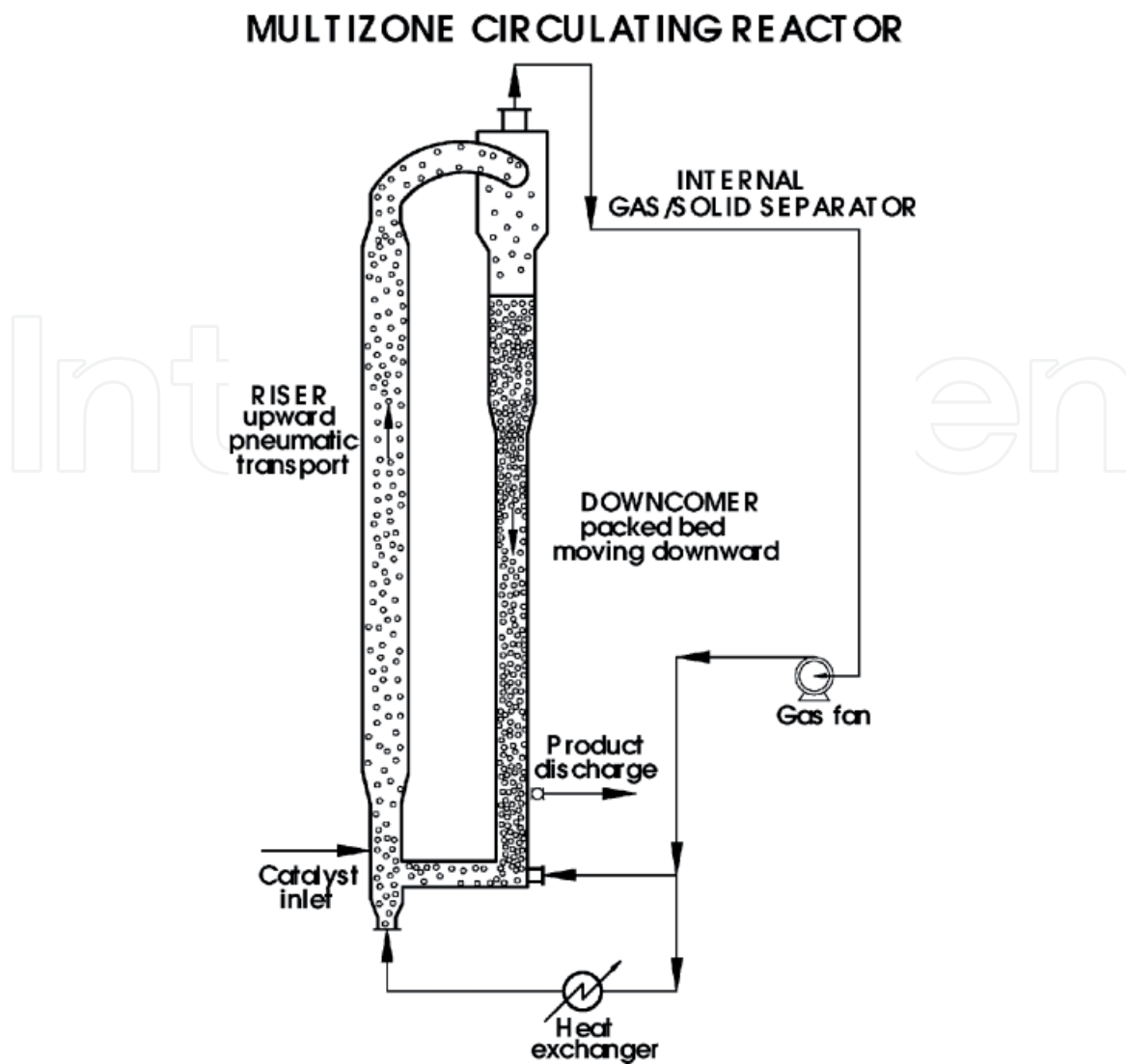

Figure 16.
Multizone circulating reactor [118].

4.6 Innovene process (BP Amoco)

Instead of the vertical agitator of the BASF process, the INEOS's PP process uses one or two horizontally stirred reactors. Uncondensed monomers and hydrogen are injected into the reactors from the base to maintain the gas composition, while condensed recycled monomers are discharged into the top of the reactor to provide cooling. Fluidized-bed deactivation system is used in both horizontal reactors to avoid particle agglomeration. Homopolymers, random copolymers, and impact copolymers can be produced in this process using highly effective CD series catalysts. This process is suitable for the production of high-impact copolymers with high rubber content, and the rubber phase content could be up to 50%.

4.7 Borstar process

The Borstar PP process developed by Borealis is based on a double loop reactor and a fluidized-bed reactor in tandem connection for the production of HPP and RPP. The loop reactor is operated under supercritical conditions with increased comonomer and hydrogen concentration, and higher temperature avoiding gas bubbles. For producing the impact PP, additional one or two fluidized-bed reactors are connected in series, as illustrated in **Figure 17**.

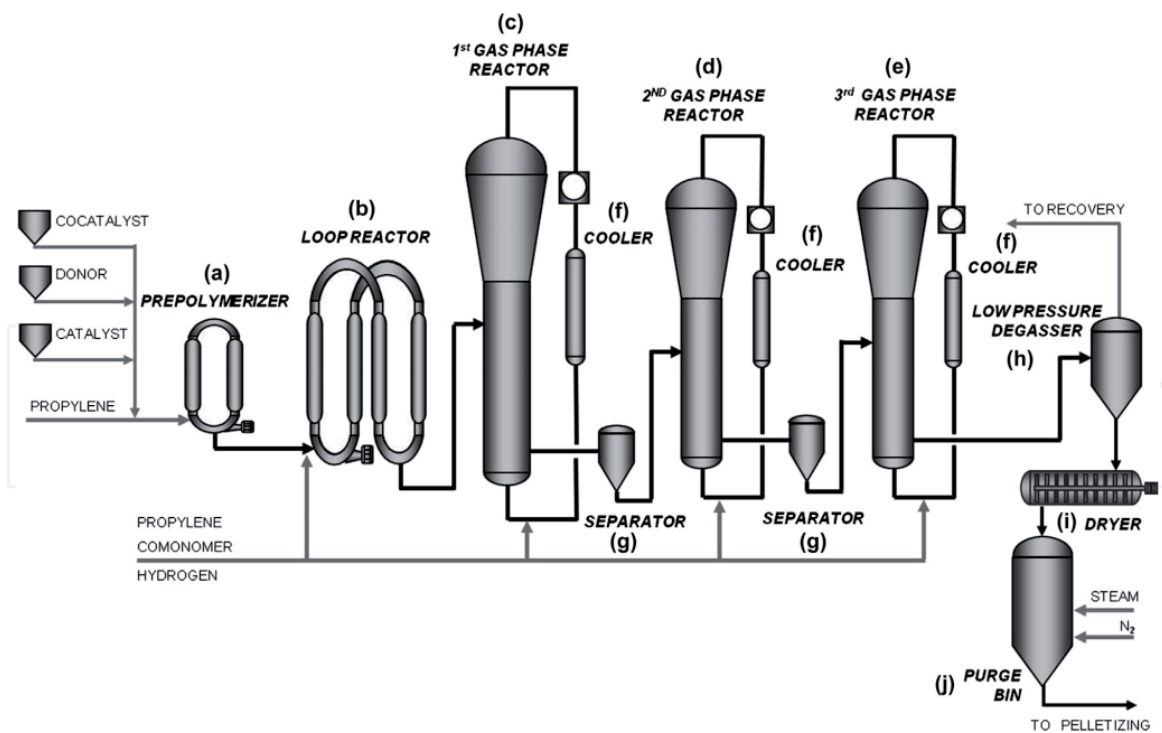

Figure 17. Borstar polypropylene process scheme (four-reactor setup) : (a) prepolymerizer; (b) loop reactor; (c) first gas-phase reactor; (d) second gas-phase reactor; (e) third gas-phase reactor; (f) coolers; (g) separators; (h) low-pressure degasser; (i) dryer; (j) purge bin [117].

Using the HY/HS catalysts of Borealis, which are prepared from emulsion strategy from two-phase liquid/liquid contact, Borstar PP technology produces high-performance HPP and RPP with very low ash content and narrow molecular weight distribution in the supercritical loop reactor due to excellent heat removal and high productivity. The rubber phase (EPR) of the impact copolymers is typically generated through the 3rd and 4th gas-phase reactors. Using the multi-reactor processes described, it is feasible and practical to further broaden PP material properties meeting up the ever-demanding customer needs.

4.8 Solution polymerization process

Autoclaves, tubular or loop reactors all could be used in a solution process. Different from the slurry and gas-phase process, the solution polymerization process is generally operated at a much higher temperature above 100°C, and in order to form a homogeneous uniform solution, a reaction solvent is added to dissolve the catalyst and polymer generated during the polymerization. Typically, the average residence time is much lower (5–20 min) in contrast with the bulk or gas-phase process (1–4 h). Since polymerization takes place in a more uniform solution, heat and mass transfer resistances are avoided, and this homogeneous process is practical for the production of ethylene-polypropylene copolymer elastomers, EPDM rubbers and stereoblock PP with soluble Ziegler-Natta catalysts, metallocenes, and post-metallocenes. Although conventional HPP could be produced in a solution process, the overall cost is too high to produce them due to requirements for use of solvent and additional process for removal of the solvent.

Solution polymerization process is also very appropriate for production of the atactic PP and PP-based elastomers. Commercial equipment developed to make atactic PP has been announced by Himont (Canada), El Paso (Texas), and Huls (Germany). Special PP-based polyolefins are also produced using the solution process by Exxon, Dow Chemical, and other companies. Propylene-ethylene

copolymers referred to as commercialized Vistamaxx™ are launched successfully by ExxonMobil with a special metallocene catalyst. The VERSIFY™ Plastomers and Elastomers of propylene/ethylene-based copolymers are produced profitably with a new post-metallocene pyridyl amine catalyst system in solution process. Stereoblock PPs [17] are also produced by using oscillating metallocene, or a mixed catalyst systems of two metallocenes and/or post-metallocenes in the presence of chain transfer agent or chain shuttling agent, as mentioned above.

5. Conclusion and outlook

Polypropylene-based polyolefins are undoubtedly one of the most robust material fields in polymer production and consumption worldwide. The remarkable progress in olefin polymerization catalyst and PP process technology contributes to the development of various PP-based polyolefins and helps to meet the continuous growing demand of the global market. Today, HY/HS Ziegler-Natta catalysts and RGT technology will continue to play a significant role in production of HPP, RPP, and impact PP especially via bulk, gas-phase polymerization process, or combination of the two processes with the newest developed process technology. With RGT technology which provides virtual nanoreactors within the catalyst and the polyolefin particles, it is possible to design more high performance micro-reactor catalysts. The molecular catalysis of single-site metallocene and post-metallocene catalysts enables precise control of the molecule structure and properties via homogeneous solution polymerization, and high-throughput screening technology provides more robust single-site catalysts with a molecular architecture approach. This allows materials scientists and engineers to design products with a broadening range of properties with advanced catalysts and polymerization process. Despite high activities, a little nontoxic catalyst residue could still be left in the polyolefin; therefore, research and development of greener and cleaner PP products with special high-performance are still way ahead.

Author details

Xiong Wang*, Xiaoyu Han and Renwei Xu
Lanzhou Petrochemical Research Center, Petrochemical Research Institute,
PetroChina, Lanzhou, China

*Address all correspondence to: wangxiong1@petrochina.com.cn

IntechOpen

© 2019 The Author(s). Licensee IntechOpen. This chapter is distributed under the terms of the Creative Commons Attribution License (<http://creativecommons.org/licenses/by/3.0>), which permits unrestricted use, distribution, and reproduction in any medium, provided the original work is properly cited. 

References

- [1] Sauter DW, Popoff N, Bashir MA, Szeto KC, Gauvin RM, Delevoye L, et al. The design of a bipodalbis(pentafluorophenoxy) aluminate supported on silica as an activator for ethylene polymerization using surface organometallic chemistry. *Chemical Communications*. 2016;**52**:4776-4779
- [2] Wang X, Han X, Ren F, Xu R, Bai Y. *Catalysts*. 2018;**8**:146
- [3] Stürzel M, Mihañ S, Mülhaupt R. *Chemical Reviews*. 2016;**116**:1398-1433
- [4] Grein C. *Advances in Polymer Science*. 2005;**188**:43
- [5] Grein C, Gahleitner M. *Express Polymer Letters*. 2008;**2**:392
- [6] Yamaguchi M, Miyata H, Nitta K-H. *Journal of Polymer Science. Part B*. 1997;**35**:953
- [7] Yamaguchi M, Nitta K-H, Miyata H, Masuda T. *Journal of Applied Polymer Science*. 1997;**63**:467
- [8] Phulkerd P, Funahashi Y, Ito A, Iwasaki S, Yamaguchi M. *Polymer Journal*. 2018;**50**:309
- [9] Heggs TG. *Polypropylene*. Weinheim: Wiley-VCH Verlag GmbH & Co. KGaA; 2012
- [10] Nwabunma D, Kyu T. *Polypropylene Composites*. Hoboken, New Jersey: John Wiley & Sons, Inc. 2007
- [11] Busico V, Alfano F, Boone HW, Cipullo R, Stevens JC. US 8,129,487B2. 2012
- [12] Chum PS, Swogger KW. *Progress in Polymer Science*. 2008;**33**:797-819
- [13] Stevens JC, Vanderlende DD. US Patent 6,960,635. 2005
- [14] Tau LM, Chum PS, Karande S, Bosnyak C. US Patent 6,919,407. 2005
- [15] Arriola DJ, Carnahan EM, Hustad PD, Kuhlman RL, Wenzel TT. *Science*. 2006;**312**:714-719
- [16] Kaminsky W. *Catalysis Today*. 2000;**62**:23e34
- [17] Arriola DJ, Carnahan EM, Devore DD, Hustad PD, Roger L. US 7,981,992B2. 2011
- [18] Mike Chung TC. *Macromolecular Reaction Engineering*. 2014;**8**:69-80
- [19] Ferreira MJ, Martins AM. *Coordination Chemistry Reviews*. 2006:250
- [20] Maddah HA. *American Journal of Polymer Science*. 2016;**6**(1):1-11
- [21] Galli P, Vecellio G. *Progress in Polymer Science*. 2001;**26**:1287-1336
- [22] Kioka M, Kashiwa N. *Mitsui Petrochemical Industries*. US 4,952,649. 1990
- [23] Mao B, Yang A, Zheng Y, Yang J, Li Z. *Beijing Inst. Chem. Eur. Patent* 0,258,485. 1992
- [24] Mao B, Yang X, Li Z, Yang A. *China Petrochemical Corp. Chin. Patent* CN 1091748. 1994
- [25] Cecchin G, Guglielmi F, Pellicani A, Burgin E. *Himont Inc. US Patent* 5,286,564. 1994
- [26] Invernizzi R, Ligorati F. *Enchimica Secondaria S.p.A. US Patent* 4,506,027. 1985
- [27] Iiskola E, Koskinen J. *Neste Oy. US Patent* 4,829,034. 1989
- [28] Karbasi AK, Leinonen T, Sormunen P. *Eur. Patent Appl.* 0,627,449 A1. 1994

- [29] Goodall BL, van der Nat AA, Sjardijn W. Shell Oil. Co. US Patent 4,329,253. 1982
- [30] Goodall BL, van der Nat AA, Sjardijn W. Shell Oil. Co. US Patent 4,393,182. 1983
- [31] Goodall BL, van der Nat AA, Sjardijn W. Shell Oil. Co. US Patent 4,400,302. 1983
- [32] Goodall BL, van der Nat AA, Sjardijn W. Shell Oil. Co. US Patent 4,414,132. 1983
- [33] Terano M, Murai A, Inoue M, Miyoshi K. Toho Titanium. US Patent 4,816,433. 1989
- [34] Terano M, Soga H, Kimura K. Toho Titanium. US Patent 4,829,037. 1989
- [35] Murai A, Terano M, Kimura K, Inoue M. Toho Titanium. US Patent 4,839,321. 1989
- [36] Arzoumanidis GG, Karayannis NM, Khelghatian HM, Lee SS, Johnson BV. Amoco Corp. US Patent 4,866,022. 1989
- [37] Arzoumanidis GG, Karayannis NM, Khelghatian HM, Lee SS, Johnson BV. Amoco Corp. US Patent 4,988,656. 1991
- [38] Streeky JA, Bersted BH, Blake JW, Feng D, Hoppin CR, Tovrog BS. Amoco Corp. US Patent 6,201,079. 2001
- [39] Ramjoie YJE, Sergeev SA, Vlaar M, Zakharov VA, Bukatov GD. Saudi Basic Indust. Corp. US Patent 7,947,788. 2011
- [40] Zuideveld MA, Sainani JB, Vimalkumar MP. Saudi Basic Indust. Corp. Eur. Patent Appl. 2,837,634. 2015
- [41] Smith GM, Amata RJ, Tirendi CF, Band EI. Akzo Nv. US Patent 5,262,573. 1993
- [42] Epstein RA, Wallack WT. Akzo Nv. US Patent 7,504,352. 2009
- [43] Albizzati E, Giannini U, Morini G, Smith CA, Ziegler R. Ziegler Catalysts: Recent Scientific Innovations and Technological Improvements
- [44] Fink G, Mülhaupt R, Brintzinger HH, editors. Ziegler catalysts: recent scientific innovations and technological improvements. Berlin: Springer-Verlag; 1995. p. 413
- [45] Albizzati E, Barbè PC, Noristi L, Scordamaglia R, Barino L, Giannini U, et al. Himont Inc. Eur. Patent 0,361,494. 1989
- [46] Morini G, Cristofori A. Montell North America Inc. Eur. Patent 0,728,724. 1996
- [47] Barino L, Scordamaglia R. Macromolecular Symposia. 1995;**89**:101
- [48] Morini G, Balbontin G, Gulevich YV, Kelder RT, Duijghuisen HPB, Klusener PAA, et al. Montell Tech. Corp. PCT Int. Appl. WO 2000063261. 2000
- [49] Cecchin G, Morini G, Pelliconi A. Macromolecular Symposia. 2001;**173**:195
- [50] Gao M, Lui H, Li Z, Wang J, Yang J, Li T, et al. China Petroleum Chem. Corp. US Patent Appl. 20050239636. 2005
- [51] Guidotti S, Morini G, Esposito S, Mignogna A, Pater JTM, Piemontesi F, et al. US Patent Appl. 2014/0046010. 2014
- [52] Guidotti S, Piemontesi F, Pater JTM, Morini G. US Patent 8,829,126. 2014
- [53] Severn J, Robert L, Jones JR. In: Ray Hoff., editors. Handbook of Transition Metal Polymerization Catalysts. 2nd ed. John Wiley & Sons, Inc.; 2018. p. 257

- [54] Chen L, Leung TW, Tao T. US Patent 8,288,585. 2012
- [55] van Egmond JW. PCT. Int. Patent Appl. 2015/081254. 2015
- [56] Chen L, Leung TW, Roth GA, Tao T, Gao K. US Patent 8,507,717. 2013
- [57] Gullo MF, Roth GA, Leung TW, Williams CC. US Patent Appl. 2013/0053525. 2013
- [58] Coalter III JN, Chen L, Williams CC. US Patent Appl. 2013/0338321. 2013
- [59] Leinonen T, Denifl P. Borealis Polymers Oy. Eur. Patent 1,273,595. 2003
- [60] Rönkkö H-L, Knuutilla H, Denifl P, Leinonen T, Venäläinen T. Journal of Molecular Catalysis A: Chemical. 2007;**278**:127
- [61] Abboud M, Denifl P, Reichert K-H. Macromolecular Materials and Engineering. 2005;**290**:1220
- [62] Härkönen M, Seppälä JV. Macromolecular Chemistry. 1991;**192**:721
- [63] Chang M, Liu X, Nelson PJ, Munzing GR, Gegan TA, Kissin YV. Journal of Catalysis. 2006;**239**:347
- [64] Härkönen M, Seppälä JV, Väänänen T. In: Keii T, Soga K, editors. Catalytic Olefin Polymerization. Amsterdam: Elsevier; 1990. p. 87
- [65] Proto A, Oliva L, Pellicchia C, Sivak AJ, Cullo LA. Macromolecules. 1990;**23**:2904
- [66] Ishimaru N, Kioka M, Toyota A. Eur. Patent 0,350,170. 1990
- [67] Chadwick JC, Van Kessel GMM, Sudmeijer O. Macromolecular Chemistry and Physics. 1995;**196**:1431
- [68] Chadwick JC. Macromolecular Symposia. 2001;**173**:21
- [69] Miro ND, Georgellis GB, Swei H. Exxon Chemical. Eur. Patent 0,743,960. 1998
- [70] Chen L, Nemzek TL. Union Carbide Chem. and Plastic Tech. Corp. US Pat 7,141,635. 2006
- [71] Peil KP, Neithamer DR, Patrick DW, Wilson BE, Tucker CJ. Macromolecular Rapid Communications. 2004;**25**:119
- [72] Cai P, Van Egmond JW, Fedec MJ, Goad JD, Brady III RC, Chen L. US Patent Appl. 2013/0005923. 2013
- [73] Resconi L, Cavallo L, Fait A, Piemontesi F. Chemical Reviews. 2000;**100**:1253-1346
- [74] Corradini P, Guerra G, Cavallo L. Accounts of Chemical Research. 2004;**37**:231-241
- [75] Busico V, Cipullo RJ. American Chemical Society. 1984;**106**:6355-6364
- [76] Spaleck W, Antberg M, Rohrman, J, Winter A, Bachmann B, Kiprof P, et al. Angewandte Chemie International Edition. 1992;**31**:1347
- [77] Kaminsky W, Külper K, Brintzinger HH, Wild FRWP. Angewandte Chemie. 1985;**97**:507-508
- [78] Ewen JA, Jones RL, Razavi A, Ferrara JD. Journal of the American Chemical Society. 1988;**110**:6255-6256
- [79] Coates GW, Waymouth RM. Science. 1995;**267**:217-219
- [80] Ewen JA, Elder MJ, Jones RL, Haspeslagh L, Atwood JL, Bott SG, et al. Makromolekulare Chemie, Macromolecular Symposia. 1991;**48-49**:253-295
- [81] Wild FRWP, Zsolnai L, Huttner G, Brintzinger HH. Journal of Organometallic Chemistry. 1982;**232**:233

- [82] Schnutenhaus H, Brintzinger HH. *Angewandte Chemie (International Ed. in English)*. 1979;**18**:777-778
- [83] Brintzinger HH, Fischer D, Mülhaupt R, Rieger B, Waymouth RM. *Angewandte Chemie (International Ed. in English)*. 1995;**34**:1143-1170
- [84] Ewen JA. *Journal of Molecular Catalysis A: Chemical*. 1998;**128**:103-109
- [85] Coates GW, Waymouth RM. Oscillating stereocontrol: A strategy for the synthesis of thermoplastic elastomeric polypropylene. *Science* 1995;**267**:217-219
- [86] Bruce MD, Coates GW, Hauptman E, Waymouth RM, Ziller J. *American Chemical Society*. 1997;**119**:11174-11182
- [87] Lin S, Waymouth RM. 2-Arylindene metallocenes: Conformationally dynamic catalysts to control the structure and properties of polypropylenes. *Accounts of Chemical Research*. 2002;**35**:765-773
- [88] Hu Y, Carlson ED, Fuller GG, Waymouth RM. *Macromolecules*. 1999;**32**:3334-3340
- [89] Petoff JLM, Agoston T, Lal TK, Waymouth RM. *Journal of the American Chemical Society*. 1998;**120**:11316-11322
- [90] Babkina ON, Bravaya NM, Nedorezova PM, Saratovskikh SL, Tsvetkova VI. *Journal of Catalysis*. 2002;**43**:341-350
- [91] Bravakis AM, Bailey LE, Pigeon M, Collins S. *Macromolecules*. 1998;**31**:1000-1009
- [92] Nejabat G-R, Nekoomanesh M, Arabi H, SalehiMobarakeh H, Zohuri G-H, Omidvar M, et al. *Journal of Polymer Science, Part A: Polymer Chemistry*. 2013;**51**:724-731
- [93] Chien JCW, Iwamoto Y, Rausch MD, Wedler W, Winter HH. *Macromolecules*. 1997;**30**:3447-3458
- [94] Przybyla C, Fink G. *Acta Polymerica*. 1999;**50**:77-83
- [95] Thomann R, Thomann Y, Mülhaupt R, Kressler J, Busse K, Lilge D, et al. *Journal of Macromolecular Science, Part B: Physics*. 2002;**B41**:1079-1090
- [96] Tynys A, Eilertsen JL, Seppala JV, Rytter E. *Journal of Polymer Science, Part A: Polymer Chemistry*. 2007;**45**:1364-1376
- [97] Weng W, Dekmezian A, Markel EJ, Gadkari A, Dekoninck J-M. US Patent 6,750,307B2. 2004
- [98] Nakamura A, Ito S, Nozaki K. *Chemical Reviews*. 2009;**109**(11): 5215-5244
- [99] Huang H-h, Zhang C-h, Qin Y-w, Niu H, Dong J-y. *Chinese Journal of Polymer Science*. 2013;**31**(4):550-562
- [100] Amin S B, Marks T J. *Angewandte Chemie, International Edition*. 2008;**47**:2006-2025
- [101] Makio H, Kashiwa N, Fujita T. *Advanced Synthesis and Catalysis*. 2002;**344**:477
- [102] Tian J, Coates GW. *Angewandte Chemie, International Edition in English*. 2000;**39**:3626
- [103] Diamond GM, LaPointe AM, Leclerc MK, Longnire J, Nava-Salgado V, Shoemaker JAW, et al. *Symxy Tech. US Patent 7,256,296*. 2007
- [104] Boussie TR, Brümmer O, Diamond GM, Goh C, LaPointe AM, Leclerc M, et al. *Symxy Tech. US Patent 7,241,715*. 2007
- [105] Buscio V, Cipullo R, Ronca S, Budzelaar PHM. *Macromolecular Rapid Communications*. 2001;**22**:1405
- [106] Boussie TR, Diamond GM, Goh C, Hall KA, LaPointe AM, Leclerc MK, et al. *Angewandte Chemie*,

International Edition in English.
2006;**45**:3278

[118] Covezzi M, Mei G. *Chemical Engineering Science*.
2001;**56**:4059-4067

[107] Soares JBP, Simon LC. Chapter 8: Coordination Polymerization. In: *Handbook of Polymer Reaction Engineering*. Weinheim: Wiley-VCH Verlag GmbH & Co. KGaA; 2005. ISBN: 3-527-31014-2

[108] Arriola DJ, Carnahan EM, Devore DD, Hustad PD, Huhlman RL, Wenzel TT. WO 2005/090425 A1. 2005

[109] Arriola DJ, Carnahan EM, Devore DD, Hustad PD, Huhlman RL, Wenzel TT. WO 2005/090427 A2. 2005

[110] Hustad PD, Kuhlman RL, Shan CLP, Poon BC, Roof GR, Stevens JC, et al.. WO 2005/090426 A1. 2005

[111] Alfano F, Boone HW, Busico V, Cipullo R, Stevens JC. *Macromolecules*. 2007;**40**:7736-7738

[112] Wang J, Liu X, Jia J, Chen X, Zhu B. *Advances in Materials Research*. 2011;**396-398**:8-12

[113] Ijpeij EG, Coussens B, Zuideveld MA, van Doremaele GHJ, Mountford P, Lutz M, et al. *Chemical Communications*. 2010;**46**:3339-3341

[114] Ijpeij EG, Windmuller PJH, Arts HJ, van der Burgt F, van Doremaele GHJ, Zuideveld MA. DSM, WO 2005/090418 A1. 2005

[115] Windmuller PJH, van Doremaele GHJ. DSM, WO 2005/005496 A2. 2005

[116] Ijpeij EG, Zuideveld MA, Arts HJ, van der Burgt F, van Doremaele GHJ. DSM, WO 2007/031295 A1. 2007

[117] Dorini M, Mei G. Chapter 17: Spherizone technology. In: Cavani F, Centi G, Perathoner S, Trifiró F, editors. *Copyright 2009. Sustainable Industrial Processes*. Weinheim: Wiley-VCH Verlag GmbH & Co. KGaA. ISBN: 978-3-527-31552-9