

We are IntechOpen, the world's leading publisher of Open Access books Built by scientists, for scientists

4,800

Open access books available

122,000

International authors and editors

135M

Downloads

Our authors are among the

154

Countries delivered to

TOP 1%

most cited scientists

12.2%

Contributors from top 500 universities



WEB OF SCIENCE™

Selection of our books indexed in the Book Citation Index
in Web of Science™ Core Collection (BKCI)

Interested in publishing with us?
Contact book.department@intechopen.com

Numbers displayed above are based on latest data collected.

For more information visit www.intechopen.com



Studying Growth and Vigor as Quantitative Traits in Grapevine Populations

Inés Pilar Hugalde, Summaira Riaz, Cecilia B. Agüero, Hernán Vila, Sebastián Gomez Talquenca and M. Andrew Walker

Abstract

Vigor is considered as a propensity to assimilate, store, and/or use nonstructural carbohydrates for producing large canopies, and it is associated with high metabolism and fast growth. Growth involves cell expansion and cell division. Cell division depends on hormonal and metabolic processes. Cell expansion occurs because cell walls are extensible, meaning they deform under the action of tensile forces, generally caused by turgor. There is increasing interest in understanding the genetic basis of vigor and biomass production. It is well established that growth and vigor are quantitative traits and their genetic architecture consists of a big number of genes with small individual effects. The search for groups of genes with small individual effects, which control a specific quantitative trait, is performed by QTL analysis and genetic mapping. Today, several linkage maps are available, like “Syrah” × “grenache,” “Riesling” × “Cabernet Sauvignon,” and “Ramsey” × *Vitis riparia*. This last progeny segregates for vigor and constituted an interesting tool for our genetic studies on growth.

Keywords: PCA, QTL mapping, vegetative vigor, biomass partitioning, quantitative trait

1. Introduction

In 1865, Mendelian studies gave birth to genetics as a science. The Mendelian model accurately explains inheritance for qualitative traits, with discontinuous distributions. But, what happens with quantitative, continuous traits, like growth or vigor? These quantitative, polygenic, complex traits reveal the expression of many genes with small but additive effects. The part of the chromosome where these genes are clustered is called quantitative trait loci or QTLs.

The main economic interesting traits, like production, growth, and vigor, have quantitative distributions and respond to QTLs. In addition, as they are being controlled by many genes, similar phenotypes may have different allelic variations, or plants with the same QTLs may have very different phenotypes in different environments. Additionally, the epistatic effect, caused by allelic combinations of different genes—meaning that the expression of a certain gene may affect the expression of another—adds variations in the final expression of the phenotype.

Sax [1] was the first to describe the theory of QTL mapping. Later, Thoday [2] suggested that it was possible to apply the well-known concept of segregation of simple genes, to linked QTL detection. The vital participation of molecular markers that have been developed through the years allowed improving the technique, permitting, in many cases, the identification of a certain gene or few genes responsible for the quantitative phenotypic variation [3]. In a very elegant thesis, Donoso Contreras [4] adopts the “needle in the hay” analogy to picture the difficulty in finding, in a whole genome, one gene with quantitative effect. QTL analysis allows dividing the hay into several “bunches of hay” and systematically looking for the “needle.”

QTL analysis links two types of information—phenotypic data (measurements) and genetic data (molecular markers)—in an attempt to explain the genetic bases of variations in complex traits [5, 6]. This analysis allows linking certain complex phenotypes to certain regions in the chromosomes. The original premise is to discover locus by co-segregation of the phenotypes with the markers.

Two things are essential for QTL mapping. In the first place, two contrasting parents for a certain trait are crossed, and a segregating population must be obtained. Later, genetic markers that distinguish the two parental lines are involved in the mapping. In this sense, molecular markers are preferred as they will rarely affect the studied trait. The markers linked to a QTL that influences the character or trait of interest will segregate with the trait (in high-frequency, lower recombination rate), while the non-linked markers will segregate separately (high recombination). For highly heterocygous species, like grapevines, to obtain pure homocygous lines is almost impossible, and the F1 progenies that do segregate are feasible to be studied. This progenies are called pseudo F1 progenies.

There are three statistic methodologies for the detection of a QTL: single marker analysis, simple interval mapping (SIM), and composite interval mapping (CIM). In the first case, single marker analysis, the technique is based on ANOVA and simple linear regression. It is simple and easy to do, not needing a genetic map as it analyzes the relation between each marker with the phenotype. On the other hand, SIM uses a genetic map to define the interval among adjacent pairs of linked markers [7]. Finally, CIM is combined with SIM for a single QTL in a given interval with multiple regression analysis of associated markers to other QTLs, including additional genetic markers or cofactors that control the genetic background. This is the most efficient and effective approach [8]. The results of QTL analysis are presented in terms of logarithm of the odds (LOD) scores or probabilities [9]. Strictly, a QTL is considered significant when its LOD score is higher than the LOD score calculated by permutation tests [10]. After localizing the QTL, the explained variability is calculated by means of the average values of the phenotypes of the genetic groups of the QTL, in the position of the map with maximum LOD score [3].

1.1 Vigor as a quantitative trait

Vigor is considered the genotype’s propensity to assimilate, store, and/or use nonstructural carbohydrates for producing large canopies, and it is associated with intense metabolism and fast shoot growth [11, 12]. Carbon assimilation (A) turns to be the vital mechanism that makes growth possible. For A to occur, CO_2 must diffuse into the leaf mesophyll, through opened stomata. The trade-off of C assimilation is loss of water from the leaf to the atmosphere. This inevitable water loss through opened stomata (and the depreciable diffusion through cuticle) constitutes transpiration (E). This means that A and stomatal conductance (g_s) are tightly correlated [13] and stomata are directly responsible for optimizing E vs. A [14].

Growth involves cell expansion and cell division [15]. Cell expansion takes place when cell walls deform under the action of tensile forces, generally caused by turgor

[16]. The plant water uptake capacity is influenced by the hydraulic conductance (k_H) of the roots which in turn confers different hydration and turgor to the canopy [17, 18], conferring different growth levels by cellular extension [19]. Keller [20] found that k_H adapts to support canopy growth and carbon partitioning but may limit shoot vigor in grapevines. These differences in k_H that account for variation in growth among genotypes have a genetic correlate. Marguerit et al. [21] detected quantitative trait loci (QTL) for E, soil water extraction capacity, and water use efficiency (WUE) when studying water stress response of *Vitis vinifera* cv. Cabernet Sauvignon × *Vitis riparia* cv. Gloire de Montpellier progeny. They observed that their QTLs co-localized with genes involved in the expression of hydraulic regulation and aquaporin activity that directly affect the plant k_H , as previously proposed [18].

There is increasing interest in deepening on the genetic basis of vigor and biomass production. It is well established that growth and vigor are quantitative traits and their genetic architecture consists of multiple genes with small individual effects. Today, several linkage maps are available, like Syrah × grenache, Cabernet Sauvignon × Riesling, and Ramsey × *Vitis riparia* [22–24]. Lowe and Walker concluded that the Ramsey × *V. riparia* linkage map was a valuable tool with which to examine and map traits like biotic resistance, drought tolerance, and vigor. This map was used to study vigor and map QTLs in relation to this trait.

2. Physiological component of vigor

In 1997, under code 9715, in the University of California, Davis, a cross between Ramsey (*Vitis champinii*) and *Vitis riparia* Gloire de Montpellier (**Figure 1**) was done. The purpose of this cross was to study biotic resistances. Later, it was observed that the population also segregated for vigor and vegetative growth, among other quantitative traits [24]. This allowed the opportunity of inquiring about the genetic and mechanistic bases of this characteristic.

This population is a pseudo F1 cross of Ramsey and *V. riparia* GM. In grapevine, the high heterozygosity makes it impossible to recover pure homozygous lines and obtain F2 crosses or backcrosses. Segregation is possible in pseudo F1 populations. In this way, our F1 from Ramsey and *V. riparia* GM was obtained with the intention of studying biotic and abiotic resistances and vigor.

One hundred thirty-eight genotypes from a F1 progeny between Ramsey and *V. riparia* GM were evaluated at UC Davis, California, in the summer of 2014 and 2015. Shoot growth rate (b); leaf area (LA); leaf, shoot, and root dry biomasses (DWL, DWS, DWR); plant hydraulic conductance (k_H); root hydraulic



Figure 1.
*Two extreme genotypes from the Ramsey (*Vitis champinii*) and *Vitis riparia* Gloire de Montpellier. UC Davis, Davis, CA, USA.*

conductance (L_{pr}); stomatal conductance (g_s); and water potential (Ψ) were measured as vigor-related traits. Specific leaf area (SLA: LA/leaf biomass) was calculated, and QTL mapping and detection were performed on both parental and consensus maps. A complete description of the techniques and methods used to measure and assess the variables studied is published by Hugalde et al. [25].

Hydraulic variables were not mapped, as they were measured in a smaller number of genotypes given the time-consuming nature of the methods that assess them. However, significant statistics evidenced an important role of root hydraulics in vigor definition [25].

A principal component analysis (PCA) of a subset of 50 genotypes explained 80% of the variability (**Figure 2**). Component 1 showed strong positive effects of LA, growth rate (b), and root dry weight (DWR), while strong and negative effect was found for specific root hydraulic conductance (L_{pr} , hydraulic conductance per gram of dry biomass). This negative effect explains that more vigor corresponds to lower L_{pr} , meaning that smaller plants and smaller root systems tend to be, when considered per biomass weight, more effective in water absorption than vigorous plants. This was also observed by Lovisolo et al. [26] in olive dwarfing rootstocks, Herralde et al. [17] when studying grapevine rootstocks under water stress, and Kaldenhoff et al. [27] with *Arabidopsis thaliana* and an antisense construct targeted to the PIP1b aquaporin gene. Later, similar results were observed in kiwi plants, where leaf area-specific conductance and g_s were both higher in the low-vigor rootstocks [28]. Finally, one more study with two chickpea progenies showed the same type of behavior, being the low-vigor plants the ones with higher root hydraulic conductivity and higher transpiration rates [29]. This higher L_{pr} in small root systems of low-vigor plants seems to try to compensate the low biomass production, while vigorous plants, which may be less efficient per biomass unit, have bigger root systems, with more biomass accumulation, and in conclusion higher total root hydraulic conductance.

For component 2, positive effects were explained by specific leaf area (SLA) and the partitioning index constituted by leaf area (LA) and total biomass.

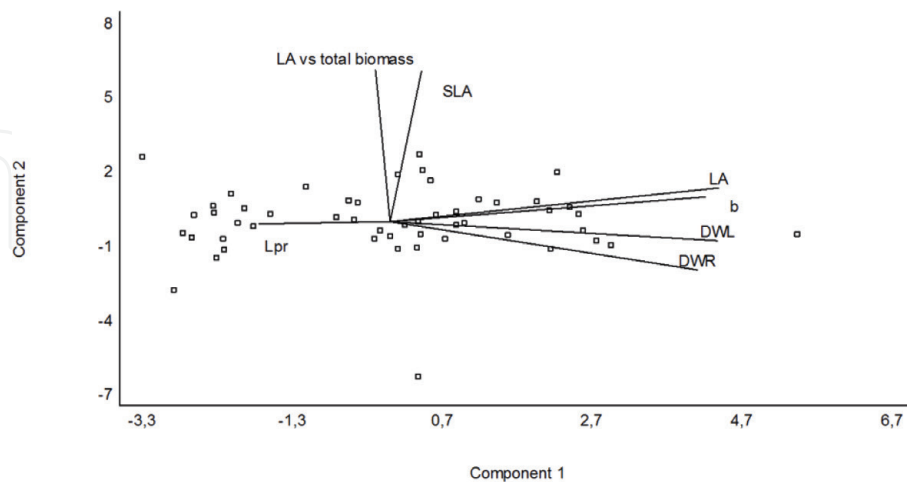

Component	Variance %	Cumulative %
1	52.016	52.016
2	27.576	79.593

Figure 2.

Principal components analysis of the main phenotypic characters related to vigor under well-watered conditions in 2015. L_{pr} , root-specific hydraulic conductance; b , stem growth rate; SLA, specific leaf area; DWL, leaf dry weight; DWR, root dry weight; LA, leaf area; LA vs. total biomass, partitioning index. $N = 50$ [25]. This analysis was carried out with Statgraphics centurion XVI, 16.1.11.

important parameter of growth rate because the larger the SLA, the larger the area for capturing light per unit of previously captured mass. These indices indicate that different genotypes with different vigor also have different partitioning pathways; as for vigorous plants, more LA *vs.* total biomass can be expected, while for smaller plants, the opposite is expected. However, when comparing dry weights (biomass), low-vigor plants tend to have small canopies and also small root systems. This clearly shows how LA, which depends on leaf biomass and the hydraulic situation (turgor that allows cell expansion), is so different between opposite genotypes. Big plants with higher total plant hydraulic conductance have more leaf area, with respect to their biomasses, than small plants [25].

3. Genetic component of vigor: QTL mapping in a grapevine population

The Ramsey \times *V. riparia* GM progeny showed transgressive segregation and significant differences between small, intermediate, and big plants. **Figure 3** shows vigor (canopy biomass, B) for the complete progeny and the parents, for 2014. Data for 2015 (not shown) showed similar results [25].

For *V. riparia* GM, during the first year of study, 16 significant QTLs at the chromosome level were found (LOD scores higher than the threshold value calculated after 1000 permutations, for α 0.05), but only three resulted significant genome wide (LOD scores higher than the threshold calculated for the genome). The partitioning indices related to canopy *vs.* root biomass were significant at the group level and considered putative (**Table 1**).

For LA *vs.* total plant biomass and SLA, QTLs explaining 11.4 and 9% of variance were found in chromosome 1, next to a putative QTL for LA. For LA, another QTL, explaining 12% of total variance, was found in chromosome 4.

During the second year of study and mapping, the parental map of *V. riparia* GM showed five QTLs, significant at the chromosome level (**Table 2**). This time, chromosomes 4 and 16 showed once more QTLs for traits related to biomass partitioning and LA. This result allowed us to have good confidence about these QTLs, previously considered as putative, but found in two independent mapping processes. On the other side, for variables like SLA and growth rate, new QTLs were found during 2015.

For the parental Ramsey map (**Table 3**), during 2014, the first year of mapping, seven putative QTLs were found. LA/total biomass, SLA, and partitioning indices

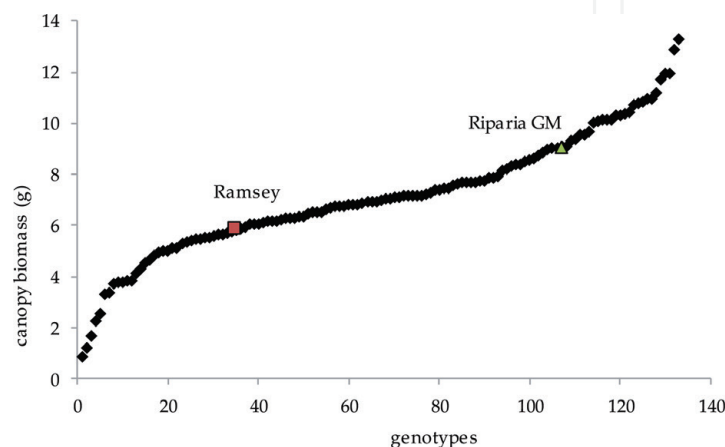

Figure 3.
Vigor (canopy biomass) for the complete progeny and the parents for 2014 [25].

Chromosome	Trait	LOD	Chromosome LOD threshold	Explained variance (%)	Genome LOD threshold
1	LA/total biomass	3.3	1.5	11.4	2.6–2.8
	LA/DWR	2.13	1.5	7.5	
	SLA	2.6	1.5	9	
	LA	2.03	1.6	8	
4	LA	3.48	1.6	12	
	Total biomass	2.15	1.6	8	
	Canopy	1.93	1.6	7	
	DWL	2.39	1.7	9	
16	DWR/DWS	1.8	1.6	7	
	DWR	1.96	1.6	7	
5	DWR/total biomass	2.45	1.5	8.5	
	Canopy/total biomass	2.45	1.5	8.5	
	DWS/total biomass	2.02	1.5	7	
	Canopy/DWR	2.44	1.5	8.5	
19	Stem growth rate (b)	1.55	1.5	6	

Bold letter indicates genomewide significance for the trait.

Table 1.
QTLs for the *V. riparia* GM parental map in 2014 [25].

Chromosome	Trait	LOD	Chromosome LOD threshold	Explained variance (%)	Genome LOD threshold
7	LA/total biomass	1.95	1.6	7	
	SLA	2.08	1.6	8	
15	Stem growth rate (b)	2	1.3	7	2.6–2.8
16	DWS/total biomass	1.63	1.3	6	
4	LA/total biomass	2.32	1.7	9	

Bold letter shows significant traits for 2014 and 2015, related to LA.

Table 2.
QTLs for parental *V. riparia* GM map in 2015.

were mapped. No QTLs for LA, growth rate, canopy, or total biomass could be detected.

During the second mapping, in 2015, Ramsey showed 21 QTLs (**Table 4**), among which four were genome-wide significant, being all the rest considered as putative (significant at the chromosome level). Among these putative QTLs, it is worthy to mention that the mapped traits were LA, growth rate, canopy, and total biomass, also found in the Riparia map. In addition, one of the putative QTLs corresponded to shoot biomass (DWS), also found in chromosome 14, in 2014. The four genome-wide significant QTLs were found in chromosomes 1 and 19 of the Ramsey map, corresponding to partitioning variables like DWR/DWL, DWR/total biomass, canopy/total biomass, and LA/total biomass. This last trait, which explains 11% of the phenotypic variance, has almost the same biological meaning as SLA, as it represents the possibility of the plant to transform biomass from its “whole body,” into sunlight-receiving screen, for photosynthesis. This variable was mapped in

Chromosome	Trait	LOD	Chromosome LOD threshold	Explained variance (%)	Genome LOD threshold
13	LA/total biomass	2.05	1.4	75	2.7-2.8
	LA/DWR	2.28	1.4	8	
	SLA	1.45	1.3	5	
	DWS/total biomass	1.47	1.4	5	
14	DWL/total biomass	2.21	1.9	8	
	DWS/DWL	1.93	1.8	7	
	DWR/DWL	2.05	1.9	7	

QTLs for parental Ramsey map in 2014.

Table 3.
QTLs para el mapa de Ramsey para 2014.

Chromosome	Trait	LOD	Chromosome LOD threshold	Explained variance (%)	Genome LOD threshold
14	DWS	2.23	1.7	8	
	Canopy	1.83	1.7	7	
	LA	1.91	1.8	7	
	Number of leaves	2.25	1.8	8	
	Growth rate b	2.25	1.7	9	
9	DWR	2.23	1.5	8	
	Total biomass	1.62	1.4	6	
6	DWR/total biomass	1.6	1.6	6	
	Canopy/total biomass	1.73	1.5	6	
	Canopy/DWR	2.08	1.7	8	
1	Canopy/DWR	2.43	1.6	9	
	DWR/DWS	2.38	1.6	9	
	DWR/DWL	2.68	1.6	10	
	DWR/total biomass	2.86	1.6	10	
19	Canopy/total biomass	2.86	1.7	10	
	SLA	2.05	1.5	8	
	LA/total biomass	3	1.4	11	
8	DWS/DWL	1.52	1.3	5	
17	DWS/DWL	1.52	1.2	5	
4	DWS/total biomass	2.33	1.6	9	
	LA/total biomass	1.89	1.7	7	

Bold letter shows genomewide significant traits and LA related traits.

Table 4.
QTLs for the parental Ramsey map in 2015.

Chromosome	Trait	LOD	Chromosome LOD threshold	Explained variance (%)	Genome LOD threshold
1	LA/total biomass	3.39	2.8	12	4
	SLA	3.23	2.8	11	
13	LA	2.8	2.8	10	
4	LA	3.67	2.7	12.5	
3	Canopy	2.95	2.5	10	
	DWS/DWL	2.64	2.4	9	
	DWL/total biomass	2.64	2.5	9	
	DWL	3.82	2.5	13	
	Total biomass	3.04	2.5	10.4	
11	LA	2.9	2.7	10	
5	DWR/DWL	2.92	2.4	10	
	DWR/total biomass	3.38	2.5	11.5	
	Canopy/total biomass	3.38	2.6	11.5	
	Leaf density	3.41	2.5	12	
10	Canopy/DWR	2.85	2.6	10	
7	Leaf density	3.65	2.7	12.5	

Bold letters show traits related to LA.

Table 5.
QTLs for consensus maps for 2014.

Chromosome	Trait	LOD	Chromosome LOD threshold	Explained variance (%)	Genome LOD threshold
6	DWR	2.83	2.8	10	
3	LA	2.75	2.6	10	
1	DWR/DWL	3.16	2.8	11	
	DWR/total biomass	2.82	2.8	10	4.2
	Canopy/total biomass	2.82	2.8	10	
17	DWS/total biomass	2.81	2.6	10	
19	LA/total biomass	4.28	2.7	15	

Bold letters show genomewide significant traits.

Table 6.
QTLs for consensus map (2015).

chromosome 19, along with SLA, probably evidencing that it could be possible that the same genes encode for both traits.

Consensus maps of both mappings are shown in **Tables 5 and 6**.

Consensus map from 2014 (**Table 5**) showed significant QTLs at the chromosome level, but not genome wide. There was positive interaction in chromosomes 5 and 7 for leaf density and in chromosomes 5, 4, and 13 for LA, variables that were not mapped in the parents. In these consensus maps, significant QTLs were also mapped

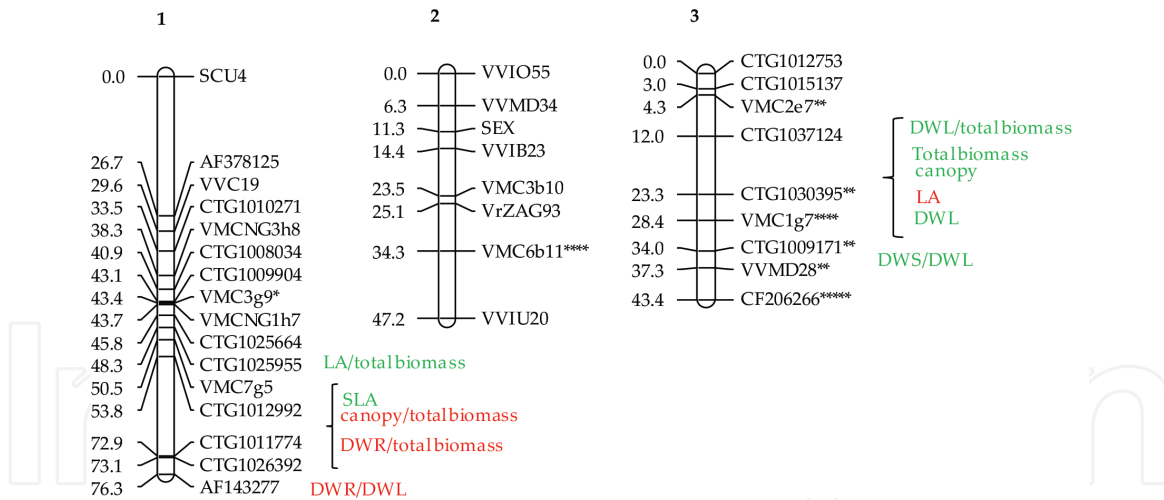

Figure 4. Consensus linkage map from Ramsey and Riparia Gloire de Montpellier. Chromosomes 1–3. In green, QTLs mapped in 2014. In red, QTLs mapped in 2015.

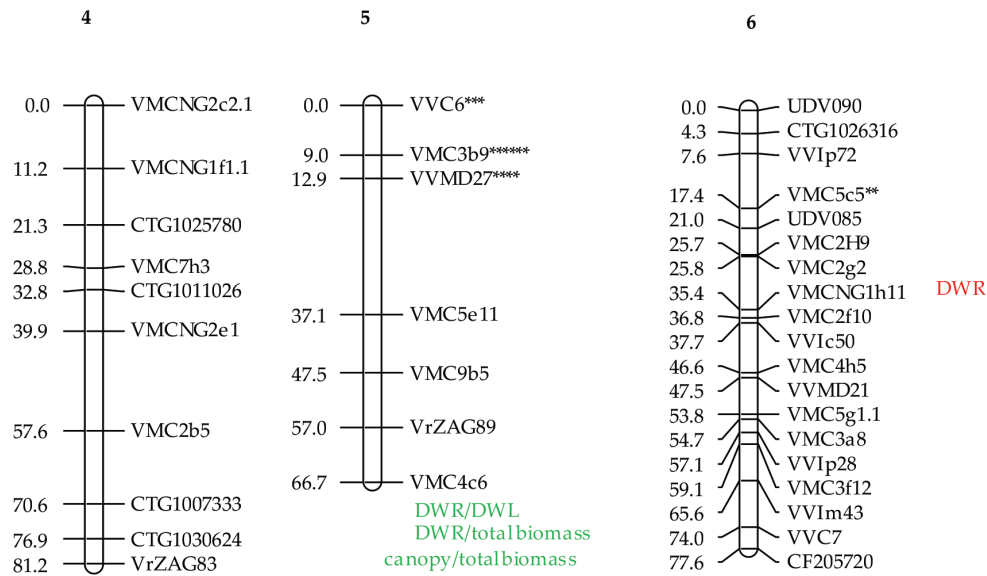

Figure 5. Consensus linkage map from Ramsey and Riparia Gloire de Montpellier. Chromosomes 4–6. In green, QTLs mapped in 2014. In red, QTLs mapped in 2015.

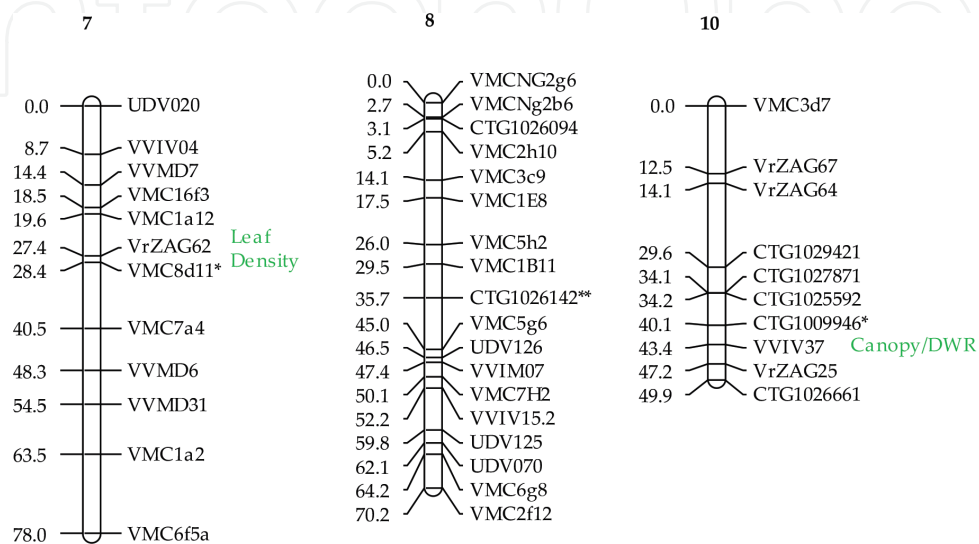

Figure 6. Consensus linkage map from Ramsey and Riparia Gloire de Montpellier. Chromosomes 7–10. In green, QTLs mapped in 2014.

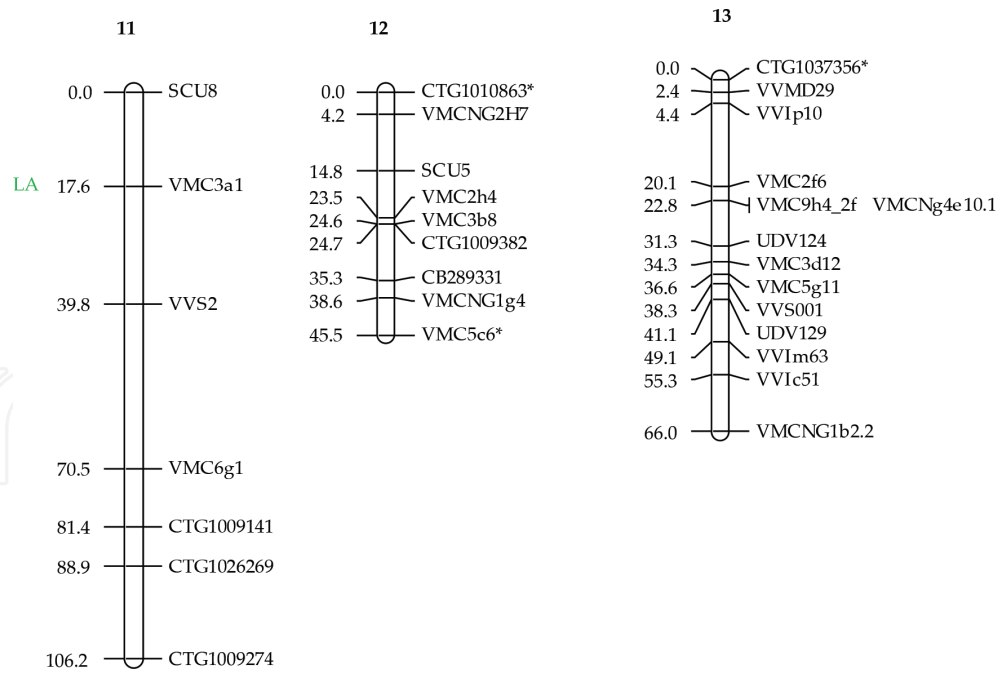

Figure 7. Consensus linkage map from Ramsey and Riparia Gloire de Montpellier. Chromosomes 11–13. In green, in chromosome 11, QTLs mapped in 2014 for LA.

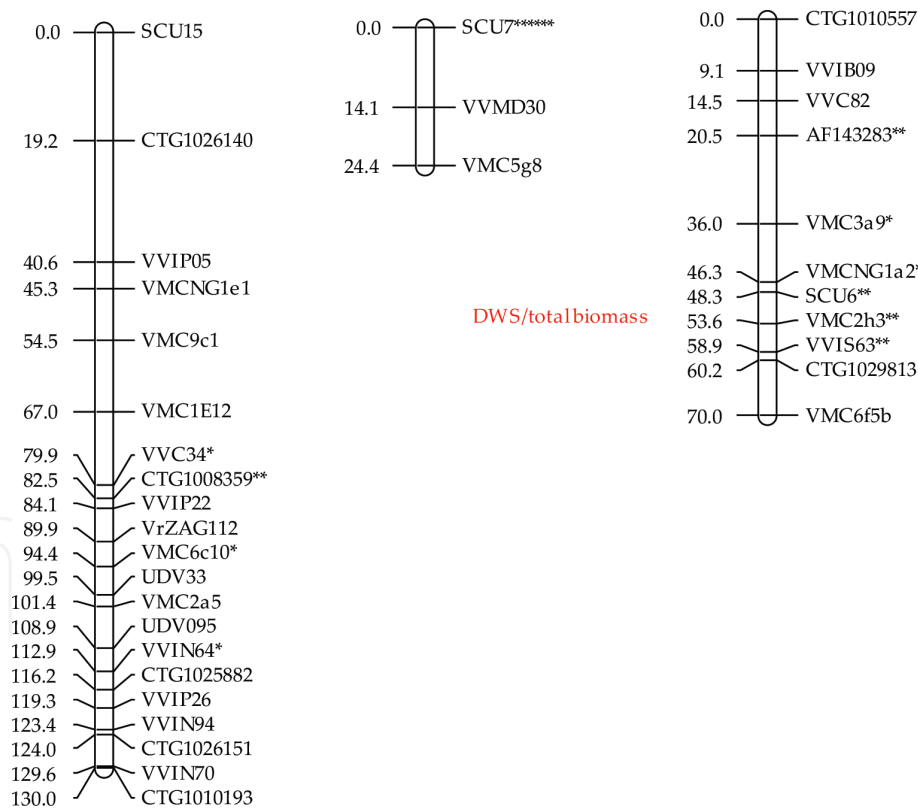

Figure 8. Consensus linkage map from Ramsey and Riparia Gloire de Montpellier. Chromosomes 14, 15, and 17. In green, QTLs mapped in 2014. In red, QTLs mapped in 2015.

in chromosomes 3, 10, and 11 for canopy biomass (what we consider vigor), LA, and biomass partitioning (canopy/DWR).

Negative interaction was also found in chromosome 13 of Ramsey. LA/total biomass, LA/DWR, SLA, and DWS/total biomass were mapped in the parental map but were not found in the consensus map.

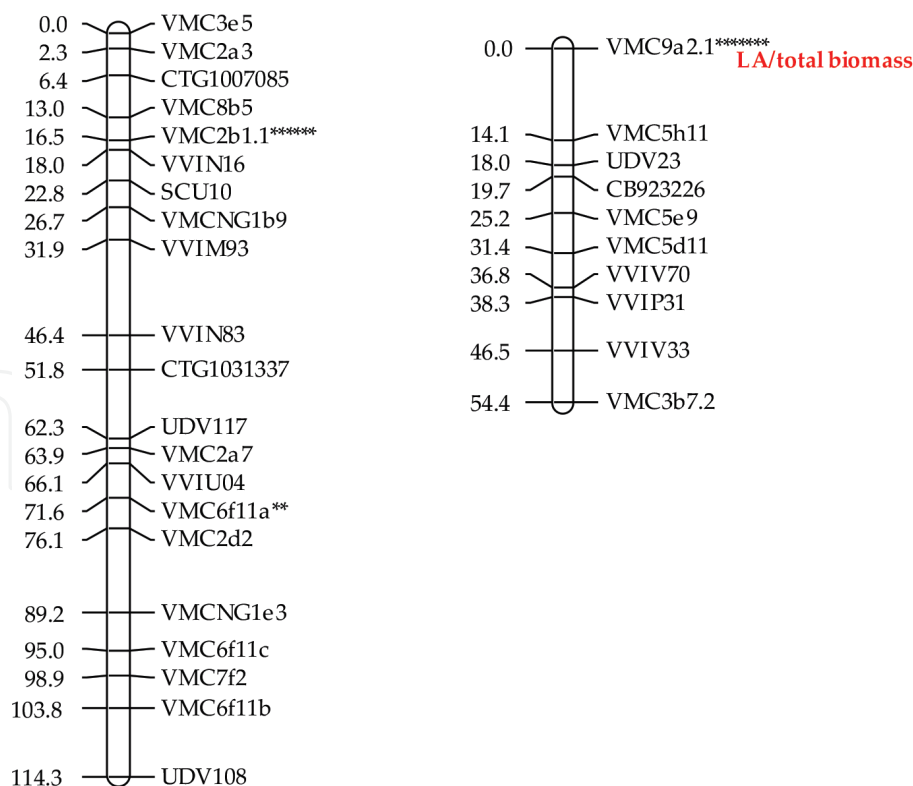

Figure 9. Consensus linkage map from Ramsey and Riparia Gloire de Montpellier. Chromosomes 18 and 19. In red, in chromosome 19, the QTLs mapped in 2015.

With regard to the consensus map of 2015 (**Table 6**), many QTLs that were not mapped in 2014 were mapped this time. Six QTLs were found to be significant at the chromosome level, while only one was significant genome wide. In chromosome 19, one QTL for LA/total biomass, also found in Ramsey, explained 15% of total variance.

As observed in 2014, negative interaction was also found in 2015. This time, DWS, canopy, leaf number, growth rate, total biomass, canopy/DWR, DWR/DWS, SLA, DWS/DWL, and DWS/DWL were mapped in the parental map of Ramsey, but were not found in consensus map. The same happened for SLA and growth rate in reference to the *V. riparia* GM parental map that showed QTLs for these traits, but were not found in consensus.

Figures 4–9 show the linkage map of Ramsey and *V. riparia* GM [24], the 19 chromosomes and the approximate localization of the QTLs mapped in consensus maps. In green, QTLs were found in the first year, 2014. In red, QTLs were found in the second mapping, from 2015. QTL mapping was carried out with JoinMap/MapQTL 6 2003–2018, Kyazma B.V.

4. Identifying other quantitative traits in grapevine: QTL maps and underlying phenotypes

One major purpose in grapevine genetics is to identify quantitative loci, and underlying genes, that explain the natural genetic variation of specific traits. The frequent quantitative nature of genetic variation in grapevine requires the use of QTL mapping to understand the genetic architecture of traits. Several maps have been created and studied in grapevine with these purposes. Crosses between contrasting varieties have given birth to several progenies that constitute the basis for QTL/genetic mapping. Agronomic interesting traits like resistances to powdery and

downy mildew, Phylloxera, Pierce's disease, and Xiphinema were studied in *V. vinifera* complex hybrids, *V. cinerea*, *V. rupestris*, and *V. arizonica* [30–37]. QTLs related to growth and development were found in progenies like Picovine × Ugni blanc [38], Riesling × Gewurztraminer [39], and Syrah and Grenache [40]. Also, in *V. vinifera* complex hybrids and *V. cinerea*, *V. rupestris*, and *V. arizonica*, traits related to plant physiology were studied: flowering and ripening dates, flower sex, and mineral deficiencies [21, 30–32, 41, 42]. Additionally, in Syrah × Pinot Noir, Grzeskowiak et al. [43] detected QTLs related to budburst, flowering beginning, the onset of ripening (*véraison*), and total fertility, while Bayo Canha [44] studied Monastrell × Syrah in search for QTLs related to phenology, enology-related traits, and productive and morphological traits.

Breeding purposes include a wide spectrum of objectives. Classic breeding programs have searched for biotic and abiotic resistances, as well as production, quality, growth, and developmental characteristics. Genomic studies and genetic mapping can significantly speed up the selection of seedlings with desired traits. Early identification of individuals carrying the desired allele combinations results in decreased maintenance and evaluation costs. The identification of genes and molecular markers underlying specific traits will help accelerate the breeding process, generating new prospects for crop improvement [44].

5. Conclusions

Vigor, a quantitative character, is particularly difficult to address. A large number of variables need to be studied in order to achieve a fine comprehension of the phenomena involved. In our study, we analyzed vigor from a wide physiological view and a genetic mapping approach. The mathematical function that represents growth, called sigmoid, starts with an initial plateau where small effects occur. Later, as these small effects accumulate, and cause successive effects, the function turns exponential. For quantitative characters, where positive feedbacks (typically exponential) can cause large effects, low but statistically significant explanatory levels, like the QTLs found, as well as the physiologic results, may have impressive effects.

It turns interesting to observe that many variables that physiologically showed to be significant in vigor explanation could be mapped and significant QTLs were found for them. The most important ones, SLA, LA, and LA/total biomass, showed to be significant in the PCA analysis as well as for the QTL mapping.

Previous studies bring support to our findings. When mapping the population of Picovine × Ugni blanc, Houel et al. [38] also found a QTL for LA in chromosome 4 of the parental map of ugni blanc and one QTL for LA in chromosome 9 of Picovine. In addition, QTLs related to budbreak explaining 11 and 12% of variation were mapped in chromosomes 4 and 19 in the Riesling × Gewurztraminer population [39], and five QTLs for growth rate were found in linkage groups 4, 10, 15, 17, and 18, in the Syrah and grenache population, altogether accounting for up to 30% of total variance [40]. Moreover, Díaz-Riquelme et al. [45] found that five MIKC genes (that encode for transcription factors with growth and developmental functions in plants) of grapevine were localized in chromosome 1. In our mapping, the major number of QTLs was found in chromosomes 1, 3, 5, 13, and 19, coincident with other studies.

After the QTL mapping, the next step would be to manage the search of candidate genes by saturating the portion of the chromosome that includes the interesting QTL and narrowing the piece of DNA that includes the candidate genes. As an example, by saturating chromosome 19, we could try to find candidate genes for the expression of the relation among LA and biomass production. This would finally

support a breeding strategy, where to have a more efficient growing plant could turn to be important.

Vigor in grapevine, as many quantitative traits, appears to have a complex genetic background. This character, beside its biological significance, has a wide agronomical impact, not only related to the plant behavior but also linked to the amount and the quality of the harvest. In this paper, the analysis over a segregating progeny of Ramsey \times *V. riparia* GM was able to identify several vigor-linked traits with good statistical support. Whereas the effect expected to be explained for each individual trait appears to be small, it will shed light to this complex character.

The phenotyping of segregating progenies constitutes a valuable tool for clarifying the genetic basis of traits of complex nature. An accurate choice of the parameters to be studied is crucial in order to optimize the experimental procedure and data analysis. In consequence, a previous understanding of the physiological basis of a trait of interest, or at least a very well-supported hypothesis, should lead a population genetics study. When these issues are considered, the obtained results would be able to achieve the expected goal.

Acknowledgements

Results shown in this Chapter were supported by INTA EEA Mendoza, Argentina and Viticulture and Enology, UC Davis, CA, USA.

We especially thank Nina Romero, Joaquín Fraga, Andy Viet Nguyen, Cassie Bent, Becky Wheeler, Karla Huerta, Jake Uretsky and Ashley Eustis for their valuable help in assessing and measuring experiments.

Author details

Inés Pilar Hugalde^{1,2*}, Summaira Riaz², Cecilia B. Agüero², Hernán Vila¹, Sebastián Gomez Talquenca¹ and M. Andrew Walker²

1 Estación Experimental Agropecuaria Mendoza, INTA, Mendoza, Argentina

2 Department of Viticulture and Enology, UC Davis, Davis, CA, USA

*Address all correspondence to: hugalde.ines@inta.gob.ar

IntechOpen

© 2019 The Author(s). Licensee IntechOpen. This chapter is distributed under the terms of the Creative Commons Attribution License (<http://creativecommons.org/licenses/by/3.0>), which permits unrestricted use, distribution, and reproduction in any medium, provided the original work is properly cited. 

References

- [1] Sax K. The association of size differences with seed-coat pattern and pigmentation in *Phaseolus vulgaris*. *Genetics*. 1923;**8**(6):552
- [2] Thoday JM. Location of polygenes. *Nature*. 1960;**191**:368-370
- [3] Torres AM et al. QTL detection and application to plant breeding. In: *La genética de los caracteres cuantitativos en al mejora vegetal del siglo XXI*. España: Sociedad Espanola de Genetica; Sociedad Espanola de Ciencias Hortícolas; 2012
- [4] Donoso Contreras JM. Genética de la introgresión de genes del almendro (*Prunus dulcis* Mill.) en el melocotonero [*P. persica* (L.) Batsch]: desarrollo de una estrategia de selección de líneas casi isogénicas (Nils) con marcadores moleculares; 2014
- [5] Falconer DS, Mackay TF, Frankham R. Introduction to quantitative genetics (4th ed). *Trends in Genetics*. 1996;**12**(7):280
- [6] Lynch M, Walsh B. *Genetics and Analysis of Quantitative Traits*. Vol. 1. Massachusetts, USA: Sinauer Sunderland; 1998
- [7] Lander ES, Botstein D. Mapping mendelian factors underlying quantitative traits using RFLP linkage maps. *Genetics*. 1989;**121**(1):185-199
- [8] Jansen RC, Stam P. High resolution of quantitative traits into multiple loci via interval mapping. *Genetics*. 1994;**136**(4):1447-1455
- [9] Boopathi NM. Marker-assisted selection. In: *Genetic Mapping and Marker Assisted Selection*. Springer; 2013. pp. 173-186
- [10] Churchill GA, Doerge RW. Empirical threshold values for quantitative trait mapping. *Genetics*. 1994;**138**(3):963-971
- [11] Ollat N et al. Vigour conferred by rootstock: Hypotheses and direction for research. *Bulletin de l'OIV*. 2003;**76**(869/870):581-595
- [12] Rebolledo M et al. Phenotypic and genetic dissection of component traits for early vigour in rice using plant growth modelling, sugar content analyses and association mapping. *Journal of Experimental Botany*. 2015;**66**(18):5555-5566
- [13] Wong SC, Cowan IR, Farquhar GD. Stomatal conductance correlates with photosynthetic capacity. *Nature*. 1979;**282**(5737):424
- [14] Rogiers SY et al. Stomatal response of an anisohydric grapevine cultivar to evaporative demand, available soil moisture and abscisic acid. *Tree Physiology*. 2012;**32**(3):249-261
- [15] Polymenis M, Schmidt EV. Coupling of cell division to cell growth by translational control of the G1 cyclin CLN3 in yeast. *Genes & Development*. 1997;**11**(19):2522-2531
- [16] Cosgrove DJ. Growth of the plant cell wall. *Nature Reviews Molecular Cell Biology*. 2005;**6**(11):850-861
- [17] De Herralde F et al. Effects of rootstock and irrigation regime on hydraulic architecture of *Vitis vinifera* L. cv. tempranillo. *Journal International des Sciences de la Vigne et du Vin*. 2006;**40**(3):133-139
- [18] Lovisolo C et al. An abscisic acid-related reduced transpiration promotes gradual embolism repair when grapevines are rehydrated after drought. *New Phytologist*. 2008;**180**(3):642-651

- [19] Di Filippo M, Vila H. Influence of different rootstocks on the vegetative and reproductive performance of *Vitis vinifera* L. malbec under irrigated conditions. *Journal International des Sciences de la Vigne et du Vin*. 2011;**45**(2):75-84
- [20] Keller M. *The Science of Grapevines: Anatomy and Physiology*. Prosser, WA, USA: Academic Press; 2015
- [21] Marguerit E et al. Rootstock control of scion transpiration and its acclimation to water deficit are controlled by different genes. *New Phytologist*. 2012;**194**(2):416-429
- [22] Adam-Blondon A-F et al. Mapping 245 SSR markers on the *Vitis vinifera* genome: A tool for grape genetics. *Theoretical and Applied Genetics*. 2004;**109**(5):1017-1027
- [23] Riaz S et al. A microsatellite marker based framework linkage map of *Vitis vinifera* L. *Theoretical and Applied Genetics*. 2004;**108**(5):864-872
- [24] Lowe K, Walker M. Genetic linkage map of the interspecific grape rootstock cross Ramsey (*Vitis champinii*) × Riparia Gloire (*Vitis riparia*). *Theoretical and Applied Genetics*. 2006;**112**(8):1582-1592
- [25] Hugalde I et al. Physiological and Genetic Control of Vigour in A ‘Ramsey’ × ‘Riparia Gloire de Montpellier’ Population. Leuven, Belgium: International Society for Horticultural Science (ISHS); 2017
- [26] Lovisolo C et al. Expression of PIP1 and PIP2 aquaporins is enhanced in olive dwarf genotypes and is related to root and leaf hydraulic conductance. *Physiologia Plantarum*. 2007;**130**(4):543-551
- [27] Kaldenhoff R et al. Significance of plasmalemma aquaporins for water-transport in *Arabidopsis thaliana*. *The Plant Journal*. 1998;**14**(1):121-128
- [28] Clearwater M, Lowe R, Hofstee B, Barclay C, Mandemaker A, Blattmann P. Hydraulic conductance and rootstock effects in grafted vines of kiwifruit. *Journal of experimental botany*. 2004;**55**:1371-1382
- [29] Sivasakthi K et al. Chickpea genotypes contrasting for vigor and canopy conductance also differ in their dependence on different water transport pathways. *Frontiers in Plant Science*. 2017;**8**:1663
- [30] Dalbó M et al. Marker-assisted selection for powdery mildew resistance in grapes. *Journal of the American Society for Horticultural Science*. 2001;**126**(1):83-89
- [31] Fischer BM et al. Quantitative trait locus analysis of fungal disease resistance factors on a molecular map of grapevine. *Theoretical and Applied Genetics*. 2004;**108**(3):501-515
- [32] Welter LJ et al. Genetic mapping and localization of quantitative trait loci affecting fungal disease resistance and leaf morphology in grapevine (*Vitis vinifera* L.). *Molecular Breeding*. 2007;**20**(4):359-374
- [33] Krivanek A, Riaz S, Walker M. Identification and molecular mapping of PdR1, a primary resistance gene to Pierce’s disease in *Vitis*. *Theoretical and Applied Genetics*. 2006;**112**(6):1125-1131
- [34] Riaz S et al. Fine-scale genetic mapping of two Pierce’s disease resistance loci and a major segregation distortion region on chromosome 14 of grape. *Theoretical and Applied Genetics*. 2008;**117**(5):671
- [35] Riaz S et al. Refined mapping of the Pierce’s disease resistance locus, PdR1, and sex on an extended genetic map of *Vitis rupestris* × *V. arizonica*. *Theoretical and Applied Genetics*. 2006;**113**(7):1317

- [36] Roush TL, Granett J, Walker MA. Inheritance of gall formation relative to phylloxera resistance levels in hybrid grapevines. *American Journal of Enology and Viticulture*. 2007;**58**(2):234-241
- [37] Xu K et al. Genetic and QTL analysis of resistance to *Xiphinema index* in a grapevine cross. *Theoretical and Applied Genetics*. 2008;**116**(2):305-311
- [38] Houel C et al. Identification of stable QTLs for vegetative and reproductive traits in the microvine (*Vitis vinifera* L.) using the 18 K Infinium chip. *BMC Plant Biology*. 2015;**15**(1):1
- [39] Duchêne E et al. Towards the adaptation of grapevine varieties to climate change: QTLs and candidate genes for developmental stages. *Theoretical and Applied Genetics*. 2012;**124**(4):623-635
- [40] Coupel-Ledru A et al. Reduced nighttime transpiration is a relevant breeding target for high water-use efficiency in grapevine. *Proceedings of the National Academy of Sciences*. 2016;**113**(32):8963-8968
- [41] Mandl K et al. A genetic map of Welschriesling × Sirius for the identification of magnesium-deficiency by QTL analysis. *Euphytica*. 2006;**149**(1-2):133-144
- [42] Costantini L et al. Berry and phenology-related traits in grapevine (*Vitis vinifera* L.): From quantitative trait loci to underlying genes. *BMC Plant Biology*. 2008;**8**(1):38
- [43] Grzeskowiak L et al. Candidate loci for phenology and fruitfulness contributing to the phenotypic variability observed in grapevine. *Theoretical and Applied Genetics*. 2013;**126**(11):2763-2776
- [44] Bayo Canha A. Genetic Analysis of Traits of Interest in *Vitis vinifera* Using a Progeny of Wine Grapes. PhD thesis. Universidad Politécnica de Cartagena. Colombia: Monastrell x Syrah; 2015
- [45] Díaz-Riquelme J et al. Genome-wide analysis of MIKCC-type MADS box genes in grapevine. *Plant Physiology*. 2009;**149**(1):354-369