

# We are IntechOpen, the world's leading publisher of Open Access books Built by scientists, for scientists

4,800

Open access books available

122,000

International authors and editors

135M

Downloads

Our authors are among the

154

Countries delivered to

TOP 1%

most cited scientists

12.2%

Contributors from top 500 universities



WEB OF SCIENCE™

Selection of our books indexed in the Book Citation Index  
in Web of Science™ Core Collection (BKCI)

Interested in publishing with us?  
Contact [book.department@intechopen.com](mailto:book.department@intechopen.com)

Numbers displayed above are based on latest data collected.  
For more information visit [www.intechopen.com](http://www.intechopen.com)



---

# Large-Area Synthesis and Growth Mechanism of Graphene by Chemical Vapor Deposition

---

Chen Wang, Kizhanipuram Vinodgopal and  
Gui-Ping Dai

Additional information is available at the end of the chapter

<http://dx.doi.org/10.5772/intechopen.79959>

---

## Abstract

There has been continuous progress in the development of different synthesis methods to readily produce graphene at a lower cost. Compared with the other methods, chemical vapor deposition (CVD) is an effective and powerful method of producing graphene and has attracted increased attention during the last decade. In this way, we can obtain good uniformity with a multitude of domains, excellent quality, and large scale of the produced graphene. Meanwhile, it is also helping for large-area synthesis of single-crystal graphene. In the CVD method, precursors are typically absorbed on the surface followed by pyrolytic decomposition, which leads to the generation of absorption sites on the surface and promotes the growth of continuous thin films.

**Keywords:** chemical vapor deposition, graphene, large-scale synthesis, growth mechanism

---

## 1. Introduction

Graphene (shown in **Figure 1**), as a versatile two-dimensional material [1], has attracted great interest in the research community owing to its high mechanical stiffness [2], great flexibility [3], and stable chemical properties [4–6]. Based on the properties of graphene and its nano-scale thickness, it has been selected as a material for various applications in electrical, chemical, mechanical, optical, and catalysis industries [7–11]. Hence, it is very critical to propose methods for preparing high-quality graphene film.

Compared with other methods, such as mechanical exfoliation of graphite [12–14], liquid-phase exfoliation [15, 16], and reduction of graphene oxide (GO) [17, 18], chemical vapor deposition

---

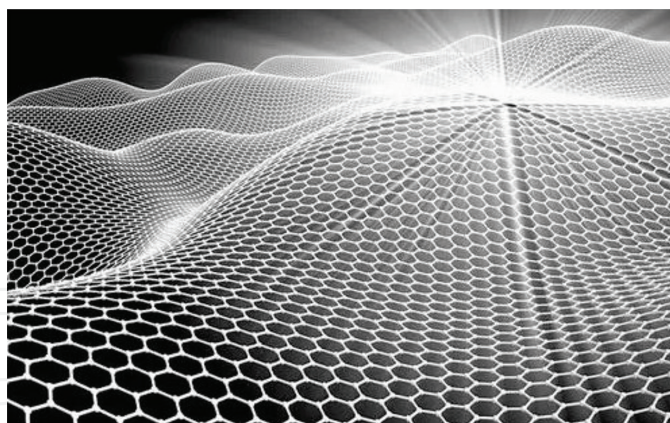

**Figure 1.** The schematic diagram of graphene.

(CVD) is regarded as the most promising way for large-scale graphene production at a large scale with low defects, good uniformity, and controlled number of graphene layers, which has attracted intense research attention during the last decades [19–22]. CVD involves the activation of gaseous reactants and the subsequent chemical reaction, followed by the formation of a stable solid deposit over a suitable substrate such as Ni [6, 23], Cu [5, 24, 25], Fe [26], Pt [27, 28], or their alloys [29, 30]. As early as 1969, Robertson et al. [31] discovered that chemical vapor deposition in the presence of methane produces a layer of graphite on some transition metal surfaces. However, even if the prepared graphene displays excellent performance, it cannot be applied to the related devices due to the limitations of deposition on the metal surface. The advent of poly(methyl methacrylate)-mediated nanotransfer printing technology [32] enabled the successful transfer of graphene from the growth substrate to any other substrate, and it also completely changed the status of chemical vapor deposition methods in the preparation method of graphene.

It is worth mentioning that, compared to exfoliated graphene obtained from natural graphite, the CVD graphene still shows a lower carrier mobility ranging from 100 to 1000  $\text{cm}^2/(\text{V}\cdot\text{s})$ , due to the presence of growth defects and boundaries [33]. Therefore, a feasible route to improve graphene film quality lies in increasing the domain size that enables to avoid the side effect of graphene domain boundaries.

Now, large-area graphene synthesized have generally been single crystalline, and related research is aimed to control the domain size, defects, number of graphene layers, and so on. With regard to desired graphene, there are many effect parameters including hydrogen, oxygen, gas flow rate, and residence time.



**Figure 2.** Image of meter-size single-crystal graphene. Reproduced with permission of ref. [34].

In addition, great success has been achieved in the fabrication of large-area, single-crystalline graphene. Different teams have published reports on the single crystals. We also summarize these experimental results.

There are already many comprehensive articles published about increasing the size of graphene. Among these articles, a publication by Xu et al. [34] reports the fabrication of meter-size single-crystal graphene. The authors developed an innovative method to achieve the ultrafast epitaxial growth of meter-sized single-crystal graphene on a commercially available Cu foil (shown in **Figure 2**).

In this chapter, we talk about the preparation of high-quality graphene in recent years, effect of experimental parameters, challenges of preparation of high-quality graphene, and timeline of graphene production. Finally, development trend and application prospect of CVD graphene are described.

## 2. Preparation of graphene

Great effort has been given to the synthesis of graphene with controlled size, morphology, edge structures, and layer numbers [22, 35–40]. Studies into the dynamics of CVD graphene growth on copper foils have chiefly focused on monolayer films that develop under vacuum conditions. Up to now, the preparation methods of graphene are usually divided into two ways: physical and chemical (shown in **Figure 3**). With respect to physical method, mechanical exfoliation [12–14] and liquid-phase exfoliation [15, 16] are always used. With respect to chemical methods, they include CVD, reduction of graphene oxide (GO) [17, 18], epitaxial growth on various substrates.

### 2.1. Mechanical exfoliation

The mechanical exfoliation method can provide the highest quality graphene sheets, which strips the graphene layers from the surface of graphite crystals by mechanical force. It is not suitable for mass production, however, because of the difficulty in controlling the number of layers and the size of sheets.

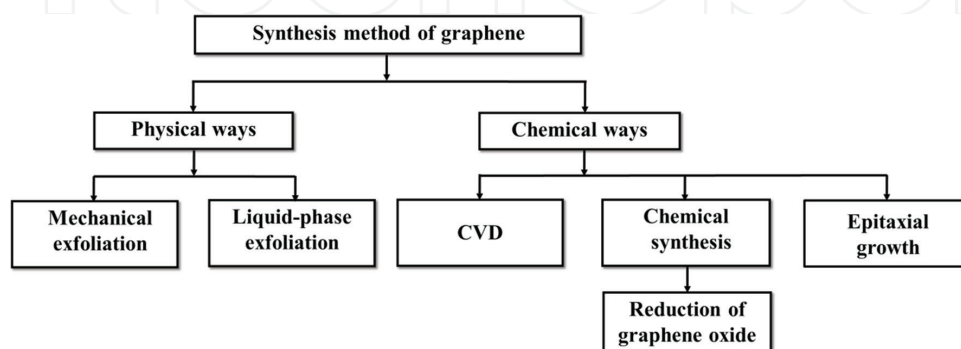

**Figure 3.** Classification of graphene synthesis techniques.

## 2.2. Liquid-phase exfoliation

Liquid-phase exfoliation cannot produce graphene films with high electronic quality, where scatter graphite to specific solvents or surfactants, and strip the single layer or multilayer graphene through ultrasonic energy to get graphene dispersions [15, 41].

## 2.3. Reduced graphene oxide (RGO)

With regard to RGO methods, first, the graphite is oxidized by treatment with  $\text{KMnO}_4$ ,  $\text{NaNO}_3$ , and so on. Second, GO prepared from flake graphite can be readily dispersed in water and has been used on a large scale for preparing large graphitic films, but it would result defects in graphene [42].

## 2.4. Chemical vapor deposition

In comparison, CVD is an effective and powerful method of producing graphene. CVD processes typically involve two steps: the activation of gaseous reactants and the chemical reaction of forming a stable solid deposit over a suitable substrate [43, 44]. The deposition process consists of two types of reactions: homogeneous gas-phase reactions, occurring in the gas phase, and heterogeneous chemical reactions that occur on a heated surface. Therefore, CVD method is the use of carbon source (gas, liquid, and solid) decomposing in the high-temperature reaction zone, the release of carbon atoms in the metal substrate, eventually it forms a continuous graphene membrane. And many researchers use CVD method to prepare the high-quality and large-area graphene, as Li et al. [45] pointed (shown in **Figure 4**). Subsequently, CVD can be divided into two types: (I) thermal CVD and (II) plasma-enhanced CVD.

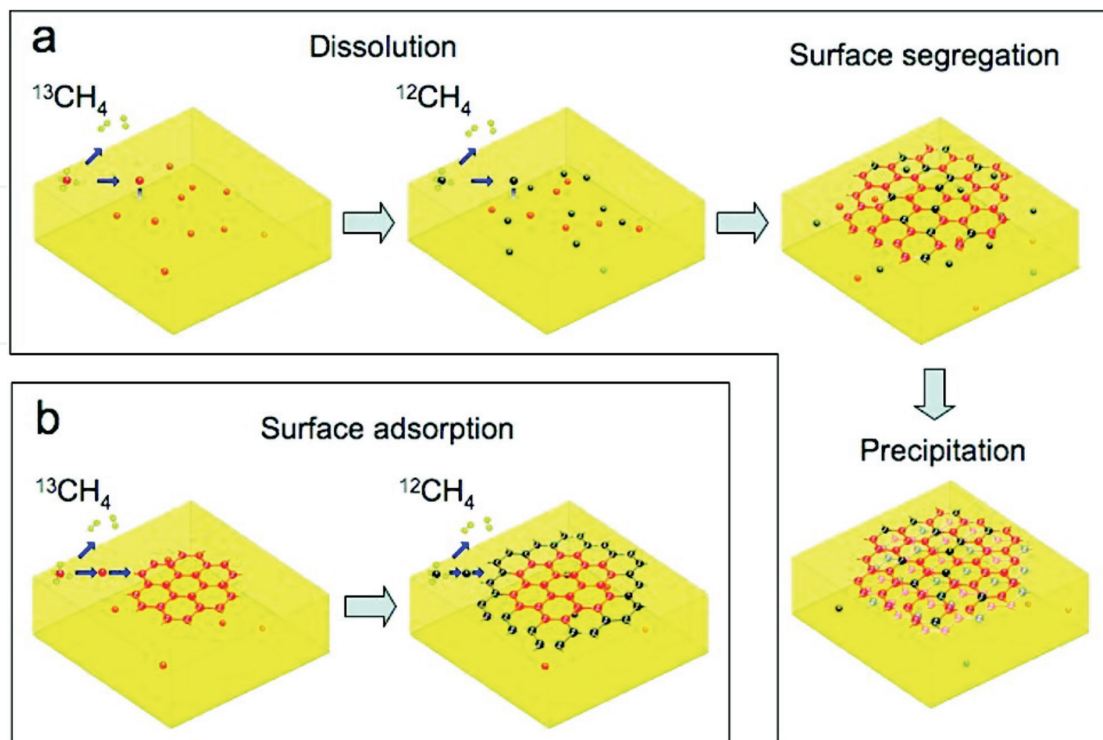

**Figure 4.** Schematic diagram of growth mechanism of graphene on the metal substrate. Reproduced with permission of ref. [45].

## 2.5. Epitaxial growth on substrates

Obviously, the term “epitaxial growth” means ordered or arranged atomic growth in single crystalline manner over a single-crystalline substrate. When the substrate deposited materials are the same as the substrate, it is called homoepitaxial growth. Oppositely, it is defined as hetero epitaxial growth if substrate differs from the deposited materials. And epitaxial growth of graphite on semiconducting substrates (SiC) was known to us since 1975 [46]. Berger’s group successfully synthesized epitaxial graphene sheet [47] by using Si terminated face of single-crystal 6H-SiC by thermal desorption of Si. To summarize, although it is still an expensive approach, this is a promising method and possibly be scalable commercially.

## 3. CVD synthesis mechanism and the choice of carbon source

Chemical vapor deposition has been used to prepare inorganic materials in recent years. Besides, it also can be applied to produce graphene. CVD is the process of using gaseous matter to react on a solid surface and form solid deposits. The thermal decomposition and thermal synthesis of the deposition techniques are carried out at high temperature. As for the synthesis of graphene, three steps are generally required:

1. a volatile precursor,
2. transport of volatile matter to the precipitation area, and
3. chemical reaction on the substrate to produce a solid substance.

Two phenomenological growth mechanisms have been proposed based on an isotope labeling experiments [12] to understand the graphene growth. It is very easy to form a metal-carbide phase due to the strong interaction between carbon and metal [45, 48–50], following the precipitated growth mechanism. During the subsequent cooling process, the pyrolytic carbon atoms from the carbon sources firstly dissolve into the catalyst and then deposit at the metal surface to form graphene layers. On the other hand, the pyrolytic carbon atoms could only diffuse on the catalyst surface as the cases are shown with Cu and Au when the interaction between metal and carbon is fairly weak [22, 51], where both the nucleation and growth of graphene are dominated by the surface diffusion of the decomposed carbon atoms. Multi-layered graphene film formation normally follows the sedimentary growth mechanism and the number of graphene layers can be controlled by adjusting the dissolved C atoms in the metals or the thickness and composition of the substrate or by slowing down the cooling rate. Obviously, only single-layer graphene can be formed in the diffusive growth because the feedstock cannot get access to the graphene covered area of catalyst surface.

Meantime, SLG (shown in **Figure 5**) has been synthesized from solid and liquid hydrocarbon sources at different temperature (400–1000°C). Li et al. [52] adopted polymethyl-methacrylate (PMMA) and polystyrene as solid hydrocarbon and benzene as a liquid hydrocarbon source to grow graphene at temperatures lower than 1000°C on copper foil. Jang et al. [53] tried to remove remaining oxidizing impurities (oxygen-free APCVD, which is shown in **Figure 6**) before graphene deposition by using pumping and purging. This method leads to continuous SLG with full coverage of the substrate.

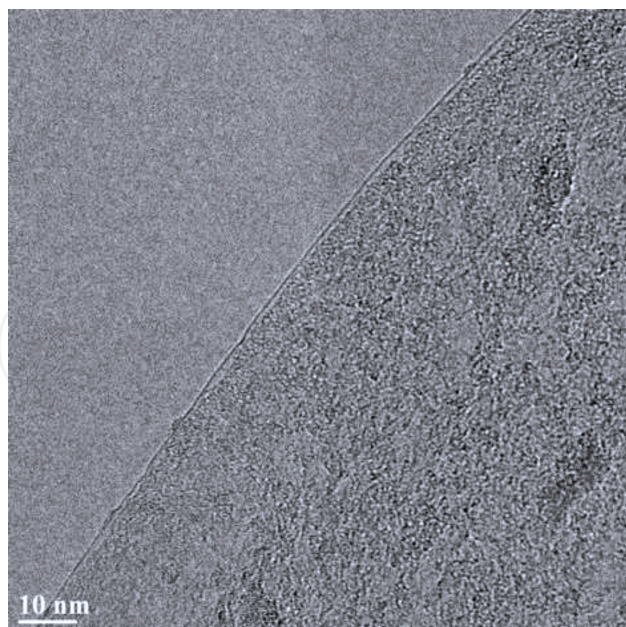

Figure 5. HRTEM image of single-layer graphene.

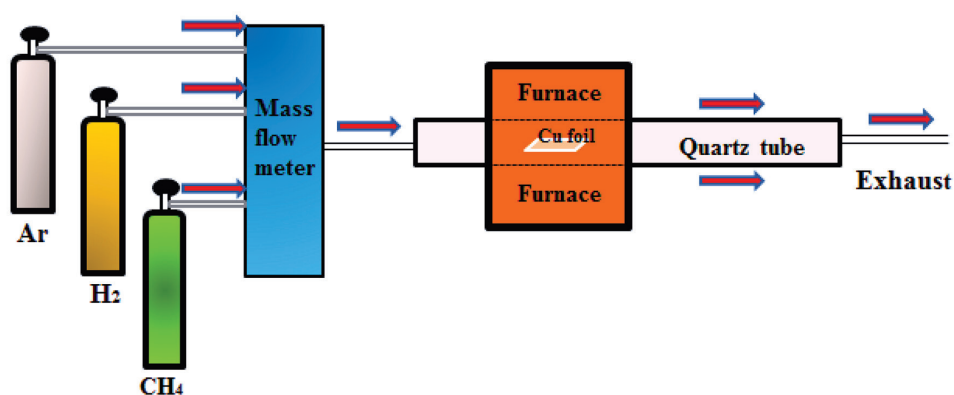

Figure 6. The schematic diagram of APCVD. Reproduced with permission of ref. [54].

As for the multilayer graphene (MLG), the high solubility of carbon in catalysts results in the dissolution of carbon into the bulk at high temperatures, leading to multilayer graphene (MLG) during the cooling process [33, 54–56].

## 4. Toward high-quality graphene: effect of experimental parameters

### 4.1. Choice of metal base material

Up to now, a large number of research have been done about the growth of graphene on the metal surfaces. CVD graphene growth is strongly dependent on the catalyst. Due to the different catalytic activity and atomic packing, the growth behavior of graphene on catalyst

surfaces, such as quality, continuity, and layer number, is different in each case. The catalyst plays an important role in the CVD process. We generally use Cu [5, 24, 25], Ni [6, 23], Pd [49], Ru [57], and Ir [58], as the metal base material for the preparation of graphene. As we know, different metal base materials have a different effect on the preparation of graphene, so the metal substrate is the key factor to determine the growth of graphene.

The mechanism of growth of graphene by chemical vapor deposition in copper and nickel substrate is different. Studies have shown that the growth of graphene on other metal substrates can also be basically classified into the growth mechanisms of copper and nickel substrates. On a metal substrate with high soluble carbon content, such as nickel, the carbon atoms produced by the carbon source cracking are infiltrated into the metal matrix at high temperature. When the temperature drops, the core is precipitated from the inside, then the graphene is formed. It is difficult to control the precipitation of carbon atoms during the cooling process because the solubility of carbon atoms in nickel increases with temperature, so it has a negative effect on the preparation of graphene. In the case of copper, the solubility of carbon atoms in copper is relatively low at high temperature; therefore, compared with other catalysts, Cu is currently the most widely used catalyst material [22, 45].

#### 4.2. Effect of hydrogen

Hydrogen is often involved in CVD graphene synthesis. Thus, hydrogen has a great impact on graphene reducing substrate surface contamination and defects in the annealing process [59], controlling the graphene domain shape [40, 60, 61], nucleation [62], and layer number [63]. And excess hydrogen could etch graphene to destroy the integrity of the lattice and make the quality of graphene worse [64]. It also affects the adsorption, stability, thickness [65–67], population of active species on the catalyst surface [68, 69] and the morphology [70–79] of the grown graphene. Luo et al. [72] determined the effect of hydrogen on the shape and orientation of graphene using DFT calculation (shown in **Figure 7**). High hydrogen concentration is required to synthesize large single-crystal monolayer graphene domains [40, 80]. Besides the low carbon concentration, etching by hydrogen is also an obstacle to short-time graphene growth [81].

#### 4.3. Effect of oxygen

It is known that oxygen plays an important role in each step of graphene synthesis, especially on copper. The effect of surface oxygen or pre-adsorbed oxygen on methane decomposition on Cu and that on the transition metal surface such as Ni and Pd is different [33].

The strong binding of active carbon species with catalyst surface is crucial for nucleation of graphene. The adsorption of active species on the catalyst surface becomes higher in the presence of oxygen. Hao et al. [82] found that the graphene edge with H-termination is better than a bare edge on Cu. In addition, oxygen plays a vital role in reducing the nucleation density not only in the bulk but also on the surface [83]. For example, oxygen could remove the unwanted carbon from Cu bulk, [84] which results in unintentional nucleation.



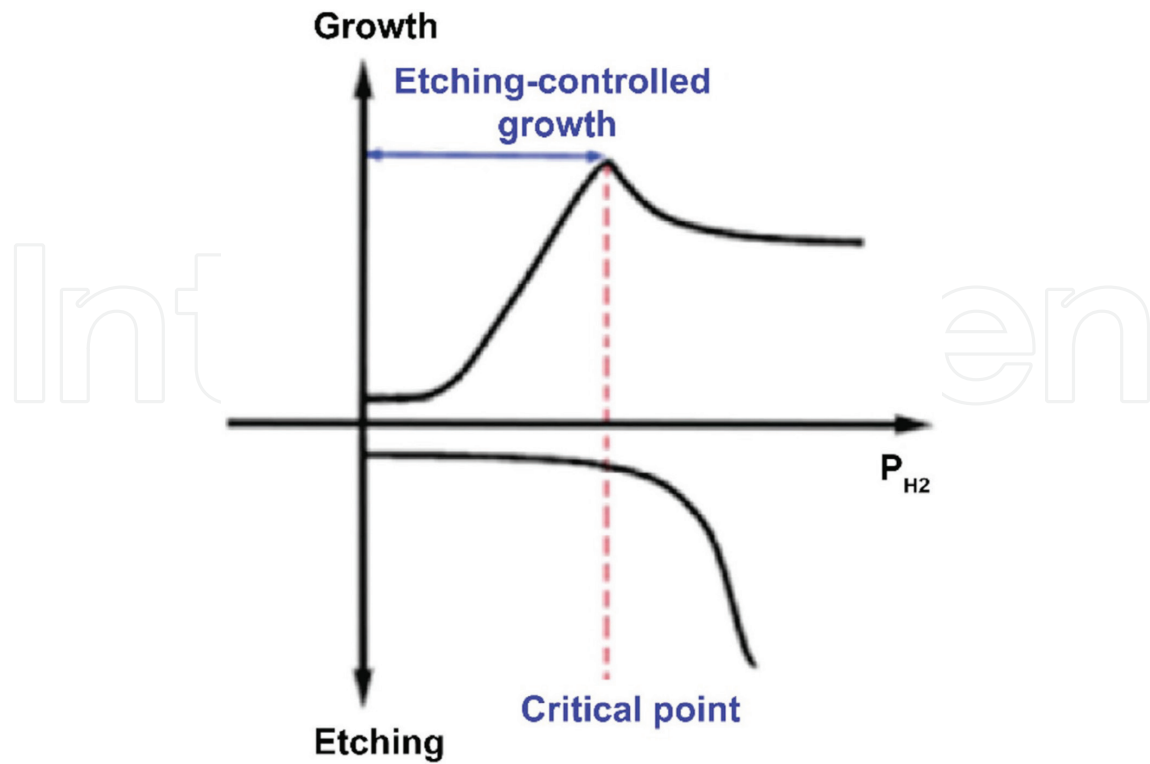

Figure 7. Schematic diagram of Etching-controlled growth mechanism of CVD. Reproduced with permission of ref. [71].

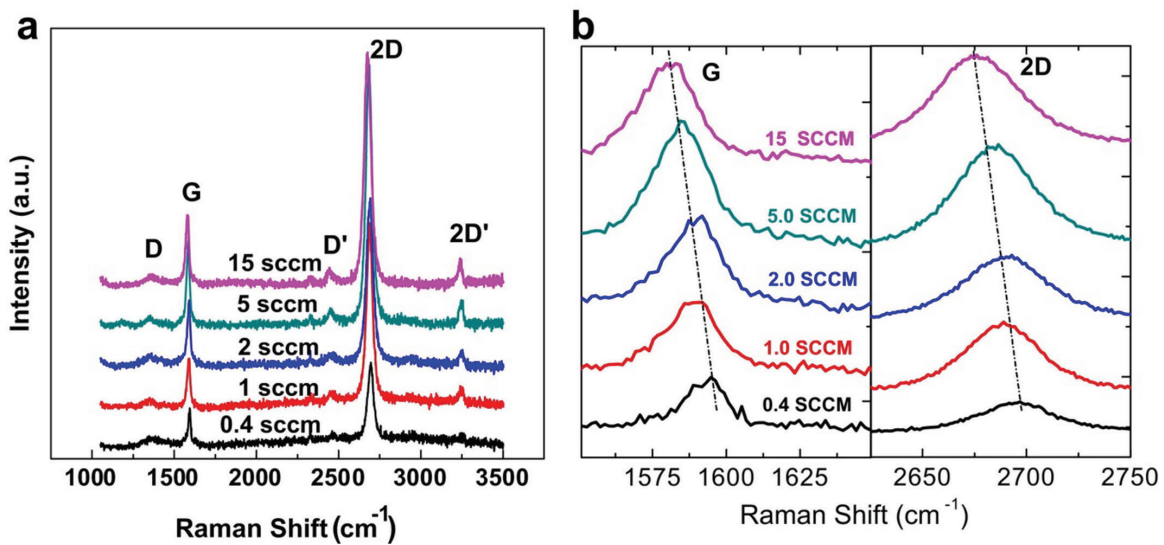

Figure 8. Raman spectra (a) and Gand 2D peaks (b) of the graphene films grown under various methane fluxes. Reproduced with permission of ref. [85].

#### 4.4. Effect of gas flow rate

The gas flow has been considered as a crucial factor during graphene synthesis. Optimizing the flow rate of  $\text{CH}_4$  and  $\text{H}_2$  could improve the quality of graphene. Therefore, Li et al. [22] described the CVD growth of graphene single crystals up to 0.5 mm in size in a quasi-static flow regime, using a copper enclosure in LPCVD. Meantime, Wang et al. [85] have used a  $\text{H}_2$

flow rate of 20 sccm adopt, at 80 Pa, and 1000°C, in their CVD method for graphene growth. The methane flow was varied systematically between 0.4 and 15 sccm. The graphene was characterized by Raman spectroscopy, and the results were shown in **Figure 8**. The study found that the ratio of  $I_G/I_{2D}$  peak ratio did not increase with the increase of methane flow and is less than 0.5. This indicates the formation of single layer graphene and no dependence on methane flow rate. They reported that the methane flow has a significant effect on the structure of graphene and determined the optimal flow rate of methane as 5 sccm. At 0 sccm,  $I_D/I_{2D}$  peak intensity ratio has a minimum value (0.0395) yielding graphene with the least defects.

## 5. Timeline of graphene production

Li et al. [22] synthesize large-area graphene grown by low-pressure chemical vapor deposition in copper-foil enclosures using methane as a precursor single crystal with dimensions of up to 0.5 mm on a side. While Hao et al. [82] enabled repeatable growth of centimeter-scale single-crystal graphene domains to attain 1 cm single-crystal graphene by controlling of surface oxygen. Correspondingly, Wu et al. [29] prepare a similar to 1.5-inch-large graphene monolayer in 2.5 h by locally feeding carbon precursors to a desired position of a substrate composed of an optimized Cu-Ni alloy. Besides, Nguyen et al. [86] have fabricated the  $6 \times 3 \text{ cm}^2$  graphene film without grain boundaries on polished copper(111) foil by Seamless stitching of graphene domains. However, a foundation of the modern technology by Xu et al. [34] that using single-crystal silicon improve the growth of high-quality single-crystal graphene with diameters up to 12 inches or larger.

In 2004, micron-sized graphene was obtained by exfoliation, which was not scalable. In 2006, the scientists obtained graphene by thermal deposition of SiC, which is an expensive process. In 2009, researchers first used Cu-CVD method to get graphene, and subsequently, this CVD method was extended to using other metals as substrates.

The graphene can be transferred using a wet method [32]. The process involves (1) coating a protective layer (e.g., PMMA) on one side, (2) etching graphene on the other side, (3) etching away the copper and then rinse with water, (4) transferring to target substrate, and (5) removal of protective film, by typically using solvent to dissolve it. With the development of graphene production, there are many ways to transfer graphene, including R2R ([87–89],

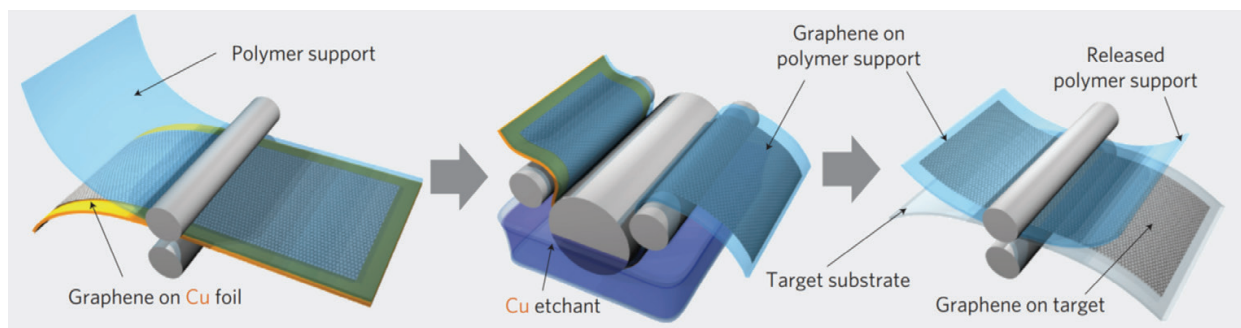

**Figure 9.** Schematic diagram of roll to roll production of graphene. Reproduced with permission of ref. [89].

shown in **Figure 9**) with thermal release tape, R2R with epoxy [90], and bubbling transfer [91]. These developments have led to much more controllable graphene synthesis [19, 33, 89].

## 6. Development trend and application prospect of CVD graphene

As for the graphene synthesis by CVD, it is beneficial to maximize the scale while maintaining the homogeneity of large-area films, as indicated by Bae et al. [89]. A creative approach to the CVD synthesis of ultra large-area graphene based on selective Joule heating was reported by Kobayashi et al. [92]. Since the first growth on copper foil a decade ago, inch-sized single-crystal graphene has been achieved. For most industrialized applications, large single-crystal graphene films are promising for top-down processing. In recent decades, the SCG island size has increased more than four orders of magnitude, from micrometers to inches. Xu et al. [34] have made large-area graphene film (5 cm × 50 cm) within 20 min, which is almost 99% ultra-highly oriented grains and is, to the best of our knowledge, the largest graphene area synthesized and demonstrated by far. The growth steps are described as follows: (1) manufacturing substrate with meter-sized single-crystal Cu(111) foil; (2) epitaxial growth of graphene grains on the Cu(111) surface; (3) seamless merging of graphene domains into a film with high-single crystallinity; and (4) the growth of graphene film in an ultrafast fashion.

At present, the process of preparing graphene by chemical vapor deposition has matured to the point of large-scale production and has been applied to electric ink, lithium battery additives, coatings and composite materials additives, touch screen, and other low-end applications [93].

For lithium battery applications, graphene as a conductive additive can also solve the contradiction between the high-voltage real ratio and the battery performance of the cathode materials such as lithium cobalt oxide [94]. Graphene has extremely high thermal conductivity, high thermal radiation coefficient, and high specific surface area, so that a surface coating of graphene as auxiliary heat dissipation has great potential for application [95]. Graphene can be used as the main filling material for new conductive ink and plastics [96], and it can also be mixed with nanometer silver powder into a new type of conductive adhesive or ink, and the resistivity and adhesion properties of conductive ink can be adjusted by changing the filling ratio of graphene. The two-dimensional structure of graphene allows for conductive thermal channels in graphene-based anticorrosive paint coating and forms a tight labyrinth of physical barriers to prevent corrosion related exposure. Graphene could be applied to improve performance on graphene capacitive screen [96]. Similarly, carbon nanowalls [97] described as a graphite nano-structure with edge structure and arranged perpendicularly to the matrix on a sheet of graphite have been synthesized by the CVD and is widely used in electrochemical devices, catalyst carriers, etc.

## 7. Summary and outlook

With excellent prosperities of graphene, there are tremendous amount of research on digging out its exceptional prospect in future applications. But challenges including the growth rate of graphene growth, defects, stacking order, and transfer still remain. Nevertheless, more and

more scientific communities are making efforts to achieve the industrialization of graphene. Undoubtedly, the graphene industry is growing at a fast rate. In the next 5–10 years, the technology for graphene-based conductive additives, anticorrosive coatings, touch screen would be mature, along with the industrialization of high-end applications such as super capacitors, sensors, and electronic chips. But mono-crystalline graphene films are extremely difficult to prepare. At present, they can only be made in millimeter size, and they are still quite far away from the practical crystal size, which is difficult to break in the short term. We need to achieve a balance between the advantages and disadvantages of graphene in order to create a fast and healthy way for the sustainable development of graphene. Chemical vapor deposition (CVD) is the most promising preparation technique. The preparation by chemical vapor deposition has become a major method for preparing semiconductor, thin film materials, and industrial production of high-quality graphene materials in large quantity. Meantime, for the CVD method, considerable efforts have been exerted to get low cost on any arbitrary substrate, but it is still a long way to make it.

## Author details

Chen Wang<sup>1</sup>, Kizhanipuram Vinodgopal<sup>2\*</sup> and Gui-Ping Dai<sup>1,2,3\*</sup>

\*Address all correspondence to: nanodai@gmail.com

1 School of Resources Environmental and Chemical Engineering, Nanchang University, Nanchang, Jiangxi, China

2 Department of Chemistry and Biochemistry, North Carolina Central University, Durham, NC, USA

3 Institute for Advanced Study, Nanchang University, Nanchang, Jiangxi, China

## References

- [1] Novoselov KS, Geim AK, Morozov SV, Jiang D, Katsnelson MI, Grigorieva IV, et al. Two-dimensional gas of massless Dirac fermions in graphene. *Nature*. 2005;438:197-200
- [2] Liu Y, Xie B, Zhang Z, et al. Mechanical properties of graphene papers. *Journal of the Mechanics & Physics of Solids*. 2012;60(4):591-605
- [3] Stöberl U, Wurstbauer U, Wegscheider W, et al. Morphology and flexibility of graphene and few-layer graphene on various substrates. *Applied Physics Letters*. 2008;93(5):19912
- [4] Mišković-Stanković V, Jevremović I, Jung I, et al. Electrochemical study of corrosion behavior of graphene coatings on copper and aluminum in a chloride solution. *Carbon*. 2014;75(10):335-344
- [5] Raman RKS, Banerjee PC, Lobo DE, et al. Protecting copper from electrochemical degradation by graphene coating. *Carbon*. 2012;50(11):4040-4045

- [6] Nayak PK, Hsu CJ, Wang SC, et al. Graphene coated Ni films: A protective coating. *Thin Solid Films*. 2013;**529**(2):312-316
- [7] Ma Y, Kim D, Jang H, et al. Characterization of low temperature graphene synthesis in inductively coupled plasma chemical vapor deposition process with optical emission spectroscopy. *Journal of Nanoscience & Nanotechnology*. 2014;**14**(12):9065
- [8] Ning G, Xu C, Cao Y, et al. Chemical vapor deposition derived flexible graphene paper and its application as high performance anodes for lithium rechargeable batteries. *Journal of Materials Chemistry A*. 2012;**1**(2):408-414
- [9] Chen Z, Ren W, Gao L, et al. Three-dimensional flexible and conductive interconnected graphene networks grown by chemical vapour deposition. *Nature Materials*. 2011;**10**(6):424
- [10] Yuan GD, Zhang WJ, Yang Y, et al. Graphene sheets via microwave chemical vapor deposition. *Chemical Physics Letters*. 2009;**467**(4):361-364
- [11] Zheng Q, Kim JK. Synthesis, structure, and properties of graphene and graphene oxide. *Journal of Experimental Medicine*. 2015;**23**(2):29-94
- [12] Novoselov KS, Geim AK, Morozov SV, Jiang D, Zhang Y, Dubonos SV, et al. Electric field effect in atomically thin carbon films. *Science*. 2004;**306**:666-669
- [13] Geim AK. Graphene: Status and prospects. *Science*. 2009;**324**:1530-1534
- [14] Schwierz F. Graphene transistors. *Nature Nanotechnology*. 2010;**5**:487-496
- [15] Hernandez Y, Nicolosi V, Lotya M, et al. High-yield production of graphene by liquid-phase exfoliation of graphite. *Nature Nanotechnology*. 2008;**3**(9):563-568
- [16] Ciesielski A, Samori P. Graphene via sonication assisted liquid-phase exfoliation. *Chemical Society Reviews*. 2014;**43**:381-398
- [17] Dikin DA, Stankovich S, Zimney EJ, Piner RD, Dommett GHB, Evmenenko G, et al. Preparation and characterization of graphene oxide paper. *Nature*. 2007;**448**:457-460
- [18] Eda G, Fanchini G, Chhowalla M. Large-area ultrathin films of reduced graphene oxide as a transparent and flexible electronic material. *Nature Nanotechnology*. 2008;**3**:270-274
- [19] Li M, Liu D, Wei D, et al. Controllable synthesis of graphene by plasma-enhanced chemical vapor deposition and its related applications. *Advanced Science*. 2016;**3**(11):1600003
- [20] Qi Y, Eskelsen JR, Mazur U, et al. Fabrication of graphene with CuO islands by chemical vapor deposition. *Langmuir the ACS Journal of Surfaces & Colloids*. 2012;**28**(7):3489-3493
- [21] Sun J, Lindvall N, Cole MT, et al. Low partial pressure chemical vapor deposition of graphene on copper. *IEEE Transactions on Nanotechnology*. 2012;**11**(2):255-260
- [22] Li X, Cai W, An J, et al. Large-area synthesis of high-quality and uniform graphene films on copper foils. *Science*. 2009;**324**(5932):1312

- [23] Kwon H-J et al. Synthesis of flake-like graphene from nickel-coated polyacrylonitrile polymer. *Nanoscale Research Letters*. 2014;**9**(1):618
- [24] Kim M-S et al. Effect of copper surface pre-treatment on the properties of CVD grown graphene. *AIP Advances*. 2014;**4**(12):127107
- [25] Gnanaprakasa TJ et al. The role of copper pretreatment on the morphology of graphene grown by chemical vapor deposition. *Microelectronic Engineering*. 2015;**131**:1-7
- [26] Vinogradov NA et al. Formation and structure of graphene waves on Fe(110). *Physical Review Letters*. 2012;**109**:026101
- [27] Sutter P, Sadowski JT, Sutter E. Graphene on Pt(111): Growth and substrate interaction. *Physical Review*. 2009;**B80**:245411
- [28] Feng X, Wu J, Bell AT, Salmeron M. An atomicscale view of the nucleation and growth of graphene islands on Pt surfaces. *Journal of Physical Chemistry C*. 2015;**119**:7124-7129
- [29] Wu T et al. Fast growth of inch-sized single-crystalline graphene from a controlled single nucleus on Cu–Ni alloys. *Nature Materials*. 2015;**15**(1):43
- [30] Liu X, Fu L, Liu N, Gao T, Zhang Y, Liao L. Segregation growth of graphene on Cu–Ni alloy for precise layer control. *Journal of Physical Chemistry C*. 2011;**115**:11976-11982
- [31] Robertson SD. Graphite formation from low temperature pyrolysis of methane over some transition metal surfaces. *Nature*. 1969;**221**(5185):1044-1046
- [32] Jiao L, Fan B, Xian X, et al. Creation of nanostructures with poly(methyl methacrylate)-mediated nanotransfer printing. *Journal of the American Chemical Society*. 2008;**130**(38):12612-12613
- [33] Addou R et al. Monolayer graphene growth on Ni(111) by low temperature chemical vapor deposition. *Applied Physics Letters*.
- [34] Xu X, Zhang Z, Dong J, et al. Ultrafast epitaxial growth of metre-sized single-crystal graphene. *Science Bulletin*. 2017;**62**(15):1074-1080
- [35] Wang H, Wang G, Bao P, et al. Controllable synthesis of submillimeter single-crystal monolayer graphene domains on copper foils by suppressing nucleation. *Journal of the American Chemical Society*. 2012;**134**(8):3627
- [36] Fan L, Li Z, Li X, et al. Controllable growth of shaped graphene domains by atmospheric pressure chemical vapour deposition. *Nanoscale*. 2011;**3**(12):4946-4950
- [37] Liu L, Zhou H, Cheng R, et al. High-yield chemical vapor deposition growth of high-quality large-area AB-stacked bilayer graphene. *Acs Nano*. 2012;**6**(9):8241-8249
- [38] Yu Q, Jauregui LA, Wu W, et al. Control and characterization of individual grains and grain boundaries in graphene grown by chemical vapour deposition. *Nature Materials*. 2010;**10**(6):443-449

- [39] Luo B, Chen B, Meng L, Geng D, et al. Layer-stacking growth and electrical transport of hierarchical graphene architectures. *Advanced Materials*. 2014;**26**:3218-3224
- [40] Wu B, Geng D, Xu Z et al. Self-organized graphene crystal patterns. *NPG Asia Materials*. 2013;**S**:e36
- [41] Lotya M, Hernandez Y, King PJ, et al. Liquid phase production of graphene by exfoliation of graphite in surfactant/water solutions. *Journal of the American Chemical Society*. 2009;**131**(10):3611-3620
- [42] Hummers WS, Offeman RE. Preparation of graphitic oxide. *Journal of the American Chemical Society*. 1958;**80**(6):1339
- [43] Song HS, Li SL, Miyazaki H, Sato S, Hayashi K, Yamada A, et al. Origin of the relatively low transport mobility of graphene grown through chemical vapor deposition. *Scientific Reports*. UK. 2012;**2**:337
- [44] Muñoz R, Gómez-Aleixandre C. Review of CVD synthesis of graphene. *Chemical Vapor Deposition*. 2013;**19**(10-11-12):297-322
- [45] Li X, Cai W, Colombo L, Ruoff RS. Evolution of graphene growth on Ni and Cu by carbon isotope labeling. *Nano Letters*. 2009;**9**:4268-4272
- [46] Van Bommel AJ, Crombeen JE, Van Tooren A. LEED and Auger electron observations of the SiC(0001) surface. *Surface Science*. 1975;**48**(2):463-472
- [47] Berger C et al. Ultrathin epitaxial graphite: 2D electron gas properties and a route toward graphene-based nanoelectronics. *The Journal of Physical Chemistry B*. 2004;**108**(52):19912-19916
- [48] Zhang X, Li H, Ding F. Self-assembly of carbon atomson transition metal surfaces—Chemical vapor deposition growth mechanism of graphene. *Advanced Materials*. 2014;**26**:5488-5495
- [49] Kwon S-Y, Ciobanu CV, Petrova V, Shenoy VB, Bareno J, Gambin V, et al. Growth of semiconducting graphene on palladium. *Nano Letters*. 2009;**9**:3985-3390
- [50] Losurdo M, Giangregorio MM, Capezzuto P, Bruno G. Graphene CVD growth on copper and nickel: Role of hydrogen in kinetics and structure. *Physical Chemistry Chemical Physics*. 2011;**13**:20836-20843
- [51] Nie S, Bartelt NC, Wofford JM, Dubon OD, McCarty KF, Thurmer K. Scanning tunneling microscopy study of graphene on Au(111): Growth mechanisms and substrate interactions. *Physical Review B*. 2012;**85**:205406
- [52] Li Z et al. Low-temperature growth of graphene by chemical vapor deposition using solid and liquid carbon sources. *ACS Nano*. 2011;**5**(4):3385-3390
- [53] Jang J et al. Low-temperature-growth continuous graphene films from benzene by chemical vapor deposition at ambient pressure. *Scientific Reports*. 2015;**5**:17955

- [54] Jiang B-B, Pan M, Wang C, Wu MH, Vinodgopal K, Dai G-P. Controllable synthesis of circular graphene domains by atmosphere pressure chemical vapor deposition. *Journal of Physical Chemistry C*. 2018;**122**:13572-13578
- [55] Weatherup RS, Dlubak B, Hofmann S. Kinetic control of catalytic CVD for high-quality graphene at low temperatures. *ACS Nano*. 2012;**6**(11):9996-10003
- [56] Yokoyama H, Numakura H, Koiwa M. The solubility and diffusion of carbon in palladium. *Acta Materials*. 1998;**46**(8):2823-2830
- [57] Sutter PW, Flege JI, Sutter EA. Epitaxial graphene on ruthenium. *Nature Materials*. 2008;**7**(5):406-411
- [58] Shu N, Bartelt NC, Starodub E, Walter A, Bostwick A, Rotenberg E. Growth from below: Graphene multilayers on Ir(111). United States. 2011. DOI: 10.1021/nn103582g
- [59] Loginova E, Bartelt NC, Feibelman PJ, McCarty KF. Evidence for graphene growth by C cluster attachment. *New Journal of Physics*. 2009;**11**:063046 (093026)
- [60] Yan Z, Lin J, Peng ZW, Sun ZZ, Zhu Y, Li L, Xiang CS, Samuel EL, Kittrell C, Tour JM. *ACS Nano*. 2012;**10**(6):126-132
- [61] Zhang Y, Li Z, Kim P, Zhang LY, Zhou CW. *ACS Nano*. 2012;**7**(6):871-877
- [62] Meca E, Lowengrub J, Kim H, Mattevi C, Shenoy VB. Epitaxial graphene growth and shape dynamics on copper: Phase-field modeling and experiments. *Nano Letters*. 2013;**11**(13):5692-5697
- [63] Jacobberger RM, Arnold MS. Graphene growth dynamics on epitaxial copper thin films. *Chemistry of Materials*. 2013;**6**(25):3040-3047
- [64] Park HJ et al. Growth and properties of few-layer graphene prepared by chemical vapor deposition. *Carbon*. 2010;**48**(4):1088
- [65] Zhang X, Wang L, Xin JH, et al. The role of hydrogen in graphene chemical vapor deposition (CVD) growth on copper surface. *Journal of the American Chemical Society*. 2014;**136**(8):3040-3047
- [66] Weiss SJ, Young J, Lobuglio AF, et al. Role of hydrogen peroxide in neutrophil-mediated destruction of cultured endothelial cells. *Journal of Clinical Investigation*. 1981;**68**(3):714-721
- [67] Liu Q, Gong Y, Wilt JS, et al. Synchronous growth of AB-stacked bilayer graphene on Cu by simply controlling hydrogen pressure in CVD process. *Carbon*. 2015;**93**:199-206
- [68] Shu H, Tao XM, Ding F. What are the active carbon species during graphene chemical vapor deposition growth? *Nanoscale*. 2015;**7**(5):1627-1634
- [69] Li K, He C, Jiao M, et al. A first-principles study on the role of hydrogen in early stage of graphene growth during the CH<sub>4</sub> dissociation on Cu(111) and Ni(111) surfaces. *Carbon*. 2014;**74**(10):255-265



- [70] Gan CK, Srolovitz DJ. First-principles study of graphene edge properties and flake shapes. 2010;**81**(12):760-762
- [71] Geng D, Wu B, Guo Y, et al. From the cover: Uniform hexagonal graphene flakes and films grown on liquid copper surface. *Proceedings of the National Academy of Sciences of the United States of America*. 2012;**109**(21):7992-7996
- [72] Luo B, Gao E, Geng D, et al. Etching-controlled growth of graphene by chemical vapor deposition. *Chemistry of Materials*. 2017;**29**(3):1022-1027
- [73] Zhang H, Zhang Y, Zhang Y, et al. Realizing controllable graphene nucleation by regulating the competition of hydrogen and oxygen during chemical vapor deposition heating. *Physical Chemistry Chemical Physics*. 2016;**18**(34):23638-23642
- [74] Ma T, Ren W, Liu Z, et al. Repeated growth-etching-regrowth for large-area defect-free single-crystal graphene by chemical vapor deposition. *ACS Nano*. 2014;**8**(12):12806-12813
- [75] Da HJ, Kang C, Kim M, et al. Effects of hydrogen partial pressure in the annealing process on graphene growth. *Journal of Physical Chemistry C*. 2015;**118**(7):3574-3580
- [76] Hu B, Jin Y, Guan D, et al. H<sub>2</sub>-dependent carbon dissolution and diffusion-out in graphene chemical vapor deposition growth. *Journal of Physical Chemistry C*. 2015;**119**(42):585080264
- [77] Jin Y, Hu B, Wei Z, et al. Roles of H<sub>2</sub> in annealing and growth times of graphene CVD synthesis over copper foil. *Journal of Materials Chemistry A*. 2014;**2**(38):16208-16216
- [78] Wu B, Geng D, Guo Y, et al. Equiangular hexagon-shape-controlled synthesis of graphene on copper surface. *Advanced Materials*. 2011;**23**(31):3522-3525
- [79] Zhao P, Cheng Y, Zhao D, et al. The role of hydrogen in oxygen-assisted chemical vapor deposition growth of millimeter-sized graphene single crystals. *Nanoscale*. 2016;**8**(14):7646
- [80] Shin YC, Kong J. *Carbon*. 2013;**59**:439
- [81] Zhang XY, Wang L, Xin J, Yakobson BI, Ding F. *Journal of American Chemical Society*. 2014;**136**
- [82] Hao Y, Ruoff RS. The role of surface oxygen in the growth of large single-crystal graphene on copper. *Science*. 2013;**342**(6159):720-723
- [83] Liang T, Luan C, Chen H, et al. Exploring oxygen in graphene chemical vapor deposition synthesis. *Nanoscale*. 2017;**9**(11):3719
- [84] Zhang Y, Li Z, Kim P, Zhang LY, Zhou CW. *ACS Nano*. 2012;**7**:6
- [85] Wang ZG, Chen YF, Li PJ, et al. Effects of methane flux on structural and transport properties of CVD-grown graphene films. *Vacuum*. 2012;**86**(7):895
- [86] Nguyen VL, Shin BG, Duong DL, et al. Seamless stitching of graphene domains on polished copper (111) foil. *Advanced Materials*. 2015;**27**(8):1376-1382

- [87] Yamada T, Ishihara M, Hasegawa M. Large area coating of graphene at low temperature using a roll-to-roll microwave plasma chemical vapor deposition. *Thin Solid Films*. 2013;**532**(532):89-93
- [88] Juang ZY, Wu CY, Lu AY, et al. Graphene synthesis by chemical vapor deposition and transfer by a roll-to-roll process. *Carbon*. 2010;**48**(11):3169-3174
- [89] Bae S, Kim H, Lee Y, Xu X, Park J-S, Zheng Y, et al. Roll-to-roll production of 30-inch graphene films for transparent electrodes. *Nature Nanotechnology*. 2010;**5**:574
- [90] Kraus J, Böbel M, Günther S. Suppressing graphene nucleation during CVD on polycrystalline Cu bycontrolling the carbon content of the support foils. *Carbon*. 2016;**96**:153-165
- [91] Zhang H, Zhang Y, Wang B, Chen Z, Sui Y, Zhang Y, et al. *Journal of Electronic Materials*. 2015;**44**:79-86
- [92] Kobayashi T, Bando M, Kimura N, Shimizu K, Kadono K, Umezu N, et al. Production of a 100-m-long high-quality graphene transparent conductive film by roll-to-roll chemical vapor deposition and transfer process. *Applied Physics Letters*. 2013;**102**:023112
- [93] Choi W, Lahiri I, Seelaboyina R, Kang YS. Synthesis of graphene and its applications: A review. *Critical Reviews in Solid State and Materials Sciences*. 2010;**35**:52-71
- [94] Li X, Sun X, et al. A simple one-pot strategy for synthesizing ultrafine SnS<sub>2</sub> nanoparticle/graphene composites as anodes for lithium/sodium-ion batteries. *ChemSuschem*. 2018;**11**(9):1390-1575
- [95] Molina-Valdovinos S et al. Low-dimensional thermoelectricity in graphene: The case of gated graphene superlattices. *Physica E: Low-dimensional Systems and Nanostructures*. 2018;**101**:188-196
- [96] Arapov K et al. Conductive screen printing inks by gelation of graphene dispersions. *Advanced Functional Materials*. 2016;**26**(4):586-593
- [97] Wang JJ, Zhu MY, Outlaw RA, Zhao X, Manos DM. Free-standing sub-nanometer graphite sheets. *Applied Physics Letters*. 2004;**85**:1265

