

# We are IntechOpen, the world's leading publisher of Open Access books Built by scientists, for scientists

4,800

Open access books available

122,000

International authors and editors

135M

Downloads

Our authors are among the

154

Countries delivered to

TOP 1%

most cited scientists

12.2%

Contributors from top 500 universities



WEB OF SCIENCE™

Selection of our books indexed in the Book Citation Index  
in Web of Science™ Core Collection (BKCI)

Interested in publishing with us?  
Contact [book.department@intechopen.com](mailto:book.department@intechopen.com)

Numbers displayed above are based on latest data collected.  
For more information visit [www.intechopen.com](http://www.intechopen.com)



---

# Optical Amplifiers for Next-Generation Telecommunication

---

Toto Saktioto and Roby Ikhsan

Additional information is available at the end of the chapter

<http://dx.doi.org/10.5772/intechopen.79941>

---

## Abstract

The continuing growth of telecommunication networks is currently dominated by fiber optics (or optical networking). Optical fiber has become the guided medium of choice in telecommunications, and associated optoelectronic technologies have become important such as optical fiber itself and optical amplifiers. Optical amplifiers can operate in the long distance using fiber optic carrying data and information in communication links. Some mechanisms are able to amplify electromagnetic signal corresponding to kinds of optical amplifiers. In doped fiber amplifiers and bulk laser sources, a stimulated emission in the amplifier's gain media causes amplification of incoming electromagnetic spectrum. In semiconductor optical amplifier (SOA), electron-hole interaction will occur. For Raman amplifier (RA), its scattering of incoming source with phonons in the lattice of the gain media will produce photons coherent with the incoming photons. Using the simulation, both amplifiers are simulated and compared by in-line amplifiers to allow and keep a better signal from material and geometry disturbance.

**Keywords:** fiber optic, SOA, FRA, optical amplifier, BER, Q-factor

---

## 1. Introduction

Optical amplifiers are optical active components as a circuit enabling technology for optical communication networks. Together with telecommunication system and technology allowing the transmission of channels over the fiber, optical amplifiers have made it possible to transmit many data over distances from 100 km and up to transoceanic distances, providing the data capacity required for current and future communication networks. Optical amplifiers have important role in optical telecommunication and data information. They can be used as repeater circuit in long-distance optical fiber component and cables carrying the world's telecommunication links.

---

The main aim of this topic is to provide a description of optical amplifiers having a device that amplifies an optical signal, without the need to convert it to an electrical signal or source. This can be formed in visible or invisible electromagnetic spectral source such as light or a laser without an optical resonator, or one in which feedback from the cavity is suppressed. A fundamental optical communication link comprises a transmitter and receiver, with an optical fiber cable and connector which connect them. Even though signals propagating in fiber suffer far less energy in terms of absorption and other damped along the media, such conductor media still have a limit of about 140 km on the distance the signal wave can propagate before producing the disturbance like noise. Before going to the market, the optical amplifiers are necessary to regenerate the optical signals every 80–140 km [1] electronically in order to fulfill the transmission value over long distances. This process describes the receiving of the information signal, organizing and multiplying the amplification optically and electronically, and then retransmitting it over the next medium and segment of the circuit and link. It can be feasible if a single low optical signal is transmitted; it will travel fast and be unfeasible, transmitting in tens of high-capacity order of wavelength-division multiplexing (WDM) channel devices. This results in high-cost, power-hungry, and bulky regenerator port. Furthermore, the regeneration hardware and software depend upon bit-rate, protocol, channel numbers, and modulation which are set to each channel. Any upgrade to the link therefore will automatically require upgrades to the regenerator stations. On the other hand, an ideal amplifier is modeled and designed to amplify any input optical signal directly, no need to transform the signal first to an electronic one.

There are different kinds of processes that can be applied to amplify electromagnetic signals corresponding to the major formation of amplifier optics. For doped fiber ones and bulk lasers, SOA, electron-hole interaction process and recombination will occur. For RA, its scattering of incoming electromagnetic signal with phonons in the lattice of the gain media will produce photons coherent with the incoming photons. Parameters of amplifiers use parametric amplification. **Figure 1** shows amplifier's gain medium causes amplification of incoming light. In semiconductor optical, the block diagram of an amplified signal was optically totally different from an electronic signal regeneration regime, in which channels are usually split, detected, amplified, cleaned electronically, retransmitted, and then recombined. This is a benefit of optical amplifier that can be used to all channels optically and transparently amplified together.

Optical transmission media greatly affect the performance of a communication system. Fiber optic is one of the transmission media that is capable of transmitting information with a large capacity, is high speed, and has low attenuation. Although optical fiber provides many advantages, there are also disadvantages that can disrupt the performance of the fiber optics,

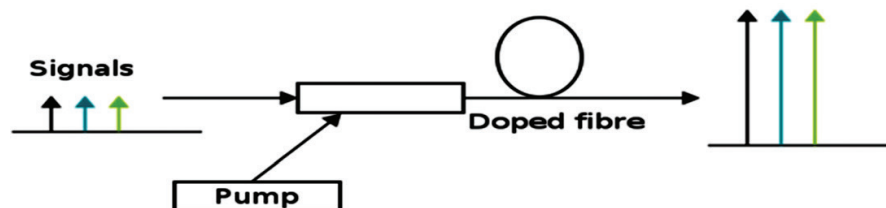
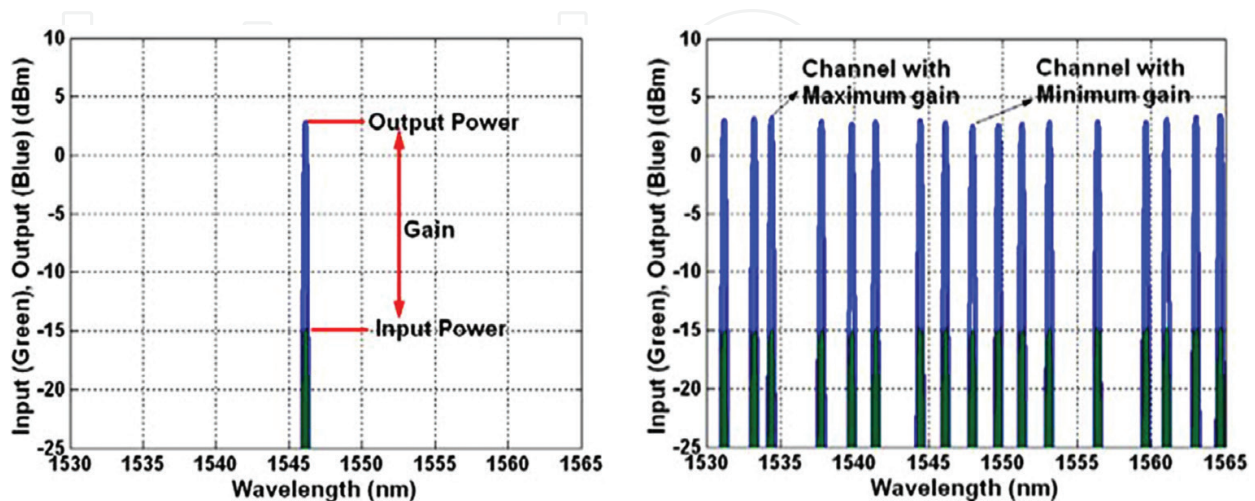

**Figure 1.** An optical amplifier, all channels are optically, transparently amplified together.

the effects that can limit the delivery and speed of data transmission. This effect is divided into linear effects and nonlinear effects. Linear effects include attenuation and dispersion, a distortion in the beam of light passing through the optical fiber core caused by different modes, wavelengths, and velocities, while nonlinear effects arise due to Kerr effect in the form of self-phase modulation (SPM), cross-phase modulation (XPM), and four-wave mixing (FWM) and as the result of inelastic scattering including stimulated Raman scattering (SRS) and stimulated Brillouin scattering (SBS) [2]. These linear and nonlinear effects can damage information signals such as widespread light pulses, reduced bandwidth shortened, transmission distance, and limited bit-rate. All this is a communication disorder.

## 2. Optical amplifier properties

Optical amplifiers have several properties. First, it has a gain that the input optical signal is amplified and that is detected from the output port one. It is typically measured in the range of 5–35 dB. For instance if the gain is 10 dB, meaning the input signal is amplified by a factor of 10 subject to logarithm factor. It is also characterized by the supported input and output powers. Especially, the main specification of the amplifier is the maximum output power, which can be contributed and subjected to as saturated output power. There are two kinds of optical amplifiers. They are single and multichannel. The former is designed to amplify only one channel located within a specified band, such as the C-band (1528–1564 nm). This channel can usually deal with over a wide range of gains and require relatively low output power. In the latter channel, WDM amplifiers are designed to work out if any number of channels are input to the amplifier. The gain flatness is the properties of WDM amplifiers, the variation of the gain for different channels, as depicted in **Figure 2** (right side). When the gain is not flat, different WDM channels will have different gains, which can accumulate along a chain of amplifiers leading to a large mismatch between channels. To maintain flat gain, most low-end WDM amplifiers only support a single gain, or a relatively narrow gain range, supporting



**Figure 2.** Example input (green) and output (blue) spectrums of a single channel amplifier (left) and a WDM multichannel amplifier (right) [1].

both flat gain and a large gain range, providing a large dynamic input power range, to support different input conditions where any number of channels 1 up to 80 may be available. The maximum quantity of WDM channel amplifiers requires a relatively high saturated output power, particularly in the range of 17–23 dBm. Secondly, optical amplifiers have noise during the amplification process. The noise is detected by its noise figure (NF), where it has the ratio between the signal-to-noise ratio (SNR) at the output port and an ideal SNR at the input port. Due to one-to-one connection between the NF and the optical link, the value of NF should be maintained as low as possible. The value of NF depends upon the technology applied and used for it, where higher gain usually has lower NF. Thirdly, amplifiers detection to dynamical conversion at input port source describe that the gain ideally should not convert at all if the source of input power converts it. But, it is impossible if the amplifier deals with at or almost the peak output power source. This has an important reason if the amplifier can respond step by step; hence its gain is determined only by the average input power source, and it does not influence and change fast (for instance, due to data modulation). Amplifiers having responses too quick can result too noisy. It cannot overcome the multiple channels well.

Optical amplifiers may be used within an optical network as boosters, line amplifiers, or pre-amplifiers, as shown in **Figure 3**, with slightly different specifications.

### 2.1. Laser amplifier

Generally, laser active gain medium can be pumped to produce gain for spectral wave of a laser made with the same material as its gain medium to result in very high-power laser systems, such as regenerative and chirped-pulse amplifiers which are applied to amplify ultrashort pulses. In addition, solid-state amplifiers are examples of using a wide range of doped solid-state materials (Yb:YAG, Ti:Sa, Nd:YAG) and other kind of sizes and geometries for instance a disk, a slab, and a rod. The variety of materials allows the amplification of different wavelengths, while the shape of the medium can distinguish between what is more suitable for energy [3]. Doped fiber amplifiers (DFAs) use a doped fiber optics having gain resonator to multiply the signals corresponding to the source of fiber lasers. The signals will be multiplied and amplified, and a pump laser is multiplexed to the resonator. The signal will interact through the doping ions (erbium-doped fiber amplifier, EDFA), where the core of a silica fiber is doped with trivalent erbium ions and can be efficiently pumped with a laser at a wavelength of infrared region.

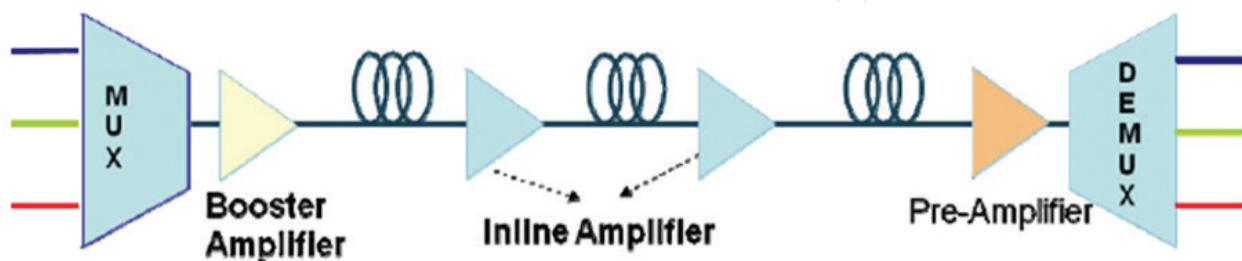

**Figure 3.** A simple WDM optical network, where a number of transmitted channels are combined using a WDM multiplexer (MUX), amplified using a booster amplifier before being launched into the transmission fiber, re-amplified every 80–120 km using in-line amplifiers, and finally preamplified before being demultiplexed and received [1].

Amplification is obtained by processing of emission which is stimulated and producing photons in the dopant ions in the optical fiber which is doped. The source excites ions into a greater energy and will decay via spectral of stimulated emission which has a photon at the signal wavelength back to a lower energy level. The spontaneous emission (decay) can occur to the excited ions or even via non-radiative mechanism involving interactions with phonons of the glass matrix. The last two decay processes compete with stimulated emission, which decreases the efficiency of amplitude or intensity of electromagnetic amplification. The *amplification window* represents the range of wavelengths for which the amplifier results in an applicable gain. This is determined by the measurement of the glass structure of fiber optic or by spectroscopic properties of dopant ions and the wavelength and power of the electromagnetic source. Even though the transitions of electronic or an isolated ion are very well known, the wide band of the energy levels happens if the ions are interacted to the fiber optic. Therefore, the amplification window is also broadened. The broadening will be homogeneous (all ions exhibit the same broadened spectrum) and also it will be inhomogeneous (different ions in different glass locations exhibit different spectra). A relatively high-powered beam of electromagnetic source such as light is combined with the input signal by using a wavelength selective coupler (WSC). This input one and the excitation beam have to be of different wavelengths significantly. The mixed electromagnetics or polychromatics or laser will be guided into a resonator of fiber with erbium ions subject to the fiber core. The high-powered electromagnetics of light beam excites the dopants ions to the higher-energy state. If photons of signal at a particular resonant wavelength from the beam source meet the excited erbium atoms, the erbium atoms will surrender several of their energy to the signal and go back to their lower-energy state. The main point is that the erbium surrenders up its energy in the form of additional photons with the similar phase and direction as the signal being multiplied and amplified. Thus, the signal is amplified along the direction of transmission. This is not unusual—if an atom “lases,” it always surrenders its energy in the same direction and phase as the incoming beam source. Therefore, a whole additional signal source is guided in the similar fiber mode as the incoming signal. Usually, an isolator is placed at the output port to overcome reflections going back from the attached optical fiber. As reflections disrupt amplifier operation, in the extreme case, it will cause the amplifier to become a laser. The ED (erbium-doped) compound has a great gain.

## 2.2. Semiconductor optical amplifier

SOA is an amplifier of small size using a semiconductor to provide the gain medium [4] and pump electronically. It operates as the same as standard semiconductor lasers and is packaged in tiny size as “butterfly” design. In addition to their tiny size, they are low cost. SOA suffers from a quantity drawbacks making it not suitable for wide applications. In special case, it gives relatively low gain (<15 dB), has a low saturated output power (<13 dBm), and has relatively high NF. SOA has quick response time providing the operation to near the saturation level. They suffer from signal distortion for single channel setup and noise as effect of cross-gain modulation such as WDM operation and can suit for single channel booster where they do not require high gain or high output power. SOA has the same formation to Fabry-Pérot laser diodes but with anti-reflection elements at the end faces. Nowadays, the designs include antireflective coatings and tilted waveguide and window regions which can decrease

end-face reflection  $<0.001\%$ . Because it produces power losses from the resonator which can be higher than the gain, it prevents the amplifier from the source of laser. There are two kinds of SOA. One region is a laser diode having a Fabry-Pérot, and the second one is a tapered geometry to decrease the value power density on the output facet. SOA is particularly made from III-V compound periodic system such as InGaAs/ InP, AlGaAs/GaAs, InAlGaAs/ InP, and InGaAsP/InP, though any direct band gap semiconductors such as II-VI will conceivably be applied. These components are usually used for amplifier in telecommunication systems and technology such a fiber-pigtailed components, operating at signal wavelengths between 0.85 and 1.6  $\mu\text{m}$  and generating gains of up to 30 dB [5].

### 2.3. Raman amplifier

Raman amplifier (RA) amplifies signal by stimulated Raman scattering (SRS). SRS is a device having a process of electromagnetic wave scattered by ions or molecule compound from a lower state to a higher state of wavelength source. Sufficient great power source at a lower state which stimulated scattering may happen if data signal with a higher wavelength state is multiplied and amplified by Raman's from the source. SRS actually represents a nonlinear interaction between higher and lower wavelength. It can take place in optical waveguide. The efficiency of SRS is low for most fibers having high pump power particularly 1 W to obtain useful signal gain. Generally, RA cannot compete to EDFAs as depicted in **Figure 4**.

Raman amplification provides two unique benefits to other amplification telecommunication and technologies. This amplification wavelength band can be tailored by changing the source of wavelengths. It can be obtained at wavelengths that are not supported by competing technologies. The Raman amplification can be also achieved within the propagation wave in the optical fiber itself, enabling a distributed Raman amplification (DRA). In this mechanism, a high source power is launched into the optical fiber (from the output end) to amplify the wave signal to the fiber optics. Because the gain happens along the optical fiber cable, DRA prevents the wave signal from being damped or attenuated to very low powers, improving the SNR of information signal. RA is also always used with EDFAs to deal with the ultra-low

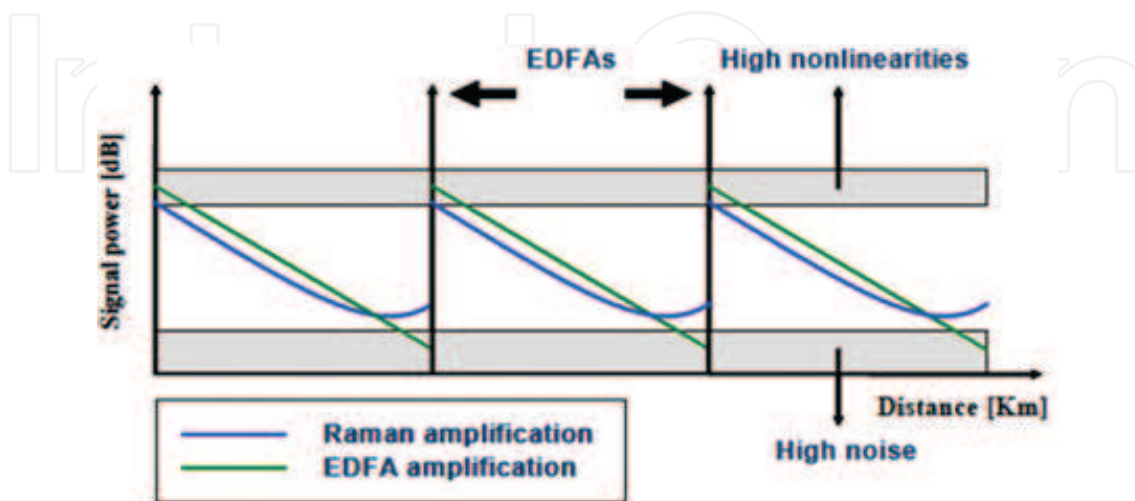

**Figure 4.** Signal power for Raman and EDFA.

NF-combined amplifiers. These are beneficial to many usages in communication, for example, ultra-long links spanning by order of  $10^3$  km, the long links with no in-line amplifiers, or very high bit-rate (40/100 Gb/s) links.

It is not like the EDFA and SOA; the effect of amplification is achieved by nonlinear factors between the optical signal and a laser source within the optical waveguide. There are two kinds of RA, i.e., distributed and lumped one. The former is the transmission fiber used as the gain medium by multiplexing a source wavelength with signal wavelength, while latter one utilizes a dedicated, shorter length of optical waveguide to provide amplification. Particularly, a lumped RA with highly nonlinear fiber having a small core is applied to enhance the interaction to signals and source wavelengths and thereby decreases the length of optical fiber required. The laser source may be combined to the fiber of transmission signal with the same direction (codirectional pumping), on the other direction (contra-directional pumping), or both. Contra-directional pumping source is often used as the noise transfer to the source pump to the signal decreased. Source power of RA is greater than that of the EDFA, >500 mW being required to achieve useful levels of gain in a distributed amplifier. In lumped amplifiers, the pump light can be safely contained to avoid safety implications of high optical powers, may use over 1 W. The principal advantage of Raman amplification is its ability to amplify and distribute the signal within the waveguide, by increasing the length of spans between amplifier and regeneration sites. The amplification bandwidth represents the source wavelengths used so that the amplification can be provided over wider, and different, regions than it is possible with other amplifier which depends upon dopants and optical component design to introduce the amplification "window."

Other advantages of RA are as follows. Firstly, its gain is available in fiber, providing a cost-effective means of upgrading of the terminal ends. Secondly, the Raman gain is non-resonant, that gain is available over the whole transparency area of the fiber approximately 0.3–2  $\mu\text{m}$ . Thirdly, by organizing the source of wavelengths, the gain may be tailored such as the multiple source lines can be utilized in order to enhance the bandwidth, and also the source distribution describes the gain flatness. The benefit to Raman amplifier is a broadband amplifier with a bandwidth relatively >5 THz, this result gain is reasonably flat over a wide wavelength range. But, the challenges of Raman amplifiers prevent their earlier adoption. Firstly, if one compares to the EDFAs, RA has relatively less pumping efficiency at lower-level signal power. Even though it has a disadvantage, this lack of pump efficiency becomes gain clamping readily in RA. Secondly, RA requires a longer gain of optical fiber. On the other hand, this disadvantage can be mitigated by mixing gain and the dispersion compensation in a single fiber. Thirdly, it has a fast response time, which gives rise to new sources of noise. Finally, there are concerns of nonlinear penalty in the amplifier for the WDM signal channels. Amplifier parameters will allow the amplification of a weak signal impulse in a non-centrosymmetric nonlinear medium. On the other hand, the amplifiers are mostly used in telecommunication application and technology. This kind finds its main application in expanding the frequency tunability of ultrafast solid-state lasers. For a noncollinear interaction geometry, its optical parameters are suitable for extremely wide bandwidths for amplification.



### 3. Design and model of SOA and FRA circuit

The suitable amplifier is one way to deal with the effects of linear and nonlinear disturbances as well as maximize the working of optical transmission media. Generally the optical amplifier consists of fiber Raman amplifier (FRA), erbium-doped fiber amplifier (EDFA), and semiconductor optical amplifier (SOA). SOA is designed in the form of quantum-dot SOA network as linear network and bulk SOA as nonlinear network [2]. Then, it is known that SOA has a high nonlinear nature, low power consumption, fast operating speed, and can easily be used in photonic systems [6–9].

In SOA type amplifier, the gain can be calculated using the following equation:

$$g_m = A_g (N - N_0) \quad (1)$$

where  $g_m$  = material amplifier,  $A_g$  = coefficient of derivative gain,  $N$  = carrier density,  $N_0$  = carrier density at the point of transparency.

$$g_t = \Gamma g_m - \alpha \quad (2)$$

where  $g_t$  = coefficient of amplifier,  $\Gamma$  = optical confinement factor,  $\alpha$  = effective loss coefficient.

$$G = \exp[g_t z] \quad (3)$$

where  $G$  = magnitude of gain (dB),  $z$  = length of optical fiber (dB).

Then, Bromage introduced the RA used in fiber-optic communication systems [10]. The gain on this amplifier can be calculated using the equation as follows:

$$G = 10 \log(\exp[gPL]) \quad (4)$$

$$g = 2\gamma\rho \text{Im}(\chi_{1111}[\omega_p - \omega_s]) \quad (5)$$

$$\gamma = \frac{2\pi n_2}{\lambda A_{eff}} \quad (6)$$

where  $G$  = magnitude of gain (dB),  $P$  = power pump (Watt),  $L$  = length of optical fiber (m),  $n_2$  = nonlinear refractive index ( $\text{m}^2 \cdot \text{W}^{-1}$ ),  $\gamma$  = nonlinear phase change (rad),  $A_{eff}$  = effective surface ( $\text{m}^2$ ),  $\lambda$  = wavelength signal (m),  $g$  = Raman gain coefficient,  $\rho$  = nonlinear polarization fraction,  $\chi_{1111}(\omega_p - \omega_s)$  = Raman's susceptibility.

Both amplifiers show that the type of SOA more considered the carrier density and the material factor, whereas FRA more considered the frequency characteristics and wave nonlinear conditions. However, both amplifiers are very dependent on the media passed by the signal. In order to investigate the performance of SOA and FRA, bit error rate (BER) and Q-factor are two parameters used to measure their characteristics.

BER and Q-factor are the most important factors that limiting the transmission distance in optical communication system. In order to transmit signals over long distances, it is necessary to have a low BER and high Q-factor within the fiber. The optical amplifier in the fiber represents the optical signals to be directly amplified optically without any conversion. The BER is an indication of how often data is retransmitted due to an error. Too high BER may indicate that a slower data rate will actually improve overall transmission time for a given amount of transmitted data because the BER may be decreased, lowering the quantity of packets that has to be present. In BER, the quantity of measured bits is incorrect before error correction, divided by the total amount of transferred bits (including redundant error codes). Usually, the BER is larger than the information data of it. The information of BER is influenced by the strength of the forward error correction program and code. There are kinds of BER occurring in optical communication circuit. It can be affected by transmission noise, interference, distortion, bit synchronization problems, attenuation, wireless multipath fading, etc. However, in both amplifiers, we consider the simple channel model and data source model.

Another factor is Q-factor, which explains the resonance performance of disturbance that is particularly shown by an underdamped harmonic oscillator. The driven cavity or resonators having high number of Q-factor will resonate with larger intensity, which is shown by amplitudes (at certain frequency). They have more tiny bandwidth range of frequencies around that frequency. They will resonate having frequencies that are defined as a bandwidth. The high value of Q-factor oscillators oscillates with more tiny range of frequencies and more stable condition. Q-factor unit is dimensionless describing how underdamped an oscillator is and characterizes a resonator's bandwidth relative to its center frequency.

The design of the network model will be simulated using OptiSystem version 11.1.0.53. In the model, the SOA and FRA optical amplifiers are coupled to the transmission amplifier network (in-line amplifier). **Figure 5** shows the design of model, optical fiber communication system.

### 3.1. Information source block

The information source block consists of two components: pseudorandom bit sequence (PRBS) and *non-return-to-zero pulse generator* (NRZ). PRBS functions to generate bits with specific patterns and speeds. Then the bit that has been generated by PRBS will be encoded using NRZ coding technique. NRZ coding technique has the advantage that is more resistant to noise and is not affected by the voltage level. **Figure 6** shows the planning drawing for the source of pulse information.

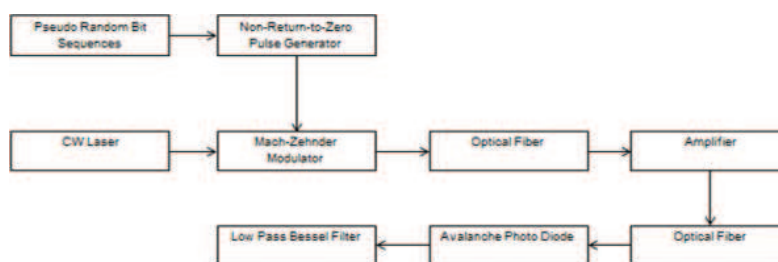

**Figure 5.** Model design with amplifier.

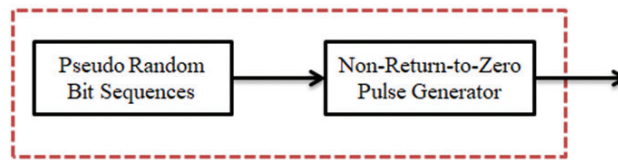

Figure 6. Information source block.

### 3.2. Transmitter block

The transmitter block (Figure 7) consists of two components: the laser and the modulator. The laser acts as a light signal generator on a network system. The type of laser used is a continuous wave (CW) laser. The modulator used is the Mach-Zehnder modulator (MZM) which will modulate the coded information signal with the output signal laser.

### 3.3. Transmission media block

The transmission medium (Figure 8) on this optical network uses single-mode optical fiber, because it has a wide bandwidth and a considerable range. In order for the transmitted signal to reach a considerable distance, it requires an optical amplifier, SOA and FRA. Type of TRD used is average power model amplifier (APA).

### 3.4. Receiver block

The receiver block consists of two components: a detector and a filter. The detector used is avalanche photodiode (APD) as shown in Figure 9, because it has a faster response and higher gain. The already converted information signal will be forwarded to the filter. The working principle of this filter passes a certain frequency and dampens other frequencies. The type of filter used is the *low-pass Bessel filter*.

The stages of this procedure begin with a preliminary simulation process that aims to determine the maximum transmission distance of signal propagation on the optical fiber without any gain. In the simulation process, it will iterate on the optical fiber, for 30 iterations, and each iteration is 10 km. Then, the determination of maximum transmission distance is demonstrated by using SOA and FRA. The working procedure of these two optical amplifiers can be seen in Figures 10 and 11. The length of fiber optics greatly affects the performance of a communication system. In determining the maximum transmission length, the parameters that

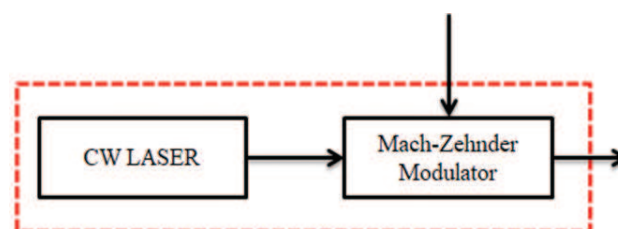

Figure 7. Transmitter block.



Figure 8. Transmission media block.

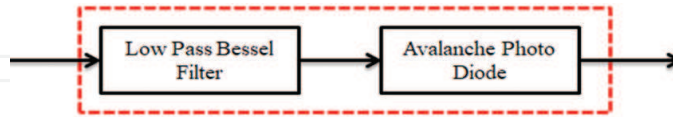

Figure 9. Receiver block.

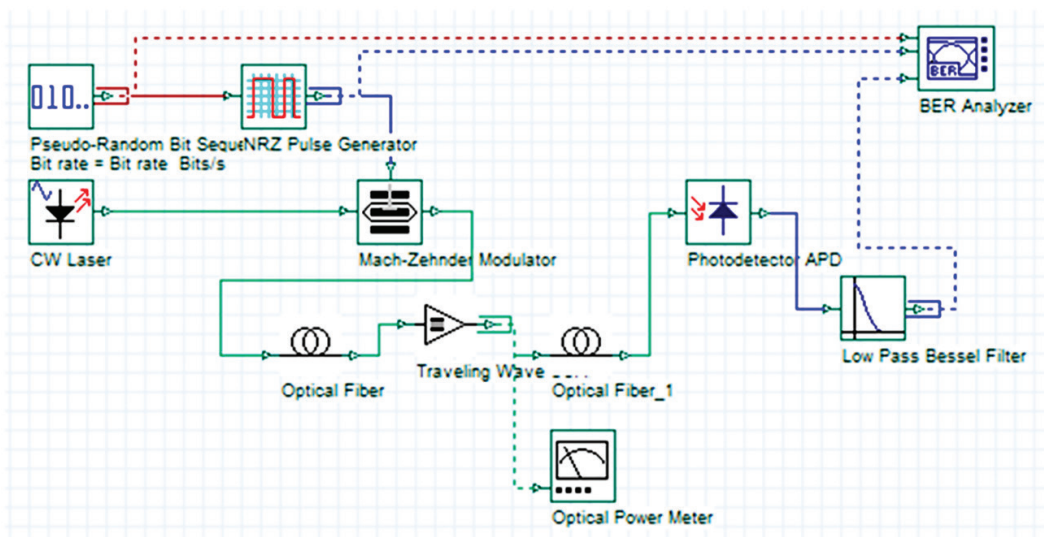

Figure 10. Optical fiber system scheme with SOA in-line amplifier.

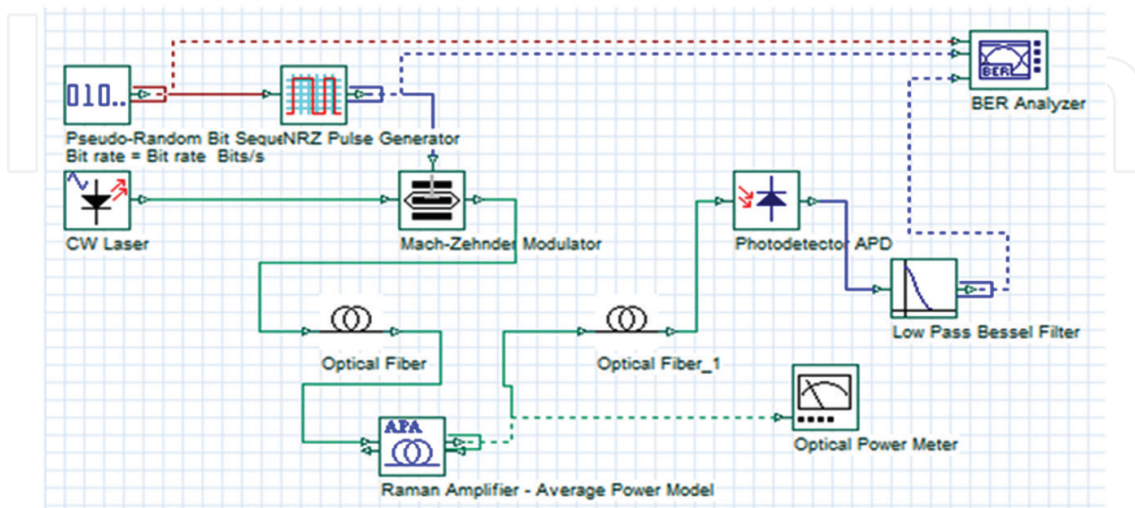

Figure 11. Optical fiber system scheme with FRA in-line amplifier.

play an important role are the bit error rate (BER) and Q-factor. According to the rules of the International Telecommunication Union (ITU-T G.691; ITU-T G.692; ITU-T G.693), the BER requirements for optical communication systems must be better than  $10^{-12}$ , meaning that the minimum value of BER system should be smaller than  $10^{-12}$ . Q-factor is a quality factor that will determine the quality of a link. In a fiber-optic communication system, the minimum size of a good Q-factor is 6. The power consumption of the amplifier will be measured using the optical power meter contained in the circuit. We will then see the influence of the wavelength on the maximum transmission distance of the system.

#### 4. Propagation and amplification of SOA and FRA

The result of SOA is depicted in **Figure 12**. The BER can be discussed by applying a model and simulation using a computer. A propagation model and data source mode are simply considered; the BER can be calculated analytically as well. If the device for BER analysis is not available, OTDR can be applied to detect the wave losses through the OptiSystem software for detecting the BER. A schematic flowchart of **Figure 10** is depicted to this analysis. BER is found in SOA where 1350 nm wavelength with 1 mW input power is better than the others since it has higher energy than 1470 nm and 1560 nm, so that BER oscillation depends on energy. However, after about 150 km, BER value increases. It is not surprising when the distance is long then the error will come; this is due to attenuation of geometry length where it can operate either low- or high-energy sources corresponding to wavelength source. Even at 120 km, the highest BER is achieved for 1350 nm (highest energy). This is the weaknesses of SOA characteristics. Although these data are unknown source of loss factors, improving BER may be measured by choosing strong signal, a slow and robust modulation pattern, or line coding signal such as repetitive forward error correction program (**Figure 13**).

As well as BER of SOA, Q-factor of SOA goes down as the distance is increased. But, Q-factor for 1350 nm (highest energy) is even less decayed than the others. Although the decay trends are stable beginning from 80 km similar to a constant Q-factor, at 140 km, the energy source is not good enough to maintain the oscillation source; hence the decay goes down near linear including 1350 nm and keeps maintaining to reduce it slowly. This performance shows that at

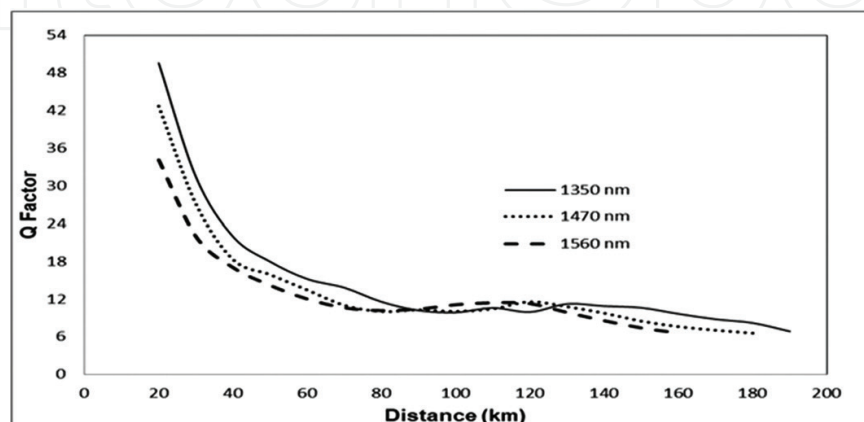

**Figure 12.** BER for SOA.

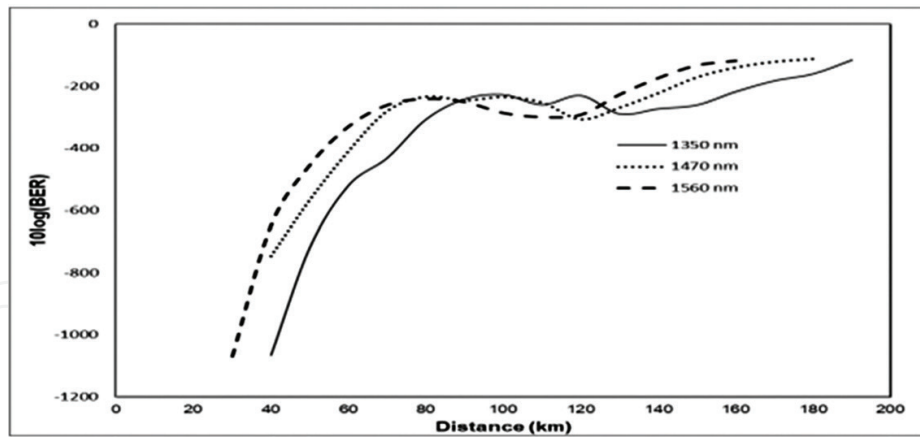

Figure 13. Q-factor of SOA.

wavelength of 1350 nm, the dispersion is more than the wavelength of 1560 nm, but Q-factor oscillation is low. Unlike SOA, FRA has good performance for both BER and Q-factor. The result of FRA for BER and Q-factor is depicted in **Figures 14** and **15**. BER is less fluctuated and more stable for higher energy of  $E = hf$ , where  $f$  is frequency source,  $h$  is Planck constant, and  $E$  is energy. From 60 to 140 km, BER is nearly constant for various wavelength sources; hence this BER is better than SOA. Q-factor is faster for a stable condition at higher energy at 80 km and continues after 160 km.

**Figure 16** is an eye pattern diagram with no amplifier. It is generally seen that the amplitude and bit error rate differ greatly at the lower distances at (a) than (b). The weakness of the unfocused amplitude is due to the power and geometry of the far wave from the wave source. The red line facing below is BER, and the red line facing the top is Q-factor.

In **Figure 17**, both wavelengths at 160 km distance have a low Q-factor especially at low-wave energy. SOA function is very effective at a distance less than 100 km, but at the peak of 160 km, the wave amplitude is not focused anymore. Amplitude is affected by distance even if SOA is used.

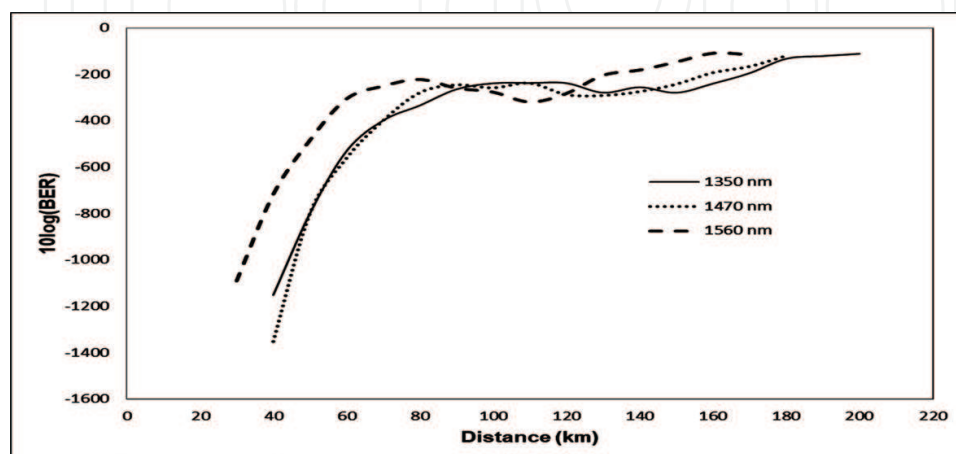

Figure 14. BER for FRA profile.

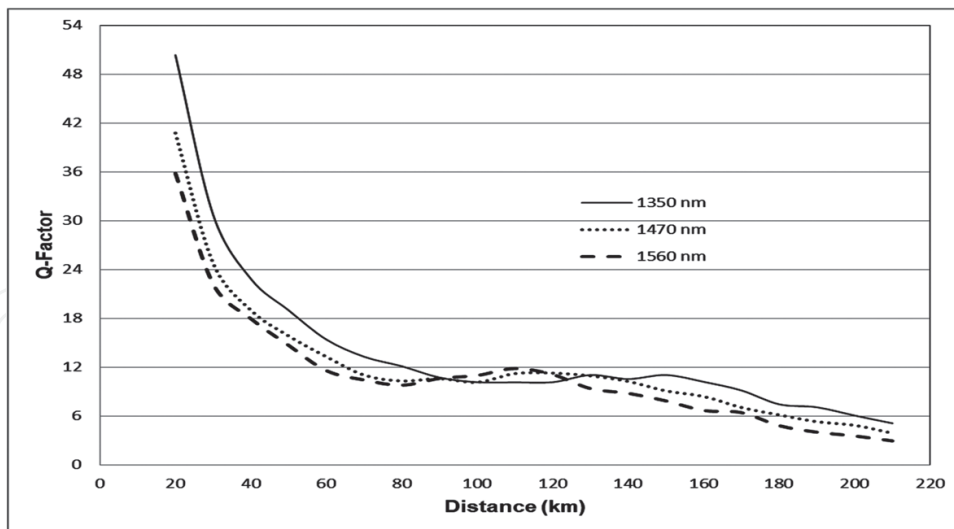

Figure 15. Q-factor of FRA profile for various energy.

Figure 18 is somewhat different than SOA. FRA has a more effective BER and Q-factor. At a distance of less than 90 km, the very sharp eye pattern at 1350 nm wavelength is almost equal to the 1560 nm wavelength. The value of FRA at a distance of 170 km is still more effective than on SOA values both at 1350 nm and at 1560 nm. However at 1560 nm, BER is more sharp as Q-factor as well. BER and Q-factor at 1560 are higher so that the amplifier function is weak especially at great distances.

#### 4.1. Optical circuits without amplifier BER and Q-factor analysis

The length of the optical fiber used can affect the performance of a fiber-optic communication system. In determining the maximum transmission length, one of the parameters that play an important role is the amount of bit error rate (BER). The BER requirement for the optical communication system should be less than  $10^{-12}$ . The first stage is a simulation process without using an optical amplifier to determine the maximum transmission length with laser wavelength variation. BER is shown in Figure 19.

Since the data obtained is in a very small order, then the data change in the form of logarithmic functions. The BER value for an optical source with a wavelength of 1350 nm is  $2.12 \times 10^{-12}$

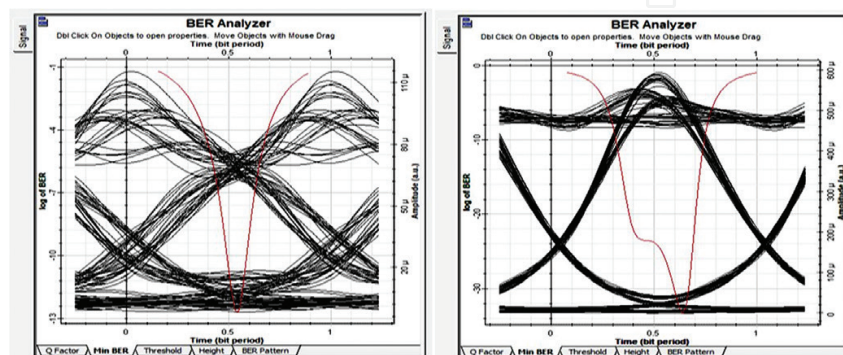

Figure 16. (a) 1350 nm, 85 km. (b) 1560 nm, 85 km.

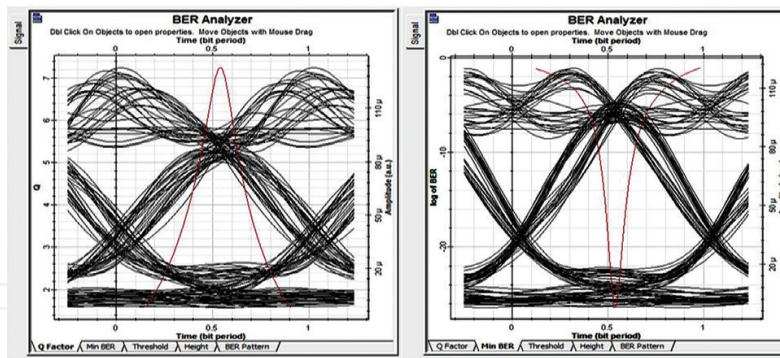

Figure 17. (a) SOA (BER and Q-factor) 1350 nm, 80 km. (b) SOA (BER, Q-factor) 1560 nm, 160 km.

or  $-116.74$  dB at a distance of 95 km and  $3.51 \times 10^{-9}$  or  $-84.55$  dB at a distance of 100 km. The BER value for an optical source with a wavelength of 1470 nm is  $1.64 \times 10^{-13}$  or  $-127.85$  dB at a distance of 85 km and  $1.66 \times 10^{-9}$  or  $-87.80$  dB at a distance of 90 km, whereas the BER value for an optical source with a wavelength of 1560 nm is  $1.26 \times 10^{-12}$  or  $-119$  dB at a distance of 80 km and  $3.56 \times 10^{-9}$  or  $-84.49$  dB at a distance of 85 km. So it can be concluded from Figure 4.1 that the maximum transmission distance of the fiber-optic communication system without the amplifier is 95 km for the 1350 nm wavelength, 85 km for the 1470 nm wavelength, and 80 km for the 1560 nm wavelength.

In addition to the BER value, Q-factor is one of the parameters used as a reference in determining the quality of the optical circuit. Under the rules of ITU (International Telecommunication Union) in ITU-T G.691; ITU-T G.692; ITU-T G.693, it is agreed that the minimum Q-factor value that must be possessed by an optical communication system is 6. This shows that a circuit can be categorized well if the circuit has a Q-factor above 6. In contrast, the circuit cannot be used if it has a number below that value.

Based on the simulation that has been executed, it obtains that the value of Q-factor at the source wavelength of 1350 nm is 6.59 at a distance of 95 km and 5.79 at a distance of 100 km. At the source wavelength of 1470 nm, the obtained value is 7.28 at a distance of 85 km and 5.91 at a distance of 90 km, while at the wavelength of 1560 nm, the found value is 6.32 at a

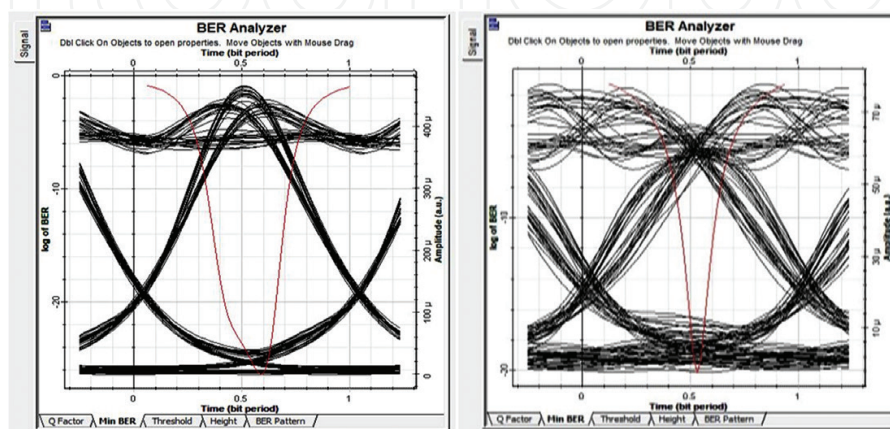

Figure 18. (a) Raman (BER and Q-factor) 1350 nm, 90 km. (b) Raman (BER and Q-factor) 1350 nm, 170 km.



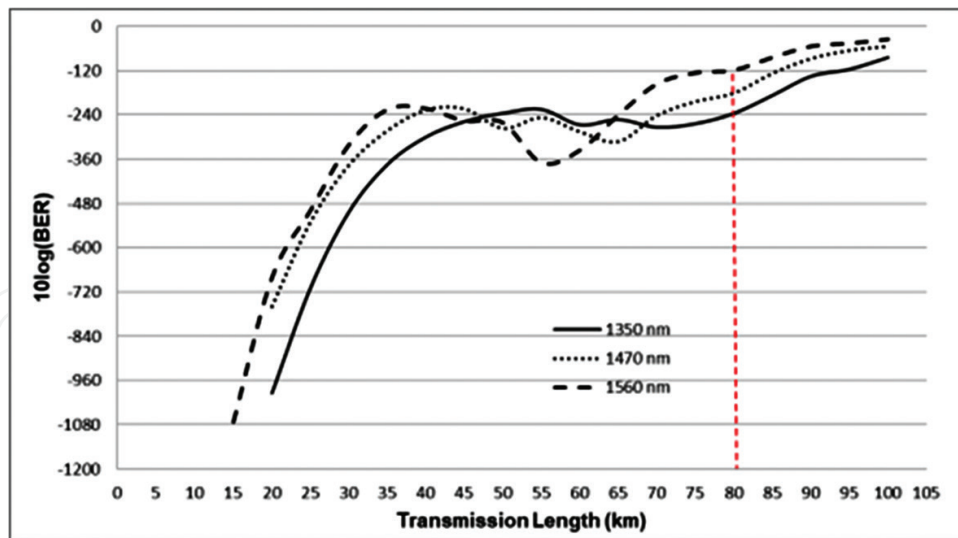

Figure 19. BER value to transmission length.

distance of 80 km and 5.79 at a distance of 85 km. So **Figure 20** corresponds to the BER data obtained where the maximum transmission distance at the source wavelength of 1350 nm is 95 km, 85 km at 1470 nm wavelength, and 80 km at 1560 nm wavelength.

#### 4.2. SOA amplifier circuit BER and Q-factor

SOA is a type of amplifier that uses semiconductors to gain medium gain. SOA has a structure similar to the Fabry-Pérot laser diode, but it has an anti-reflection element on its surface. Unlike other amplifiers, SOA is electronically pumped directly through the current and does not require a separate laser pump. The working principle of SOA is similar to the laser, where in the active part of the semiconductor, the injection current will excite the electrons from the valence band to the conduction band. If there is light as an input signal, then the electron set will be stimulated to return to the valence band by emitting energy to gain reinforcement. Based on the simulation, SOA is depicted in **Figures 21** and **22**.

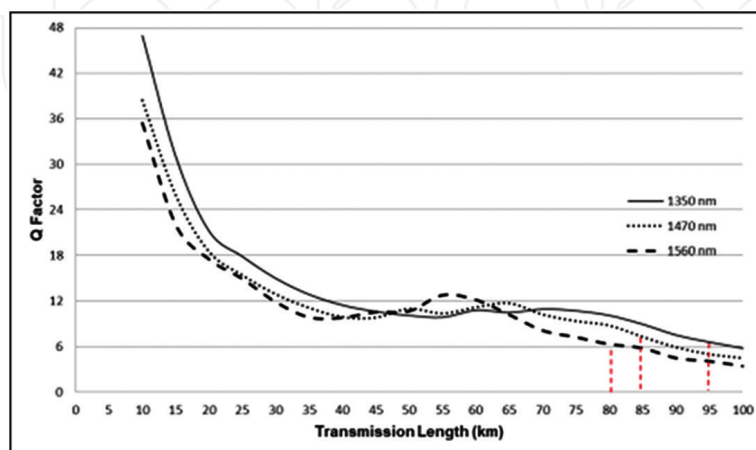

Figure 20. Q-factor on transmission length without amplifier of optical circuit.

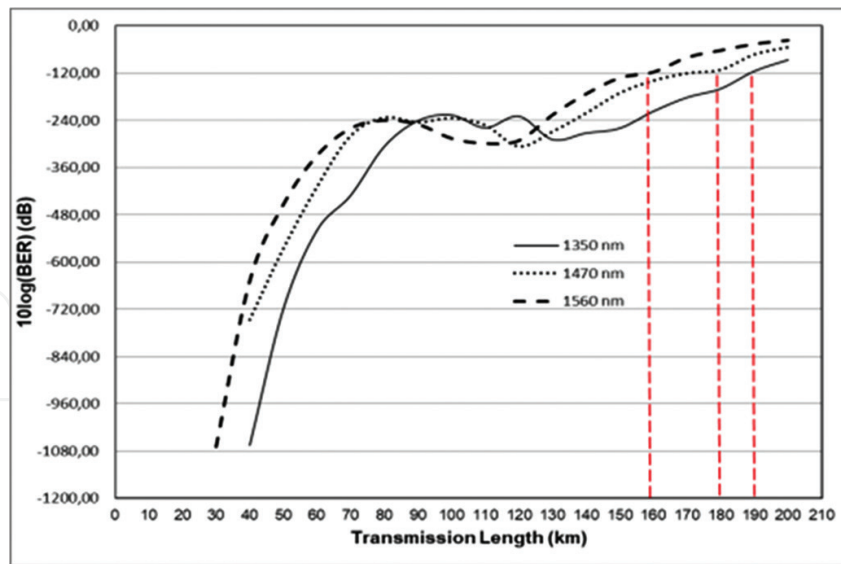

Figure 21. BER, transmitting on SOA circuit.

The BER value for an optical source with a wavelength of 1350 nm is  $3.25 \times 10^{-12}$  or  $-114.88$  dB at 190 km and  $2.31 \times 10^{-9}$  or  $-86.36$  dB at a distance of 200 km. The BER value for an optical source with a 1470 nm wavelength is  $7.24 \times 10^{-12}$  or  $-111.40$  dB at a distance of 180 km and  $5.63 \times 10^{-8}$  or  $-72.49$  dB at a distance of 190 km. The BER value for the optical source with a wavelength of 1560 nm is  $1.85 \times 10^{-12}$  or  $-117.33$  dB at a distance of 160 km and  $9.51 \times 10^{-9}$  or  $-80.2$  dB at a distance of 170 km. So it can be concluded from the graph that the maximum transmission distance of the fiber-optic communication amplifier SOA system is 190 km for the wavelength of 1350 nm, 180 km for the 1470 nm wavelength, and 160 km for the 1560 nm wavelength.

The Q-factor value (Figure 22) at the source wavelength of 1350 nm is 6.87 at a distance of 190 km and 5.86 at a distance of 200 km. At the source wavelength of 1470 nm, the obtained

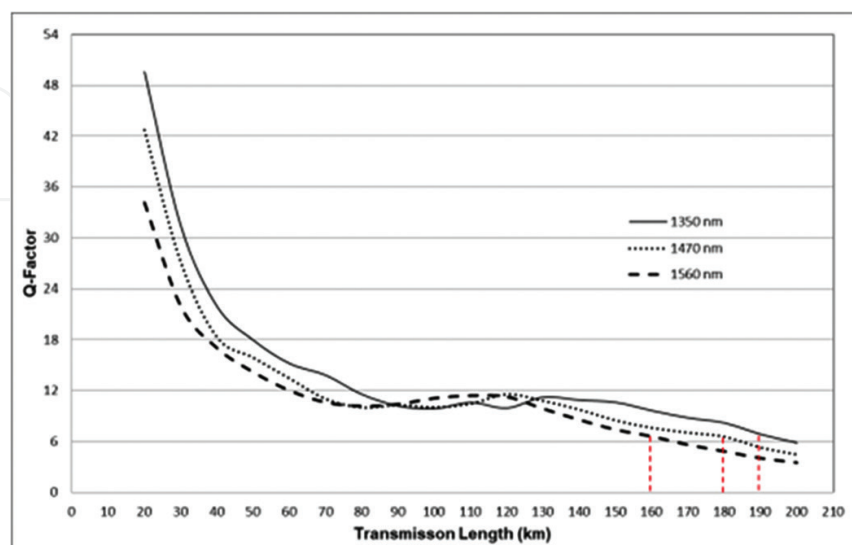

Figure 22. Q-factor of transmission length in SOA circuit.

value is 6.58 at a distance of 180 km and 5.30 at a distance of 190 km, while at the wavelength of 1560 nm, the found value is 6.61 at a distance of 160 km and 5.62 at a distance of 170 km. So this result corresponds to the BER data obtained where the maximum transmission distance at the source wavelength of 1350 nm is 190 km, 180 km at 1470 nm wavelength, and 160 km at a 1560 nm wavelength.

#### 4.3. RFA circuit: BER and Q-factor

RA works based on the principle of scattering Raman (Raman scattering). This amplifier does not use a special medium/fiber for strengthening but uses only its transmission media. The characteristics of RA include:

- The strengthening mechanism uses stimulated Raman scattering (SRS).
- Effectively SRS deprives the energy of shorter wavelengths and gives it to longer wavelengths.

When a monochromatic light engulfs or crashes into a particle, there will be a certain interaction between the light and the particles it has hit. Light will be reflected, absorbed/refracted, or scattered. If scattering causes wavelength changes, then this phenomenon is called Raman scattering producing higher power.

The RA is an additional component of the development of the EDFA optical amplifier. Raman launches high-power laser into the optical waveguide in the opposite direction of the source signal. The photon injection amplifies the optical signal where it is needed almost at all over long distances. Reinforcement Raman can make signal boosters more than 10 dB, where skipping for longer distances. Also it allows optical network to achieve transmission speed up to 40 Gbits/s.

The nonlinear effect will appear in the fiber transmission which is the result of signal amplification if the optical signal is pumped by the wavelength and power is released into the fiber. Based on the simulation, FRA is depicted in **Figures 23** and **24**.

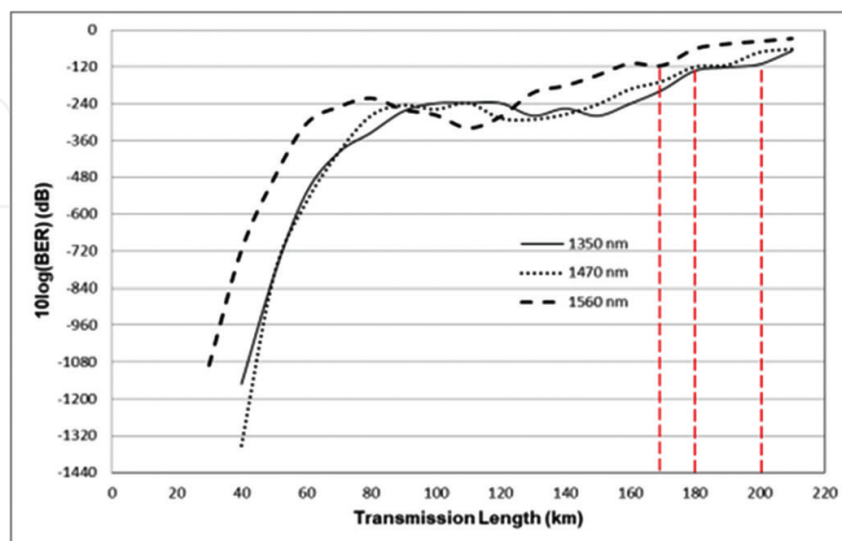

Figure 23. Graph of BER value to transmission length on FRA circuit.

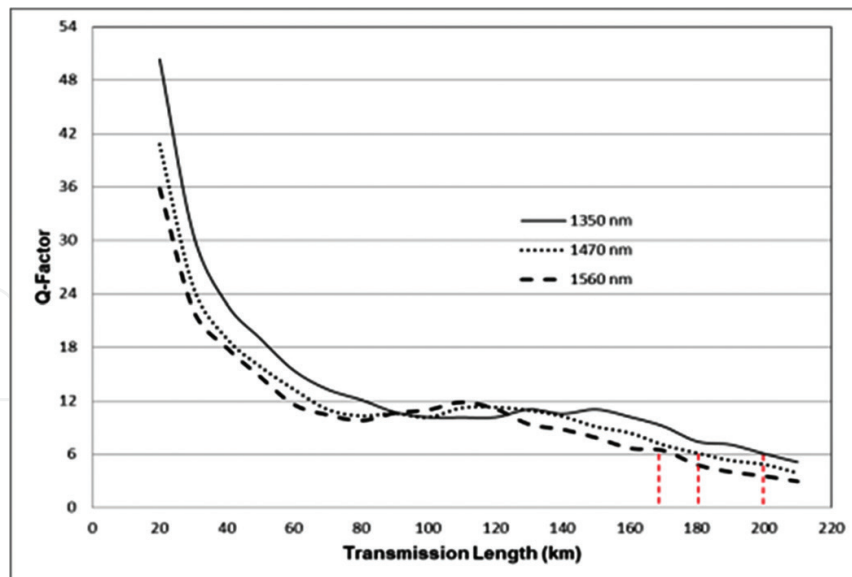

Figure 24. Q-factor of transmission length on the FRA circuit.

The BER value for an optical source with a wavelength of 1350 nm is  $6.98 \times 10^{-12}$  or  $-111.56$  dB at a distance of 200 km and  $1.62 \times 10^{-7}$  or  $-67.90$  dB at a distance of 210 km. The BER value for an optical source with a 1470 nm wavelength is  $4.01 \times 10^{-12}$  or  $-113.97$  dB at a distance of 180 km and  $5.73 \times 10^{-8}$  or  $-72.42$  dB at a distance of 190 km. The BER value for an optical source with a wavelength of 1560 nm is  $2.94 \times 10^{-12}$  or  $-115.32$  dB at a distance of 170 km and  $7.11 \times 10^{-7}$  or  $-61.48$  dB at a distance of 180 km. So it can be concluded that the maximum transmission distance of the fiber-optic communication amplifier FRA system is 200 km for 1350 nm wavelength, 180 km for 1470 nm wavelength, and 170 km for 1560 nm wavelength.

The Q-factor value in Figure 24 at the source wavelength of 1350 nm is 6.06 at a distance of 200 km and 5.11 at a distance of 210 km. At the source wavelength of 1470 nm, the obtained value is 6.14 at a distance of 180 km and 5.30 at a distance of 190 km, while at the wavelength of 1560 nm, the found value is 6.42 at a distance of 170 km and 4.82 at a distance of 180 km. So this result corresponds to the BER data obtained where the maximum transmission distance at the source wavelength of 1350 nm is 200 km, 180 km at the 1470 nm wavelength, and 170 km at the 1560 nm wavelength.

#### 4.4. Comparison between BER and Q-factor without amplifier SOA and FRA

Based on Figures 25 and 26, it can be seen at the stance the SOA reinforcement system is 180 km. But the BER value in the SOA amplifier circuit is larger, and the Q-factor is smaller than the FRA amplifier circuit. While in the circuit without the amplifier, the maximum transmission distance is only worth 90 km.

Based on Figures 27 and 28, at the 1350 nm source wavelength, the FRA amplifier optical circuit has a longer transmission distance than the SOA system, where the maximum distance on the FRA amplifier circuit is 200 km while the maximum distance on the SOA circuit is only

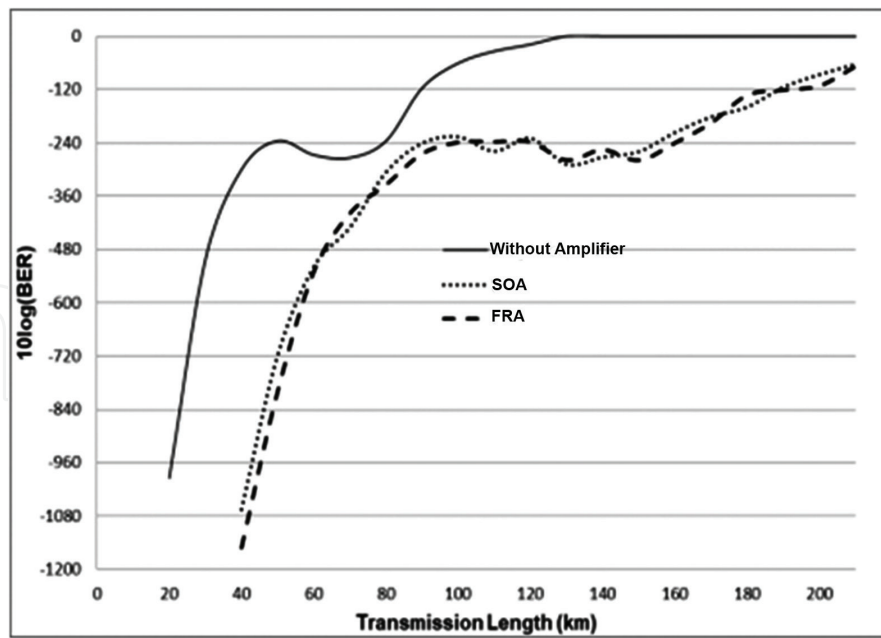

Figure 25. BER value over transmission length at wavelength of 1470 nm.

190 km. While in the circuit without the amplifier, the maximum transmission distance is only worth 90 km. This proves the role of the optical amplifier used so that the signal can propagate further when compared to the circuit without amplifier.

Based on Figures 29 and 30 it can be seen at the largest source wavelength of 1560 nm, the TRA amplifier optical circuit has a longer transmission distance than the SOA system, where the maximum distance on the FRA amplifier circuit is 170 km while the maximum distance in the SOA circuit is only 160 km. While in the circuit without the amplifier, the maximum transmission distance is only worth 80 km.

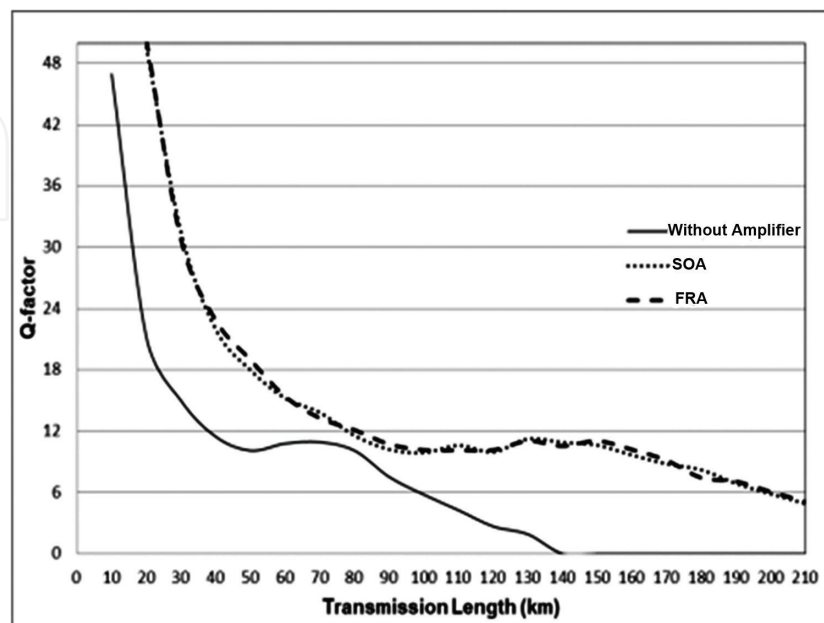

Figure 26. Q-factor to transmission distance at wavelength 1470 nm.

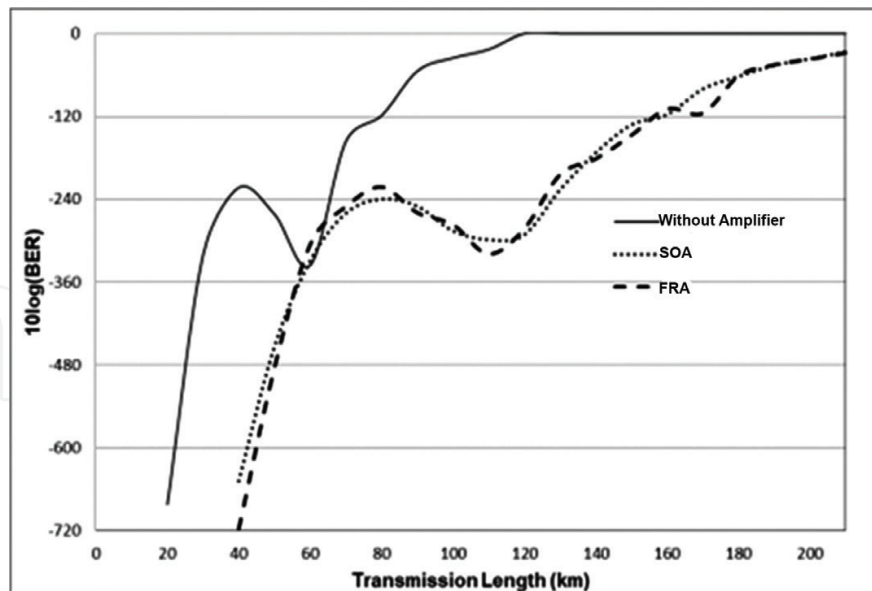

Figure 27. BER to transmission over wavelength at wavelength 1350 nm.

#### 4.5. SOA and FRA: BER and Q-factor

The result of SOA of BER can be analyzed using computer simulations. When a simple transmission model and data source mode are considered, the BER can also be calculated analytically. In the absence of device for BER analysis, OTDR has been used for detecting signal losses in optical fiber and the OptiSystem software for analyzing the BER. The circuit diagram is used to do this analysis. BER is found in SOA where 1350 nm wavelength with 1 mW input power is better than the others since it has higher energy than 1470 and 1560 nm, so that BER oscillation depends on energy. However, after about 150 km, BER value increases. It is not surprising when the distance is long then the error will come; this is due to attenuation of

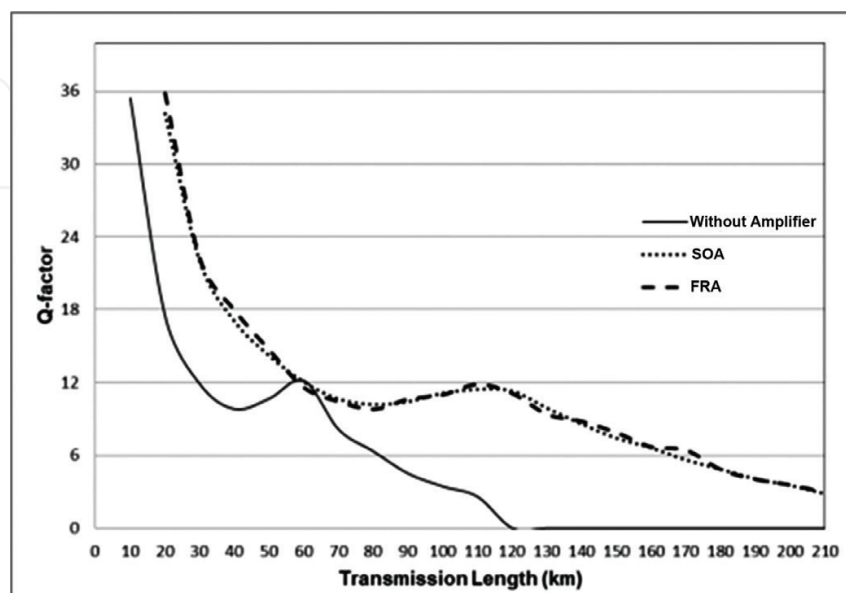

Figure 28. Q-factor over transmission length for wavelength 1350 nm.

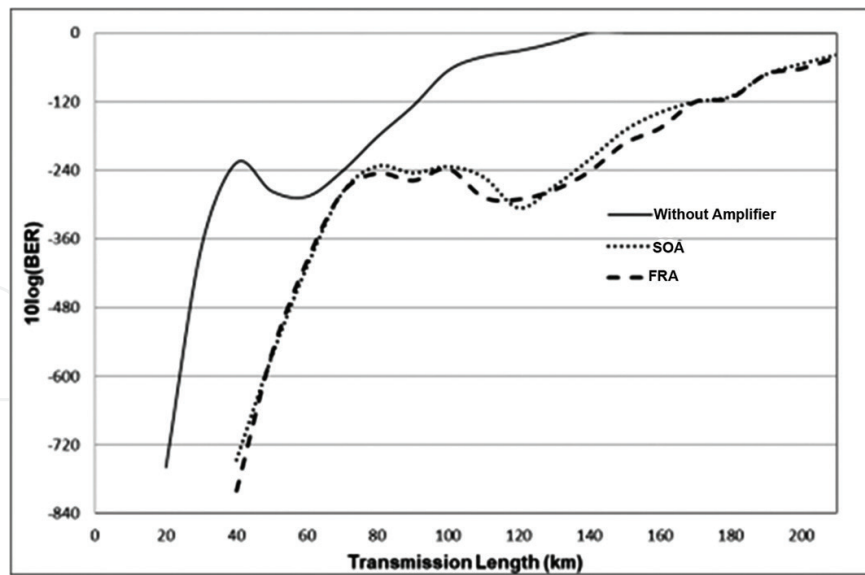

Figure 29. BER value over transmission length at wavelength 1560 nm.

geometry length where it can operate either low- or high-energy sources corresponding to wavelength source. Even at 120 km, the highest BER is achieved for 1350 nm (high energy). This is the weaknesses of SOA characteristics.

Although these data are unknown source of loss factors, improving BER can be detected by choosing strong signal strength, a slow and robust modulation scheme, or line coding scheme or using coding schemes such as redundant forward error correction codes. As well as BER of SOA, Q-factor of SOA goes down as a distance is increased. Q-factor for 1350 nm is even less decayed than the others, although the decay trends are stable beginning from 80 km similar to a constant Q-factor. At 140 km the energy source is not good enough to maintain the oscillation source; the decay goes down near linear for 1350 nm and keeps maintaining to reduce it slowly.

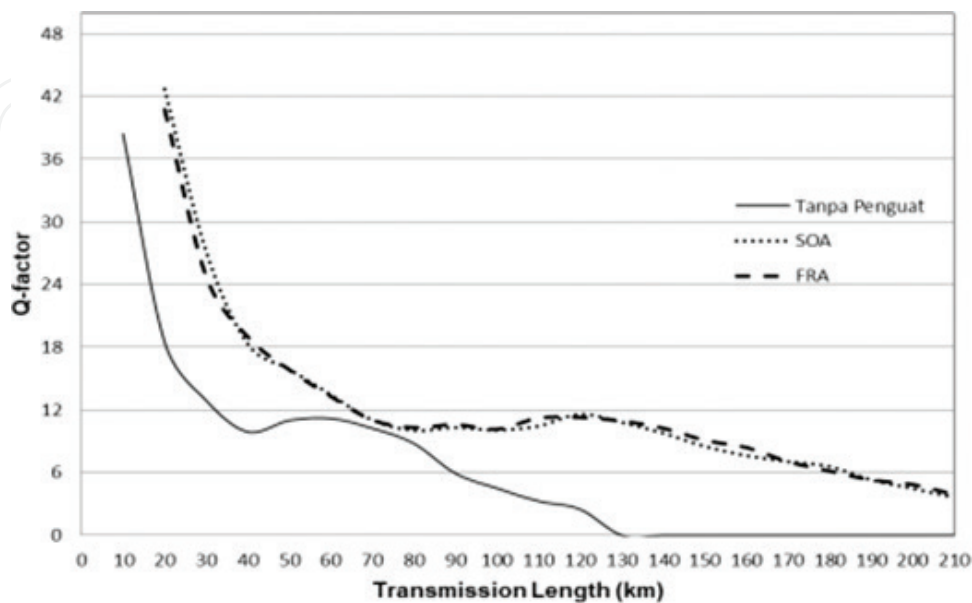

Figure 30. Q-factor to transmission length at wavelength 1560 nm.

Wavelength source (nm)	Transmission length (km)	Amplifier	Power input (dBm)	Power output (dBm)	Power consumption (dBm)
1350	100	FRA	0	-43.533	43.533
		SOA	0	-41.737	41.737
	190	FRA	0	-61.302	61.302
		SOA	0	-59.592	59.592
1470	100	FRA	0	-43.565	43.565
		SOA	0	-41.622	41.622
	180	FRA	0	-59.499	59.499
		SOA	0	-57.880	57.880
1560	100	FRA	0	-43.752	43.752
		SOA	0	-41.808	41.808
	160	FRA	0	-55.740	55.740
		SOA	0	-53.794	53.794

**Table 1.** Power consumption to FRA than SOA.

Unlike SOA, FRA has good performance for both BER and Q-factor. BER is less fluctuated and more stable for higher energy of  $E = hf$ , where  $f$  is frequency source,  $h$  is Planck constant, and  $E$  is energy. From 60 to 140 km, BER is nearly constant for various wavelength sources; hence, this BER is better than BER of SOA. Q-factor is faster for a stable condition at higher energy at 80 km and continues after 160 km. This performance shows that at wavelength of 1350 nm, the dispersion is more than the wavelength of 1560 nm, but Q-factor oscillation is low.

#### 4.6. Power consumption

The measured power consumption is the power consumption in the FRA circuit and the SOA circuit. The input power used in both circuit types is 1 mW or 0 dBm. This input power comes from the laser, and the output power is measured on the detector device. The power measurement uses an optical power meter and an electrical power meter at the output that can calculate the signal power passing through which the device is placed. Power consumption is obtained by calculating the input power difference with output power. From **Table 1** it can be seen at wavelengths of 1350, 1470, and 1560 nm for in-line amplifier implementation, the power consumption of the SOA is smaller than that of the FRA circuit. The SOA has slightly more energy efficient when compared to the FRA requiring a pumping laser so that the lost power is greater.

### 5. Conclusion

Although the optical amplifier can maintain the signal along the trajectory of waveguide, several amplifiers still have weaknesses. Both SOA and FRA have advantages and disadvantages. Using the simulation application, both amplifiers are successfully designed and compared by in-line amplifiers. The results described that the transmission distance of the FRA is much farther than the SOA shown by BER and Q-factor. However, this FRA system has higher power consumption when compared to the SOA system.



## Author details

Toto Saktioto\* and Roby Ikhsan

\*Address all correspondence to: saktioto@ieee.org

Department of Physics, Faculty of Mathematics and Natural Sciences, Universitas Riau,  
Pekanbaru, Indonesia

## References

- [1] Finisar White Paper. Introduction to Optical Amplifiers. Finisar Corporation. Sunnyvale, CA. 2012
- [2] Karimah ZN, Hambali A, Suwandi. Analisis Perbandingan Kinerja Mach-Zehnder berdasarkan Ragam Format Modulasi pada Jaringan FTTH. *Jurnal ELKOMIKA*. 2017;5(1): 73-92
- [3] Leuthold J, Bonk R, Vallaitis T, Marculescu A, Freude W, Meuer C, et al. Linear and non-linear semiconductor optical amplifiers. In: Conference on Optical Fiber communication (OFC/NFOEC) Collocated National Fiber Optic Engineers Conference. San Diego: IEEE Xplore, Digital Library; 2010
- [4] Bromage J. Raman amplification for fiber communications systems. *IEEE Journal of Lightwave Technology*. 2004;22(1):79-93
- [5] Connolly MJ. Semiconductor Optical Amplifiers. Boston, MA: Springer-Verlag; 2002. ISBN: 978-0-7923-7657-6
- [6] Sun H, Wang Q, Dong H, Dutta NK. XOR performance of a quantum dot semiconductor optical amplifier based Mach-Zehnder interferometer. *Optics Express*. 2005;13(6):1892-1899. DOI: 10.1364/OPEX.13.001892
- [7] Hamie A, Sharaiha A, Guegan M, Pucel B. All-optical logic NOR gate using two-cascaded semiconductor optical amplifiers. *IEEE Photonics Technology Letters*. 2002;14(10):1439-1441. DOI: 10.1109/LPT.2002.802426
- [8] Kanellos GT, Petrantonakis D, Tsiokos D, Bakopoulos P, Zakynthinos P, Pleros N, et al. All-optical 3R burst-mode reception at 40 Gb/s using four integrated MZI switches. *Journal of Lightwave Technology*. 2007;25(1):184-192
- [9] Dong J, Zhang X, Fu S, Xu J, Shum P, Huang D. Ultrafast all-optical signal processing based on single semiconductor optical amplifier. *IEEE Journal of Selected Topics in Quantum Electronics*. 2008;14(3). DOI: 770-778. DOI: 10.1109/JSTQE.2008.916248
- [10] Ghosh B, Mukhopadhyay S. All-optical wavelength encoded NAND and NOR operations exploiting semiconductor optical amplifier based Mach-Zehnder interferometer wavelength converter and phase conjugation system. *Optics and Photonics Letters*. 2011; 4(2):1-9. DOI: 10.1142/S1793528811000172