

We are IntechOpen, the world's leading publisher of Open Access books Built by scientists, for scientists

4,800

Open access books available

122,000

International authors and editors

135M

Downloads

Our authors are among the

154

Countries delivered to

TOP 1%

most cited scientists

12.2%

Contributors from top 500 universities



WEB OF SCIENCE™

Selection of our books indexed in the Book Citation Index
in Web of Science™ Core Collection (BKCI)

Interested in publishing with us?
Contact book.department@intechopen.com

Numbers displayed above are based on latest data collected.

For more information visit www.intechopen.com



NO_x Pollutants from Diesel Vehicles and Trends in the Control Technologies

İbrahim Aslan Reşitoğlu

Abstract

Nowadays, climate change that caused from air pollution has become a major problem on the agenda of almost all countries around the world. Compared to other air pollutants, NO_x emissions have an important share in climate change, and especially diesel vehicles are one of the most important sources for the formation of NO_x pollutants. This chapter focused on NO_x emissions from diesel vehicles and the trends in NO_x control technologies; Exhaust Gas Recirculation (EGR), Lean NO_x trap (LNT) and Selective Catalytic Reduction of NO_x by ammonia (NH₃-SCR) and hydrocarbons (HC-SCR). The reasons of the NO_x emissions, environmental effects and damages on human health, NO_x emissions from diesel engines and diesel engine parameters affecting NO_x emissions are handled in detail. The EGR, LNT and SCR technologies that had large reduction rates of NO_x emissions and the latest developments in these systems are comprehensively explained.

Keywords: air pollution, NO_x emissions, diesel engine, EGR, LNT, SCR

1. NO_x emissions in the window of life cycle

Air pollution causes serious damage to human health and the environment. The World Health Organization reported that 9 out of every 10 people in the world breathe polluted air and 7 million people lost their lives due to air pollution [1]. Harmful gases, which are released from industrial facilities, power plants, automobiles and other transport vehicles, threaten human health by entering the airways, the lungs and the bloodstream from there. In addition to human health, biodiversity and ecosystems are also endangered by air pollution. The damages of air pollution at financial level reach very serious figures [2]. It is reported that in 2015, air pollution caused USD 280 billion expense only in social assistance costs worldwide [3]. From past to present, dozens of reports on air pollution and its effects have been published by various organizations, and various policies and plans have been drafted and regulations and laws have been enacted in order to prevent air pollution [4–10].

NO_x emissions are one of the most important pollutants causing air pollution and climatic change. NO_x emissions are in the most effective pollutant class with PM and ozone (O₃) [8]. All kinds of sources where combustion is performed at high temperatures (internal combustion engines, gas turbines, power plants, industry etc.) create NO_x emissions and 95% of NO_x emission is made by these sources [4].

NO_x emissions are called nitrogen oxides and are usually in the form of nitrogen monoxide (NO) and nitrogen dioxide (NO₂). NO emission is a colorless and odorless gas and poisonous to humans. NO₂ gas is a highly reactive gas in red-brown color and has a suffocating odor and high oxidizing property. Compared with NO gas, the toxic effect of NO₂ gases is 5 times higher [11, 12].

The effects of NO_x emissions on human health are on a frightening scale. Today, pollutant emissions and especially NO_x emissions lie behind the problems, which about many individuals complain. The report of the European Environment Agency (EEA), published in 2017, shows the extent of the air pollution and the threat of global warming caused by NO_x emissions. It is stated in this report that NO_x emissions in 2014 caused about 80,000 premature deaths in Europe [8].

The effects of NO_x gases on human health are directly proportionate to the density and inhalation period. Low rates or short-term inhalation of NO_x emissions can cause health problems such as eye and throat irritation, chest tightness, nausea, headache and loss of strength. Long-term or large amount of exposure to NO_x gases causes severe coughing, difficulty in breathing, asthma, cyanosis, and sometimes give rise to even death [13]. The World Health Organization (WHO) states that 80% of lung diseases and lung cancer are caused by air pollution, particularly by NO_x [9]. A study found that NO_x emissions causes premature birth resulting from asthma in pregnant women [14].

NO_x pollutant emissions also play an important role in ground-level ozone formation, which has serious adverse effects on human health and the environment. In the natural process, ozone (O₃) is a very reactive form of oxygen formed in the upper layer of the atmosphere and protects the earth from the sun's ultraviolet rays. However, the ozone layer that takes place due to the pollutant emissions under the atmosphere is very dangerous. When NO emissions are released into the air, they react with O₂ in the air and form NO₂ and cause formation of undesirable ground-level ozone. Ozone formed in this way leads to global warming, causing serious damage to human health and environment [15].

Ground-level ozone formation, which is caused by NO_x emissions, invites global warming by increasing the greenhouse effect. Due to the undesirable ozone formation, the year 2015 has been the hottest year since the past [8].

Figure 1 shows the effect of NO_x emissions on ozone and greenhouse gases. The rays coming on the Earth are reflected by the earth and are absorbed by the gases (mainly carbon dioxide (CO₂), methane (CH₄) and water vapor) in the atmosphere. This natural process called the greenhouse effect give rise earth to warm. The presence of redundant gases in the atmosphere causes the reflected radiation to be held at a high level, resulting increase in warming and temperatures than the normal level in the earth. The activity of the people, especially the emissions of NO_x pollutants formed from the consumption of fossil fuels, cause the greenhouse effect to intensify by increasing the amount of greenhouse gases. The formation of greenhouse gases more than normal in the atmosphere, brings with it climate change and global warming.

Rain is very effective in removing NO₂ gases from the atmosphere. However, the contact of NO₂ gas with water produces nitrous acid (HNO₂) and nitric acid (HNO₃), which have a very corrosive effect (**Figure 2**). This leads to acid rain, which is harmful particularly for plants. In addition to acid rain, the combination of NO₂ emissions with hydrocarbon (HC) emissions leads to the formation of photochemical smog.

Many precautions are taken by various organizations to reduce the negative effects of NO_x emissions on human health and the environment, and various policies and laws are being established. In 2030, if severe climatic policies are implemented, two-thirds of the NO_x emissions in 2005 will be reduced [16]. Creation of clean air zones, establishment of emissions standards by various organizations, taking necessary measures to eliminate pollutant emissions are among the policies

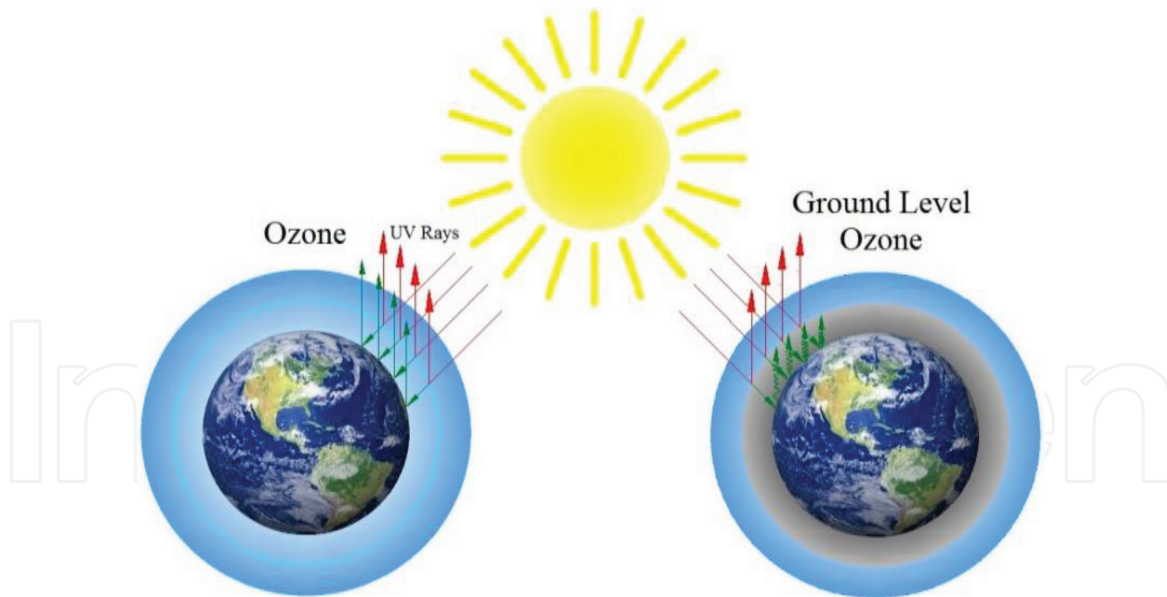

Figure 1.
Ozone & ground level ozone and greenhouse effect.

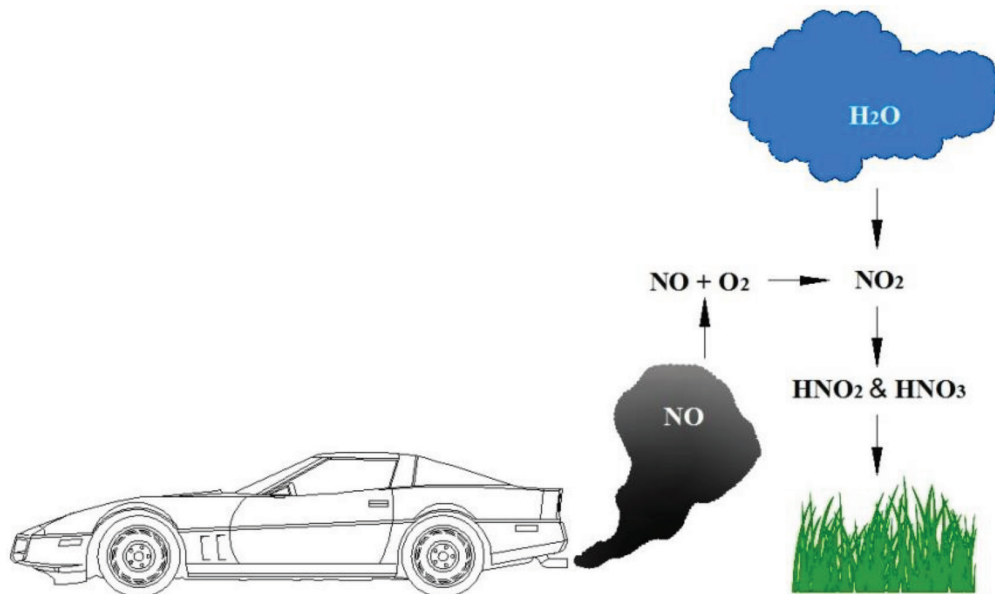

Figure 2.
The formation of acid rains.

that developed to prevent NO_x emissions. Significant work is being done around the world to remove old model vehicles which are far from emissions standards, and which cause high levels of pollutant emissions and leading to serious environmental and human health problems. As a result of established policies and measures taken, in many countries, NO_x emissions and other pollutant emissions have been significantly reduced compared to previous periods [7, 10, 17–19].

2. NO_x emissions from diesel engines

Road transport takes place on the top among sources that bring on the formation of NO_x emissions. Due to its high efficiency and low fuel consumption, diesel engines with a wide range of applications in the transportation sector lead a high rate of NO_x emission. Diesel vehicles play an important role in the formation of NO_x emissions causing air pollution.

There are three different mechanisms of NO_x formation in diesel engines, prompt NO_x, fuel NO_x and thermal NO_x. Prompt NO_x formation occurs because of rapid reactions between the nitrogen, oxygen and hydrocarbon radicals. In case of the presence of nitrogen content in the fuel, the nitrogen contained in the fuel reacts with oxygen and this mechanism defined as fuel NO_x. In the thermal NO_x mechanism, nitrogen and oxygen react at high temperatures and cause NO_x formation [20].

The thermal NO_x mechanism is generally seen as the main source of NO_x formation in diesel engines. The Zeldovich model given below explains this mechanism.



The NO emissions resulting from the reaction (1)–(3) can be converted to NO₂ or back to NO form with the following reactions.

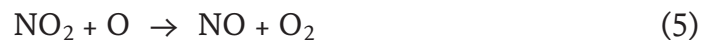

Temperature and oxygen content are the two basic parameters affected the thermal NO_x mechanism. Diesel engines are operated with lean mixtures that had high air excess coefficients. Thus, the combustion process involves more oxygen than necessary. On the other hand, the high compression ratios of diesel engines create high combustion end temperatures in combustion chamber. Therefore, diesel engines offer a very effective infrastructure for the formation of NO_x emissions. Compression ratio and air excess coefficient values of diesel engines are considerably higher than those of gasoline engines. In this case, when compared with gasoline engines, diesel engines causes the generation of NO_x emissions at much higher rates.

When cylinder temperature exceeds about 1500°C, N₂ gas in the air taken into the cylinder reacts with oxygen to form NO_x [21]. Depending on the increase in temperature, NO_x also increase. Each increase of 1% in temperature over 1700°C causes 20% increase in NO_x [22].

Besides the combustion end temperature, thermodynamic conditions, combustion reaction, flame speed and the time that the burned gases exposed to high temperature are the main parameters affected the formation of NO_x emissions. All kinds of engine specifications, which have an effect on these parameters, play an effective role in the formation of NO_x. Some of these specifications include compression ratio, injection system, injection timing, combustion chamber geometry, air excess coefficient, engine speed and fuel composition.

The air excess coefficient, which is the function of the amount of oxygen present in the cylinder, is obtained by dividing the actual air/fuel ratio received into the cylinder to the theoretical air/fuel ratio required to burn a unit fuel. The air excess coefficient is denoted by the symbol λ. When λ is bigger than 1, it means that the mixture inside the cylinder is lean and when it is smaller than 1, it means that the mixture inside the cylinder is rich and when it is equal to 1, it means that it is the stoichiometric ratio. When λ is around 1.1, maximum NO_x formation occurs. As the air/fuel ratio increases above 1.1 and the mixture becomes leaner, the cylinder temperature decreases and NO_x emissions decrease.

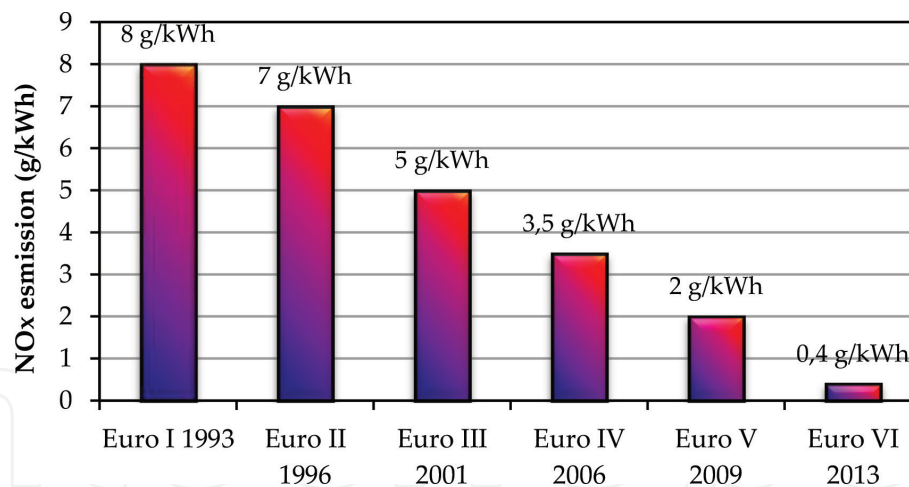

Figure 3.
Euro standards of NO_x emission for heavy-duty vehicles [24].

In diesel engines, a large majority (80–85%) of NO_x emissions formed as a result of combustion are in NO form. Almost all of the NO_x emissions occur during 20 CAD (Crank Angle Degree) following the start of combustion [23].

The fact that diesel-powered vehicles have more widespread use due to their superiority over gasoline-powered vehicles and the ever-increasing number of diesel-powered vehicles leads to a significant increase in NO_x emissions released to the environment.

Figure 3 presents the Euro Standards of NO_x emission for heavy-duty vehicles. The European Union first introduced euro standards for heavy-duty vehicles in 1993 to reduce the damages of NO_x emissions from diesel vehicles on human health and environment.

The amount of NO_x applicable to heavy-duty vehicles under Euro VI standards, which has been in effect since 2013, has been reduced to 0.4 g/kWh. This value is exactly 92% lower compared to the Euro III standard which was implemented in 2001. It is aimed to reduce the amount of NO_x to below 0.1 g/kWh in 2023.

Many research and development activities are carried out scientifically or commercially to eliminate NO_x emissions from diesel engines. Developed methods for reducing NO_x emissions in these activities are divided into pre-treatment and after-treatment methods. Reducing of NO_x emissions before directing to the exhaust port of the engine is called pre-treatment method and reducing of NO_x emissions after directing to the exhaust port of engine is called after-treatment method. Exhaust Gas Recirculation (EGR), electronically controlled fuel injection, engine modification, increasing injection timing, water spray in the combustion chamber, improvement of fuel properties, use of fuel additives, etc. are pre-treatment methods of reducing NO_x emissions. Lean NO_x trap (LNT) catalysts and the Selective Catalytic Reduction System are the examples of after treatment methods. This study focuses on Exhaust Gas Recirculation (EGR), Lean NO_x trap (LNT) catalysts and Selective Catalytic Reduction (SCR) systems, which have been developed to prevent NO_x emissions and which are widely used in diesel engines. Since they are the most effective methods for eliminating NO_x emissions, these three systems are focused on. Each NO_x emission control system is addressed in detail in the light of current information.

3. Exhaust gas recirculation (EGR)

EGR is a system developed to incorporate some of the exhaust gases in the cylinder into the combustion process with the intake air. The purpose here is to lower the

combustion end temperature and thus the NO_x emission values by deteriorating the combustion performance, because high temperature is the main influence in the formation of NO_x emissions. The use of the EGR system reduces the amount of oxygen in the cylinder, and therefore resulting in a decrease in the combustion end pressure and temperature. The decrease in the amount of oxygen suppresses the formation of NO_x . The exhaust gas recirculated in the cylinder and containing large amounts of CO_2 and H_2O increases the specific heat capacity of the intake charge, and this reduces the temperature values in the compression and combustion processes [25]. Displacement of some of the oxygen content in the intake charge by the exiting exhaust gases reduces the air excess coefficient and increases the ignition delay by diluting the intake charge. This slows the mixture of oxygen with fuel and therefore the combustion rate.

The EGR system developed to reduce the combustion end temperature in the cylinder has been widely used by automobile manufacturers since the past. The circulation of the exhaust gas with the intake air can be achieved in two different ways; external and internal [26]. In the external exhaust gas recirculation, the exhaust gas taken from the exhaust manifold is sent to the intake stream through a valve and a coolant. In the internal exhaust gas recirculation, unlike the external exhaust gas recirculation, some of the combustion exhaust gas is withdrawn to the combustion chamber before exiting the exhaust valve. This is accomplished by delaying the camshaft and closing the exhaust valves a little later than normal. The late closing of the exhaust valve allows the piston to draw a portion of the exhaust gas at the outlet of the exhaust valve into the cylinder while the piston is moving downward at intake stroke. The engines, which have the internal EGR systems, are run with variable valve timing. Compared with external EGR, the internal EGR system remains weak in controlling exhaust gas into the cylinder. In addition, since no cooling operation can be performed on the recirculated exhaust gas, desired reductions in NO_x emission values are not achieved. The internal EGR system is generally preferred for gasoline engines, which have lower NO_x emissions compared to diesel engines. On the other hand, external EGR systems are widely used in diesel engines.

Figure 4 shows the structure of a conventional EGR system used in diesel engines. The system simply consists of valve, control unit and coolant. The EGR valve mounted on the intake manifold is controlled by the control unit. The function of the EGR valve is to control the flow of exhaust gas to intake port depending on the engine load. The amount of exhaust gas sent to the intake port may constitute a maximum of 50% of the air taken into the combustion chamber [27]. Because of the high exhaust gas content included in the combustion, the combustion performance is greatly affected; therefore the engine performance can decrease significantly. For this reason, the exhaust gas content mixed with the intake air does not exceed 20% in practice.

The cooling of the exhaust gas included in the combustion process in the EGR system allows the higher amount of exhaust gas to be included in the combustion process and at the same time the combustion chamber temperature and hence NO_x emissions can be further reduced. For this reason, in the EGR systems, the exhaust gas is passed through a cooler and sent to the intake stream. Cooling is carried out using engine coolant. In an electronically controlled cooling system, the cooling process is optimized depending on different engine loads, temperatures and conditions.

In turbocharged diesel engines, the use of EGR takes place in two different ways; high pressure and low pressure. In a high-pressure EGR system, the exhaust gas is recirculated to the intake channel before the exhaust gas goes to the turbine and in the low-pressure EGR system the exhaust gas is recirculated after passing through the turbine.

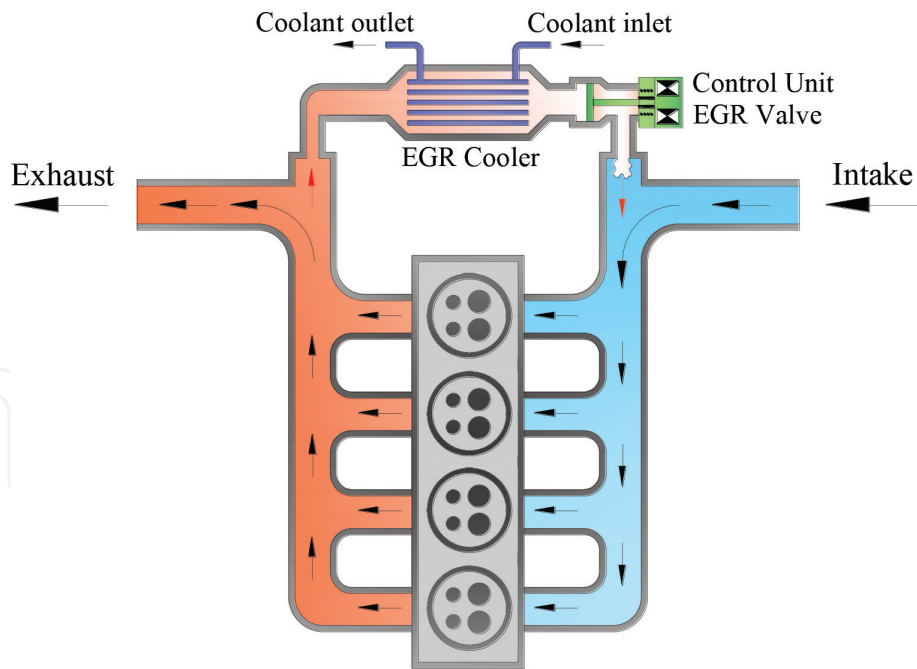

Figure 4.
 Exhaust gas recirculation (EGR).

Thanks to the EGR system, the NO_x emission in diesel engines can be reduced by up to 50% [26]. However, in this method, combustion is worsened, engine performance decreases, and other pollutants, especially particulate emissions (PM) slightly increases. At the same time, the EGR system leads to an increase of about 2% in fuel consumption [28]. Due to the flow of the exhaust gas, EGR system can affect the quality of lubrication oil and the engine durability negatively, and erosion on piston rings and cylinder liner can increase [29]. These disadvantages and developed after-treatment emission control technologies have overshadowed the EGR system [30].

4. Lean NO_x trap (LNT)

Lean NO_x trap (LNT) technology, also referred to as NO_x absorber catalyst (NAC), NO_x storage catalyst (NSC) or NO_x storage/reduction (NSR) catalyst, is a method used to convert NO_x emissions at particularly low exhaust gas temperatures. At low exhaust gas temperatures, NO_x emissions in the exhaust gas content are absorbed at the catalyst surface and released when the exhaust temperature reaches high values.

Coating surface in LNT catalyst consists of an oxidation catalyst, an absorbent combined with alkali metals and a reduction catalyst. In LNT catalysts, there is usually Platinum and Rhodium supported by Al₂O₃ structure with component that has a NO_x storage property such as barium carbonate (BaCO₃). The reactions in the LNT catalyst occur in two different cycles; lean and rich. In the lean cycle, NO is absorbed into the storage component and converted to NO₂ by being oxidizing on the catalyst surface and stored in the nitrate form on the surface. In the rich cycle, the stored NO_x is released from the surface and converted to N₂ on the catalyst surface via CO, HC and H₂, which are formed due to incomplete combustion. All of the reactions taking place in the LNT catalyst are given in Eqs. (6)–(11).

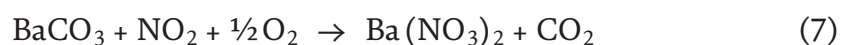

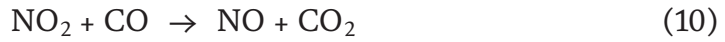
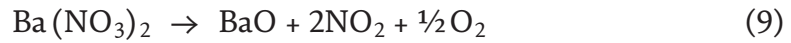
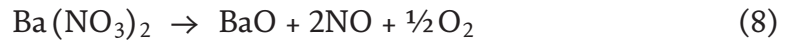

In Eq. (6), NO emissions at low exhaust gas temperatures are oxidized on the Platinum catalyst and converted to NO₂ form. NO₂ emissions are then absorbed in the Barium nitrate form, which has a storage feature of NO_x emissions (Eq. (7)). When the storage capacity is full, regeneration is started by increasing the exhaust gas temperature to high levels. During the regeneration process, the stored nitrogen compounds become thermodynamically unstable and decomposed into NO and NO₂ forms (Eqs. (8) and (9)). In the presence of CO, HC and H₂, the released NO and NO₂ components are then reacted on catalyst to form N₂.

Increasing the exhaust gas temperature for regeneration in LNT systems can be achieved by injecting extra diesel fuel or hydrogen into the cylinder. Since diesel engines have lean mixture, HC is included externally by being injected into the exhaust gas. In the LNT technology, the amount of injected fuel, injecting timing and the ability of the catalyst to store NO_x are parameters that must be optimized to ensure fuel economy.

Although LNT technology is a suitable solution for NO_x conversion at low exhaust gas temperatures, it has some disadvantages. LNT catalysts usually contain precious metals such as Pt at high level to increase the oxidation process of NO emissions and to ensure their continuity. However, this situation increases the cost. At the same time, LNT catalysts need the supply of NO₂ with NO oxidation to provide storage. For this reason, they do not have high NO_x storage efficiency at exhaust gas temperatures below 150°C. On the other hand, Nitrates (NO₃) formed as a result of storage are highly stable and they need to be decomposed in rich operating conditions for reacting of NO_x emissions with reductants such as HC, CO and H₂ on the catalyst surface to form N₂. This affects the fuel economy negatively, and undesirable increases can happen in CO, HC and PM emissions. In the LNT catalysis, NO_x adsorption can be poisoned by sulfur compounds and this undesirable sulfur poisoning causes the catalyst to lose its properties. Sulfur poisoning can be removed by desulphurization at exhaust gas temperatures of 600–750°C. This increases fuel consumption and other pollutant emissions. The use of low sulfur diesel fuel (ULSD) reduces sulfur poisoning and the frequency of desulphurization. To overcome these disadvantages of LNT catalysts, different catalyst types such as Ce, Palladium and different methods have been investigated [31].

LNT technology has a wide range commercial application worldwide. Yang et al. [30] indicated that the LNT technology was adapted to more than half a million vehicles by many manufacturers, including VW and BMW. Up to 90% conversion efficiency at the low engine loads and its combination with the SCR system has raised the use of LNT technology in market.

5. Selective catalytic reduction of NO_x emissions

The selective catalytic reduction of NO_x emissions was dates back to 1970s but was used commercially in heavy-duty vehicles in 2005 [32, 33]. In the selective

catalytic reduction process, NO_x emissions in the exhaust gas are converted to N₂ and H₂O via a reducing agent. NH₃-SCR and HC-SCR systems, where NO_x emissions are eliminated by the use of ammonia and hydrocarbons, are the most widely used technologies.

5.1 Selective catalytic reduction of NO_x by Ammonia (NH₃-SCR)

In SCR systems, ammonia (NH₃) which is generally highly efficient is used as reducer. Ammonia is obtained from aqueous urea solution called AdBlue in the market to prevent burning due to high exhaust gas temperatures. The aqueous urea solution consists of 67% purified water (H₂O) and 33% urea solution ((NH₂)₂CO). Aqueous urea solution (AdBlue) is the most commonly used reductant in SCR systems. Particularly at high exhaust gas temperatures (350–450°C), NO_x emissions in exhaust gas can be eliminated at high rates using AdBlue [34]. However, at low exhaust gas temperatures below 200°C, the conversion efficiency is underperforming and ammonia accumulates on the exhaust line and the catalyst surfaces. Temperatures above 600°C are a major problem for the NH₃-SCR system. Because high temperatures can cause the reductant to burn before reaching the catalyst, and at the same time cause catalyst deformation. The active operating range of the NH₃-SCR system is between 200 and 600°C exhaust gas temperatures. A maximum conversion efficiency can be achieved about 350°C [35].

Figure 5 visually shows the reactions that occur when the aqueous urea solution is sprayed onto the exhaust gas.

In NH₃-SCR system, the aqueous urea solution sprayed on the exhaust gas is first subjected to thermolysis and hydrolysis reactions under the influence of high temperature (Eqs. (12) and (13)). These reactions result in the production of two molecules of ammonia from one molecule urea.

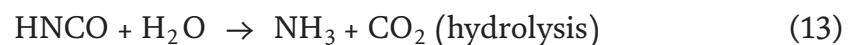
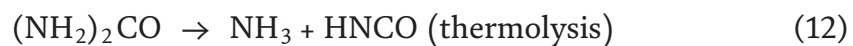

The main reactions occurring in the system after the thermolysis and hydrolysis reactions are given in Eqs. (14)–(16).

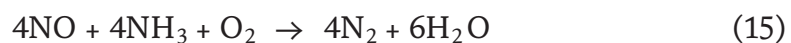

Eq. (14) provides the highest conversion efficiency in the conversion reactions taking place in the NH₃-SCR system. This reaction usually takes place when a diesel oxidation catalyst (DOC) is present before the NH₃-SCR system. DOC converts NO emissions to NO₂ form and when the content of NO and NO₂ in the exhaust gas get close to each other, higher efficiency is achieved in the NH₃-SCR system. Therefore, NH₃-SCR system usually needs DOC and they are used together in applications. Eq. (15) occurs when there isn't any DOC before the NH₃-SCR system and NO emissions are included with large amount in the exhaust exit. If the DOC catalyst

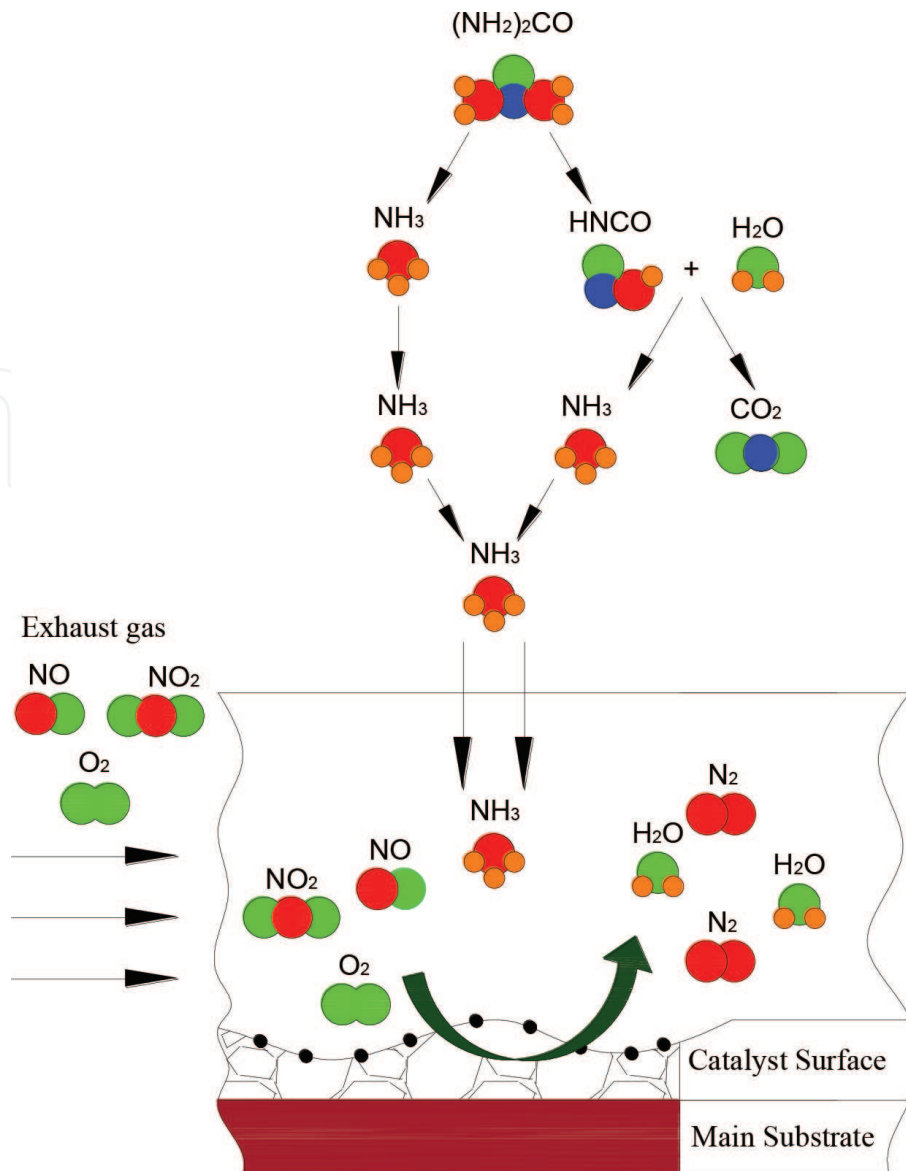

Figure 5.
NO_x conversion reactions in NH₃-SCR.

is larger than the necessary and consequently the vast majority of NO emissions are converted to NO₂, the Eq. (16) is realized. In terms of efficiency, this equation exhibits the worst conversion performance [36].

Figure 6 presents a schematic view of a classical NH₃-SCR system. In this system managed by an electronic control unit, the data from the NO_x and temperature sensors is evaluated and injector sprays the reductant with an optimized rate onto the exhaust gas.

Thanks to the NH₃-SCR system, diesel engines can be operated at high combustion end temperatures, thus resulting in improved engine performance and fuel consumption. With the use of the NH₃-SCR system, fuel consumption can be reduced by 5% [37].

Metal oxides and zeolites are the most commonly used catalyst types in NH₃-SCR systems. Metal oxide catalysts are a group of catalysts produced from metals such as vanadium and titanium ($\text{V}_2\text{O}_5\text{-WO}_3/\text{TiO}_2$), which operate efficiently generally between 250 and 400°C [38]. When compared to metal oxide catalysts, zeolite catalysts are capable of operating in the high temperature range of 400–550°C [39]. While $\text{V}_2\text{O}_5\text{-WO}_3/\text{TiO}_2$ catalysts were preferred for commercial use of NH₃-SCR in the vehicles in 2005, Fe-zeolites began to be used more widespread in the period after 2010 [40]. In addition to these catalysts, Cu-ZSM5 and Ag/Al₂O₃ catalysts

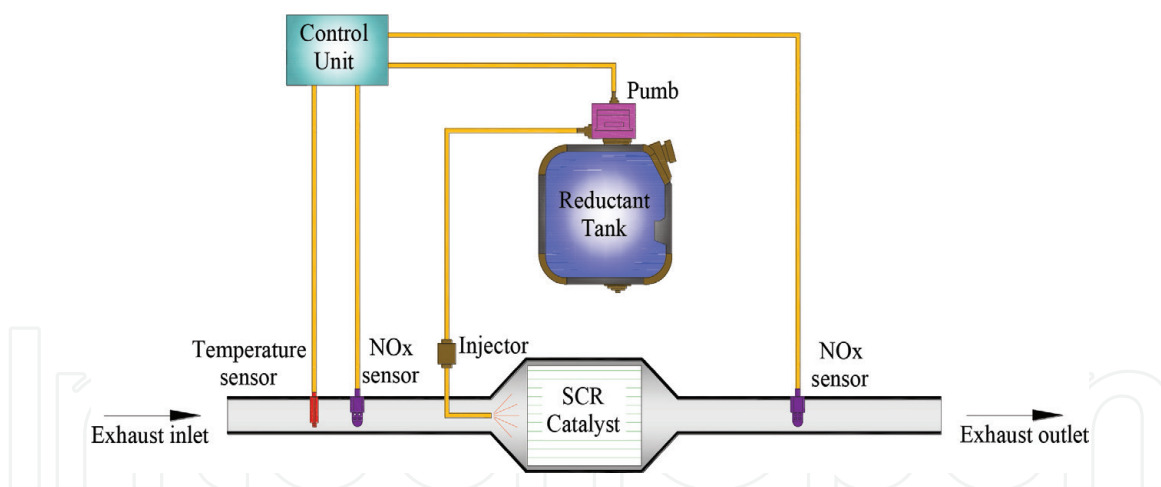

Figure 6.
NH₃-SCR system.

may be preferred in applications. In particular, Ag/Al₂O₃ catalysts can exhibit high performance at low exhaust temperatures.

Cost, an extra storage that it requires and the space that it takes up on the vehicle are the biggest problem in using the NH₃-SCR system. However, as a result of the studies performed in the NH₃-SCR system, it is achieved that a volume reduction of 60%, a weight reduction of 40% and a cost reduction of 30% when compared to 2010 [41]. Low efficiency at low exhaust gas temperatures, ammonia slip, lifetime, adaptation to different operating conditions, integration with other oxidation and particulate filter systems are the negative aspects of NH₃-SCR systems. In addition, the NH₃-SCR system requires a pre-catalyst (DOC) because they exhibit the best performance while NO/NO₂ ratio is 1.

Even if NH₃-SCR system has been developed for heavy-duty vehicles in general, it is widely used in many automobiles thanks to innovations (electronic injection, etc.) in the system [42]. NH₃-SCR is the most effective system to meet the NO_x emission values determined by the organizations in the current situation [40]. In addition, the fuel consumption of engine improves with the use of NH₃-SCR system.

5.2 Selective catalytic reduction of NO_x by hydrocarbons (HC-SCR)

When compared to NH₃-SCR, HC-SCR systems have stayed in the background due to their low efficiency, but the catalysts in which hydrocarbons are used as reductant have been developed since 1980 [33].

As an alternative to NH₃ reductant in SCR systems, the use of HCs improves the performance of the SCR system at low temperature. The use of diesel fuel or unburned HCs in the exhaust stream simplifies the system and reduces the cost. In addition to diesel fuel, oxygen-containing HCs such as ethanol, methanol, and propanol are highly effective in NO_x conversions [43].

The NO_x conversion reactions occurred in HC-SCR systems are given below.



HC-SCR system is an up-to-date field of study, where many researches has been made on. The studies have focused especially on the development of catalysts

for HC-SCR systems. Ag/Al₂O₃ catalysts are the most preferred type of catalyst in HC-SCR systems. Besides, silver, gold, copper, platinum, rhodium, cobalt and iron-based zeolites are used as catalysts in HC-SCR systems [44].

In the HC-SCR systems where conventional Ag-containing Al₂O₃ structures are used as catalysts, NO_x conversions exceeding 80% can be achieved in the temperature range of 350–500°C. At the same time, these structures are very resistant to the adverse effects of water and sulfur. It is even indicated that the sulfur formation on the silver catalyst enhances the conversion efficiency [45]. In Ag-containing catalysts, hydrogen accelerates the oxidation of HC, thereby increasing NO_x conversion efficiency. In addition, the use of hydrogen increases NO_x conversion efficiency at low temperatures by retaining radicals in reducing NO_x emissions [46].

The conversion efficiency of NO_x emissions in HC-SCR systems varies depending on the HC and NO_x ratio in the exhaust gas content. That the amount HC is 2–4 times higher than NO_x emission can provide conversion in NO_x emissions up to 80%. However, in diesel engines, the exhaust gas does not contain HC in this amount. Therefore, the amount of HC in the exhaust gas content must be provided by enriching the mixture during combustion or spraying it directly on the exhaust gas [47]. Direct injection of HC's onto the exhaust gas can be controlled by different parameters via an injector and control unit. Increasing the amount of HC in the exhaust gas content by enriching the mixture in the engine is an indirect method and high NO_x conversion efficiency cannot be obtained.

6. Conclusion

NO_x emissions and the air pollution resulting from it are not the precepts of the countries. Establishing policies, making regulations, taking the necessary measures and making them sustainable for reducing pollutant emissions, especially NO_x emissions in the world, will prevent air pollution and global warming and thus the world will become more liveable in terms of environment and human health.

Although diesel engines cause high level NO_x emissions in the combustion stage, these harmful gases can be disposed of at very high rates by improving the emission control systems before and after the engine.

Although the EGR system which is one of the pre-engine emission control systems can provide up to 50% NO_x conversion, it is inadequate to provide the desired emission values. In the present case, the desired reductions in NO_x emissions can be achieved with post-engine emission control systems.

In post-engine control systems, NO_x emissions can be reduced in the desired level without any reduction in engine performance due to the catalysts used. LNT and SCR technologies are effective post-engine emission control systems used in NO_x disposal.

In LNT technology, NO_x emissions absorbed at low exhaust temperatures are released at high exhaust gas temperatures and reacted with HC, CO and/or H₂ and converted to nitrogen. LNT technology can especially provide suitable solutions for light duty vehicles. However, LNT systems doesn't have high NO_x storage capacity, it is highly susceptible to sulfur poisoning and it needs rich operating conditions for regeneration process. These problems restrict the efficiency of LNT system.

Thanks to SCR technology, high conversion rates can be achieved in NO_x emissions. Today, the SCR system is the most efficient of the post-engine emission control systems used to reduce NO_x emissions. However, even though the SCR systems perform well at temperatures above 200°C, they do not perform well when the exhaust gas temperature is below 200°C during initial operation of engine.

In SCR systems, performance at low exhaust gas temperatures can be avoided by an LNT catalyst used before the SCR system. LNT catalysts provide the conversion of NO_x pollutants in SCR system by absorbing NO_x emissions at low exhaust temperatures and releasing NO_x emissions when the exhaust temperature reaches high levels. While the LNT catalyst has high NO_x absorptive ability at low exhaust temperatures, NO_x conversion performance of the SCR system is low. At high exhaust gas temperatures, while the LNT catalyst has low NO_x absorptive ability, NO_x conversion performance of the SCR system is high. For this reason, the two systems complement each other and NO_x emissions can be controlled both at low exhaust gas temperatures and at high exhaust gas temperatures. With the combined use of SCR and LNT technologies, NO_x emissions can be eliminated in all operating conditions.

In the years to come, it is inevitable that emissions standards put into effect by various organizations for diesel vehicles will be further strict in order to prevent air pollution and global warming caused by it. In this sense, researches on emission control systems will maintain their continuity for a long time. Future standard values to be determined can only be achieved with post-engine emission control systems. The use of post-engine emission control systems is essential to ensure the desired emission values.

Future studies to be performed on NO_x emission control methods will focus on optimizing NO_x control systems, lowering cost, creating simpler structures, increasing engine efficiency, and increasing NO_x conversion efficiency at low exhaust temperatures. The findings and innovations to be achieved as a result of these studies will enable the development of more environmentally friendly diesel vehicles.

IntechOpen

Author details

İbrahim Aslan Reşitoğlu
Department of Automotive Technology, Technical Sciences Vocational School,
Mersin University, Mersin, Turkey

*Address all correspondence to: aslanresitoglu@gmail.com

IntechOpen

© 2018 The Author(s). Licensee IntechOpen. Distributed under the terms of the Creative Commons Attribution - NonCommercial 4.0 License (<https://creativecommons.org/licenses/by-nc/4.0/>), which permits use, distribution and reproduction for non-commercial purposes, provided the original is properly cited. 

References

- [1] World Health Organization. 9 out of 10 People Worldwide Breathe Polluted Air, but More Countries Are Taking Action [Internet]. 2018. Available form: <https://www.who.int/news-room/detail/02-05-2018-9-out-of-10-people-worldwide-breathe-polluted-air-but-more-countries-are-taking-action> [Accessed: Jun 15, 2018]
- [2] Deschenes O, Greenstone M, Shapiro JS. Defensive investments and the demand for air quality: Evidence from the NO_x budget program and ozone reductions. NBER Working Paper No. 18267. Aug 2012. DOI: 10.3386/18267
- [3] Organisation for Economic Co-operation and Development. The Economic Consequences of Outdoor Air Pollution. Paris: OECD Publishing; 2016. 17 p. DOI: 10.1787/9789264257474-en
- [4] Canadian Council of Ministers of the Environment. Management Plan for NO_x and VOCs. Canadian: CCME Publishing; 1990. 176 p
- [5] New York City Community Air Survey. New York City Trends in Air Pollution and its Health Consequences. New York: NYC Health; 2013. 15 p
- [6] Department for Environment Food & Rural Affairs. Air Pollution in the UK 2015. UK: DEFRA; 2016. 115 p
- [7] Gjorgjeva S, Pietarila H. Macedonian air quality assessment report for the period 2005-2015. Skopje: Ministry of environment and physical planning and Macedonian environmental information center; 2017. 68 p
- [8] European Environmental Agency. Air Quality in Europe—2017 Report. Denmark: EEA; 2017. 74 p
- [9] World Health Organization. Health Risk Assessment of Air Pollution—General Principles. Copenhagen: WHO Regional Office for Europe; 2016
- [10] Astrom S, Gustafsson T, Lindblad M, Stigson P, Kindbom K. Estimating Air Pollution Emission Abatement Potential in Sweden 2030. Sweden: IVL Swedish Environmental Research Institute; 2013. 36 p
- [11] Agrawal AK, Singh SK, Sinha S, Shukla MK. Effect of EGR on the exhaust gas temperature and exhaust opacity in compression ignition engines. *Sadhana*. 2004;**29**(3):275-284. DOI: 10.1007/BF02703777
- [12] Price K, Jacques J, Pauly T, Wang L. Impact of SCR integration on N₂O emissions in diesel application. *SAE International Journal of Passenger Cars—Mechanical Systems*. 2015;**8**(2):526-530. DOI: 10.4271/2015-01-1034
- [13] Langton LL, Pinner HQ, Ho H. Lethal and Illegal: Solving London's Air Pollution Crisis. London: Institute for Public Policy Research; 2016. 51 p
- [14] Mendola P, Wallace M, Hwang BS, et al. Preterm birth and air pollution: Critical windows of exposure for women with asthma. *The Journal of Allergy and Clinical Immunology*. 2016;**138**(2):432-440. DOI: 10.1016/j.jaci.2015.12.1309
- [15] Vilcekova S. Advanced Air Pollution: Indoor Nitrogen Oxides. Croatia: InTech; 2011. p 31-50. DOI: 10.5772/16819
- [16] Collette A, Granier C, Hodneborg Q, et al. Future air quality in Europe: A multi-model assessment of projected exposure to ozone. *Atmospheric Chemistry and Physics*. 2012;**12**:10613-10630. DOI: 10.5194/acp-12-10613-2012

- [17] Department for Environment Food & Rural Affairs. Improving Air Quality in the UK: Tackling Nitrogen Dioxide in our Towns and Cities Draft UK Air Quality Plan for Tackling Nitrogen Dioxide. London, UK: DEFRA; 2017. 81 p
- [18] Maryland Department of the Environment. Maryland: Maryland Clean Air 2017 Progress Report. 2017
- [19] Gregory D, Mclaughlin O, Mullender S, Sundararajah N. New solutions to air pollution challenges in the UK. In: London Forum for Science and Policy Briefing Paper. London: Grantham Institute; 2016. 6 p
- [20] Guardiola C, Martin J, Pla B, Bares P. Cycle by cycle NO_x model for diesel engine control. Applied Thermal Engineering. 2017;**110**:1011-1020. DOI: 10.1016/j.applthermaleng.2016.08.170
- [21] Parash SM, Kalam MA, Masjuki HH, et al. Impacts of biodiesel combustion on NO_x emissions and their reduction approaches. Renewable and Sustainable Energy Reviews. 2013;**23**:473-490. DOI: 10.1016/j.rser.2013.03.003
- [22] Seykens X. Development and Validation of a Phenomenological Diesel Engine Combustion Model [Thesis]. Netherland: The Netherlands Eindhoven University of Technology; 2010. 220 p. DOI: 10.6100/IR656995
- [23] Lloyd's Register of Shipping. Emissions of Nitrogen Oxides from Marine Diesel Engines. 2002
- [24] Delphi. Worldwide Emissions Standards—Heavy Duty and Off-Highway Vehicles. Delphi; 2017
- [25] Asad U, Zheng M. Exhaust gas recirculation for advanced diesel combustion cycles. Applied Energy. 2014;**123**:242-252. DOI: 10.1016/j.apenergy.2014.02.073
- [26] Thangaraja J, Kannan C. Effect of exhaust gas recirculation on advanced diesel combustion and alternate fuels—A review. Applied Energy. 2016;**180**:169-184. DOI: 10.1016/j.apenergy.2016.07.096
- [27] Hawley G, Brace CJ, Wallace FJ, Horrocks RW. Handbook of Air Pollution from Internal Combustion Engines: Combustion-Related Emissions in CI Engines. USA: Academic Press; 1998. 663 p. DOI: 10.1016/B978-0-12-639855-7.X5038-8
- [28] Jordal J. Reducing Air Pollution from Ships. Kopenhagen: Danish Ministry of the Environment; 2012. 120 p
- [29] Abd-Alla GH. Using exhaust gas recirculation in internal combustion engines: A review. Energy Conversion and Management. 2002;**43**:1027-1042. DOI: 10.1016/S0196-8904(01)00091-7
- [30] Yang L, Franco V, Campestrini A, German J, Mock P. NO_x Control Technologies for Euro 6 Diesel Passenger Cars-Market Penetration and Experimental Performance Assessment. ICCT White paper, Sep 2015
- [31] Theis JR, Lambert CK. An assessment of low temperature NO_x adsorbers for cold-start NO_x control on diesel engines. Catalysis Today. 2015;**258**:367-377. DOI: 10.1016/j.cattod.2015.01.031
- [32] Jung Y, Shin YJ, Pyo YD, Cho CP, Jang J, Kim G. NO_x and N₂O emissions over a urea-SCR system containing both V₂O₅-WO₃/TiO₂ and Cu-zeolite catalysts in a diesel engine. Chemical Engineering Journal. 2017;**326**:853-862. DOI: 10.1016/j.cej.2017.06.020
- [33] Kass MD, Thomas JF, et al. Selective Catalytic Reduction of diesel engine NO_x emissions using ethanol as a reductant. In: Proceedings of the U.S. Department of Energy 9th Diesel Engine Emissions Reduction Conference; 24-28

August 2003; Newport. Rhode Island: IEEE; 2003. p. 1-8

[34] Liu ZG, Ottinger NA, Cremeens CM. Vanadium and tungsten release from V-based selective catalytic reduction diesel aftertreatment. *Atmospheric Environment*. 2015;**104**:154-161. DOI: 10.1016/j.atmosenv.2014.12.063

[35] Way P, Viswanathan K, Preethi P, Gilb A, Zambon N, Blaisdell J. SCR performance optimization through advancements in aftertreatment packaging. SAE Technical Paper 2009-01-0633. DOI: 10.4271/2009-01-0633

[36] Resitoglu IA, Altinisik K, Keskin A. The pollutant emissions from diesel-engine vehicles and exhaust aftertreatment systems. *Clean Technologies and Environmental Policy*. 2015;**17**:15-27. DOI: 10.1007/s10098-014-0793-9

[37] Cummins. Diesel Exhaust Fluid (DEF) Q & A. Bulletin. USA: Delphi; 2009

[38] Gao G, Shi JW, Liu C, Gao C, Fan Z, Niu C. Mn/CeO₂ catalysts for SCR of NO_x with NH₃: Comparative study on the effect of supports on low-temperature catalytic activity. *Applied Surface Science*. 2017;**411**:338-346. DOI: 10.1016/j.apsusc.2017.03.164

[39] Baranski K, Underwood B. Mitigate Air Pollution with Catalytic Technology. USA: American Institute of Chemical Engineering; 2014. pp. 30-34

[40] Cho CP, Pyo YD, Jang JY, Kim GC, Shin YJ. NO_x reduction and N₂O emissions in a diesel engine exhaust using Fe-zeolite and vanadium based SCR catalysts. *Applied Thermal Engineering*. 2017;**110**:18-24. DOI: 10.1016/j.applthermaleng.2016.08.118

[41] Brezny R. NO_x Reduction from Heavy-Duty Engines. *Motor Vehicle/*

Vessel Emission Control Workshop, Hong Kong. Dec 14, 2016

[42] Marek V, Tunka L, Polcar A, Slimarik D. Reduction of NO_x emission of a diesel engine with a multiple injection pump by SCR catalytic converter. *Acta Universitatis Agriculturae et Silviculturae Mendelianae Brunensis*. 2016;**64**:1205-1210. DOI: 10.11118/actaun201664041205

[43] Björn W, Christian KCU, Ingemar O. Transient modelling of a HC-SCR catalyst for diesel exhaust aftertreatment. *Chemical Engineering Journal*. 2002;**92**:27-39. DOI: 10.1016/S1385-8947(02)00118-3

[44] More PM, Nguyen DL, Granger P, Dujardin C, Dongare MK, Umbarkar SB. Activation by pretreatment of Ag-Au/Al₂O₃ bimetallic catalyst to improve low temperature HC-SCR of NO_x for lean burn engine exhaust. *Applied Catalysis B: Environmental*. 2015;**174-175**:145-156. DOI: 10.1016/j.apcatb.2015.02.035

[45] Jagtap N, Umbarkar SB, Miquel P, Granger P, Dongare MK. Support modification to improve the Sulphur tolerance of Ag/Al₂O₃ for SCR of NO_x with propene under lean-burn conditions. *Applied Catalysis B: Environmental*. 2009;**99**:416-425. DOI: 10.1016/j.apcatb.2009.04.001

[46] Gu H, Chun KM, Song S. The effects of hydrogen on the efficiency of NO_x reduction via hydrocarbon-selective catalytic reduction (HC-SCR) at low temperature using various reductants. *International Journal of Hydrogen Energy*. 2015;**40**:9602-9610. DOI: 10.1016/j.ijhydene.2015.05.070

[47] Piumetti M, Bensaid S, Fino D, Russo N. Catalysis in diesel engine NO_x aftertreatment: A review. *Catalysis, Structure & Reactivity*. 2015;**1**(4):155-173. DOI: 10.1080/2055074X.2015.1105615