

We are IntechOpen, the world's leading publisher of Open Access books Built by scientists, for scientists

4,800

Open access books available

122,000

International authors and editors

135M

Downloads

Our authors are among the

154

Countries delivered to

TOP 1%

most cited scientists

12.2%

Contributors from top 500 universities



WEB OF SCIENCE™

Selection of our books indexed in the Book Citation Index
in Web of Science™ Core Collection (BKCI)

Interested in publishing with us?
Contact book.department@intechopen.com

Numbers displayed above are based on latest data collected.
For more information visit www.intechopen.com



A Critical Review of the Application of Electrochemical Techniques for Studying Corrosion of Mg and Mg Alloys: Opportunities and Challenges

Santiago Fajardo, Federico R. García-Galvan,
Violeta Barranco, Juan C. Galvan and
Sebastian Feliu Batlle

Additional information is available at the end of the chapter

<http://dx.doi.org/10.5772/intechopen.79497>

Abstract

In order to elucidate the corrosion mechanism of Magnesium (Mg), assess its corrosion rate and evaluate the viability of effective corrosion protection methods, a number of different and complementary techniques are required. Aqueous corrosion is, in nature, an electrochemical process and as such electrochemical methods represent a powerful tool for the study of Mg corrosion. In this chapter the main electrochemical techniques used to study the corrosion of Mg are reviewed along with other simple non-electrochemical methods such as weight loss and hydrogen evolution measurements. The electrochemical techniques covered in this review include conventional DC and AC electrochemical techniques and the latest advances in local electrochemical methods for the evaluation and characterization of Mg corrosion. Each technique presented will be discussed, and its major advantages and drawbacks for the study of Mg corrosion will be commented. Applications range from studies of influence of the impurities in catalytic activity of high purity Mg towards hydrogen evolution, the determination of corrosion rate for Mg and Mg alloys by electrochemical methods and electrochemical study of sol-gel films as pre-treatment for Mg alloys.

Keywords: magnesium alloys, corrosion resistance, hydrogen evolution, anodic dissolution, cathodic reaction, electrochemical impedance spectroscopy (EIS), polarization, local electrochemical impedance spectroscopy (LEIS), sol-gel coatings

1. Introduction

Magnesium (Mg) and Mg alloys are materials of great technological interest. Its low density (approximately 1.7 g cm^{-3}) even lower than that of aluminum, combined with good mechanical properties makes them the lightest structural materials [1]. Mg and its alloys are used for a number of different applications such as biomaterial for biodegradable implants, electrode battery material for primary and secondary Mg batteries and casings for electronic devices, among others. Furthermore, the increasing demand of more environmentally sustainable transports, in particular the lightweighting of vehicles, makes Mg alloys excellent candidates for the automotive sector [1].

Despite the increasing technological possibilities of Mg alloys its use has been limited so far due to its high reactivity in aqueous solutions. Mg exhibits the lowest standard reduction potential among all structural metals (approximately -2.4 V vs. SHE). This results in very high corrosion rates when in contact with water [2].

There are a number of methods to assess the corrosion rate of Mg. As with most metals, the most common are weight loss measurements. This simple and well-established method is based in determining the difference in weight of the specimen under study before and after it is immersed in an aggressive electrolyte for a certain amount of time [3]. However, this method presents some important limitations [4]. The first one is that it only provides the average corrosion rate, not allowing for differences in the oxidation kinetics to be determined. Secondly, it can lead to inaccuracies in corrosion rate determination as a consequence of a poor or an excessive corrosion product removal post immersion.

Another common procedure to assess the corrosion rate of Mg alloys is the hydrogen collection method. In this method the rates associated with the HER in a quiescent electrolyte are determined [5]. The primary cathodic reaction in Mg dissolution in the absence of an external polarization is the hydrogen evolution reaction (HER). This is due to the very low corrosion potential (E_{corr}) exhibited by Mg and its alloys in solution (between -1.3 and -1.8 V vs. SCE), well below the reversible potential for the HER ($E_{\text{rev,H}}$) that creates a large overpotential for the HER [1]. Under these circumstances the oxygen reduction reaction (normally diffusion limited) does not control the cathodic kinetics and the HER dominates the rates associated with the overall reduction process. Given that at the E_{corr} the rate of oxidation is equal to the rate of reduction, the corrosion rate of Mg can be easily assessed by recording the evolution of H_2 volume with the time of immersion. Please note that in this case, in contrast with the weight loss measurements, the Mg dissolution kinetics is determined indirectly by assessing the rates associated with the main cathodic reaction.

There are two main experimental arrangements for measuring the evolution of H_2 from a dissolving Mg specimen, as shown in **Figure 1**. In the traditional setup (see **Figure 1a**) the H_2 gas volume is collected by a burette attached to a funnel that are placed upside down over the sample and filled with electrolyte. As Mg dissolves the evolved H_2 travels upwards to the top of the burette, displacing the solution so the volume of gas can be easily monitored over time [6]. Even though this setup has been common for a long time it presents important limitations [4]. Recently, Fajardo and Frankel developed a more sensitive setup originally proposed by Curioni [7] in which the evolution of hydrogen is monitored by attaching the specimen to a fully

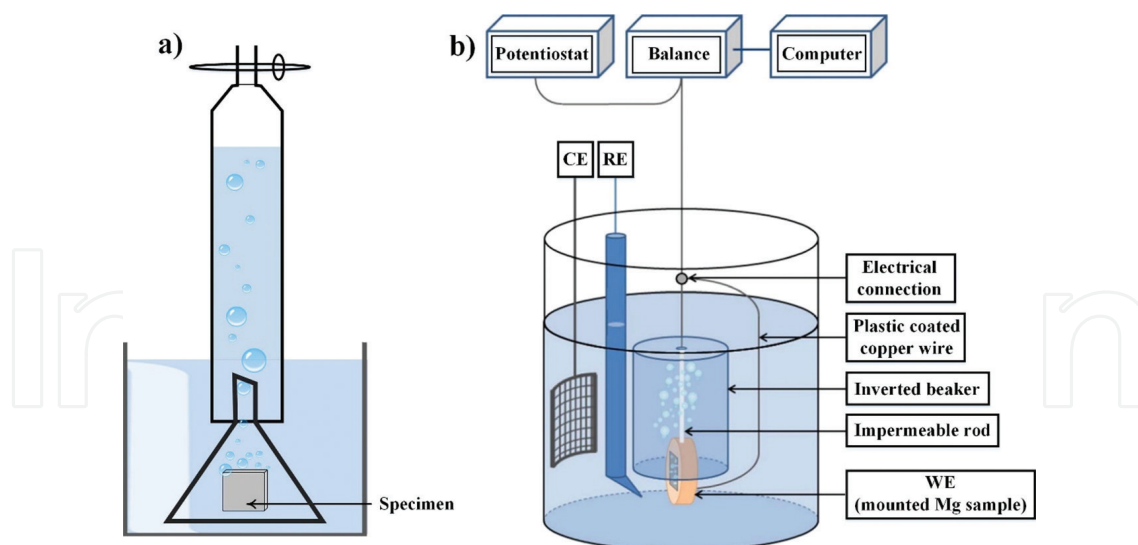

Figure 1. Schematic of the experimental setups for hydrogen gas collection [1]: (a) volumetric method [6], and (b) gravimetric method [5].

immersed container coupled with a high precision balance [5] (see **Figure 1b**). The gas that accumulates at the top of the container changes the apparent weight measured by the balance due to a variation in the buoyant force produced by the volume of solution displaced by the evolved H_2 .

Besides weight loss and H_2 volume collection measurements, the electrochemical methods continue to be the most popular in corrosion science and Mg is no exception. This is essentially due to the electrochemical nature of aqueous corrosion. They represent a reliable, rapid and often simple way of assessing many aspects of the corrosion of metals such as kinetics, passivity, etc. Furthermore, the application of electrochemical techniques for the study of Mg corrosion can be used independently or simultaneously with the non-electrochemical methods previously described (among others). In this chapter the main electrochemical techniques that are commonly used in the study of Mg corrosion will be presented. Global electrochemical methods such as potentiodynamic/potentiostatic and galvanodynamic/galvanostatic polarization measurements will be described and critically discussed. Conventional electrochemical impedance spectroscopy (EIS) will be also covered. Furthermore, localized electrochemical methods have shown to be highly useful for the study of many aspects of Mg corrosion and corrosion protection. For this reason, localized electrochemical techniques such as the scanning electrochemical microscopy (SECM), the scanning vibrating electrode technique (SVET), localized electrochemical impedance Spectroscopy (LEIS) and the scanning Kelvin probe (SKP) will be reviewed, among others.

2. Global electrochemical techniques

Mg corrosion in aqueous solutions is in nature an electrochemical process and as such, electrochemical techniques are a powerful tool to assess the corrosion rate of Mg and Mg alloys. In this section, the main global electrochemical techniques used in the study of Mg corrosion, either by the application of a direct current (DC) or an alternating current (AC), will be discussed.

2.1. Direct current (DC) methods

In these electrochemical methods a unidirectional flow of charge is passed through the electrochemical cell either by controlling the voltage and monitoring the current, or vice versa. A three electrode configuration is commonly used. The specimen under study acts as the working electrode, a reference electrode is used to measure the potential of the working electrode, and a counter or auxiliary electrode allows to close the electrical circuit. Finally, a potentiostat/galvanostat is employed to control the electrochemical cell.

2.1.1. Potentiodynamic polarization (PDP) and potentiostatic polarization (PSP) measurements

This is a voltage control technique in which the working electrode is polarized at a fixed rate over a range of potentials (PDP) or remains at a constant value during the entire time of experimentation (PSP). The current flowing through the cell in response to the generated electric field is then recorded. PDP allows to determine the kinetics of the total anodic and cathodic processes when the electrode potential is scanned at potentials above and below the E_{corr} respectively. This is clearly shown in **Figure 2** where the PDP plots of a Mg specimen with 2 different purities are presented [2]. Furthermore, PDP measurements allow for any passive behavior to be detected. This is defined by the potential region in a V vs. log i plot (V being potential and I being current density) where the current remains constant with the increase in the applied anodic potential.

If the electrochemical system is controlled by activation (i.e. the rate limiting step is the charge transfer reaction), it is possible to determine the corrosion current density (analog to the corrosion rate) by extrapolating the straight lines shown in the cathodic and anodic branches of a PDP plot to the corrosion potential. These lines are called Tafel lines and normally extend through a region in a range of about ± 50 to ± 250 mV from the E_{corr} [8]. An example of this protocol is shown in **Figure 3**. In this case the Tafel extrapolation was carried out on pure Mg in phosphate-buffered saline (PBS) using a rotating disc electrode (RDE) [9].

Instantaneous corrosion rate can also be determined by the linear polarization resistance (LPR) method [10]. In this case, the electrode potential is scanned over a much smaller range (normally ± 10 mV vs. E_{corr}) where a linear-like behavior is expected under activation controlled kinetics [8]. **Figure 4** shows the linear polarization resistance plots of a Mg-Y-RE Mg alloy where the grain size varied in a range from 70 to 0.7 μm [11]. The linear regions expected close to the E_{corr} are clearly shown. The slope of the linear region is defined as the polarization resistance (R_p) and is inversely proportional to the corrosion rate, which can be calculated then using the Stern-Geary equation (see Section 3.2) [8]. The major advantage of the LPR method is that it can be considered as non-destructive given the small polarization applied to the electrode in comparison to an extended PDP measurement where the Tafel regions want to be determined.

However, Tafel-extrapolation and the LPR method are not trivial for Mg due to the increasing ohmic potential drop resulting from the continuously increasing flow of current and resistance associated with the HER (occurring both under anodic and cathodic polarization) [1]. At this point is necessary to comment that Mg and its alloys contradict standard electrochemical kinetics, showing increasing rates of HE with increasing anodic polarization [2].

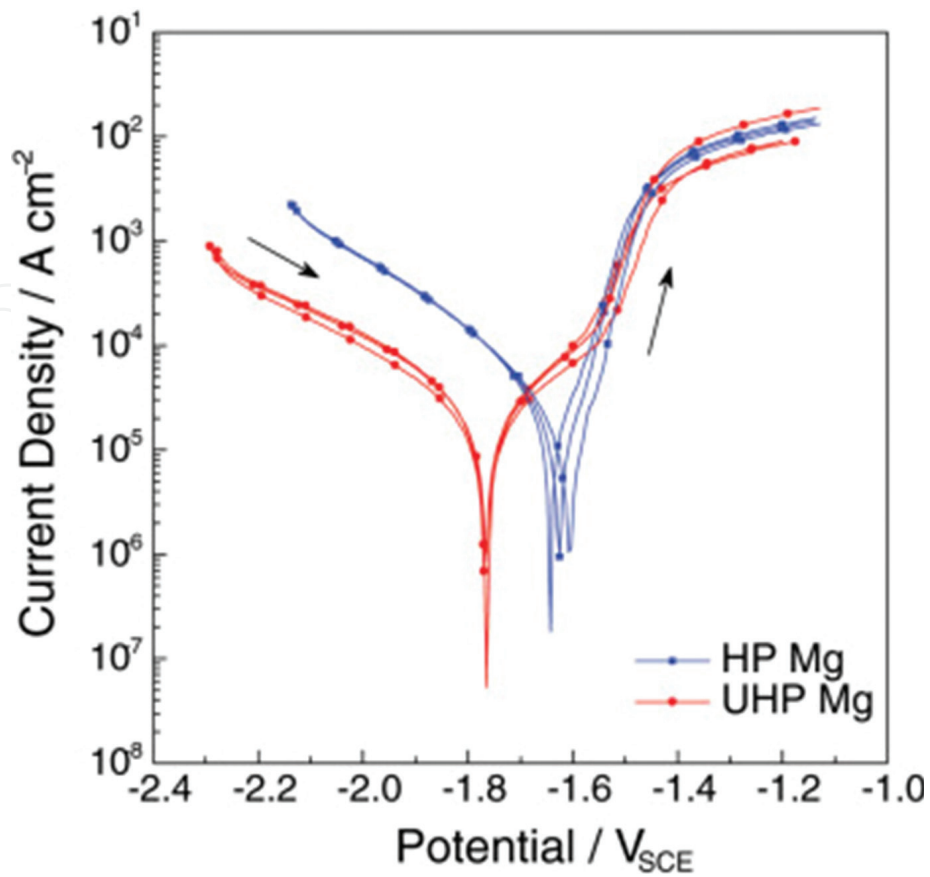

Figure 2. PDP curves of high purity and ultra-high purity (HP and UHP, respectively) Mg in NaCl solution [2].

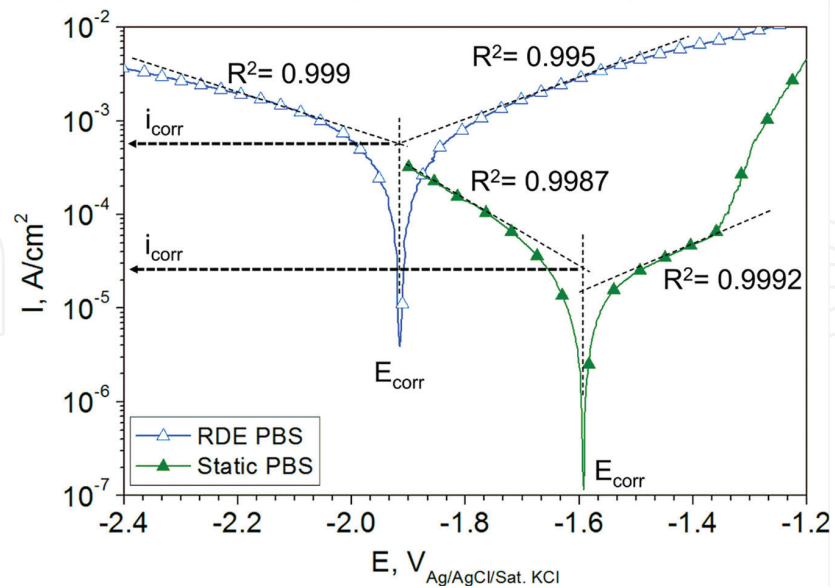

Figure 3. Tafel extrapolation on PDP curves of pure Mg under static and rotating conditions in PBS [9].

This phenomenon, historically referred to as negative difference effect (NDE), opposes the expected behavior for an electrochemical system. According to standard electrochemical kinetics (as exemplified by the Butler-Volmer equation) the rate associated with an electrochemical

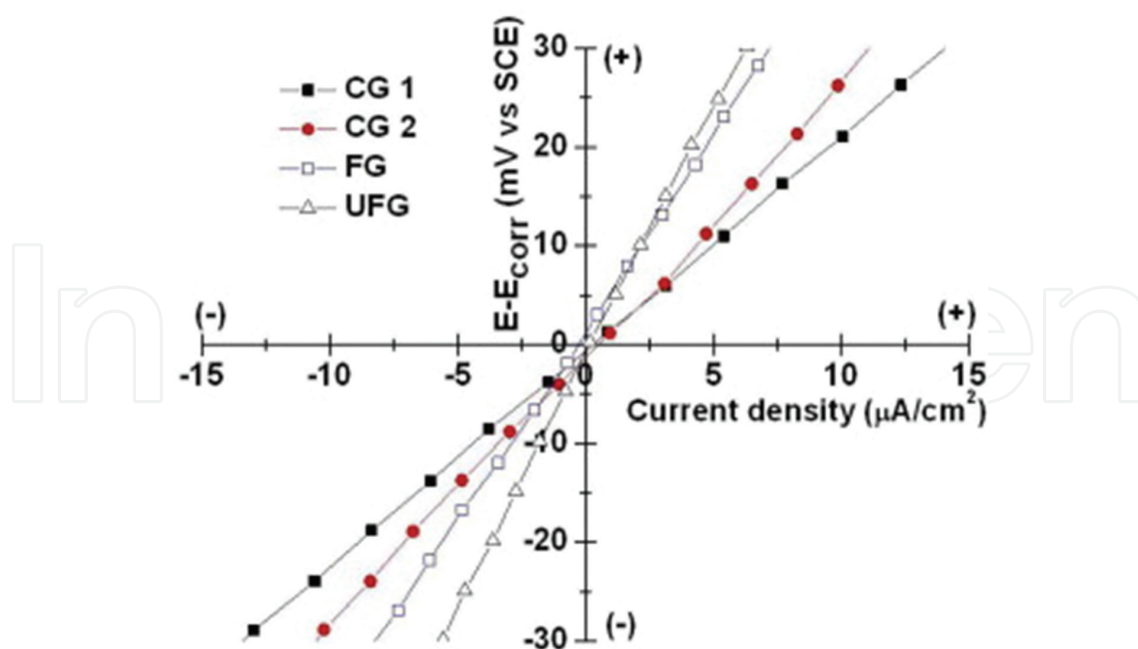

Figure 4. Linear polarization resistance plots of different conditions of Mg–Y–RE alloy in 3.5 wt.% NaCl [11].

half reaction should decrease exponentially with the increase in polarization of the opposite polarity [12]. As a consequence of this anomalous HE, ohmic potential drop effects dominate the shape of the PDP plot, difficulting the identification of the Tafel regions to carry out the extrapolation or distorting the linear-like behavior expected for a LPR measurement [3].

In PSP measurements a constant potential is applied to the working electrode. This method is normally less common than PDP. However, it is useful in some cases like, for example, for the study of the cathodic activation of Mg under anodic polarization [13]. **Figure 5** shows the evolution with time of the measured current density for high purity Mg under PSP at an anodic potential (i.e. more positive than its E_{corr}). As observed, the electrode undergoes a polarity reversal, exhibiting a net cathodic behavior after about 20 min of polarization even if the applied potential is anodic.

2.1.2. Galvanodynamic polarization (GDP) and galvanostatic polarization (GSP) measurements

As opposed to the potential-controlled methods, GDP and GSP measurements are current control techniques. This means that current is either scanned over a certain range or applied at a constant value (i.e. GDP and GSP, respectively) and the potential is measured [8]. Please note that according to standard electrochemical kinetics potential and current are mutually dependent.

Even though galvanodynamic polarization is not a suitable method when the passive behavior of a metallic surface wants to be assessed, GDP and GSP measurements are particularly useful for the study of certain aspects of Mg corrosion. One example is the investigation of the anomalous HE exhibited by anodically polarized Mg. Current control allows for an easy comparison between the current associated with the evolution of H_2 and the applied current density [2, 14, 15]. This has been traditionally evaluated in Mg and Mg alloys using

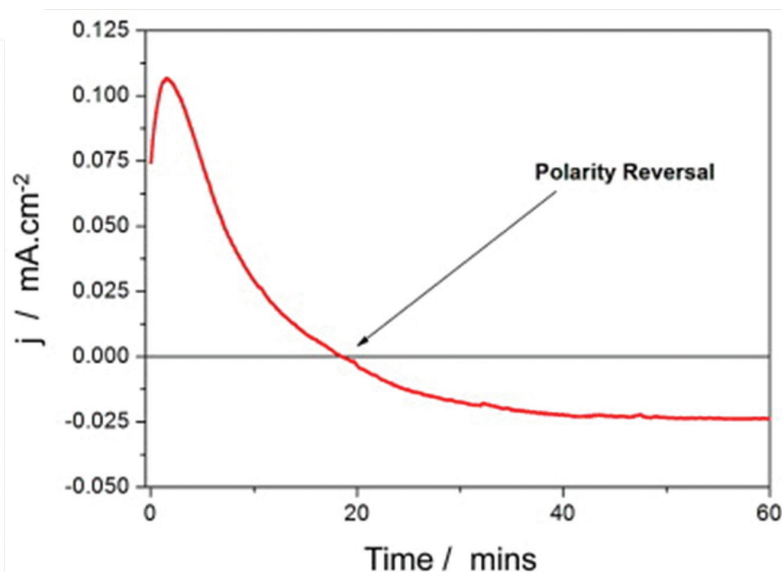

Figure 5. Net current density measured during PSP of high purity Mg at $-1.6 V_{SCE}$ in NaCl solution [13].

GSP, where a constant anodic current density flows through the electrochemical cell and the hydrogen gas volume evolving from the Mg sample is collected. **Figure 6a** shows the volume of H_2 measurements as a function of time determined from gravimetric measurements on ultra-high purity Mg in NaCl solution using GSP under the application of different anodic current densities [14]. From the steady-state rates during GSP the HE current density values can be calculated (see **Figure 6**). The reason for the preferential use of GSP instead of GDP is that it has not been until recently that a hydrogen collection method with a suitable temporal resolution has been available (see Section 1) [5]. Since the development of the gravimetric method for HE, GDP measurements have shown to reliably monitor the real-time evolution of H_2 from a Mg surface. Using GDP instead of GSP allows for an easy determination of the HE current density in a single GDP measurement by interpolation in a HE current density vs. applied current density plot [16] (see **Figure 7**). This has shown to be particularly useful when short timescales are needed or when limited amount of material is available and a large range current densities need to be applied.

Another advantage of using current control methods such as GDP and GSP instead of potential control techniques is that the sample under study can be more reliably polarized before ohmic effects dominate the electrochemical response of the system. Under potential control the large ohmic potential drop associated with the intense HE exhibited both during cathodic and anodic polarization difficult an accurate polarization to a particular potential value. Furthermore, the high reactivity of Mg in aqueous solutions makes it behave like an ideally non-polarizable electrode (i.e. an increase of several orders of magnitude is shown within a small range of applied potentials above the E_{corr}), limiting the region over which the electrode can be effectively polarized. Consequently, if current is controlled instead of potential it is possible to accurately expand the study of the electrochemical behavior of Mg and Mg alloys over a wider range of polarization.

It is also interesting to mention that, due to the anomalous HE exhibited by Mg during anodic polarization, the current densities registered by the potentiostat do not resemble the true dissolution kinetics of Mg. This evolution of hydrogen is a cathodic process and as such, consumes

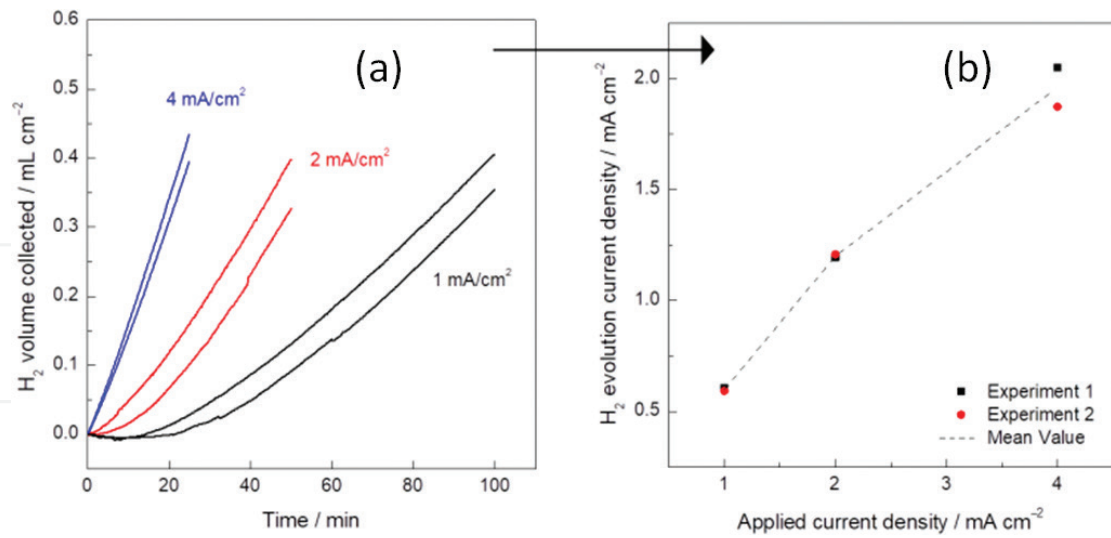

Figure 6. (a) Volume of H₂ determined from gravimetric measurements as a function of time for an ultra-high purity Mg electrode in NaCl solution during a GSP measurement and (b) their corresponding HE current density values (right) [14].

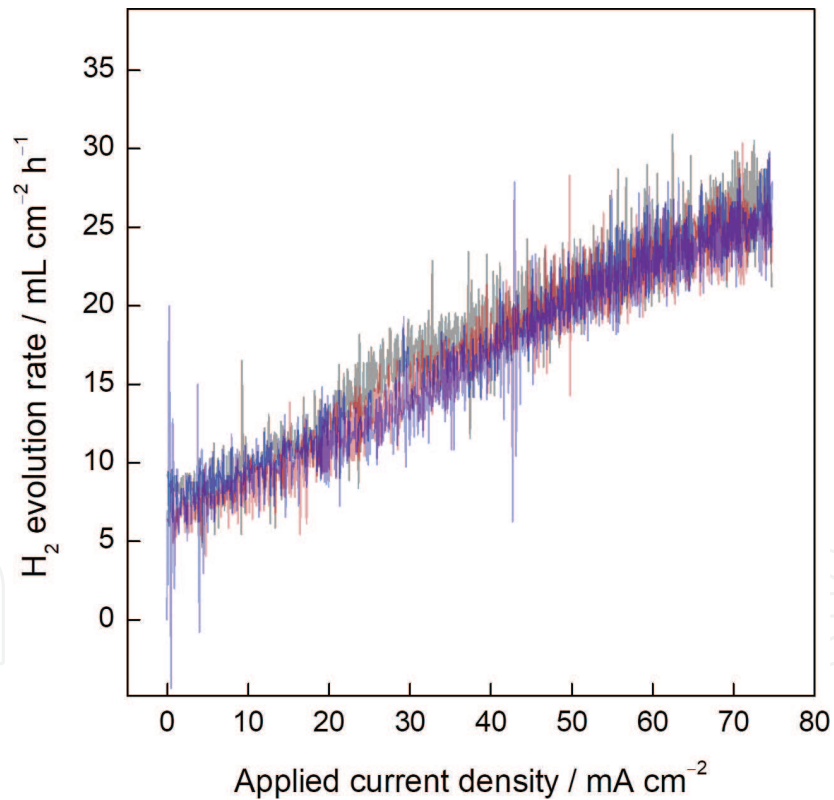

Figure 7. H₂ evolution rates for a high purity Mg electrode in 0.1 M citric acid buffer (pH 3) solution during anodic GDP as a function of the applied current density [16].

electrons. The source of electrons on the anodically polarized surface is the Mg specimen. Please note that these electrons are consumed at the electrode surface and do not flow through the potentiostat. Consequently, the Mg extra dissolution associated with the anomalous HE is not accounted in the current density measured in a simple polarization experiment. To accurately assess the true Mg dissolution kinetics, it is necessary to simultaneously account

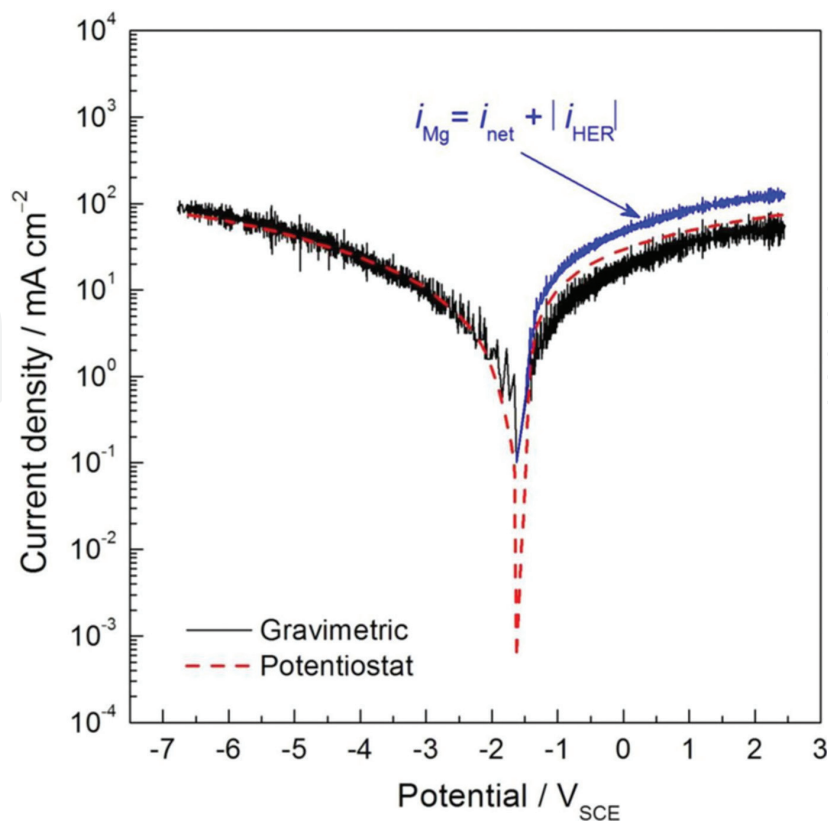

Figure 8. GDP curve of a high purity Mg electrode in NaCl solution as a function of the measured potential [5].

for the real-time HE occurring during polarization. This way, the true current density associated with Mg oxidation will be given by the sum of the net current density measured by the potentiostat (electrons that flow through the electrochemical cell) and the HE current density (consequence of the anomalous HE and measured using a suitable hydrogen collection method) [5] (see **Figure 8**).

In summary, direct current electrochemical methods are a powerful technique to evaluate the electrochemical behavior of Mg and its alloys. They allow for the reaction kinetics and corrosion rate to be determined as well as to assess passivity. Furthermore, they are useful when the evolution of hydrogen is investigated. However, it is necessary to be particularly careful with the ohmic potential drop that is difficult to compensate since they may distort the shape of a polarization curve leading to inaccurate results.

2.2. Electrochemical impedance spectroscopy (EIS) technique

EIS is one of the most widely used technique for investigating in situ the corrosion mechanisms and surface films developed on Mg and alloys specimens in corrosive environments [1, 3, 4, 17–20]. EIS studies are also useful to evaluate the corrosion rate of Mg [1, 3, 17] and to rank the corrosion protective ability of Mg alloys [20].

2.2.1. Advantages

Its most outstanding and well-known advantages are its relative ease of use, the relatively short time taken for measurements, the use of relatively cheap and simple equipment, quantitative

nature, high accuracy and reproducibility of the results [18]. Apart from the quantitative information provided by this technique, the occurrence of corrosion in Mg alloys can also be indicated by the emerging of EIS inductive characteristics long before visual changes can be observed using traditional exposure tests [21].

While polarization curve technique is destructive to the specimen and cannot serve for prediction of the long-term corrosion rates of the material [4], the surface properties of the metal or metal alloy remain similar after each EIS measurement since signals applied have low amplitude (the deviation from corrosion equilibrium was ± 5 to ± 10 mV) and do not alter corrosion potential [18, 21]. The non-destructive character of the impedance technique [19] allows continuous monitoring of the progress of corrosion process in situ, with instantaneous measurements of the corrosion rate and can provide information on the changes of the mechanisms of degradation for the Mg alloys during the immersion period [17–19]. EIS has been considered as an ideal method to evaluate the durability of these alloys [20].

2.2.2. Limitations

A major shortcoming with conventional EIS measurements is associated with the lack of spatial resolution, as the measured impedance results are attributed to the electrochemical response of the global properties of the corroding system, reflecting an averaged electrochemical behavior of the whole electrode [22]. This is a major limitation in the investigation of localized corrosion processes such as passivity breakdown, pitting corrosion and the breakdown of coated systems [22].

Equivalent circuit models using passive electrical engineering and physics circuit elements have commonly been used in order to convert frequency response data to corrosion properties (e.g. resistance and impedance) [4]. However, one of the major weaknesses of this analytical approach arises in how to select the equivalent circuits that not only fit the values, as often multiple equivalent circuits may fit the same data [4], but also provide a meaningful interpretation of the studied interface with quantitative parameters [4].

2.2.3. Typical spectra and equivalent circuits

In our EIS studies about the corrosion of Mg alloys, we reported Nyquist plots characterized by two loops (**Figure 9a**), a capacitive loop at high frequencies (HFs) and an inductive loop at low frequencies (LFs) [18] which can also be observed in corresponding Bode plots (**Figure 9b** and **c**). It is generally agreed that the capacitive loop at high frequencies is always related to the charge transfer resistance as well as the effect of ionic double layer capacitance of the electrode. The equivalent circuit shown in **Figure 10a** was used to simulate the two-time constant impedance spectra in **Figure 9a**. In this circuit, R_s represents the electrolyte resistance, R_1 is the charge transfer resistance, and CPE1 represents the non-ideal capacitive behavior related to the electrical double layer [18]. An inductor (L) and a resistance (RL) have been included to represent the inductive response appearing at low frequency [17–20].

Most of EIS studies about the corrosion of Mg alloys reported impedance diagrams rather complex, exhibiting three loops (**Figure 9d**), a capacitive arc in the high frequency (HFs) region, a capacitive arc in the middle frequency (MFs) region, and one inductive loop in the low frequency (LFs) region [23–26]. This behavior can be confirmed using Bode plots

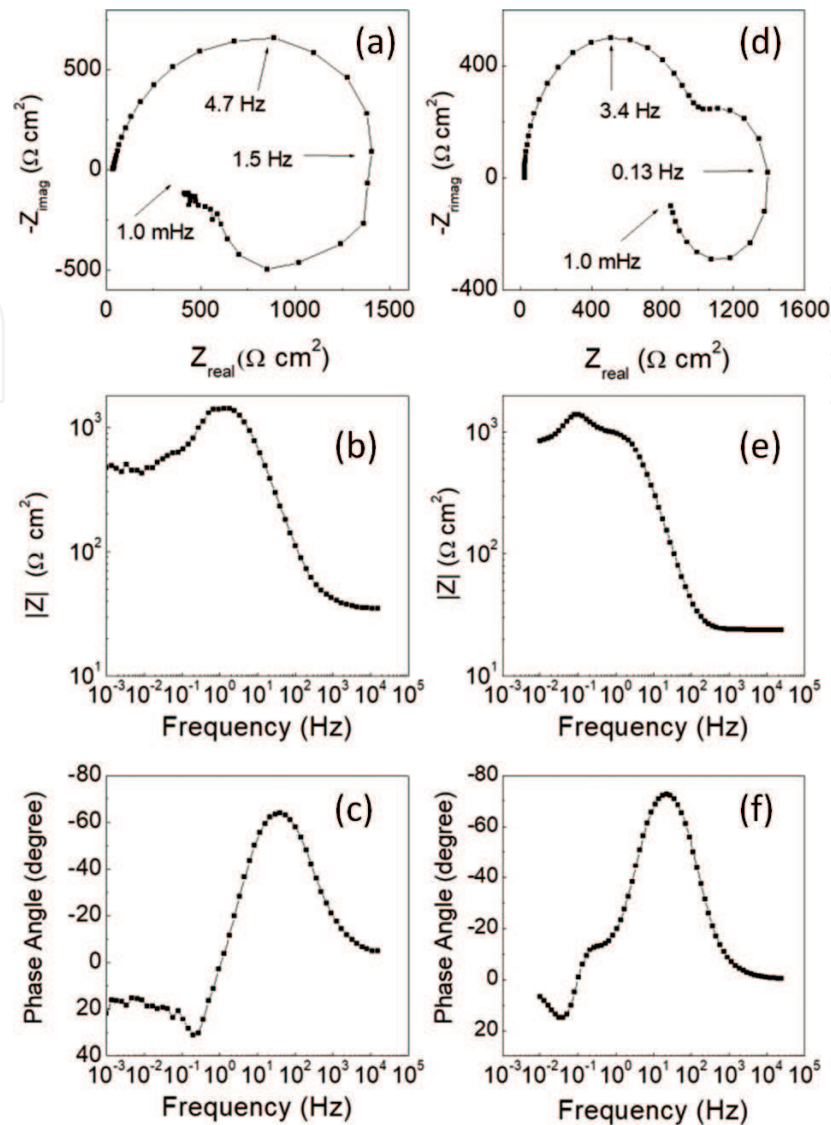

Figure 9. (a, d) Typical Nyquist and (b, c, e, f) bode plots for Mg alloys.

(**Figure 9e** and **f**). In this case, an additional R2/CPE2 model element was introduced in the equivalent circuit (**Figure 10b**). Some studies suggested that the capacitive loop in the HF's may be ascribed to the charge transfer process at the double layer formed at the surface film while the capacitive loop in the MF's accounts for mass transport processes [21, 24, 25]. However, the interpretation of the two characteristic capacitive loops in the high and medium frequency ranges is controversial and unclear [23, 26].

2.2.4. Challenges

Stern and Geary [10] shown that the that the polarization resistance (R_p) is inversely proportional to the corrosion current density in cases when metals behave as electrochemically active

$$i_{\text{corr}} = B/R_p \quad (1)$$

where B is the Stern Geary coefficient that is a function of the cathodic and anodic Tafel slopes (β_c and β_a) [17, 19].

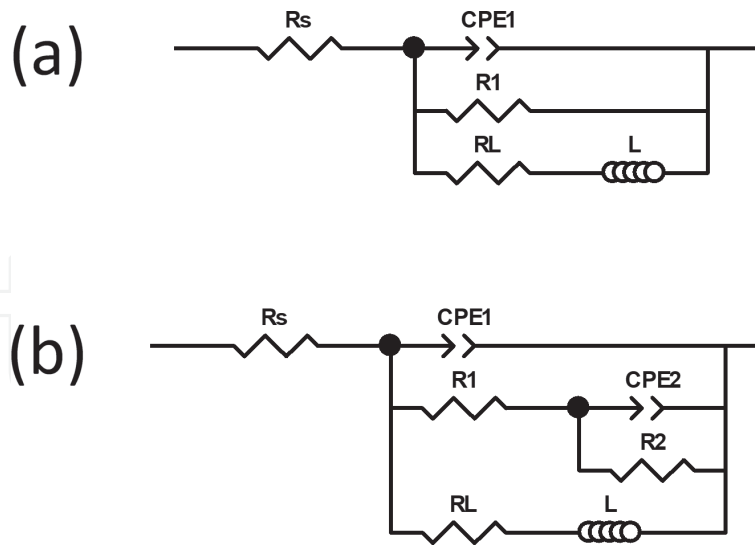

Figure 10. (a) Equivalent circuit used for fitting two-time and (b) three-time constants impedance spectra.

The use of the Stern-Geary equation (1) for the quantitative determination of the corrosion rate for Mg and its alloys presents two main challenges: the precise knowledge of the B constant and the value of resistance obtained from fitting of the EIS spectra selected for the estimation of i_{corr} .

As already commented (**Figure 9a and d**), the impedance diagrams for Mg usually are characterized by a well-marked inductive loop at LF [17]. The inductive behavior is often associated with the occurrence of pitting corrosion caused by anodic dissolution of the Mg and linked to the relaxation of adsorbed intermediates [27]. The disappearance of the inductive loop is caused by the formation of protective corrosion layers on Mg surface which inhibit the pitting corrosion [28]. However, the precise chemical species responsible for the characteristic inductive loop are still unclear [17] and its interpretation remains controversial [19].

2.2.5. Using EIS to monitor corrosion rate

The Nyquist diagrams of AZ31 specimens in NaCl 0.6 M solution display one semi-circle followed by an inductive loop at lower frequency region (**Figure 11a**). After the first hour of immersion in 0.6 M NaCl solution, the charge transfer resistance values, R_t increased markedly, as shown in **Figure 11b** related to the formation of a corrosion layer with major protective ability. Finally, **Figure 11c** compares the variations of EIS-estimated corrosion rate with immersion time obtained by integration of the current density (i_{corr}) vs. time data determined by the evolution of reciprocal R_t over time and the B' values calculated via correlation with gravimetric measurements (**Table 1**). It should be noted that corrosion rates determined from parameter R_t quantitatively agree with the corrosion rate calculated by using independent hydrogen evolution measurement over the whole duration of the measurement (**Figure 11c**).

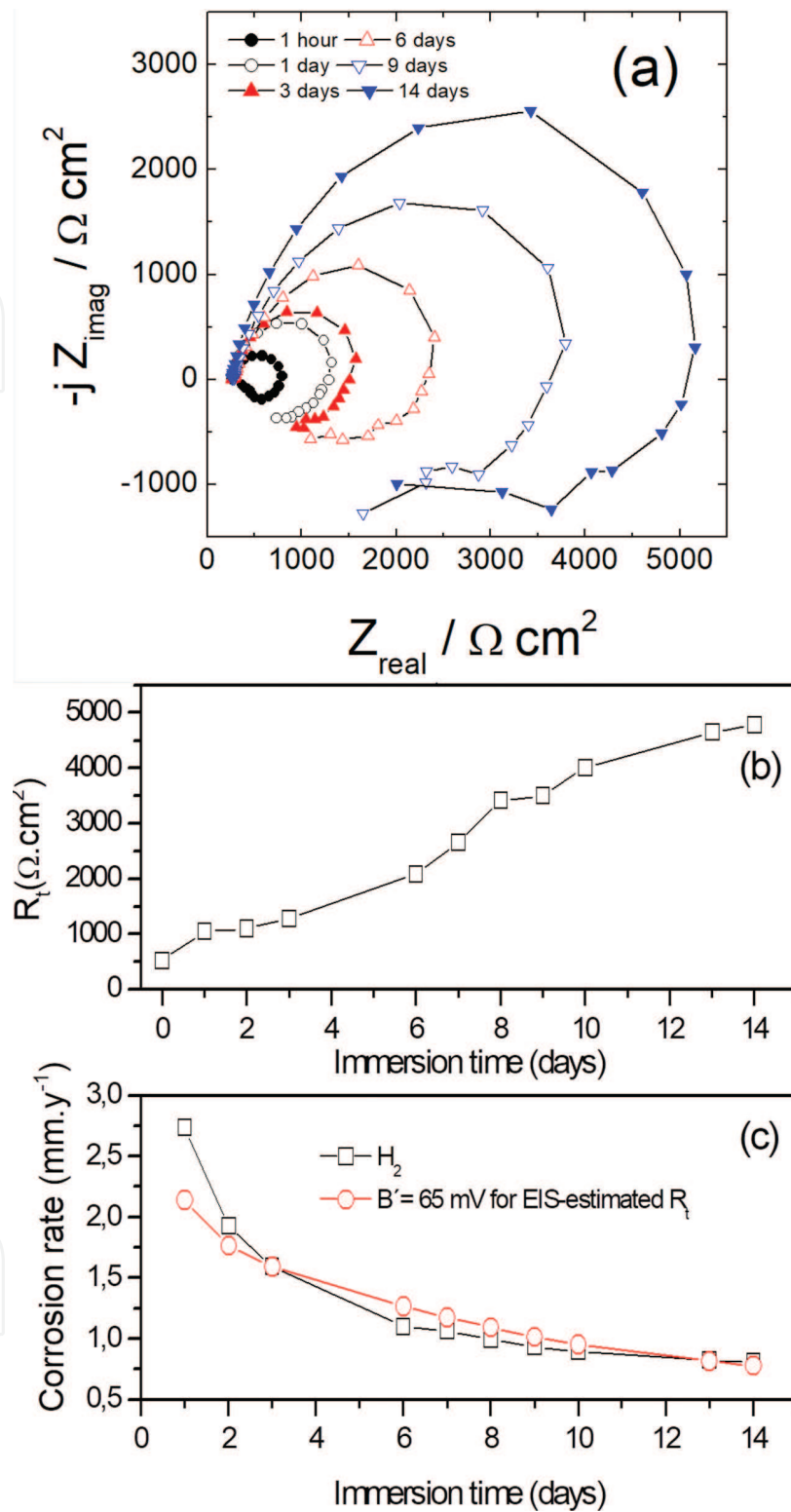

Figure 11. (a) Variation in Nyquist plots for AZ31 sample with immersion time in 0.6 M NaCl solution; (b) evolution of the resistance (R_t) value with immersion time; and (c) variation in corrosion rate ($\text{mm} \cdot \text{year}^{-1}$) as a function of immersion time obtained from hydrogen evolution measurements and EIS during 14 days of immersion in 0.6 M NaCl.

<i>Time</i> (days)	$\int(1/R_t) dt$	P_w (mm.y ⁻¹)	B' (mV)
14	$7.35 \cdot 10^{-3}$	0.78	65

Table 1. 'Apparent' Stern-Geary coefficient calculated from R_t resistance performed in 0.6 M NaCl solutions.

3. Localized electrochemical techniques for studying Mg and Mg alloys

Corroding metallic surfaces present heterogeneous surfaces and that influence their electrochemical activity, including highly reactive sites and/or passive regions. This is the case of Mg and Mg alloys. So, in order to be able to study the different processes that take place on an Mg corroding surface at the micrometer scale (i.e. corrosion initiation, corrosion propagation, corrosion inhibition by smart coatings, etc.) the use of localized electrochemical techniques can provide crucial information not available using solely global electrochemical methods.

Mg, as previously mentioned, is a very reactive metal that readily reacts with water, producing large amounts of H₂ gas. This H₂ evolution leads to a change in the natural convection of the electrolyte and thus in the electrochemistry of the system under study. The exposition time to the aggressive medium is another important factor, since the increase in pH of the solutions, due to the corrosion processes, causes the precipitation of Mg(OH)₂, leading to a further change in the electrochemical activity of the material. In this section the advantages and challenges faced by localized electrochemical techniques to characterize Mg corrosion, will be highlighted, as this remains a complex task.

At present, two different methodologies are applied for local electrochemical investigation:

- a. Scanning techniques, where the whole metal surface is either immersed in aqueous electrolyte [Scanning Electrochemical Microscopy (SECM), Scanning Vibrating Electrode Technique (SVET), Localized Electrochemical Impedance Spectroscopy (LEIS)] or exposed at high humid atmosphere [Scanning Kelvin Probe (SKP)].
- b. Methodologies where only small areas are exposed to the electrolyte using mini or micro capillary electrochemical cells [Scanning Droplet Cell (SDC), Flowing electrolyte type SDC (FT-SDC), Mini Cell System (MCS)].

The scanning techniques can perform a relatively rapid mapping of the studied areas but, generally, highly diluted electrolytes with low conductivity are required in order to achieve good local resolution. Furthermore, the scanned area cannot be locally polarized. The methods of the second group, on the other hand, have the main advantage that concentrate electrolytes can be used and the current resolution is improved down to the pA to fA range, allowing the study of local dissolution processes in the nm-range. Moreover, any DC or AC electrochemical technique can be used to study the surface with localized resolution. The main disadvantage of these methods is, in general, the slow mapping process. Furthermore, the surface conductivity of the studied metallic material plays an important role in the local resolution achieved. Let's continue firstly, showing the applications of these capillary electrochemical techniques and secondly those of the scanning techniques.

3.1. Microcapillary electrochemical techniques

These techniques basically consist in the miniaturization of a three electrode electrochemical cell. The SDC the electrochemical cell is formed by a micro reference electrode, micro counter electrode and a microcapillary filled with the electrolyte solution that will be in contact with a microarea of the working electrode, which is the metallic surface [29]. In certain designs, which are the case of the FT-SDC, the electrolyte solution can also flow through the microcapillary, allowing fresh solution to be brought to the substrate surface. In new configurations of the scanning droplet microscope (FT-SDCM) [30] the gas bubbles or reaction products formed on the surface of the working electrode can be removed using a constant electrolyte flow, which is extremely useful for the study of Mg and its alloys. This represents an improvement with respect to previous experimental setups, because the cell can operate with stagnant or flowing electrolyte. In the study of the heterogeneous microstructured AZ91 alloy, potentiodynamic polarization scans were recorded using microcapillaries of 5–10 μm diameter [31]. The scans recorded at lowest current were associated with the β phase, meaning that this phase was the most corrosion resistant. These results highlight the suitability of the SDC technique for monitoring the electrochemical activity of microstructural feature avoiding the interference from the bulk of the alloy. For the study of the new smart coatings developed for Mg corrosion protection, it is necessary increase the capillary diameter to reduce the big resistances ($\text{M}\Omega$) provided by the coatings when measured in areas of 5–10 μm diameter. The Mini Cell System (MCS) with a geometry pencil like incorporates a three electrode cell with a capillary diameter of 700 μm which allows separate the kinetics of damaged and undamaged areas of a metal/coating system. The MCS has been proved to be extremely useful to characterize new electrochemically active sol-gel thin films applied onto metallic substrates [32, 33].

3.2. Scanning electrochemical techniques

The Scanning Kelvin Probe (SKP) allows the study of localized corrosion processes underneath insulating coatings [34] relevant for the corrosion processes at the polymer-coated metal interface, like swelling and ion incorporation into the coating [35]; the initiation of localized corrosion in defects; and corrosion propagation, caused by anodic or cathodic reactions occurring on the underlying interface. The SKP measures the work-function of a sample using the vibrating condenser method. The major advantage of the SKP in comparison to conventional electrochemical devices is the fact that the SKP measures electrode potentials without touching the surface under investigation across a dielectric medium of high resistance. The measurements are performed in humid atmosphere but in absence of aqueous electrolyte.

The Scanning Electrochemical Microscopy (SECM) uses an ultra-microelectrode (UME) immersed in a liquid electrolyte that bathes the entire metal surface. The UME scans the substrate surface at a fixed height detecting the electrochemical activity on the electrode surface as a consequence of the electrochemical response that the probe experiences when in close proximity with the substrate surface measuring the diffusion-limited current of a redox-active couple (e.g., $\text{Fe}^{2+}/\text{Fe}^{3+}$). With a spatial resolution in the micrometer scale or below allows the discrimination between the activities of different electroactive species by polarizing the UME at a potential of interest [36]. The SECM has shown to be a powerful technique in the study of Mg alloys in simulated biological fluids [37] and the localized corrosion of Mg alloys in NaCl solutions [38, 39] and has been also used to study the phenomenon of anomalous HE [40].

Another non-destructive technique is the Scanning Vibrating Electrode Technique (SVET) that measures the electric field generated by a sample immersed in a solution using a vibrating probe with a fixed amplitude, frequency and height. The scanning vibrating probe detects the potential gradients ohmically produced by local currents originated from actively corroding surfaces immersed in an electrolyte. Scanning is done with a 3D micro-stepping motorized micro-manipulator [41]. The probe vibration is controlled by a piezoceramic displacement device allowing vibration amplitudes from 1 to 30 μm (perpendicular to the sample surface). Calibration then enables quantification of localized cathodic and anodic activity [41, 42].

Scanning Reference Electrode Techniques have increasing their use over the last 30 years in studying the phenomena associated to the localized metallic corrosion. The principles of SVET measurement have been extensively addressed in pioneer works written by Isaacs [43–45]. A basic equation used by Bastos et al. [41, 40], for calculating the current density in solution, i , and describing the operating principle of SVET is

$$i = \kappa E = -\kappa \Delta V / \Delta r \quad (2)$$

which is a form of Ohm's law, where κ is the solution conductivity, E is the electric field in solution and V is the potential difference between two points separated by the distance r in the direction of current flow.

Several examples of the use of SVET in studies of Mg and Mg alloys can be found in renowned works of Williams and McMurray [46]. They have used SVET for studying, for instance, the inhibition of localized corrosion occurring on unpolarized Mg samples immersed in uninhibited aqueous sodium chloride electrolyte [42]. These authors also have used SVET for studying the behavior of a range of potential anionic inhibitors, selected on the basis of their ability to form insoluble precipitates with aqueous Mg^{2+} ions [46]. Their results using SVET for investigating the source of hydrogen evolution from high purity Mg anodically polarized are also significant [14, 16, 47].

Other successful examples of the use of SVET in corrosion studies of Mg alloys are found in several works of Montemor and Ferreira. These authors studied the relation with corrosion

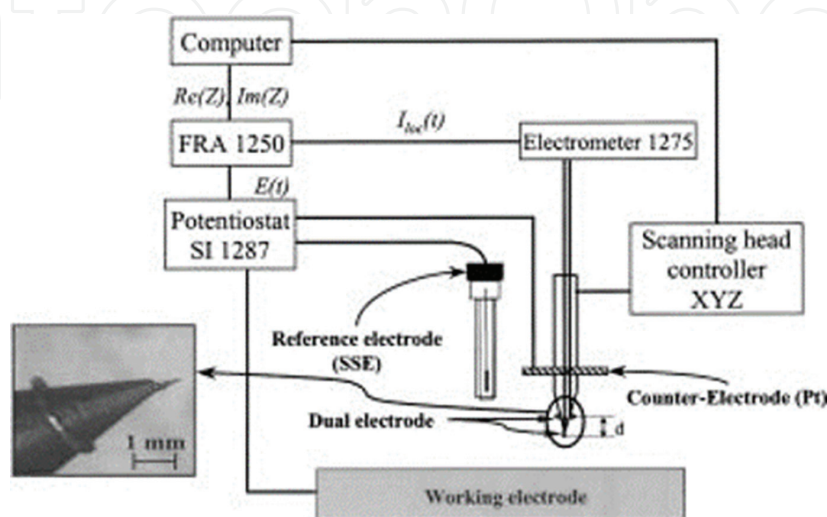

Figure 12. Schematic representation of the LEIS apparatus [56].

protection of pre-treatments consisting in the application of cerium and lanthanum nitrate solutions on AZ31 Mg alloy substrates [48]. Very important contributions of these authors have been their studies with SVET of modified bis-[triethoxysilylpropyl] tetrasulfide silane films on AZ31 alloy and, inhibitor-doped sol-gel coatings (8-Hydroxyquinoline) also on Mg alloy AZ31 substrates [49, 50].

Finally, it is important not to overlook in this section the contributions of the Bierwagen group on the application of SVET to studies of cathodic corrosion protection performance of Mg-rich coatings on aluminum substrates. In such studies coating characteristics were assessed not just using SVET but also multiple electrochemical techniques as SECM, open circuit potential (OCP) measurement, potentiodynamic polarization measurement (PDP) and EIS [51, 52].

Isaacs and Kendig were pioneers in the development of the local electrochemical impedance spectroscopy (LEIS) [53, 54]. This technique is closely related with SVET [55]. Typically, the LEIS method used a five-electrode configuration (**Figure 12**) [56]; a typical three-electrode arrangement (working electrode, counter electrode, and reference electrode) was used to control the dc potential and excite the interface potentiostatically with an ac signal, while two microreference electrodes were used to detect the local potential gradient in solution above the sample surface [57]. The principles of the technique are similar to those used in the conventional bulk EIS; a small sinusoidal voltage perturbation is applied to a working electrode sample and the resulting current is measured to allow the calculation of the impedance. The applied voltage ($\Delta V_{\text{applied}}$) is the potential difference between the working electrode and the reference electrode. The local impedance Z_{local} is calculated by the relationship:

$$Z_{\text{local}} = \Delta V_{\text{applied}} / i_{\text{local}} \quad (3)$$

The local AC current density (i_{local}) is calculated using the Ohm's law:

$$i_{\text{local}} = (\Delta V_{\text{local}} / d) \kappa \quad (4)$$

where ΔV_{local} is the ac potential difference measured between the two probes positioned on and in a conical plastic holder which are separated a distance d , and κ is the conductivity of the electrolyte [56].

Two measurements modes are possible:

- Full local impedance spectrum at one single location (LEIS)
- Area maps of the local impedance of the sample at one frequency (LEIM)

Baril, Galicia and co-workers applied the first measurement mode (LEIS) to study corrosion behavior of pure Mg and AZ91 magnesium Alloy [24, 56, 58]. More recently Barranco, Galvan et al. have applied the second mode (LEIM) to study the corrosion behavior of sol-gel thin films modified with Zr^{4+} and Ce^{3+} ions on AZ9, and doped with organic corrosion inhibitors (benzotriazole and L-cysteine) on AZ31 and AZ61 magnesium alloys [59, 60]. **Figure 13** shows as an example impedance maps (LEIM) recorded around an artificial defect at a fixed frequency (500 Hz) and variable soaking time in 0.006 M NaCl solution for (a) undoped sol-gel film and (b) 0.3% wt.% benzotriazole (BTA) doped sol-gel film deposited on AZ31

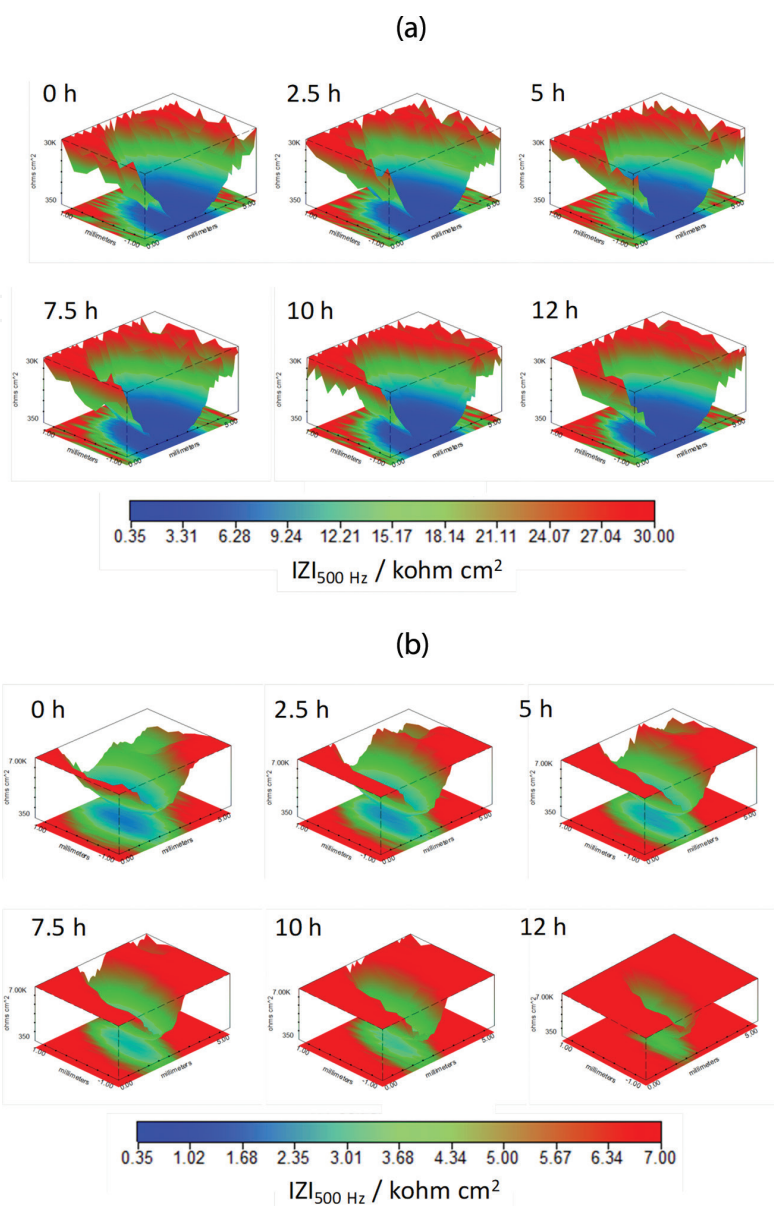

Figure 13. Impedance maps recorded at constant frequency (500 Hz) and variable soaking time in 0.006 M NaCl solution for (a) undoped sol-gel film and (b) 0.3% wt.% BTA doped sol-gel film deposited on AZ31 alloy.

alloy [60]. For the undoped sol-gel films no remarkable differences were observed between the registered impedance maps obtained initially and after longer soak time. In contrast, for BTA doped sol-gel films the LEIS maps showed that around the artificial defect the impedance values increased with soaking time. This effect was ascribed to the gradual release of the BTA from the sol-gel film that caused inhibition of corrosion on the active areas of the magnesium substrate [60].

4. Conclusions

- Global DC methods, comprising potential and current controlled techniques, are versatile tools to assess the corrosion rate of Mg and Mg alloys. They provide relevant

information on the reaction kinetics and passive behavior of these materials. Furthermore, DC methods are particularly suitable for the study of the anomalous hydrogen evolution on anodically polarized Mg when coupled with other non-electrochemical methods such as hydrogen volume collection. The main limitation of the global DC techniques for the study of Mg is that, as a consequence of the intense evolution of hydrogen gas (both under anodic and cathodic polarization) large ohmic potential drops normally dominate the electrochemical response not far from the E_{corr} . For this reason, care should be taken when designing, performing and analyzing the results obtained using these methods.

- EIS is a very powerful tool, non-destructive and sensitive electrochemical technique, to study corrosion processes over time, formation of corrosion products and monitor corrosion rates of Mg alloys. These measurements obtained in a very wide range of frequencies allow us to examine the different processes that determine the corrosion behavior of Mg alloys, from the faster processes that are under charge transfer control, to the slower ones, generally of mass transport control, and inductive characteristics due to adsorption species.
- Localized electrochemical techniques, either that based on surface scanning; LEIS, SVET, SKP and SECM or those based on microcapillaries; SDC, FT-SDC, MCS, have proven to be valuable tools in the study of microareas with different electrochemical activity that exist in Mg alloys due to their microstructure.
- Complementary studies based on multiple global and localized electrochemical techniques are the key to face the challenge of controlling the corrosion of reactive Mg and its alloys for their use in technological applications.

Acknowledgements

The authors gratefully acknowledge the financial support provided by the Ministry of Economy and Competitiveness of Spain (MAT2015-65445-C2-1-R) to carry out the present study. Santiago Fajardo expresses his gratitude to the State Research Agency (Ministry of Economy, Industry and Competitiveness of Spain), the Spanish Research Council (CSIC) and the European Regional Development Fund (ERDF) for the financial support under the Project MAT2015-74420-JIN (AEI/FEDER/UE).

Author details

Santiago Fajardo, Federico R. García-Galvan, Violeta Barranco, Juan C. Galvan and Sebastian Feliu Batlle*

*Address all correspondence to: sfeliu@cenim.csic.es

National Centre for Metallurgical Research (CENIM-CSIC), Madrid, Spain

References

- [1] Esmaily M, Svensson JE, Fajardo S, Birbilis N, Frankel GS, Virtanen S, Arrabal R, Thomas S, Johansson LG. Fundamentals and advances in magnesium alloy corrosion. *Progress in Materials Science*. 2017;**89**:92-193. DOI: 10.1016/j.pmatsci.2017.04.011
- [2] Fajardo S, Frankel GS. Effect of impurities on the enhanced catalytic activity for hydrogen evolution in high purity magnesium. *Electrochimica Acta*. 2015;**165**:255-267. DOI: 10.1016/j.electacta.2015.03.021
- [3] Bland LG, King AD, Birbilis N, Scully JR. Assessing the corrosion of commercially pure magnesium and commercial AZ31B by electrochemical impedance, mass-loss, hydrogen collection, and inductively coupled plasma optical emission spectrometry solution analysis. *Corrosion*. 2015;**71**:128-145. DOI: 10.5006/1419
- [4] Kirkland NT, Birbilis N, Staiger MP. Assessing the corrosion of biodegradable magnesium implants: A critical review of current methodologies and their limitations. *Acta Biomaterialia*. 2012;**8**:925-936. DOI: 10.1016/j.actbio.2011.11.014
- [5] Fajardo S, Frankel GS. Gravimetric method for hydrogen evolution measurements on dissolving magnesium. *Journal of The Electrochemical Society*. 2015;**162**:C693-C701. DOI: 10.1149/2.0241514jes
- [6] Song G, Atrens A, StJohn D. An hydrogen evolution method for the estimation of the corrosion rate of magnesium alloys. In: Hryn JN, editor. *Magnesium Technology*. Hoboken, N.J: John Wiley & Sons; 2001. pp. 254-262. DOI: 10.1002/9781118805497.ch44
- [7] Curioni M. The behaviour of magnesium during free corrosion and potentiodynamic polarization investigated by real-time hydrogen measurement and optical imaging. *Electrochimica Acta*. 2014;**120**:284-292. DOI: 10.1016/j.electacta.2013.12.109
- [8] Frankel GS. Electrochemical techniques in corrosion: Status, limitations, and needs. *Journal of Testing and Evaluation*. 2014;**42**:517-540. DOI: 10.1520/JTE20140289
- [9] Marco I, Van der Biest O. Polarization measurements from a rotating disc electrode for characterization of magnesium corrosion. *Corrosion Science*. 2016;**102**:384-393. DOI: 10.1016/j.corsci.2015.10.031
- [10] Stern M, Geary AL. Electrochemical polarization: I. A theoretical analysis of the shape of polarization curves. *Journal of The Electrochemical Society*. 1957;**104**:56-63. DOI: 10.1149/1.2428496
- [11] Argade GR, Panigrahi SK, Mishra RS. Effects of grain size on the corrosion resistance of wrought magnesium alloys containing neodymium. *Corrosion Science*. 2012;**58**:145-151. DOI: 10.1016/j.corsci.2012.01.021
- [12] Bockris JOM, Reddy AKN. *Modern Electrochemistry*. New York: Kluwer Academic/Plenum Publishing; 2000. p. 1432. DOI: 10.1007/978-1-4613-4560-2

- [13] Birbilis N, King AD, Thomas S, Frankel GS, Scully JR. Evidence for enhanced catalytic activity of magnesium arising from anodic dissolution. *Electrochimica Acta*. 2014;**132**:277-283. DOI: 10.1016/j.electacta.2014.03.133
- [14] Fajardo S, Glover CF, Williams G, Frankel GS. The source of anodic hydrogen evolution on ultra high purity magnesium. *Electrochimica Acta*. 2016;**212**:510-521. DOI: 10.1016/j.electacta.2016.07.018
- [15] Frankel GS, Fajardo S, Lynch BM. Introductory lecture on corrosion chemistry: A focus on anodic hydrogen evolution on Al and Mg. *Faraday Discussions*. 2015;**180**:11-33. DOI: 10.1039/C5FD00066A
- [16] Fajardo S, Glover CF, Williams G, Frankel GS. The evolution of anodic hydrogen on high purity magnesium in acidic buffer solution. *Corrosion*. 2017;**73**:482-493. DOI: 10.5006/2247
- [17] King AD, Birbilis N, Scully JR. Accurate electrochemical measurement of magnesium corrosion rates; a combined impedance, mass-loss and hydrogen collection study. *Electrochimica Acta*. 2014;**121**:394-406. DOI: 10.1016/j.electacta.2013.12.124
- [18] Feliu S, García-Galvan FR, Llorente I, Diaz L, Simancas J. Influence of hydrogen bubbles adhering to the exposed surface on the corrosion rate of magnesium alloys AZ31 and AZ61 in sodium chloride solution. *Materials and Corrosion*. 2017;**68**:651-663. DOI: 10.1002/maco.201609233
- [19] Curioni M, Scenini F, Monetta T, Bellucci F. Correlation between electrochemical impedance measurements and corrosion rate of magnesium investigated by real-time hydrogen measurement and optical imaging. *Electrochimica Acta*. 2015;**166**:372-384. DOI: 10.1016/j.electacta.2015.03.050
- [20] Jamesh M, Kumar S, Sankara Narayanan TSN. Corrosion behavior of commercially pure Mg and ZM21 Mg alloy in Ringer's solution – Long term evaluation by EIS. *Corrosion Science*. 2011;**53**:645-654. DOI: 10.1016/j.corsci.2010.10.011
- [21] Song G-L, Shi Z. Corrosion mechanism and evaluation of anodized magnesium alloys. *Corrosion Science*. 2014;**85**:126-140. DOI: 10.1016/j.corsci.2014.04.008
- [22] Moreto JA, Marino CEB, Bose Filho WW, Rocha LA, Fernandes JCS. SVET, SKP and EIS study of the corrosion behaviour of high strength Al and Al-Li alloys used in aircraft fabrication. *Corrosion Science*. 2014;**84**:30-41. DOI: 10.1016/j.corsci.2014.03.001
- [23] Pinto R, Ferreira MGS, Carmezim MJ, Montemor MF. The corrosion behaviour of rare-earth containing magnesium alloys in borate buffer solution. *Electrochimica Acta*. 2011;**56**:1535-1545. DOI: 10.1016/j.electacta.2010.09.081
- [24] Galicia G, Pébère N, Tribollet B, Vivier V. Local and global electrochemical impedances applied to the corrosion behaviour of an AZ91 magnesium alloy. *Corrosion Science*. 2009;**51**:1789-1794. DOI: 10.1016/j.corsci.2009.05.005

- [25] Baril G, Pébère N. The corrosion of pure magnesium in aerated and deaerated sodium sulphate solutions. *Corrosion Science*. 2001;**43**:471-484. DOI: 10.1016/S0010-938X(00)00095-0
- [26] Cao F, Shi Z, Hofstetter J, Uggowitzer PJ, Song G, Liu M, Atrens A. Corrosion of ultra-high-purity Mg in 3.5% NaCl solution saturated with Mg(OH)₂. *Corrosion Science*. 2013;**75**:78-99. DOI: 10.1016/j.corsci.2013.05.018
- [27] Brett CMA, Dias L, Trindade B, Fischer R, Mies S. Characterisation by EIS of ternary Mg alloys synthesised by mechanical alloying. *Electrochimica Acta*. 2006;**51**:1752-1760. DOI: 10.1016/j.electacta.2005.02.124
- [28] Baril G, Blanc C, Pébère N. AC impedance spectroscopy in characterizing time-dependent corrosion of AZ91 and AM50 magnesium alloys characterization with respect to their microstructures. *Journal of The Electrochemical Society*. 2001;**148**:B489-B496. DOI: 10.1149/1.1415722
- [29] Hassel AW, Lohrengel MM. The scanning droplet cell and its application to structured nanometer oxide films on aluminium. *Electrochimica Acta*. 1997;**42**:3327-3333. DOI: 10.1016/S0013-4686(97)00184-9
- [30] Kollender JP, Voith M, Schneiderbauer S, Mardare AI, Hassel AW. Highly customisable scanning droplet cell microscopes using 3D-printing. *Journal of Electroanalytical Chemistry*. 2015;**740**:53-60. DOI: 10.1016/j.jelechem.2014.12.043
- [31] Krawiec H, Stanek S, Vignal V, Lelito J, Suchy JS. The use of microcapillary techniques to study the corrosion resistance of AZ91 magnesium alloy at the microscale. *Corrosion Science*. 2011;**53**:3108-3113. DOI: 10.1016/j.corsci.2011.05.054
- [32] Barranco V, Carmona N, Villegas MA, Galvan JC. Tailored sol-gel coatings as environmentally friendly pre-treatments for corrosion protection. *ECS Transactions*. 2010;**24**:277-290. DOI: 10.1149/1.3453622
- [33] Mueller WD. Electrochemical techniques for assessment of corrosion behaviour of Mg and Mg-alloys. *BioNanoMaterials*. 2015;**16**:31-39. DOI: 10.1515/bnm-2015-0006
- [34] Grundmeier G, Jüttner K, Stratmann M. Novel electrochemical techniques in corrosion research. In: Cahn RW, Haasen P, Kramer EJ, editors. *Materials Science and Technology*. Weinheim: Wiley-VCH Verlag GmbH & Co. KGaA; 2013. pp. 287-376. DOI: 10.1002/crat.2170300811
- [35] Barranco V, Thiemann P, Yasuda HK, Stratmann M, Grundmeier G. Spectroscopic and electrochemical characterisation of thin cathodic plasma polymer films on iron. *Applied Surface Science*. 2004;**229**:87-96. DOI: 10.1016/j.apsusc.2004.01.046
- [36] Thomas S, Izquierdo J, Birbilis N, Souto RM. Possibilities and limitations of scanning electrochemical microscopy of Mg and Mg alloys. *Corrosion*. 2015;**71**:171-183. DOI: 10.5006/1483
- [37] Jamali SS, Moulton SE, Tallman DE, Forsyth M, Weber J, Wallace GG. Evaluating the corrosion behaviour of magnesium alloy in simulated biological fluid by using SECM

- to detect hydrogen evolution. *Electrochimica Acta*. 2015;**152**:294-301. DOI: 10.1016/j.electacta.2014.11.012
- [38] Liu W, Cao F, Xia Y, Chang L, Zhang J. Localized corrosion of magnesium alloys in NaCl solutions explored by scanning electrochemical microscopy in feedback mode. *Electrochimica Acta*. 2014;**132**:377-388. DOI: 10.1016/j.electacta.2014.04.044
- [39] Izquierdo J, Nagy L, Bitter I, Souto RM, Nagy G. Potentiometric scanning electrochemical microscopy for the local characterization of the electrochemical behaviour of magnesium-based materials. *Electrochimica Acta*. 2013;**87**:283-293. DOI: 10.1016/j.electacta.2012.09.029
- [40] Salleh SH, Thomas S, Yuwono JA, Venkatesan K, Birbilis N. Enhanced hydrogen evolution on Mg(OH)₂ covered Mg surfaces. *Electrochimica Acta*. 2015;**161**:144-152. DOI: 10.1016/j.electacta.2015.02.079
- [41] Bastos AC, Quevedo MC, Karavai OV, Ferreira MGS. Review—On the application of the scanning vibrating electrode technique (SVET) to corrosion research. *Journal of The Electrochemical Society*. 2017;**164**:C973-C990. DOI: 10.1149/2.0431714jes
- [42] Williams G, Neil McMurray H. Localized corrosion of magnesium in chloride-containing electrolyte studied by a scanning vibrating electrode technique. *Journal of The Electrochemical Society*. 2008;**155**:C340-C349. DOI: 10.1149/1.2918900
- [43] Isaacs HS, Vyas B. Scanning reference electrode techniques in localized corrosion. In: Mansfeld F, Bertocci U, editors. *STP727 Electrochemical Corrosion Testing*, American Society for Testing and Materials. Philadelphia: ASTM; 1981. DOI: 10.1520/STP28024S
- [44] Isaacs HS. Limitations of in situ current density mapping for vibrating electrodes close to metal surfaces. *Corrosion*. 1990;**46**:677-679. DOI: 10.5006/1.3585167
- [45] Wilson BP, Searle JR, Yliniemi K, Worsley DA, McMurray HN. Effect of probe tip inclination on the response of the scanning vibrating electrode technique to an idealised pit-like feature. *Electrochimica Acta*. 2012;**66**:52-60. DOI: 10.1016/j.electacta.2012.01.062
- [46] Williams G, McMurray HN, Grace R. Inhibition of magnesium localised corrosion in chloride containing electrolyte. *Electrochimica Acta*. 2010;**55**:7824-7833. DOI: 10.1016/j.electacta.2010.03.023
- [47] Williams G, Birbilis N, McMurray HN. The source of hydrogen evolved from a magnesium anode. *Electrochemistry Communications*. 2013;**36**:1-5. DOI: 10.1016/j.elecom.2013.08.023
- [48] Montemor MF, Simões AM, Carmezim MJ. Characterization of rare-earth conversion films formed on the AZ31 magnesium alloy and its relation with corrosion protection. *Applied Surface Science*. 2007;**253**:6922-6931. DOI: 10.1016/j.apsusc.2007.02.019
- [49] Montemor MF, Ferreira MGS. Electrochemical study of modified bis-[triethoxysilylpropyl] tetrasulfide silane films applied on the AZ31 Mg alloy. *Electrochimica Acta*. 2007;**52**:7486-7495. DOI: 10.1016/j.electacta.2006.12.086

- [50] Galio AF, Lamaka SV, Zheludkevich ML, Dick LFP, Müller IL, Ferreira MGS. Inhibitor-doped sol-gel coatings for corrosion protection of magnesium alloy AZ31. *Surface and Coatings Technology*. 2010;**204**:1479-1486. DOI: 10.1016/j.surfcoat.2009.09.067
- [51] Simões AM, Battocchi D, Tallman DE, Bierwagen GP. SVET and SECM imaging of cathodic protection of aluminium by a Mg-rich coating. *Corrosion Science*. 2007;**49**:3838-3849. DOI: 10.1016/j.corsci.2007.03.045
- [52] Bierwagen G, Battocchi D, Simões A, Stanness A, Tallman D. The use of multiple electrochemical techniques to characterize Mg-rich primers for Al alloys. *Progress in Organic Coatings*. 2007;**59**:172-178. DOI: 10.1016/j.porgcoat.2007.01.022
- [53] Isaacs HS, Kendig MW. Determination of surface inhomogeneities using a scanning probe impedance technique. *Corrosion*. 1980;**36**:269-274. DOI: 10.5006/0010-9312
- [54] Huang VM, Wu S-L, Orazem ME, Pébère N, Tribollet B, Vivier V. Local electrochemical impedance spectroscopy: A review and some recent developments. *Electrochimica Acta*. 2011;**56**:8048-8057. DOI: 10.1016/j.electacta.2011.03.018
- [55] Bayet E, Huet F, Keddam M, Ogle K, Takenouti H. A novel way of measuring local electrochemical impedance using a single vibrating probe. *Journal of The Electrochemical Society*. 1997;**144**:L87-L90. DOI: 10.1149/1.1837562
- [56] Baril G, Blanc C, Keddam M, Pébère N. Local electrochemical impedance spectroscopy applied to the corrosion behavior of an AZ91 magnesium alloy. *Journal of The Electrochemical Society*. 2003;**150**:B488-B493. DOI: 10.1149/1.1602080
- [57] Wittmann MW, Leggat RB, Taylor SR. The detection and mapping of defects in organic coatings using local electrochemical impedance methods. *Journal of The Electrochemical Society*. 1999;**146**:4071-4075. DOI: 10.1149/1.1392593
- [58] Baril G, Galicia G, Deslouis C, Pébère N, Tribollet B, Vivier V. An impedance investigation of the mechanism of pure magnesium corrosion in sodium sulfate solutions. *Journal of The Electrochemical Society*. 2007;**154**:C108-C113. DOI: 10.1149/1.2401056
- [59] Barranco V, Carmona N, Galván JC, Grobelny M, Kwiatkowski L, Villegas MA. Electrochemical study of tailored sol-gel thin films as pre-treatment prior to organic coating for AZ91 magnesium alloy. *Progress in Organic Coatings*. 2010;**68**:347-355. DOI: 10.1016/j.porgcoat.2010.02.009
- [60] Galvan JC, García-Galván FR, Barranco V, Jiménez-Morales A, Feliu S Jr. Waterborne sol-gel coatings doped with corrosion inhibitors for the protection of Mg-Al alloys. In: *Proceedings of the Forty-Second Annual International Waterborne, High-Solids, and Powder Coatings Symposium*; 8-13 February 2015; New Orleans. Raleigh: NC Lulu Press; 2015. pp. 349-365