

We are IntechOpen, the world's leading publisher of Open Access books Built by scientists, for scientists

4,800

Open access books available

122,000

International authors and editors

135M

Downloads

Our authors are among the

154

Countries delivered to

TOP 1%

most cited scientists

12.2%

Contributors from top 500 universities



WEB OF SCIENCE™

Selection of our books indexed in the Book Citation Index
in Web of Science™ Core Collection (BKCI)

Interested in publishing with us?
Contact book.department@intechopen.com

Numbers displayed above are based on latest data collected.
For more information visit www.intechopen.com



Structure-Soil-Structure Interaction between Underground Structure and Surface Structure

Huai-feng Wang

Additional information is available at the end of the chapter

<http://dx.doi.org/10.5772/intechopen.76243>

Abstract

A numerical study is made on the dynamic through-soil interaction between underground station and nearby pile supported surface structure on viscous-elastic soil layer, under vertically incident S wave. This paper focuses on the dynamic interaction and the interactive influence on seismic response of adjacent surface structure and underground structure. To this end, ANSYS has been further developed for calculation in frequency domain, in which hysteretic damping can be considered, so that structure-soil-structure interaction (SSSI) can be investigated via direct methodology. Discussion is made on the influence of arrangement of structures, distances between structures, shaking direction of seismic wave, shear wave velocity and damping of soil, scale and burial depth of underground structure, storey number, stiffness, style and pile length of surface structure on SSSI, in terms of horizontal acceleration of surface structure and horizontal relative displacement of underground structure. Maximum acceleration and displacement is also presented for 12 seismic inputs. Arrangement and shaking direction are two of the most important factors. The response can be either amplified or attenuated according to the distance, related to dynamic properties of the overall system. The underground structure, surrounded by building with the fundamental frequency approximate to that of free field, is heavily affected.

Keywords: structure-soil-structure interaction (SSSI), soil-structure interaction (SSI), underground structure, surface structure, seismic response

1. Introduction

With the increasing narrowing of urban ground development space, plentiful underground space structures have been constructed under the building groups and arterial roads in urban

bustling business districts. Underground structures, such as subway station and underground plaza, have become increasingly common in urban construction, and they are often close to the surrounding high-rise buildings. In the metropolitans, like Kobe in Japan, structures, such as buildings, stations and tunnels, are built closely to each other on the soft soil deposit. Under such circumstances, the dynamic interaction among structures is bound to occur through the radiation energy emitted from a vibrating structure to other structures. Hence, the dynamical characteristics and earthquake response characteristics of a structure are closely related to those of the adjacent structures.

Structure-soil interaction (SSI) is an important research topic in earthquake engineering, which has attracted extensive attention for several decades. As a branch of SSI, structure-soil-structure interaction (SSSI) is a key research topic during recent years. It is an interdisciplinary field of endeavor, which lies at the intersection of soil and structural mechanics, soil and structural dynamics, earthquake engineering, geophysics and geomechanics, material science, computational and numerical methods, and diverse other technical disciplines.

Researches on SSI originate from the vibration problem between machines and foundations, which belongs to the category of linear harmonic vibration. The influence of impedance matrix of foundations and SSI on the machine operation is studied. In the 1960s, studies on anti-seismic safety of nuclear power station hastened researches on the issue of SSI under earthquake action. Owing to the development of numerical calculation theory and computer technology, especially the application of finite element method and boundary element method, effective measures have been provided for seismic analysis on complicated engineering structures considering the influence of SSI. Finite element method is used to handle the problems with irregular field, while boundary element method can process the problems with infinite field conveniently. Due to the finite element-boundary element coupling method, the solution scope of SSI is further expanded. Problems, with complicated shape, flexibility, burial depth of foundation, sheet separation between foundation and base, soil layers, local topography, nonlinear characteristic can be handled via numerical discretization method. In recent years, the issue of SSI under nonlinear analysis conditions has already become the mainstream direction of research work. When various theoretical analysis methods are further studied, model test and prototype test have also attracted increasing attention from scholars, to become the new hotspot of SSI study. With the successful outcome about SSI, various kinds of theoretical methods and experimental installations are used to promote the study of SSSI.

The history and current status of SSSI were elucidated by the author in another paper [1]. A simple introduction will be given here. To the writer's knowledge, it is Luco and Contesse [2] in 1973 to come up with the structure-soil-structure interaction designation for this area of study first. The steady-state response of two parallel infinite shear walls placed on rigid foundations for a vertically incident SH wave is obtained and compared with corresponding values resulting from consideration of only one structure. During this period, analytical method and semi-analytical numerical method were mainly used to study the issue of SSSI,

and most of them were based on elastic half-space theory. Shallow foundation or surface foundation was adopted. Besides, system with single-particle or columnar block was used to simulate the surface structures, and some work gone so far as to simulate the foundation only, without considering the upper structures. Undoubtedly, these researches have laid a solid theoretical foundation for follow-up studies, but still cannot solve practical SSSI problems.

With the rapid development of computer technology, calculation theory, and calculation software, numerical simulation and analysis became the most extensive method to study SSSI. In the 1980s, many researchers began to conduct a study through numerical methods. In 1982, Fu and Yu [3] analyzed the dynamic response of two-dimensional SSSI system placed on elastic half-space by applying substructure method. By simplifying the surface structure into a multi-particle string system, Tian and Yu [4] studied the interaction of two multi-particle systems on the elastic half-space by solving the dynamic impedance function of soil via boundary element method for the first time. In addition, Jiang et al. [5] analyzed the interaction of two multi-particle string systems on homogeneous soil layer via finite element method. According to the results, when the distance between structures is greater than the scope of 2.5 times the structure width, the influence of SSSI can be ignored.

Later, the simulation for surface structures became elaborate. Dou and Yang [6] studied the adjacent 6-storey and 21-storey three-span two-dimensional frame structures by applying finite element method. Padron et al. [7] and Alamo et al. [8] utilized finite element-boundary element coupling method to study the influence of SSSI on transversal, vertical and torsional deformation and shearing force of several 1-storey frames under S wave and Rayleigh wave in frequency domain and time domain. In addition, Fariborz and Ali [9] analyzed the seismic response of contiguous 15-storey and 30-storey steel-frame structures. In order to obtain the dynamic response of two adjacent 12-storey frame-shear wall structures under earthquake action, Li et al. [10] conducted three-dimensional finite element model to analyze adjacent high-rise structures-pile-soil interaction system. Alam and Kim [11] explored the seismic response of two adjacent 3-storey frames considering the spatial effect of seismic oscillation. Moreover, Ghandil et al. [12] studied the applicability of equivalent linearization in SSSI system by simulating soil nonlinearity via equivalent linearization.

The lumped parameter method is a common method used to analyze SSI and SSSI, in which soil is simulated by spring, mass, and damper, or an equivalent impedance function [13]. In 1998, Mulliken et al. [14] firstly made use of this method to present efficient discrete models with frequency-independent masses, springs, and dampers. Each model has modes of vibration considered independent degree of freedom for predicting the dynamic interaction between adjacent rigid surface foundations, which are supported by a homogeneous, isotropic, and linear elastic half-space. This finding is achieved through a proposed modification of the Wilson- θ method; thus, the time-lagging effects due to wave propagation are also considered. Besides, the basic foundation interaction model is extended to the evaluation of coupled building-foundation systems. Moreover, Alexander et al. [15] applied this method to study SSSI effect. After that, Naserkhaki and Pourmohammad [16] probed into the work of Mulliken et al. [14].

Tests are important means for scientists and engineers to improve humans' knowledge about the nature law. In 1980, Mizuno [17] firstly clarified actual phenomena of SSSI by a series of tests such as forced vibration tests, micro tremor or measurements and earthquake observations for a full-scale building and a model structure. In recent years, more tests have been conducted on civil structures. Yin [18] and Kang [19] analyzed the dynamic interaction of underground structure and surface structure through shaking table test and numerical analysis. Besides, Pan et al. [20] conducted a forced vibration tests on two steel frames on the shear soil box. According to the results, in SSSI system, modes of vibration with approximate two frequencies and opposite phase exist, and the frequency of mode corresponding to SSI system is between the two frequencies. In addition, Trombetta et al. [21] conducted a centrifuge test on the 1-storey steel frame and 2-storey shear wall model, which shows that the SSSI effect is relatively obvious when the seismic excitation is low. By simplifying the surface structure into a single-particle system, Xiong et al. [22] conducted a shaking table test on five adjacent single-particle systems on the shear soil box, but the test results are different from the results of Pan et al. [20] and Trombetta et al. [21] in the aspects of dynamic characteristics and seismic response respectively, showing the complexity of SSSI. By simulating the soil with foam and rubber respectively, Aldaikh et al. [23] and Cacciola et al. [24] conducted shaking table tests on several adjacent single-particle systems. Owing to the limitation of test equipment, especially shaking table test, multi-storey structures are often investigated, and soil layer with the depth of 100 m and even several hundred meters cannot be simulated.

Obviously, less attention is paid to the problem of the interaction of adjacent surface structure and underground structure through the underlying and surrounding soil. Many researchers have done a lot of work about dynamic response of underground structure, diffraction and scatter of wave, and effect of seismic field by underground structure, but they have ignored adjacent structure and interaction between them, such as Lee [25, 26], Lin [27], Hatzigeorgiou [28], Abate and Massimino [29]. Guo and Chen [30] studied the influence of subway station on the dynamic response of a nearby 6-storey frame structure by adopting the two-dimensional model. Meanwhile, Yang et al. [31], Li and Zhou [32], and Farghaly [33] explored the influence of subway tunnel on the dynamic response of a nearby frame structure with more than 10 storeys. Abate and Massimino [34–36] investigated the effects of the tunnel on the response of the soil and/or of the building and vice versa. Via full-coupled FEM modeling, a cross-section of the underground network in Catania including an aboveground building was modeled to study its behavior during the expected scenario earthquake ($MS = 7.0-7.4$).

Indeed, more work needs to be done in order to assess the effects of interaction between surface structure and underground structure on general three-dimensional problems with different structural and subsoil configurations, and its associated risks.

In the following sections, the problem is first stated and the parameters and properties are defined. Then, the calculation method and model are briefly outlined. Afterwards, a set of numerical results, in the frequency domain, is presented to assess the effects of building on the seismic response of underground station in terms of its horizontal relative displacement and the effects of underground station on the seismic response of building in terms of its magnification factor of horizontal acceleration. Maximum relative displacement and acceleration responses are also presented for 12 seismic inputs.

2. Problem definition

The system under investigation is composed of one or more common multi-storey frame structures (GS), which is founded on fixed-head pile groups embedded into homogeneous soil layer, and a neighboring typical underground subway station (US), three-dimensionally distributed.

Note that **Figures 1** and **2** are two-dimensional representations of the three-dimensional model used herein. The frame construction plane is shown in **Figure 1** and the cross-section of subway station is presented in **Figure 2**. The mechanical and geometrical properties of surface structure are defined by the following parameters: storey height 3.6 m; number of storey $N_F = 10$; cross section of frame column 600 × 600 mm; cross section of frame beam 250 × 600 mm; cross section of foundation beam 300 × 800 mm; diameter of pile 600 mm; length of pile $H_{pile} = 18m$; thickness of floor slab 150 mm; thickness of base plate 300 mm; concrete modulus 3×10^4 MPa; Poisson ratio of concrete 0.2; damping ratio $\zeta_{GS} = 0.05$. The fundamental period of surface structure is 0.71 s along lateral axis, and 0.67 s along longitudinal axis. The mechanical and geometrical properties of underground structure are defined by the following parameters: burial depth of underground station $H_{bd} = 2m$; length of underground station 72 m; concrete modulus of underground structure 3.45×10^4 MPa; Poisson ratio of concrete 0.2; damping ratio $\zeta_{US} = 0.05$.

On the other hand, the most important parameters to define the soil dynamic behavior are as follows: mass density $1900kg/m^3$; shear wave velocity $c_s = 300m/s$; soil height $H = 60m$; damping ratio $\zeta = 0.05$; Poisson ratio 0.3.

An analysis is made on the dynamic behavior of several problems (of which the different relative arrangements of structures are shown in **Figure 3**, termed as “AR0”–“AR10”) under vertically incident S waves (producing motions on the X axis, termed as “SX”, or Y axis, termed as “SY”) from rigid bedrock. The response of underground structure and surface structure in the group is compared with that of single-underground structure-soil system or single-surface structure-soil system (termed as “AR0”) respectively, in order to find out whether or not SSSI effects between two or more structures can be of importance. Note that in all configurations the distance D between adjacent structures is measured in parallel to X axis and Y axis, and is the same between all structures in the same problem.

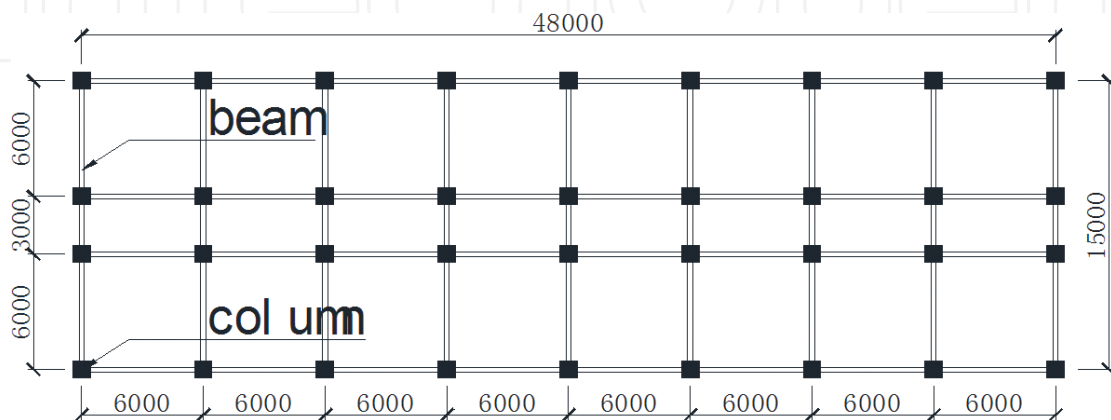

Figure 1. Typical plan of surface structure (unit: Mm).

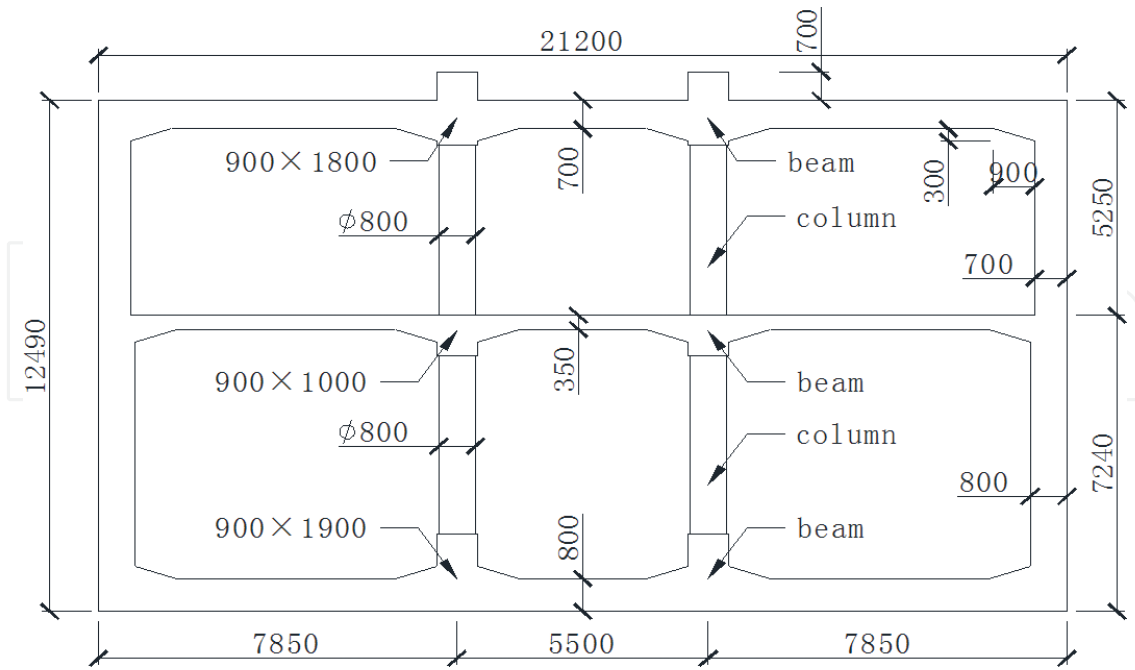

Figure 2. Cross-section of underground station (unit: Mm).

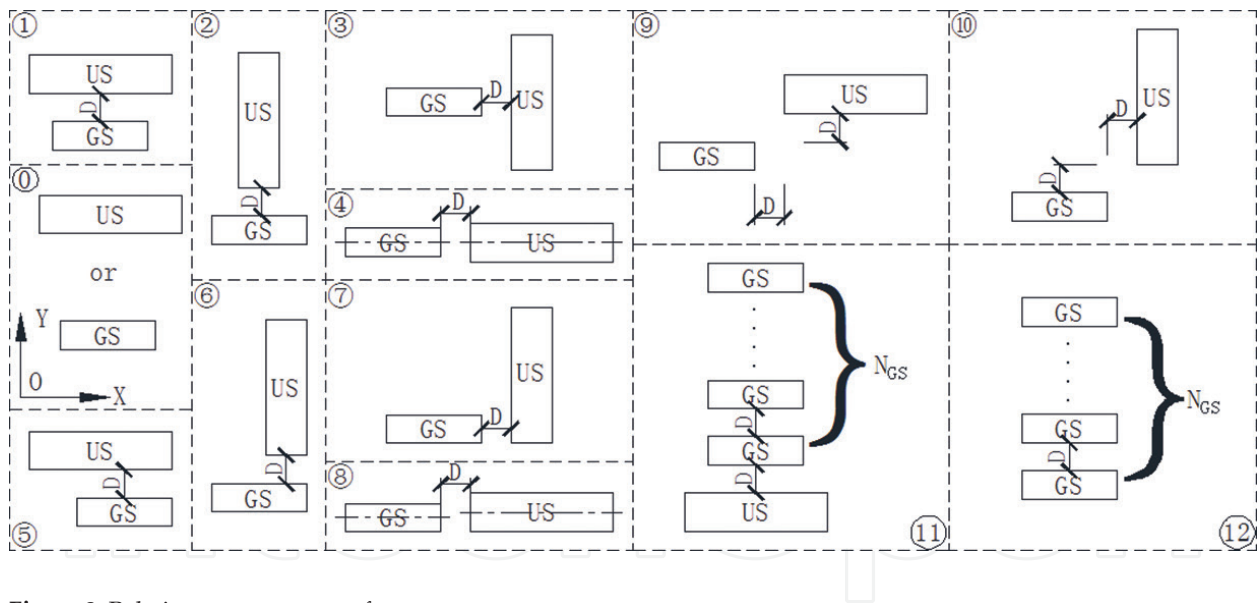

Figure 3. Relative arrangements of structures.

3. Finite element model

A commercial software product for finite element analysis, ANSYS, has been further developed and enhanced for calculation in frequency domain, in which hysteretic damping can be considered for both the soil and the structures by defining a complex soil shear modulus $\mu = \text{Re}[\mu](1 + 2i\zeta)$ and a complex structural stiffness $k = \text{Re}[k](1 + 2i\zeta_{GS})$ or $k = \text{Re}[k](1 + 2i\zeta_{US})$.

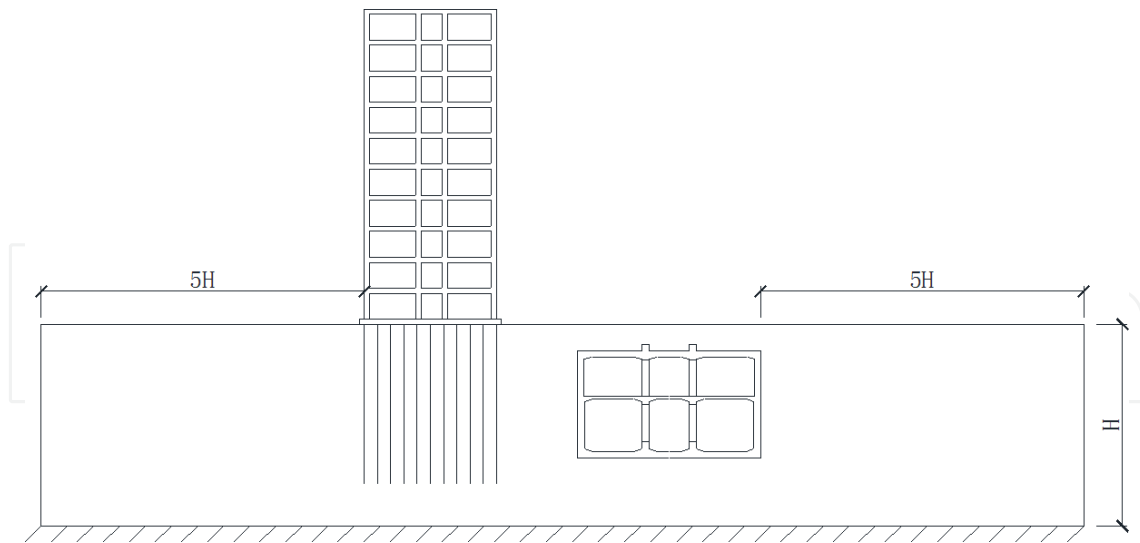

Figure 4. Arrangement of structures and soil (AR1).

The soil, considered as a consecutive, isotropic, homogeneous, linear, viscous-elastic medium, is modeled by solid elements (SOLID45). Fully bonded contact conditions are assumed between the soil and the underground station, and between soil and piles. Beams, and columns of the structures are modeled as Bernoulli beams via beam elements (beam188) and floor slabs and walls are modeled by shell element (shell63). Piles, whose heads can be fixedly connected to the base plate of surface structure, are modeled as vertical Bernoulli beams via pipe elements (pipe16).

Fixed constrains are applied at the bottom of the soil to simulate rigid bedrock where the seismic waves come. In view of the radiation damping of semi-infinite space, the scope of soil is set large enough, extending $5H$ long from structure scope (**Figure 4**). And in view of the transmission of energy in soil, the finite element mesh is set small enough, limited to $1/8 \lambda_{\min}$, being $\lambda_{\min} = c_s / f_{\max}$ the minimum premeditated wavelength. Here $f_{\max} = 20\text{Hz}$ is the maximum premeditated frequency of seismic wave.

The seismic inputs include harmonic wave, whose amplitude is 1 and frequency ranges from 0 to 12.5 Hz, and nine ground motion records from bedrock and three artificial seismic waves with different exceedance probabilities.

4. Numerical results

The influence of SSSI on the dynamic response of subway station is expounded in this section. Here, an analysis is made on the horizontal seismic behavior of underground structure in terms of its dimensionless displacement u , which is defined as $\left| \frac{\Delta u_{US}}{T^2 a_{\text{bedrock}}} \right|$, where $\Delta u_{US} = u_{\text{top}} - u_{\text{bottom}}$ is the relative displacement, paralleling to seismic excitation orientation, of underground structure at the top and bottom, and a_{bedrock} is the peak horizontal acceleration at the bedrock and $T = 4H/c_s$ is the fundamental period of free field. The horizontal seismic behavior of ground

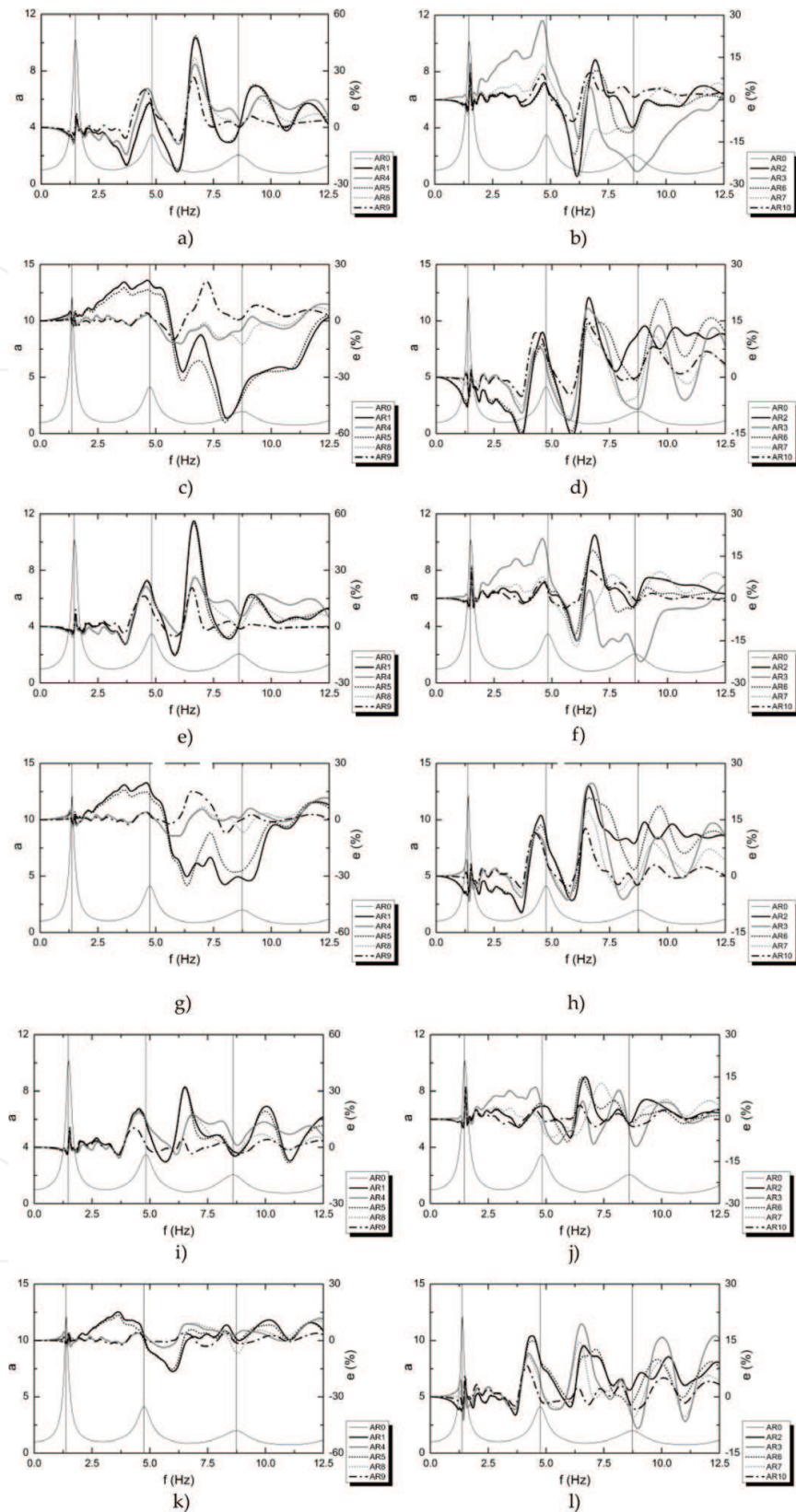

Figure 5. Interaction between surface structure and underground structure in terms of harmonic response spectra and influence coefficient e for different arrangements under S waves with different excitation orientation, a) AR0/1/4/5/8/9, SX and $d = 0.1$, b) AR0/2/3/6/7/10, SX and $d = 0.1$, c) AR0/1/4/5/8/9, SY and $d = 0.1$, d) AR0/2/3/6/7/10, SY and $d = 0.1$, e) AR0/1/4/5/8/9, SX and $d = 0.5$, f) AR0/2/3/6/7/10, SX and $d = 0.5$, g) AR0/1/4/5/8/9, SY and $d = 0.5$, h) AR0/2/3/6/7/10, SY and $d = 0.5$, i) AR0/1/4/5/8/9, SX and $d = 1.0$, j) AR0/2/3/6/7/10, SX and $d = 1.0$, k) AR0/1/4/5/8/9, SY and $d = 1.0$, l) AR0/2/3/6/7/10, SY and $d = 1.0$.

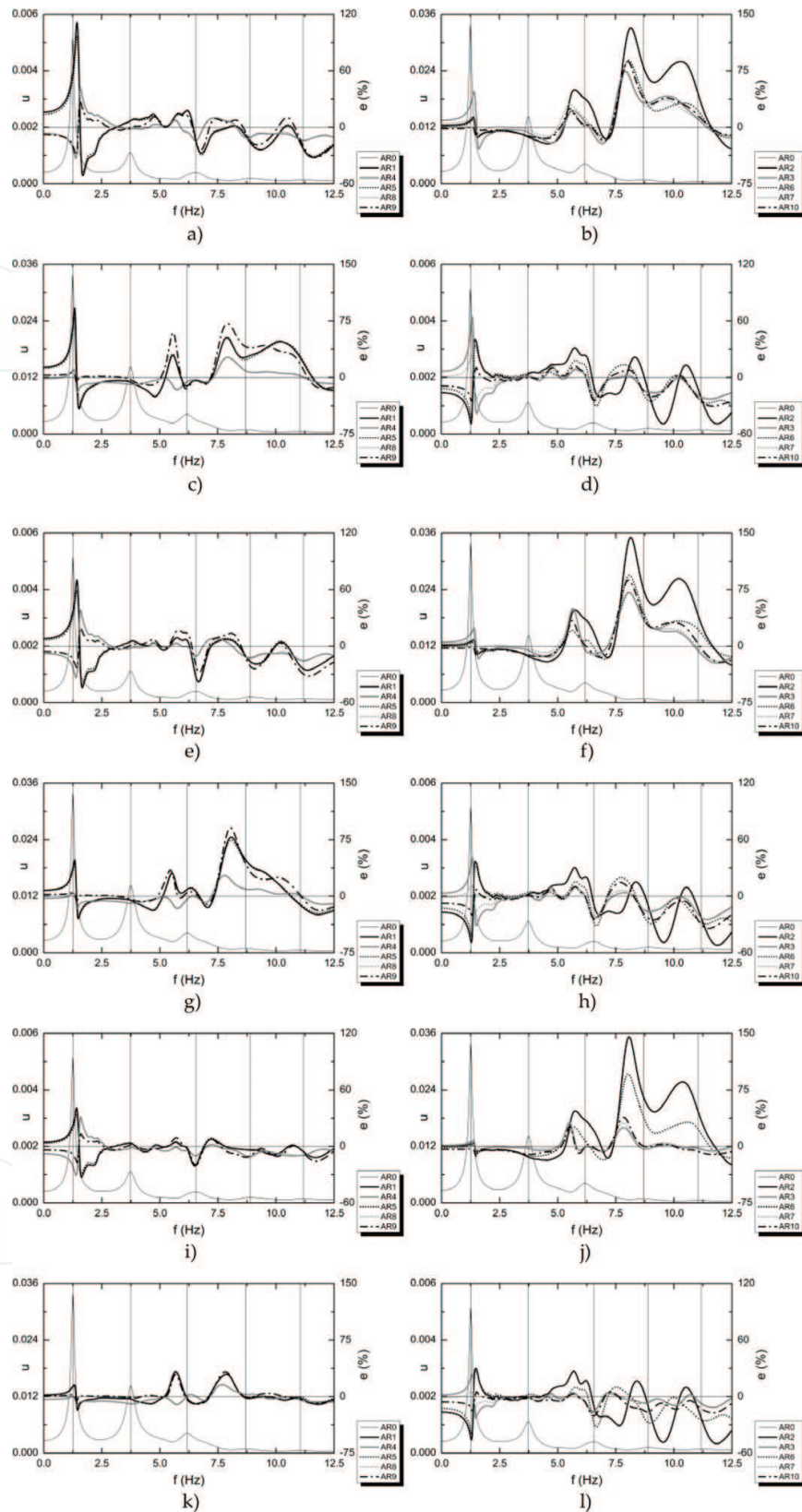

Figure 6. Interaction between surface structure and underground structure in terms of harmonic response spectra and influence coefficient e for different arrangements under S waves with different excitation orientation, a) AR0/1/4/5/8/9, SX and $d = 0.1$, b) AR0/2/3/6/7/10, SX and $d = 0.1$, c) AR0/1/4/5/8/9, SY and $d = 0.1$, d) AR0/2/3/6/7/10, SY and $d = 0.1$, e) AR0/1/4/5/8/9, SX and $d = 0.5$, f) AR0/2/3/6/7/10, SX and $d = 0.5$, g) AR0/1/4/5/8/9, SY and $d = 0.5$, h) AR0/2/3/6/7/10, SY and $d = 0.5$, i) AR0/1/4/5/8/9, SX and $d = 1.0$, j) AR0/2/3/6/7/10, SX and $d = 1.0$, k) AR0/1/4/5/8/9, SY and $d = 1.0$, l) AR0/2/3/6/7/10, SY and $d = 1.0$.

structure is analyzed in terms of its dynamic magnification factor a , defined as $|a_{GS}/a_{ff}|$, where a_{GS} and a_{ff} are respectively the horizontal acceleration, parallel to seismic excitation orientation, of surface structure and of free-field at the ground surface. The product of this value with the structural mass and the corresponding free-field horizontal acceleration at ground surface level yields the amplitude of shear force at each storey of the structure.

In order to show the SSSI effect explicitly, the influence of surface structure on underground structure is illustrated with influence coefficient e , defined as $(u_{AR1-11} - u_{AR0})/u_{AR0}$, where u_{AR0-11} is the aforementioned dimensionless displacement (u) of underground structure, arranging according to AR0–AR11 (**Figure 3**). Meanwhile, the influence of underground structure on surface structure is illustrated by influence coefficient e , defined as $(a_{AR1-10} - a_{AR0})/a_{AR0}$ or $(a_{AR11} - a_{AR12})/a_{AR12}$, where a_{AR0-12} is the dynamic magnification factor (a) of surface structure, arranging according to AR0–AR12 (**Figure 3**). The dimensionless distance d is D/B , where B is the width of surface structure.

4.1. Steady-state response

In this section, the following figures show the harmonic dynamic response (thin line), the aforementioned dimensionless displacement u of single-underground structure-soil systems (AR0) or the dynamic magnification factor (a) of single-surface structure-soil systems (AR0) together with the influence coefficient e (thick lines) of surface structure-soil-underground structure systems (AR1–11) under vertically incident S waves (SX or SY).

Figure 5 shows the dynamic response (thin line) of single-surface structure-soil system (AR0) together with the influence of adjacent surface structure on the response of underground structure (thick lines) under vertically incident S waves while **Figure 6** shows the dynamic response (thin line) of single-underground structure-soil system (AR0) together with the influence of adjacent surface structure on the response of underground structure (thick lines) under vertically incident S waves. Consideration is given to 10 different arrangements of structures (AR1–10), including one underground structure and one surface structure, and three distances between adjacent structures ($d=0.1, 0.5$ and 1.0). Shaking direction is assumed to be either parallel or perpendicular to the axes of structures (SX or SY).

A very slight shift at the peak of harmonic response spectra of underground structure takes place, slighter than that of surface structure-soil-surface structure system in many previous works [1]. The peak of harmonic response spectra of underground structure drifts slightly too, even slighter than that of surface structure, which can be ignored. It can be seen that the horizontal response of a surface structure and an underground structure may vary significantly due to the presence of underground structure or neighboring surface structure. The influence coefficient e , much depending on excitation frequency, fluctuates around zero with excitation frequency, and the dynamic response can be positive or negative. The influence of SSSI varies for different arrangements, distances between structures and shaking directions, and the dynamic response of structure may even increase or decrease, depending on the configuration.

The underground structure has conspicuous influence on the surface structure on many configurations, and the maximum impact can be up to 50%. But it has little influence ($e \leq 12\%$) if structures arrange in accordance with AR4 or AR8 under S waves producing motions on the Y.

That the central axis of two structures coincide with each other (AR1–4) or not (AR5–8) has very little influence on the interaction of structures. The most impact appears when AR3 contrast with AR7 under S waves producing motions on the X. The influence coefficient e is very depending on excitation frequency. When the excitation frequency is lower than 1 Hz, the influence coefficient e is almost close to zero for each arrangement. Namely that, the adjacent underground structure has little influence on the surface structure. When the excitation frequency is higher than 1 Hz, the influence coefficient e fluctuates with excitation frequency, and the dynamic response can be plus or minus. For all arrangement, the values of the lateral response at the top of surface structure around fundamental frequency are impact but not much. And that e are almost within 10% except the conditions with seismic motion on the X axis, $d = 0.1$ and arrangement according to AR3 or AR10.

The surface structure has a conspicuous influence on the underground structure on many configurations, and the maximum impact can reach up to 150%. It has smallest influence ($e \leq 27\%$) when structures arrange in accordance with AR4 or AR8 under S waves producing motions on the Y axis. This condition is consistent with that of influence of underground structure on surface structure, with influence coefficient not exceeding 12%. Whether the central axis of two structures coincide with each other (AR1–4) or not (AR5–8) has a little influence on the interaction of structures. There is little difference between AR1 and AR5 and between AR4 and AR8 under S waves producing motions on the X axis or Y axis. The greatest impact appears when AR2 contrast with AR6 under high frequency S waves producing motions on the X axis ($\geq 6.0\text{Hz}$) and Y axis ($\geq 3.5\text{Hz}$) and when AR3 contrasts with AR7 under low frequency S waves producing motions on the X axis ($\leq 6.0\text{Hz}$) and Y axis ($\leq 3.5\text{Hz}$).

For all arrangements, the horizontal response (dimensionless displacement) of underground structure around fundamental frequency of surface structure on shaking direction is impacted sharply. And the curves of influence coefficient e present peaks here. As the fundamental frequency of surface structure is approximate to that of underground structure-soil system, it is hard to determine the frequency near which the peaks appear. But this is clear in **Figures 9, 11–13** for the peaks move with the fundamental frequency of surface structure but not that of underground structure-soil system. As the distance increases, the peaks decline rapidly for AR1 and AR3, and slowly for AR2 and AR4. Experiments and observations from real cases have shown that underground structure exhibits a significantly different seismic response from surface structures as they do not respond in resonance with the ground motion, but rather on the basis of the response of the surrounding soil. This special behavior occurs, first because the mass effect is much smaller in underground than in surface structures and second, because the damping in underground structures is very high due to the energy radiating from them into the surrounding ground. Thus, the fundamental frequency of underground structure-soil system is approximately equal to that of free field. When the fundamental frequency of surface structure is approximate to that of free field, the surface structure might produce a more obvious influence on adjacent underground structure.

The influence of distance between structures on the interaction is investigated in **Figure 7**. **Figure 7(a)** shows the dynamic response (thin line) of surface structure-soil system (AR0) together with the influence of SSSI (thick lines) on the surface structure while **Figure 7(b)**

shows the dynamic response (thin line) of underground structure-soil system (AR0) together with the influence of SSSI (thick lines) on the underground structure, for AR1 under S waves producing motions on the Y axis, for different distance (d). Combining with **Figures 5** and **6**, for all frequencies, the interaction between structures reduces with the increase of distance, fluctuating but not monotonous. Obviously, with the increase of distance, the energy of scattered wave from structure reduces and the interaction between structures fades away. This is also the explanation of the phenomenon illustrated in **Figure 8**. **Figure 8** presents the dynamic response (thin line) of single-structure-soil system (AR0) and the influence coefficient e (thick lines) for AR1 under S waves producing motions on the Y axis, for different soil damping ($\zeta = 0.05, 0.10, 0.15, 0.20$). With the increase of soil damping, the absolute value of influence coefficient e decreases for all frequencies. And the curves fluctuate more gently.

Another important attribute of subsoil is shear wave velocity. So **Figure 9** presents the dynamic response (thin line) of single-structure-soil system (AR0) and the influence coefficient e (thick lines) for AR1 under S waves producing motions on the Y axis, now for different shear wave velocities of soil ($c_s = 200, 300, 400m/s$). At low frequency points, those shapes of influence

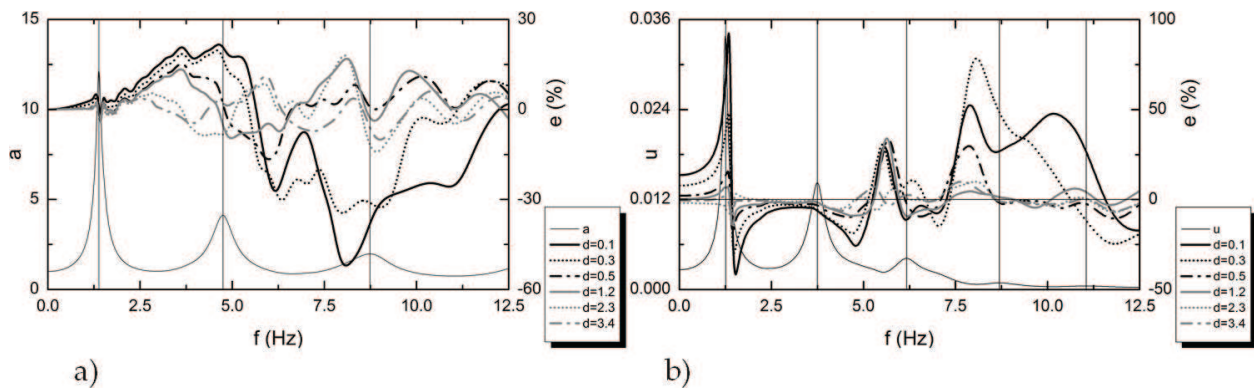

Figure 7. Interaction between surface structure and underground structure, arranged according to AR1, in terms of harmonic response spectra and influence coefficient e for different distances between structures under S waves producing motions on the Y axis, a) the impact on surface structure, b) the impact on underground structure.

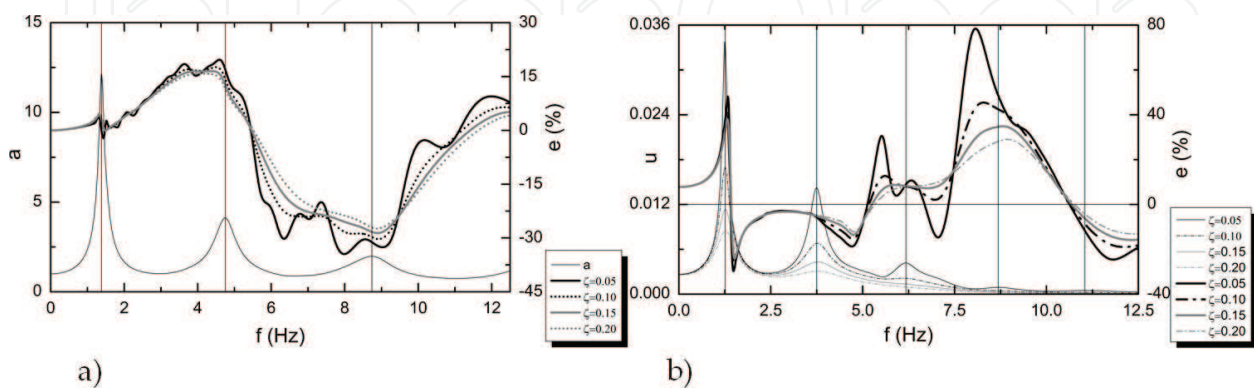

Figure 8. Interaction between surface structure and underground structure, arranged according to AR1, in terms of harmonic response spectra and influence coefficient e for different soil damping under S waves producing motions on the Y axis ($d = 0.5$), a) the impact on surface structure, b) the impact on underground structure.

coefficient curves are similar, but at high frequency points, the increase of shear wave velocity leads to the increase of absolute value of influence coefficient e .

Figure 10 presents the dynamic response (thin line) of single-structure-soil system (AR0) and the influence coefficient e (thick lines) for AR1 under S waves producing motions on the Y axis, now for different lengths of piles of the surface structure ($H_{pile} = 6m, 12m, 18m, 24m$) and surface foundation ($H_{pile} = 0m$). Those curves of influence coefficient e almost coincide at all frequencies, which mean that the influence of pile can be ignored here. However, with the decrease of length of pile, the impact of underground structure on surface structure around fundamental frequency increases. And that e can be up to 15% for surface foundation.

Figures 11 and 12 show the dynamic response (thin line) of single-structure-soil system (AR0) and the influence coefficient e (thick lines) for AR1 under S waves producing motions on the Y axis, for frame with different stiffness and frame-shear wall structures with different stiffness respectively. The frame-shear wall structure is based on the aforementioned frame structure with the addition of four L-shape shear walls on each storey. Meanwhile, consideration is given to three different kinds of stiffness (original stiffness multiplied by 0.8, 1.0 and 1.2,

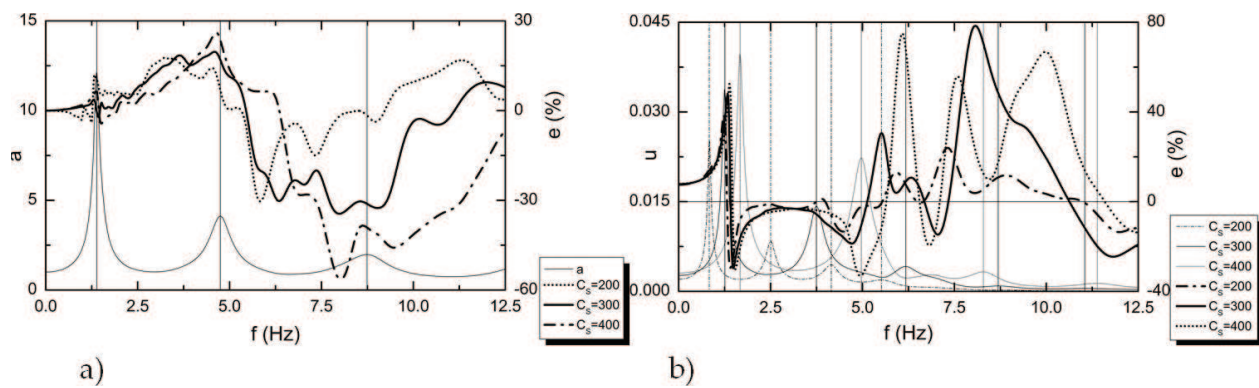

Figure 9. Interaction between surface structure and underground structure, arranged according to AR1, in terms of harmonic response spectra and influence coefficient e for different shear wave velocity of soil under S waves producing motions on the Y axis ($d = 0.5$), a) the impact on surface structure, b) the impact on underground structure.

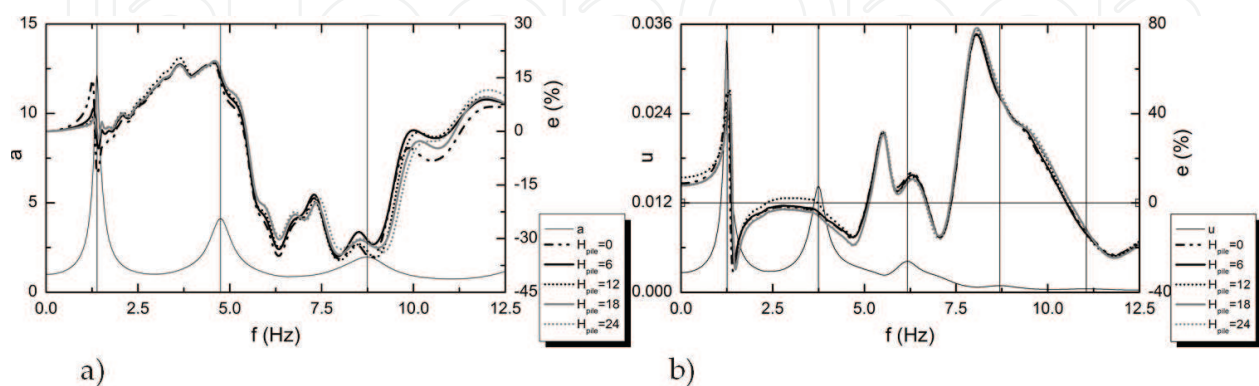

Figure 10. Interaction between surface structure and underground structure, arranged according to AR1, in terms of harmonic response spectra and influence coefficient e for different length of pile of surface structure under S waves producing motions on the Y axis ($d = 0.5$), a) the impact on surface structure, b) the impact on underground structure.

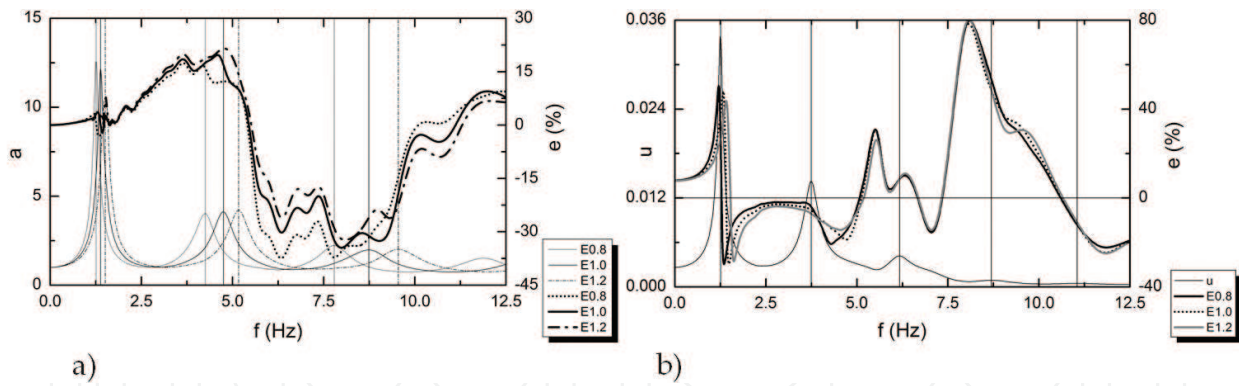

Figure 11. Interaction between surface structure and underground structure, arranged according to AR1, in terms of harmonic response spectra and influence coefficient e for different stiffness of surface structure under S waves producing motions on the Y (frame structure, $d = 0.5$), a) the impact on surface structure, b) the impact on underground structure.

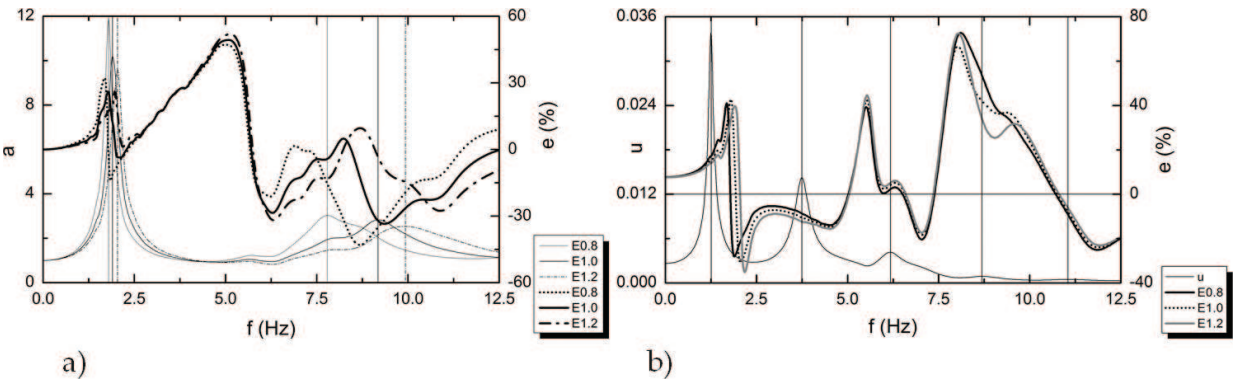

Figure 12. Interaction between surface structure and underground structure, arranged according to AR1, in terms of harmonic response spectra and influence coefficient e for different stiffness of surface structure under S waves producing motions on the Y axis (frame-shear wall structure, $d = 0.5$), a) the impact on surface structure, b) the impact on underground structure.

termed as “E0.8”, “E1.0” and “E1.2”) of the surface structure. The fundamental periods, along lateral axis, of frame structures are 0.77 s for “E0.8” and 0.67 s for “E1.2”; and that of frame-shear wall structures are 0.56 s for “E0.8”, 0.53 s for “E1.0” and 0.50s for “E1.2”.

The moderate adjustment of stiffness does not have much influence on the interaction at all frequency points. Meanwhile, through contrast on **Figures 11** and **12**, style of surface structure, frame structure or frame-shear wall structure, has no great influence on SSSI when focus on the response of underground structure. The shapes of those influence coefficient curves are similar except that the first peaks drift with fundamental frequencies of surface structures. However, style of structure has unexpectedly impact on SSSI when focus on the response of surface structure. But this impact does not just owing to the difference of stiffness.

Figure 13 shows the dynamic response (thin line) of single-structure-soil system (AR0) and the influence coefficient e (thick lines) for AR1 under S waves producing motions on the Y axis, for different storey numbers ($N_f = 6, 10, 14$) of the surface structure. The fundamental periods, along lateral axis, of the frame structure are 0.42 s for “ $N_f = 6$ ” and 1.11 s for “ $N_f = 14$ ”. The variation of number of storey has some influence on the interaction between structures, but the shapes of

influence coefficient curves are similar by and large. There are some perturbations at those frequency points around the natural frequency of surface structure, and the smaller the number of storey, the sharper the perturbation is. Expectedly, except that the first peaks of influence coefficient curves of SSSI on underground structure shift with fundamental frequencies of surface structures, the variation of storey number has no great influence on the interaction between structures. Meanwhile, the larger the storey number is, the sharper the first peak will be.

Figure 14 presents the dynamic response (thin line) of single-structure-soil system (AR0) and the influence coefficient e (thick lines) for AR1 under S waves producing motions on the Y axis, for different burial depths of the underground station ($H_{bd} = 2m, 3m, 4m$). Those shapes of influence coefficient e curves of SSSI on surface structure are similar, but at some frequency points, such as 1–4 Hz, the increase of burial depth leads to a little increase of interaction, and at the other frequency points, such as 5.5–7.5 Hz, the increase of burial depth leads to a little decrease of interaction. At the same frequency, the increase or decrease of interaction is monotonous. Except at high frequency points ($\geq 9.0\text{Hz}$), those curves of influence coefficient e on underground structure almost coincide at most of the frequency points, which means that burial depth generates little impact on the interaction.

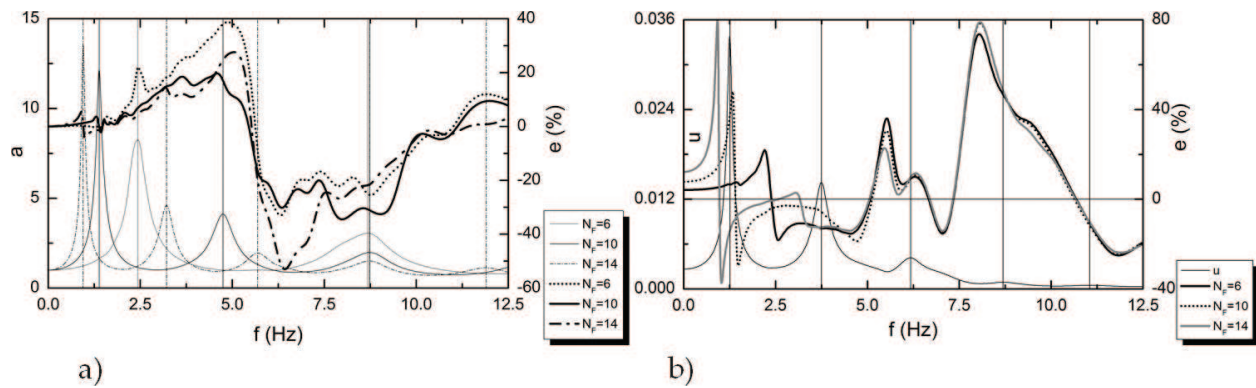

Figure 13. Interaction between surface structure and underground structure, arranged according to AR1, in terms of harmonic response spectra and influence coefficient e for different number of storey of surface structure under S waves producing motions on the Y axis ($d = 0.5$), a) the impact on surface structure, b) the impact on underground structure.

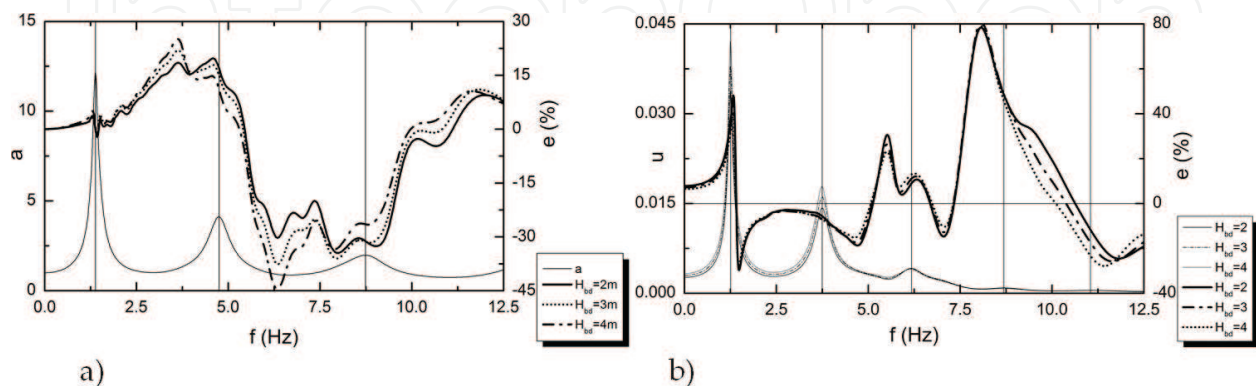

Figure 14. Interaction between surface structure and underground structure in terms of harmonic response spectra and influence coefficient e for different burial depth of underground station under S waves producing motions on the Y axis ($d = 0.5$), a) the impact on surface structure, b) the impact on underground structure.

Figure 2 depicts the profile of a typical three-span underground subway station, which is used for analysis in this paper. At some smaller subway stations, however, a two-span profile is widely adopted. So the middle span of the profile depicted in **Figure 2** is cut off, and the underground structure is turned into a two-span station for comparison. **Figure 15** displays the dynamic response (thin line) of single-structure-soil system (AR0) and the influence coefficient e (thick lines) for AR1 under S waves producing motions on the Y axis, for different numbers of spans ($N_s = 2, 3$) of underground station. At the lower frequency points (0–4.5 Hz), number of spans hardly impacts the interaction. But at the higher frequency points (4.5–12.5 Hz), different numbers of spans lead to the misalign of influential coefficient e . Even so, the influence of surface structure on two-span and three-span underground station is not much different.

Now, an analysis is made on a case of several similar surface structures and an underground structure arranged as shown in **Figure 3** (AR11). For comparison, the case of just only surface structures (AR12) is analyzed too. **Figure 16** presents the dynamic response (thin line) of single-structures-soil system (AR0) together with the influence coefficient e (thick lines) of surface structures-soil-underground structure systems (AR11) under S waves producing

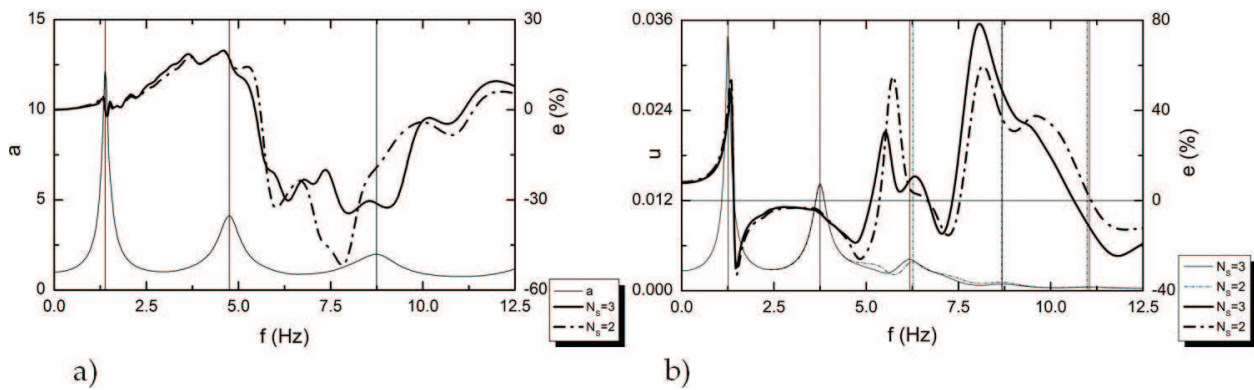

Figure 15. Interaction between surface structure and underground structure in terms of harmonic response spectra and influence coefficient e for different number of span of underground structure under S waves producing motions on the Y axis ($d = 0.5$), a) the impact on surface structure, b) the impact on underground structure.

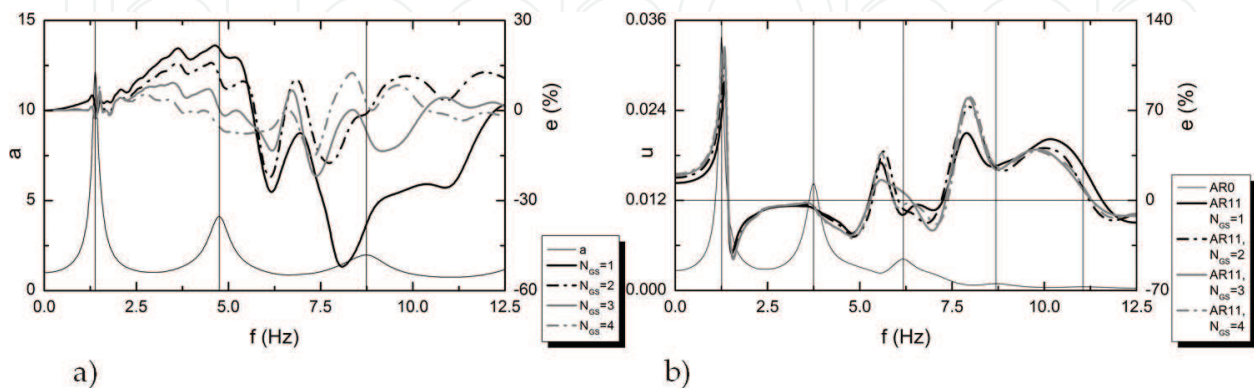

Figure 16. Interaction between surface structure and underground structure in terms of harmonic response spectra and influence coefficient e for different numbers of surface structures under S waves producing motions on the Y axis ($d = 0.1$), a) the impact on surface structure, b) the impact on underground structure.

motions on the Y axis, for different numbers of surface structures ($N_{GS} = 1, 2, 3, 4$). The lateral response of the surface structure, which is furthest away from the underground station, is checked here. It is exposed that the presence of underground structure can not only has influence on the contiguous surface structure but also the other neighboring ground structures. Expectedly, because the energy of scattered wave fade away, the influence falls down when the number of ground structures grows up. It is exposed that those neighboring surface structures, which are not next to the underground structure, also generate an impact on the underground structure by affecting the contiguous surface structure. More buildings will cause greater impact, particularly at the first peak of influence coefficient. As the energy of scattered wave fades away, however, the influence of building number tends to converge when it grows up.

4.2. Earthquake response

In this section, nine ground motion records from bedrock and three artificial seismic waves with different exceedance probabilities are selected in order to measure the influence of surface structure on underground structure. Results in the time domain are obtained by Fourier transformation, via the fast Fourier transform (FFT) algorithm.

Figures 17 and 18 show the influence of SSSI under vertically incident S waves. Obviously, the absolute value of influence coefficient e of SSSI on surface structure is within 15% and that of SSSI on underground structure is within 40%. Although, in harmonic analysis, the influence coefficient e can reach up to 50% (SSSI on surface structure) or 150% (SSSI on underground structure) at some frequency points, the corresponding dynamic response (a or u) or the corresponding seismic energy might still be small, and consequently, the interaction between structures is not so conspicuous. The absolute value of influence coefficient e of underground structure on surface structure is almost within 5 percent for 11 seismic waves. However, the influence coefficient e , the dynamic magnification factor a and the seismic energy (showed by Figure 19) around 4.5 Hz is great. This is why the interaction under GGP-100 seismic wave is greater than the others. For AR2 and AR4, generally, the influence of surface structure on

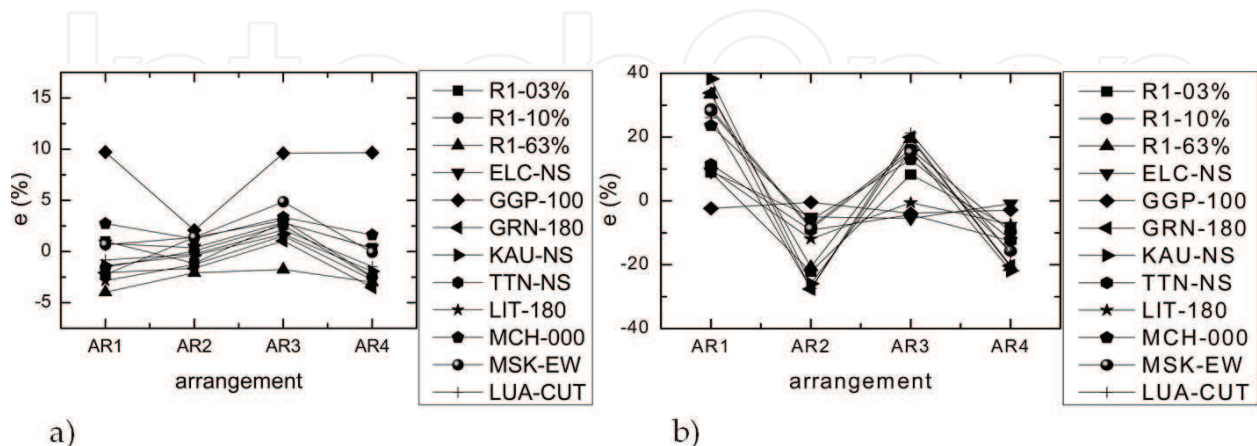

Figure 17. Interaction between surface structure and underground structure in terms of influence coefficient e for different arrangements under S waves producing motions along longitudinal axis ($d = 0.5$), a) the impact on surface structure, b) the impact on underground structure.

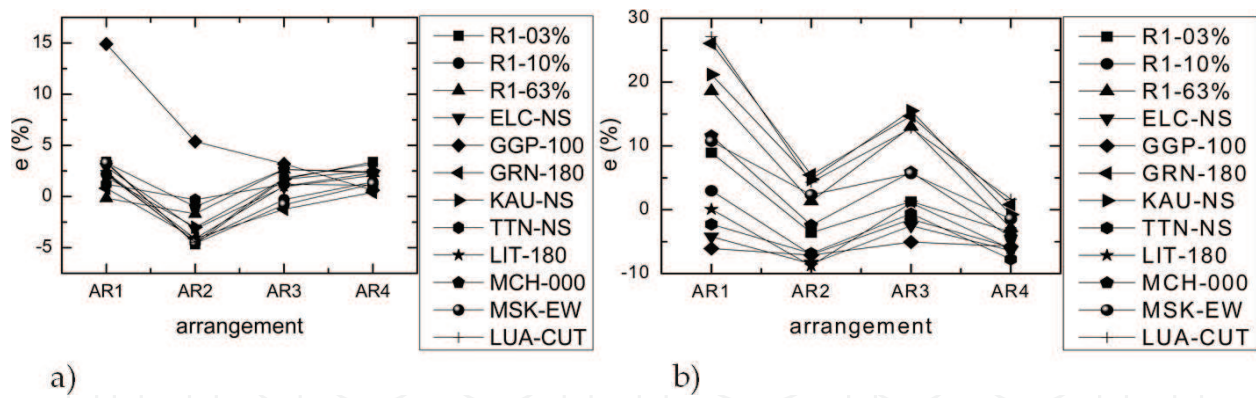

Figure 18. Interaction between surface structure and underground structure in terms of influence coefficient e for different arrangements under S waves producing motions along lateral axis ($d = 0.5$), a) the impact on surface structure, b) the impact on underground structure.

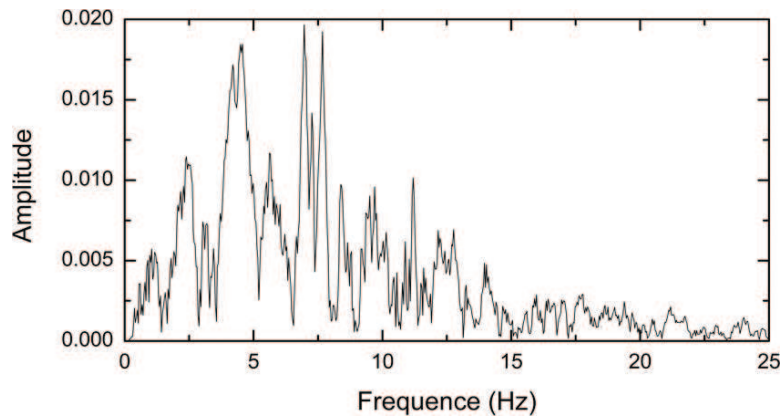

Figure 19. Fourier spectrum of seismic wave (GGP-100).

underground structure is beneficial or negligible under S waves producing motions along longitudinal axis; it is also not so conspicuous ($|e| < 10\%$) under S waves producing motions along lateral axis. For AR1 and AR3, however, the influence coefficient e can reach up to 40% which deserves more attention in seismic dynamic analysis.

5. Compare and contrast

The similarity and difference of the impact on surface structure and on underground structure are briefly summarized in this section.

The presence of adjacent structure leads to the peak of harmonic response spectra of structure shifted. But the shift of underground structure is slighter than that of surface structure, which can be ignored. The horizontal responses of surface structure and underground structure around fundamental frequency of surface structure at shaking direction are both conspicuously impacted and the influence coefficient curves show peaks here. But the peaks of underground structure are much more outstanding. The influence of adjacent structure on underground structure reaches minimum if structures arrange in accordance with AR4 or AR8 under S waves producing motions

on the Y axis. Whether the central axes of the two structures coincide with each other (AR1–4) or not (AR5–8) has a small influence on the response of underground structure and has a relatively larger influence on the response of surface structure, especially in contrast between AR3 and AR7. In general, the impact of each parameter on the influence coefficient curve of surface structure on underground structure is smaller than that of underground structure on surface structure.

6. Conclusion

A three-dimensional numerical procedure for the dynamic analysis of pile supported surface building and underground station was used in this work, to solve the problem of through-soil interaction between multi-storey frame structure and neighboring underground structure. The commercial software (ANSYS), based on finite element method, has been further developed and enhanced for calculation in frequency domain, in which hysteretic damping has been considered for both soil and structures, and linear assumptions have been put forward for the rigorous three-dimensional modeling. In this way, SSSI phenomena are implicitly included in the model.

Transfer functions of horizontal acceleration of surface structure and that of relative horizontal displacement of underground structure under harmonic wave, and maximum horizontal acceleration of surface structure and maximum relative horizontal displacement response of underground structure under real or artificial seismic wave, are presented, in order to assess the influence of SSSI phenomena on the structural seismic response of neighboring surface structure and underground structure subject to vertically incident S wave.

Arrangement and shaking direction of seismic wave are two of the most important factors, which have conspicuous influences on the interaction. In general, when structures arrange according to AR1 under S waves producing motions on the X axis and according to AR2 under S waves producing motions on the Y axis, the impact of surface structure on underground structure is more noticeable. And when structures arrange AR3 under S waves producing motions on the X and according to AR1 under S waves producing motions on the Y, the impact of underground structure on surface structure is more noticeable. Depending on the distance between adjacent structures, the seismic response of surface structure can either increase or decrease. But the interaction surely fades away if the distance is large enough. When the fundamental frequency of surface structure is approximate to that of free field, surface structure may have more considerable influences on adjacent underground structure.

In view of the results, it is apparent that further studies about SSSI phenomena and their influence on structural seismic risk are needed, as it has been shown that nearby buildings can significantly increase the seismic response of a structure.

Acknowledgements

The authors would like to gratefully acknowledge the support from National Natural Science Foundation of China under Grant No. 51608462.

Author details

Huai-feng Wang

Address all correspondence to: whf_tj@163.com

School of Civil Engineering and Architecture, Xiamen University of Technology, Xiamen, China

References

- [1] Lou M et al. Structure-soil-structure interaction: Literature review. *Soil Dynamics and Earthquake Engineering*. 2011;**31**(12):1724-1731
- [2] Luco JE, Contesse L. Dynamic structure-soil-structure interaction. *Bulletin of the Seismological Society of America*. 1973;**63**(4):1289-1303
- [3] Fu CS, Yu ZD. Analysis of dynamic behaviour of structure including the effects of an adjacent building. *Shanghai Mechanics*. 1982;**3**(3):28-39
- [4] Tian BD, Yu ZD. Dynamic analysis of structure-soil-structure interaction. *Journal of Tongji University*. 1987;**15**(2):157-168
- [5] Jiang XL, Yan ZD, Li XZ. Analysis of earthquake response of neighboring buildings-foundation-soil system under multi-support excitations. *Earthquake Engineering and Engineering Vibration*. 1997;**17**(4):65-71
- [6] Dou LJ, Yang BP. Dynamic interaction of tall building with neighboring multi-storied building. *Earthquake Engineering and Engineering Vibration*. 2000;**20**(3):15-21
- [7] Padron LA, Aznarez JJ, Maeso O. Dynamic structure-soil-structure interaction between nearby piled buildings under seismic excitation by BEM-FEM model. *Soil Dynamics and Earthquake Engineering*. 2009;**9**(6):1084-1096
- [8] Alamo GM et al. Structure-soil-structure interaction effects on the dynamic response of piled structures under obliquely incident seismic shear waves. *Soil Dynamics and Earthquake Engineering*. 2015;**78**(11):142-153
- [9] Fariborz N, Ali R. Nonlinear dynamic response of tall buildings considering structure-soil-structure effects. *The Structural Design of Tall and Special Buildings*. 2013;**22**(14):1075-1082
- [10] Li P, Yan K, Xu P. Study on dynamic interaction between soil and group of high-rise buildings under seismic excitation. *China Civil Engineering Journal*. 2014;**S1**:1-5
- [11] Alam M, Kim D. Spatially varying ground motion effects on seismic response of adjacent structures considering soil-structure interaction. *Advances in Structural Engineering*. 2014;**17**(1):131-142

- [12] Ghandil M, Behnamfar F, Vafaeian M. Dynamic responses of structure-soil-structure systems with an extension of the equivalent linear soil modeling. *Soil Dynamics and Earthquake Engineering*. 2016;**80**(1):149-162
- [13] Wolf JP. *Foundation Vibration Analysis Using Simple Physical Models*. Englewood Cliffs: PTR Prentice Hall; 1994
- [14] Mulliken JS, Karabalis DL. Discrete model for dynamic through-the-soil coupling of 3-D foundations and structures. *Earthquake Engineering and Structural Dynamics*. 1998;**27**(7):687-710
- [15] Alexander NA, Ibraim E, Aldaikh H. Exploration of structure-soil-structure interaction dynamics. In: *Proceedings of the 13th International Conference on Civil, Structural and Environmental Engineering Computing*; Chania, Crete, Greece; 2011
- [16] Naserkhaki S, Pourmohammad H. SSI and SSSI effects in seismic analysis of twin buildings: Discrete model concept. *Journal of Civil Engineering and Management*. 2012;**18**(6): 890-898
- [17] Mizuno H. Effects of structure-soil-structure interaction during various excitations. In: *Proceedings of 7th World Conference on Earthquake Engineering*; Istanbul, Turkey; 1980
- [18] Lin Y. *Shaking Table Model Test of Underground Structure and Numerical Analysis*. Shanghai: Tongji University; 2012
- [19] Kang S. *Shaking Table Model Test of Substructure-Soil-Superstructure System and Numerical Analysis*. Shanghai: Tongji University; 2012
- [20] Pan DG et al. Model test of the dynamic characteristics of a structure-soil-structure system. *Journal of University of Science and Technology Beijing*. 2014;**36**(12):1720-1728
- [21] Trombetta NW et al. Nonlinear soil-foundation-structure and structure-soil-structure interaction: Engineering demands. *Journal of Structural Engineering*. 2015;**141**(7): 04014177
- [22] Xiong F et al. Shake table tests of high-rise building group-soil interaction. *Journal of Sichuan University (Engineering Science Edition)*. 2015;**47**(03):37-43
- [23] Aldaikh H et al. Two dimensional numerical and experimental models for the study of structure-soil-structure interaction involving three buildings. *Computers & Structures*. 2015;**150**(4):79-91
- [24] Cacciola P, Espinosa MG, Tombari A. Vibration control of piled-structures through structure-soil-structure-interaction. *Soil Dynamics and Earthquake Engineering*. 2015;**77**(10):47-57
- [25] Lee VW, Trifunac MD. Response of tunnels to incident SH-waves. *ASCE Journal of the Engineering Mechanics Division*. 1979;**105**(4):643-659
- [26] Lee VW, Karl J. Diffraction of SV waves by underground, circular, cylindrical cavities. *Soil Dynamics and Earthquake Engineering*. 1992;**11**(8):445-456

- [27] Lin CH et al. Zero-stress, cylindrical wave functions around a circular underground tunnel in a flat, elastic half-space: Incident P-waves. *Soil Dynamics and Earthquake Engineering*. 2010;**30**(1):879-894
- [28] Hatzigeorgiou GD, Beskos DE. Soil-structure interaction effects on seismic inelastic analysis of 3-D tunnels. *Soil Dynamics and Earthquake Engineering*. 2010;**30**(9SI):851-861
- [29] Abate G, Massimino MR, Maugeri M. Numerical modelling of centrifuge tests on tunnel-soil systems. *Bulletin of Earthquake Engineering*. 2015;**13**(7):1927-1951
- [30] Guo J, Chen JY. Influence of subway station buried in homogenous foundations on the inter-story drift ratio of adjacent structures. *Journal of Hunan University (Natural Science)*. 2013;**40**(08):40-45
- [31] Yang SY, Jiang XL, Li XG. Analysis on seismic response effect of tunnel to nearby structure. *Journal of Sichuan University (Engineering Science Edition)*. 2007;**39**(3):41-46
- [32] Li YT, Zhou ZX. Effect of tunnel on seismic response of adjacent surface building structure. *Journal of Hebei University of Technology*. 2014;**43**(05):97-100
- [33] Farghaly AA. Seismic analysis of high rise building with deep foundation constructed near deep channel. *Electronic Journal of Geotechnical Engineering*. 2014;**19N**:3099-3124
- [34] Abate G, Corsico S, Massimino MR. FEM modelling of the seismic behavior of a tunnel-soil-aboveground building system: A case history in Catania (Italy). In: 6th Italian Conference of Researchers in Geotechnical Engineering. Bologna, Italy: Elsevier Ltd; 2016
- [35] Abate G, Massimino MR. Parametric analysis of the seismic response of coupled tunnel-soil-aboveground building systems by numerical modelling. *Bulletin of Earthquake Engineering*. 2017;**15**(1):443-467
- [36] Abate G, Massimino MR. Numerical modelling of the seismic response of a tunnel-soil-aboveground building system in Catania (Italy). *Bulletin of Earthquake Engineering*. 2017;**15**(1):469-491