

# We are IntechOpen, the world's leading publisher of Open Access books Built by scientists, for scientists

4,800

Open access books available

122,000

International authors and editors

135M

Downloads

Our authors are among the

154

Countries delivered to

TOP 1%

most cited scientists

12.2%

Contributors from top 500 universities



WEB OF SCIENCE™

Selection of our books indexed in the Book Citation Index  
in Web of Science™ Core Collection (BKCI)

Interested in publishing with us?  
Contact [book.department@intechopen.com](mailto:book.department@intechopen.com)

Numbers displayed above are based on latest data collected.  
For more information visit [www.intechopen.com](http://www.intechopen.com)



---

# Distillation Column

---

Nasser Mohamed Ramli

Additional information is available at the end of the chapter

<http://dx.doi.org/10.5772/intechopen.74656>

---

## Abstract

Dynamic simulations are used to model systems that are in transition from a steady state to dynamic state. The dynamic model is used to evaluate different basic control schemes and later to evaluate and test the control strategy. In this chapter, a steady-state simulation and dynamic simulation for debutanizer column are performed using a plant process simulator, HYSYS™. The objective of this chapter is to study the process variables of each controller at the column by using different tuning relations and identify the best tuning methods for the controllers in order to optimise the performance of the column. Two tuning methods are used in determining the controller settings for each controller. The process variable for each controller are used by using two different tuning methods are being studied. Furthermore, the effect on the process variables of each controller when using the controller settings based on real plant data and calculated using the PID equation is also being analysed. As for conclusion, the different tuning methods could give the different results on the behaviour of the response for each controller and the optimum response for each controller could be determined by considering the behaviour of the response and the value of integral square of the error (ISE) and integral of absolute value of error (IAE). All the research and findings obtained will be used to improve the overall performance of the plant as well as to improve the quality of the product and maximise profitability. The successful outcome of this chapter will be a great helping hand for industrial application.

**Keywords:** distillation column, steady state, dynamic state, PID controller, tuning

---

## 1. Introduction

The process industries are dynamic in nature. Process plants rarely run at a steady-state condition on dynamic. Feed and environmental disturbances, equipment vibrations, changes in

ambient conditions, heat exchanger fouling and degrading equipment performance that will effect smooth running of a process operation [1]. The transient behaviour of the process system is best studied using a dynamic simulation tool like HYSYS™. HYSYS™ contains a wide variety of property packages which provide accurate thermodynamic, physical and transport property predictions for hydrocarbon, non-hydrocarbon, petrochemical and chemical fluids. This powerful simulation program provides an environment for exploration of thermodynamic model behaviour, proper determination and tuning of interaction parameters and physical properties, as well as alternative designs for distillation systems.

Through dynamic simulation analyses, users are able to effectively study the impacts that change operating conditions and design modifications have on the operation of a process [2]. Process configurations and control system designs can be evaluated to ensure that they will meet corporate manufacturing objectives regardless of changing process and market conditions. The optimization and design of a process involves both steady-state and dynamic behaviour. Steady-state models consist of steady-state material and energy balances in order to evaluate different plant scenarios. The process engineer can use steady-state model to optimise the process industry by reducing equipment costs and capital while production maximising. Dynamic models allow the design engineer to design and compare alternative control strategies, examine the dynamic response to system disturbances and optimise the tuning of controllers in order to improve the overall performance of the plant [3, 4].

## 2. Literature review

### 2.1. Modelling under steady state

Steady-state simulations are widely used in process design, optimization and provide information for process flow sheets in terms of material and energy balances. It is also used for process design equipment such as heat exchangers, reactors and distillation columns. These simulations consist blocks of unit operations connected together and physical property data for the input streams chemical components specified by the user.

Steady-state models can perform steady-state energy and material balances and evaluate different plant scenarios. The design engineer can use steady-state simulation to optimise the process by reducing capital and equipment costs while maximising production.

However, the one obvious limitation of steady-state modelling is that it tells us nothing about the dynamic response, making it difficult to compare the dynamic disturbance rejection capability of alternative control schemes [6].

### 2.2. Dynamic modelling

Dynamic models are used to predict how to control a process and respond to various upsets in terms of function of time. They are widely used to evaluate equipment configurations, control schemes and determine the reliability and safety of a certain design before capital is committed to the implementation of a process. For an optimum process, dynamic simulation

can be used to assess transient conditions that could determine the process design pressures and temperatures. In many cases, unnecessary capital expenditures can be neglected using dynamic simulation.

Dynamic simulation during process design could lead to profit during plant start-up. Expensive field changes and impact schedule can be minimised if the control system and equipment are validated using dynamic simulation. Shutdown and start-up can be tested using dynamic simulation [7].

During start-up dynamic simulation could also provide controller-tuning parameters. In a lot of cases, accurate tuning controller settings can prevent expensive shutdowns and accelerate plant start-up. Dynamic simulation models used for process design are not based on transfer functions that are run from operator training simulators, but on actual physical equations governing the process and fundamental engineering principles [8].

Dynamic simulation models that are used for process design include:

- From differential balances for equipment models that include mass and energy inventory.
- Rigorous thermodynamics based on property correlations, steam tables and equations of state.
- Actual valve, piping, distillation tray, equipment hydraulics for both incompressible and compressible and lastly critical flow.

These models are so detailed that the results can influence engineering design decisions and ensure a realistic prediction of the process and the control system's interaction to assess control system stability [11].

### 2.3. PID controller

A proportional-integral-derivative controller (PID controller) is a general control loop feedback mechanism (controller) widely used in industry. A PID controller attempts to correct the error between a desired setpoint and a measured process variable by calculating it and then a corrective action that can adjust the process accordingly to keep the error minimal.

The PID controller involves three important parameters: which are proportional, integral and derivative. The *proportional* controller determines the reaction to the error calculated, the *integral* determines the reaction based on the sum of recent errors and the *derivative* determines the reaction based on the rate at which the error that has been changed. The weighted sum of these three actions is used to adjust the process control element such as the opening of a control valve (manipulated variable) or the power supply of a heating element [9].

The three constants are tuned in the PID controller equation; the controller can provide control action designed for specific requirements. The response of the controller could be decided in terms of the responsiveness of the controller to the required error, the degree to which the controller overshoots the setpoint and the degree of oscillation. The use of the PID algorithm for control does not guarantee optimal control of the system and stability.

To some extent, the applications may require using only one or two mode to provide the appropriate control. This could be achieved by setting the gain of the control outputs to zero. A PID controller will be called a PI, PID, PD, or P controller in the absence of the respective control actions. PI controllers are particularly widely used, since derivative action is sensitive to measurement noise and the absence of an integral value may prevent the system from reaching its setpoint value due to the control action [10].

The PID control scheme is named after its three correcting terms, whose sum constitutes the manipulated variable (MV). Hence:

$$MV(t) = P_{out} + I_{out} + D_{out} \quad (1)$$

Once the process gain, time constant time delay calculated for first-order response in the open loop tuning, the values are used in the Cohen Coon formula and input in HYSYS to perform the closed loop tuning in the PID equation. The first-order model of different loops are as follows; Temp 1 is controlled by regulating the heat duty of the reboiler using feedback control. Flow 3 is controlled by regulating the bottom liquid flowrate of the column. Pressure 1 is controlled using split range control of the vapour flowrate of the column and outlet vapour of the condenser. Flow 2 is controlled regulated using the distillate flowrate of the column.

### 3. Methodology

#### 3.1. Data collection

The relevant data are identified and gathered after the problem is clearly defined. The steady-state and dynamic simulation by using HYSYS was performed in order to determine which data are needed for the simulation. The data collected from the plant information (PI) systems with the helping of an engineer in oil refinery industry [12].

##### 3.1.1. Debutanizer column

**Table 1** shows the debutanizer column description. The column plant data tabulated in **Table 1** are important in order for the HYSYS simulation to run.

##### 3.1.2. Composition in the feed in mass fraction including components in the feed

**Table 2** shows the composition of the feed debutanizer column which is important to analyse as the column consists of multicomponent.

##### 3.1.3. Hypothetical components properties

**Table 3** shows the important properties of the hypothetical components that are used for the simulation and the component not available therefore need to input the information in HYSYS.

Number of tray of the column	35
Feed tray-stage number	23
Type of tray used	Valve
Column diameter	1.3 m
Column height	23.95 m
Type of condenser	Partial
Feed mass flowrate	44,106 kg/h
Feed temperature	113°C
Feed pressure	823.8 kPa
Overhead vapour mass flowrate	11,286 kg/h
Overhead liquid mass flowrate	5040 kg/h
Pressure condenser	823.8 kPa
Pressure reboiler	853.2 kPa

**Table 1.** Debutanizer column plant data.

Composition	Mass fraction
Propane	0037
i-Butane	0093
n-Butane	0062
i-Pentane	0082
n-Pentane	0110
Hypo50_13*	0017
Hypo60_13*	0191
Hypo70_13*	0245
Hypo80_13*	0063
Hypo90_13*	0070
Hypo100_13*	0029
Hypo110_13*	0003
Hypo120_13*	0001

**Table 2.** Composition at the feed.

### 3.1.4. Operational parameters

#### 3.1.4.1. Temp 1, Flow 3, Pressure 1 and Flow 2

**Table 4** shows the operational parameters for Temp 1, Flow 3, Pressure 1 and Flow 2 that are obtained in industry input in the simulation.

Component	Boiling temp (°C)	Critical P (kPa)	Critical T (°C)	Critical volume (m <sup>3</sup> /kgmol)	Molecular weight	SG	Viscosity 50°C (cSt)	TVP (kPa)
Hypo40_13*	38	3363	2017	03171	7134	6422	0	0
Hypo50_13*	45	4545	221	02483	7013	7603	021	6845
Hypo60_13*	55	3162	221	03475	8598	666	021	4781
Hypo70_13*	65	3053	2322	03658	8569	6818	021	4431
Hypo80_13*	75	3957	261,7	0,303	83,83	774,9	0,21	26,61
Hypo90_13*	85	2907	2559	03983	9902	7047	021	172
Hypo100_13*	95	3141	2741	03813	9844	7368	021	1463
Hypo110_13*	105	3262	290	0377	105	7582	02114	8582
Hypo120_13*	115	2739	2934	04474	1117	7372	02213	6168

**Table 3.** Properties of the hypothetical components.

	Temp 1	Flow 3	Pressure 1	Flow 2
Mode	Auto	Auto	Auto	Cascade
Action	Reverse	Reverse	Reverse	Reverse
SP	140.7°C	19.37 m <sup>3</sup> /h	823.8 kPa	8.8206 m <sup>3</sup> /h
OP	52.00%	74.20%	25.30%	54.30%
Kc	250	0.1	0.5	0.2
Ti	1.33 min	0.5 min	0.7 min	0.2 min
Td	0.333 min	—	—	—
PV Minimum	125.15°C	19.37 m <sup>3</sup> /h	552.60 kPa	0.00 m <sup>3</sup> /h
PV Maximum	145.55°C	56.40 m <sup>3</sup> /h	903.58 kPa	15.80 m <sup>3</sup> /h

**Table 4.** Operational parameter Temp 1, Flow 3, Pressure 1 and Flow 2.

#### 3.1.4.2. Temp 1, Flow 3, Pressure 1 and Flow 2

**Table 5** shows the PID controller for Temp 1, Flow 3, Pressure 1 and Flow 2 that are obtained in industry input in the simulation.

#### 3.1.4.3. Temp 1, Flow 3, Pressure 1 and Flow 2

**Table 6** shows the ISE and IAE values for Temp 1, Flow 3, Pressure 1 and Flow 2 that are calculated using Microsoft Excel.

### 3.2. Steady-state modelling using HYSYS

HYSYS™ is widely used for designing a steady-state model for the Debutanizer column before the steady state is transitioned to the dynamic model. Within HYSYS™, steady-state

Controller settings	Temp 1		Flow 3		Pressure 1		Flow 2	
	Real plant data	PID equation	Real plant data	PID equation	Real plant data	PID equation	Real plant data	PID equation
Kc	250	250	0.1	0.1	0.5	0.5	0.2	0.2
Ti (s)	80	3.125	30	0.003	42	0.012	12	0.0167
Td (s)	20	5000	—	—	—	—	—	—

Table 5. PID controller for Temp 1, Flow 3, Pressure 1 and Flow 2.

Controller settings	Temp 1		Flow 3		Pressure 1		Flow 2	
	Real plant data	PID equation	Real plant data	PID equation	Real plant data	PID equation	Real plant data	PID equation
ISE	2863.68	12099.97	8058.76	8108.98	1,380,285	1,313,971	892.9	2072.93
IAE	771.49	2863.68	560.32	596.14	19749.54	19406.04	193.9	394.55

Table 6. ISE and IAE for Temp 1, Flow 3, Pressure 1 and Flow 2.

simulations can be easily converted into dynamic simulations by specifying pressure/flow relationships, additional engineering details and equipment dimensions. The HYSYS™ environment consists of the basic environment and the simulation environment. The basic environment is used to select the chemical components that are involved in the simulation, as well as the thermodynamic property suitable for the components.

The simulation environment consists of the process flow diagram (PFD) and worksheet. The worksheet contains the information on every heat and flow stream which are involved in

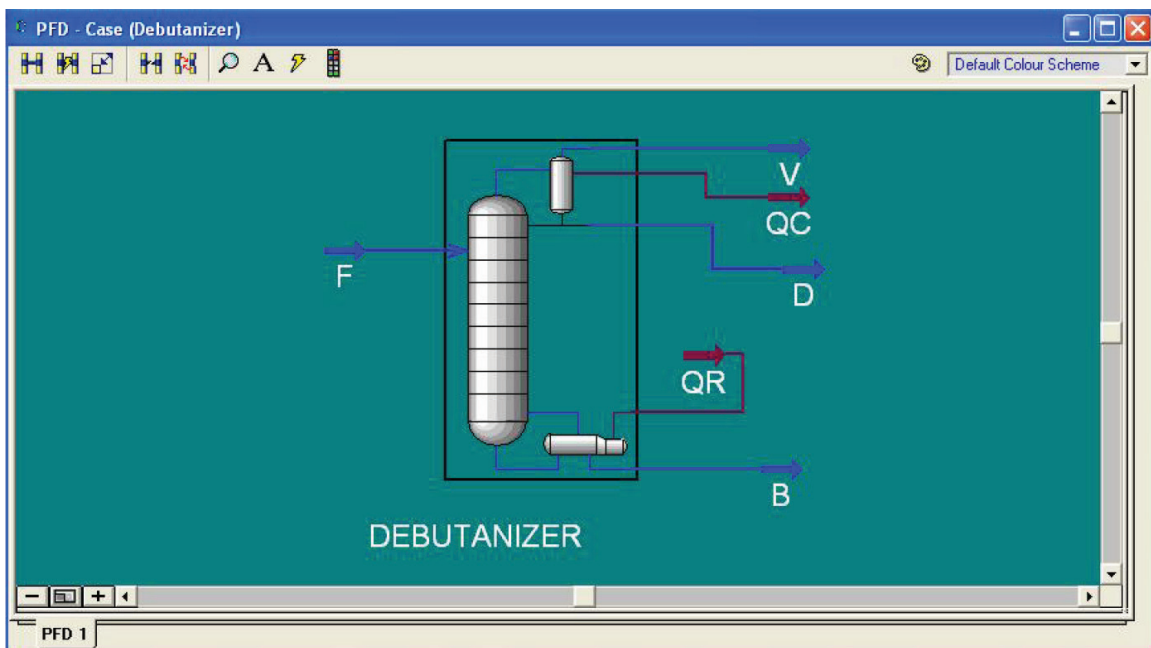

Figure 1. Process flow diagram (PFD) of debutanizer column in steady state.



the simulation. Most of the streams require inputs while HYSYS™, depend on the degree of freedom, will calculate the output streams automatically. The PFD will graphically show the unit's operation streams that are involved. The necessary information such as feed conditions, feed compositions, reflux ratio, pressure condenser, pressure reboiler and so on have to be provided for the chosen unit operation in order to be able to design the unit automatically.

### 3.3. Dynamic modelling using HYSYS

**Figure 1** shows the process flow diagram of debutanizer column and **Figure 2** shows the process flow diagram of debutanizer column in dynamic state. The setpoint that is used in

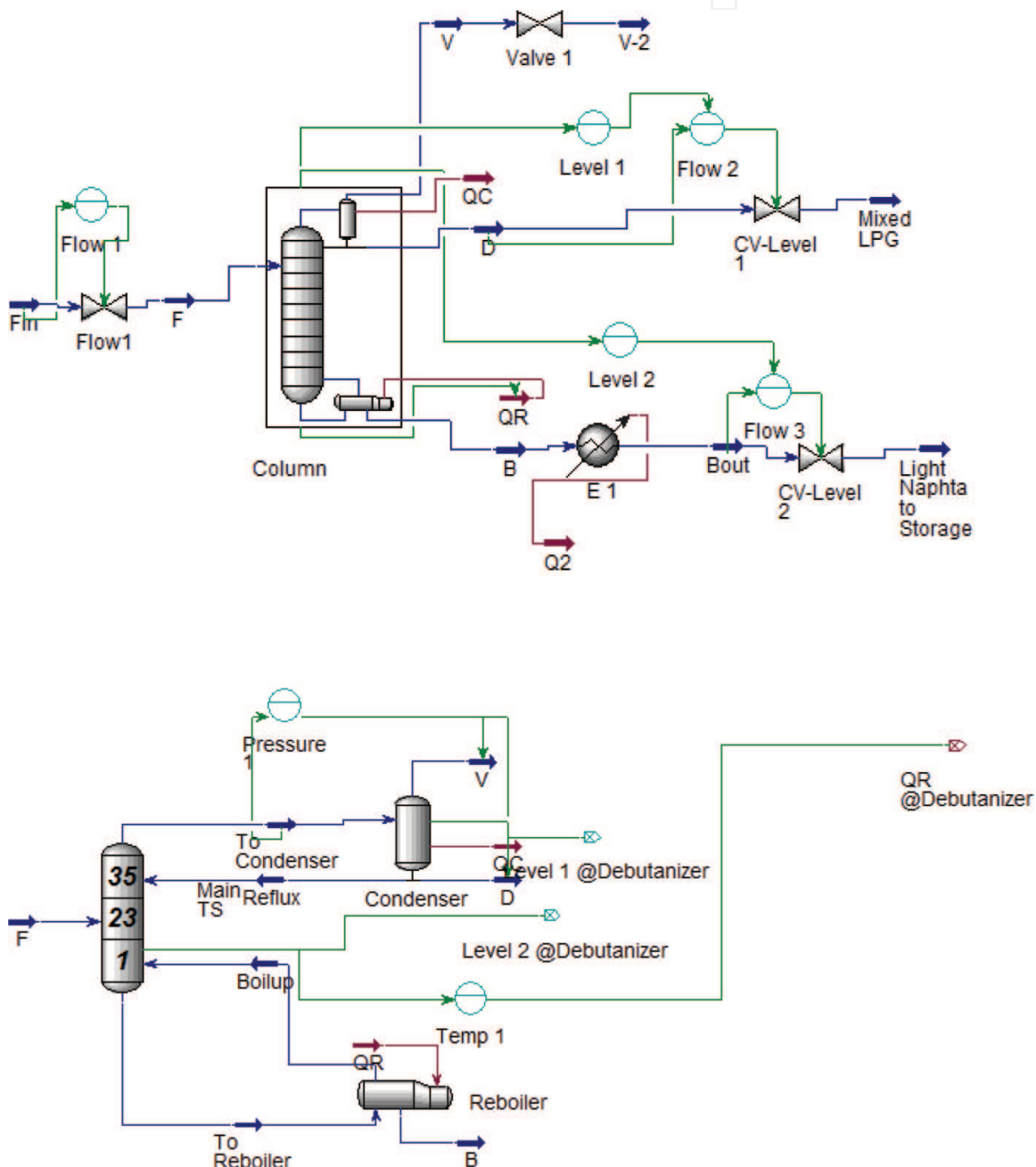

**Figure 2.** Process flow diagram (PFD) of debutanizer column in dynamic state.

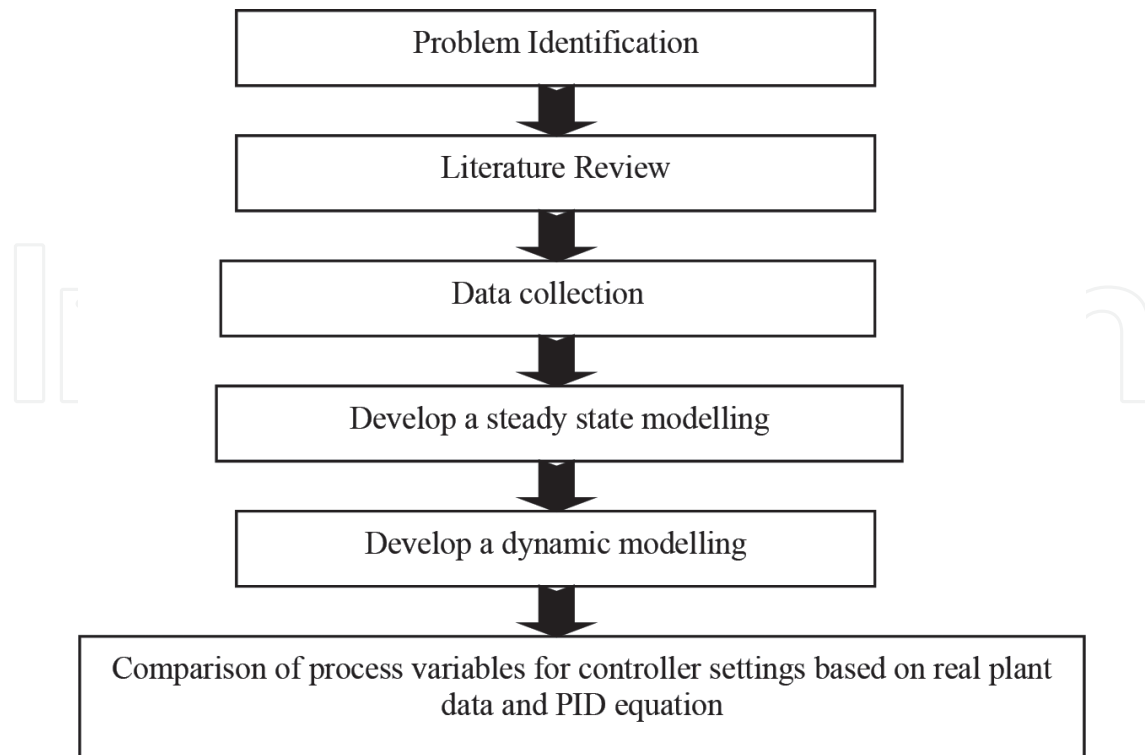

Figure 3. Flow of Modelling.

the simulation is used based on the parameter in **Table 4**. The setpoint value is fixed and then once the transition from steady state to dynamic state the change of setpoint is increased slight about 5% change from the actual setpoint in each controller in the dynamic state.

### 3.4. Approach methodology

The block diagram in **Figure 3** shows the approach that has been conducted in this chapter. Each step has been done thoroughly in order to fulfil the objective of this chapter. Furthermore, it can be done smoothly by constructing this approach.

## 4. Results and discussion

### 4.1. Comparison of process variable for controller settings based on real plant data and PID

Process variables for controller settings are based on real plant data are compared with the controller settings that are calculated using the PID equation.

PID equation

$$G_c(s) = K_c \left( 1 + \frac{1}{T_i s} + T_d s \right) \quad (2)$$

The controller variable response for all controllers are also compared with using the integral square of the error (ISE) and integral of absolute value of error (IAE) [5], where

$$ISE = \sum_{i=0} (y_{sp} - y_i)^2 \quad IAE = \sum_{i=0} | (y_{sp} - y_i) | \quad (3)$$

4.1.1. Temp 1

Figure 4 represents the process variables of reboiler outlet temperature to column for controller settings based on real plant data and PID equation. Plant data show optimum response as it fluctuates within the set point and takes a shorter time to settle. Meanwhile, PID equation response decreases dramatically and exceeds the lower limit at 1300 s. Plant data response gives the smallest value of ISE and IAE which are 2863.68 and 771.49, respectively.

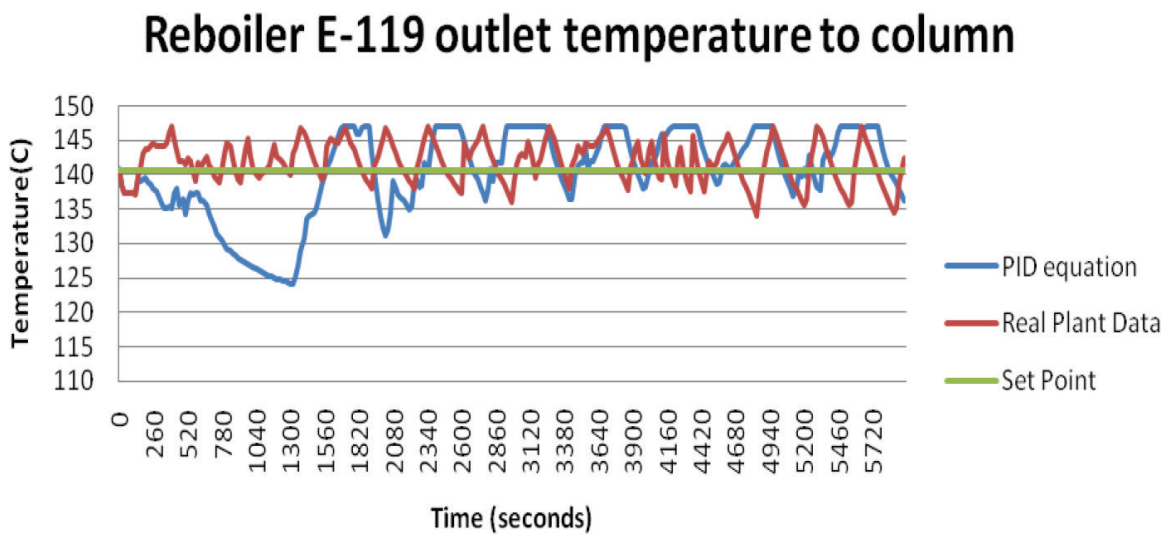

Figure 4. Process variables of Temp 1 for controller settings based on real plant data and PID equation.

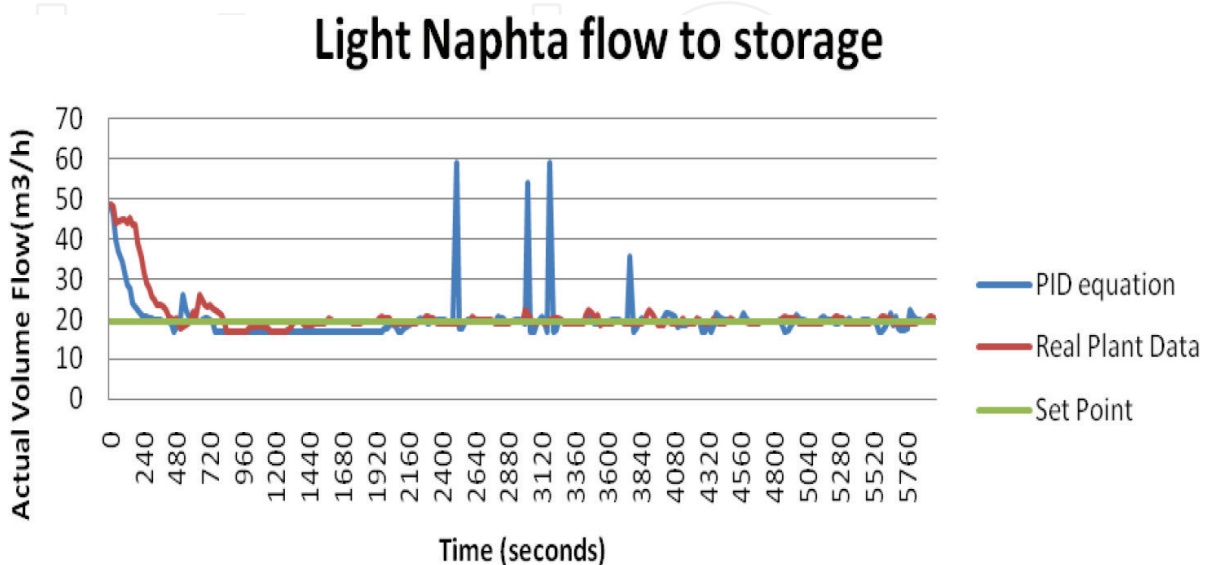

Figure 5. Process variables of Flow 3 for controller settings based on real plant data and PID equation.

4.1.2. Flow 3

**Figure 5** represents the process variables of light naphta flow to storage for controller settings based on real plant data and PID equation. The response of real plant data reaches the settling time faster than PID equation and exhibits the more stable response with no large oscillation and fluctuates within its set point. Meanwhile, PID equation response shows the large overshoot and exceeds the high limit at 2500 and 3180 s. Plant data response gives the smallest value of ISE and IAE which are 8058.76 and 560.32, respectively.

4.1.3. Pressure 1

**Figure 6** represents the process variables of debutanizer overhead pressure for controller settings based on real plant data and PID equation. The responses shows a different trend where the real plant data exhibit the larger overshoot and take a longer settling time compared to

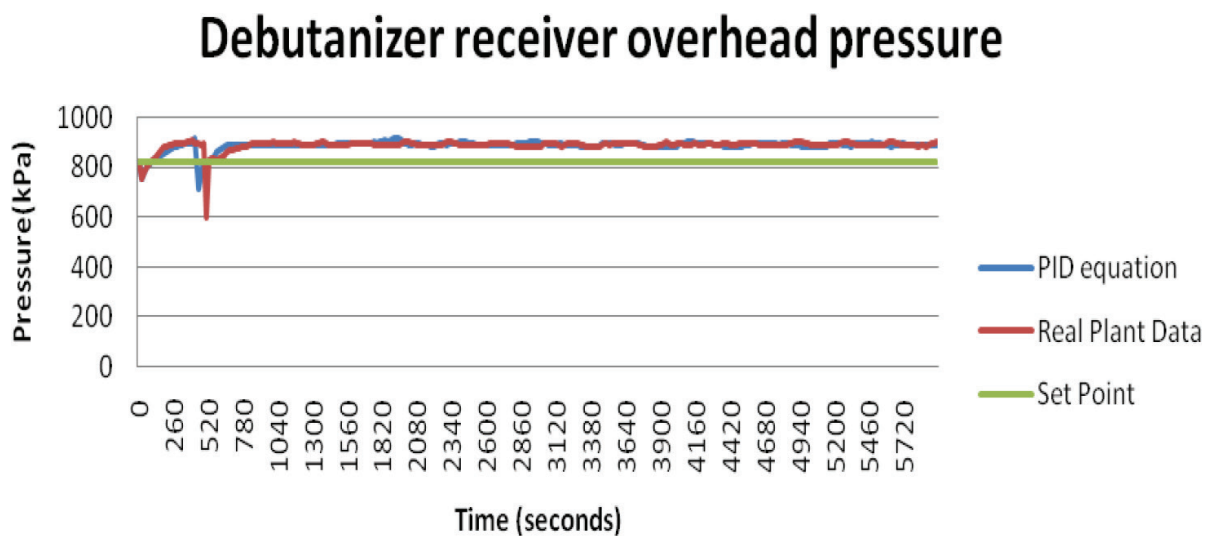

**Figure 6.** Process variables of Pressure 1 for controller settings based on real plant data and PID equation.

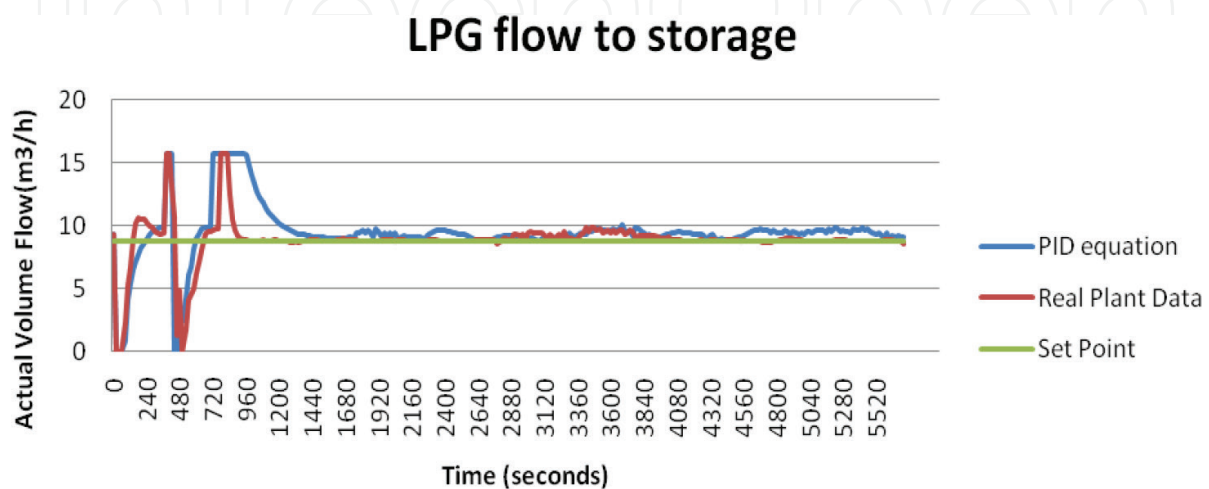

**Figure 7.** Process variables of Flow 2 for controller settings based on real plant data and PID equation.

PID equation. After both responses had settled, the responses were almost similar to the rapid and smooth response but slightly deviate from the set point. PID equation response gives the smallest value of ISE and IAE which are 1,313,971 and 19406.04, respectively.

#### 4.1.4. Flow 2

**Figure 7** represents the process variables of LPG flow to storage for controller settings based on real plant data and PID equation. The response of real plant data reaches the settling time faster than PID equation and exhibits the more rapid and smooth response compared to PID equation. Plant data response gives the smallest value of ISE and IAE which are 892.99 and 193.98, respectively.

## 5. Conclusion

This chapter is mainly about modelling a steady-state and dynamic model for debutanizer column in order to optimise the performance of the column and to identify the best tuning methods for each controller at the column. Debutanizer column in Crude Distillation Unit (CDU) of oil refinery has been chosen as a model for this chapter.

From results and discussion, it is concluded that the different tuning methods could give the different results on the behaviour of the response for each controller. The optimum response for each controller has been chosen by considering the behaviour of the response and the value of integral square of the error (ISE) and integral of absolute value of error (IAE).

All the findings obtained will be used to improve the overall performance of the plant as well as to improve the quality of the product and maximise profitability. The successful outcome of this chapter will be a great helping hand for industrial application.

### 5.1. Recommendation

1. Determine the second-order approximation of the transfer function and the process model for each controller.
2. Calculate the controller settings for PI and PID controller by using the process model that determined from the second-order approximation of the transfer function.
3. Implement the model predictive control (MPC) for each controller.

## Acknowledgements

The authors would like to acknowledge PETRONAS for providing the required data and information for the research. I would like to acknowledge University Malaya for providing the grant for the research (PS107/2010B).

## Author details

Nasser Mohamed Ramli

Address all correspondence to: [nasser\\_mramli@utp.edu.my](mailto:nasser_mramli@utp.edu.my)

Chemical Engineering Department, Faculty of Engineering, Universiti Teknologi Petronas, Bandar Seri Iskandar, Perak, Malaysia

## References

- [1] Liptak Bela G. *Instrument Engineers' Handbook: Process Control*. 4th ed. United State of America: CRC Taylor and Francis; 1995
- [2] Mohammad AW, Takriff MS. *Using Professional Simulation Software for Better Integration in the Chemical Engineering Undergraduate Curriculum*. Selangor: Universiti Kebangsaan Malaysia (UKM); 2003
- [3] Mohutsiwa Donald A. *PID Controller Tuning using Internal Model Control Method* [thesis]. University of Southern Queensland; 2006
- [4] Aidan O'D. *Handbook of PI and PID Controller Tuning Rules*. 1st ed. United Kingdom: World Scientific Publishing Co, Imperial College Press; 2003
- [5] Karacan S, Hapoglu H, Aplbaz M. Multivariable system identification and generic model control of a laboratory scale packed distillation column. *Applied Thermal Engineering*. 2007;**27**:1017-1028. DOI: 10.1016/j.applthermaleng.2006.07.032
- [6] Available from: [http://www.separationprocesses.com/CourseWare/Experiments/DT\\_Prac05a.htm](http://www.separationprocesses.com/CourseWare/Experiments/DT_Prac05a.htm) [Accessed: June 01, 2003]
- [7] Available from: [http://www.aspentech.com/publication\\_files/ertc2004\\_alsop\\_ferrer.pdf](http://www.aspentech.com/publication_files/ertc2004_alsop_ferrer.pdf) [Accessed: August 01, 2003]
- [8] Available from: <http://www.cheresources.com/invision/lofiversion/index.php/t5568.html> [Accessed: October 1, 2003]
- [9] Available from: [http://en.wikipedia.org/wiki/Liquified\\_petroleum\\_gas](http://en.wikipedia.org/wiki/Liquified_petroleum_gas) [Accessed: December 01, 2003]
- [10] Available from: [http://en.wikipedia.org/wiki/PID\\_controller](http://en.wikipedia.org/wiki/PID_controller) [Accessed: January 01, 2004]
- [11] Muda TZT. *SKG16: Advance Simulation Inc. Dynamic–Level 3*. Malaysia: Institute of Science PETRONAS; 2006
- [12] *Training Manual for Crude Distillation Unit of Oil Refinery*. Malaysia: Institute of Science PETRONAS; 2006

