



**SAMUEL
ROCHA NEVES
PINTO MOREIRA**

**TÉCNICAS DE LOCALIZAÇÃO FINA DE VEÍCULOS
POR RÁDIO-FREQUÊNCIA**

**FINE-GRAINED VEHICLE LOCALIZATION USING RF
AND ULTRASOUND**



**SAMUEL
ROCHA NEVES
PINTO MOREIRA**

**TÉCNICAS DE LOCALIZAÇÃO FINA DE VEÍCULOS
POR RÁDIO-FREQUÊNCIA**

**FINE-GRAINED VEHICLE LOCALIZATION USING RF
AND ULTRASOUND**

Dissertação apresentada à Universidade de Aveiro para cumprimento dos requisitos necessários à obtenção do grau de Mestre em Engenharia Electrónica e Telecomunicações, realizada sob a orientação científica do Doutor José Alberto Gouveia Fonseca, Professor Associado do Departamento de Electrónica, Telecomunicações e Informática da Universidade de Aveiro.

Dedico este trabalho aos meus pais.

O júri

Presidente

Professor Doutor Paulo Bacelar Reis Pedreiras
Professor Auxiliar, Universidade de Aveiro

Vogais

Professor Doutor Paulo Alexandre Ferreira Neto Alves Afonso
Professor Coordenador, Universidade de Aveiro

Professor Doutor José Alberto Gouveia Fonseca
Professor Associado, Universidade de Aveiro

Agradecimentos

Gostaria de agradecer ao meu orientador Prof. Doutor José Alberto Fonseca por me ter possibilitado a realização desta dissertação, assim como por me ter guiado durante a mesma. Uma palavra também para o meu co-orientador, Prof. Doutor Rui Escadas, pela ajuda prestada em momentos importantes.

Um abraço para o Rui, companheiro e amigo com quem desenvolvi parte do trabalho aqui apresentado.

Agradeço também à instituição Universidade de Aveiro e ao Departamento de Electrónica, Telecomunicações e Informática, pelas condições que me proporcionou tanto para a conclusão do ensino superior como para o desenvolvimento deste trabalho.

Por último, e sem dúvida o maior agradecimento, vai para os meus pais António e Almira, e irmã Marta, pelo carinho e apoio incondicional prestado durante todo o meu percurso académico.

A todas estas pessoas e instituições, o meu muito obrigado.

Samuel Rocha Neves Pinto Moreira

Palavras-chave

Rádio-Frequência, Ultra-Sons, IEEE 802.15.4, Sistema Híbrido, Localização Outdoor, Localização Veicular.

Resumo

Este documento descreve um sistema de localização veicular destinado a estacionamento exterior. Este sistema oferece vantagens tanto para os utilizadores (pessoas que dirigem os veículos) como também para as pessoas que têm como função a gestão e o controlo do estacionamento.

Hoje em dia existe quase um veículo por pessoa condutora, fazendo deste um dos transportes mais utilizados. Um grande problema nesta escolha surge no momento de estacionar no exterior, onde existem diferentes formas de o fazer, no entanto nenhuma delas verdadeiramente eficientes. Tempo a procurar um lugar vago aliado ao combustível gasto nesse acto ou mesmo sistemas de pagamento rudimentares podem agora ser parte do passado.

O sistema de localização veicular apresentado aqui surge como uma possível solução para estes problemas. O método de localização é feito através de um disparo de rádio-frequência combinado com medições de distâncias com ultrasons, aplicando posteriormente a técnica de trilateração. Pela visão do utilizador, pode ser tão simples como clicar num comando pessoal no início e fim de estacionamento, pagando antes ou depois o tempo utilizado por um método conveniente. Para quem gere o parque de estacionamento, este sistema traz o grande benefício de controlar todos os lugares em tempo real através de um único computador, assim como muitas outras vantagens.

Em termos tecnológicos, o comando pessoal consiste num sistema embutido composto por um microcontrolador e um transceptor de comunicações segundo a norma 802.15.4, o qual comunica com os elementos da infraestrutura. Além do mais contém ainda um módulo de ultrasons para ajudar a localizar o lugar de estacionamento onde está o veículo.

Aproveitando a evolução tecnológica podem ser criadas aplicações para muitos dispositivos, como smartphones ou tablets, para mapear lugares livres, controlar o estacionamento e a segurança do veículo durante este ou mesmo oferecer facilidades de pagamento, aumentando a comodidade e poupando tempo e dinheiro ao utilizador.

Keywords

Radio-frequency, Ultrasounds, IEEE 802.15.4, Hybrid System, Outdoor Localization, Vehicle Localization.

Abstract

This document describes a vehicular localization system aimed for outdoor parking. This system offers advantages for the users (people who drive the vehicle) as well as for the people whose function is the parking management and control.

Nowadays there is almost one vehicle per driving person, being this transport one of the most used. One big problem of this choice of individual transport is the parking of the car outdoor. Parking lot search time and fuel waste or even inefficient payment systems can now be part of the past.

The vehicular localization system presented here tries to propose a solution for these problems, which affect everyone, sometime. The localization method combines a radio-frequency burst with distance measurement using ultrasounds, and then trilateration to calculate the exact point. From the user view, it can be as simple as clicking on a personal remote control at the time of start and stop parking, paying the parking time pre/after it through a convenient method. For the parking manager, this system brings the benefit of controlling the parking occupation in real time, through a single computer, as well as many others advantages.

In what concerns technology, the remote control consists in an embedded system composed by a microcontroller and an 802.15.4 standard transceiver, which communicates with the infrastructure elements. Furthermore it contains an ultrasound module to help in the parking lot localization where the vehicle is.

Leveraging the technological evolution, it can be created applications for many devices, as smart phones or tablets, to map free spots, control the parking period and vehicle security during user absence or even offer payment facilities, increasing user's comfort and saving him/her time and money.

Table of Contents

Table of Contents	1
List of Figures	5
List of Tables	7
Abbreviations and Acronyms	9
1. Introduction.....	11
1.1 Framework and Motivation.....	11
1.2 Structure of the Thesis.....	12
1.3 Brief Glimpse of the Results Achieved	13
2. State of the Art.....	15
2.1 Introduction.....	15
2.2 Parking Systems and Technologies	15
2.2.1 Parking Meter	15
2.2.2 Barrier Gates	16
2.2.3 Video-based Detection	17
2.2.4 Wireless Sensor	17
2.2.5 Mobile Parking.....	18
2.3 Localization Based on Ultrasonic Systems	18
2.3.1 Active Bat	19
2.3.2 Cricket	20

2.3.3	Dolphin	20
2.3.4	Parrot	21
2.4	State of the Art Conclusion	22
3.	Requirements	25
3.1	Brief Description of the Localization System and its Architecture	25
3.1.1	User's View	25
3.1.2	Decision Maker's View.....	26
3.1.3	Installation Scenario	27
3.2	Operating Principle	28
3.3	Technical Solutions.....	30
3.3.1	IEEE 802.15.4 @ 2.4GHz.....	30
3.3.2	Ultrasonic Sensors.....	31
3.4	The μ MRF Module	33
3.4.1	Characteristics.....	34
3.4.2	Consumptions.....	34
3.4.3	Hardware.....	35
3.4.4	Motivation to use the Module	36
4.	Development of the Solution	37
4.1	PRC Unit	37
4.1.1	Program Code Algorithm	37
4.1.2	Transmission of the RF and the Ultrasonic Pulses.....	39
4.1.3	Circuit Design of the Ultrasonic Transmitter Module	40
4.1.3.1	Concept Circuit Design	40
4.1.3.2	Expansion of the Circuit Design	41
4.1.4	PCBs of the PRC Unit.....	43
4.2	Infrastructure Unit	44
4.2.1	Program Code Algorithm	45
4.2.2	Circuit Design of the Ultrasonic Receiver Module	47

4.2.3	PCBs of the Infrastructure Unit	50
4.3	Master Infrastructure Unit	51
4.3.1	Program Code Algorithm	52
5.	Tests and Results	55
5.1	Power Consumption Tests.....	55
5.1.1	Ultrasonic Modules Power Consumption	55
5.1.2	Localization System Power Consumptions	57
5.2	Indoor Tests.....	58
5.2.1	Distance Range with the PRC Unit with Only One Sensor	58
5.2.2	Distance Range of the PRC Unit.....	62
5.2.3	Calibration	65
5.2.4	Pre-Trilateration.....	68
5.2.4.1	Measurements with Random Layouts of the Infrastructure Units	69
5.2.4.2	Measurements with a Fixed layout.....	70
5.3	Outdoor Tests.....	72
5.3.1	Distance Range of the System Outdoor.....	72
5.3.2	Distance Range in the Presence of Obstacles	75
6.	Conclusions and Future Work.....	77
	References	81

List of Figures

Figure 1 - Block diagram of the parking steps from the user's view.....	26
Figure 2 - Block diagram of the decision maker's view.....	27
Figure 3 - Installation scenario.....	28
Figure 4 - Operating principle.....	30
Figure 5 - The ultrasonic transceiver MCUSD16A40S12RO.....	32
Figure 6 - Sensitivity characteristics.....	32
Figure 7 - Sound Pressure Level characteristics.....	33
Figure 8 - Directivity in overall sensitivity.....	33
Figure 9 - The μ MRF module [20].....	35
Figure 10 - The RF transceiver MRF24J40MA.....	36
Figure 11 - Block diagram of the program algorithm.....	38
Figure 12 - Response time of the μ MRF module.....	39
Figure 13 - Concept circuit design of the ultrasonic transmitter module.....	40
Figure 14 - Expansion of the circuit design.....	42
Figure 15 - PRC unit.....	43
Figure 16 - Block diagram of the program code algorithm.....	45
Figure 17 - Circuit design of the ultrasonic receiver module.....	47
Figure 18 - Infrastructure Unit.....	50
Figure 19 - Block diagram of the program code algorithm.....	52
Figure 20 - Test condition.....	58
Figure 21 - Maximum distance range comparison.....	61
Figure 22 - Measurement error comparison.....	61
Figure 23 - Devices under test.....	62
Figure 24 - Maximum distance range comparison for US transmitter supplied by 12V.....	64

Figure 25 - Maximum distance range comparison for the US transmitter supplied by 17,5V	64
Figure 26 - Measurement error for the third pair.....	65
Figure 27 - Linear regression	66
Figure 28 - Test devices	68
Figure 29 - Measurement acquisition made with Realterm.....	71
Figure 30 - Maximum distance range outdoor vs indoor.....	74
Figure 31 - Measurement error outdoor vs indoor	75
Figure 32 - Vehicle's windshield as an obstacle	76

List of Tables

Table 1 - Comparison of the parking systems features	23
Table 2 - Comparison of the hybrid systems features	24
Table 3 - Current consumption of the μ MRF module [20].....	34
Table 4 - US Transmitter module total cost	44
Table 5 - US Receiver module total cost	51
Table 6 - Current consumptions of the ultrasonic transmitter module.....	56
Table 7 - Current consumptions of the ultrasonic receiver module	56
Table 8 - Current consumptions of the PRC unit	57
Table 9 - Current consumptions of the Infrastructure Unit	57
Table 10 - Measured distances with the US transmitter supplied by 12V	59
Table 11 - Measured distances with the US transmitter supplied by 17,5V	60
Table 12 - Measured distances for the US transmitter supplied by 12V and 17,5V	63
Table 13 - Calibration of table 12 for the 12V values.....	67
Table 14 - Measured distances made with random layouts of the Infrastructure Units	69
Table 15 - Measured distances with an Infrastructure Units fixed layout	70
Table 16 - Measured distances outdoor	73
Table 17 - PRC maximum distance range.....	77

Abbreviations and Acronyms

3D	Three-Dimensional
AGC	Automatic Gain Control
CPU	Central Processing Unit
CSMA-CA	Carrier Sense Multiple Access-Collision Avoidance
DSP	Digital Signal Processor
DSSS	Direct Sequence Spread Spectrum
EEPROM	Electrically Erasable Programmable Read-Only Memory
GPS	Global Positioning System
I2C	Inter-Integrated Circuit
IEEE	Institute of Electrical and Electronics Engineers
ISM	Industrial, Scientific and Medical
IU	Infrastructure Unit
LED	Light-Emitting Diode
MAC	Media Access Control
MIPS	Millions of Instructions per Second
MIU	Master Infrastructure Unit
MS	Main Server
PC	Personal Computer
PCB	Printed Circuit Board
PIC	Peripheral Interface Controller
PRC	Personal Remote Controller
RF	Radio-Frequency
RFID	Radio-Frequency Identification
RISC	Reduced Instruction Set Computing

SMD	Surface-Mount Device
SNR	Signal to Noise Ratio
SPI	Serial Peripheral Interface
SPL	Sound Pressure Level
TDoA	Time-Difference of Arrival
US	Ultrasounds
USART	Universal Synchronous Asynchronous Receiver Transmitter
USB	Universal Serial Port
XLP	Extreme Low-Power

1. Introduction

1.1 Framework and Motivation

The localization of people and objects constitutes an interesting issue both for academic as for industrial purposes. Such localization systems diverge in a variety of applications, such as the localization of people, vehicles, transport fleets, hospital items, or the control of goods stock, statistical processes, as many others.

Nowadays a high percentage of people use a personal vehicle as means of transport. As a result of that the traffic increases everywhere and new environmental and management problems arise. An example of those problems comes at the time of parking the vehicle. While for the indoor case there are plenty of options and systems, in the outdoor case exists a few ways to do it, however none of them truly efficient.

This project intends thus to offer an efficient solution to the outdoor parking, and to cope with that intention, a vehicular localization system aimed for outdoor was developed. The system has the goal to be an advantage not only for the users, the people who drive the vehicles, but also for those whose function is the parking management and control. Furthermore the system aims to be low cost, to have low power consumption and to have a small size.

The localization is performed using three measures of distance between the vehicle and three devices installed in the infrastructure positioned in known coordinates. The measurement of these three distances is made by radio-frequency and ultrasounds, the first being used to trigger the ultrasounds whose time of flight is then measured by the devices of the infrastructure. This solution is adequate not only because of its low cost but also because its easy implementation. The developed system consists in one transmission unit to install in the vehicle and three receiver units, which are included in the infrastructure devices. Each unit is composed by a radio-frequency module and an ultrasonic module. Existing modules, the μ MRFs, were used to handle the radio-frequency signals and through a microcontroller to control the system, whereas the ultrasonic modules were developed from scratch in this project.

All the system and its details will be explained throughout the document.

1.2 Structure of the Thesis

The whole document is divided into six chapters and their subchapters. All is related to the study and development of a localization system through radio-frequency and ultrasounds, beginning the first chapter to describe the motivations and objectives which lead to the realization of this project. Moreover, in the same chapter, is given a brief glimpse of the result achieved.

The second chapter, named state of the art, focuses on the study of what exists nowadays resembling this project. The state of the art is divided in two parts, one to describe the most common outdoor parking systems and technologies and other to study various localization techniques based on ultrasonic systems. For each parking system and localization technique is made a small pro and cons analyzes, and a full conclusion is presented at the end of the chapter.

The third chapter anticipates the execution of the project. There, it is made a description of the localization system and its architecture, as well as its operating principle. Furthermore are justified the technical solutions and is fully presented and analyzed the radio-frequency module, the μ MRF, which is an integral part of the developed system.

Chapter four describes then the development of what was previously announced. The ultrasonic modules and their connection with the μ MRFs are explained in detail. The electrical circuit designs and photos of the final printed circuit boards are also depicted. Diagram blocks are presented to explain the program code algorithms of the different units which compose the localization system.

Chapter five describes all the different tests that were performed in order to evaluate the localization system. A simple conclusion derived from the results is made at the end of each test. Before the field tests, still at the laboratory, the power consumption of the system and their ultrasonic modules were measured. After that a few tests were performed indoor in order to check the functionality of the whole system. Moreover, as a result of them, is explained how the measurements calibration is done. To conclude, as the system was developed aimed for vehicles localization and outside parking application, the outdoor tests are presented and compared with the indoor tests. A car windshield was tested as an obstacle to the system's communications.

Finally in the last chapter, the number six, is presented a final project conclusion and some ideas for the future work which can be developed.

1.3 Brief Glimpse of the Results Achieved

A measurement system is presented here in this document. It is composed by one transmitter and three receivers, and enables to obtain three distances through the push of a single button. Both the transmitter and the receiver units are composed by a radio-frequency and an ultrasonic module.

The transmitter unit, named Personal Remote Controller, is intended to be omnidirectional and thus is composed by six transceivers mounted in circle. When its ultrasonic module is supplied by 12V, dependent on the transceiver, a maximum distance range between 3,5m and 9m is obtained. On the other hand, if the ultrasonic module is supplied by 17,5V the distance range increases to a maximum between 8m and 10m.

Indoor and outdoor tests revealed a maximum measurement error of 9cm with the ultrasonic modules powered by 12V. Furthermore it was confirmed the possibility to use the system outdoor and the impossibility to use the PRC inside a vehicle.

Finally, the goals of low cost, low power consumption and small size were successfully achieved. The designed ultrasonic receiver modules have a cost of 13,97€ and, when powered by 12V, showed current consumptions of 11mA and 36mA for the standby and receiving operations, respectively. The ultrasonic transmitter module has a cost of 21,75€ and current consumptions of 20mA and 43mA for the standby and transmitting operations when powered by 12V. Furthermore, with the use of SMD technology, it was possible to create small PCBs for both ultrasonic modules.

2. State of the Art

2.1 Introduction

The act to park a car arises, logically, along with its creation. The world's first autonomous outdoor parking paid system dates from 1935, in the form of a parking meter. After almost one hundred years this rural, but functional, system is still the most used around the world. Of course it is now modernized, fully electronic with solar-powered option among others facilities, however with the same principle.

Toward a complete scenario of the state of the art, it will be presented and studied here some of the parking systems and technologies implemented nowadays around the world, as well as the ultrasonic systems most used or that can be used into localization purposes.

2.2 Parking Systems and Technologies

Besides the most modern parking meters, many others new outdoor parking systems are currently available and fully working in the market, supported and getting use of modern and actual technology. It is emphasized here five different parking systems: parking meter, barrier gates, video-based detection, wireless sensor and mobile parking.

2.2.1 Parking Meter

A parking meter [1] [2] is a device used to collect money in exchange for the right to park a vehicle in a particular place for a limited amount of time. Recent parking meters are fully electrical, being generically called multi-space meters (as opposed to single space meters) due to its capability to control multiple spaces or lots.

These devices incorporates some features such as on-screen instructions, acceptance of credit cards for payment and solar-powered option. Moreover most of them are wireless and can report problems immediately to the maintenance staff, who can then fix the meters so they not stand out of service for very long. Other advances with parking meters include vehicle detection technology, which allows the space meters to know when a vehicle is parked in its space.

An alternative to the traditional and fixed parking meter is the use of in-vehicle personal parking meters, handheld electronic devices that drivers display in their vehicle window either as a parking permit or as a proof of parking payment. They are normally pre-paid and can offer the possibility of add money (parking time) via a secure Internet site.

Pro:

- Credit card payment option

Against:

- Pre-payment, forcing to bear the risk of uncertain parking duration
- Vulnerability to coin jams, thief or vandalism
- Waste of time searching and paying the parking in the zonal meter machine

2.2.2 Barrier Gates

A barrier gate [3] is a motorized unit which raises a gate arm, from a horizontal to a vertical position, to allow the passage of a vehicle. These are a solution for space delimited vehicle parks, where all the vehicle control is made only at the park entry/exit stations.

There are many control technologies which can be aliased to an electronic barrier gate, allowing the user independence and dispensing any human operator. The most common used are ticket cards/coins, proximity cards or other objects using RFID technology, license plate recognition or even using mobile phone signals and payments.

Pro:

- Simple infrastructure
- Single control unit
- Multi access methods
- Easy maintenance and long life

Against:

- Doesn't offer car guidance
- Only for delimited parking spaces usage

2.2.3 Video-based Detection

The video-based parking system [4] [5] can be applied both for indoor as for outdoor purposes. Its infrastructure consists on video-based detection cameras, being possible for each to monitor more than thirty outdoor parking spaces at the same time. Zone or individual displays are part of the infrastructure as well, having the function, in real time, of guiding the users to the free parking spaces.

The lot occupancy status, indicated by the displays, is controlled by video analysis software which records what the outdoor cameras see. In that video sensor, the individual parking spaces are covered by analysis fields in order to be evaluated by the sensor. A comparison with a stored reference image produces then the logical value of "occupied" or "not occupied" for each individual parking space.

Pro:

- Single parking space real time occupancy
- Easy to install, adjust and move the location detector
- Low hardware and installation costs

Against:

- One camera failure provides many uncontrolled parking lots
- Different weather and lighting conditions or objects occluding some parking lots might influence the results accuracy
- Detection accuracy is attached to the camera location

2.2.4 Wireless Sensor

Parking systems using individual wireless car space sensors [6] [7] are becoming usual nowadays. Most of these sensors are magnetic, combined in several cases with other types, for instance optical or infrared. Ultrasonic wireless sensors can be used for this purpose as well.

A geomagnetic sensor determines a vehicle presence measuring the magnetic variation, while an ultrasonic sensor by measuring the distance between its position and the parking space.

For outdoor purposes magnetic sensors are buried on the pavement surface, to suit under the parked car, while ultrasonic ones are installed on fixed locals where a direct and clean view exists over the parking space. For indoor cases ultrasonic sensors are often used in ceilings.

Information detected by the sensors, like presence or flow, is then transmitted via RF signal to the related wireless zone controller, and then uploaded to the corresponding central system to actualize the whole park situation and provide parking guidance.

Since the sensors are wireless, most of them are powered up by a built-in battery, which can last more than five years. New approaches to this constraint are starting to appear on the ultrasonic cases as energy harvesting from the sun.

Pro:

- Single parking space real time occupancy
- Parking guidance system

Against:

- Hardware requirement for each parking lot

2.2.5 Mobile Parking

This is a system that allows users to manage parking zones from their mobile phone [8], through a voice call or a smartphone application. The application can locate the user position automatically through GPS, or with address insertion, and indicate whether or not is needed to pay. The time and date are also taken into account to avoid possible unnecessary payments.

Mobile parking is a pre-paid system. The principle is similar to the parking meter, in the logic that it is needed to pay before leave the car, however with the advantage to make it all through a personal phone.

Multiple services can be aliased to the system, as for example the possibility to extend a parking session through the phone.

Pro:

- No physical infrastructure needed, and consequently no maintenance, cash collection and accounting
- Allows parking monitoring and sessions extension remotely
- No surveillance needed

Against:

- Requires an online pre-register
- Smartphone dependence to fully use all services
- Pre-paid system

2.3 Localization Based on Ultrasonic Systems

Nowadays the necessity to identify and track people and objects is becoming an area of interest, both for commercial and personal purposes. The ultimate goal of such systems is

providing its users with a fast and viable method to obtain location information and appropriate content for his/her location.

As previously mentioned, this project goal is the development of a localization system using high frequency sounds, the ultrasounds, together with radio-frequency waves. Therefore it is here presented and analyzed the hybrid systems Active Bat, Cricket, Dolphin and Parrot.

2.3.1 Active Bat

The Active Bat [9] [10] is an indoor localization system through ultrasonic waves based on the principle of trilateration. A short ultrasonic pulse is emitted from a transmitter (a Bat) attached on the object to be located, thereafter is measured the times-of-flight of the pulse until reach the receivers which are mounted at known points on the ceiling. The sound speed in air is known, so it is possible to calculate the distances from the Bat to each receiver. Thereafter with three or more distances is possible to determine the 3D position of the object or person where the Bat is mounted. Moreover, by finding the relative positions of two or more Bats attached to an object, it is possible to calculate its orientation.

A central controller coordinates the Bats and the receiver chains. When a Bat is going to be located, the controller addresses it over the radio link in order to transmit the ultrasonic pulse at a known time. When its position is found by the DSP (Digital Signal Processor) calculation boards, the controller transmits the information of which Bat was triggered as well as the resulting location information to client middleware and applications. The central controller can also notice Bats when they are expected to be addressed, allowing them to sleep in the intervals between messages polling and thus substantially increase the battery lifetime.

The system can locate Bats within 9 cm of their true position for 95 percent of the measurements.

Pro:

- Both emitters as receivers units are discrete, being the bats easily transportable
- Low power consumption and low hardware cost

Against:

- Receptors require ceiling sensor grid and a high-speed serial cable connection
- Lack of scalability since multiple tags must be addressed in series to prevent interference within the positioning medium

2.3.2 Cricket

The Cricket system [10] [11] is mainly intended for indoor use. Such system is the result of six design goals: user privacy, decentralized administration, network heterogeneity, low cost, low power operation and portion-of-a-room granularity.

Complementing the Active Bat system, the Cricket system uses ultrasonic emitters to create the infrastructure and embeds receivers in the object being located. This approach forces the objects to perform all their own trilateration computations. Cricket uses the radio-frequency signal not only for synchronization of the time measurement, but also to delineate the time period during which the receiver should consider the sounds it receives.

Like the Active Bat system, Cricket uses ultrasonic time-of-flight data and a radio-frequency control signal, however this system does not require a grid of ceiling sensors with fixed locations since its mobile receivers perform the timing and computation functions.

Cricket can accurately delineate 1,2 x 1,2 square-meters regions within a room.

Pro:

- Low power consumption and hardware cost
- Privacy and decentralized scalability

Against:

- Requires a lot of manual configuration for large-scale spaces
- No central management and monitoring receiver computation

2.3.3 Dolphin

The basic positioning principle of the Dolphin system [12] is similar both to the Active Bat as to the Cricket system. It consists in wireless sensors which are capable of emitting and receiving RF and ultrasonic pulses, using both signals to determine distances between nodes.

Although resembling, Dolphin system was created to solve Active Bat and Cricket's problems concerning to their necessity to configure individually all emitters nodes when implemented in large-scale space. In the Dolphin system, location of objects is automatically determined in a distributed manner using only few manually configured references, reducing this way configuration costs.

This system presents the capability to determine 3-dimensional positioning, requiring for that the exact location of at least three nodes. It is necessary that certain receptor nodes have fixed positions, which the localization is known by the rest of the system's modules.

An accuracy of 15cm can be obtained with the Dolphin system.

Pro:

- Low cost for large-scale implementation
- Temporal multiplexing access

Against:

- Temporal multiplexing access reduces actualization rates
- Requires nodes with fixed positions

2.3.4 Parrot

This is a sensor network that uses radio to communicate data and ultrasonic measurements to range between nodes. The Parrot [13] nodes enable a low-cost means of omnidirectional ranging, suitable for localization in environments where standard localization systems such as GPS are not available or provide poor accuracy. It offers a decentralized and ad-hoc network structure that facilitates range-based localization of every node within the network. The system is indifferent to static and mobile nodes, and thus, enables a truly versatile and ad-hoc network.

Each Parrot beacon is constituted by one microcontroller, one RF transceiver and four pairs of ultrasonic transmitters and receivers arranged in a configuration such that signals can arrive from any direction. Range measurement between any beacons pairs is made available to the other beacons over a radio link.

Periodically and time spaced, each node transmits a RF and an ultrasonic signal, which will allow the receptor to determine the distance between him and the emitter through the time difference of arrival of both signals. This way the system becomes capable to determine the distance between the nodes and discover in which direction is coming the signals.

This system has a distance range up to 15m between two nodes and 2cm accuracy, having the great advantage of building an information share internal network of the relative positioning of the parrot nodes. This feature can be seen as a disadvantage as well, due to the wireless network contents localization information of all nodes, which is propitious to intrusions. Another system disadvantage is the undesirable reflections occurrences which can create false nodes.

Pro:

- Emitter direction knowledge
- Omnidirectional ranging
- Long range with precise accuracy combination

Against:

- The system can become insecure
- Reflections can create false nodes

2.4 State of the Art Conclusion

Actual parking systems offer plenty of options targeted to each case specification. Some of those are traditional, with already many years of deployment like the Parking Meter. Others, as Video Detection, Wireless Sensor, or Mobile Parking are recent creations which are starting to be implemented in real life scenarios.

Despite the possibility of all the systems here studied can be used in outdoor applications, only Parking Meter and Mobile Parking systems were created specifically for that purpose. However these systems are very different from each other. Through a usual smartphone, a registered user can do all his/her parking operations, since there is no physical infrastructure over the Mobile Parking system. In the other hand a parking meter unit is needed per vehicle's lot for the money collection and time counting. Herein a user does not need to have any type of hardware in his/her possession.

Comparing to the others three systems, the Barrier Gate is by far the most basic one, aimed exceptionally for bounded spaces and without offering any type of extra to their users. The Video Detection has the great advantage of managing many spaces through a single camera, however it is easily affected by external factors like weather, light condition, or any new object which blocks its view. Wireless Sensor system is more robust about this criteria, nonetheless a sensor is needed per vehicle's lot what increases the infrastructure cost.

Whereas for indoor situations the scenario is already satisfactory, existing well-functioning solutions to park, for outdoor scenarios there are still many features which can be created and developed. The new system which will be here presented arises as an option to this field, granting a set of unique characteristics which helps and facilitates both users and parking managers.

Following it is drawn a table where a comparison and differentiation about seven different features is made for all the parking systems analyzed here.

Table 1 - Comparison of the parking systems features

	Parking Meter	Barrier Gates	Video Detection	Wireless Sensor	Mobile Parking
Application	Outdoor	Indoor/ Outdoor	Indoor/ Outdoor	Indoor/ Outdoor	Outdoor
Parking space	Zonal	Bounded	Zonal	Zonal	Zonal
User's hardware	Not needed	Not needed	Not needed	Not needed	Smartphone
Infrastructure	One parking meter per lot	One barrier gate per park	Depends on the number of lots	One sensor per lot	Non physical
Installation	Hard	Easy	Easy	Hard	Online registration
Software requirement	No	No	Yes	Yes	Yes
Real time occupancy	No	No	Yes	Yes	Yes

Concerning localization techniques four different hybrid systems were here analyzed.

Active Bat is one of the first ultrasonic localization systems, and the oldest analyzed here. A few years later the Cricket system was created to differentiate from Active bat, in an effort to offer users privacy and to create a decentralized network where a central node was not needed to control or monitor anything.

Recent systems as the Dolphin and the Parrot tend to explore a dynamic infrastructure, where just a few or even none of the nodes need to be fixed. Consequently the scalability issue simplifies, being the network installation cheaper and easier.

What none of these systems provides is a pro-management system, where all the information about every active node in the network is managed, allowing the user to know if he/she is located or not, however without receiving his/her own localization.

To conclude the state of the art is now presented a table with a complete comparison about the key features of the four localization systems analyzed here. As it can be observed, besides the many differences, all of them share the same technique over the same technology. In other words, the four systems use Time-Difference of Arrival (TDoA) technique through radio-frequency and ultrasonic technology.

Table 2 - Comparison of the hybrid systems features

	Active Bat	Cricket	Dolphin	Parrot
User privacy	No	Yes	Yes	No
Centralized	Yes	No	No	No
Fixed infrastructure	Yes	Yes	Few	No
Scalability	Difficult/ Expensive	Difficult/ Expensive	Easy/Cheap	Easy/ Expensive
Orientation	Yes	Yes	No	Yes
Accuracy	9cm	1,2m x 1,2m	15cm	2cm
Technology	RF & US	RF & US	RF & US	RF & US
Technique	TDoA	TDoA	TDoA	TDoA

3. Requirements

3.1 Brief Description of the Localization System and its Architecture

3.1.1 User's View

The user is anyone who drives a vehicle and wants to park it in a zone where the localization system presented here is installed. The way to do it is very simple, being an advantage when is necessary to park the vehicle for a certain time period.

To use the system the user requires to previously purchase a Personal Remote Controller (PRC), a cheap and small electronic device powered up by a long-life battery. This device stays as user's propriety. Since each PRC unit has a registered vehicle associated, it is recommended their permanency in the respective one. Therefore to park the vehicle the user just needs to push his/her PRC at the times of arrival and departure of the parking zone. As a consequence of those actions the user receives in the PRC validation signals in order to know his/her park situation.

Following is presented a block diagram elucidating the parking steps whenever a user is arriving or leaving the park. The green colour symbolizes the arrival time and the blue colour the departure time.

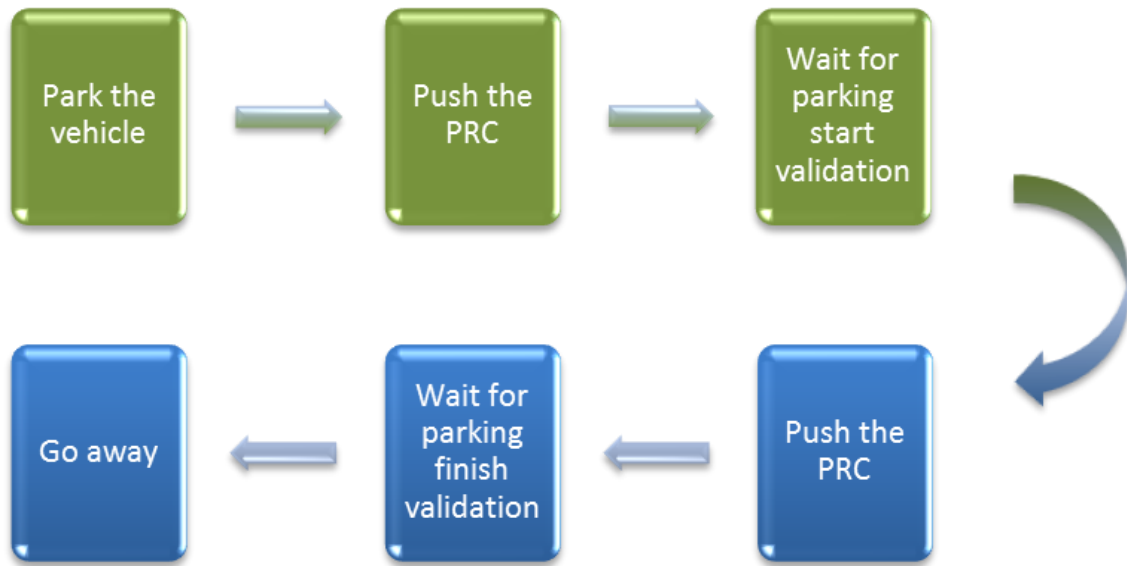

Figure 1 - Block diagram of the parking steps from the user's view

3.1.2 Decision Maker's View

The decision maker is the person or people who are in charge of the parking zone administration. For those people this system can be a significant help, since it simplifies all the parking management and control.

Communications between the system's elements are made by wire, radio-frequency or ultrasonic waves. A single RF shot from a PRC starts the localization process, being followed by ultrasonic waves in order to measure distances to fixed parking units. Thereafter to localize the user's PRC and thus his/her vehicle's lot some calculus are made with the distances obtained.

From the information of various antennas, part of the infrastructure, all the parking spaces can be supervised through a single computer in real time. A Main Server (MS) receives all the information from the parking infrastructure to process and save it. Parking information display, single lots validation and occupation time or even error detections are made through this server.

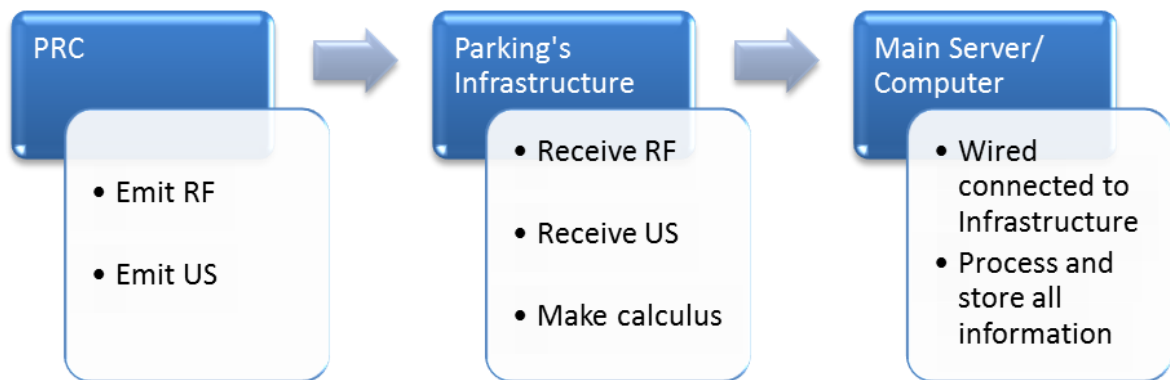

Figure 2 - Block diagram of the decision maker's view

3.1.3 Installation Scenario

Since this localization system is not based on GPS, all the PRCs request an infrastructure in the parking area to communicate with. Small antennas which are capable of receive both RF and ultrasonic signals are installed throughout the park covering the entire place. These units, defined here by Infrastructure Units (IU), can also emit RF signals allowing communications between themselves and the PRC.

One of those antennas, called here Master Infrastructure Unit (MIU), has the responsibility to collect the information from all IUs and transfer it then to the Main Server. Moreover it acts as a bridge between the MS and all the other elements of the parking system, being through this unit the user receives all possible information in his/her PRC from the parking management. Therefore such the importance of this unit it is essential to be installed on a key location, where it can be able to communicate anytime is requested with all possible PRCs or IUs prevailing in the park. Additionally its location has to be suitable for the MS since they are wired connected.

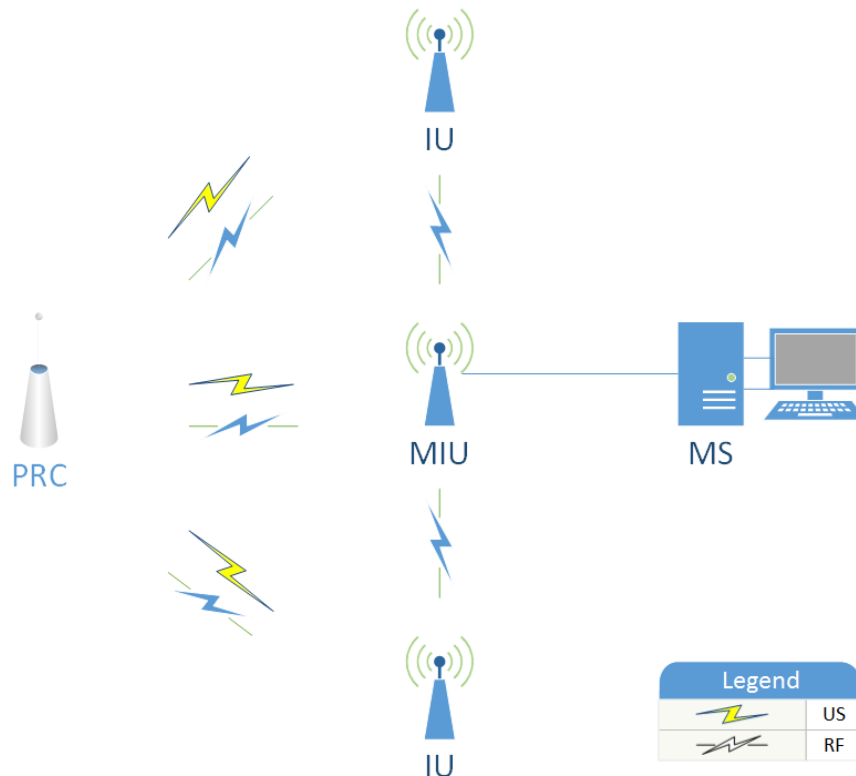

Figure 3 - Installation scenario

3.2 Operating Principle

The system starts when the user parks his/her vehicle and pushes his/her PRC. This action will make the PRC emit, simultaneously, a RF and an ultrasonic signal. These sending signals are provided by an identification datagram, unique for each PRC, being then collected by the nearest IUs. Towards the adequate operation of the system, the achievement of these signals by at least three IUs is essential, belonging to the parking manager the responsibility to well adequate their position through the parking zone.

Playing the role of receivers, each IU has to determine its distance from the respective PRC transmitter. That is possible through a technique called TDoA [14], which was already referred in the chapter of the State of the Art, however just now is explained.

Time-Difference of Arrival (TDoA)

This localization technique is based on transmission time acquisition, without clock synchronization between transmitter and receptor. For this purpose, the concerned system uses habitually two different technologies with distinct signal propagation velocities.

Both signals are shot at the same instance. The technology having the largest propagation velocity is used to start the temporal count, while the second signal reception to end it, originating the TDoA. Through the second signal propagation velocity, which is known, a distance-time relation can be obtained.

Therefore to make use of this technique each IU must contain a timer. This one is started at the receiving time of the RF signal, being only stopped by the reception of the ultrasonic signal. Afterwards the time interval value recorded by the timer is used to calculate the distance between the PRC and the IU. Finally, since the velocity of the ultrasound is known, the following formula applies:

$$\text{Distance [m]} = \Delta t \text{ [s]} \times \text{Vultrasound [m/s]}$$

Where “ Δt ” represents the time counted by the timer and “ $V_{\text{ultrasound}}$ ” the speed of sound in the air, which depends of the temperature as it can be noticed in the following formula [15]:

$$\text{Vultrasound} = 331,3 \times \sqrt{1 + \frac{T \text{ (C}^\circ\text{)}}{273,15}} \text{ [m/s]}$$

Once each IU measures its distance to the PRC, sends that information to the MIU, making this one reach it to MS afterwards. Having at least three different distance measurements from the same PRC, it is already possible to obtain an accurate value for the user’s vehicle localization.

The localization calculus is made by trilateration technique, which computes the position of an object by measuring its distance from multiple reference positions. In this case the object to compute is the PRC and the reference positions are the IU’s localizations. It is combined the measured distance from each IU to lead the system to the PRC’s position. The trilateration technique is made by the Main Server.

As soon as the vehicle localization is complete, in order to inform the user about his/her parking situation the MIU sends back a RF signal to the PRC. At that moment the user is able to see a green light meaning parking acceptance or an orange light to a parking rejection situation. In the case of a system localization error the user sees a green and an orange light simultaneously, as a request to push his/her PRC again to make another attempt. In the acceptance case the MS actualizes the situation, starting the parking time counting and changing the parking space status to occupied.

Finally at the parking off time the cycle repeats, having the MS to recognize the signal as a parking off and not a parking in, and to proceed to its finalization. To inform the user the MIU transmits an order to his/her PRC to blink three times the green led.

The next figure shows a schematic of the operating principle.

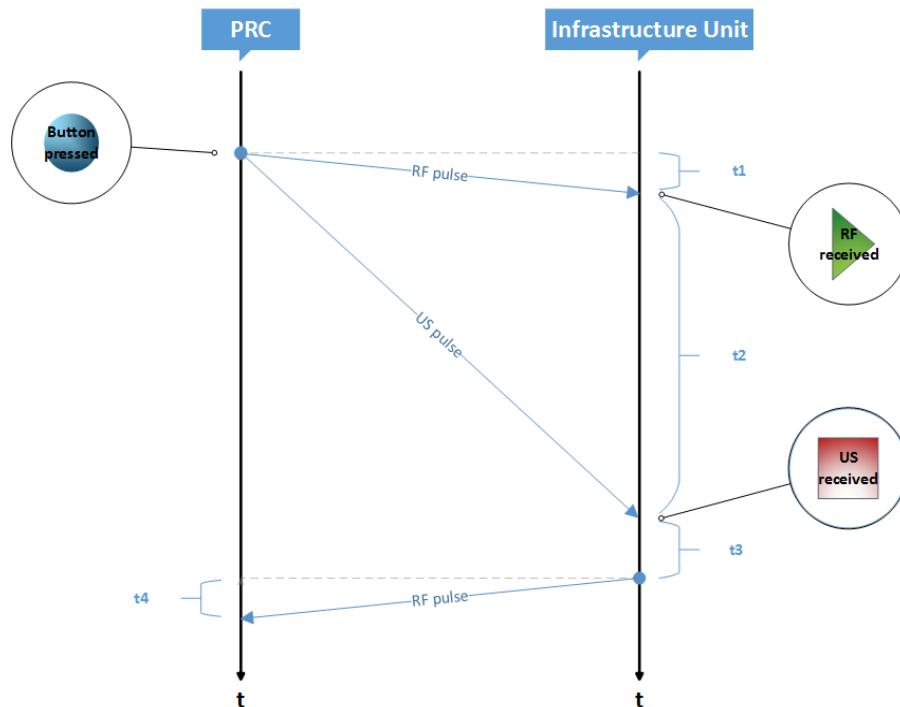

Figure 4 - Operating principle

The timer count is here denoted by “t2”, a time period which depends of the distance between the PRC and the Infrastructure Unit. The “t1”, which is much smaller than “t2”, represents the RF pulse delay from the PRC to the IU. The same for “t4” which represents the acknowledgement time from the MIU to the PRC. The “t3” represents the process time of the system to send back the acknowledge signal to the PRC.

3.3 Technical Solutions

3.3.1 IEEE 802.15.4 @ 2.4GHz

IEEE 802.15.4 [16] [17] is a standard which specifies the physical layer and media access control for low-rate wireless personal area networks (LR-WPANs). It was created by the Institute of Electrical and Electronics Engineers with the main purpose to provide a framework for low data rate communications systems.

The media access control layer is a sublayer of the data link layer. This MAC sublayer, as it is usually called, provides addressing and channel access control mechanisms that make it possible for several terminals or network nodes to communicate within a multiple access network that incorporates a shared medium.

The frequencies defined in the standard are spread among more than forty-nine different channels divided in three main bands: 868.0-868.6MHz, 902.0-928.0MHz and 2.40-2.48GHz. The lowest frequencies band is targeted to Europe, the second one to USA and the highest frequencies, containing more than sixteen channels, are used worldwide. At 2.4GHz ISM band it can be assured a bit rate of 250Kb/s.

IEEE standard 802.15.4 focuses on low-cost and low-speed ubiquitous communication between devices. The emphasis is on very low cost communication of nearby devices with little or none underlying infrastructure, intending to exploit applications requiring lower power consumption. Plus, it is adequate to work with low-duty cycles. It means the transceiver can be sleeping most of the time and thus the receiving and sending tasks can be set to take just a small part of the device's energy.

Furthermore the standard present good noise immunity since it uses a technique called "Direct Sequence Spread Spectrum" (DSSS) to modulate the information before being sent to the physical layer. This causes less interference in the used frequency bands and improves the Signal to Noise Ratio (SNR) in the receiver due to the fact that it is easier to detect and decode the message which is being sent by the transmitter. Moreover due to another technique, Carrier Sense Multiple Access-Collision Avoidance (CSMA-CA), the standard can avoid the most of interferences interdicting all the nodes to start emitting at the same time, since each node has to listen the medium prior to transmit. Regarding transmission power and reception sensibility, 802.15.4 sets the minimum amount of energy needed to transmit in -3dBm, and the minimum sensibility in the receiver in -92dBm [17].

On 802.15.4 upper layers there are several protocols using its MAC layer. The most known is probably ZigBee, although there are others such as Wireless HART, ISA-SP100 or IETF IPV6-LoWPAN.

3.3.2 Ultrasonic Sensors

Among all different types of sensors the best one to use in this project is the piezoelectric sensor, which is made with a piezoelectric material and an acoustic surface. Both of them are connected in a way that any physical change on the material geometry will affect the acoustic surface. Therefore when an electric signal is pushed through a piezoelectric material, its changes of geometric form will shake the acoustic surface geometry producing then a sound wave.

At the reception time the same principle applies. When a sound wave is received by the sensor, the acoustic surface will oscillate according to it, compressing the piezoelectric material and creating thus a correspondent voltage of the received wave.

The piezoelectric material can be made of ceramic or crystal. Piezoelectric ceramics are more versatile since their physical, chemical, and piezoelectric characteristics can be tailored to specific applications. Moreover the ceramic ones are cheaper. For all these

characteristics, piezoelectric ceramics sensors are the chosen ones to be used in this project as ultrasonic sensors.

Concerning the previous explanation and foreseeing their application in the project it was chosen the low cost MCUSD16A40S12RO ultrasonic sensor, made by Multicomp company [18], which is a transceiver having thus a dual use. These are compact and light-weight metal sensors, which present high sensitivity and high sound pressure combined with high reliability. Datasheet states a detectable range between 70cm and 18m.



Figure 5 - The ultrasonic transceiver MCUSD16A40S12RO

In the following figures are presented the beam patterns of the transceiver. Through figures 6 and 7 it can be observed that this ultrasonic sensor centers its nominal frequency at 40KHz, where it shows the highest sensitivity around -63dB and the highest SPL of approximately 118dB. Relatively to the directivity the datasheet announces 50 degrees for this sensor. Through figure 8 it can be seen the radiation characteristics for the overall sensitivity, where the signal's power loss is about -30dB to 50 degrees.

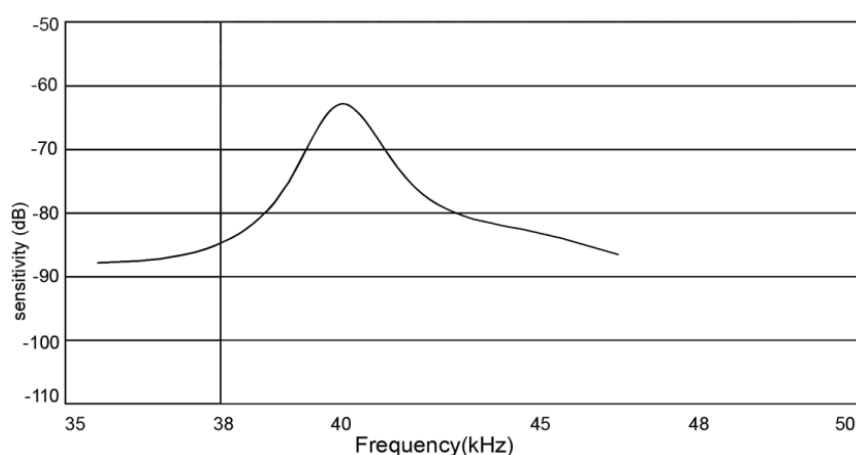

Figure 6 - Sensitivity characteristics

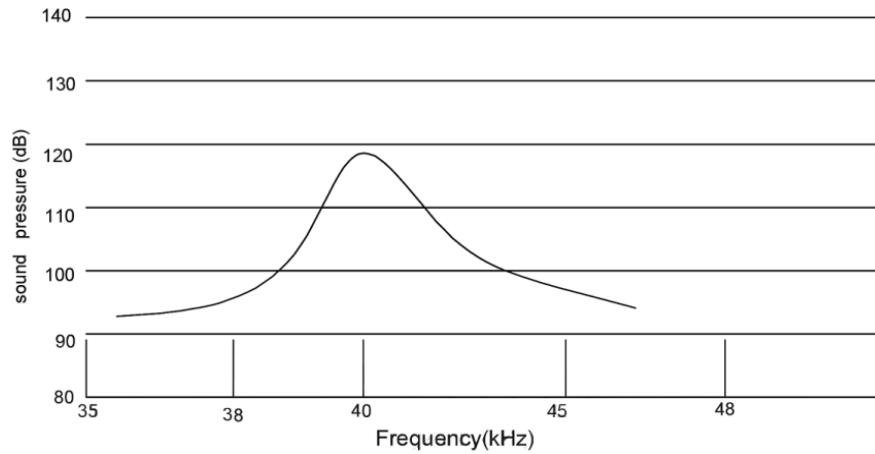

Figure 7 - Sound Pressure Level characteristics

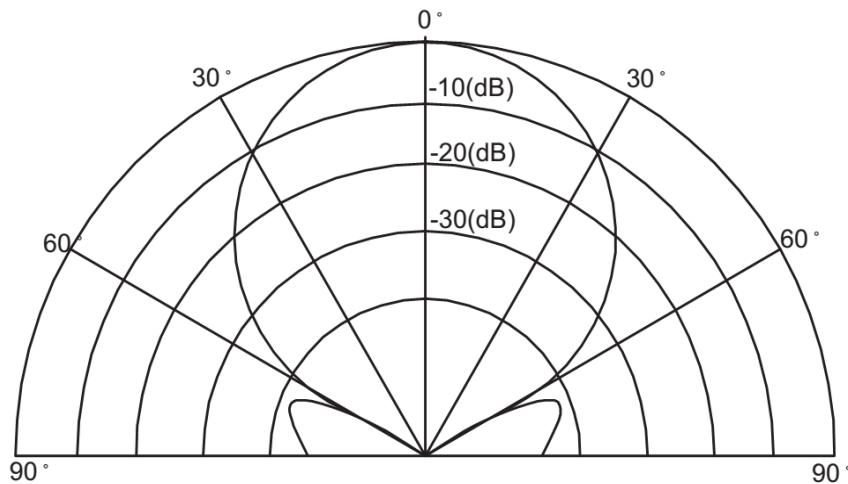

Figure 8 - Directivity in overall sensitivity

3.4 The μ MRF Module

The μ MRF module is an electronic board developed by the Micro I/O enterprise [19]. It was designed having in mind wireless systems utilization, with the responsibility to establish communications based on the IEEE 802.15.4 standard. Nevertheless, many other features are offered by this module such as temperature acquisition or the electronic board acceleration measurement.

A great advantage of the μ MRF is its low power consumption, which enhances its application under many adverse circumstances, such as when the public power grid is not accessible. In those cases the module uses a lithium ion battery, which can be charged by a personal computer through its USB interface.

3.4.1 Characteristics

The architecture of this electronic board, along with features as autonomy or the possibility to use it as a development module, allowed the inclusion of the components here identified, leading the μ MRF module to offer the following characteristics:

- Microcontroller able to operate up to 16MIPS;
- Low power wireless communication interface, under the IEEE 802.15.4 standard requisition;
- Low power digital accelerometer (approximately 400 μ A);
- USB interface;
- Powered up by battery or USB, being included a circuit to charge the battery upon connected to a PC;
- Buttons and LEDs to debug;
- Small dimensions (44mm x 44mm x 9mm);
- Three digital input/output pins;
- Existence of free software tools (academic use), which allow the development of new applications;
- The module consumptions depend mainly on the operating modes of the microcontroller and the IEEE 802.15.4 transceiver. Those consumptions are shown below.

3.4.2 Consumptions

In the following table are presented the maximum current consumptions of the μ MRF module under the different operating modes. Once the accelerometer current consumptions are much lower than the microcontroller or the transceiver ones, its state is not considered in the table.

Table 3 - Current consumption of the μ MRF module [20]

Operating mode	Current consumption
Microcontroller OFF ; Transceiver OFF	102 nA
Microcontroller ON ; Transceiver OFF	16 μ A
Microcontroller OFF ; Transceiver ON	23 mA
Microcontroller ON ; Transceiver ON	23 mA

3.4.3 Hardware

The following figure represents the μ MRF module, where the main components are highlighted and identified.

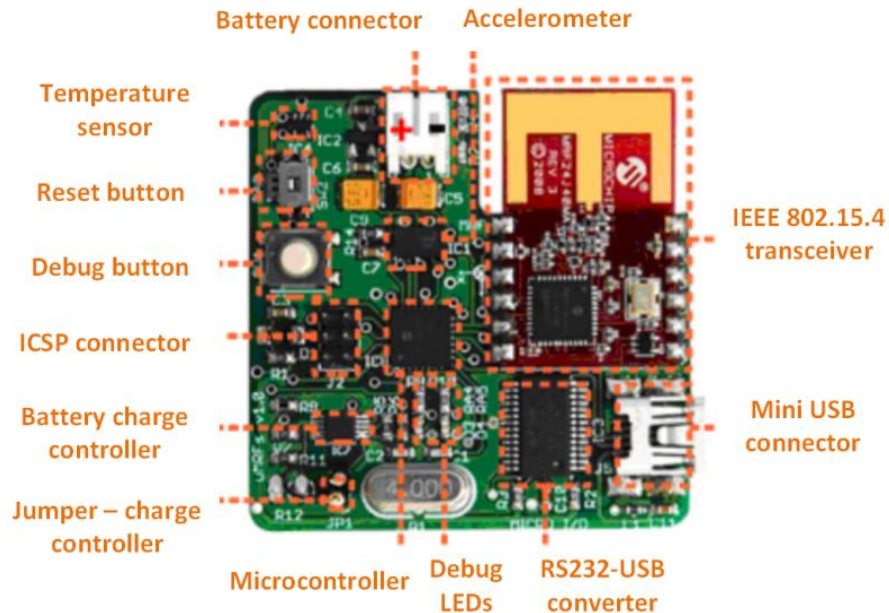

Figure 9 - The μ MRF module [20]

Among all the components identified, the transceiver and the microcontroller deserve special attention, due to their characteristics and important functions.

The MRF24J40MA, a RF transceiver module from Microchip company [21], is the component which is compliant and makes use of the IEEE 802.15.4 standard in this project. It operates at 2.4GHz with a data rate of 250kbps, and contains an on-board PCB antenna (+0dBm) to assure communications up to 120m range.

This small module (17,8mm x 27,9mm) interfaces with the microcontroller via a simple four-wire SPI (Serial Peripheral Interface). It is supplied by 3,3V and offers very low-current consumptions due to its three modes of operation, depending of being transmitting (23mA), receiving (19mA) or just sleeping (2 μ A) while awaiting an order or activation.

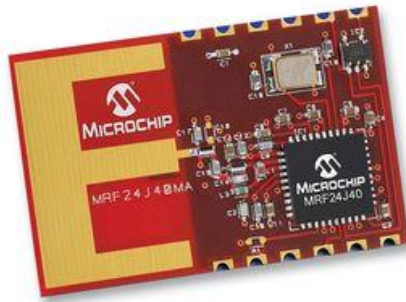

Figure 10 - The RF transceiver MRF24J40MA

In the center of all the operations stands the microcontroller. It is from it that most of all mathematic calculus and communications commands are driven by. For this project it is used the PIC18F26K20, a 28-pin flash microcontroller with XLP (extreme low-power) technology from Microchip company.

This PIC has a high-performance RISC (Reduced Instruction Set Computing) CPU with a C compiler optimized architecture, supporting up to 1024 bytes data EEPROM and 64Kbytes program Flash. Its oscillator structure shows flexibility, since it has a precision 16MHz internal oscillator and also four crystal modes up to 64MHz, being two of them external.

Operating voltage range varies from 1,8V to 3,6V and consumptions are very low, obtaining to 1,8V of operation less than 100nA to the sleep mode and less than 800nA to the standby mode and active mode with 32KHz timer1 oscillation.

Peripherally this microcontroller offers more than 35 input/output pins plus 1 input-only pin. Moreover it includes a SPI (Serial Peripheral Interface) and an I²C (Inter-Integrated Circuit) interfaces, as well as an enhanced USART (Universal Synchronous Asynchronous Receiver Transmitter) module.

3.4.4 Motivation to use the Module

The μ MRF presents relevant features to the project here developed since it is through this module the IEEE 802.15.4 standard is applied. Moreover the fact to provide three programmable pins enable the connection with the ultrasonic sensors module and, through the microcontroller, command all the wireless communications.

The USB interface together with the buttons and the debug LEDs simplifies its programming, facilitating the development of applications through simple and intuitive anomalies detection. Last but not least, the fact this module was entirely conceived by Micro I/O allows the full knowledge about its features, operation modes, limitations and potentials.

4. Development of the Solution

4.1 PRC Unit

Technologically a PRC consists of an embedded system that includes a μ MRF with an ultrasonic transmitter module, which are connected and synchronized in order to trigger both RF and ultrasonic pulses at the same instant.

Concerning signal types the PRC is thus composed by two major parts, one for the RF signal and another for the ultrasonic signal. These two parts or modules are also separated by the power supplies, since the μ MRF is powered up by 5V, being prepared for USB connection, and the ultrasonic module is powered up by 12V.

A PRC should be an autonomous unit, so it is prepared to be powered up by batteries. However, if available, the best case scenario would be the use of the common vehicle's 12V power supply.

In the following subchapters is presented and explained all the relevant software and hardware development of the PRC unit.

4.1.1 Program Code Algorithm

As mentioned before the μ MRF module includes a microcontroller. Thereby it will be here explained the firmware developed to that microcontroller in order to manage and control the whole PRC unit.

The C programming language is the software language used to program the PIC18F26K20 microcontroller. Despite the program code is not provided in this document, all the technical decisions as well as the final algorithm are explained in detail. So, below it can be seen a block diagram of the algorithm developed.

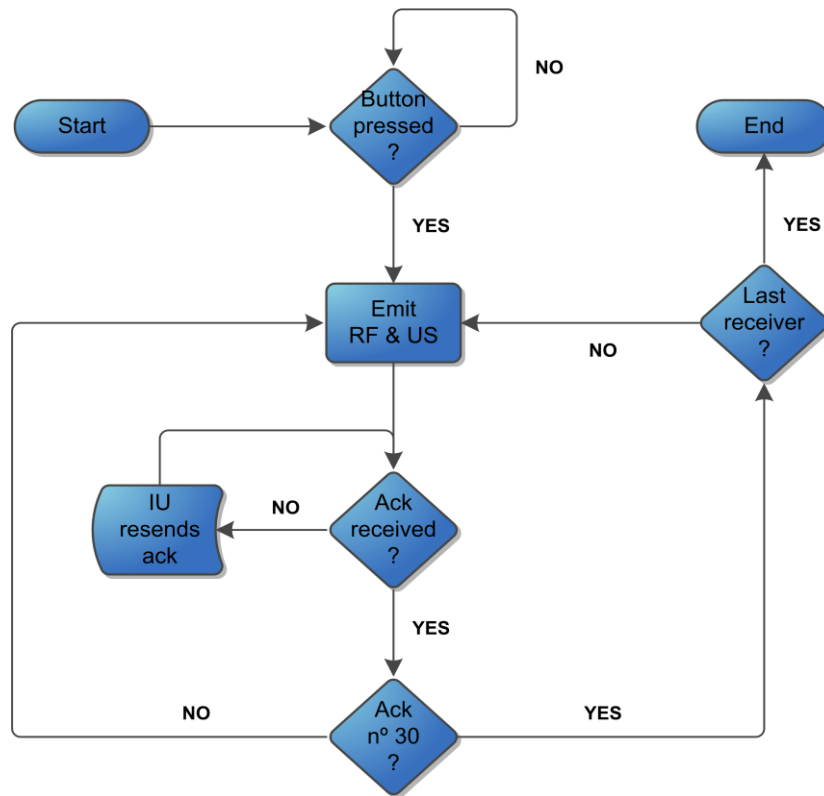

Figure 11 - Block diagram of the program algorithm

The PRC is the unit which has the power to start the whole parking system communications. This unit, when powered up, is constantly waiting in standby mode until its button is pressed. This action will be then responsible for the localization system start.

As soon as the button is pressed the system begins a cycle which only stops when all the communications between the PRC and the Infrastructure Units of the park are concluded.

The mentioned cycle starts with the transmission of RF and ultrasonic pulses, looking ahead to the reception of both pulses by the first IU specified by the PRC. If those pulses are received an acknowledge signal of return is expected. The reception of this signal is under the responsibility of the specific IU which the PRC is communicating with. It is explained below how this is done in the program of an Infrastructure Unit.

As a result of a random time delay caused by the μ MRF module, which is explained in the next subchapter, the PRC transmits thirty times both RF and ultrasonic signals to each IU. For that reason every acknowledge signal is counted and the PRC is repetitively emitting its pulses until the thirty one is received.

After the reception of the acknowledge number thirty the PRC checks if that signal is from the last IU which it needs to communicate with. If so, the program finishes and the PRC comes back to the standby mode. If not, the PRC selects another IU from the park and begins to emit its pulses heading for it.

4.1.2 Transmission of the RF and the Ultrasonic Pulses

Once each Infrastructure Unit expects a time-difference of arrival (TDoA), in order to measure an accurate distance the triggering of both RF and ultrasonic pulses needs to be simultaneous. Ensuring this condition is essential since it is proportionally associated to the localization system's accuracy.

During the project development it was detected that the time between the PRC's instruction to trigger a signal and its effective transmission is not the same for both modules. Although the ultrasonic transmitter module has a fast response, the μ MRF module reveals a significant delay time that needs to be taken in account.

This delay time is actually the response time of the module to execute the instruction to trigger a RF pulse. The response time can be observed in the oscilloscope, as it is shown in the following figure.

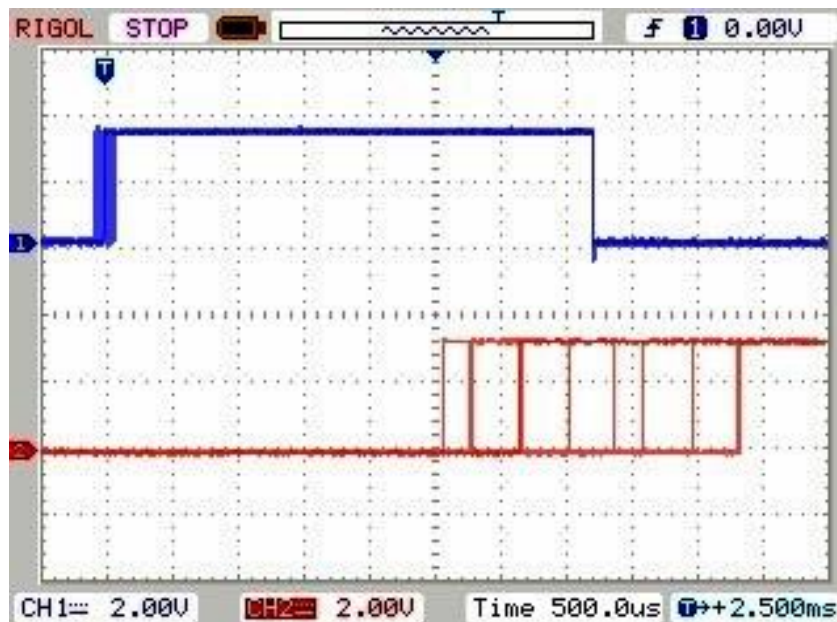

Figure 12 - Response time of the μ MRF module

The blue line corresponds to the instruction order and the red lines to the effective trigger of the RF pulses. Using the persistence mode in the oscilloscope it was possible to fix the instruction time slope and then visualize the different trigger times of the RF pulses. After pushing the μ MRF button a few dozen of times it can be observed and calculated that the response time of the module varies randomly, between eight different possibilities, from a minimum value of 2,6ms and a maximum value of 4,85ms.

Consequently the technical solution adopted was to delay the ultrasonic pulse trigger for 2,6ms and to transmit thirty times both signals. This way is ensured the simultaneous

triggering of both signals a few times of the total transmissions, leaving to the Infrastructure Unit the management of those thirty transmissions received.

Another technical decision, also of significant importance, is related to the duration of the ultrasonic pulse which is emitted by the PRC. It was tested, for a distance of three meters in line-of-sight, that the minimum pulse duration that an IU is able to receive is 100µs. However as longer range communications are expected, and knowing that a limit value is not reliable for the system, it was chosen to emit the ultrasonic pulses for 2ms. Thereby is ensured that the ultrasonic transceivers are operating at their full potential, and prevented that the system has a shorter distance of communication caused by the ultrasonic pulse duration.

4.1.3 Circuit Design of the Ultrasonic Transmitter Module

In figure 13 the ultrasonic transmitter circuit design is presented. It is simplified and divided in three main parts to help in the explanation. The complete circuit design has not one, but six ultrasonic sensors, being explained how the circuit is expanded in the next subchapter.

In this subchapter the ultrasonic transceivers are referred as ultrasonic transmitters, since at this point their function is to transmit the ultrasonic waves.

4.1.3.1 Concept Circuit Design

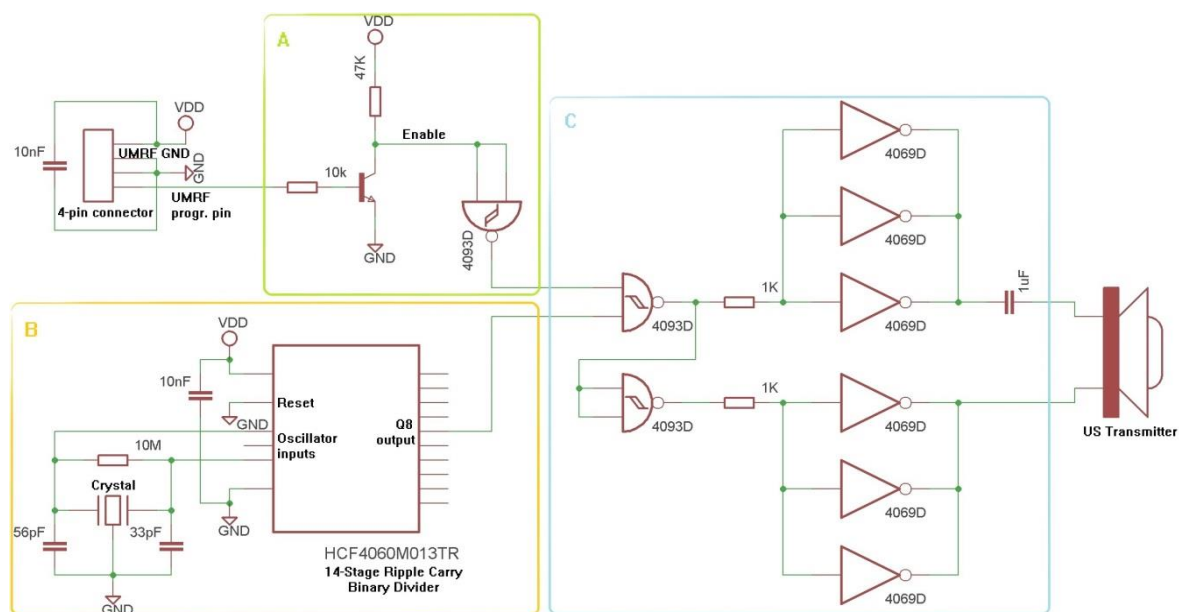

Figure 13 - Concept circuit design of the ultrasonic transmitter module

As it can be seen in the figure, this circuit includes a four-pin connector which is used to connect to the external power supply and to interface with the μ MRF module. In this point, the ground of the μ MRF module and the ground of the ultrasonic transmitter module are short circuited.

The circuit can be divided into three parts as explained below:

Part A: As it can be perceived from the system operation, the ultrasonic module should not transmit continuously. So, there is an enable signal to control its active and sleep times. The enable signal is generated by the microcontroller in one of its programmable pins. Since the μ MRF and the ultrasonic module operate with different power supplies, it is needed here a transistor to boost the μ MRF signal, which is 3,3V, to a sufficient level to drive the analog Schmitt Trigger NAND (HCF4093), which is supplied by 12V.

Part B: As previously said, the ultrasonic sensors used here operate at 40KHz. This part of the circuit provides that frequency to the sensors. The signal is obtained from a 10,24MHz crystal, connected to a 14-Stage Ripple Carry Binary Counter/Divider and Oscillator, the HCF4060. This last component is introduced here with the divider function, since there are no crystals of the desired frequency. Thereby through its Q8 output, which divides by 256 (2^8) the input signal, the 40kHz frequency is obtained.

$$10.24\text{MHz} \div 256 = 40\text{KHz}$$

Part C: Once all wireless signals suffer attenuation during their transmission, the amplification of the ultrasonic signal is essential to this circuit in order to increase the range. This part of the circuit allows getting a signal with $2V_{DD}$ amplitude, quadruplicating thus its power, without the need of another power supply. Since the input current from the modulated signal could be insufficient to the efficient generation of the ultrasonic waves it is used three inverters (CD4069) connected in parallel so the emitter sensor gets a higher current drive. Moreover, through a Schmitt trigger NAND and three additional inverters, the same sensor is also supplied with a symmetrical signal. The capacitor allows filtering any DC component, which, in the case of being too high, could damage the ultrasonic sensor.

4.1.3.2 Expansion of the Circuit Design

In order to get an enhanced efficiency the PRC should be as much omnidirectional as possible. For that reason the unit needs more than one emitter, since the ultrasonic sensor's datasheet refers only 50 degrees of directivity for their transducers, wherewith the distance range is hardly affected alongside a wider angle.

Adding emitters to the circuit is not trivial, since the power supply is fixed and thus there are power limitations to consider. Therefore the solution has to be a balance between an

attempt to preserve the long range characteristic of the transceivers and the desired goal of omni-directionality. In order to cover the maximum space the adopted solution was to equip the PRC unit with six ultrasonic transceivers. These sensors are equiangular disposed so each one is spaced by sixty degrees from the other, achieving three hundred degrees in the total and distributing the sixty degrees left between all the sensors.

In order to create and emit efficiently the ultrasonic waves the six transceivers need a correct reception of the modulated signal. The present circuit is already able to well supply two transceivers, connected in parallel, without significant loss. However to add more transceivers the circuit has to be modified. Since part A just enables the transmission, and part B creates the modulated signal, part C is the one which needs improvements. If there are more transceivers, the modulated signal needs to be more powerful. In another words, it needs to be amplified.

The solution adopted is presented in the next figure, where the Non_Inverter (N_INV) and the Inverter (INV) modulated signal, coming from the Schmitt Trigger NANDS, are connected to three amplification stages, made by the inverters. This way the modulated signal is replicated, reaching all transmitters with the same power.

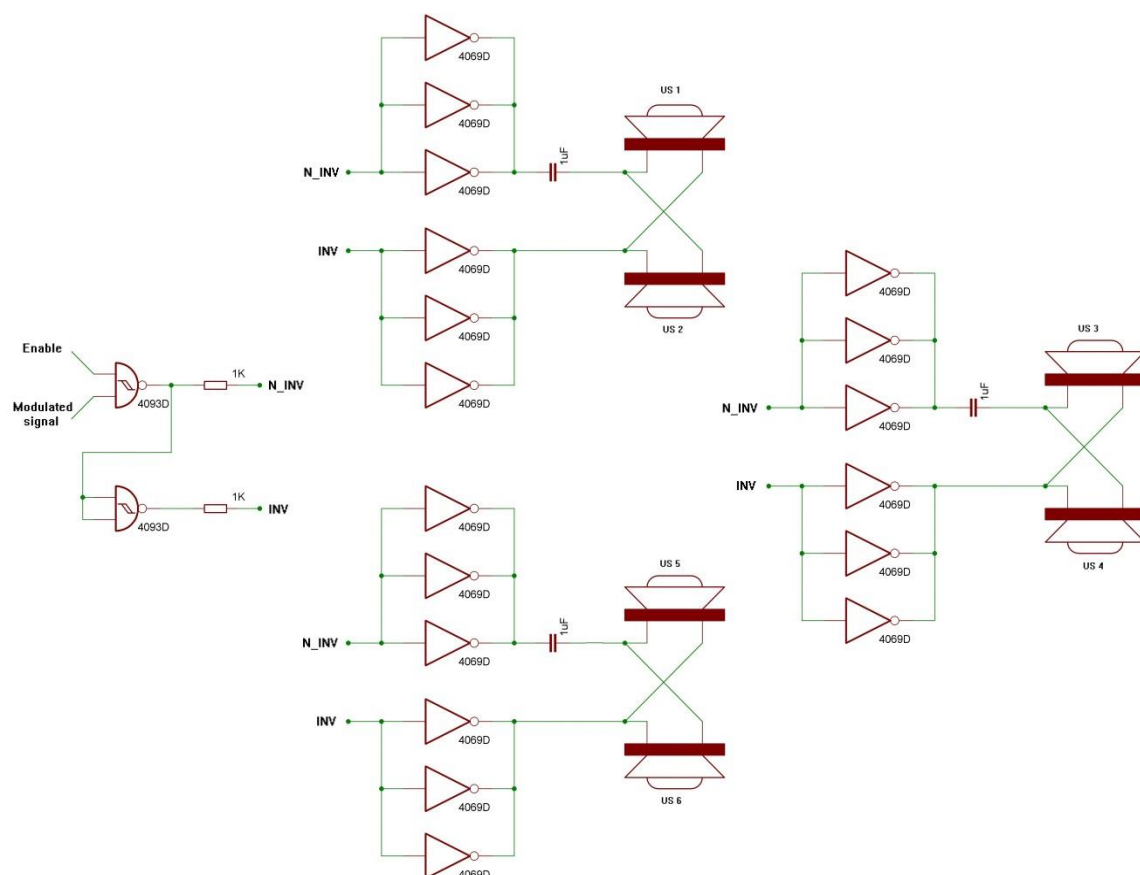

Figure 14 - Expansion of the circuit design

4.1.4 PCBs of the PRC Unit

In the following figure is presented the PRC. There it can be seen the ultrasonic transmitter module composed by its six transceivers and the μ MRF module.

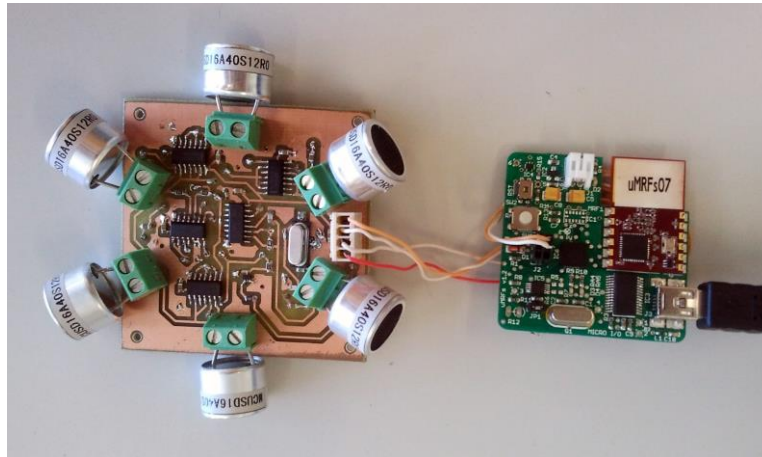

Figure 15 - PRC unit

As the μ MRF module was already presented and analyzed in the last chapter, it is just described here the development of the ultrasonic transmitter module PCB.

The printed circuit board was designed using the Eagle PCB software [22]. Although not seen in figure 15 the board is double sided, having both sides a ground plane for shielding and power return. All the components are installed in the same board side, being the other one composed only by conductive tracks.

The majority of the components are soldered directly onto the PCB surface through the surface-mount technology. Recurring to this technology it was possible to use very small devices, the SMDs (surface-mount devices), allowing thus to create a small board with a 6,1cm x 6,1cm area.

The connectors are the only devices non SMD, since they are required to mount the sensors and to establish the connection between the two modules of the PRC unit. These components, together with the sensors, make the ultrasonic transmitter module a little larger than its board, giving a height around 2cm to the module as well.

The PCB of the ultrasonic transmitter module was totally created and developed in the Department of Electronics, Telecommunications and Informatics (DETI) of the University of Aveiro.

Next is presented a table with the detailed cost of each component of the ultrasonic transmitter module, as well as its total cost.

Table 4 - US Transmitter module total cost

US Transmitter	Quantity	Individual Price	Total Cost
US Transceiver	6	2,57 €	15,42 €
Crystal 10.24MHz	1	0,76 €	0,76 €
Sch. NANDs (HCF 4093)	1	0,46 €	0,46 €
Inverters (CD 4069)	3	0,42 €	1,26 €
Binary divider (HCF 4060)	1	0,55 €	0,55 €
Capacitors	11	0,05 €	0,55 €
Resistors	5	0,22 €	1,10 €
Connector + Contacts	1	1,65 €	1,65 €
Total			21,75 €

As it can be observed the ultrasonic transmitter module has a total cost of 21,75€.

4.2 Infrastructure Unit

Likewise the PRC, Infrastructure Units are also controlled by a microcontroller and need to receive and emit radio-frequency signals, therefore these units are equipped with a μ MRF module as well. However, regarding ultrasounds, they differ completely of the PRC's hardware, once IUs do not have the goal to emit, but to receive them instead.

Technologically an Infrastructure Unit is composed of a μ MRF and an ultrasonic receiver module, as explained below.

These units are powered up by 5V (μ MRF) and 12V (US module), and since they are fixed and part of the parking infrastructure they do not need to be powered up through batteries, being consequently supplied by the parking's power grid.

In the following subchapters is presented and explained all the relevant software and hardware development of the Infrastructure Unit.

4.2.1 Program Code Algorithm

The Infrastructure Unit is composed of a μ MRF based on a PIC18F26K20. The firmware is also developed using the C language. The block diagram of the code algorithm is presented in the next figure.

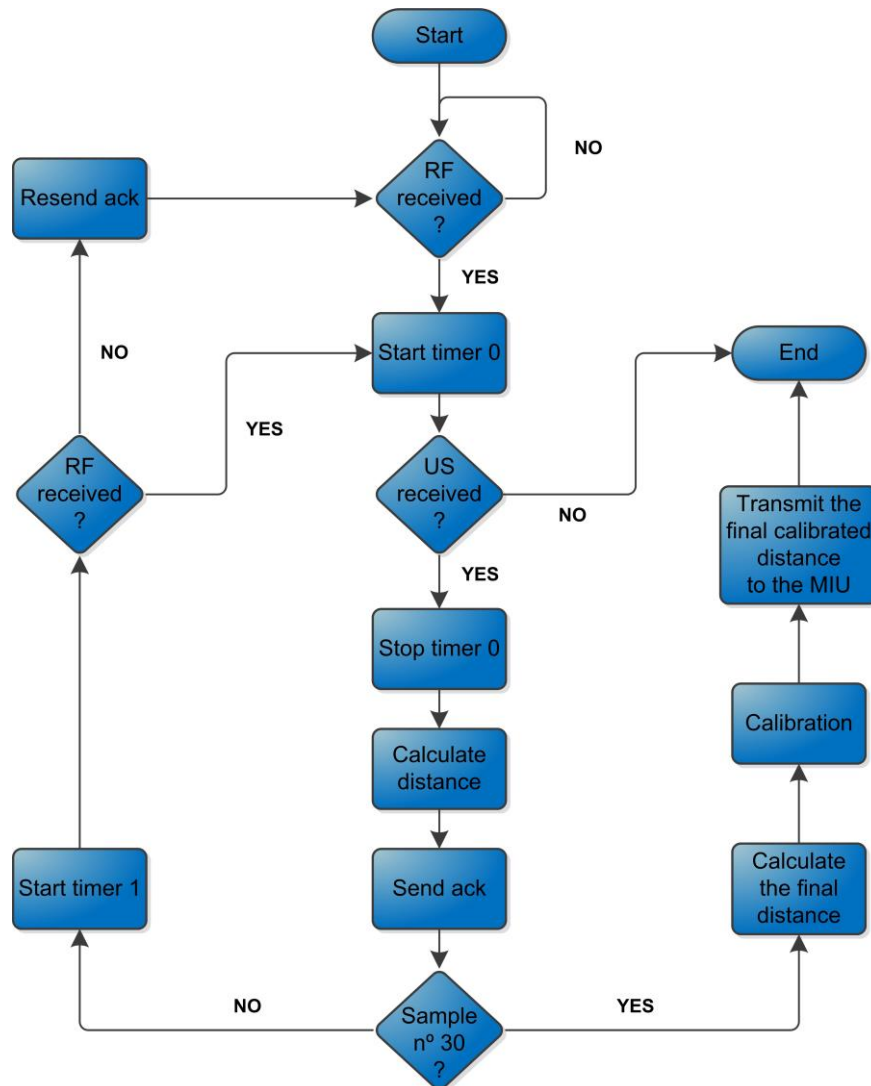

Figure 16 - Block diagram of the program code algorithm

The Infrastructure Unit is in standby mode until the reception of a specific RF pulse. As previously explained in the program code algorithm of the PRC unit, each RF pulse has an identification, which specifies the IU to communicate with. Therefore the reception of that pulse means the start of the distance measurement between the user location and the respective IU of the park.

As illustrated in figure 16 the reception of that RF pulse activates the microcontroller's timer 0. The same timer starts then to count, waiting for the ultrasonic pulse reception to stop. If the ultrasonic pulse is not received during the following 66ms, what means that the timer overflowed, the program ends. However in the best case scenario of both signals reception, the microcontroller uses the timer 0 value to calculate the distance between the two units and saves the result.

The value that timer 0 saves in its register is the number of cycles it counts. In order to convert that value into time it needs to be divided by the timer 0 frequency, which was programmed to be 1MHz. Therefore knowing the air temperature and thus the speed of the ultrasonic pulse the following formula can express the distance in meters:

$$\text{Distance [m]} = \frac{\text{timer register}}{\text{timer frequency [Hz]}} \times \text{Vultrasound [m/s]}$$

Where "timer register" value is the number of cycles counted by timer 0, "timer frequency" is 1MHz, and "V_{ultrasound}" is the velocity of the ultrasonic pulse and depends on the air temperature.

In accordance with the PRC program code algorithm, after the distance calculus the Infrastructure Unit sends back an acknowledge signal notifying the transmitter about the successful reception of its pulses. Moreover as the PRC emits thirty times its pulses the IU checks if those are from the last sample.

In the negative case the IU awaits another RF pulse to repeat the cycle and measure another distance. In order to prevent the early end of the system if the RF pulse is not received within 60ms, time counted by timer 1, the acknowledge signal is resent to the PRC. On the other hand if the last sample is detected the IU stops to receive any signal and calculates the final distance.

As previously described in the "Transmission of the RF and the Ultrasonic Pulses" subchapter the Infrastructure Unit has to manage the thirty transmissions received. Being assured by the PRC that the RF pulses are never transmitted before the ultrasonic ones, the largest calculated distances are expected to be relative to the simultaneous transmission of both pulses. Therefore the thirty distances are ordered, and since a measurement error can happen the final distance is the average calculus of the three largest ones.

Furthermore in order to enhance and improve the measurement accuracy a calibration is applied to the final distance. Since the calibration arises from the results of the first tests it will be explained only in the next chapter.

After the calibration of the final distance the IU transmits the value to the Master Infrastructure Unit through radio-frequency signal and finishes the program, returning to the standby mode.

4.2.2 Circuit Design of the Ultrasonic Receiver Module

In figure 17 is presented the ultrasonic receiver circuit design. It is divided in four different parts, from A to D, to simplify and help its explanation. After the figure it is then presented a detailed explanation of each part.

During this subchapter the ultrasonic transceivers are referred as ultrasonic receivers, since at this point their function is to receive the ultrasonic waves.

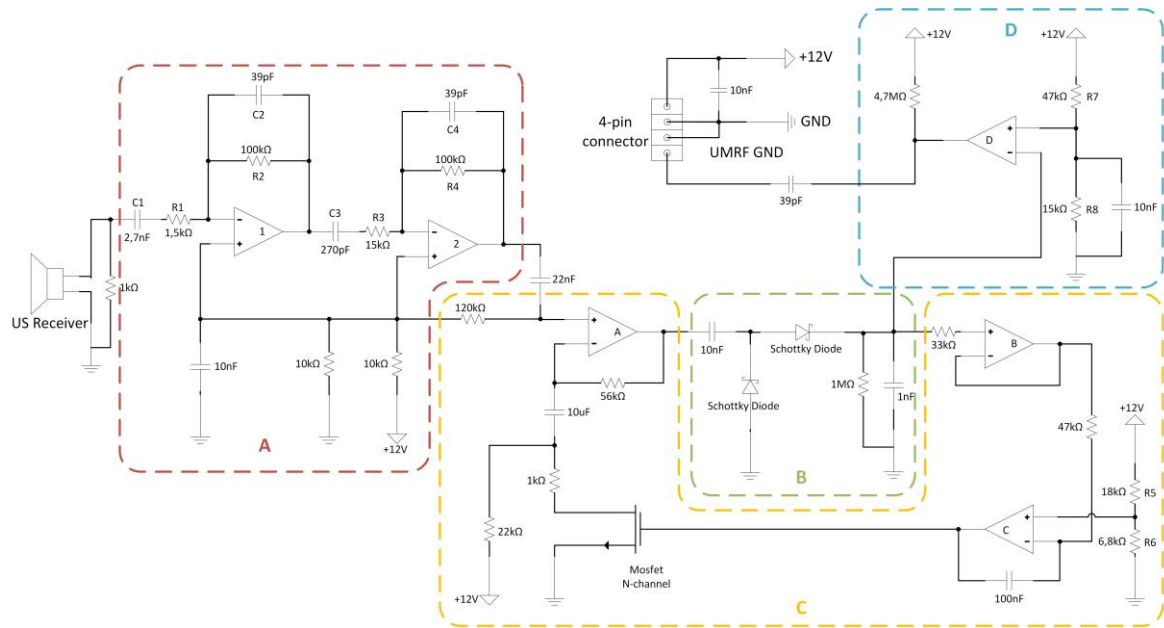

Figure 17 - Circuit design of the ultrasonic receiver module

Part A: This first part is a signal amplification circuit, which, as the name suggests, has the main goal to amplify the ultrasonic signal received by the US Receiver. Moreover, since the expected signal holds a 40KHz frequency, correlated with the gain is implemented a tight filter around that frequency to exclude from the amplification the maximum amount of noise.

The signal amplification is made by two operational amplifiers, embedded into a TL082ACD component, which ensures a supply voltage range of 6V to 36V and a 4MHz bandwidth (GBW). This component is supplied by 12V. As the driven signal has a frequency of 40KHz (B), it is easily verified that the maximum voltage gain (A_{MV}) that can be reached is 100V/V, which is sufficiently high to the purpose.

$$GBW = A_{mv} \times B \Leftrightarrow A_{mv} = \frac{4 \text{ MHz}}{40 \text{ KHz}} = 100 \text{ V/V}$$

This circuit is thus composed by two amplification stages, both under inverting configuration design. The first one has a higher gain of 66,7V/V and the second one a lower gain of 6,7V/V, since together the total gain is 447V/V and no more amplification is needed. The two amplification gains are calculated by the following expressions:

$$Av1 = -\frac{R2}{R1} = -\frac{100k}{1,5k} \cong 66,7V/V \qquad Av2 = -\frac{R4}{R3} = -\frac{100k}{15k} \cong 6,7V/V$$

Where $R1=1,5K\Omega$, $R2=100K\Omega$, $R3=15K\Omega$ and $R4=100K\Omega$.

Both amplifiers use a reference voltage of 6V on their non-inverting inputs to be polarized and consequently to avoid any signal power loss.

In order to amplify the minimum amount of signal noise, it is applied a band-pass filter around 40KHz in each amplifier. These filters are made correlating capacitors with the same resistors used to the amplification. The obtained result is an equal filter to both amplifiers, which excludes frequencies lower than 39,3KHz and greater than 40,8KHz. Once the central signal frequency is 40KHz, these band-pass filters are tight enough to exclude a significant amount of noise, preserving and assuring at the same time the whole characteristics of the received ultrasonic signal.

The following expressions calculate the low and high cut-off frequencies for the two filters, being as previous mentioned identical for both.

$$f_{\ell 1} = \frac{1}{2\pi R1 C1} = \frac{1}{2\pi \times 1,5K\Omega \times 2,7nF} = 39,3KHz$$

$$f_{h1} = \frac{1}{2\pi R2 C2} = \frac{1}{2\pi \times 100K\Omega \times 39pF} = 40,8KHz$$

$$f_{\ell 2} = \frac{1}{2\pi R3 C3} = \frac{1}{2\pi \times 15K\Omega \times 270pF} = 39,3KHz$$

$$f_{h2} = \frac{1}{2\pi R4 C4} = \frac{1}{2\pi \times 100K\Omega \times 39pF} = 40,8KHz$$

Where, besides the already referenced resistances, $C1=2,7nF$, $C2=39pF$, $C3=270pF$ and $C4=39pF$.

Part B: This small part is an envelope detector circuit. With the insertion of a filter capacitor it is able to get an approximately constant voltage at the output, which is crucial to further comparisons.

The half-wave rectification is here made with Schottky diodes (BAS70-04) due to their good characteristics under high frequencies, enhancing thus the detection of the signal envelope.

Part C: This is a control circuit which has the responsibility to maintain the output signal constant. The automatic gain control (AGC), as it is usually called, feedback the peak output signal level from Part B to adjust the gain of the op amp A, enabling the circuit to work with a greater range of input signal levels. The op amps A to D, which are going to be referred in this explanation, are embedded into the LMC6494BEM component.

The op amp C compares that output signal with an ascribed 3,3V reference voltage, defined here by $V_{ref_{AGC}}$, which is made by a voltage divider with the resistors number 5 and 6. This op amp output signal will be then controlling the n-channel mosfet (2N7002-7-F) by its gate, taking the role of its V_{GS} . The mosfet is in the amplifier design, which means “when operated in saturation, it functions as voltage-controlled source: the gate-to-source voltage V_{GS} controls the drain current i_D ” [23].

$$V_{ref_{agc}} = \frac{R6}{R5 + R6} \times V_{dd} = \frac{6,8K\Omega}{18K\Omega + 6,8K\Omega} \times 12V = 3,3V$$

If the output signal is greater than the $V_{ref_{AGC}}$, AGC does not produce any feedback amplification, since mosfet’s V_{GS} is null and consequently it stands in the cut-off region. On the other hand, if the output signal is lower than the $V_{ref_{AGC}}$ the AGC produces the feedback amplification to the output signal of Part B. This means that mosfet’s V_{GS} is no longer null and so the mosfet is operating in the saturation region and thus amplifying the signal.

Part D: This last part consists in a signal detector circuit, which goal is to yield at its output a V_{DD} voltage of 12V in the case of received an ultrasonic signal by the ultrasonic receiver. This circuit is composed by an op amp which is constantly comparing the output signal from Part B with a reference voltage $V_{ref_{OUT}}$ of 2,9V, made by resistors number 7 and 8. This reference voltage is chosen to be a little lower than the $V_{ref_{AGC}}$ to assure that no matter how much the AGC amplifies a signal it will be always detectable by the signal detector circuit.

$$V_{ref_{out}} = \frac{R8}{R7 + R8} \times V_{dd} = \frac{15K\Omega}{47K\Omega + 15K\Omega} \times 12V = 2,9V$$

Therefore the ultrasonic receiver circuit provides no voltage to its output, and consequently to the μ MRF programmable pin, unless a signal is detected by overcoming the $V_{ref_{OUT}}$ and thus producing a high voltage in its output.

This ultrasonic receiver circuit contains a four-pin connector to receive power from the external power supply and to connect it to the μ MRF.

4.2.3 PCBs of the Infrastructure Unit

In the next figure is presented the Infrastructure Unit. There it can be seen the ultrasonic receiver module with one transceiver and the μ MRF module.

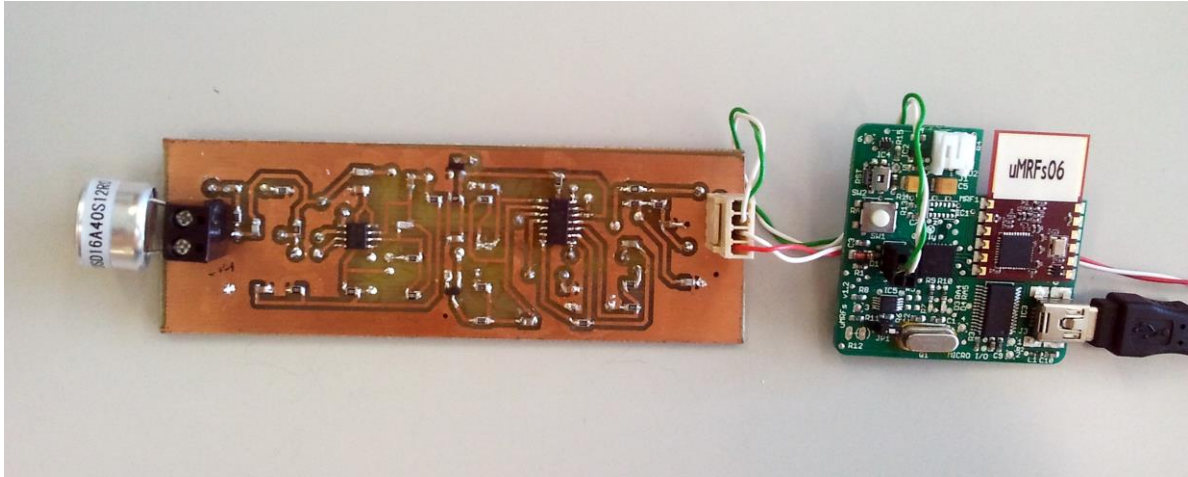

Figure 18 - Infrastructure Unit

The design of the printed circuit board was produced with the same software, the Eagle PCB, and presents all the components in one side of the board. The other side is composed just by conductive tracks, and as it can be observed in the figure the ground plane was not forgotten as well.

Once the majority of the components are SMD they are soldered directly onto the PCB surface allowing thus to create a board with 11,2cm x 4,4cm of area. Thereafter the connectors and the transceiver itself add more 1,5cm long and 2cm high to the ultrasonic receiver module.

The PCB of the ultrasonic receiver module was totally created and developed in the Department of Electronics, Telecommunications and Informatics (DETI) of the University of Aveiro.

Following is presented a table with the detailed cost of each component of the ultrasonic receiver module, as well as its total cost.

Table 5 - US Receiver module total cost

US Receiver	Quantity	Individual Price	Total cost
US Transceiver	1	2,57 €	2,57 €
Sch. diodes (BAS 70-04)	1	0,55 €	0,55 €
Op amps (TL 082 ACD)	1	0,80 €	0,80 €
Op amps (LMC 6494 BEM)	1	3,30 €	3,30 €
Mosfet (2N7002-7-F)	1	0,12 €	0,12 €
Capacitors	16	0,05 €	0,80 €
Resistors	19	0,22 €	4,18 €
Connector + contacts	1	1,65 €	1,65 €
Total			13,97 €

As it can be observed the ultrasonic receiver module has a total cost of 13,97€.

4.3 Master Infrastructure Unit

The Master Infrastructure Unit is very similar to an Infrastructure Unit. Both units have the same hardware, composed by a μ MRF and an ultrasonic receiver module. However their software is slightly different.

Beyond all the Infrastructure Unit features, this unique unit is also responsible to establish the bridge between the Personal Remote Controller and the Main Server. This means that, after calculating their distances to a PRC, each IU of the park refers exclusively to the MIU, leaving to this unit the duty to collect all the distances and transfer them to the Main Server.

Likewise an IU these units are powered up by 5V (μ MRF) and 12V (US module), and since they are static and part of the parking infrastructure they do not need to be powered up through batteries, being consequently supplied by the parking's power grid.

In the following subchapter is presented and explained all the relevant software development of the Master Infrastructure Unit.

4.3.1 Program Code Algorithm

For the same reasons of the PRC and the IU a program code, in C language, was developed for the Master Infrastructure Unit. Due to the many similarities with the IU only the differences between the two units will be here explained.

In the following figure is presented the MIU's block diagram of the program code algorithm.

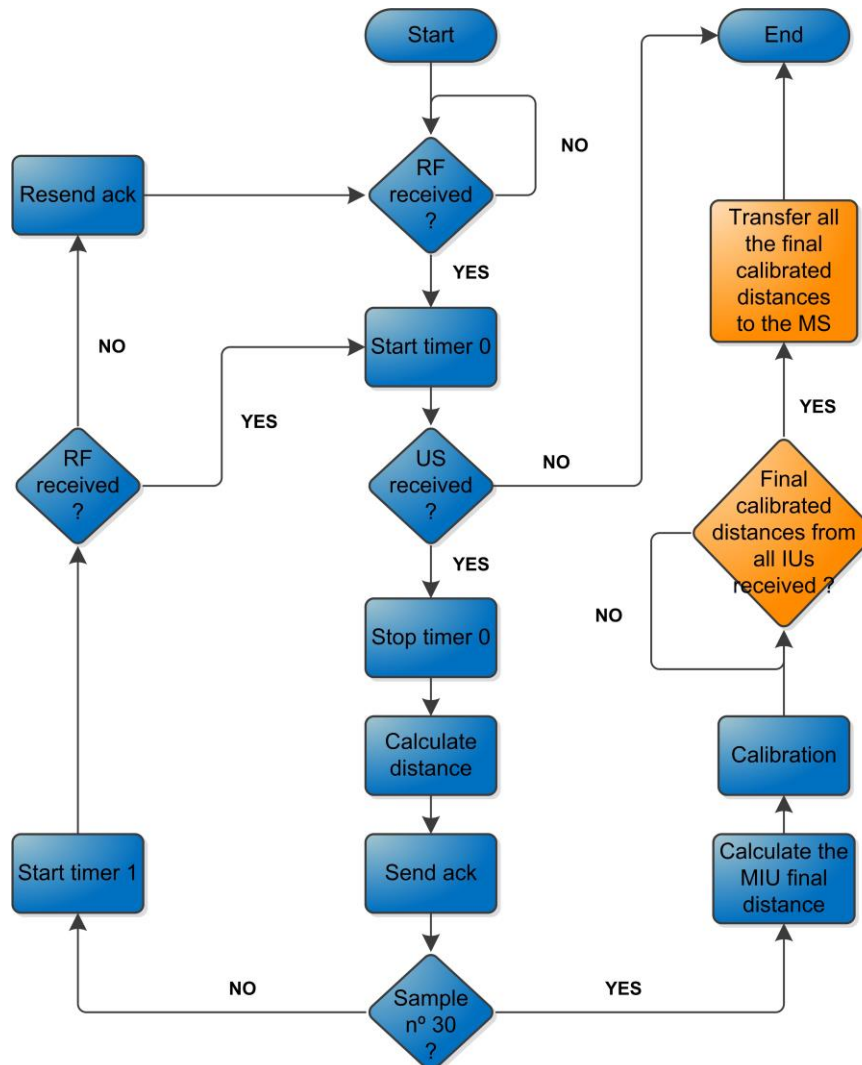

Figure 19 - Block diagram of the program code algorithm

As it can be observed in figure nineteen there are two orange blocks. Those blocks represent the algorithm differences between the Master and the simple Infrastructure Unit.

Thereby after the calibration of the final distance calculated by the own MIU, instead of transmit that value the MIU awaits the reception, through radio-frequency, of all the other final calibrated distances from all the IUs existing in the park. As soon as all the distances are collected they are transferred to the Main Server in order to be presented and analyzed.

The Master Infrastructure Unit concludes thus its program and returns to the standby mode, waiting for a new RF pulse from another user.

5. Tests and Results

Finished the project development, as well as all the system implementation, remains to check its practical performance and confront the results with the theoretical expectations. In order to reach the full potential of the system several tests were made under different circumstances and mediums. All the condition tests were previously established and carefully maintained during the experiences. Concluded the description and presentation of these tests the consequent results will be subject of analyses.

5.1 Power Consumption Tests

The first tests, the power consumption ones, were made in the same laboratory where the system was implemented. Despite the development of other different projects in the same area, at the time of these tests none of them were active, preventing thus any possible interference.

The maximum current consumptions of the μ MRF module are already known, being presented in another chapter of the document. However it still remains to measure the power consumptions of the designed ultrasonic modules, both for the transmitter as for the receiver one. After knowing these values, it will be possible to predict the total amount of current consumed either by a PRC as also by an Infrastructure Unit.

5.1.1 Ultrasonic Modules Power Consumption

All the values presented in the following tables were measured through a current probe and visualized in an oscilloscope. Therefore these values are human eye approximations.

In table 6 is presented the current consumption measurements of the ultrasonic transmitter module. To successfully test this module its program code was changed so it can transmit, continuously, the ultrasonic waves. Besides the standard tests in standby

and transmitting modes for 12V, it were measured the current consumptions with almost the maximum power which the components can be supplied with. Moreover once the hardware of the ultrasonic transmitter module includes six transceivers, with the possibility to change or even remove them individually, it was also tested the current consumption with just one sensor connected.

Table 6 - Current consumptions of the ultrasonic transmitter module

US Transmitter		Standby	Transmitting
12V	1 sensor	20mA	20mA
	6 sensors	20mA	20mA
17,5V	1 sensor	35mA	35mA
	6 sensors	35mA	38mA

From table 6 it is easily concluded that current consumption is directly related with the power supply. With 12V, either for the standby as for the transmitting operation, the ultrasonic transmitter module consumes around 20mA. Increasing the power supply to 17,5V the module starts to consume around 35mA, reaching a maximum current consumption of 38mA during the transmitting operation with six transceivers.

The following table is associated to the ultrasonic receiver module, and presents the current consumptions of the two operation modes, the standby and the receiving one.

Table 7 - Current consumptions of the ultrasonic receiver module

US Receiver	Standby	Receiving
12V	11mA	13mA

In this case just the standard power supply of 12V was applied, since it was previously tested that distance range is not affected with its increase. Therefore it was measured 11mA for the standby mode and 13mA for the receiving operation mode, with the US Receiver at a distance of one meter to the US Transmitter.

5.1.2 Localization System Power Consumptions

Concluded the current consumption measurements for the ultrasonic modules, it can be now predicted how much current consumes each one of the localization system's units. The current consumptions of the μ MRF module are already known and previously presented in table 3. Thereafter once each unit is composed by a μ MRF and the respective ultrasonic module simple mathematical calculations remain to be done.

The current consumptions of the PRC unit are presented in the following table. Only the values for the US Transmitter with six sensors were used.

Table 8 - Current consumptions of the PRC unit

PRC unit	Standby	Transmitting
12V	20mA	43mA
17,5V	35mA	61mA

The standby current consumptions of the PRC unit are approximately the same of the US Transmitter itself, since the μ MRF module consumes only 16μ A in the system standby, when just the microcontroller is active waiting for the button to be pressed. However that changes at the transmitting time, since the μ MRF current consumption can no longer be neglected. Therefore, to transmit both RF and ultrasonic pulses the PRC consumes 43mA when powered up by 12V and 61mA when powered up by 17,5V.

Relatively to the Infrastructure Unit, its current consumptions are presented in the following table.

Table 9 - Current consumptions of the Infrastructure Unit

Infrastructure Unit	Standby	Receiving
12V	11mA	36mA

The same justification applies now for the standby current consumption of the IU, since the μ MRF operating mode is the same and thus can be neglected. Regarding the active operation mode, to receive both RF and ultrasonic pulses the Infrastructure Unit consumes 36mA.

5.2 Indoor Tests

Before the outdoor tests, where the system was designed to be implemented, indoor tests were made in order to check the full potential and characteristics of the same system. These tests occurred inside the sports hall of the Department of Education, University of Aveiro, being the only activity at the time.

The mentioned sports hall offered the perfect conditions to perform these tests, since it has the necessary space to measure the maximum distance range of the system as well as test the whole system itself with all the developed units.

All the data acquisition was made through a serial terminal program called Realterm.

5.2.1 Distance Range with the PRC Unit with Only One Sensor

These first indoor tests use one PRC and one Infrastructure Unit, however in order to know how the PRC unit works it is here transmitting through a single transceiver. The next figure presents the test condition where, besides the IU, it can be seen the PRC unit, more specifically the ultrasonic transmitter module, composed by only one sensor.

The air temperature measured at the moment of these tests was 22 degrees Celsius.

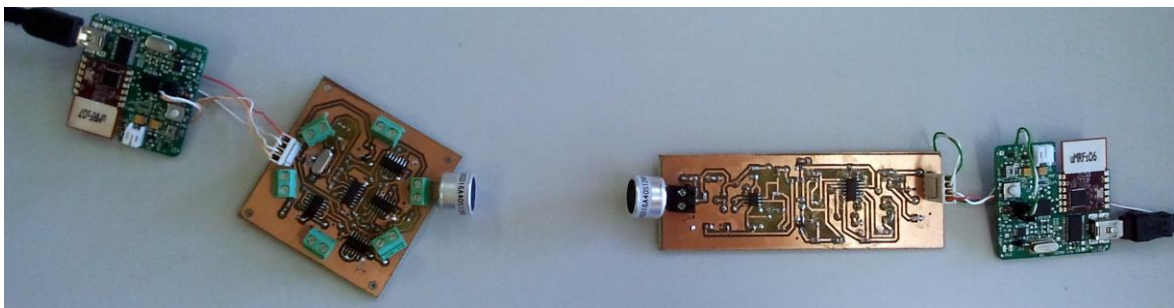

Figure 20 – Test condition

The goal of these tests is to measure the distance range between the two units. The tests were made with the units in line-of-sight and at a meter high from the ground. All the measurements positions are spaced by half a meter, starting at a distance of 50cm and increasing the distance until the ultrasonic communications are no longer possible.

For each position the distance was measured five times. Thereby an average distance and thus a trustful measurement can be obtained. Moreover subtracting the real to the measured distance it was calculated the adjacent error of each measurement.

Following is presented the two tables with values obtained under the described conditions. The table 10 was obtained supplying the ultrasonic transmitter module with 12V and the table 11 with 17,5V.

Table 10 – Measured distances with the US transmitter supplied by 12V

Ultrasonic transmitter – 12V							
Real distance (cm)	Measured distances (cm)					Average distance (cm)	Error (cm)
	#1	#2	#3	#4	#5		
50	34	34	34	33	34	34	16
100	86	86	85	85	86	86	14
150	136	136	136	136	136	136	14
200	185	185	185	185	185	185	15
250	235	235	231	235	235	234	16
300	286	286	287	286	286	286	14
350	337	337	337	337	336	337	13
400	384	386	383	383	386	384	16
450	435	434	434	434	435	434	16
500	488	488	485	488	484	487	13
550	537	538	538	538	537	538	12
600	587	588	587	584	587	587	13
650	639	641	641	637	640	640	10
700	690	691	691	691	691	691	9
750	743	743	742	742	741	742	8
800	794	795	794	795	794	794	6
850	844	843	843	844	842	843	7
900	896	894	895	896	895	895	5
950	946	946	946	948	946	946	4
1000	994	993	994	994	993	994	6
1050	1048	1049	1049	1049	1048	1049	1
1100	1100	1100	1101	1100	1101	1100	0
1150	1153	1154	1156	1153	1154	1154	4
1200	1209	1207	1209	1211	1209	1209	9

Table 11 - Measured distances with the US transmitter supplied by 17,5V

Ultrasonic transmitter – 17,5V							
Real distance (cm)	Measured distances (cm)					Average distance (cm)	Error (cm)
	#1	#2	#3	#4	#5		
50	33	34	33	33	33	33	17
100	84	84	84	84	84	84	16
150	134	134	133	134	134	134	16
200	185	185	185	185	185	185	15
250	234	234	234	234	234	234	16
300	285	285	286	285	285	285	15
350	336	336	336	336	336	336	14
400	386	386	387	386	386	386	14
450	436	436	437	436	436	436	14
500	487	486	486	486	486	486	14
550	537	537	537	537	537	537	13
600	587	587	587	587	587	587	13
650	637	636	637	636	637	637	13
700	688	689	688	688	688	688	12
750	737	736	736	736	737	736	14
800	788	787	787	787	787	787	13
850	837	837	837	837	837	837	13
900	887	888	887	888	888	888	12
950	940	939	940	939	939	939	11
1000	989	989	989	990	989	989	11
1050	1040	1041	1040	1040	1040	1040	10
1100	1094	1093	1093	1093	1094	1093	7
1150	1143	1143	1145	1143	1144	1144	6
1200	1195	1193	1195	1193	1195	1194	6
1250	1246	1245	1247	1249	1246	1247	3
1300	1301	1299	1302	1300	1300	1300	0
1350	1353	1352	1351	1353	1354	1354	4

Comparing the two tables it can be immediately noticed that with 17,5V of power supply a maximum distance range is obtained. The next figure illustrates that conclusion with a comparison between the average measured distances with the ultrasonic transmitter supplied by 12V and 17,5V. Whereas for 12V the maximum distance range is twelve meters, with 17,5V the same communications can be made until a distance of thirteen meters and a half.

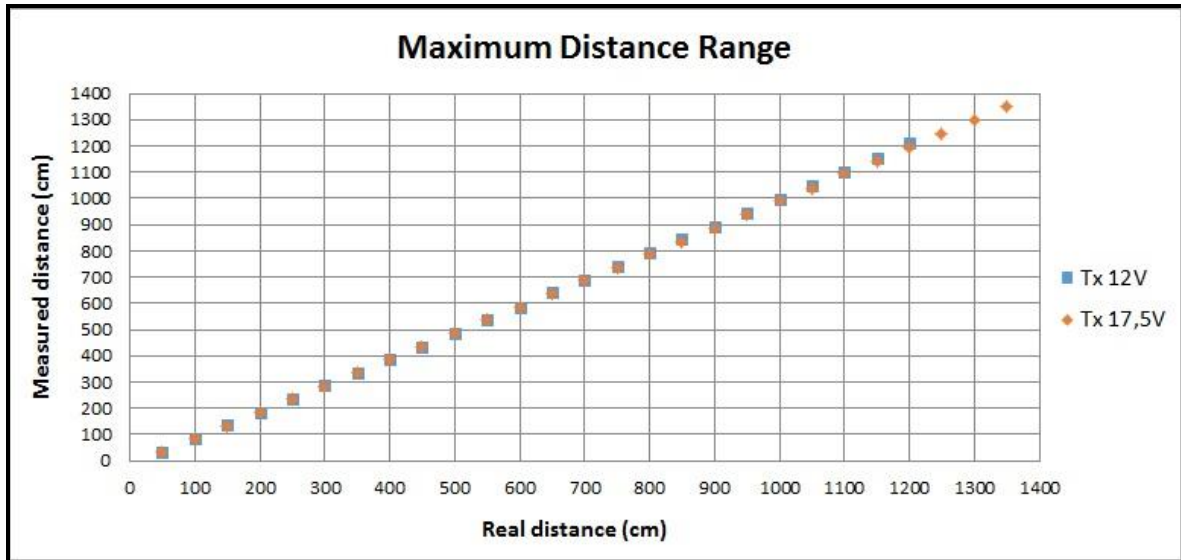

Figure 21 – Maximum distance range comparison

The measurement error is also illustrated by the next figure. Therein can be observed a more or less constant error around fourteen for the shorter distances, followed by a smooth error decreasing up to zero and a significant error increasing after that and until reaching the maximum distance range.

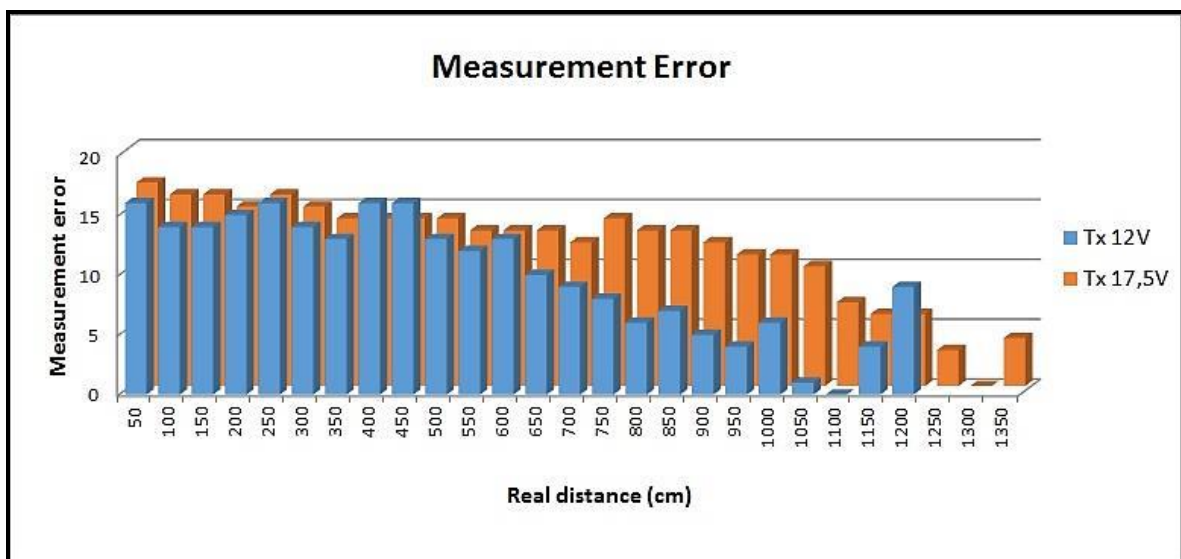

Figure 22 – Measurement error comparison

5.2.2 Distance Range of the PRC Unit

Likewise in the last subchapter it is used here exclusively one PRC and one Infrastructure Unit. However the goal now is to measure the distance range with the PRC unit complete, in other words, composed by its six transceivers. Figure 23 presents the test condition, where it can be seen the PRC and the IU.

These tests were made right after the previous ones, and thus the same air temperature of 22 degrees Celsius was observed.

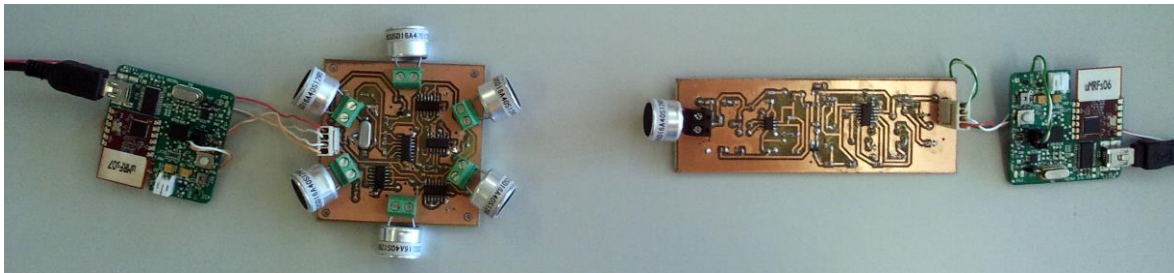

Figure 23 – Devices under test

As it was previously explained in the last chapter of this document the six transceivers of the ultrasonic transmitter module can be grouped into three pairs, having the two sensors of each pair similar characteristics. Therefore for each measurement position it was chosen one sensor of each pair to be in line-of-sight with the IU and thus measure the distance to that unit.

Hereupon similar measurements to the previous subchapter were made to each chosen transceiver, preserving all the conditions such as the altitude of the units and the distance measurement from 50cm until being no longer possible.

The following table, number 12, presents the mentioned measurements. The table is divided by the three pairs of transceivers, and for each real distance is filled with the measured distance and the resultant measurement error calculations.

The “Measured distance (cm)” column represents here, despite being not presented, an average distance of five different measurements. Moreover the orange values refer to the measurements acquired supplying the ultrasonic transmitter module with 17,5V, instead of the standard power supply of 12V which are the values in black colour.

Table 12 – Measured distances for the US transmitter supplied by 12V and 17,5V

Real distance (cm)	Pair 1		Pair 2		Pair 3	
	Measured distance (cm)	Error (cm)	Measured distance (cm)	Error (cm)	Measured distance (cm)	Error (cm)
50	33	17	33	17	34	16
100	85	15	85	15	86	14
150	135	15	135	15	136	14
200	187	13	186	14	187 / 185	13 / 15
250	237	13	236	14	241 / 238	9 / 12
300	289	11	287	13	292 / 288	8 / 12
350	338	12	336	14	344 / 341	6 / 9
400	391	9	387	13	428 / 389	28 / 11
450	442	8	440	10	480 / 443	30 / 7
500	495	5	490	10	493	7
550	546	4	540	10	544	6
600	595 / 589	5 / 11	590	10	594	6
650	645 / 640	5 / 10	641	9	643	7
700	696 / 693	4 / 7	694	6	694	6
750	742	8	744	6	749	1
800	791	9	794	6	799	1
850	841	9	845	5		
900	893	7	900 / 886	0 / 14		
950			938	12		
1000			991	9		

Observing table 12 it is easily noticed that the three pairs of transceivers do not have the same performance. Following, a few figures are presented showing graphs of the values and thus facilitating the table analysis.

The figures 24 and 25 represent the maximum distance range of the three pairs under 12V and 17,5V of power supply. From the first figure it can be observed the accentuate difference between the pairs of transceivers when powered up by 12V. The second pair is by far the most powerful, being able to transmit up to nine meters, while the first pair up to seven meters and the third pair only up to four meters and a half.

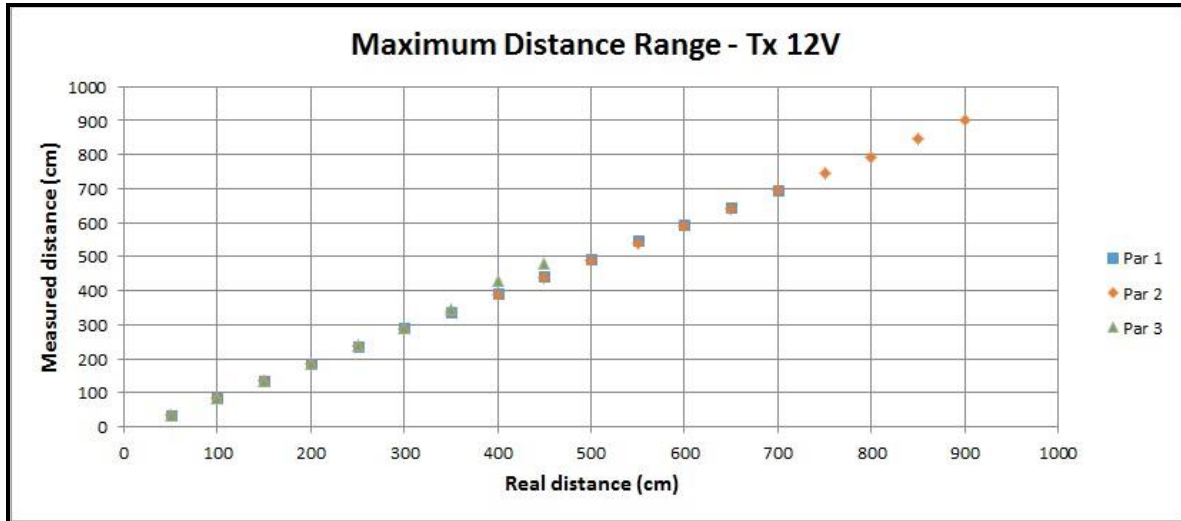

Figure 24 - Maximum distance range comparison for US transmitter supplied by 12V

In figure 25 it can be seen that a better balance between the three pairs of transceivers can be obtained. Although the order of the transceivers does not change, the second pair is also the most performant, when powered with 17,5V. The other two pairs improve their performance significantly. With this power supply increase the second pair is then able to communicate up to ten meters, the first pair up to nine meters and the third pair up to an acceptable eight meters.

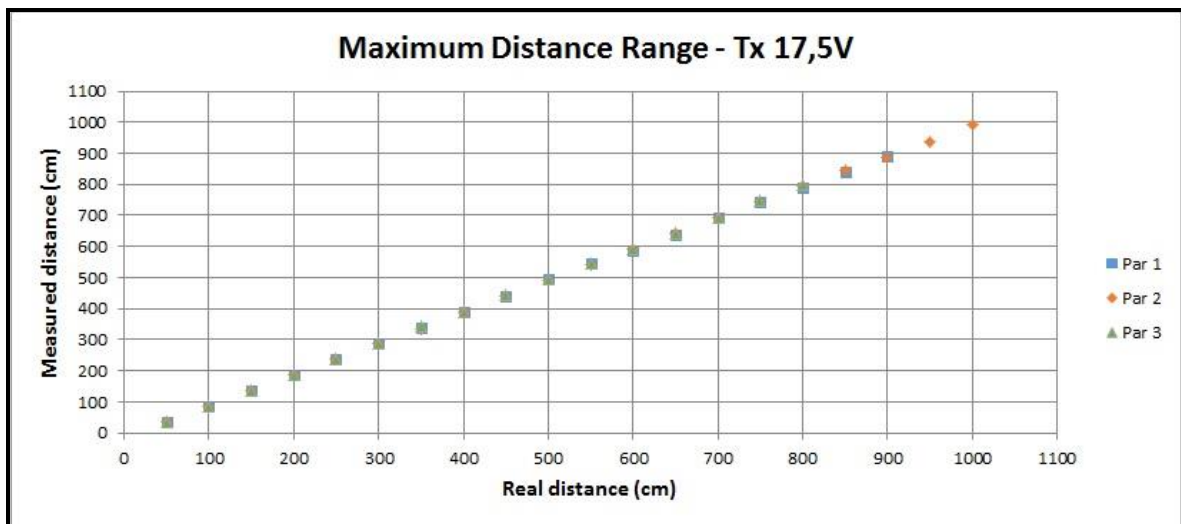

Figure 25 - Maximum distance range comparison for the US transmitter supplied by 17,5V

Relatively to the measurement errors a similar behavior of the second pair can be noticed when compared with the last subchapter tests, revealing a smooth decreasing until the limit distance where the communications can be made.

Moreover these errors demonstrate the great improvement of performance of the third pair when powered up by 17,5V. Whereas for 12V of power supply the maximum distance range was short and showing high measurement errors (near thirty centimeters), when powered with 17,5V the maximum distance range improves and the distance error decreases.

Figure 26 presents the measurement error of the third pair. In this figure it can be observed what has just been referred.

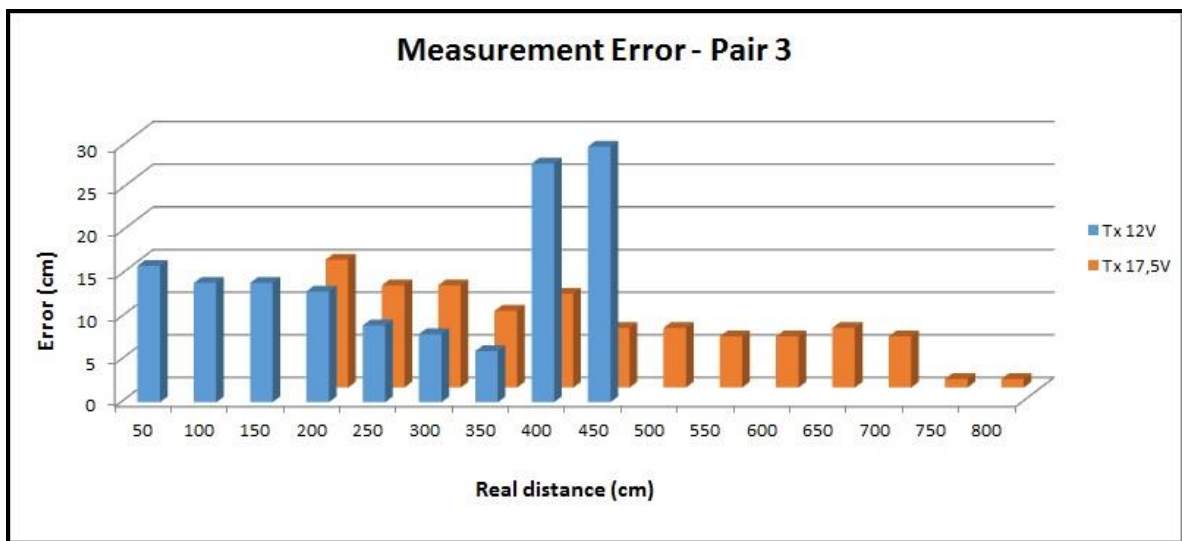

Figure 26 - Measurement error for the third pair

5.2.3 Calibration

After finishing the first tests, where the PRC unit was tested with one and six sensors, a few adjusts can be made to enhance the system. Observing the results, a calibration to the measured values seems indispensable in order to minimize the errors and thus to acquire a more precise measurement.

The calibration which will be here explained is made by the Master and all Infrastructure Units being part of their program code, as already referred in the last chapter.

In order to reach a mathematical expression which can adjust the measures some values need to be chosen. Once the practical system, and more specifically the ultrasonic transmitter module, was designed to operate with six transceivers the standard adjustment is made with the results of the last subchapter. For the same reason the values acquired from a power supply of 12V are the chosen ones. Moreover as the Pair 2

is the one which presents the maximum distance range its measured distances are used to make a linear regression and thus get the desired mathematical expression.

As figure 27 demonstrates the linear regression arises from the correlation between the real distances and the measured distances of the second pair of transceivers when powered up by 12V. There it can be seen the linear regression line and its associated mathematical expression, which is:

$$y = 0,9843x + 17,695$$

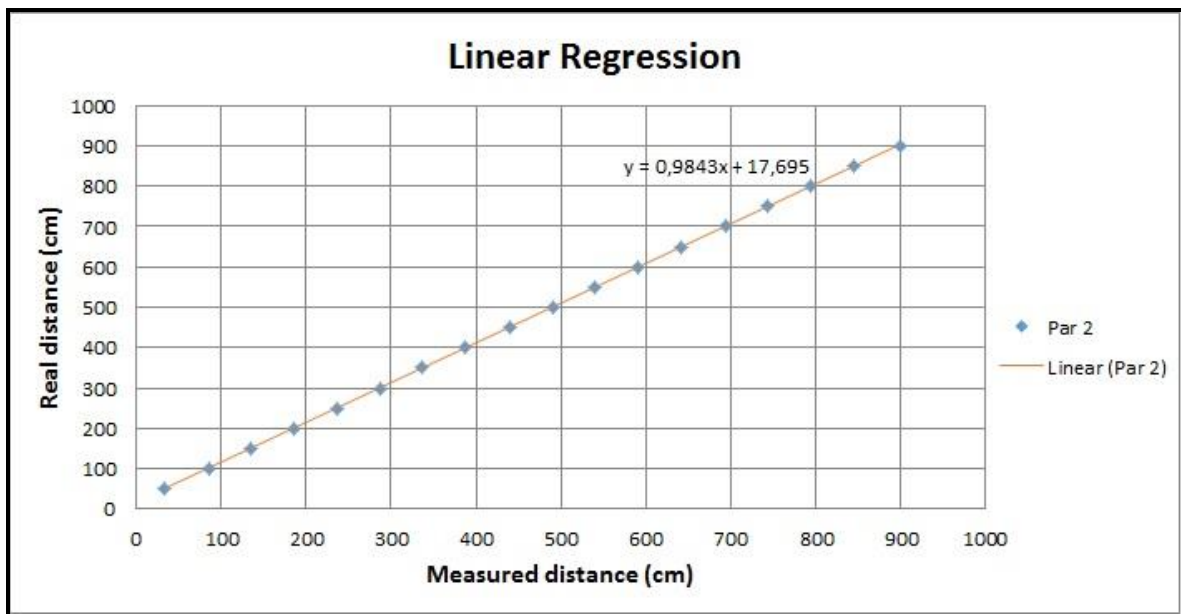

Figure 27 - Linear regression

In order to calibrate the system the linear regression expression is used replacing the “x” with the measured distances to obtain the “y” as the same values adjusted. The next figure demonstrates how this affects the system, presenting the last table after the calibration has been applied. The “Error (cm)” columns are now calculated with the adjusted measured distances, representing its subtraction to the real distances in absolute values.

Table 13 - Calibration of table 12 for the 12V values

Table 12 after calibration (12V values)						
Real distance (cm)	Pair 1		Pair 2		Pair 3	
	Adjusted measured distance (cm)	New error (cm)	Adjusted measured distance (cm)	New error (cm)	Adjusted measured distance (cm)	New error (cm)
50	50	0	50	0	51	1
100	101	1	101	1	102	2
150	151	1	151	1	152	2
200	202	2	201	1	202	2
250	251	1	250	0	255	5
300	302	2	300	0	305	5
350	350	0	348	2	356	6
400	403	3	399	1	439	39
450	453	3	451	1	490	40
500	505	5	500	0		
550	555	5	549	1		
600	603	3	598	2		
650	653	3	649	1		
700	703	3	701	1		
750			750	0		
800			799	1		
850			849	1		
900			904	4		

As it can be observed the calibration had a successful impact in the distance values. The adjusted values of the measured distances approached significantly to the real distances resulting in a large decrease of the consequent errors.

Plausibly the values of the second pair are the finest ones since the standard calibration was made on it, however the adjustment reveals successful results in the other pairs as well.

Thereby the new error of the second pair is mostly null or 1cm, the maximum error of the first pair is 5cm and for the third pair 6cm. The last two error values of the third pair,

relative to four meters and four meters and a half measures, are negligible since they can be considered wrong measurements due their high error of 39cm and 40cm.

5.2.4 Pre-Trilateration

These are the last indoor tests and in them all the modules designed in the project were used. For that reason the pre-trilateration tests are very important, having the goal to examine the whole system.

The tests are called pre-trilateration because the trilateration calculations are not performed. However, all the developed work until that point is tested and the three distances which would enable to locate the PRC are measured. Moreover, since it is intended to work with bounded errors, the calibration is now applied.

The following figure presents all the elements used in these tests. There it can be seen the PRC at the center and three Infrastructure Units surrounding it, knowing beforehand that one of them is programmed to be the Master Infrastructure Unit.

The air temperature measured at the moment of these tests was 18 degrees Celsius.

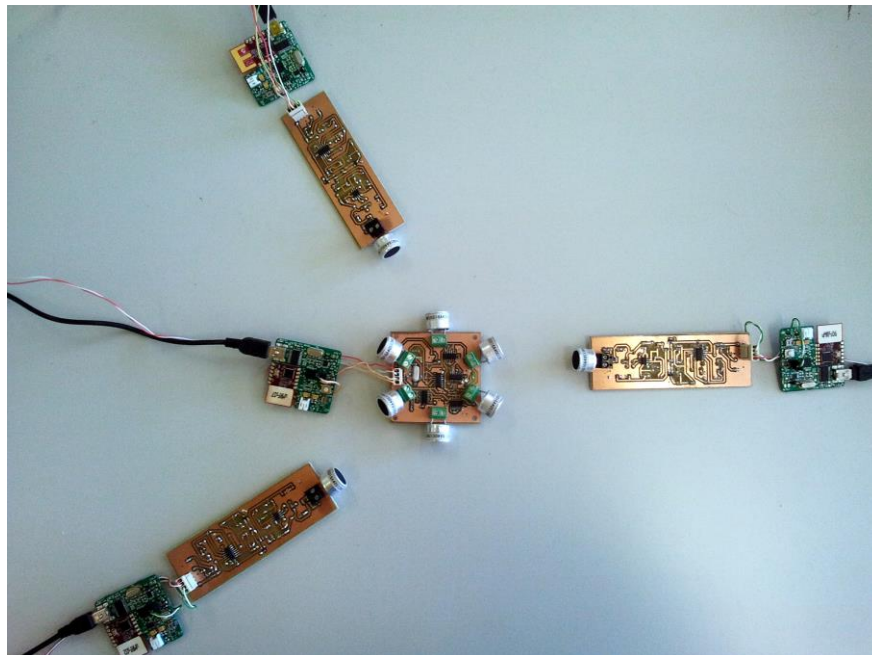

Figure 28 – Test devices

Likewise the previous tests, the modules always stand at a meter high from the ground. However, the line-of-sight between the module's transceivers is no longer required. As the goal is to test the system in its normal operating conditions the power supply is now fixed at 12V.

In order to make an exhaustive test the system was disposed in two different situations, being each of them explained in the following two subchapters. In the end a print screen of the Realterm program is presented to demonstrate a measurement acquisition example.

5.2.4.1 Measurements with Random Layouts of the Infrastructure Units

In this first situation the PRC has a fixed location and the Infrastructure Units are disposed randomly around it. Thereafter for each different layout the IUs measured their distances to the PRC unit.

The following table presents the real and the measured distances, as well as the consequent error, of each receiver (IU) for each one of five different layouts.

Table 14 – Measured distances made with random layouts of the Infrastructure Units

n°	Receiver 1			Receiver 2			Receiver 3		
	Real distance (cm)	Measured distance (cm)	Error (cm)	Real distance (cm)	Measured distance (cm)	Error (cm)	Real distance (cm)	Measured distance (cm)	Error (cm)
1	479	470	9	208	213	5	162	153	9
2	539	530	9	204	205	1	473	479	6
3	725	720	5	204	207	3	292	288	4
4	598	593	5	143	139	4	350	353	3
5	854	848	6	258	264	6	538	535	3

Observing table 14 a larger error can be noticed in the overall measurements when compared with table 13. The first layout presents the measurements with the largest error, with 9cm for two of the three receivers. On the other hand the measurements correspondents to the third and fourth layout are the most accurate ones, presenting both a maximum error of 5cm in just one of the three receivers.

The increase of the measurement error was expected and explained mainly by the loss of the line-of-sight between the transceivers. Furthermore the difference in the air temperature at the moment of the tests influenced too, once it is known that the ultrasonic speed varies with the temperature.

5.2.4.2 Measurements with a Fixed layout

For this second situation the opposite was done. The Infrastructure Units are now installed with a fixed layout, being the PRC unit the mobile device which generates the different measurement positions. Due to the shorter distance range of the third pair of transceivers, the IUs were disposed in the vertices of an equilateral triangle of 3,7m side.

The following table presents the receivers measurements for each one of the five different created layouts.

Table 15 - Measured distances with an Infrastructure Units fixed layout

n ^o	Receiver 1			Receiver 2			Receiver 3		
	Real distance (cm)	Measured distance (cm)	Error (cm)	Real distance (cm)	Measured distance (cm)	Error (cm)	Real distance (cm)	Measured distance (cm)	Error (cm)
1	298	291	7	258	256	2	115	110	5
2	205	205	0	228	222	6	192	185	7
3	187	178	9	286	290	4	166	157	9
4	270	265	5	100	97	3	309	300	9
5	185	179	6	229	223	6	209	202	7

Likewise the previous measurements, in table 15 it can be observed that a largest error of 9cm was also obtained with a fixed layout. The measurements under the third and fourth layouts presented that same maximum error of 9cm, while for the other layouts a maximum measurement error of 7cm was obtained.

When compared with table 13, the increase of the measurement errors can be also explained by the loss of line-of-sight between the transceivers and by the different air temperature at the moment of the tests.

As previously announced, in the following figure is presented a measurement acquisition. This example belongs to the fifth layout of table 15, where Receiver 1 is the Master Infrastructure Unit and thus receives the final distances adjusted of the other two Infrastructure Units.

```

RealTerm: Serial Capture Pr
RF & US received? 27 LF
Timer0 register:c103c, LF CR
Decimal: 4156, LF
Distance: 141, LF
---- ack sent ---- LF
RF & US received? 28 LF
Timer0 register:c71, LF CR
Decimal: 3185, LF
Distance: 108, LF
---- ack sent ---- LF
RF & US received? 29 LF
Timer0 register:c1027, LF CR
Decimal: 4135, LF
Distance: 140, LF
---- ack sent ---- LF
RF & US received? 30 LF
Timer0 register:9e7, LF CR
Decimal: 2535, LF
Distance: 86, LF
---- ack sent ---- LF
===== 3 largest distances ===== LF
163 cm, LF
164 cm, LF CR
164 cm, LF CR
===== Final distance ===== LF
receiver number 1 : LF
164 cm, LF
===== Final distances adjusted ===== LF
receiver number 1 : LF
179 cm, LF
receiver number 2 : LF
223 cm, LF
receiver number 3 : LF
202 cm, LF
===== UMRFS Localization ===== LF
Waiting... LF

```

Figure 29 - Measurement acquisition made with Realterm

In figure 29 the MIU operation can be observed. There it can be seen the last four of thirty distance measurements, with information about the counting of pulses received, the timer 0 register, the respective conversion to decimal and the relative calculated distance. Moreover it is also shown the acknowledge transmission which is sent to the PRC.

After the thirty distance measurements, the three largest distances are presented and the average of them is calculated to represent the final distance. Afterwards the MIU, in the figure as receiver number 1, adjusts its own final distance and awaits the reception of the other adjusted distances, received from the other two receivers (IUs), to present them all.

Here it can be analyzed the calibration importance, once without it the final distance was 164cm and thus with a measurement error of 21cm, while with calibration the distance was adjusted to 179cm reducing significantly the error to just 6cm.

Finished the cycle and presented the three final distances adjusted, the MIU returns to the beginning of the program code, waiting for the next RF and ultrasonic pulses.

5.3 Outdoor Tests

The following outdoor tests were made inside the University of Aveiro campus, at an open space without any other activity which could disturb the tests at the moment. That afternoon was sunny and a little windy, with an air temperature of 24 degrees Celsius.

Since the indoor tests served to examine the operation of the system, the outdoor tests were made to compare the results and analyze the differences. Therefore the maximum distance range was measured with the PRC and one Infrastructure Unit, both supplied by 12V. Moreover in order to foresee a real case scenario the system was tested with the presence of an obstacle.

Likewise the indoor tests all the data acquisition was made through the serial terminal program Realterm.

5.3.1 Distance Range of the System Outdoor

As previously said the distance range outdoor was measured with the PRC and one Infrastructure Unit. Once the goal here is to test the developed system as it was intended to operate, the PRC unit is composed by its six transceivers and both ultrasonic modules are supplied by 12V.

This test was made with the IU in line-of-sight with the PRC's second pair of transceivers, being both units at a meter high from the ground. Thereafter all the measurement positions were spaced by half a meter, starting at a distance of 1m and increasing it until the ultrasonic communications was no longer possible.

As done before, for each position the distance was measured five times in order to calculate the average value and the consequent measurement error. Furthermore the calibration was applied to check once again its importance and the final values obtained.

The following table presents the measurements done under the described conditions, where the "adjusted distance (cm)" and the "final error (cm)" columns are highlighted in order to judge the system outdoor.

Table 16 – Measured distances outdoor

Real Distance (cm)	Measured distances (cm)					Average Distance (cm)	Error (cm)	Adjusted Distance (cm)	Final Error (cm)
	#1	#2	#3	#4	#5				
100	88	88	88	88	88	88	12	104	4
150	138	138	138	138	138	138	12	154	4
200	188	188	188	187	188	188	12	203	3
250	238	238	237	237	239	238	12	252	2
300	288	288	288	287	287	288	12	301	1
350	338	338	337	337	337	337	13	350	0
400	389	389	390	390	391	390	10	401	1
450	442	438	439	438	440	439	11	450	0
500	490	489	491	489	488	489	11	499	1
550	541	545	542	541	540	542	8	551	1
600	591	593	594	591	590	592	8	600	0
650	643	645	646	644	646	645	5	652	2
700	694	693	691	694	697	694	6	701	1
750	752	746	750	748	747	749	1	754	4

Observing table 16 it is immediately noticed that a maximum distance range of seven meters and a half is obtained for the system outdoor. Comparing with the indoor tests the system lost one meter and a half of communication distance range, once for the same 12V of power supply the maximum distance range indoor was nine meters.

The decrease of the distance range is due to the different conditions encountered outdoor, where factors such incident sun light, humidity in the air or windy weather change the ultrasonic speed and its propagation.

The following figure shows the comparison between the maximum distance range, as well as the other adjusted measurements, of the system in the tested outdoor and indoor environments.

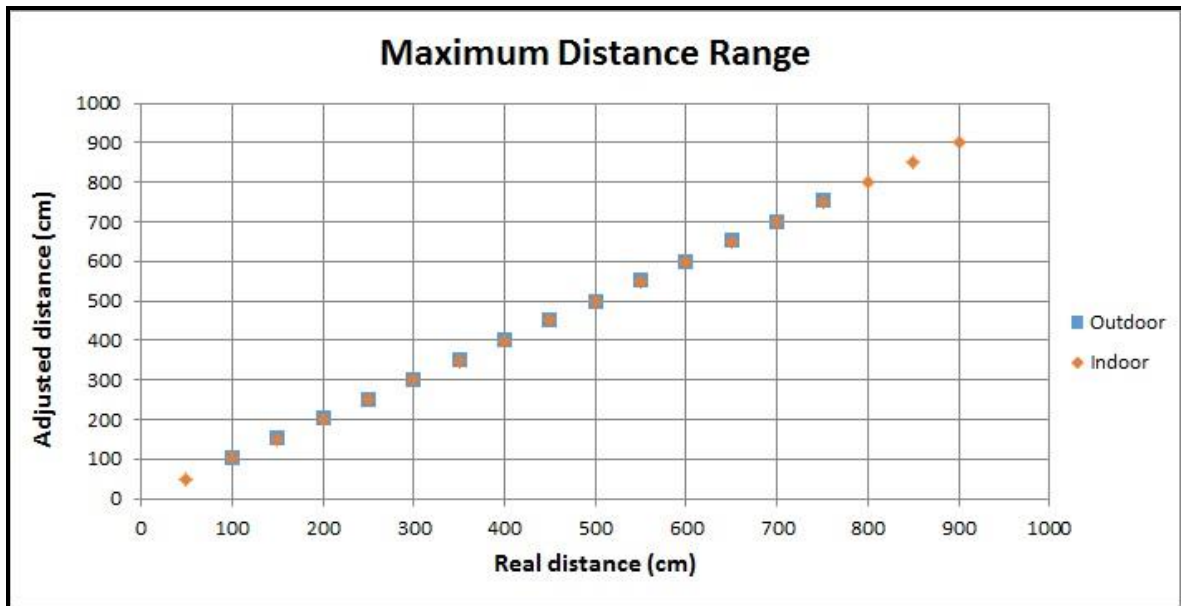

Figure 30 – Maximum distance range outdoor vs indoor

Relatively to the measurement error it can be observed through table 16 the significant improvement it experienced with the calibration, since the maximum error decreased from 12cm to only 4cm.

When compared with the similar indoor tests after calibration (table 13) both tests present the same maximum error, however a larger overall error is now obtained. That increase of the overall error is not surprising once the measurement conditions were different and thus different measurements are expected. Moreover this is not a fair comparison since the calibration was made for the indoor values with which the outdoor ones are being compared.

The following figure presents the measurement error comparison of the system in the different tested environments.

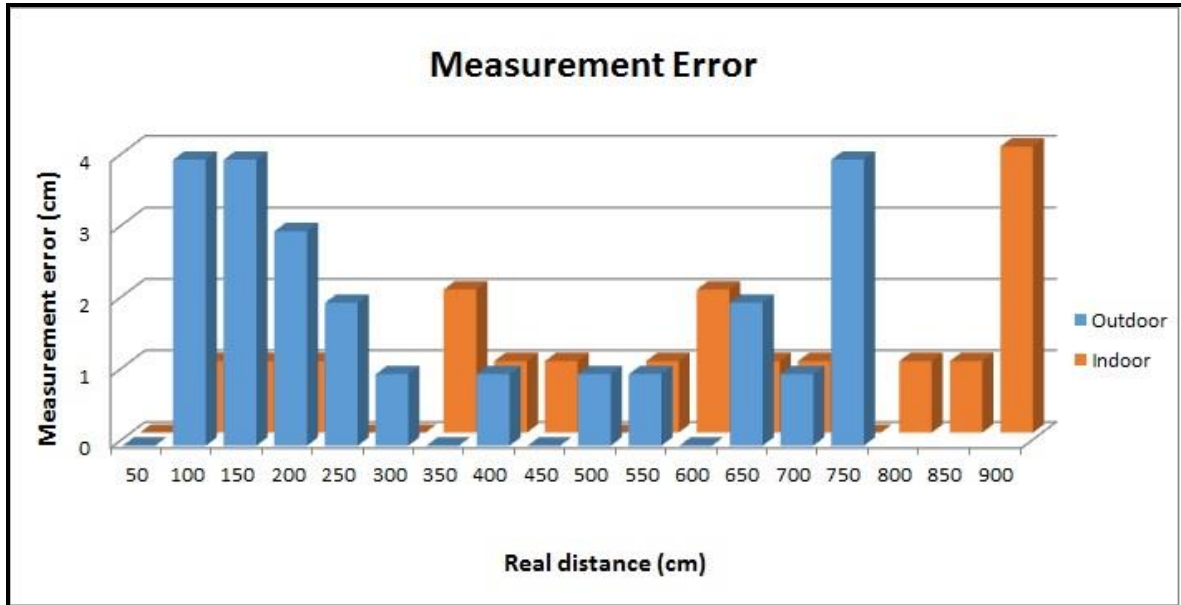

Figure 31 - Measurement error outdoor vs indoor

5.3.2 Distance Range in the Presence of Obstacles

The tests are not concluded until the system is tested in the presence of obstacles. Since the aim of the developed system is the vehicle localization, the chosen obstacle is without surprises a glass of a vehicle. Moreover, in accordance with other systems as Via Verde [24] which uses electronic toll devices inside vehicles, the tested glass will be the vehicle's windshield.

The following figure demonstrates the test condition. There it can be seen the PRC unit inside the car, the Infrastructure Unit outside and the car's windshield as the communications obstacle. Moreover it can be seen one of two mobile batteries, which were used to supply the ultrasonic modules with the requested 12V. The μ MRF modules were connected to laptops, and thus powered up by their USB ports.



Figure 32 - Vehicle's windshield as an obstacle

Even for the shortest possible distance this test revealed very conclusive: ultrasonic communications cannot be made through the vehicle's windshield. Regarding the RF pulses the obstacle did not affect the communication between the μ MRF modules, however as it is known the localization system does not work without both signals.

This conclusion was not completely unexpected, once it was already known that the ultrasounds are severely affected by obstacles. Furthermore none of the systems studied in the state of the art predict the constant presence of any obstacle, what supports the conclusion.

6. Conclusions and Future Work

Concluded the project development it still remains work to do in order to finish the desired localization system as it was described in the document. Instead of that, an enhanced distance measurement system was created being composed by four units (one transmitter and three receivers). The system designed allows the successful measurement of three distances between the transmitter (PRC) and the three receivers (Infrastructure Units) through the push of a single button. Thereafter to reach the ambitious goal of the project and locate the exact position of the PRC is just missing to perform the trilateration technique with the obtained distances.

Relatively to the developed system different power supplies and number of transceivers were tested with the ultrasonic transmitter module, which is part of the PRC unit. The following table resumes the maximum distance range under the different test conditions.

Table 17 - PRC maximum distance range

PRC maximum distance range	1 transceiver	6 transceivers
12V	12m	3,5m – 9m
17,5V	13,5m	8m – 10m

From these tests it is concluded that the desired 12V of power supply is not enough to the successful performance of the PRC unit. When the unit is transmitting through just one transceiver a satisfactory distance is achieved, however when all the transceivers are installed the supplied power becomes insufficient and the unit loses its balance. By contrast, when the unit is powered by 17,5V it already presents satisfactory results.

This comparison allows to conclude that the PRC unit performs better with higher power supplies, however since a mobile device has power limitations increasing it is not an option. Therefore different approaches need to be studied in order to extend the system's area of communications. An idea is to invert the role of the units, since if the transmitters were part of the infrastructure the power supply would be limited just by the unit characteristics, and not by any battery or vehicle's power supply.

The pre-trilateration tests served to observe the correct operation of the system. The developed programming was successfully tested performing exactly like it was intended. Relatively to the tests under a fixed layout these were done with 12V and thus could cover a larger area with power supply increasing, however they perfectly served to prove the system concept.

About the environment for which the system was developed, outdoor, it was observed a shorter distance range comparing with the indoor tests. Nonetheless, it can be concluded that the system is also functional and therefore can be applied in outdoor parking. Relatively to the vehicles application, the car windshield revealed to be an insurmountable obstacle for the ultrasounds, what prevents the user to push his/her PRC inside the vehicle. Therefore a new approach to this problem has to be studied, such as the PRC installation in the outside of the vehicle or just limit its use outside it.

Once a measurement system was developed, one of its most important quality factors is the measurement error. It is concluded that the maximum measurement error of the system is 9cm. This conclusion is based on both indoor and outdoor tests, being the final result very satisfactory. A successful calibration was the key to achieve such result, since the measurement errors were significantly higher before its application.

Another concern is the low-power consumption of the system. About this issue it can be concluded that the goal was successfully achieved. Moreover, the small difference in the power consumption when powered by 17,5V can be compensatory due the significantly increase of the system performance.

Finally, it remains to analyze the size and cost of the developed units. Beyond the small size of the μ MRF modules, the created ultrasonic modules present a small size as well, mainly due to the use of the SMD technology. The final result is thus satisfactory.

Relatively to the system cost, the price of a μ MRF module is unknown and therefore the conclusion will focus only on the ultrasonic modules. The receiver designed has a total cost of 13,97€ while the transmitter has a cost of 21,75€. The receiver cost seems acceptable in order to install an infrastructure layout in a parking zone. However the transmitter may be a little expensive to the regular user, due to its six transceivers which increase the final cost.

Upon the conclusion of the system tests and implementation is notorious the existence and necessity of future work. A few proposals are following presented with a view of the development continuity of this project.

The most obvious work is the development and implementation, through software, of the trilateration technique. The success of that would signify the conclusion of the localization system development and thus would allow to locate the user's PRC.

Furthermore, still through software, the system robustness can be improved. The most opportunist work would be the use of the μ MRF temperature sensor in order to acquire the air temperature in real time. This would enable the system adaption and thus the accuracy enhance of its measurements.

Relatively to the hardware there is also relevant work to be done in the future. The current system has a complicated power supply, since the μ MRF and the ultrasonic modules are powered up by different voltages. Therefore, in order to simplify, a unique power supply

could be developed to the system. Moreover this could be an opportunity to enhance the system efficiency, with the development of energy harvesting solutions as for example using the solar power source.

To conclude, once the PRC cannot transmit its pulses inside a vehicle, different options need to be studied and analyzed in order to achieve a new functional solution.

References

- [1] Shanker S. and Mahmud, S. M., "An Intelligent Architecture for Metropolitan Area Parking Control and Toll Collection", Intelligent Vehicles Symposium, 2005.
- [2] [Http://en.wikipedia.org/wiki/Parking_meter](http://en.wikipedia.org/wiki/Parking_meter), 2014.
- [3] Pala Z. and Inanc N., "Smart Parking Applications Using RFID Technology", RFID Eurasia, 1st Annual, 2007.
- [4] Tschentscher M. and Neuhausen M., "Video-based Parking Space Detection", Proceedings of the Forum Bauinformatik, 2012.
- [5] Zhang Bin, Jiang Dalin, Wang Fang, and Wan Tingting, "A Design of Parking Space Detector Based on Video Image", 9th International Conference on Electronic Measurement and Instruments, 2009.
- [6] Lee P., Tan H.-P., and Han M., "Demo: A Solar-Powered Wireless Parking Guidance System for Outdoor Car Parks", Proceedings of the 9th ACM Conference on Embedded Networked Sensor Systems, 2011.
- [7] Mingkai Che and Tianhai Chang, "A Parking Guidance and Information System Based on Wireless Sensor Network" IEEE International Conference on Information and Automation, 2011.
- [8] Stenneth L., Wolfson O., Bo Xu, and Yu P.S., "PhonePark: Street Parking Using Mobile Phones", IEEE 13th International Conference on Mobile Data Management, 2012.
- [9] Harle R. K. and Hopper A., "Deploying and Evaluating a Location-Aware System", Proceedings of the Third International Conference on Mobile Systems, Applications, and Services, USA, 2005.
- [10] Hightower J. and Borriello G., "Locations Systems for Ubiquitous Computing", IEEE Computer Society, Volume: 34, 2001.

-
- [11] Priyantha N. B., Chakraborty A., and Balakrishnan H., "The Cricket Location-Support System", Sixth Annual International Conference on Mobile Computing and Networking, 2000.
- [12] Fukuju Y., Minami M., Morikawa H., and Aoyama T., "DOLPHIN: An Autonomous Indoor Positioning System in Ubiquitous Computing Environment", IEEE Workshop on Software Technologies for Future Embedded Systems, Japan, 2003.
- [13] Zhang W., Djughash J., and Singh S., "Parrots: A Range Measuring Sensor Network", Technical report, Robotic Institute in Carnegie Mellon University, 2006.
- [14] Rui Zhang, Fabian Hofflinger and Leonhard M. Reindl, "TDOA based Localization using Interacting Multiple Model Estimator and Ultrasonic Transmitter/Receiver", 9th International Multi-Conference on Systems, Signals and Devices, 2012.
- [15] [Http://en.wikipedia.org/wiki/Speed_of_sound](http://en.wikipedia.org/wiki/Speed_of_sound), 2014.
- [16] Luca De Nardis and Maria-Gabriella Di Benedetto, "Overview of the IEEE 802.15.4/4a Standards for Low Data Rate Wireless Personal Data Networks", 4th Workshop on Positioning, Navigation and Communication, Germany, 2007.
- [17] [Http://en.wikipedia.org/wiki/IEEE_802.15.4](http://en.wikipedia.org/wiki/IEEE_802.15.4), 2014.
- [18] MCUSD16A40S12RO ultrasonic sensor datasheet, Multicomp, 2013.
- [19] [Http://www.microio.pt](http://www.microio.pt), 2014.
- [20] Pedro Do Mar, "Wireless Sensor/Actuator Networking For Home Assisted Living", Master Thesis on Electronics and Telecommunications Engineering, Aveiro, 2011.
- [21] MRF24J40MA RF transceiver datasheet, Microchip, 2008.
- [22] [Http://www.cadsoftusa.com/eagle-pcb-design-software/?language=en](http://www.cadsoftusa.com/eagle-pcb-design-software/?language=en), 2014.
- [23] Sedra Abel S., Smith Kenneth C., "Microelectronic Circuits", International 6th Edition, 2011.
- [24] [Http://www.viaverde.pt](http://www.viaverde.pt), 2014.