

We are IntechOpen, the world's leading publisher of Open Access books Built by scientists, for scientists

4,800

Open access books available

122,000

International authors and editors

135M

Downloads

Our authors are among the

154

Countries delivered to

TOP 1%

most cited scientists

12.2%

Contributors from top 500 universities



WEB OF SCIENCE™

Selection of our books indexed in the Book Citation Index
in Web of Science™ Core Collection (BKCI)

Interested in publishing with us?
Contact book.department@intechopen.com

Numbers displayed above are based on latest data collected.
For more information visit www.intechopen.com



Vibration Mitigation of Railway Bridge Using Magnetorheological Damper

Muzaffer Metin, Arif Ulu, Mahmut Paksoy and Murat Emre Yücel

Additional information is available at the end of the chapter

<http://dx.doi.org/10.5772/intechopen.71980>

Abstract

The purpose of this study is to analyze the railway bridge vibrations and control their negative effects through semi-active magnetorheological (MR) damper. Dynamic analysis of a railway bridge subjected to the moving load is performed. The real structural parameters are used, and the six-axle train is simulated as moving loads. The railway bridge is modeled as Euler-Bernoulli beam theory, and it is discretized through Galerkin method. To mitigate the bridge vibrations, MR damper with a fuzzy logic-based controller (FLC) is positioned at the ends of the bridge. The simulations of the system are performed by MatLab software. Finally, the results are examined both in the time and frequency domains.

Keywords: bridge vibration, vibration control, semi active control, magnetorheological damper, adaptive control

1. Introduction

In general, because of the increasing air pollution and traffic problems, rail vehicles gained importance as a mass transportation system. While the transportation speeds increased with the development of technology, expectations of comfort are also raised along the entire line, including bridges and viaducts. On the other hand, the bridges are enabled to be built light and slender. This made the bridges prone to the vibrations triggered by moving rail vehicles. The resulting vibrations reduce the safety of travel while also affecting the comfort of the passengers negatively. For this reason, the vibration analyses of railway bridges are considered as a significant factor in bridge design [1]. In recent years, research and development activities on suppressing railway bridge vibrations are increasingly concentrated, especially to increase passenger comfort without compromising safety at high speeds [1, 3, 11, 12]. For conventional speeds in railway transport, it may be sufficient to apply only passive methods such as polyurethane materials to insulate the bridge vibrations. However, after the increasing speeds

on the railways, semi-active and active control methods are begun to be tried as only passive methods do not provide the desired performance in suppressing bridge vibrations [1, 3, 11, 12].

The dynamic behavior of railway bridges under moving load is a complicated and challenging phenomenon and has drawn the attention of scientists and engineers due to the complex structure of railway bridges. The interaction between rail vehicle and bridge creates a dynamic effect. The most crucial parameters determining the dynamic response of bridges are rail vehicle speed, characteristics of bridge, and rail irregularity. The comfort level of the rail vehicles must meet expectations, while the safety of running is at the highest level. In order to do so, suppressing the railway bridge vibrations is significant as well as rail vehicle suspensions. In addition, the vibration control of a rail bridge is better both for bridge's life and safety of the rail vehicles. This also brings passengers' comfort improvement and allows them to pass faster.

Structural damping is one of the typical characteristics that damps the vibration effect of structures. Yet, that damping is regarded as insufficient. So, when the disturbance force is applied, it may cause strong and long-lasting vibrations. Hence, passive, semi-active, and active suspensions to mitigate vibrations are investigated.

Related literature shows that the structural control of the railway bridges subjected to the moving load is studied by many researchers. The bridge can be modeled as a simply supported Euler-Bernoulli beam [2], and the train mass is modeled at a constant speed as a time and spatially changing load. For this aim, lumped parameters of the vehicle can be neglected [3]. Also, some models which have lumped parameters are adopted subsequently in the related study [4, 5]. On the other hand, several researches on bridges' dynamic response under the moving load demonstrate the effects of moving train.

The suspension types of railway bridges are separated into three groups which are passive, semi-active, and active suspensions. However, only the active suspensions can be controlled by applying an external force. The idea in implementing a semi-active suspension is to change active force generator with adaptive elements that can shift the rate of energy dissipation in response to a momentary condition of motion. The force of suspension can be controlled through active causes in response to sensory feedback, whereas the actuators are used in active controllers to implement an independent force on suspension [6]. We could say that semi-active systems are more practical than passive systems and less expensive and complicated than active systems [7]. It is widely known that the MR damper is quite feasible and reliable to implement in reducing vibrations [8] since its performance is better than passive suspension as its power requirements are low and its hardware is less expensive than active suspension [9]. Usually, the MR damper-based semi-active controller works through a two-step progress. Firstly, a system controller designates the desired control force in respect of the responses; then damper controller sets the command applied to the MR damper so that it can track the desired control force. Hence, the success of MR damper-based semi-active controller depends on two aspects: One of them is to select a proper control strategy, and the other is to establish the accurate damper controller [10].

In this paper, the vibration of railway bridges subjected to the moving load is investigated. The bridge model is taken into consideration as a simple support beam. As the model is a continuous

one, it is changed to discrete model through the Galerkin method, and its vibration is investigated when subjected to the force which is due to the train passing on the bridge. To mitigate vibrations, two symmetric MR dampers are applied to the bridge from the bottom. Fuzzy logic control method is used on MR dampers to determine the voltage input. Controlled and uncontrolled results of vibration analyses are analyzed.

2. Mathematical modeling

Figure 1 shows a model of railway bridge. Bridge modeled as Euler-Bernoulli beam is a constant cross section, homogeneous, and simply supported. At that time MR dampers that modeled as modified Bouc-Wen model is located on two sides of bridge. In addition, forces are thought as axial forces of railway train axles:

$$m \frac{\partial^2 w(x, t)}{\partial t^2} + c \frac{\partial w(x, t)}{\partial t} + EI \frac{\partial^4 w(x, t)}{\partial x^4} = \sum_{j=1}^6 \delta(x - vt) P_j + \sum_{j=1}^2 \delta(x - x_{dj}) F_{MRj} \quad (1)$$

where EI , m , c , and $w(x, t)$ were flexural rigidity mass per length, the damping coefficient, and transverse displacement of bridge at point x and time t , respectively. Parameters of bridge were given in **Table 1**. Right hand of equation is axial forces (P) represented by Dirac-delta function

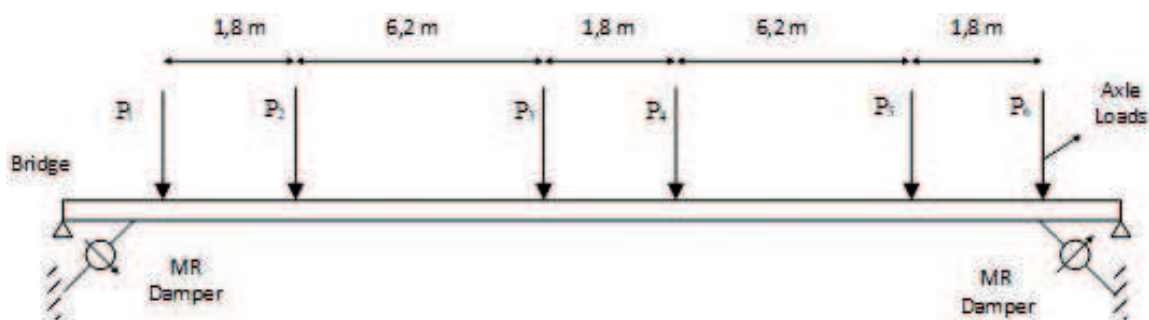

Figure 1. Railway bridge with MR dampers acted on moving axle loads.

Young's modulus (N/m ²)	210 × 10 ⁹
Area moment of inertia (m ⁴)	0.61
Mass per length (kg/m)	18,400
Length of the beam (m)	42
Moving load (N)	80,000
Damping ratio	0.1
MR damper locations (m)	5.37

Table 1. Properties of railway bridge [11].

and MR damper forces. Dirac-delta function $\delta(x)$ was thought as a unit concentrated force acting at point $x = 0$. Dirac-delta function was defined in Eq. (2):

$$\int_a^b \delta(x - vt)f(x)dx = f(\xi) \text{ for } a < \xi < b \quad (2)$$

By using Galerkin method, transverse function $w(x, t)$ was transformed into two separate functions Eq. (3). A sinus function $(\sin \frac{i\pi x}{L})$ depending on x , in order to satisfy boundary conditions, was selected:

$$w(x, t) = \sum_{i=1}^N T(t) \sin \frac{i\pi x}{L} \quad i = 1, 2, \dots, N \quad (3)$$

Trial function (3) is implemented in Eq. (1), multiplied full equation with trial function and integrated from 0 to L . Finally, a partial differential equation (Eq. (1)) is turned into ordinary differential equation (Eq. (4)):

$$m\ddot{T}_i(t) + c\dot{T}_i(t) + EI\left(\frac{i\pi}{L}\right)^4 T_i(t) = \sum_{j=1}^6 \frac{2P_j}{L} \sin\left(\frac{i\pi(vt - L_j)}{L}\right) + \sum_{j=1}^2 \frac{2F_{MRj}}{L} \sin\left(\frac{i\pi x_{dj}}{L}\right) \quad i = 1, 2, 3, \dots, N \quad (4)$$

At the right-hand side of equation, there are eight forces. The first six forces are moving forces that represented train axle loads. L_1, L_2, \dots are distance from first wheel (**Figure 1**). The last ones are the MR damper forces that were located two sides (x_{d1}, x_{d2}) of bridge.

Damping of bridge is modeled as Rayleigh structural damping [2] and depends on mass, rigidity, and natural frequencies of the bridge (Eqs. (5)–(6)). ω_i and ω_j are represented natural frequencies of the simply supported bridge. Railway bridge model parameters are given in **Table 1**:

$$c = a_0 m + a_1 k \quad (5)$$

$$a_0 = \xi \frac{2\omega_i \omega_j}{\omega_i + \omega_j}; a_1 = \xi \frac{2}{\omega_i + \omega_j} \quad (6)$$

As mentioned above, MR Dampers modeled modified Bouc-Wen Model that related equations are given Eqs. (7)–(12) [12]:

$$\dot{z} = -\gamma|\dot{x} - \dot{y}||z|^{n-1}z - \beta(\dot{x} - \dot{y})|z|^n + A(\dot{x} - \dot{y}) \quad (7)$$

$$\dot{y} = \frac{1}{c_0 + c_1} [az + c_0\dot{x} + k_0(x - y)] \quad (8)$$

A (m^{-1})	2769
β, γ (m^{-1})	647.46
k_0 (N/m)	137,810
n	10
x_0 (m)	0.18
k_1 (N/m)	617.31

Table 2. Model parameters of MR damper [12].

where k_1 is the accumulator stiffness, c_0 is the viscous damping at larger velocities, c_1 is viscous damping for force roll-off at low velocities, x_0 is the initial displacement of spring k_1 , and A , β , γ , and n are the constants about MR damper. The force was calculated as Eq. (9) [12]. Model parameters of MR damper is given in **Table 2**:

$$\begin{aligned}
 F_{MR} &= az + c_0(\dot{x} - \dot{y}) + k_0(x - y) + k_1(x - x_0) \\
 &= c_1\dot{y} + k_1(x - x_0)
 \end{aligned}
 \tag{9}$$

c_0 , c_1 , and a have form of third-order polynomial with respect to electrical current i , expressed as Eqs. (10)–(12):

$$a(i) = 16566i^3 - 87071i^2 + 168326i + 15114 \tag{10}$$

$$c_0(i) = 437097i^3 - 1545407i^2 + 1641376i + 457741 \tag{11}$$

$$c_1(i) = -9363108i^3 + 5334183i^2 + 48788640i - 2791630 \tag{12}$$

Axle loads of Asea Brown Boveri (ABB) brand light rail vehicle used in the Istanbul urban transportation are considered as moving loads (**Figure 2**). Railway vehicle parameters are given in **Table 3**.



Figure 2. ABB railway vehicle.

Length (m)	23.2
Width (m)	2.65
Passengers capacity	257
Max design axle load (kN)	80
Wheel diameter (m)	0.68–0.6
Wheel width (m)	0.125
Max speed (km/h)	80

Table 3. ABB railway vehicle parameters [13].

3. Fuzzy control design

Fuzzy logic-based controllers (FLC) are frequently used in vibration reduction problems. Classical fuzzy logic controller is used in this paper which is based on two-input one-output FLC structure. The overall structure of used controller is shown in **Figure 3**.

The structure of fuzzy logic controller has two inputs and one output. The inputs are, respectively, “ V_1 ” which is defined as the velocity of middle point of bridge model, and “ V_2 ” which is defined as the velocity of the upper end point of MR damper. Linguistic variables which imply inputs and output are classified as NB NM NS ZO PS PM PB. Inputs and output are all normalized in the interval of $[-1, 1]$, as well as outputs are normalized at range of $[0, 1]$ as shown in **Figure 4**. Linguistic values which are used as output values are the following: ZO, VS, S, SM, M, B, and VB.

The variables are scaled with coefficient of S_{V1} , S_{V2} , and S_u . The fuzzy control rule is in the form of:

IF $e = E_i$ **and** $de = dE_j$ **than** $V = V_{(i,j)}$.

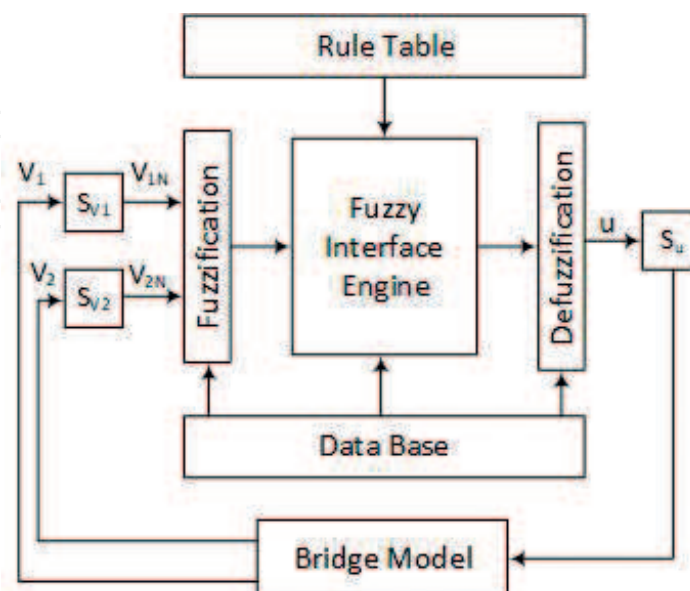

Figure 3. Block diagram of the two-input one-output fuzzy logic controller.

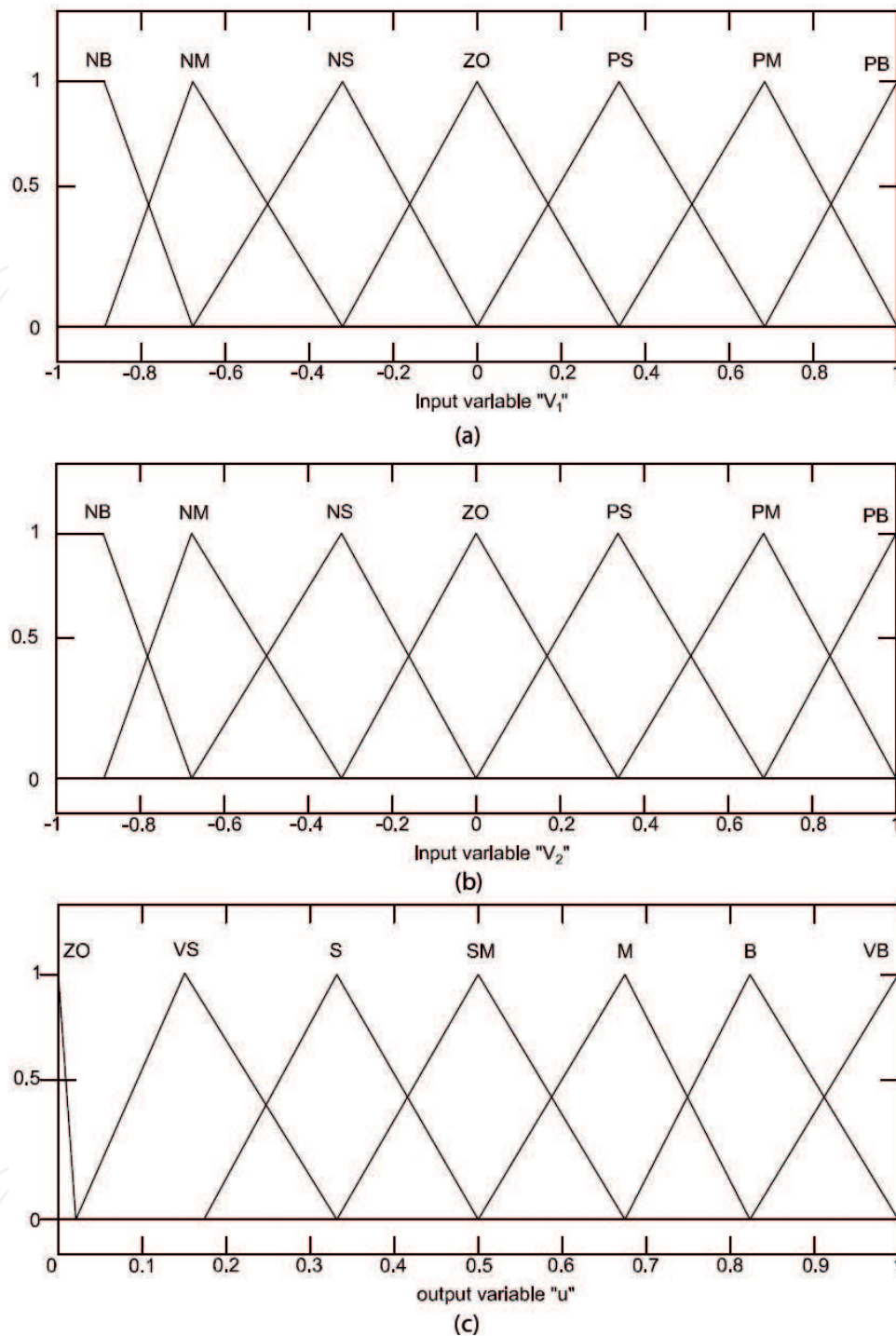

Figure 4. Membership functions of inputs V_1 (a) and V_2 (b) and output u (c).

These rules are written in a rule base lookup table which is shown in **Table 4**. The rule base structure is Mamdani type.

The linguistic labels used to describe the Fuzzy sets are “negative big” (NB), “negative medium” (NM), “negative small” (NS), “zero” (ZO), “positive small” (PS), “positive medium” (PM), “positive big” (PB), very small (VS), small (S), small medium (SM), medium (M), big (B), and very big (VB). It is possible to assign the set of decision rules as shown in **Table 1**. These

V1/V2	NB	NM	NS	ZO	PS	PM	PB
NB	SM	S	VS	ZO	VS	S	SM
NM	M	SM	VS	ZO	VS	SM	M
NS	B	M	S	ZO	S	M	B
ZO	VB	B	SM	ZO	SM	B	VB
PS	B	M	S	ZO	S	M	B
PM	M	SM	VS	ZO	VS	SM	M
PB	SM	S	VS	ZO	VS	S	SM

Table 4. Rules of fuzzy logic controller.

rules contain the input-output relationships that define the control strategy. Each control input has 7 fuzzy sets, so that there are 49 fuzzy rules.

4. Simulations

According to Eq. (4), the bridge model is considered for five modes. It was enough for the reliable responses of the bridge. MR damper models and bridge equations with fuzzy control tools are simulated in MATLAB-Simulink and performed in ode45 solver.

In all analysis train's speed was fixed to a maximum of 80 km/h for urban transportation. Moving loads are acting on bridge during 2.853 s. In uncontrolled system, supplied electrical current is fixed 0.05 A.

Figures 5–7 show the dynamic responses of midpoint of the railway bridge. Blue straight and red dashed lines show the uncontrolled and fuzzy controlled system, respectively. Maximum values of bridge responses are suppressed successfully, especially in velocity and acceleration. Also, settlement time of controlled bridge vibrations turns out to be better than uncontrolled system:

Figures 8–9 show the dynamic MR damper forces and electrical current that supplied the dampers. Straight lines and dashed lines represent the responses of the first and second MR dampers. **Figures 5, 6, and 8** show that the MR dampers generate forces in the same direction with the bridge velocity and in the opposite direction with the bridge motion. To control the MR damper structure, the maximum current occurs at 1.8 A.

If it is considered that displacement is concerned with running safety and acceleration with passenger comfort, **Figure 5** and **7** show that the MR damper performance is quite good in terms of both safety and comfort.

Power spectral density (PSD) of bridge vertical acceleration is shown in **Figure 10**. When we analyze **Figure 10**, it can be seen that the fuzzy logic controller reduced the magnitude of the bridge vertical acceleration in all frequencies significantly.

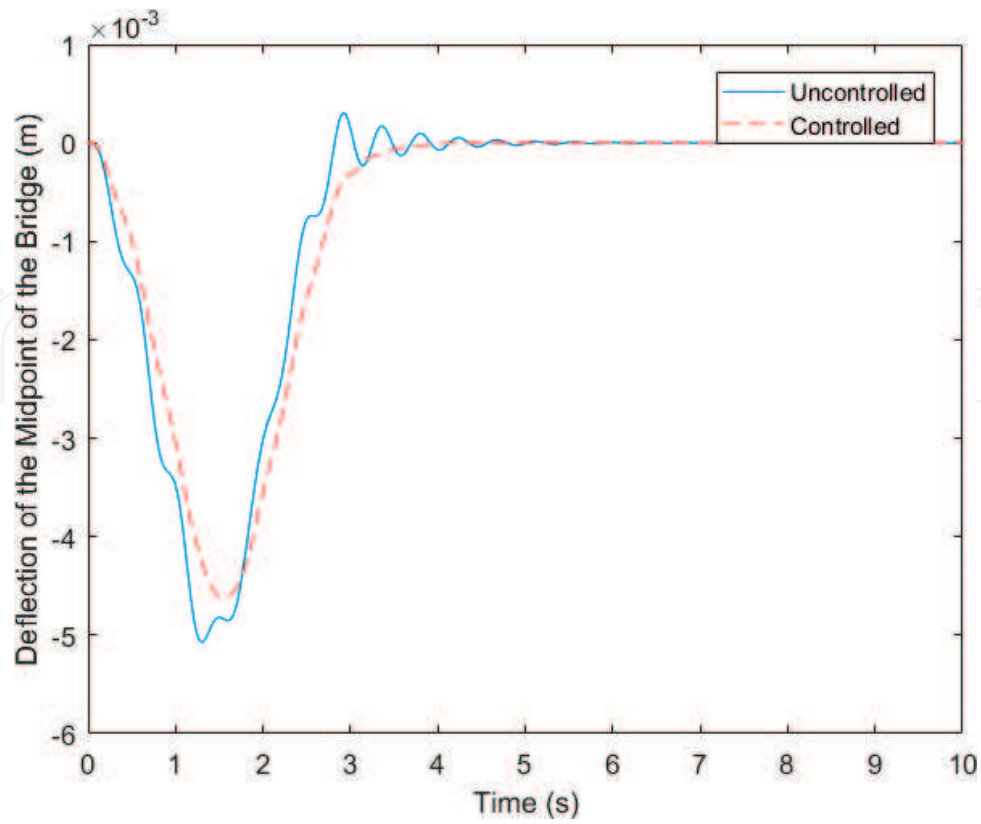

Figure 5. Displacement of the midpoint of the railway bridge.

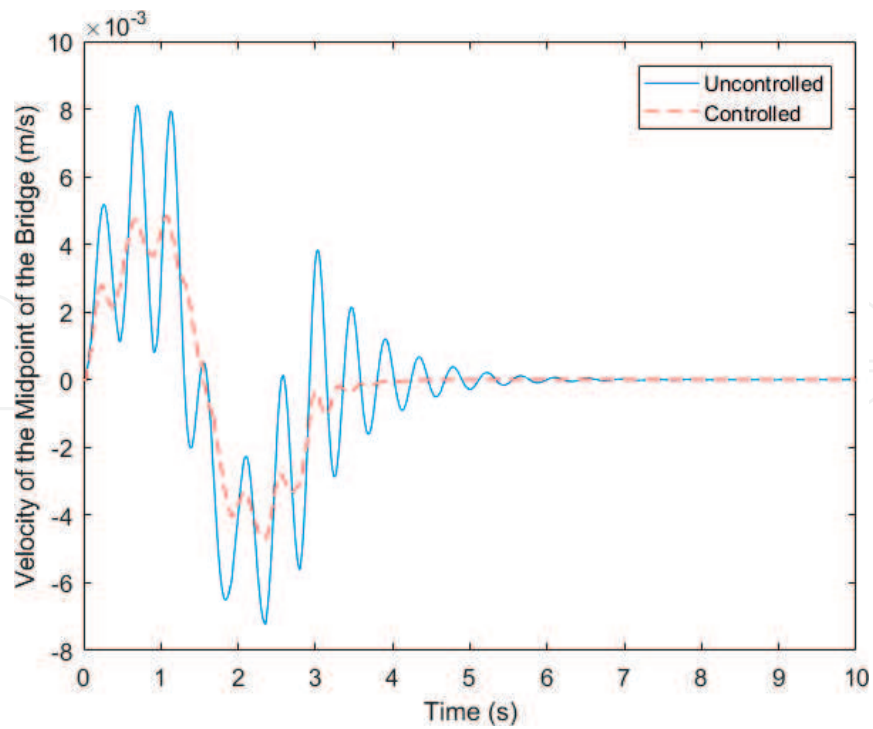

Figure 6. Velocity of the midpoint of the railway bridge.

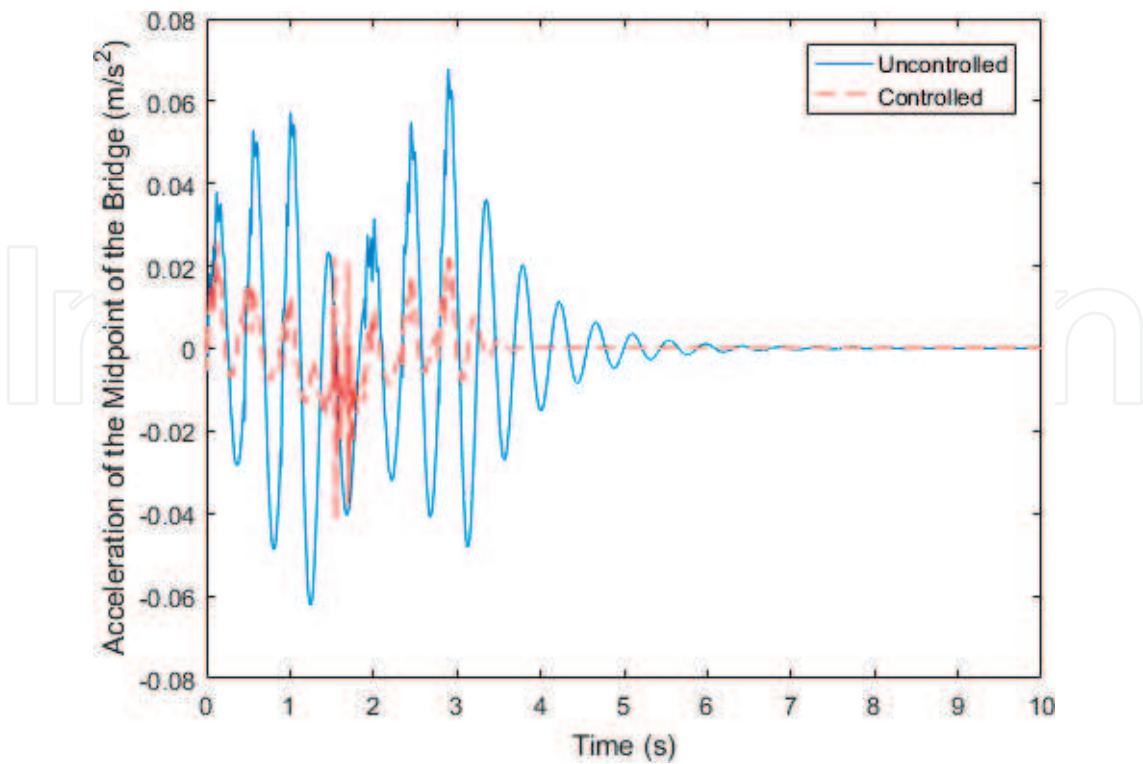

Figure 7. Acceleration of the midpoint of the railway bridge.

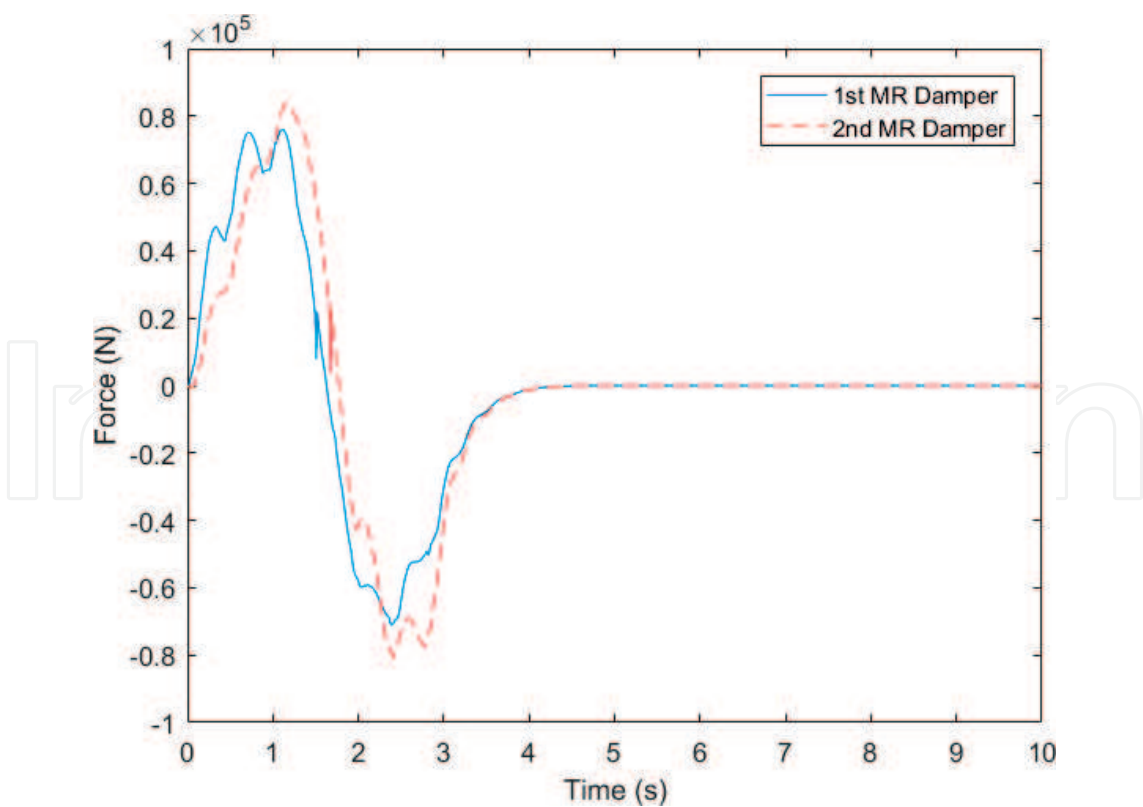

Figure 8. Two MR dampers' forces.

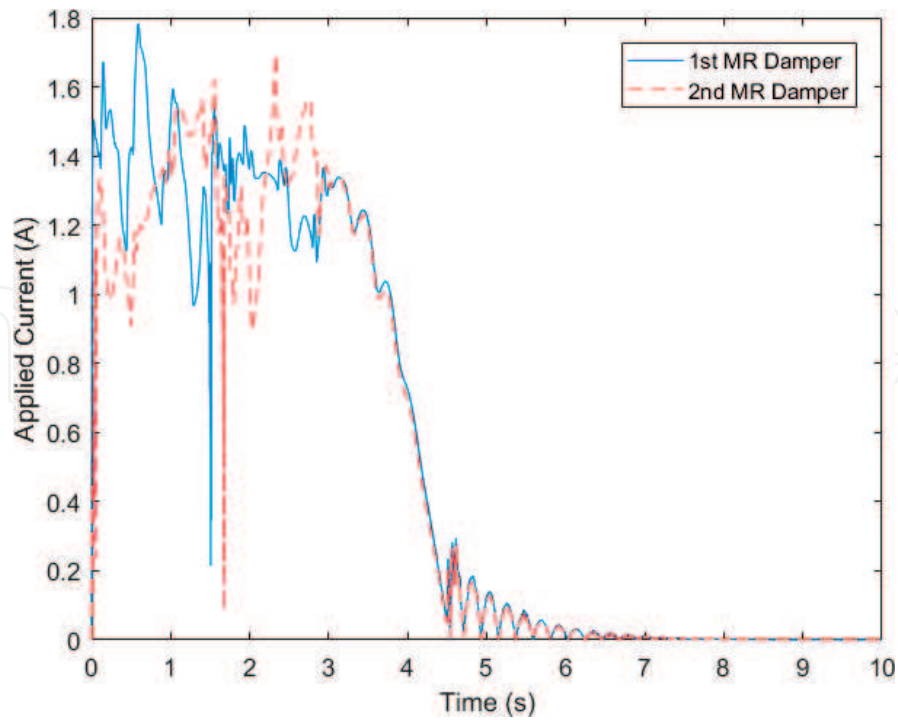

Figure 9. Applied current on the MR dampers.

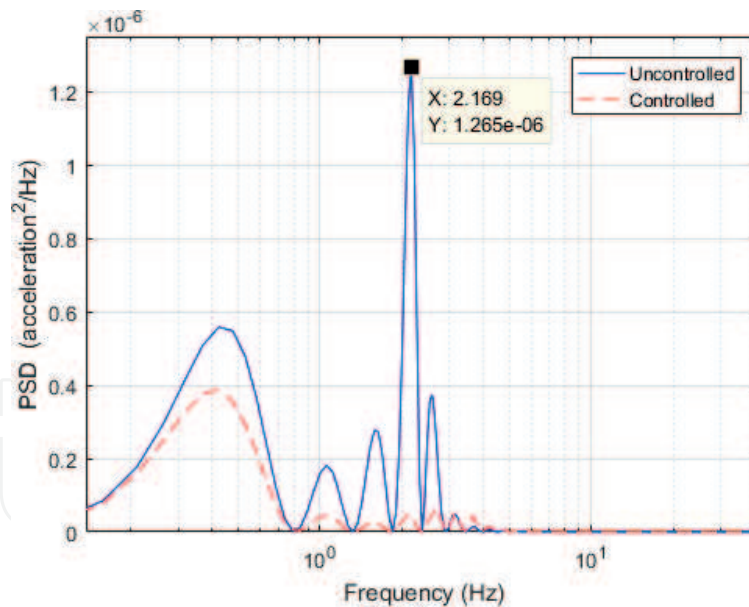

Figure 10. Power spectral density of acceleration data of the railway bridge.

Natural frequencies are calculated as 2.29, 9.17, 20.63, 36.69, and 57.32 Hz, by using Eq. (13). It is widely known that the most dangerous frequency is the first natural frequency in the structures. In this regard, the first natural frequency is well suppressed via fuzzy logic-controlled MR dampers:

$$W_n = \left(\frac{i\pi}{L}\right)^2 \sqrt{\frac{EI}{m}} \quad i = 1, \dots, 5 \quad (13)$$

5. Conclusions

The responses of a passive system to track inputs or other disturbances are obtained by using parameters such as inertia, spring, and damping. However the response for an active suspension system is developed by using a control algorithm. In this study the railway bridge vibrations are controlled through magnetorheological (MR) damper by using fuzzy logic control algorithms. This controller is preferred because of its superior performance in semi-active vibration control.

Firstly, the railway bridge is modeled as Euler-Bernoulli beam. Equations of the bridge are achieved according to Galerkin method. To suppress the railway bridge vertical vibrations, two MR dampers are positioned at the bridge ends. In the mathematical model of the bridge, MR damper is considered as friction-based modified Bouc-Wen model. The damping force of MR damper which changes with applied electrical current is controlled by the use of fuzzy logic controller. This control method's high performance, easy design, and robust character are some of the reasons for using it.

In simulations, railway vertical vibrations are analyzed for active and passive MR damper situations while six-axle railway vehicle is passing through the bridge. When the simulation results are examined, the vibration reduction performance of fuzzy logic controller in time and frequency domain can be seen. FLC performance has been simulated by comparing the results of passive and semi-active MR damper models.

Extension of bridge life, mitigation of negative effect of vibrations on human bodies and rail vehicles, and increasing of passenger comfort can be provided by reduction of bridge displacements and accelerations when passing the railway vehicle. It is observed that the method used in this study shows superior performance in the simulation environment and produces results that are suitable for all these purposes.

For the future work, fuzzy logic controller performance should be investigated taking into account the rail roughness resulting from wearing. In this way, adaptive methods for input and output parameters of controller should be developed to improve the controller performance. Also, different control algorithms can be compared, and it can be applied on the real bridge systems.

Author details

Muzaffer Metin*, Arif Ulu, Mahmut Paksoy and Murat Emre Yücel

*Address all correspondence to: mmetin@yildiz.edu.tr

Department of Mechanical Engineering, Yildiz Technical University, Turkey

References

- [1] Luu M, Martinez-Rodrigo MD, Zabel V, Könke C. Semi-active magnetorheological dampers for reducing response of high-speed railway bridges. *Control Engineering Practice*. 2014; **32**:147-160
- [2] Clough RW, Penzien J. *Dynamics of Structures*. 2nd ed. New York: McGraw-Hill; 1993
- [3] Jiang Z, Christenson R. Experimental verification of an MR damper controlled highway bridge. 19th Analysis & Computation Specialty Conference, ASCE; 2010. pp. 347-358
- [4] Sadiku S, Leipholz HHE. On the dynamics of elastic systems with moving concentrated masses. *Ingenieur-Archiv*. 1987;**57**:223-242
- [5] Akin JE, Mofid M. Numerical solution for response of beams with moving mass. *Journal of Structure Engineering*, ASCE. 1989;**115**(1):120-131
- [6] Pisal AY, Jangid RS. Vibration control of bridge subjected to multi-axle vehicle using multiple tuned mass friction dampers. *International Journal of Advanced Structure Engineering*. 2016;**8**:213-227
- [7] Metin M, Guclu R. Rail vehicle vibrations control using parameters adaptive PID controller. *Mathematical Problems in Engineering*. 2014;**2014**, Article ID 728946, 10 p
- [8] Metin M, Yücel ME, Paksoy M, Çetin Ş. Controlling rail vehicle vibrations using Magnetorheological damper. 3rd International Symposium on Railway Systems Engineering (ISERSE'16), October 13–15; 2016. Karabuk: Turkey
- [9] Zong L, Gong X, Xuan S, Guo C. Semi-active H_{∞} control of high-speed railway vehicle suspension with magnetorheological dampers. *Vehicle System Dynamics: International Journal of Vehicle Mechanics and Mobility*. 2013;**51**(5):600-626
- [10] Liao WH, Wang DH. Semiactive vibration control of train suspension systems via magnetorheological dampers. *Journal of Intelligent Material Systems and Structures*. 2003;**14**(3): 161-172
- [11] Radeström S. Application of fluid viscous dampers to mitigate vibrations of high-speed railway bridges. *International Journal of Rail Transportation*. 2017;**5**(1):47-62
- [12] Yang M. Longitudinal vibration control for a suspension bridge subjected to vehicle braking forces and earthquake excitations based on magnetorheological dampers. *Journal of Vibration and Control*; 2015;**22**(17):3659-3678
- [13] Metin M. Raylı sistem araçlarının modellenmesi ve titreşimlerinin kontrolü”, M.S. thesis. Istanbul: YTU; 2007

