

We are IntechOpen, the world's leading publisher of Open Access books Built by scientists, for scientists

4,800

Open access books available

122,000

International authors and editors

135M

Downloads

Our authors are among the

154

Countries delivered to

TOP 1%

most cited scientists

12.2%

Contributors from top 500 universities



WEB OF SCIENCE™

Selection of our books indexed in the Book Citation Index
in Web of Science™ Core Collection (BKCI)

Interested in publishing with us?
Contact book.department@intechopen.com

Numbers displayed above are based on latest data collected.
For more information visit www.intechopen.com



WSN in Conservation Management

Akbar Ghobakhlou and Shane Inder

Additional information is available at the end of the chapter

<http://dx.doi.org/10.5772/intechopen.70383>

Abstract

A wireless sensor network (WSN) utilising a mesh configuration is a cost-effective and labour-saving solution for remotely monitoring traps and tracking devices used in conservation management. The unintentional introduction of stoats and rats into a once pristine ecosystem has resulted in the devastation of large parts of New Zealand's native flora and fauna. Other equally harmful mammalian species, including possum, for their fur, and domestic cats, were introduced intentionally. Abundant vegetation and a lack of predators lead to rampant population growth, further exacerbating their destructive impact. Effective monitoring, trapping and control of mammalian pests have proven difficult, time-consuming and expensive, primarily relying on socially controversial methods such as aerially delivered toxins. Despite advances in technology, costly and time-intensive manual checking of lures, toxins, traps and tracking devices remains a limiting factor. Together with WSN-based remote monitoring capability, these advances look set to have a significant impact. This chapter discusses opportunities for WSN in conservation management. It outlines a mammalian pest management project utilising a series of possum-specific self-resetting traps. A WSN designed for remotely monitoring possum trap activity is detailed, and the process for reconfiguring and presenting field-trial data via alpha-numeric and graphical user interface applications is described.

Keywords: WSN, mesh network, pest management, possum control, remote monitoring

1. Introduction

Introduced invertebrate pests, such as rats, mustelids (ferrets; *Mustela furo* and stoats; *Mustela erminea*) and possums (*Richiurus Vulpecula*), have and continue to cause irreparable damage to New Zealand's flora and fauna. The greatest impact can be seen in New Zealand's avifauna where 42% of land bird species abundant prior to human habitation are now extinct. Of the remaining 155 native species, 45 (29%) are now endangered [1]. As the primary maintenance,

host of bovine tuberculosis (bTB), possum in particular, pose not only an ecological threat but also a significant economic one to New Zealand. The main goal of TBFree New Zealand (formerly Animal Health Board) is to manage intensive control of brushtail possum as the principal vector of bTB. TBFree NZ funded research has supported the development of cost-effective, environmentally acceptable tools and tactics for wildlife disease surveillance and control [2]. Fundamental to the success of TBFree's eradication strategy is the role of research in developing and testing innovative improvements to cost-effective control and surveillance technologies. Researchers are gaining a better understanding of the behaviours of possums at low densities and developing a suite of detection, possum-specific toxins and application methods and pest control systems, aimed at sustainable pest management [3]. Significant efforts are being made to create mammalian pest-free islands and sanctuaries equipped with predator-free fences according to a 2014 Royal Society of New Zealand 'Expert Advice Paper'. To avoid reinvasion, the paper continues to describe the need for humane methods of eliminating pests at landscape scale. Along with greater public support, it also suggests maintenance, involving effective large-scale monitoring, identification of pest species and trapping of reinvasers.

In order to address some of these issues, a number of interdisciplinary teams of researchers from across New Zealand have engaged to develop new tools and techniques for conservation management. Working across multiple projects, the teams have developed species detection and monitoring devices that incorporate advanced digital technologies; a suite of advanced humane toxins; targeted, electromechanical toxin delivery devices and systems and long-lasting baits and lure systems. Academic teams were linked to industry partners to commercialise viable outputs and disseminate best practice approaches. Teams included ecologists, toxicologists, engineers, animal behaviour experts and industrial designers. Working in interdisciplinary project teams has generated benefits for all involved. Designers, for example gained expert knowledge, access to innovative ecological and technological developments and to testing facilities that were utilised in the design process, ensuring outcomes were fit for purpose and maintained longevity throughout the validation process and into the marketplace. Experts in conservation science benefited from the engagement by seeing the transformation of data from their research into tangible and readily influential form for iterative development and into commercialisation. As identified by Root-Bernstein and Ladle [4], conservation scientists do not commonly have the expertise to turn their data into functional products.

The user-centred approach was utilised to investigate and evaluate not only the technical requirements but also stakeholder and user needs to help contextualise the projects.

In order to gain an empathetic understanding of user needs, limitations and context, qualitative research methods were used. These included stakeholder interviews, objective observation and photo-ethnography during field trips with a diverse group of conservation staff, engineers and designers. Functional and user-focussed constraints informing the development of prototypes drew from data gathered. Field trips also gave first-hand insights into the complexities of ecological systems and the interactions and behaviours of the organisms within. Opportunities for product or system efficiency gains were highlighted by the difficulties faced

by conservation workers and the labour intensiveness of existing processes such as data collection and device management [5, 6]. Qualitative research supplemented iterative prototyping and testing to inform continual development.

Although this research has delivered a suite of individual tools to use in the battle against mammalian pests, from a holistic perspective, there are a number of opportunities yet to be addressed. The time involved in set-up, checking, resupplying lures and resetting devices is still significant, particularly in some very large, often inaccessible areas of New Zealand's conservation estate. The ability to remotely access the data generated and stored in these digital devices would greatly enhance their efficiency as conservation management tools. Remote access to devices to monitor activity would reduce the frequency of manually checking devices, retrieving data and replenishing baits and lures.

Utilising a robust wireless sensor network (WSN) to remotely access and/or control devices may prove to be a feasible option. They are a relatively low cost, mature technology, which permits communication over a large area with a network of simple devices. Their use for detection and tracking purposes has already been demonstrated in diverse works [7–10]. Two projects have emerged that will demonstrate the efficiency gains possible with the integration of a WSN. One in the area of species recognition and monitoring and another a targeted pest management tool. It is anticipated that an ability to remotely monitor these tools will enable a more holistic, strategic and efficient conservation management approach.

2. Related work—potential applications in conservation management

Pest management and monitoring costs New Zealand's Department of Conservation around 10 percent of its total \$450 million budget [10]. While advances in technology have seen the introduction of a suite of products aimed at efficiency gains, set-up and monitoring these devices remain a manual operation.

A significant amount of terrestrial wildlife management involves the use of landscape-scale tracking, trapping and/or pest eradication programs on government or conservation land tenures. These programs aimed at control and research on estimating species densities or investigating their ecology, which include live trapping programs to capture animals for study. Jones et al. [6] estimated that cost savings of up to 70% could be accrued from the use of WSN-enabled systems.

2.1. Monitoring

Analysing footprints on ink blotted paper, caused by animals walking through simple tracking tunnels, is a technique first described in 1977 [7]. The tunnels (**Figure 1**) are inexpensive

and reasonably sensitive to the presence of rodents (particularly rats) when they are present at low densities less so with mustelids (weasels, ferrets and stoats) and possum. Wet weather and overtracking are key limitations of tracking tunnels, which can lead to data loss [11]. High population densities can lead to overtracking making identification of discrete footprints difficult. The paper or card substrate used to collect print data is prone to becoming illegible due to wet weather. Modifications to tunnels or more frequent paper changes can overcome this, however, at additional expense in equipment and time.

An interdisciplinary team, including ecologists, engineers and designers, from Lincoln University and Auckland University of Technology has developed an animal tracking system that addresses the shortcomings of traditional tracking tunnels. Using 'touch screen' technology, the Print Acquisition for Wildlife Surveillance (PAWS) device digitally records animal interactions. Time, date and weight data are collected along with the animals' footprint files. A field worker collects the digital data via a Bluetooth-enabled smartphone. Files are later uploaded to a computer for analysis and utilising a tailored algorithm, identify species with near perfect accuracy. Trials have proven that they are far more successful at monitoring pest animals than traditional options such as tracking tunnels, wax blocks or chew cards [12].

A PAWS device (**Figure 2**) utilising data transfer over a WSN would have significant advantages over manual data collection. Low power consumption, long-life batteries and/or solar recharging allow PAWS devices to remain active in the field indefinitely, continually relaying data. Reconfiguring the data and mapping species detection in real-time would allow conservation groups to utilise limited time and financial resources in areas that require immediate attention, such as pest management, and establish strategic programs to avoid reinfestation.

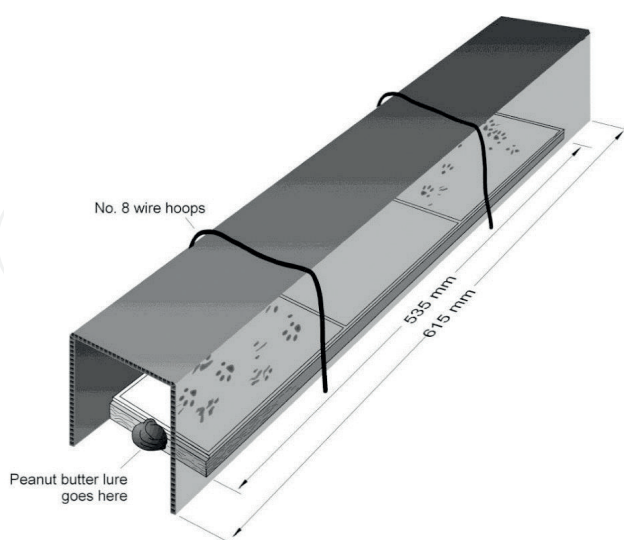

Figure 1. Traditional tracking tunnels used to monitor rodents and mustelids, DOC tracking tunnel guide v2.5.2, adopted from [7].



Figure 2. Print Acquisition for Wildlife Surveillance (PAWS) concept (adopted from [12]).

2.2. Pest management

Single kill traps and aerial distribution of 1080 are the primary means of controlling pest populations in New Zealand currently. Despite widespread public concerns over its use, the Environmental Risk Management Authority (ERMA) and Animal Health Board (AHB) determined in a 2007 assessment that Aerial application of 1080 toxin in cereal pallets, accounting for around 440,000 ha or 5% of conservation land [9] each year, has significant benefits for New Zealand's environment [8]. According to the report, 'These benefits would not be fully realised if the use of 1080 were restricted to ground-based operations only'. This is largely due to the inaccessibility of large parts of New Zealand's conservation estate and the high financial cost and labour intensity associated with ground-based pest control methods.

The NZ Department of Conservation describes the DOC200 box (see **Figure 3**) configured with a single-kill, spring-activated trap as 'best practice' for the control of rats, stoats and hedgehogs. This current paradigm for pest control has a proven track record in the field, is robust and is familiar to users. However, this approach is also time-consuming and expensive, requiring constant checking, resetting and lure/bait resupply.

The team was asked to deliver a reliable, cost-effective, safe and humane method for the extermination of large numbers of possums (100 toxicant doses per unit). In order to 'gain public support for mammalian pest control or eradication, especially where this involves toxins' [14], an interdisciplinary team was contracted to develop a possum focused targeted delivery system to exploit new humane toxins that had been developed. These toxins aimed to overcome environmental and economical inherent in aerially delivered or repeated manual replenishment of bait stations [13]. Species specificity, economical to produce and an ability to withstand being active in the field for over 12 months were also critical requirements of the system. It needed to be lightweight, low maintenance, robust and house the toxin securely [5].

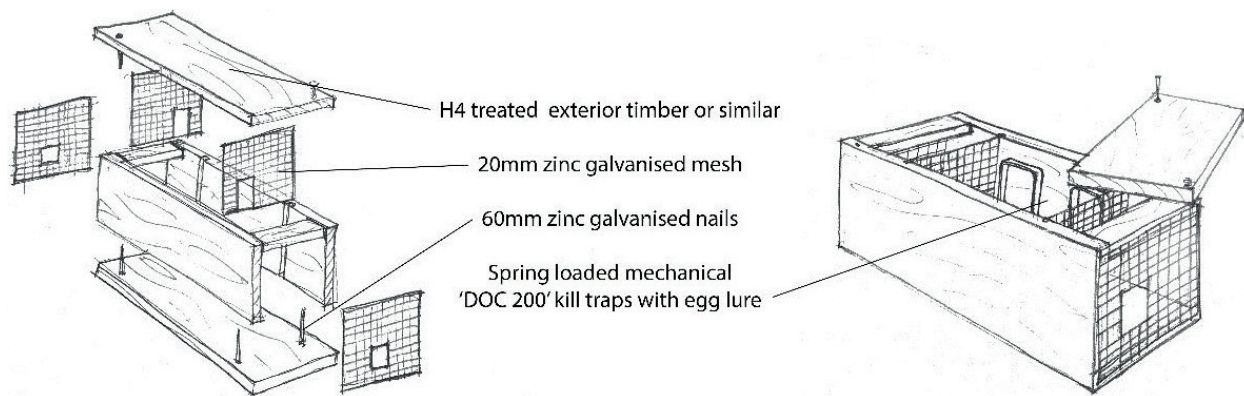

Figure 3. The DOC 200 approved humane kill trap for stoats, rats and hedgehogs [13].

A 2013 Field trial of prototype (see **Figure 4**) possum-specific toxin delivery units validated the efficacy of the toxin delivery devices. However, the trial proved to be very labour intensive due to daily frequent manual checking of traps, replenishing lures, downloading data logs and ensuring on-going functionality. These early trials utilised motion-detecting cameras at each device and pre-attached proximity collars on possums and devices (**Figure 4**). Reviewing radio-tracking signals from the 13 pre-collared possums indicated possum mortality and enabled the verification and collection of collars. **Table 1** shows station/mortality collar data downloaded for evaluation. Testing 10 of the 13 collared possums killed by spitfires with 8 of 9 of those collared in the site with a further 2 of 4 possums collared outside site. Uncollared possums seen after most collared had been killed. Most of the device activations occurred after the devices had been out for over 1 week. No non-targets were sprayed (mice, rabbits and pigs were present) indicating the triggering mechanisms worked as intended [12].

The field trail proved to be a successful approach to possum-specific pest control in this context; however, daily monitoring of the system in difficult terrain was expensive and labour intensive. It was therefore recommended that researchers explore methods to remotely access data and to decrease the necessity to check devices in the field.

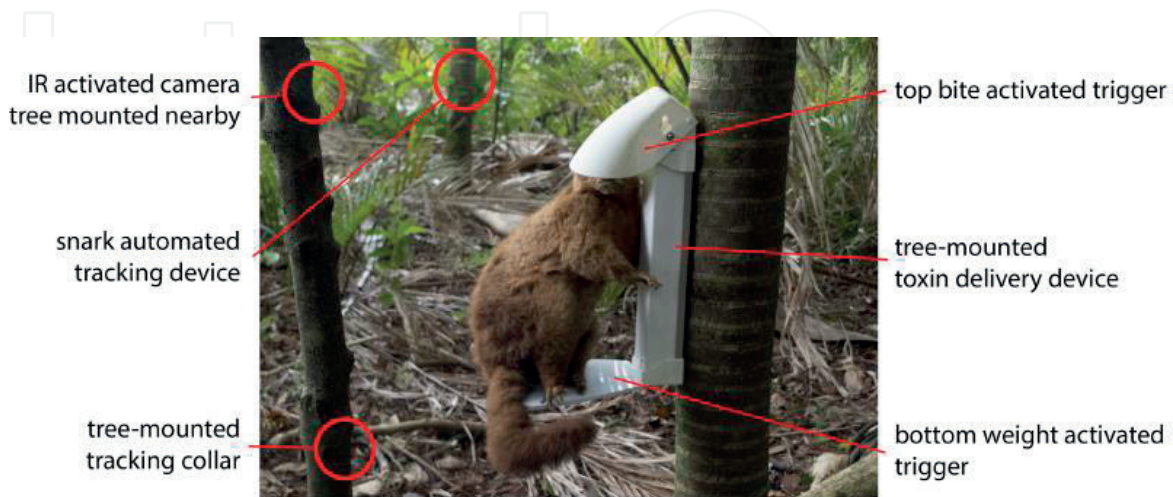

Figure 4. Field trial devices configured to capture firing event data, including date, time, and location and snapshot evidence.

Device number	No. of activations	Observations
SF1	1	10 out of 13 collared possums killed by spitfires and 8 out of 9 of those collared in the site. 2 out of 4 possums collared outside site.
SF2	2	
SF3	3	
SF4	1	Most fires occurred one week after devices were installed on site.
SF5	1	
SF6	1	Un-collared possums seen after most collared gone and no non-targets sprayed; mice, rabbits were pigs present at site.
SF8	8	
SF9	4	Juveniles are not heavy enough to trigger the spitfires. Lighter trigger required for juveniles.
SF10	1	
SF11	1	Some possums removed/accessed bait by sitting on hood. Possums seen groom shortly after toxin application
SF12	5	

Table 1. Log of triggering events and field trial summary over 3-week trial period.

3. Wireless sensor network

A wireless sensor network (WSN) is a network formed by large number of spatially distributed autonomous devices known as nodes that use sensors to monitor physical or environmental conditions. These nodes are constrained by limited storage and power, similar to embedded systems. Numerous applications have been developed employing WSN technologies in many fields, including agricultural monitoring [7, 11] and animal behaviour studies [8, 13, 14]. **Figure 5** illustrates one of the commonly used WSN architecture in monitoring applications with sensor nodes, a sink node, a base station and a server. The sink node is the network coordinator to establish the network communication and send/receive nodes data within the WSN.

The radio frequencies used by communication modules in sensor networks are restricted by licensing. The selection of transmission frequencies is most influenced by their ability to transmit across undulating topography and/or through dense vegetation. As a general rule, the higher the frequency the more direct line of sight required [15]. The commonly used 2.4 GHz frequency has been adopted by most commercial network manufacturers since this and higher frequencies have a lower risk of data corruption when information is being transmitted.

3.1. WSN topologies

The development of WSNs has taken traditional network topologies in new directions. There are four basic WSN topologies for establishing a WSN as follows: peer-to-peer, star, tree and mesh. The data path between two nodes or a node and the gateway is referred to as a single-hop network. One of the most fundamental design choices is whether to use a single-hop or a multi-hop network. Multi-hop networks are useful in situations where measuring stations

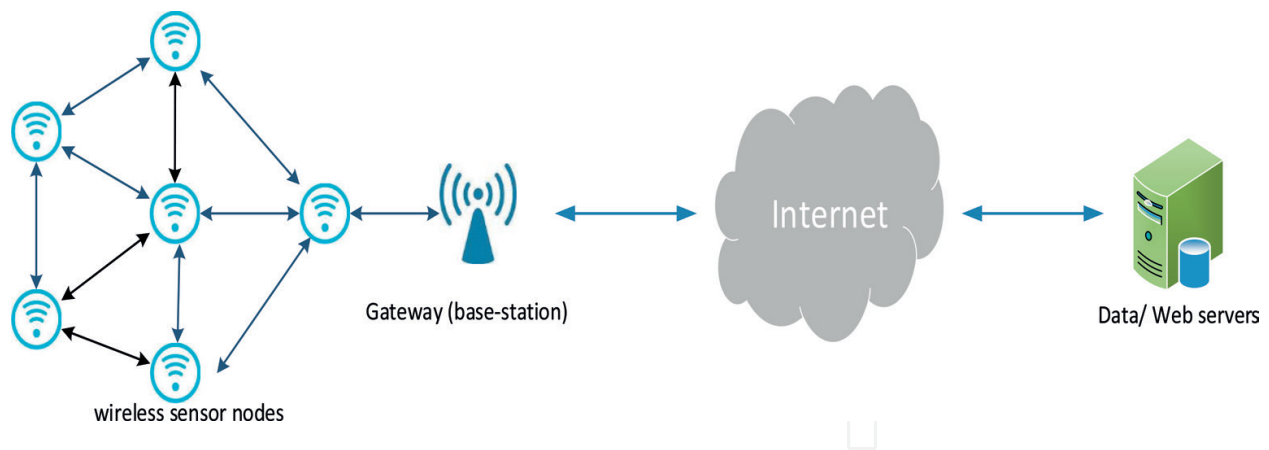

Figure 5. Schematic view of a wireless sensor network with mesh topology where data are collected through sensor nodes. All nodes communicate with each other and transmit data via a gateway or “base-station.” The gateway transfers data to the data server using internet or satellite.

are not centred around a base station. Such scenarios may occur when monitoring a mountain side, a ridge, a lakeside or any other area that is elongated [16].

Mesh networks is a more complex network configuration where a node may needs to communicate with number of other nodes to make successful transmission. In order to extend the range of a network or avoid an obstacle, a wireless relay node can be added between a gateway and a leaf node. The mesh network consists of three types of node, namely sensor node, relay node and gateway node.

The sensor node is a device used for integration with the physical system that has been designed to monitor and/or control. The relay node is usually called ‘routers’ and used to extend network coverage area and provide back-up routes in case of network congestion or device failure. A sensor node may transmit data to the gateway node through multi-hopping. This is particularly important in areas where physical terrain may interfere between nodes or nodes and gateway communication. A wireless sensor node comprises four basic modules, namely sensor/actuator module, communication module, processing/computation module and power module (**Figure 6**).

A gateway is an interface between the application platform and the nodes on the WSN [17]. In a mesh network, any of nodes can be a gateway node as long as it has an external communication capability. A secondary, tertiary or even another primary gateway can be placed in the same network.

3.2. SeNoMa-Cloud Framework

The WSN management system enables various levels of management such as configuration, communication, performance and fault detection. In large-scale WSN deployments, it is crucial for the management system to enable self-healing and maintainability. The Sensor Node Management Cloud (SeNoMa-Cloud) proposed in [18] is a framework that centralises WSN sensor node management. SeNoMa was designed to address issues outlined for a WSN application named GeoSense [19] and evolved to support various types of WSN applications. The architecture complies with the Open Geospatial Consortium (OGC) Sensor Web Enablement (SWE) standard for sensor

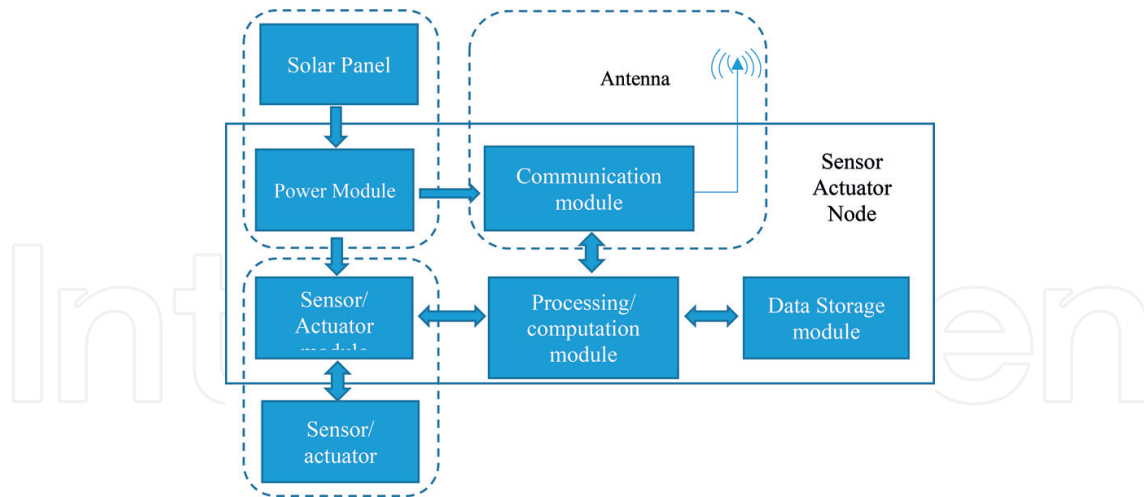

Figure 6. Basic components of a typical wireless sensor/actuator node.

data standardisation and supports communication protocols such as HTTP, MQTT and COAP. The three-layer SeNoMa-Cloud architecture is shown in Figure 7 and is briefly described below.

3.2.1. Mote layer

This layer encapsulates the WSN and supports various gateway types, protocols and communication channels. For instance, a PC base station may utilise MQTT via an Ethernet connection to a remote server or an embedded resource-constrained gateway may use HTTP through GPRS.

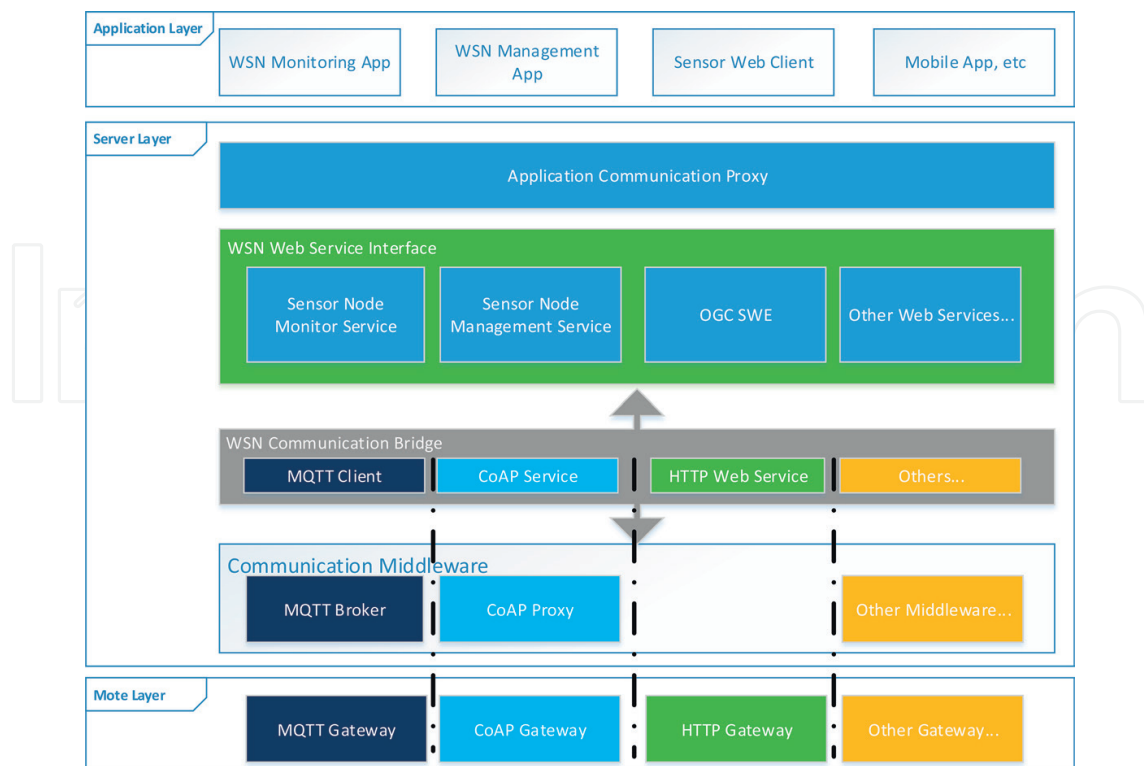

Figure 7. SeNoMa-Cloud Framework (adopted from [18]).

3.2.2. Server layer

This layer includes the services outlined below, including OGC SWE-compliant Web Services:

Sensor node monitor service: This service cooperates with the SWE to provide historical records of sensor data collected from data streamed live from a WSN communication bridge.

Sensor node management service: This service cooperates with the SWE to visualise the WSN sensor nodes and management interface, providing a mechanism to configure WSN node logging intervals.

WSN communication bridge: This accomplishes bidirectional communications between the WSN and Web services and is designed to support various communication protocols. It also handles encoding and decoding data communication from the WSN.

Communication middleware: This layer establishes communication with different types of WSN gateway, utilising different protocols and communication methods.

Application communication proxy: This relays requests utilising different protocols from an application layer to a corresponding service interface.

The server layer is provisioned for upgrades to include services such as notification or data modelling services.

3.2.3. Application layer

The application development depends on services provided by the server layer, such as the following applications:

WSN Monitoring App: This application is for monitoring and visualising sensor data from the sensor node monitor services. The monitoring application is designed based on client's requirements.

WSN Management App: This application allows network administrators to manage WSN functionalities via a web interface by communicating with sensor node management services.

Sensor Web Client: This application is for any third-party software that needs to access the SWE service to visualise data in geospatial maps.

4. Case study: WSN-enabled possum management

A small, light, easy to transport toxin delivery system has been developed to operate in the diverse range of environments that possums are found. Being small and light, many hundreds of devices can be deployed in problem regions. Each device delivers over 200 precisely measured doses of toxin to targeted animals and could remain in the environment for up to 2 years. Further successful field trials indicated the number of doses each device contained, far exceeded the number of animals in a given area. To overcome the requirement to dispense unused toxin till the next pest repopulation, a set and forget approach could remain the devices idle for months. Integrating a WSN into the device was seen as a cost-effective solution to monitoring and managing large number of devices.

With an ability to remotely monitor and gather data from WSN-enabled devices, conservation managers are able to employ more strategic approaches to animal identification,

monitoring and trapping. Gathering device-specific data on the number of individual toxin deliveries, the remaining gas level for toxin shots and a time-stamp of triggering events enabled mapping of population densities and animal movements over time. In turn, this enables devices to be moved, removed or redeployed as required to more effectively manage possum. Although the opportunities to introduce additional sensors, for example environmental or atmospheric data gathering, the primary goal of this project was to enable close monitoring of the activity of each possum-specific toxin delivery device (actuator).

The case study presented herein is based on earlier work by Ghobakhlou et al. in [5] using Sensor Node Management Cloud (SeNoMa-Cloud) architecture for data monitoring and wireless sensor nodes management.

4.1. Prototype WSN system architecture

Wireless sensor actuator network (WSAN) is a WSN with an additional component, namely an actuator. This increases the capability of the WSN from simply monitoring to interactive control. A mesh network topology was used to develop a monitoring system for a possum-specific toxin delivery device (acting as an actuator). This network configuration enabled distribution of a number of devices over a large area, attaching sensor nodes to actuators and establishing internet communication via a GPRS-enabled master node. **Figure 8** illustrates mesh WSN configuration used for this deployment.

4.2. Field implementation

The prototype WSN was implemented and tested to carry data in a multi-hop network. The actuator module on the sensor nodes operated independently of the communication module. The events were logged and passed onto the storage module.



Figure 8. WSN mesh network architecture.

In this application, the WSN was intended to transmit log events to the master node 2 hourly and then returns back into sleep mode to preserve battery power. Nodes were set to transmit and receive logged data at 2-hourly intervals consuming relatively low power with included photovoltaic panels for continuous recharging. The proposed solution employed Waspnote [20] with ZigBee protocol, which uses the 802.15.4 standard and operates on the 2.4 GHz frequency, which falls under a licence-free frequency band in New Zealand.

The sensor/actuator module communicates with the sensor device, activates/deactivates the actuator and transmits data through communication device (e.g. ZigBee) to the master (sink) node. Sensor data from all nodes gathered in the master node and transmitted to a remote server via GPRS network according to predefined intervals. In this case study, the hardware specifications are illustrated in **Table 2**.

The acquired sensor data are processed by a microprocessor-based radio frequency (RF) device. The data, now in digital form, are packetized and dispatched to the central repository. **Figure 9** illustrates a proposed actuator/node prototype.

A trial series of 14 sensor nodes with WSN-enabled possum-specific toxin delivery devices was deployed and field-tested. The web interface (**Figure 10**) shows the results of these trials. Devices were monitored over a 6-week period. Two-hourly transmissions recorded the status for each node within the network. It shows data demonstrating time and frequency of toxin delivery events, toxin shots remaining and high battery power levels for all nodes despite having overcast weather for

Sensor node	Master node
8 MHz processing power	16 MHz processing power
2GB SD card	2GB SD card
1.8 W solar panel	1.8 W solar panel
XBee ZB Pro S2	XBee ZB Pro S2
6600 mAh battery	6600 mAh battery
	GPRS SIM928A

Table 2. Hardware node specifications.

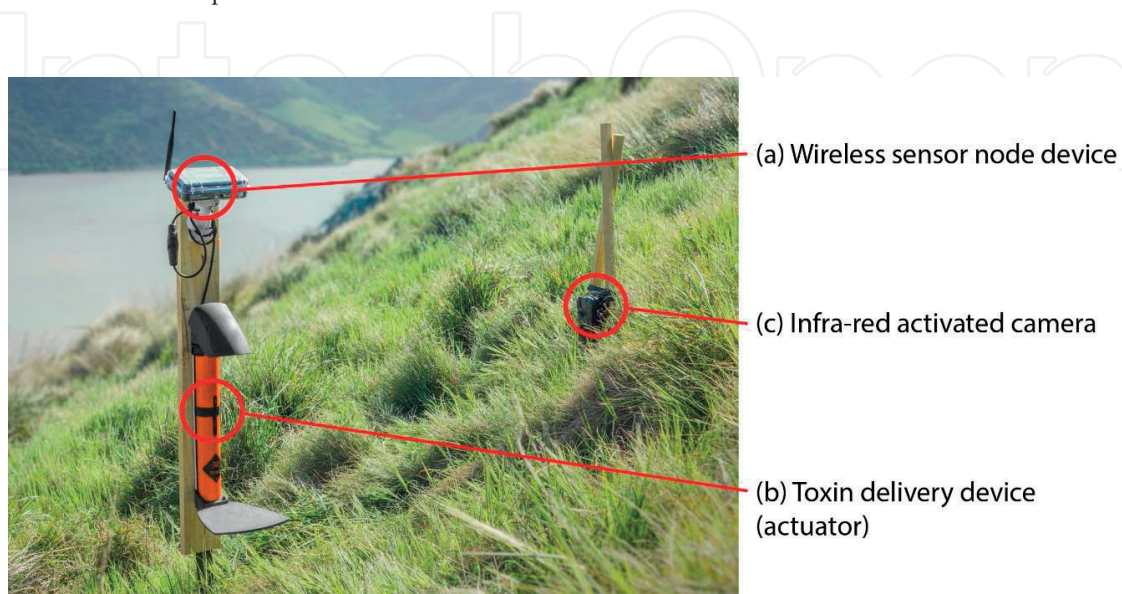

Figure 9. (a) Wireless sensor node device (b) An actuator/Toxin delivery device (c) Infra-red activated camera.

the given period, demonstrating consistent packet delivery. This observation was based on power-saving mode where nodes went to sleep mode while waiting for the next transmission interval.

A web-enabled sensor node management's control panel was developed to allow remote configuration for each node. This application allows two-way communication between the server and WSN for multiple stations (see **Figure 11**).

Possum Control Project

Name	Last Record	Battery Power	Toxin Level	Gas Level	Total Fired	Last Fired Date
GATEWAY	9 th Nov 2015, 15:00	91 %	N/A	N/A	N/A	N/A
REPEATER	26 th Oct 2015, 03:00	93 %	N/A	N/A	N/A	N/A
NODE 1	22 nd Oct 2015, 03:00	97 %	48	118	3	9 th Oct 2015, 11:36
NODE 2	28 th Oct 2015, 17:00	100 %	48	119	13	11 th Oct 2015, 04:56
NODE 3	23 rd Oct 2015, 07:00	98 %	49	119	7	11 th Oct 2015, 02:38
NODE 4	25 th Oct 2015, 23:00	98 %	46	116	3	12 th Oct 2015, 21:56
NODE 5	22 nd Oct 2015, 01:00	98 %	68	138	0	Not Available
NODE 6	22 nd Oct 2015, 01:00	96 %	58	128	6	12 th Oct 2015, 02:41
NODE 7	27 th Oct 2015, 15:00	97 %	63	133	3	25 th Oct 2015, 02:41
NODE 8	22 nd Oct 2015, 01:00	98 %	61	131	0	Not Available
NODE 9	25 th Oct 2015, 13:00	98 %	63	133	1	20 th Oct 2015, 04:07
NODE 10	27 th Oct 2015, 21:00	98 %	63	133	1	11 th Oct 2015, 21:51
NODE 11	22 nd Oct 2015, 01:00	94 %	62	132	0	Not Available
NODE 12	24 th Oct 2015, 13:00	96 %	55	125	4	26 th Aug 2015, 21:52

Figure 10. WSN's monitoring interface for possum control project.

The screenshot shows a web interface for sensor node management. At the top, there are two tabs: 'Table View' (selected) and 'Map View'. Below the tabs is a search bar with the placeholder text 'Search by station name, node name, logging interval, battery level, last date receive'. The main content area displays a table for 'Station One'. The table has the following columns: '#', 'Node Name', 'Operation Mode', 'transmission Interval', 'Logging Interval', 'Battery', and 'Last Data Received'. The data rows are:

#	Node Name	Operation Mode	transmission Interval	Logging Interval	Battery	Last Data Received
1	Gateway	Active	5 minutes	5 minutes	78%	24/05/2017 15:05
2	N1	Active	5 minutes	5 minutes	85%	24/05/2017 15:05
3	N2	Active	5 minutes	5 minutes	80%	24/05/2017 15:05
3	N3	Active	5 minutes	5 minutes	90%	24/05/2017 15:05

Below the table, there are expandable sections for 'Station Two', 'Station Three', and 'Station Four'. At the bottom right, there is a 'Submit' button. At the bottom left, there is a legend with the following items: Changed (Not Submitted), Sent To Server, Server Received Updates, Pushed To WSN, WSN Update Confirmed, WSN Failure, and Database Failure.

Figure 11. Sensor node management's control panel.

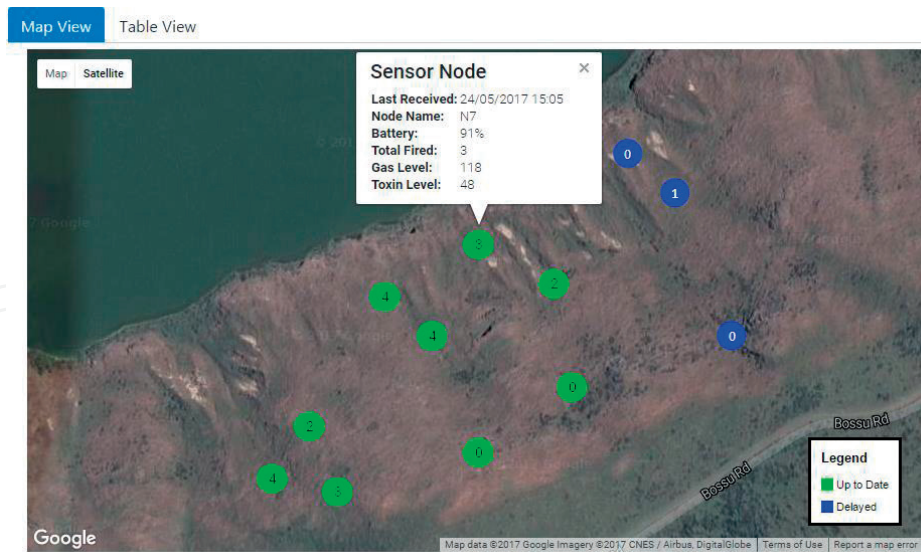

Figure 12. Map view of monitoring application interface.

The map view in **Figure 12** shows the spatial distribution of nodes along with number of times each node was triggered. A mouse over option displays a summary of statistics of the latest data such as node's remaining battery power, toxin and gas levels.

5. Conclusions

This chapter described opportunities for WSN in conservation management applications and presented WSN architecture for remotely monitoring pest control devices. The broad range of benefits for wireless sensor networks make them ideally suited to environmental monitoring and pest control. These include the ability to cost-effectively gather large volumes of long-term data and minimise labour hours in the field. In addition, an ability for nodes to save power by going into sleep mode when there is no activity and supplementing battery power by harvesting ambient solar energy gives them a long field life.

A WSN system monitoring a series of toxin delivery devices in a recent trial proved very successful and underlined the increased efficiency a reliable remote monitoring system could deliver. Conservation managers concluded that measures to decrease the necessity of manually checking devices in the field was a significant advantage and that the ability to remotely access the data reduced the labour and cost implications of the toxin delivery device trial. Further, an ability to turn off devices during periods of inactivity added a level of safety as well as increasing battery life. The sensor network enabled devices to be deployed, monitored and interactively managed, providing a significantly enhanced tool for the strategic management of pest species going forward.

Additional sensors in wireless sensor networks could also be used for monitoring other operational parameters at minimal extra cost. In addition to the primary device, data from a variety of sensors such as infrared to detect animal presence or humidity and

barometric sensors for environmental monitoring could be added to the telemetry. The WSN could potentially decrease the operational costs of terrestrial monitoring and wildlife trapping programs significantly, particularly those involving labour-intensive manual checking.

Author details

Akbar Ghobakhlou* and Shane Inder

*Address all correspondence to: akbar.ghobakhlou@aut.ac.nz

Auckland University of Technology, Auckland, New Zealand

References

- [1] Dowding JE, Murphy EC. The impact of predation by introduced mammals on endemic shorebirds in New Zealand: A conservation perspective. *Biological Conservation*. 2001;99(1):47-64
- [2] Livingstone PG, Hancox N, Nugent G, de Lisle GW. Toward eradication: The effect of *Mycobacterium bovis* infection in wildlife on the evolution and future direction of bovine tuberculosis management in New Zealand. *New Zealand Veterinary Journal* 2015;63(supp 1):4-18
- [3] Hutchings SA, Hancox N, Livingstone PG. A strategic approach to eradication of bovine TB from wildlife in New Zealand. *Transboundary and Emerging Diseases*. 2013;60(s1):85-91.
- [4] Root-Bernstein M, Ladle RJ. Conservation by design. *Conservation Biology* 2010;24:1205-1211. DOI: 10.1111/j.1523-1739.2010.01501.x
- [5] Ghobakhlou AX, Wang P, Sallis S, Inder and Blok S. Using WSN for possum management. In *Sensing Technology (ICST), 2015 9th International Conference on*, pp. 689-693. IEEE, Auckland, New Zealand, December 2015
- [6] Jones C, Warburton B, Carver J, Carver D. Potential applications of wireless sensor networks for wildlife trapping and monitoring programs. *Wildlife Society Bulletin* 2015;39:341-348. DOI: 10.1002/wsb.543
- [7] Gillies CA, Williams D. DOC Tracking Tunnel Guide v2.5.2: Using Tracking Tunnels to Monitor Rodents and Mustelids. Hamilton, New Zealand: Department of Conservation, Science & Capability Group; 2013
- [8] Green W, Rohan M. Opposition to aerial 1080 poisoning for control of invasive mammals in New Zealand: Risk perceptions and agency responses. *Journal of the Royal Society of New Zealand*. 2012;42(3). DOI: 10.1080/03036758.2011.556130

- [9] Department of Conservation. Battle for our Birds: Predator Control Programme [Internet]. 2014. Available from: <http://www.doc.govt.nz/battleforourbirds> [Accessed: May 2017]
- [10] Department of Conservation. Department of Conservation Four Year Plan; Budget. July 2016. Available from: <http://www.doc.govt.nz/Documents/about-doc/four-year-plan/doc-four-year-plan-2016.pdf>
- [11] Palma ART, Gurgel-Gonçalves R. Morphometric identification of small mammal footprints from ink tracking tunnels in the Brazilian Cerrado. *Revista Brasileira de Zoologia*. 2007;24(2):333-343
- [12] Blackie H. www.landcareresearch.co.nz [Internet]. 2013. Available from: https://www.landcareresearch.co.nz/__data/assets/pdf_file/0004/66487/Blackie_Novel_automated_pest_detection.pdf [Accessed: 2017]
- [13] Blackie H, MacKay J, Allen W, Smith D, Barrett B, Whyte B, Murphy E, Ross J, Shapiro L, Ogilvie S, Sam S, MacMorran D, Inder S, Eason CT. Innovative developments for long-term mammalian pest control. *Pest Management Science*. 2014;70(3):345-351
- [14] Paek J, Hicks J, Coe S, Govindan R. Image-based environmental monitoring sensor application using an embedded wireless sensor network. *Sensors*. 2014;14(9):15981-16002
- [15] Chen H-Y, Kuo Y-Y. Calculation of radio loss in forest environments by an empirical formula. *Microwave and Optical Technology Letters* 2001;31,no. 6: 474-480
- [16] Ruhnau Pollak A. Challenges and Considerations for a Delay-Tolerant Wireless Sensor Network Deployment. 2010
- [17] Cecílio, José, and Pedro Furtado. *Wireless Sensors in Heterogeneous Networked Systems: Configuration and Operation Middleware*. Springer, 2014
- [18] Ghobakhlou, Akbar, Alexander Kmoch, and Philip Sallis. Integration of wireless sensor network and web services. In *Proceedings of the 20th International Congress on Modelling and Simulation, Adelaide, Australia*, vol. 16. 2013 (pp.838-844)
- [19] Ghobakhlou A, Sallis P, Wang X. A service oriented wireless sensor node management system. In: *Instrumentation and Measurement Technology Conference (I2MTC) Proceedings, 2014 IEEE International*. Montevideo, Uruguay; May 2014. pp. 1475-1479
- [20] Libelium, Waspote Datasheet. www.libelium.com [Accessed: May 2017]