

We are IntechOpen, the world's leading publisher of Open Access books Built by scientists, for scientists

4,800

Open access books available

122,000

International authors and editors

135M

Downloads

Our authors are among the

154

Countries delivered to

TOP 1%

most cited scientists

12.2%

Contributors from top 500 universities



WEB OF SCIENCE™

Selection of our books indexed in the Book Citation Index
in Web of Science™ Core Collection (BKCI)

Interested in publishing with us?
Contact book.department@intechopen.com

Numbers displayed above are based on latest data collected.
For more information visit www.intechopen.com



Home Composting Using Facultative Reactor

Sandro Xavier de Campos, Rosimara Zittel,
Karine Marcondes da Cunha and
Luciléia Granhern Tavares Colares

Additional information is available at the end of the chapter

<http://dx.doi.org/10.5772/intechopen.69429>

Abstract

Concerns with the final destination of organic solid waste (OSW) generated in rural areas originate from the possibility of this waste harming the environment, in addition to producing bad smell and attracting pests, when improperly disposed of in the soil. In this sense, composting might be a suitable way of dealing with this residue. This chapter presents the advantage of treating rural OSW through composting in reactors. Facultative reactors present the advantage of not requiring handling or large areas for the waste processing, and they do not generate bad smell and do not attract pests, which represent common drawbacks of the conventional windrow composting process. The final product of this composting process can be used as fertilizer for crops, resulting in the economy, since commercial fertilizers do not have to be bought. Works carried out by the Analytical and Environmental Chemistry Research Group at the State University of Ponta Grossa—Brazil have reported important results regarding the use of facultative reactors with different OSW mixtures. From the monitoring of physical, chemical, biological and spectroscopic parameters, it was seen that composting in facultative reactors produced stable compost matured in a short period of time.

Keywords: facultative reactor, OSW, monitoring, characterization, spectroscopic, physico-chemical

1. Introduction

The final destination of solid residues originated in agriculture as well as other activities has been a pressing concern in the contemporary society, due to its negative impact on the environment. In the whole world, 1.3 billion tons of solid waste are generated every year according to the Organization for Economic Cooperation and Development (OECD). It is estimated

that 50% of this waste is produced by the 34 richest countries. Brazil, despite being considered an underdeveloped country, occupies the third position among the countries that generate the most waste in the world (220 million tons/year, 1.2 kg/inhabitant/day) [1].

The Brazilian agroindustry is the largest productive sector in the country. According to data by the United Nations (UN), Brazil will be the greatest food exporter between 2015 and 2024. Such a great food production places Brazil among the largest waste producers also in the rural area [1].

According to the Applied Research Institute (IPEA/Brazil) [2], about 291 million tons of waste are generated by the agroindustry every year. From this, 51% is organic material coming from solid waste from sugar cane, rice, soybean, corn, beans, wheat, coffee and cocoa crops, along with the growth of fruits, such as orange, banana, coconut and grapes. This organic solid waste (OSW) is usually buried, burnt or simply disposed on the soil far from households (but many times close to rivers), generating negative environmental impact [3, 4]. However, if properly separated and treated, this waste can contribute to the reduction of environmental problems originated from its improper disposal. The use of composting methods that can transform this OSW into stable and mature organic matter in the shortest period possible is the most suitable way of managing such residue.

This chapter presents the possibility of treating OSW through composting in facultative reactors.

2. OSW treatment in reactors

In the rural area, OSW from different sources, both vegetable and animal origin, is generated inside and outside the farms. Proper management of this residue might result in benefits related to the prevention of river and soil pollution; reduction in chemical fertilizer use and crop diseases. Therefore, the collection and composting of this OSW might constitute proper technology, to be used by individuals or in association with other rural producers, aiming at the agriculture technical-scientific advancement [5]. Up to now, some emphasis has been given to home composting, which requires constant care such as moist content and material aeration control. In addition, studies have demonstrated that due to the requirement of constant handling, the composting process might present chemical and biological risks [5–7].

Taking these facts into consideration, the use of a reactor for the treatment process of OSW generated in rural areas might be suitable, since it represents a low-cost process which demands reduced workforce and small areas.

The composting in reactors is considered a promising technology when compared to conventional technologies of open systems such as windrows or piles, since it does not require revolving the composting mass and provides sufficient aeration to the mixture (with or without mechanical injection of air) to produce mature final compost. It does not produce the bad smell, leachate or pollutants. Also, it provides the control of physical and chemical parameters such as temperature and moist and can be used in different climatic seasons [8–10].

Recent studies employing reactors for OSW treatment have proved the efficiency of this technology when compared to the anaerobic digestion or incineration, for resulting in compostable to improve the physical and chemical conditions of the soil, preventing the emission of greenhouse effect gases (CO_2 , NO , CH_4) [11]. In recent years, models of vertical and or horizontal reactors have been developed and adapted to OSW treatment [12, 13], and also several works have demonstrated composting processes in pilot-scale reactor systems, with rotating the drum and forced aeration [14–16].

Scale reactors between 10 and 300 liters involve different configurations that guarantee a process with favorable results, allowing the study of parameters such as temperature, moist, biological activity and oxygen content [17–19].

Taking that into consideration, some studies have emphasized that in order to retain heat and keep ideal temperatures, the reactor walls should be covered with thermal insulating material [14, 15, 20–22]. Several studies used OSW coming from vegetable, fruit, olive bagasse, grape bagasse and olive bagasse, waste which is widely found in rural areas. Due to the high moist of these substrates, in some experimental processes, output holes were adapted to drain the material and collect slurry [14, 22–24].

A study carried out by Fernández et al. [14], verified the influence of the granulometry in temperature and moist variation in a reactor system for the treatment of sewage sludge coming from an effluent treatment station (ETS), combined with carbonaceous materials with different particle sizes. The authors concluded that the best results were obtained from the ETS sludge and wood chips (5–15 mm). The use of wood chips as volume agents provides the mixture with better aeration and moist levels below 65%, in addition to favoring the achievement of temperatures close to 70°C , ensuring the elimination of pathogens.

Paradelo et al. [22] investigated the efficacy of different volume agents and studied the mixtures of food waste (raw and cooked vegetables and fruit) with the addition of different OSW produced in rural areas such as hay, wheat straw and wood chips. The composts were placed in a vertical cylindrical barrel of 30-liter volume for 2 months. The barrel was placed on wood blocks to favor aeration and elimination of the leachate produced. The authors concluded that the wood chip experiment produced a less decomposed material, due to the larger particle size (25 mm); however, it also presented parameters favorable to stabilization.

In another study by Li et al. [21], a reactor was built with plastic containers of different sizes, a 10 L container, punctured and with external output, encased in a 15 L container. The space between the reactors was 5 mm each side (filled with foam) and 20 mm in the lower part. At the bottom of the bucket, gravel was placed and that surface was covered with a plastic screen. The composting used grape bagasse and sawdust. The treatment was carried out with the lid of the system closed. The authors concluded that the cellulose degradation occurred within the three initial months; however, the variation of the C/N ratio from 30/1 (initial) to 28/1 (final) was low, and the temperature did not reach the thermophilic phase.

Composting in rotating drums with an aeration system and 250 L capacity has been widely studied [23]. Different mixtures of OSW produced in rural areas were used such as grass,

vegetable residue, bovine manure and sawdust. The authors concluded that the mixture of bovine manure, vegetable residue and sawdust resulted in a stabilized compound and agitation guaranteed aeration and uniformity to the mixture, preventing the generation of bad smell.

Iyengar and Bhawe [25] investigated composting in different kinds of reactors (aerobic, anaerobic and facultative) in laboratory scale, using OSW from rural areas such as bovine manure and straw. The facultative reactor presented anaerobic lower regions and aerobic upper regions, due to the distribution of the layers inside the reactor. The authors concluded that the aerobic and facultative reactor systems produced a more stable compost.

For the OSW composting process in reactors to be considered efficient, it is necessary to monitor the different physical and chemical parameters, and the compost obtained can be defined as the stabilized and matured product.

The compost stability and maturity show the organic matter decomposition degree, and after mature, it can be used as a soil fertilizer, releasing nutrients necessary to plant growth [9]. Stability and maturity can be monitored by observing the physicochemical properties (temperature, moisture, pH, ash content and ratio C/N) along with spectroscopic (UV/Vis and IR) and biological (germination index) parameters [26–29].

In recent years, the Analytical Environmental and Sanitary Chemistry Research Group (QAAS, Brazilian abbreviation) of the State University of Ponta Grossa—Brazil has studied the treatment of different OSW in a facultative reactor system [9, 30, 31]. Thus, this work presents an extensive study of the OSW treatment in the facultative reactor, with great results obtained through conventional (moisture, pH, temperature and C/N ratio), spectroscopic techniques (UV/Vis and Infrared-IR) and germination index.

2.1. Facultative reactor

The facultative reactor (**Figure 1**) was constructed from a copper and zinc cylindrical metal container with a capacity of 200 L (diameter 600 mm and height 700 mm). On the reactor was designed a plastic cover of 300 mm of diameter × 60 mm of height that contains 120 holes of 5 mm to allow a gas exchange. At the bottom of the reactor was coupled a liquid collection system [9].

2.2. Composting using facultative reactor

The experiments were carried out at the State University of Ponta Grossa, where five reactors were assembled, and the composting process was studied for 180 days. The reactors were installed under shelter (shed) protected from the rain. For the experiment, the following OSW was used: home organic waste (HOW), wood waste such as sawdust (WWS) and chips (WWC) and smuggled cigarette tobacco (SCT) seized by the Brazilian Federal Revenue and donated to the study. The combination of OSW used to assemble the five reactors is in **Table 1**. The mixture was distributed in 200 mm layers in the reactors. **Table 2** presents the physical and chemical characteristics of the OSW used in the experiment.

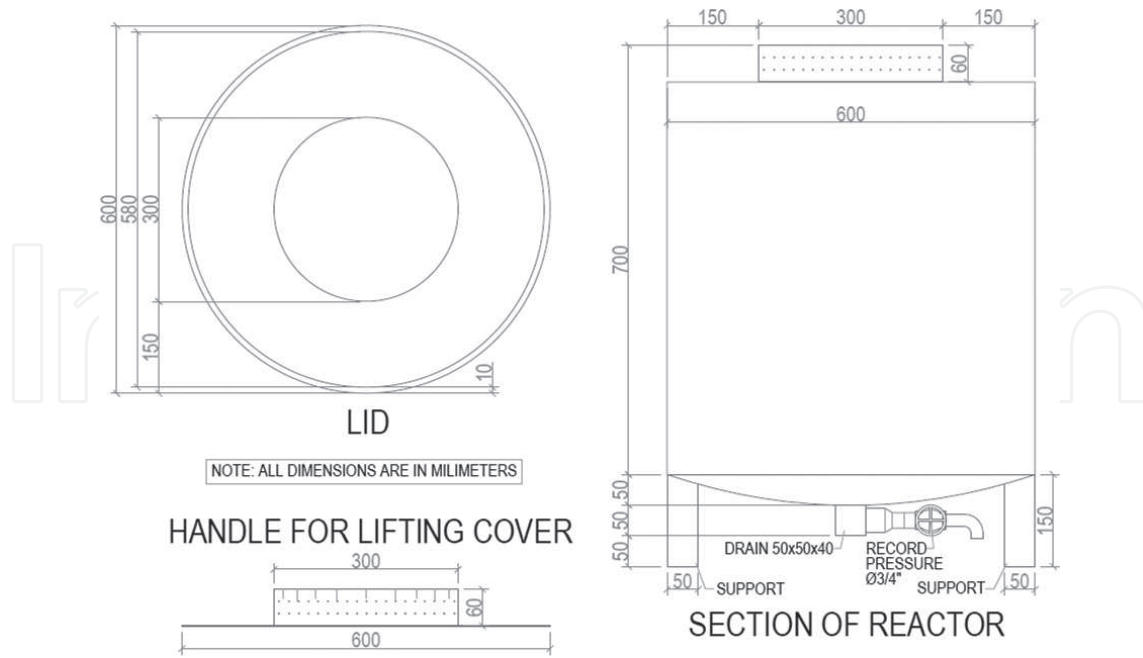

Figure 1. Schematic design of the facultative reactor.

	DOW		SCT		WC		S		Total
	(%)	(kg)	(%)	(kg)	(%)	(kg)	(%)	(kg)	(kg)
R 1	70	157.2	10	2.62	20	8.7	–	–	168.2
R 2	60	116.4	20	4.84	20	8.0	–	–	129.3
R 3	40	86.3	40	10.1	20	8.3	–	–	104.8
R 4	70	105.6	10	1.69	–	–	20	2.9	110.2
R 5	40	57.6	40	6.7	–	20	2.8	67.1	

Source: Zittel [31].

Table 1. Combination of the substrates, in proportion and mass, for the accomplishment of the experiment.

Parameters	DOW	SCT	WRS	RL
pH	5.5	7.2	6.4	6.0
C (%)	36.15	36.85	44.1	44.1
N (%)	3.04	3.20	0.28	0.28
Initial C/N ratio	11.89	11.15	157.5	157.5
Granulometry (mm)	20–50	> 1	> 1	20–40
Moisture content (%)	65	15,3	12	13

Source: Zittel [31].

DOW—domestic organic wastes; SCT—smuggled cigarette tobacco; WRS—wood residues sawdust; RL—Wood Residues Chip.

Table 2. Initial physical and chemical characteristics of the solid residues used in the experiment.

2.2.1. Home organic waste (HOW)

The average of six samplings was carried out to characterize the HOW, and a quartering process was performed three times a week according to the Technical Norms Brazilian Association—ABNT-NBR 10007/2004 [32]. Initially, the homogenized sample was divided into four parts, and two opposite quarters were selected, which were homogenized again. The quartering procedure was carried out again with the samples collected, selecting one of the remaining quarters to represent the waste characterization (Figure 2).

2.2.2. Wood waste-sawdust (WWS) and chips (WWC)

The WWS used in the experiment had a diameter smaller than 1 mm, and the WWC diameter was between 20 mm and 40 mm, as shown in Figure 3.

2.2.3. Smuggled cigarette tobacco (SCT)

The SCT used in the experiment was provided by the Brazilian Federal Revenue (Ponta Grossa—Pr unit) after having sized the material. Different batches of this material were used to assemble the reactors. The cigarette filter was separated from the tobacco portion and ground in a commercial grinder shown in Figure 4.

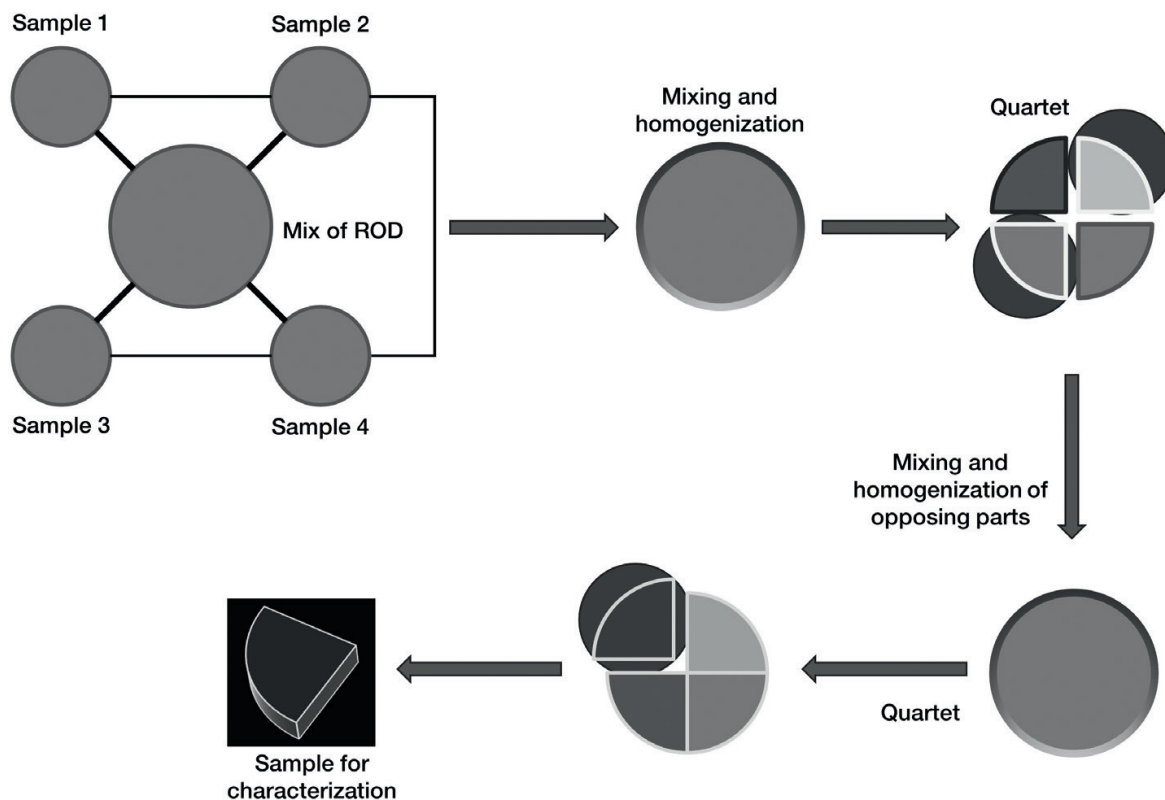

Figure 2. Quarantine process of the RODs used in the experiment.

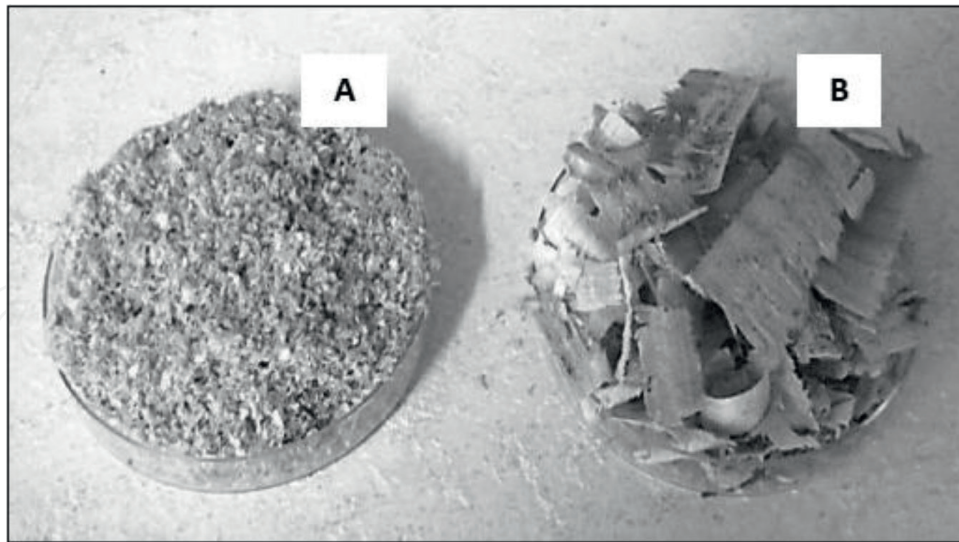

Figure 3. Wood waste used in the experiment. (A) Sawdust wood residue (RMS) and (B) residual wood chippings (RML).



Figure 4. Equipment used for grinding tobacco and paper wrapping.

After ground, the tobacco was separated from the wrapping paper around it using a 6 mm × 6 mm mesh sieve, resulting in a powder with particle smaller than 1 mm. The process to separate the tobacco from the cigarette filter and wrapping paper can be seen in **Figure 5**.

2.3. Sampling

To monitor the composting process, samples were collected every fortnight, from random points inside the reactors. The sample collection was carried out on the 1st day and in periods of 15, 30, 45, 60, 75, 90, 105, 120, 135, 150, 165, 180 days. In each collection, about 100 g of sample was removed from each reactor. These samples were homogenized, and the portions needed for the analyses were separated. To monitor de composting process and characterization of the final compost, the analyses carried out were: elemental (C/N), temperature, moist, pH, seed germination index (SGI) and spectroscopic (UV/VIS and Infrared).

2.4. Physicochemical analyses

2.4.1. Temperature

The temperature was measured three times a week using a portable digital thermometer. The monitoring was carried out on the first day of the organic material deposition inside the reactor and throughout the process, at three different points: surface, middle and bottom.

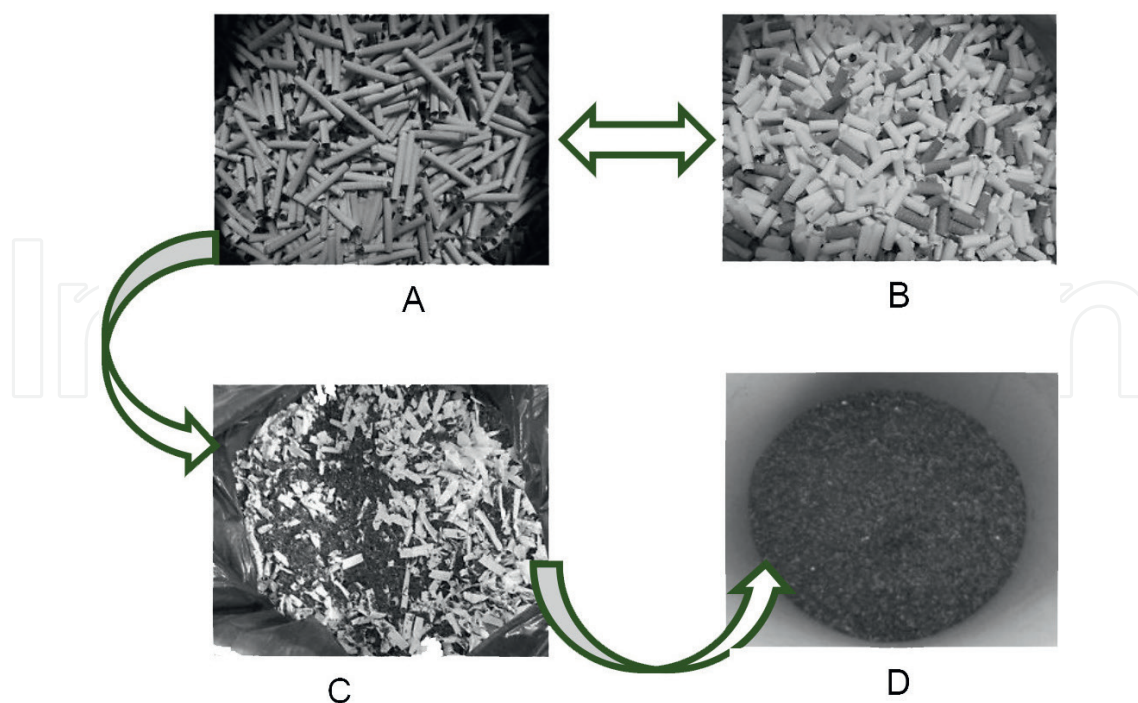

Figure 5. Separation steps of the filter and the paper wrapper of the cigarette used in the experiment. (A) Cigarette with filter; (B) filter separation; (C) shredded tobacco and paper wrapping; and (D) cigarette tobacco residue after sieving.

2.4.2. Moist

To control moist content, readings of the mixture in the reactors were performed every fortnight, at the surface and bottom of the reactor, using the combined digital thermometer and hygrometer device.

2.4.3. pH

For the pH determination, the sample was diluted in a calcium chloride solution, following the official method by the Brazilian Agriculture, Livestock and Supply Ministry [33]. The use of a calcium chloride solution allows the hydrogen ions to get free from the colloid surface, resulting in pH values which are moderately lower when compared to those found when the sample is diluted in water [34].

2.4.4. Elemental chemical analysis

The elemental chemical analysis was carried out using the Elemental Analyzer. The C/N ratio was obtained from the ratio between the percentage values of C and N in the sample.

2.4.5. Germination index (GI)

GI was performed by adapting the technique proposed by the Hong Kong Organic Resource Centre [35]. About 20 g of the fresh compost was added to 200 mL of distilled water and stirred for 2 h. Next, the solution was placed in the centrifuge at 9000 rpm for 25 min at 4°C. The GI was carried out in triplicate in the periods of 90, 120, 150 and 180 days. GI was performed by placing 5.0 mL compost extract on each petri dish. Next, 10 watercress seeds (*Lepidium sativum*) were evenly distributed on each dish and incubated for 72 h in dark room and temperature between 22 and 27°C. After 72 h, the number of germinated seeds was recorded, as well as the main root length, so that the GI calculation could be done [34] (Eqs. (1)–(3)). The percentage of germinated seeds of each sample as calculated from the triplicate weighted average. A control test was performed using 5.0 mL distilled water substituting the compost extract.

Relative seed germination percentage

$$\text{RSG}(\%) = \frac{\text{Weighted average of the no of germinated seeds in each extract} \times 100}{\text{Weighted average of the no of germinated - seeds in the control}} \quad (1)$$

Relative root growth

$$\text{RRG}(\%) = \frac{\text{Weighted average of root length in each extract} \times 100}{\text{Weighted average of root length in the blank}} \quad (2)$$

Germination index (GI)

$$\text{GI} = \frac{\text{RSG} \times \text{RRG}}{100} \quad (3)$$

2.5. Spectroscopic analysis

2.5.1. Visible ultraviolet region (UV-Vis) molecular spectroscopy

For the absorption analyses in the UV-Vis, 10 mg of the sample was dissolved in 10 mL sodium bicarbonate solution (NaHCO_3) 0.05 mol. L⁻¹, at the E_2/E_3 (wavelength absorbance 280 nm and 365 nm) and E_4/E_6 (ratio between the absorbances 465 and 665 nm).

2.5.2. Infrared region Absorption Spectroscopy (IR)

For the IR analyses, pellets were prepared with 1.0 mg sample and 100 mg KBr. The spectra were obtained in the band from 400 cm^{-1} to 4000 cm^{-1} [36].

3. Results

3.1. Physicochemical parameters

Figure 6 presents the results of physical and chemical analyses of the OSW mixtures used in the composting with the facultative reactor.

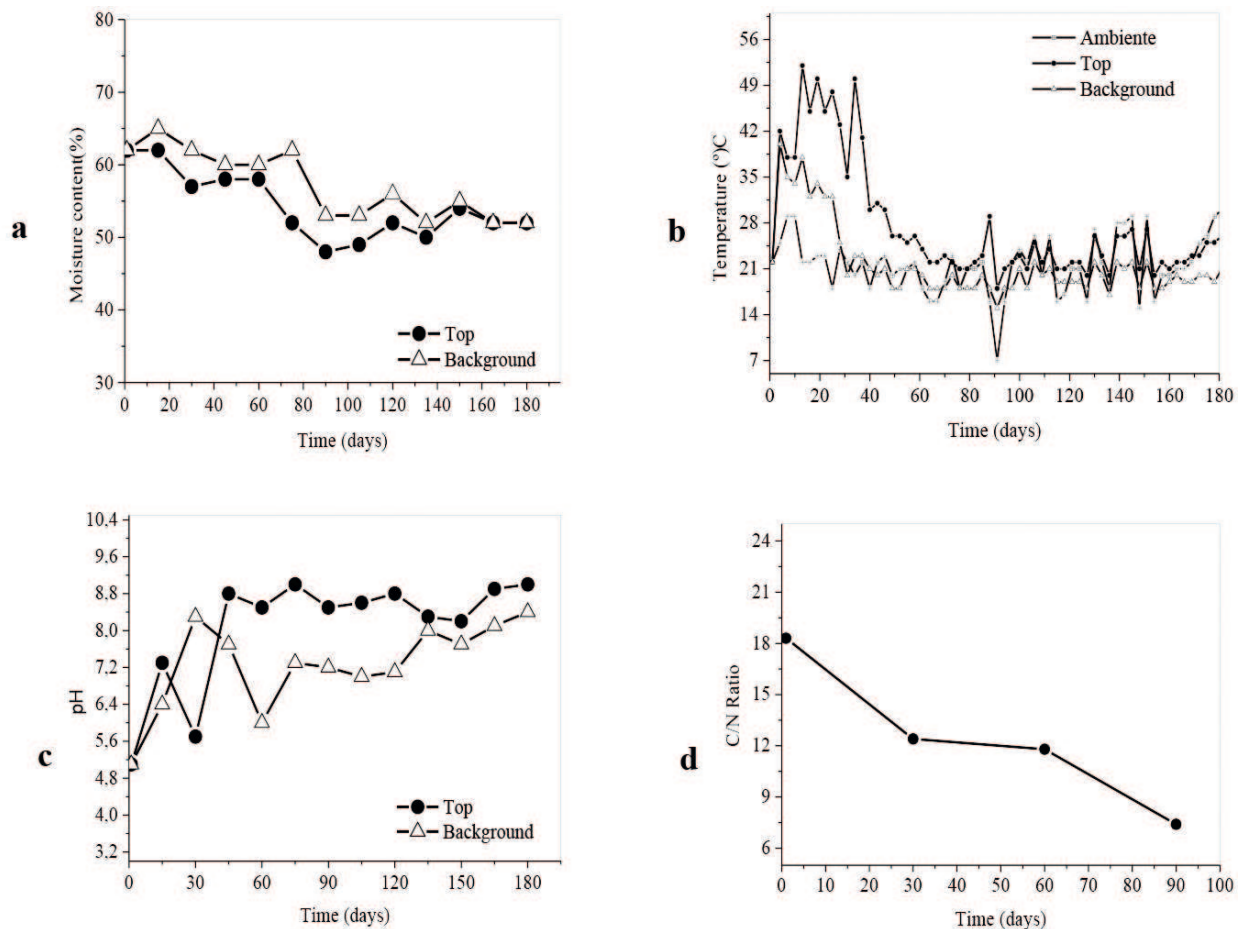

Figure 6. Control of moisture (a), temperature (b), pH (c) and C/N ratio (d) during the composting process of food residues (40%), cigarette tobacco (40%) and sawdust (20%) in the optional reactor system.

The moist (**Figure 6a**) in both layers (top and bottom) was seen to be kept between 40 and 70% throughout the process, and from the 130th day on, there was no variation of this value at the top or at the bottom of the mass, indicating the compost stability. Regarding pH (**Figure 6b**), a reduction was seen in the first 15 days in the two layers of the mixture, while, after the 80-day period, the values were in the alkaline band. From the 130th day on, the values were seen to vary from 7.5 to 9, indicating the final compost stability. The variation in pH values is due to the existence of different groups of microorganisms which are characteristic of the aerobic (bacteria, yeast, and fungi) and anaerobic (bacteria) activities. **Figure 6c** shows that the thermophilic temperature remained for a period of 40 days, which was efficient to eliminate pathogens. From the 100th day on, temperatures close to the ambient were observed, confirming the compost stability.

The C/N ratio is a parameter that evaluates the compost maturity. According to the results presented in **Figure 6d**, the ratio was seen to decrease throughout the process, indicating that the initial materials, rich in nitrogen, were transformed into inorganic compounds such as nitrates (NO_3) and nitrites (NO_2).

3.2. Germination index (GI)

Recently, the phytotoxicity evaluation through the germination index (GI) has been used as one of the parameters to evaluate the compost maturity. The application of unstable and immature compost to the soil might result in competition for oxygen by the plant roots and the microbial mass. The continuous decomposition of immature materials might cause anaerobic conditions in the soil, resulting in the production of nitrite (NO_2) and sulfuric acid (H_2S) [37]. Immature composts might contain high levels of organic acids, high C/N ration, extreme pH values, high salinity content and high ammonium (NH_4) concentrations, which inhibit seed germination and root and plant growth [38].

When the GI increases along the process, one can assume that there is a reduction in phytotoxic substances and that the organic composts are reaching maturity, being enriched with nutrients and humic substances [39].

Figure 7 presents the GI evolution in OSW composting with the facultative reactor.

Results revealed that from the 90th day on the compost was free of toxicity and reached SGI values above 80%.

3.3. Visible ultraviolet region (UV-Vis) spectroscopic analyses

The formation of humic substances is a parameter used to evaluate the maturity of the final compost obtained in OSW composting with the facultative reactor. Therefore, the humification parameter among some ratios of absorbance is widely used. The main organic material absorption bands occur in the region from 200 to 400 nm. In composting studies, the compost UV/Vis analyses result in ratios between some absorbance. The E_2/E_3 ratios (ratio between the absorbance 280 and 365 nm) provide the relation between humified and non-humified groups [40], while the E_4/E_6 ratios (ratio between the absorbance 465 and 665 nm) are used to indicate the condensation degree and aromatic constituents during composting and may be seen as humification index or compost maturity [40]. These ratios usually reduce with the increase in simple and double chemical bond conjugations characterizing the formation of humic substances through the condensation of aromatic rings of greater molecular weight [41, 42]. The

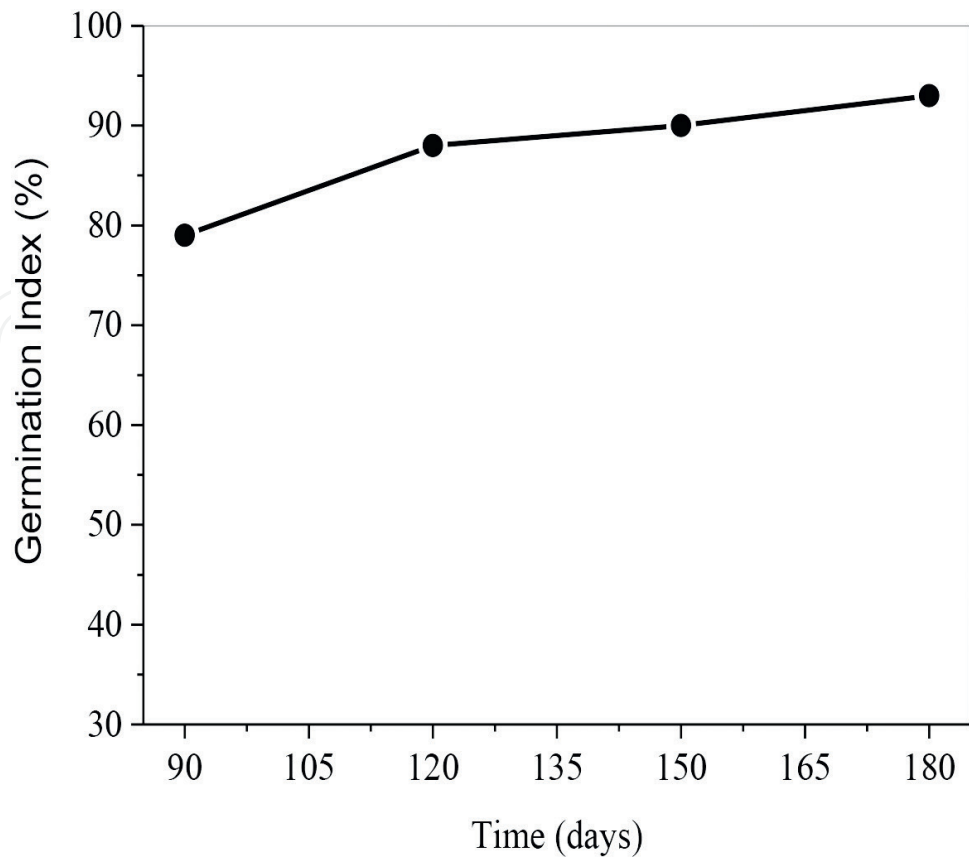

Figure 7. Seed germination index during composting process of food residues (40%), cigarette tobacco (40%) and brush (20%).

relations E_2/E_3 and E_4/E_6 with values lower than 5.0 indicate that there was the formation of mature compost due to the increase in the aromatic groups [43].

Figure 8 presents the E_2/E_3 and E_4/E_6 ratio curve during the OSW composting process with the facultative reactor.

The E_2/E_3 and E_4/E_6 ratios were seen to decrease during the process reaching values below 5. These results indicated that the composting in reactors produced matured final compost probably due to the high degree of humic acids present in the humic substance structure.

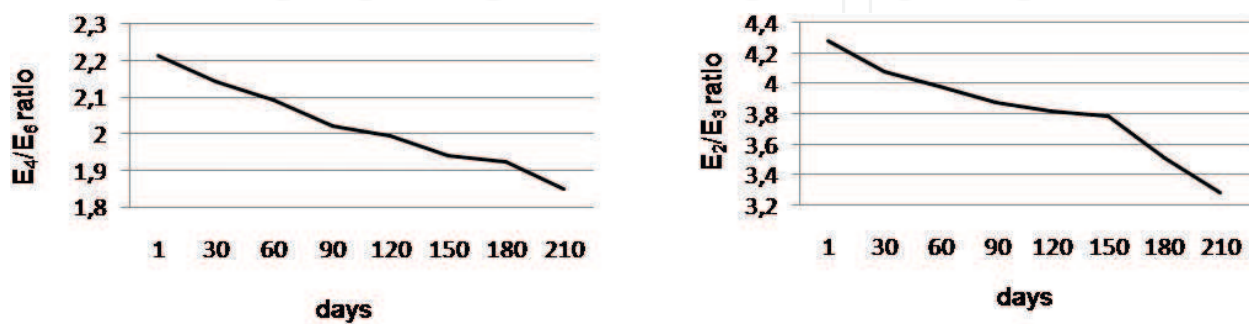

Figure 8. Curve of E_2/E_3 ratio (absorbance between 250 and 365 nm) and E_4/E_6 absorbance between 465 and 665 nm during the process of composting food residues and sawdust.

3.4. Fourier transform infrared spectroscopy (FT-IR)

The infrared spectroscopy (IR) has been used to evaluate the transformation of organic matter at the different stages of the composting process [44]. The increase and reduction in peaks reveal the decomposition of immature residue and the formation of new compounds [45].

The main absorption peaks of the IR spectrum and their respective attributions are seen in **Table 3** [44, 46].

The IR spectrum of the OSW composting process with the facultative reactor in different periods is presented in **Figure 9**.

After analyzing the main absorption peaks in the different periods of the composting process, it was seen that around 3400 cm^{-1} a band characteristic of OH alcohols, phenols and carboxyl acids occurred and another with aliphatic groups was seen around 2928 cm^{-1} . These bands decreased along the process, due to the degradation of these groups characteristic of non-humic substances (carbohydrates and fat acids) and the formation of humic substances due to the microbiological action during the process [39, 41].

The peaks between the absorbance $1700\text{--}1750\text{ cm}^{-1}$ conferred the C=O stretching vibration, of carboxyl acid groups, ketones, and aldehydes, characterizing structures made of the non-ionized

Wave number (cm^{-1})	Assignments
3550–3300	H–OH vibration elongation (phenol groups, alcohols and carboxylic acids); N–H (amides and amines)
2920	C–H vibration elongation of aliphatic structures
1715–1750	C=O vibration elongation of COOH of carboxylic acids and ketones
1620–1660	C=O vibration elongation of primary amides C=O vibration elongation of ketones, acids and quinones Vibration elongation C=C of aromatics
1505–1560	Vibration elongation C=C of lignin aromatics; N–H and C=N of amine and secondary amide
1460	Vibration elongation C=C of aromatics, O–H of phenols
1375–1390	Vibration elongation COO, C–O of carboxylic acids and/or carbonates and nitrates and deformation of vibrations O–H of phenols
1220–1250	C–H and OH vibration deformation of carboxyl groups, C–O–C aromatic ether and N–H of secondary amides
1120 and 1030–1050	C–C vibration elongation of aliphatic C–O vibration elongation of polysaccharides, C–O of aromatic-cycle ether

Source: Zittel [31].

Table 3. Peaks of absorption of the spectrum of IR and its attributions.

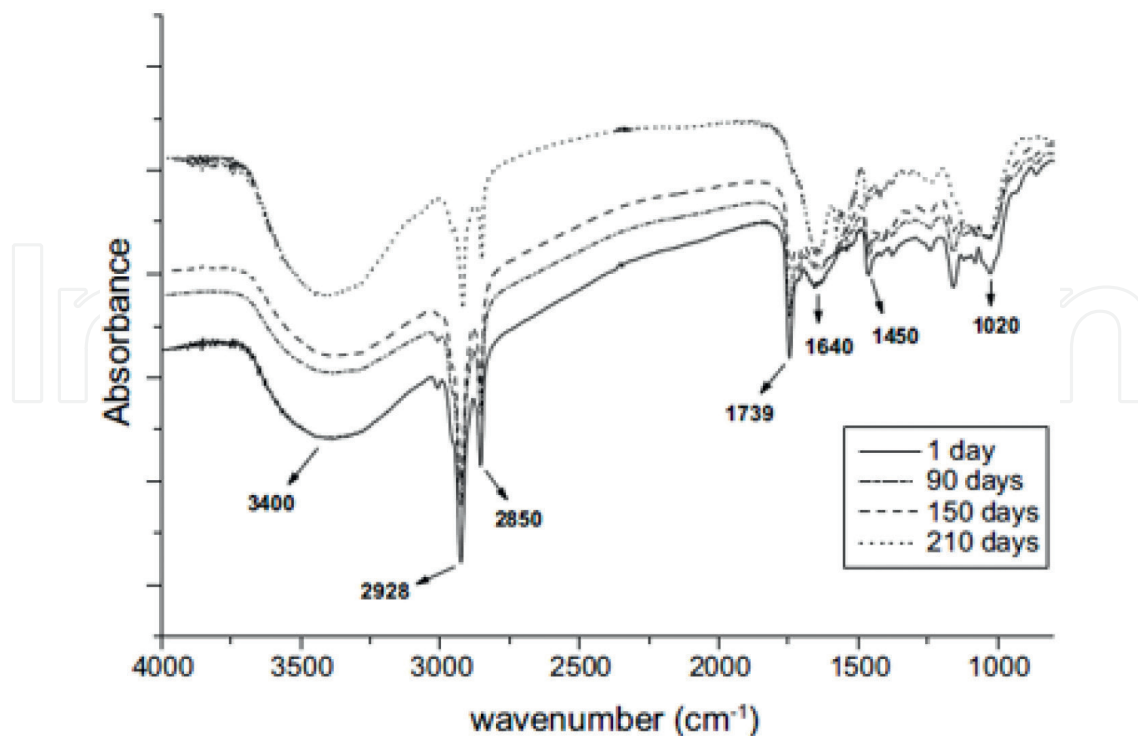

Figure 9. IR spectrum of food waste samples and sawdust in different periods of the composting process.

carbonyl. The spectrum region between 1600 and 1660 cm^{-1} is related to the intensity of the C=O groups of ionized carboxyl (COO^-) and conjugated to the aromatic ring and humic acids [39, 47].

The formation of a sharp peak between 1375 and 1390 cm^{-1} in 180 days of the process might be ascribed to the deformations of O=H of phenolic groups, present in the humic substance structure, while the vibrations in the 1010–1035 region indicated polysaccharide, C=O, stretching [41, 48].

The increase in the intensity of peak absorption at 1450 and 1390 cm^{-1} indicated the presence of oxidation reactions, with the formation of carboxyl and carbonate acids [46, 47, 49].

The IR spectrum presented absorption peaks which indicated the transformation of organic matter and matured compost production, characterizing the increase in the humic acids during the process.

4. Conclusions

From the results obtained, it was possible to conclude that the facultative reactor presented the advantages of being a low-cost system, not attracting vectors, enabling moisture and temperature control without the need for handling, besides allowing the treatment of several organic waste characteristic of rural areas. Phytotoxicity tests showed that the compost reached maturity over a period of 90 days. The spectroscopic analyzes showed that degradation of

compounds of simpler structure and the humification of the organic matter occurred. Thus, the compost obtained, with a substantial richness of stabilized organic matter and absence of toxicity, may be considered as an organic fertilizer. Finally, this study led to the conclusion that the facultative reactor proposed can be a promising technology to manage organic solid residue in rural areas.

Acknowledgements

We would like to thank CAPES, which was especially helpful at all stages of the research providing the researchers with scholarships.

Author details

Sandro Xavier de Campos^{1*}, Rosimara Zittel¹, Karine Marcondes da Cunha² and Luciléia Granhern Tavares Colares³

*Address all correspondence to: campos@uepg.br

1 State University of Ponta Grossa, Brazil

2 Federal Institute of Paraná, Jaguariaíva Campus, Brazil

3 Federal University of Rio de Janeiro, Brazil

References

- [1] OECD/FAO. OECD-FAO Agricultural Outlook 2016-2025. OECD Publishing, Paris. [Online]. 2016-2025 [cited 2017 março 25. Available from: <http://dx.doi.org/10.1787/agr-outlook-2016-en>
- [2] Instituto de Pesquisas Aplicadas—IPEA. Plano Nacional de Resíduos Sólidos: diagnóstico dos resíduos urbanos, agrosilvopastoris e a questão dos catadores. 2012
- [3] Massukado LM. Desenvolvimento do processo de compostagem em unidade descentralizada e proposta de software livre para o gerenciamento municipal de resíduos sólidos domiciliares. Programa de pós graduação em ciências ambientais. 2008
- [4] Zurbrügg C, Drescher S, Patel A, Sharatchandra HC. Decentralised composting of urban waste: An overview of community and private initiatives in Indian cities. *Waste Management*. 2004;**24**: 655-662
- [5] Teves IC, Miller PRM. Compostagem: Ciência e prática para gestão de resíduos orgânicos. Rio de Janeiro: Embrapa Solos; 2009

- [6] Gajalakshmi S, Abbasi AA. Solid waste management by composting: State of the art. *Environmental Science Technology*. 2008;**38**: 311-400
- [7] Oliveira AMG, Aquini AM, Castro Neto MT. Bahia: Embrapa; 2005 [Online] [cited 2010 junho 20. Available from: https://www.embrapa.br/mandioca-e-fruticultura/publicacoes/circulares/circular_76.pdf
- [8] Castilhos Junior AB, Pessin N, Fernandes F. Gerenciamento de Resíduos Sólidos Urbanos com Ênfase na Proteção de Corpos D'água: Prevenção, Geração e Tratamento de Lixiviados de Aterros Sanitários: Prosab–Rede Cooperativa de Pesquisas; 2006
- [9] Campos SX, Ressetti RR, Zittel R. Monitoring and characterization of compost obtained from household waste and pine sawdust in a facultative reactor by conventional and spectroscopic analysis. *Waste Management & Research*. 2014;**32**: 1186-1191
- [10] Tàtano F, Pagliaro G, Di Giovanni P, Floriani E, Mangani F. Biowaste home composting: Experimental process monitoring and quality control. *Waste Management*. 2016;**50**: 31&–38
- [11] United States Environmental Protection Agency—US EPA. Types of Composting and Understanding the Process Retrieved from [and understanding process in vessel](http://www.epa.gov/sustainable-management-food/types-composting). [Online]; 2016 [cited 28 November 2016. Available from: www.epa.gov/sustainable-management-food/types-composting
- [12] Dong JD, Zhang YY, Wang YS, Wu ML, Zhang S, Cai CH. Chemometry use in the evaluation of the sanya bay water quality. *Brazilian Journal of oceanography*. 2010;**58**(4): 339-352
- [13] Fernández J, Perez M, Romero LI. Effects of substrate concentration on dry mesophilic anaerobic digestion of organic fraction of municipal solid waste (OFSW). *Bioresource Technology*. 2008;**99**: 6075-6080
- [14] Fernández FJ, Sánchez-Arias V, Rodríguez L, Villaseñor J. Feasibility of composting combinations of sewage sludge, olive mill waste and winery waste in a rotary drum reactor. *Waste Management*. 2010;**30**: 1948-1956
- [15] Rodríguez L, Cerrillo MI, García-Albiach V, Villaseñor J. Domestic sewage sludge composting in a rotary drum reactor: Optimizing the thermophilic stage. *Bioresource Technology*. 2012;**112**:284-291
- [16] Villaseñor J, Rodríguez Mayor L, Rodríguez Romero L, Fernández FJ. Simulation of carbon degradation in a rotary drum pilot scale composting process. *Journal of Environmental Management*. 2012;**108**: 1-7
- [17] Lashermes G, Barriuso E, Villio-Poitrenaud ML, Houot S. Composting in small laboratory pilots: Performance and reproducibility. *Waste Management*. 2012;**32**:271-277
- [18] Mason IG, Milke MW. Physical modelling of the composting environment: A review. Part 1: Reactor systems. *Waste Management*. 2005;**25**: 481-500
- [19] Yu H, Huang GH. Effects of sodium acetate as a pH control amendment on the composting of food waste. *Bioresource Technology*. 2009;**100**:2005-2011

- [20] Kim KY, Kim HW, Han SK, Hwasng EJ, Lee CY, Shin HS. Effect of granular porous media on the composting of swine manure. *Waste Management*. 2008;**28**:2336-2343
- [21] Li Q, Wang XC, Zhang HH, Shi HL, T.Hu, Ngo HH. Characteristics of nitrogen transformation and microbial community in an aerobic composting reactor under two typical temperatures. *Bioresource Technology*. 2013;**137**:270-277
- [22] Paradelo R, Moldes AB, Barral MT. Evolution of organic matter during the mesophilic composting of lignocellulosic winery wastes. *Journal of Environmental Management*. 2013;**116**:18-26
- [23] Adhikari BK, Barrington S, Martinez JKS. Effectiveness of three bulking agents for food waste composting. *Waste Management*. 2009;**29**:197-203
- [24] Xi BD, Xi BD, He XS, Wei ZM, Jiang YH, Li MX, et al. Effect on inoculation methods on the composting efficiency of municipal solid wastes. *Chemosphere*. 2012;**88**: 744-750
- [25] Iyengar SR, Bhave PP. In-vessel composting of household wastes. *Waste Management*. 2005;**26**:1070-1080
- [26] Bernal MP, Alburquerque JA, Moral R. Composting of animal manures and chemical criteria for compost maturity assessment. A review. *Biosource Technology*. 2009;**100**: 5444-5453
- [27] Senesia N, Plazab C, Brunettia G, Polob A. A comparative survey of recent results on humic-like fractions in organic amendments and effects on native soil humic substances. *Soil Biology & Biochemistry*. 2007;**39**:1244-1262
- [28] Wange P, Changaa CM, Watsonb ME, Dickb WA, Chenc Y, Hoitinka HAJ. Maturity indices for composted dairy and pig manures. *Soil Biology & Biochemistry*. 2004;**25**: 767-776
- [29] Provenzano MR, Oliveira SC, Silva MRS, Senesi N. Assessment of maturity degree of composts from domestic solid wastes by fluorescence and Fourier transform infrared spectroscopies. *Journal of Agricultural and Food Chemistry*. 2001;**49**:5874-5879
- [30] Guo X, J.Gu, Gao H, Qin Q, Chen Z, Shao L, et al. Effects of Cu on metabolisms and enzyme activities of microbial communities in the process of composting. *Biosource Technology*. 2012;**108**:140-148
- [31] Zittel R. Tratamento de Resíduos Orgânicos Domésticos, Tabaco de Cigarros Contrabandeados e Resíduos de Madeira em Biorreator. 2014. Dissertação (Mestrado em Química Aplicada) - Universidade Estadual de Ponta Grossa, Ponta Grossa, p.96, 2014.
- [32] Associação Brasileira de Normas Técnicas – ABNT. NBR: 10007: Amostragem de Resíduos: Procedimentos [Online]. 2004 [cited 21 agosto 2013. Available from: www.iap.pr.gov.br/modules/conteudo/conteudo.php?conteudo=191
- [33] Ministério da Agricultura, Pecuária e Abastecimento—MAPA. Instrução Normativa 25/2009 Art.1 Inc.III. [Online]. 07 dezembro 2009 [cited 2011. Available from: <http://extranet.agricultura.gov.br/sislegis/action/detalhaAto.do?method=consultarLegislacaoFederal>

- [34] Kiehl EJ. Fertilizantes Orgânicos Piracicaba: Editora Agronomica "Ceres". 1985
- [35] Hong Kong Organic Resource Centre—Hkorc. Compost and soil conditioner quality standards. Hong Kong Organic Resources Centre Tong K, editor. Hong Kong Baptist University. 2005
- [36] Fialho LL, Silva WTL, Milori DMBP, Simões ML, Martin-Neto L. Characterization of organic matter from composting of different residues by physicochemical and spectroscopic methods. *Bioresource Technology*. 2010;**101**:1927-1934
- [37] Juarez MF, Prähauser B, Walter A, Insam H, Franke-Whittle IH. Cocomposting of bio-waste and wood ash, influence on a microbially driven-process. *Waste Management*. 2015;**46**: 155-164
- [38] Mulec AO. Composting of the solid fraction of blackwater from a separation system with vacuum toilets—effects on the process and quality. *Journal of Cleaner Production*. 2016;**112**:4683-4690
- [39] El Fels L, Hafidi M, Ouhdouch Y. Artemiasalina as a new index for assessment of acute cytotoxicity during co-composting of sewage sludge and lignocellulose waste. *Waste Management*. 2016;**50**:194-200
- [40] Albrecht R, Le Petit J, Terrom G, Périsol C. Comparison between UV spectroscopic and NIRS to assess humification process during sewage sludge and green wastes co-composting. *Bioresource Technology*. 2011;**102**:4495-4500
- [41] Spaccini R, Piccolo A. Molecular characteristics of humic acids extracted from compost as increasing maturity stages. *Soil Biology & Biochemistry*. 2009;**41**:1164-1172
- [42] Yuan J, Chadwick D, Zhang D, Li G, Chen S, Luo W, et al. Effects of aeration rate on maturity and gaseous emissions during sewage sludge composting. *Waste Management*. 2016;**56**:403-410
- [43] Zorpas AA, Inglezakis VJ, Loizidou M. Heavy metals fractionation before during and after composting of sewage sludge with natural zeolite. *Waste Management*. 2008;**28**:2054-2060
- [44] Amir S, Jouraiphy A, Meddichb A, El Gharous M, Wintertonc P, Hafidi M. Structural study of humic acids during composting of activate sludge-green waste: Elemental analyses, FTIR and ¹³C NMR. *Journal of Hazardous Materials*. 2010;**177**:524-529
- [45] Ali M, Bhatia A, Kazmi AA, Ahmed N. Characterization of high rate composting of vegetable market waste using Fourier transform-infrared (FT-IR) and thermal studies in three different seasons. *Biodegradation*. 2012;**23**:231-242
- [46] El-Ouaquoudi FZ, El Fels L, Lemée L, Amblès A, Hafidi M. Evaluatin of lignocellulose compost stability and maturity using spectroscopic (FTIR) and thermal (TGA/TDA) analysis. *Ecological Engineering*. 2015;**75**:217-222
- [47] Sarika D, Singh J, Prasad R, Vishan I, Varma VS, Kalamdhad ASS. Study of physico-chemical and biochemical parameters during rotary drum composting of water hyacinth. *International Journal Organic Waste Agriculture*. 2014;**3**:63

- [48] He WS, Xi BD, Wei ZM, Jiang YH, Geng CM, Yang Y. et al. Physicochemical and spectroscopic characteristics of dissolved organic matter extracted from municipal solid waste (MSW) and their influence on the landfill biological stability. *Bioresource Technology*. 2011;**102**:2322-2327
- [49] Hachicha R, Hachicha S, Trabelsi I, Woodward S, Mechichi T. Evaluation of the fatty fraction during co-composting of olive oil industry wastes with animal manure: Maturity assessment of the product. *Chemosphere*. 2009;**75**:1383-1386

IntechOpen

