

We are IntechOpen, the world's leading publisher of Open Access books Built by scientists, for scientists

4,800

Open access books available

122,000

International authors and editors

135M

Downloads

Our authors are among the

154

Countries delivered to

TOP 1%

most cited scientists

12.2%

Contributors from top 500 universities



WEB OF SCIENCE™

Selection of our books indexed in the Book Citation Index
in Web of Science™ Core Collection (BKCI)

Interested in publishing with us?
Contact book.department@intechopen.com

Numbers displayed above are based on latest data collected.
For more information visit www.intechopen.com



Plasma-Enhanced Chemical Vapor Deposition: Where we are and the Outlook for the Future

Yasaman Hamedani, Prathyushakrishna Macha,
Timothy J. Bunning, Rajesh R. Naik and
Milana C. Vasudev

Additional information is available at the end of the chapter

<http://dx.doi.org/10.5772/64654>

Abstract

Chemical vapor deposition (CVD) is a technique for the fabrication of thin films of polymeric materials, which has successfully overcome some of the issues faced by wet chemical fabrication and other deposition methods. There are many hybrid techniques, which arise from CVD and are constantly evolving in order to modify the properties of the fabricated thin films. Amongst them, plasma enhanced chemical vapor deposition (PECVD) is a technique that can extend the applicability of the method for various precursors, reactive organic and inorganic materials as well as inert materials. Organic/inorganic monomers, which are used as precursors in the PECVD technique, undergo disintegration and radical polymerization while exposed to a high-energy plasma stream, followed by thin film deposition. In this chapter, we have provided a summary of the history, various characteristics as well as the main applications of PECVD. By demonstrating the advantages and disadvantages of PECVD, we have provided a comparison of this technique with other techniques. PECVD, like any other techniques, still suffers from some restrictions, such as selection of appropriate monomers, or suitable inlet instrument. However, the remarkable properties of this technique and variety of possible applications make it an area of interest for researchers, and offers potential for many future developments.

Keywords: plasma, polymers, vapor deposition

1. Introduction

Chemical vapor deposition (CVD) is a multifaceted procedure which is currently used for several applications such as the fabrication of coatings, powders, fibers, and uniform components. Metals, composites of nonmetallic materials such as carbon, silicon, carbides, nitrides, oxides, and intermetallics can be deposited through CVD. Considering one of the main applications of CVD, which is the synthesis of thin films and coatings, this procedure has in general overcome some of the problems Facing the chemical synthesis of thin films, and simplified the process by having a single-step uniform fabrication. In the CVD technique, a precursor gas flows into a chamber, over the heated substrates to be coated, and deposition of thin films on the surface occurs due to the chemical reaction in vapor phase as shown in **Figure 1A**. This procedure could be defined as an atomistic process where the primary Species deposited are atoms or molecules or a combination of both. Other common deposition procedures include physical vapor deposition technique (PVD), which uses evaporation, sputtering, and other physical processes to produce Vapors of materials instead of chemical processes. The PVD technique, however, has some drawbacks, such as low deposition rate and low pressure requirements. Moreover, this process might require subsequent annealing, which could be a drawback. Although these two techniques can be used separately, however, there are procedures that have utilized The benefits of the combination of CVD and PVD techniques, such as a modified PEVCD method.

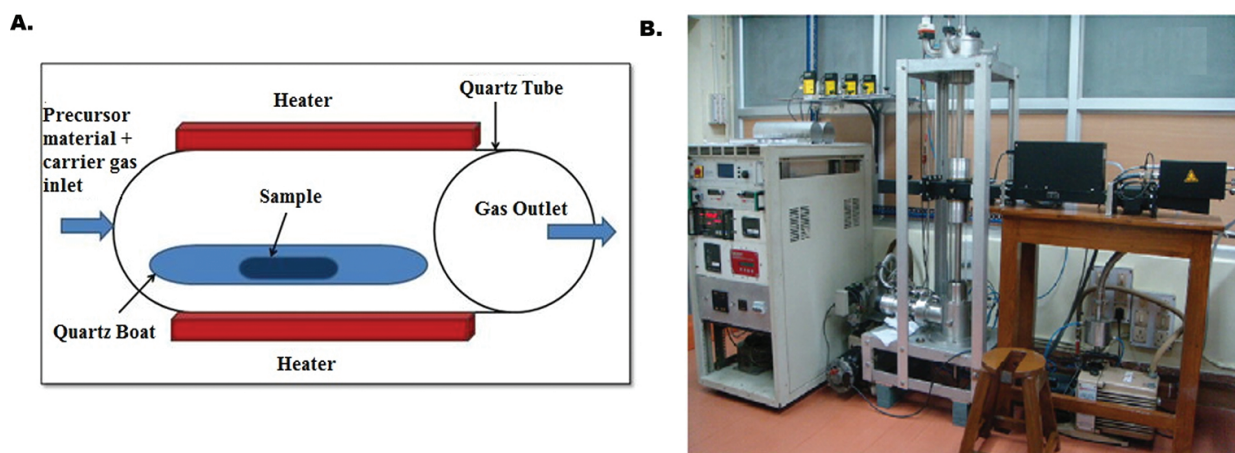

Figure 1. (A) Schematic of chemical vapor deposition technique demonstrating the various components of the instrument. (B) Microwave PECVD unit (reprinted with permission from [1], © Elsevier).

There are many hybrid techniques, which arise from CVD and are constantly evolving to modify the properties of the fabricated thin films [2], namely initiated CVD (iCVD), which utilizes an initiator to start the polymerization process because the initiator thermally decomposes to form free radicals and they are absorbed on the surface and therefore lead to start the radical polymerization, Oxidative CVD (oCVD), which can be considered as an iCVD process and utilizes an oxidant molecule as the initiator for starting the polymerization [3], metallo-organic CVD (MOCVD), which operates at temperatures lower than CVD (300–800°C) and is

used for achieving epitaxial growth and deposition of semiconductor materials [4, 5], Where deposition occurs at low pressure (10 –1000 Pa) to achieve and homogeneity of the deposited films [6], atmospheric pressure CVD (APCVD) in which deposition occurs at atmospheric pressure, which leads to lower equipment cost, avoids use of vacuum systems and simplicity of utilization and process control parameters [7] and plasma-enhanced CVD (PECVD), which uses electrical energy for producing a plasma, and the produced plasma activates the reaction by transferring the energy of its species to the precursors and induces free radical formation followed by radical polymerization [2]. Among them, PECVD can extend applicability of the vapor deposition process to various precursors, including reactive organic, inorganic, and inert materials. In this chapter, we will briefly demonstrate the characteristics of the PECVD technique, its advantages and disadvantages over other techniques, an overview of studies utilizing PECVD for both organic and inorganic materials deposition, as well as the future direction and potential applications.

CVD	PVD	PECVD
<p>ADVANTAGES</p> <ul style="list-style-type: none"> • Avoids the line-of-sight • High deposition rate • Production of thick coating layers • Co-deposition of material at the same time <p>DISADVANTAGES</p> <ul style="list-style-type: none"> • Requirement of high temperatures • Possibility of toxicity of precursors • Mostly inorganic materials have been used 	<p>ADVANTAGES</p> <ul style="list-style-type: none"> • Atomic level control of chemical composition • Not requiring the usage of special precursors • Safer than CVD due to the absence of toxic precursors or by-products <p>DISADVANTAGES</p> <ul style="list-style-type: none"> • Line-of-sight deposition • Low deposition rate • Production of thin coating layers • Requirement of annealing time 	<p>ADVANTAGES</p> <ul style="list-style-type: none"> • Avoids the line-of-sight issue to certain extent • High deposition rate • Low temperatures • Both organic and inorganic materials as precursors • Unique chemical properties of the deposited films • Thermal and chemical stability • High solvent and corrosion resistance • No limitation on substrates: complicated geometries and composition <p>DISADVANTAGES</p> <ul style="list-style-type: none"> • Instability against humidity and aging • Existence of compressive and residual stresses in the films • Time consuming specially for super-lattice structures • Existence of toxic, explosive gases in the plasma stream • High cost of equipment

Table 1. Comparison of the characteristics, advantages and disadvantages of the CVD, PVD, and PECVD techniques.

The CVD process, its modifications, and PVD each have their own unique advantages and applications. CVD may successfully overcome issues such as line-of sight deposition, which PVD commonly faces. This can improve the ease of coating both nonuniform and straight surfaces. From an economical perspective, CVD also offer advantages due to the ease of synthesis of thick coatings. The process also allows flexibility during deposition such as

codeposition of different materials, inclusion of plasma, or initiators to improve reactivity and operation at atmospheric pressure. On the other hand, CVD in its unmodified form has disadvantages, such as the requirement of higher temperatures (over 600°C). The high temperature is a constraint both due to the energy required to heat the gas phase, which increases the cost of the process and the limitation of materials and substrates that can be used due to their instability at higher temperatures. The other disadvantage of the process is the utilization of chemical precursors with high vapor pressure, such as halides, metal-carbonyl precursors, and hybrid ones which may be an issue due to some of their associated toxicities, as well as the limitation of types of materials that may be used as precursors. Moreover, the by-products of the CVD process maybe toxic and their neutralization can make the process expensive. However, PECVD, which has seen a rapid development in the last few years, has eliminated these problems to a great extent as discussed in **Table 1**.

1.1. History of PECVD

The initial experiments using plasma in the CVD process dates back to 1950s and 1960s when the decomposition of organic compounds in the presence of an electron beam was first observed [8–10]. In the electro-optical systems, when a surface was exposed to an electron beam, it was covered by a thin film. Upon observing this effect, researchers reasoned that the formation of the thin film was due to the interactions between the electron beam and organic vapor present in the vacuum system. They concluded that the mechanism of formation of the thin layer was the free radical polymerization of the organic molecules, upon exposure to the electron beam followed by adherence to the target surface [8–10]. After roughly a decade, Buck et al. suggested that the observed mechanism of film formation can be beneficial for applications where thin insulating films were required [11]. Subsequently, relative electron bombardment of appropriate chemical compounds was used for the fabrication of polymeric or metallic thin films. Christy et al. in 1960 used a defocused, low energy electron beam to form solid films composed of silicon oil. The factors affecting the film growth rate, such as oil pressure, strength of electron beam current, and temperature were also investigated. He showed that the produced films had excellent electrical insulating properties [11]. In 1961, Baker et al. have Demonstrated the production of metallic films from decomposition of organometallic vapors by an electron beam [12]. Among the initial reports on the use of PECVD, there was one in 1962, in the Electronics Laboratory of General Electric Company for the utilization of the direct current glow discharge system for the production of thin films [13]. Laendle et al. reported the use of an organosilicon compound and its decomposition in a low-energy plasma to fabricate a silicon oxide film [10]. The decomposition reported was related to the collisions that occurred between the excited or ionized gas atoms with the organosilicon molecules, which in turn resulted in the formation of free radicals, followed by their attachment on the substrate and finally due to continuous bombardment, fabrication of stable Si-O-Si network and the resultant thin film. In 1964, Davern et al. reported the use of the same process for the fabrication of silicon oxide films at room temperature, but with the use of radio frequency (RF) plasma production source to reduce the undesired sputtering observed in the previous report. A continuous bombardment of the surface was used to prevent the deposition of decomposition products. In the following year, they also investigated the use of the silicon dioxide films as a diffusion

masking against other diffusants such as N-type semiconductors including GaAs [14]. In 1965, the deposition of silicon oxide thin film capacitor was demonstrated in an AC glow discharge plasma. The produced film was amorphous, coherent and had good adherence. These capacitors also demonstrated thermal stability, resistance to humidity, and breakdown strength characteristics [15]. In 1971, Reinberg developed the "Reinberg reactor," which involved the use of a parallel plate, capacitively coupled RF reactor for depositions at lower temperatures for semiconductor encapsulation and optical coatings [16, 17]. This reactor was capable of inducing radial, laminar flow of the reactant gases over the substrate, resulted in enhancing the uniformity of the desired coating [16–18]. During this time, the process was also referred to as the chemical ion-plating and was commonly used for the deposition of silicon nitride films for encapsulation, and metal carbides [16]. Subsequently, the "plasma-assisted" or plasma-enhanced CVD as it is commonly known as evolved over the past few decades, and some of the process parameters and applications are discussed further on.

2. Methods

The CVD process can operate in two different reactor schemes: a closed reactor and an open one. In the closed reactor CVD, which is the most common one, the species are placed in a container and the container is closed; however, in the open reactor CVD, or flowing-gas CVD, the chemicals are being entered the system continuously. However, in both systems, there is a reactant supply section, in which the reactant, which may be in a gas, liquid, or solid phase, must be transported into the reactor. In the case of gaseous reactants, they can be transferred into the reactor through pressure controllers, however, in the case of liquid or solid reactants, the reactants need to be heated up to their evaporation temperature, which can sometimes be problematic to the process. Then the reactants can be transported by an inert carrier gas to the reactor [5].

Depending on the activation energy used in the CVD process, such as temperature, photon, or plasma it can be categorized into several groups, namely, thermal CVD, laser/photo CVD, and plasma CVD. Thermal CVD typically requires high temperature in the ranges of 800–2000°C, which can be produced by methods such as hot plate heating, and radiant heating. In the case of laser or photo CVD procedures, photons are produced using either a high power laser or ultraviolet (UV) radiation. Laser CVD involves the use of a laser for the generation of a strong beam of photons for the activation of CVD and photo CVD where the reaction is activated by the use of UV radiations for the dissociation of chemical bonds. However, in plasma CVD, or plasma-enhanced CVD (PECVD), the reaction is activated by the use of inert gas plasma. The utilization of plasma decreases the deposition temperature to a great degree in comparison with other methods such as thermal CVD. Deposition can occur at room temperature and the thermal effects are avoided and this opens up the opportunity of coating polymers and other materials with low melting temperatures [19]. As previously mentioned, PECVD is a variant of the CVD process in which an inert gas plasma is used for deposition of thin films. Thus far, CVD has been mostly applied to inorganic materials. The plasma, which is used in the PECVD technique, allows the usage of a wide range of precursors, both organic and inorganic due to the improved reactivity of the precursors [20, 21]. Plasma is a partially

or fully ionized gas and generally is a mixture of electrons, charged particles, and neutral atoms, and therefore, the plasma state has extremely high energy; however, the plasma has no net charge, i.e., neutral. The energy that is available in a plasma discharge is used for various applications, one of these applications is the deposition of thin films and coatings.

In the PECVD process, an external energy source is required for the ionization of atoms and molecules (creation of the plasma), a pressure reduction system (maintain the plasma state), and finally, the existence of a reaction chamber. One method for plasma production is the heating of the gas; however, ionization temperatures are extremely high, and this can be limitation of this method. The other way of plasma production is the utilization of electrical energy, at various frequency discharges which can be subcategorized into audio frequency (10 or 20 kHz), radio frequency (13.56 MHz), and microwave frequency (2.45 GHz), and this can result in various types of plasma being produced. However, when a plasma produced by any of these techniques is utilized, the deposition species undergo fragmentation which forces them to become submonomers or free radicals and ions. The plasma induces radical or plasma polymerization in the monomers. Neutral molecules will be ionized or excited when the electrons and ions in the plasma interact with them, so they will become chemically reactive. The collision of a charged ion with a neutral atom will result in improved chemical reactivity and production of implantation reactions of atoms, radical generation, and polymer-forming reactions or an etching reaction [19, 22].

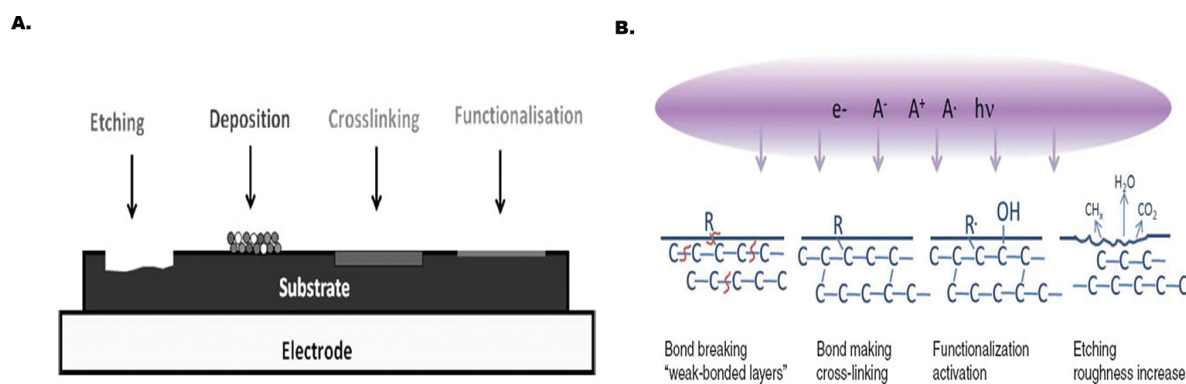

Figure 2. (A) Various processes that polymer surfaces can undergo in the time of exposure to the plasma stream (reprinted with permission from [16], © Springer). (B) Schematic of various modifications on polymer surfaces during plasma treatments (reprinted with permission from [27], © 2014 Walter de Gruyter).

The monomers that are used in this procedure are mainly in the gas or liquid states, which can be easily evaporated; however, there are studies which use solid monomers as well. Utilization of solid monomers requires inclusion of sublimation apparatus by which the solid monomer can sublime for deposition and this capability allows the use a vast range of materials as monomers [20, 23–26]. When a gaseous or liquid precursor with high vapor pressure is introduced into the PECVD reaction chamber, dissociation and activation of the precursor occur and in the presence of the plasma, which allows the deposition to happen at much lower temperatures compared to CVD. When the plasma comes in contact with the surface of a polymer substrate, modification of the surface can occur in different ways, namely *etching*,

where the plasma treatment leads to the removal of materials from the surface; *deposition*, where precursors in the plasma stream are deposited as a plasma polymerized thin layer on the surface; *cross-linking and functionalization*, which involves modifications of the plasma polymers on the surface as shown in **Figure 2** [27–29].

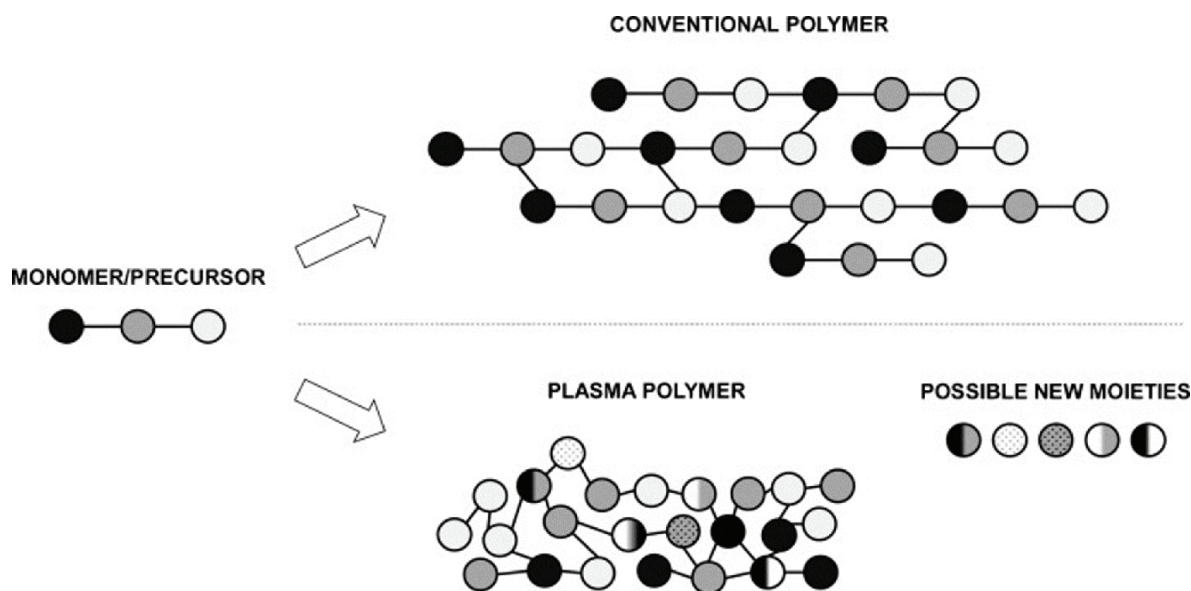

Figure 3. Schematic of structural differences among conventional polymers and plasma polymers (reprinted with permission from [30], © 2015 Elsevier).

During the PECVD process, the plasma polymerization of the precursors, which are induced in the plasma stream, is of the random radical recombination type. There is always a radical that initiates the process of polymerization, due to the radicalization of the precursor, which at the end of the process, results in the formation of polymer. And due to the presence of the radicals in each chain of the produced polymer, cross linking of the polymer also occurs; therefore, the final resulting plasma polymer coating has a cross-linked structure [29, 30, 32]. Due to the existence of a greater degree of cross-linked and branched structures, the overall structure of the plasma polymeric thin film is not similar to the conventional polymers, as shown in **Figure 3** [30, 33]. Another evidence for this difference is that the structure of subunits of the plasma polymers, which are referred to as “monomers” for conventional polymers, is not conserved during the process; therefore, they cannot be characterized by their repeating units [33–35]. However, the structure of the subunit can be reserved only under specific conditions, in which all the external and internal plasma parameters are optimized.

2.1. Variation of pressure for plasma production

The internal plasma parameters that affect the final polymerized film, include homogeneity of discharge, distribution of various species in the plasma, and energy of the species, and the external plasma parameters include reactor geometry, applied voltage, frequency, total pressure, and flow rate [32, 36]. Some of the parameters can be modified to create different

variants of this technique, namely temperature, length of the deposition, pressure, inert gas flow rate, method of plasma production, and the power of the source. The most important ones among them are pressure and method of plasma production. Based on the pressure during deposition, the PECVD process can be classified as low pressure (LP-PECVD) and atmospheric pressure (AP-PECVD), with different specific applications [34]. Both of these techniques are similar to PECVD in the main steps of the procedure such as passage, transportation and absorption of the gaseous species over the surface, and production of the reaction products at the end [6]. Initial PECVD studies were performed mostly at low pressure to avoid the plasma instability due to the mean-free path of the plasma species. But the utilization of AP-PECVD, which means having the plasma at an ambient pressure, has become an area of interest in the recent years. AP-PECVD offers two main advantages, namely, avoiding the cost of expensive vacuum pumping systems and transfer chambers from air to vacuum. The ease of controlling the plasma parameters such as current, gas flow, power, and voltage during the AP-PECVD process also makes it attractive and the schematic for the process is shown in **Figure 4**. Moreover, it has also been observed that APCVD demonstrates superior adherence of the coating on the substrate due to plasma activation [29, 34, 37]. Also, in LP-PECVD, there can be limitation on the size of the substrate to be treated, which is dependent on the size of the vacuum chamber, but it is not the case in AP-PECVD [38]. LP-PECVD has some other disadvantages too, such as lower deposition rates compared with AP-PECVD. For some of the LP-PECVD techniques, applying higher temperatures is required to bring about more uniformity with less defects for the produced layer, but this can also be considered as a disadvantage for the procedure [6]. Besides, it has been demonstrated that the chemical structure of the materials is more effectively retained in the AP-PECVD due to the lower energy of plasma in comparison with LP-PECVD [37, 39]. Treating materials such as textiles, scaffolds, membranes, and hydrogels is an area where the use of AP-PECVD over LP-PECVD has had a considerable effect [40, 41].

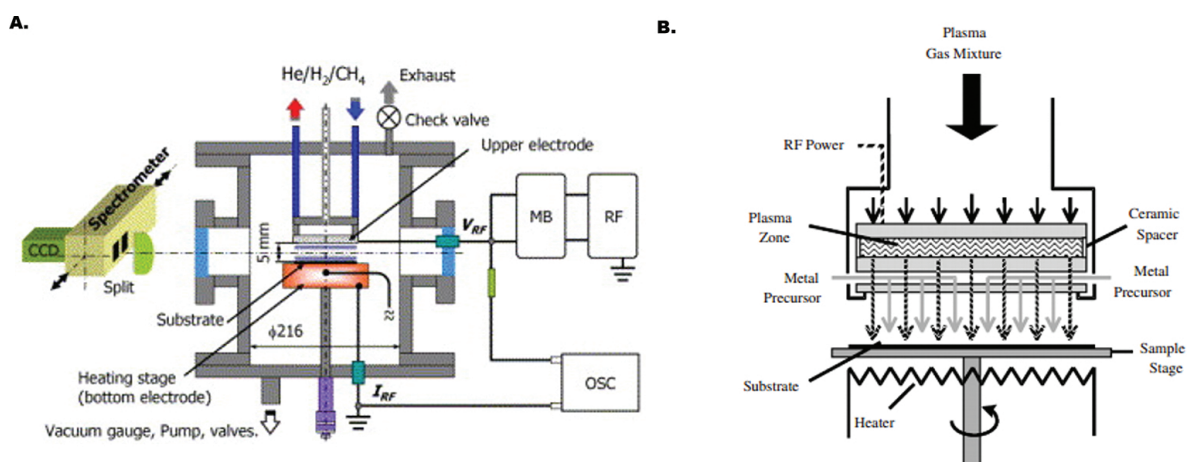

Figure 4. (A) Atmospheric RF discharge used for the deposition of single walled carbon nanotubes (reprinted with permission from [42], © Elsevier). (B) Schematic of APCVD apparatus used for the deposition of zinc oxide (reprinted with permission from [43], © 2007 Elsevier).

The primary advantage of the low pressure plasmas is the high purity of the coatings produced compared to the atmospheric pressure plasmas. When utilizing LP-PECVD, the ratio of mass transport velocity to the velocity of reaction on the surface will be different. When the pressure decreases during LP-PECVD, the diffusion of the gas decreases and therefore the velocity of mass transport will also decrease correspondingly and the produced layer is expected to be more uniform [6]. However, in the AP-PECVD, the ratio of mass transport velocity and the velocity of reaction on the surface is equal to one and the two velocities are of the same order of magnitude. Moreover, another issue facing with AP-PECVD is the problem of maintaining a glow discharge under the atmospheric pressure, which however, has been developed to some extent [38]. One of the major differences between the LP-PECVD and AP-PECVD is in the plasma excitation step. In LP-PECVD, the collision between the monomer with an electron is responsible for activating the monomers and the excitation mechanism can be denoted as follows (1):



Although this process exists in the AP-PECVD as well, but at atmospheric pressure, there are other reactions in which unstable high-energy atoms or molecules from the plasma gas exist too, so the aforementioned collision may not be the main collision responsible for activating the monomers. And therefore, the energy transfer in APCVD is more efficacious (2).



2.2. Methods of plasma production

The different methods of plasma production, include microwave frequency (MW) plasma, also known as glow-discharge, radio frequency (RF) plasma, and arc plasma. By utilizing two electrodes in the reaction chamber, the high frequency power is applied to the gas to be ionized. When the microwave frequency is used, plasma is produced by the application of a high frequency electric field of magnitude of 2.45 GHz at a low pressure to a carrier gas such as oxygen, argon, or nitrogen, and the schematic of this process is shown in **Figure 5A**. At such high frequencies, electrons due to their small masses can accelerate toward the higher energy levels; however, this is not the case for the heavier ions, therefore, the temperature of electrons increases, but for heavier ions, it will remain low, and so this is a nonisothermal plasma. In the microwave plasmas, the electrons with their high energy levels are responsible for collision with the gas molecules to dissociate them and make them reactive for further plasma polymerization and one such reactor is shown in **Figure 1B** [1]. This technique has been used for deposition of conductive films from a metal target. There are also many reports on the utilization of lower frequency discharges such as RF [23, 24]. Usually, in the case of an RF source, a matching box is used alongside the RF generator to reduce the reflected power, as shown in **Figure 5B**. The power setting differs based on the material deposited. The RF source is mainly used for nonconductive materials. Unlike for the LP-PECVD case in which micro-

wave frequency or a microbeam plasma generator is used, production of a stable plasma in an AP-PECVD utilizing an RF source does not require a dielectric material between the electrodes [44]. Arc plasmas typically operate at moderate frequencies of 1 MHz lower than the microwave plasma sources.

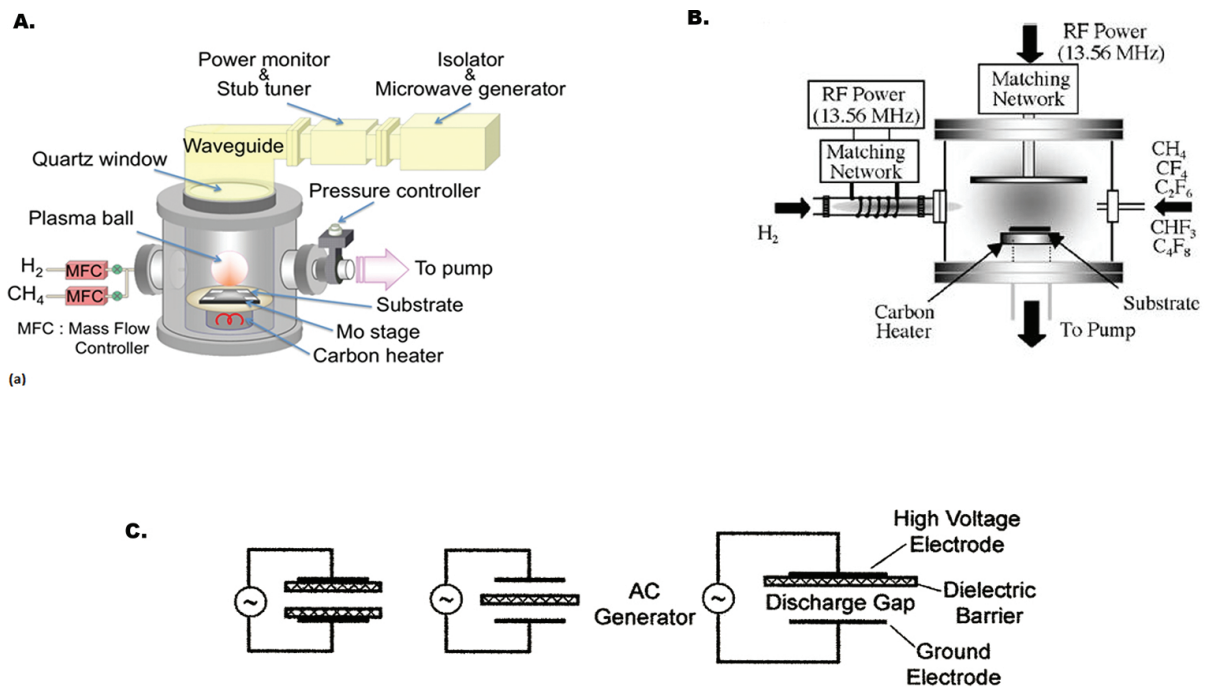

Figure 5. (A) Schematic of carbon nanotube growth procedure with microwave PECVD apparatus (reprinted with permission from [45], © InTech). (B) Schematic of the radio frequency PECVD apparatus for the production of carbon nanowalls (reprinted with permission from [46], © 2005 Elsevier). (C) Schematic of a dielectric barrier discharge system (reprinted with permission from [47], © 2003 Springer).

However, arc plasmas are extremely hot and require higher power, so they are not usually utilized and some of the efforts to avoiding this include limiting the discharge time, which is the time applied for the electrons to accelerate in the electric field, by applying pulsed voltages or using a dielectric material between the electrode to reduce the accumulation of the electrons, which is called dielectric barrier discharges (DBD), as shown in **Figure 5C** [19, 34]. Arc plasma CVD techniques are mainly used for deposition of diamonds where the process occurs at a higher pressures compared to MW PECVD, and therefore, the number of collisions increases, and, consequently, the temperature is higher. Due to high temperatures, total dissociation of hydrogen molecules occurs and proves to be advantageous over the MW PECVD and thermal CVD due to the decreased production of atomic hydrogen species [19]. Due of the high temperature of the arc plasma deposition, substrate cooling is necessary, but it is difficult process; therefore, the high temperature of this procedure counts as a disadvantage of it; however, high rate of deposition and thickness of the produced layer are some of the advantages. The plasma at different frequencies (microwave, radio frequency, and arc plasma) can be produced by various methods such as inductively coupled or capacitive-coupled parallel

plates and/or electron cyclotron resonance (ECR). For example, an MW plasma can be produced by the latter method, which is the case when the frequency of the applied electric field becomes matched with the natural frequency of the electrons when they orbit the magnetic field. The RF frequency plasma can be generated in the capacitive-coupled parallel plate configuration plasma reactor in which one of the electrodes is electrically grounded while the RF power is applied to the other electrode as shown in **Figure 5A** [46]. By considering the temperature of the species present in the plasma stream, the process can be divided into two categories. One is the case in which all the plasma species: ions, electrons, and neutral species all exist at the same temperatures, which means that plasma is at the local thermal equilibrium (LTE), and the other is when this equilibrium does not exist and the species are at different temperatures (non-LTE), and electrons may be at a higher temperature in comparison with the other particles. In a LTE plasma state, the density of electrons is usually higher than the non-LTE state, and therefore, the mean free path of the electrons is lower, and, consequently, the number of collisions increases. In the case of AP-PECVD, the plasma is expected to be in the LTE state since the higher pressure also leads to increased number of collisions; therefore, the temperature of the molecules and ions increases [43]. This case is called an arc plasma, which operates at lower frequencies compared to microwave and higher frequencies compared to RF sources (1 MHz) [19, 34].

PECVD can be considered as a nonlinear process, because the plasma stream can surround the substrate, and therefore, leads to uniform deposition and alleviates some of the issues associated with ionic or e-beam sputtering processes. It has been well-documented in the literature that the resulting chemistry of the thin films produced by PECVD is unique and cannot be obtained by common wet deposition techniques. These fabricated thin films also demonstrate high solvent and corrosion resistance along with thermal and chemical stability [24]. The process results in efficient and controlled usage of precursors and the generation of very little by-products. The process allows the utilization of unconventional precursors and can be used for deposition on surfaces with complicated geometries [48]. Moreover, because the interactions are occurring just at the surface of the substrates, mechanical properties of the substrates will not change and the film that is formed is completely uniform [49]. The plasma polymers fabricated by this technique have high modulus, due to the dense cross-linking in their polymer chains. There are some reports that show these produced polymer layers have a high permeability coefficient of oxygen and nitrogen which is mainly related to the deposition mechanism as well as the polymerization mechanism of plasma polymers [22]. Besides, if the plasma polymers contain ionic groups, they will have a wide variety of applications in various fields which require electrical conductivity, antistatic esterification, and biocompatibility.

A major difference between the films produced by PECVD and CVD is that, the ones produced through PECVD have higher content of hydrogen, which is due to the utilization of plasma in the deposition process [50]. The synthesized plasma polymers have some disadvantages as well, such as instability against aging and humidity which is due to free radicals that exist in the plasma polymers as well as the existence of polar side groups that can absorb water, and therefore may render them unsuitable for dielectric thin films [49, 51]. Some ways of over-

coming this problem such as heat treatment of plasma polymers in a vacuum which will decrease the radical concentration in the deposited thin films has been reported [35, 49, 51]. Another disadvantage is that undesirable compressive and residual stresses in the deposited film can occur at lower frequencies, which could lead to subsequent cracking and cause problems in many applications, specifically metallurgy [35]. Residual stresses can also affect thick oxide films where fracture has been observed [52]. Techniques for controlling the residual stress, which ultimately resulted in limiting the thickness of the produced layer, such as rapid thermal analysis (RTA) have been utilized [53]. However, this treatment may have other impacts on the characteristics of the produced film too; therefore, the behavior of the PECVD oxide layer following the heat treatment should be analyzed [54]. Also, the ion bombardment during the process could damage some sensitive substrates. Moreover, the problem of line-of-sight does exist to some extent and therefore, the regions that are directly exposed to the plasma stream will be more affected than the other regions. One other major issue is that due to the presence of several species in the plasma stream (with varying mass and charge), the film growth can be influenced by different species. The mechanism of this growth depends on the chemistry of the depositing species and the conditions used for deposition. For example, in DLC film deposition, it has been shown that both ions and neutral species are a part of the mass of the produced film [55]. However, in the production of silane or polymeric films, the role of radicals, as well as the influence of plasma pressure, has been considered [56, 57]. Therefore, development in the understanding the roles of different plasma species on the film growth, will enhance the film production, as well as control of the process [58].

3. Applications

The initial application of PECVD was in microelectronics, namely electrical insulation films, conductive films, semiconductors, diffusion masks, and capacitors. Over a decade after the establishment of PECVD process, researchers started to utilize this technique for the fabrication of integrated circuits (ICs) [15, 52, 59], solar cells [43, 60, 61], transistors [62], photovoltaic and photonic applications [48, 59, 63, 64] such as notch filters and antireflective coatings [27]. Deposition of inorganic materials by PECVD also has applications in food packaging, scratch resistance, and biomedical applications [2, 65, 66]. PECVD has been extensively used in the development of organic polymers and organometallic compounds. Plasma polymers are used to avoid corrosion in many dielectric and optical devices. The film properties can be easily controlled to produce homogenous organic thin films on large substrates (silicon and glass) with varying mechanical, optical, chemical, thermal, and electric properties. Due to its relatively moderate nature, this technique has also recently been used for various biological applications. Biological applications include immobilization of the biomolecules (e.g. enzymes and proteins); biometallization of gold, silver and platinum nanoparticles with the aid of DNA, amino acids or proteins; Degradation and molecular weight reduction of biopolymers such as chitosan in order to enhance their properties; Changing surface functionalities by addition of functional groups such as amine, carboxylic and silane groups; Fabrication of organic/inorganic hybrid film for enhancing the dielectric properties. Such surface treatment of

implants and biomaterials for applications in biosensors, device fabrication and anti-biofouling coatings [20, 25, 40, 67].

3.1. Silicon-based applications

PECVD is recognized as a unique method of organic thin film deposition and is commonly used for the deposition of inorganic and organic, doped, and undoped films. Silicon composite films is one area where thin films are deposited from various precursors such as silane (SiH_4), siloxane, and silazane mixed with other gases in varying ratios [68, 69]. The two predominant forms of silicon which get deposited are hydrogenated amorphous (a-Si:H) and microcrystalline ($\mu\text{c-Si:H}$) silicon [70–72]. The films deposited through PECVD, are used in semiconductor devices, solar cells, and optically active device applications due to their optical, mechanical, and electrical properties. Recently, PECVD has also been utilized for the processing of flexible and printable electronic devices, due to its high process efficiency, large-scale patternability, lower cost, and environmentally friendly nature [73, 74]. AP-PECVD at low gas temperatures due to absence of vacuum equipment, seems beneficial in the surface processing of flexible materials and has been demonstrated in the lower temperature deposition of SiO_x films on polymer substrates that are used as diffusion barrier and stable hydrophilic surfaces. The applications of flexible semiconductors can be seen in wearable electronics and organic electronics [75, 76].

3.1.1. Semiconductor devices

The physical properties of PECVD-deposited films are known to be superior since they are highly cross-linked, uniform, and resistant to thermal and chemical changes and have low rates of corrosion. Plasma polymers find extensive use in dielectric films and optical coating due to lower cost and higher efficiency [77, 78]. Plasma polymerized organic-inorganic hybrid thin films with ratio controlled precursors has been used to optimize dielectric properties. Also, the characteristics of the thin film were modified by the gases' mixing ratio, plasma power, and chamber pressure [35, 79]. Silicon oxynitride (SiON) and silicon nitride (SiN) are some of the commonly used precursors for the deposition of insulating thin films for MIM (metal-insulator-metal) capacitors and allow easy manipulation of film properties [78]. It was observed that the varying the ratios of silane (SiH_4), nitrous oxide (N_2O), and ammonia (NH_3), lead to the deposition of thin films of varying compositions. Properties including deposition rate, refractive index, and extinction index of the film were observed to improve with the increase in $\text{SiH}_4/\text{N}_2\text{O}$ (NH_3) ratio. Although both SiN and SiON have their advantages, SiN films are used for semiconductor applications due to their higher capacitance density, breakdown voltage and particle performance (**Figure 6A–C**) [63, 73, 80]. Silicon carbide, which has a high band gap and chemical inertness, is another material commonly deposited using PECVD. SiC is used widely as a material for MEMS devices due to its stability in harsh and high temperature environments [36, 81, 82]. PECVD, being a metal-compatible deposition method has been used for the deposition of $\alpha\text{-SiC}$ at 450°C using methane and silane precursor gases. Low frequency RF (40 Hz) power and pressure of range 700–1000 Torr, along with changes in the precursor ratios were utilized for the production of films of varying electrical

and mechanical properties. The results indicate the potential of the α -SiC films as structural components for devices that need stable residual film stress at high temperatures of operation [36]. Although the thin films of SiC have demonstrated promise in the development of high temperature withstanding MEMS devices, the increase in surface roughness in deposited thicker films remains an obstacle. Increasing the carbon content of the film in mixed frequency condition and decreasing the RF power was observed to decrease the surface roughness, making it a potential solution. Such methods pave the way for future studies on the influence of PECVD process parameters on the growth rate, morphology, and microstructure in the field of semiconductors.

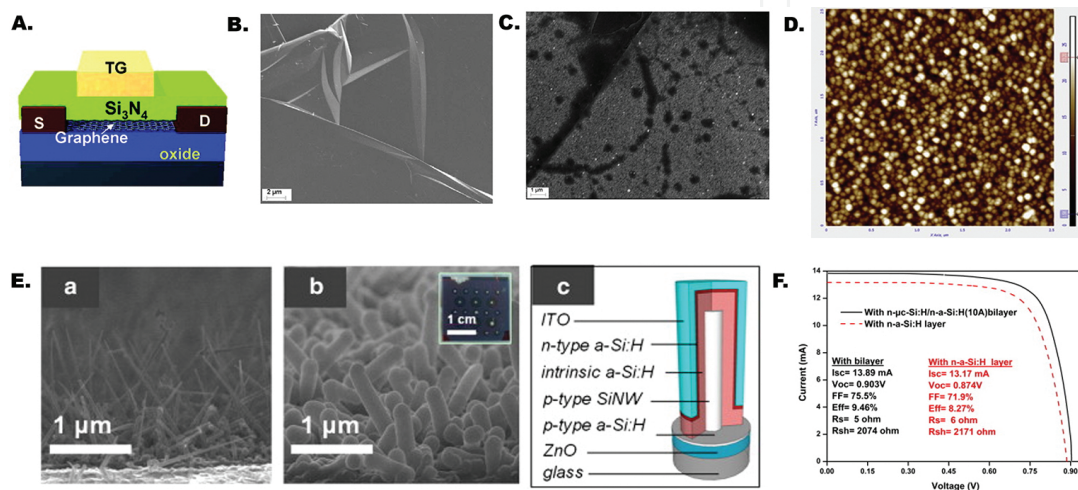

Figure 6. (A) Schematic representation of graphene FET device with silicon nitride coating. (B and C) SEM images of silicon nitride and silicon oxide deposited on graphene (A, B and C: reprinted with permission from [80] © 2010 ACS). (D) 2D surface morphology of n- μ c-Si: H layer used in single junction a-Si solar cells [83]. (E) SEM images of p-type Silicon nanowires using PECVD on a glass substrate (Sn catalyzed, 600°C). (F) Deposition of a conformal intrinsic and n-type a-Si:H after a temperature drop of 175°C using PECVD. (G) Schematic representation of a PIN radial junction. (Reprinted with permission [84], © 2011 Elsevier). (H) I-V characteristics of solar cells with n-a-Si: H layer and n- μ c-Si:H/n-a-Si: H bilayer (F and G: reprinted with permission [83], © 2015 Solar Energy).

3.1.2. Solar cells

Various deposition techniques such as PVD, CVD, oxidation, plating, and spin-coating have been used extensively for the deposition of silicon thin films with good photoelectric properties [85]. Currently, the photovoltaic market is dominated by crystalline silicon cells, which accounted for nearly 95% of world's photovoltaic cell and module production in 2004 [85, 86]. PECVD is widely used in the microelectronics and solar cell production, specifically for the deposition of thin films from a mixture of gas-phase species onto a solid substrate [87]. There has been a continuous effort to establish the process conditions to improve the film quality and the rate of deposition. PECVD at 60 MHz excitation frequency is now used extensively in large area thin film technology and industrial applications [83, 88, 89].

An increase in growth rate (going up from 1.5 to 4 nm s⁻¹) was obtained by switching from a low pressure (2–4 Torr) conventional RF plasma (13.56 MHz) to a 60 MHz excited plasma-

assisted CVD was observed by Matsuda et al. and by several other research groups [88, 89]. The crystallinity of the deposited silicon plays a vital role in the film properties. It has been observed that even high quality amorphous silicon solar cells have very low efficiency in trapping light when compared to crystalline counterparts, which has led to various studies to improve solar power conversion (**Figure 6F**) [83]. Several groups have worked on the transformation of the silicon thin film from amorphous to nanocrystalline in the presence of nonthermal SiH₄/H₂ plasmas. The interactions between the hydrogen atoms of the plasma and the solid silicon matrix determine the crystallinity and other properties of the thin films. The presence of H atoms in between the strained Si-Si bonds led to the disordered-to-ordered transitions [70, 71]. The deposition parameters such as chamber pressure (P_r), gas mixture composition, and flow rates, RF power density (P_w), and substrate temperature can be varied to obtain the desired film properties, including the crystallinity [69, 70]. Microdoping is another process used for the betterment of optical, electrical and structural properties of a microcrystalline silicon film for solar cell applications. The effect of boron microdoping through PECVD at high temperature and very high frequency (VHF, 60 MHz) PECVD at 200°C with a varying diborane flow rate of 0.00–0.30 sccm has been studied [90, 91]. Improved dark current flow and conductivity changes up to 10 orders of magnitude were observed upon boron doping was observed in these studies and could subsequently be used to improve solar conversion efficiency.

Another area where PECVD has been used extensively is the deposition of a passivation layer, which involves a shielding outer-layer deposited as a microcoating. In microelectronics and photovoltaics, a passivating layer can reduce surface recombination, which is a significant cause of losses in solar cells. Hydrogen atoms play an important role in the termination and passivation of silicon dangling bonds [70, 92]. Hydrogenated amorphous and nanocrystalline silicon films produced by PECVD are now widely being used in electronic and optoelectronic devices [70, 89]. Also, nanostructures have been used extensively to improve efficiency of solar cells in the recent times. One example is the use of silicon nanowires to improve the light-trapping in low-cost silicon photovoltaic cells (**Figure 6E**) [84, 93]. The growth of radial junctions of hydrogenated amorphous silicon over p-doped crystalline silicon nanowires on a glass substrate using PECVD (single pump) and Sn catalysts has demonstrated a considerable increase in the dark current and conversion efficiencies [84]. Silicon solar cells produced on flexible plastic substrates at an optimum deposition temperature of ~200°C, typically are cheap and robust [61, 94, 95].

3.1.3. *Optically active films*

Thin films with dye molecules are used in laser cavities, optical filters, and optical gas sensors [96–98]. Such thin films are synthesized using wet and sublimation techniques. PECVD avoids the harsh (chemical and temperature) and multistep process of these fabrication methods and can be used to deposit optically active thin films with tailorable properties. The deposition involves a partial polymerization of dye molecules that are evaporated over a substrate while exposed to an arc plasma. Ultrathin highly planar films (~100 nm) with controlled gradation of color were synthesized using the PECVD process. Such films can be used in development

of photonic materials and devices such as sensors, and wavelength couplers [99, 100]. Plasma polymerization of fluorine-containing materials yield many properties such as low dielectric constant and refractive index, low surface energy, low coefficient of friction, low permeability constant, and good biocompatibility [23, 101]. Fabrication of thin films using plasma homo- and copolymerization of octafluorocyclobutane (OFCB, C_4F_8) and hexamethyldisiloxane (HMDSO, $C_6H_{18}Si_2O$) using PECVD (RF at 13.56 MHz, power 20–45 W and pressure 0.001–1 Torr) were studied for their optical properties [23, 102]. Rare earth-doped optical materials is an area that has also garnered interest in the recent times, Pitt et al. report the synthesis of silicon-rich SiO_2 along with erbium doping. PECVD was used for the synthesis of such films due to low processing temperatures, ability of controlling stoichiometry, and growth conditions for the film. Microclusters of Si were found to be embedded in the erbium doped SiO_2 films demonstrating strong absorption peaks in the visible region along with the strong near IR fluorescence due to the erbium ions [97, 103].

3.1.4. Quantum dots

Silicon nanostructures have been found to exhibit luminescent properties, leading to many studies to understand them [63, 104]. Si-rich silicon nitride films have been grown by low frequency (440 kHz) PECVD using SiH_4 and NH_3 as reactant gases at a plasma power and a chamber pressure of 1000 W and 1500 mTorr, respectively. The total gas flow being 800 sccm, the ratio of NH_3/SiH_4 flows was changed between 2 and 10, and the flow rates were changed at a temperature of 370°C to get a different Si concentration in films. These kinds of films can be used in photovoltaic devices [105, 106].

3.2. Carbon-based nanostructures

Carbon-based nanostructures can be classified into 2D structures such as nanowalls, graphene, and 3D structures such as nanotubes and nanowires. Based on their morphological features and orientation, such nanostructures are used for different applications. For example, conical structures give higher mechanical and thermal stability when compared to narrow ones and the large surface area of nanowalls prove helpful in electrochemical devices and gas storage [107, 108]. The main drawback in the synthesis of these nanostructures is the absence of a controlled and deterministic method for depositing large-scale assemblies, which can be used in nanoelectronics, biological applications (probes), field emission displays, and radiation sources. PECVD can be used to address these difficulties and modifications of the deposition conditions produces different morphologies, location, and orientation-specific carbon nanostructures such as carbon nanotubes, diamond-like carbon (DLC) films deposited using microwave PECVD [108, 109]. However, the use of PECVD for the synthesis of DLC films is limited because of the issue of being unable to reach harder tetrahedral amorphous carbon state, due to the presence of hydrogen in the gaseous precursor [109].

Carbon nanotubes (CNTs) formed from graphene sheets have excellent electronic and mechanical properties. CNTs in the range of 1 nm in diameter and a few micrometers in length can be classified broadly as single-walled or multiwalled CNTs. Single-walled nanotubes (SWNTs) are known for their semiconductor properties and find applications in

high performance electronics. SWNTs have been grown by using RF PECVD (13.56 MHz, power ~ 75 W, low pressure) with methane as a precursor and metallic seed catalyst as shown in **Figure 5**. MW PECVD process with frequency of 2.45 GHz, pressure of 20 Torr, and power of 5 kW could also be used to produce SWNTs [45, 110]. Various parameters and factors involved in the process influence the preferential growth of the CNTs (**Figure 7**) [108, 110, 112]. Vertically oriented SWNTs have been synthesized, and this alignment is attributed to the strong electric field in a plasma sheath [44, 113]. Such CNTs can be used in various applications such as field emission devices and nanoscale electrochemical actuators [111, 113–115]. The formation of iron silicide (FeSi) roots on the Si substrate was observed to be helping in the formation of a base growth mode, which led to well-aligned CNTs deposition (**Figure 7B** and **C**) [114]. Recently, Bo et al. have reported the catalyst-free PECVD growth of graphene. The precursor was a volatile natural extract from the tea tree plant (*Melaleuca alternifolia*) [116]. The deposition rate was high and produced high quality graphene films without the presence of a catalyst. The graphene films at the end of this sustainable bottom up process, when tested yielded a high water contact angle of 135° , proving its potential use as a highly hydrophobic coating. Also, due to its mem-resistive behavior, such graphene could be used in the construction of memory devices [116].

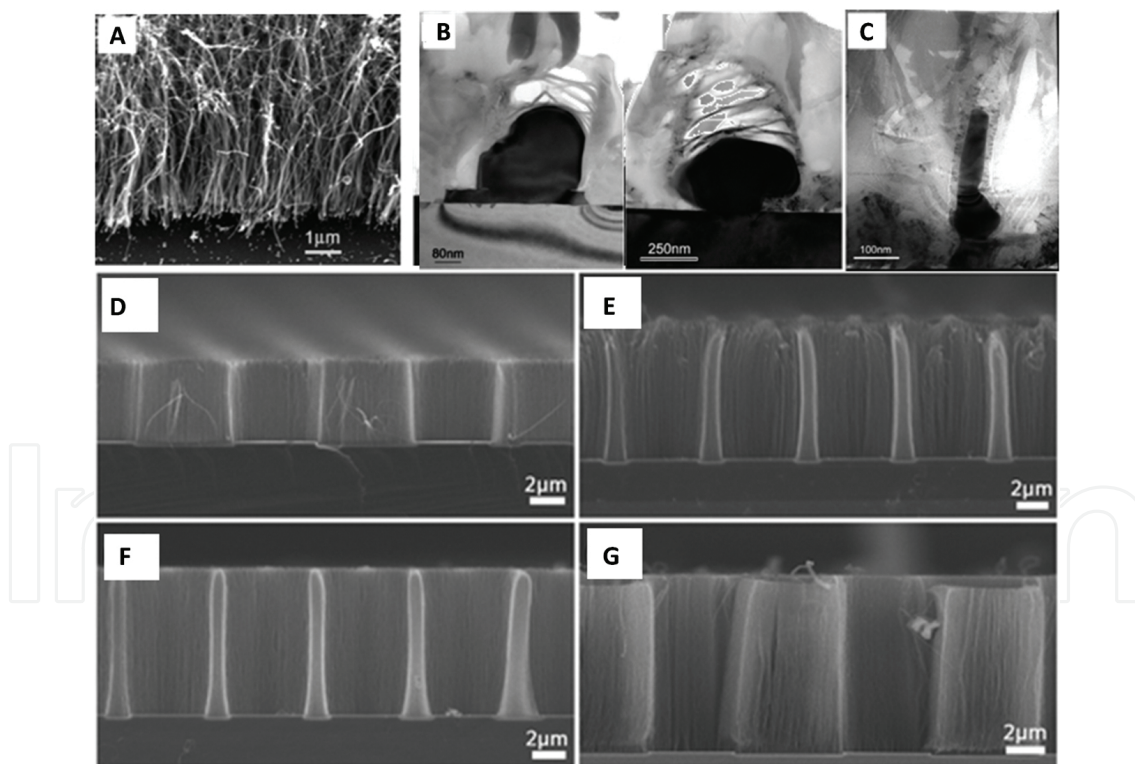

Figure 7. (A) SEM image of CNTs grown using microwave PECVD (4 nm Fe film as a catalyst). (B) TEM images of various possible shapes of catalyst at the CNT growth, i.e., not well attached to substrate and completely enclosed. (C) Elongation of catalyst particle in vertical direction moving from (A) and (B) (reprinted with permission from [113], © 2005 ACS). (D–G) CNTs deposited from different mixture ratios of H₂/C₂H₂. The flow rates of H₂/C₂H₂ were 140/2, 160/5, 140/5, and 180/10 sccm, respectively (reprinted with permission from [110], © 2015 Creative Commons Attribution (CC BY)).

Carbon nanowalls (CNWs) have been deposited using acetylene as precursors with iron as the catalyst. The growth parameters such as temperature, pressure, and gas flow rate were varied to get various samples of CNWs. The samples which displayed best field emission properties were the ones deposited at higher temperature and pressure (650°C with 120 sccm H₂ flow rate and a pressure of 300 Pa) [46, 112]. Graphene an allotrope of carbon is an example of 2D carbon nanostructure with extraordinary properties such as being 100 times stronger than steel and conducting heat and electricity with a nearly transparent sheet like morphology [117]. Graphene deposition for dielectrics is a challenge because of discontinuity in film formation. This can be compensated by the deposition of SiN by PECVD, which provides excellent coverage of graphene for preservation of their carrier mobility for application in FETs [80]. Their unique structural features, i.e., vertical orientation of the substrate without any agglomeration, sharp and exposed edges, and the controllable intersheet connectivity provide numerous advantages. These nanosheets can be deposited using PECVD on a variety of substrates using gas, solid, or liquid precursors [117]. Perpendicular orientation of the graphene sheets demonstrates better properties in comparison with conventional graphene films and is utilized for energy storage, sensors, and environmental applications. There are several unanswered questions in the development of carbon-based nanostructures by PECVD. Some of the unknowns involve the chemical species, or ions that are responsible for nanostructure growth, and their influence on the adhesion to the substrate, the rate determining step in their growth, and the effects of pressure and process parameters on the growth. Understanding some of these processes will help in the manipulation of the parameters to acquire required shape and orientation of carbon nanostructures and can lead to efficient large area deposition for various applications [108].

3.3. Titanium-based applications

Titanium has many applications due to its strength and low density and is used as an alloy, for thin film coatings, as substrates and photocatalysts. Its applications are wide-range and can be predominantly seen in medical prostheses (dental and orthoimplants), antimicrobial coatings, and electronic devices. RF PECVD has been most commonly used in the production of titanium thin films [118–123]. As a photocatalyst, titanium and its oxide (TiO₂) films have numerous applications such as antimicrobial activity, waste water treatment, and for biomedical implants. The antimicrobial activity of titanium-oxide-coated cotton textile substrates (**Figure 8A–C**) and glass substrates were tested against *E. coli*. The coatings were uniform and bacterial inhibition increased correspondingly with the increase in the refractive index of the film [118]. Titania powder has also been used for photocatalytic activities and this property was harnessed in the degradation of certain organic compounds, which could further be adapted for waste water treatment, but powders have lower efficiency due to crystalline defects. Although crystalline TiO₂ is more efficient, its surface area is not as high as powder. Hence, studies have been conducted to improve the surface area while retaining the crystallinity aspects of TiO₂. An excitation frequency of 40 kHz was employed in a cold-wall-type PECVD (precursor: titanium tetra-isopropoxide (Ti (O-*i*-C₃H₇)₄), and oxygen gas carrier flow rate: 50 sccm and reduced pressure conditions ~30 Pa) was used to produce crystalline TiO₂ particles, which had a high surface area (**Figure 8E**) and good photocatalytic properties [120].

The combination of PECVD deposited TiO₂ films with silver nanoparticles have been studied (Figure 8D) to characterize the films for their photolytic activity and antimicrobial property (silver is known for its antimicrobial activity). These films demonstrated good photochemical activity at nearly room temperature and could be used for heat-sensitive substrates [119]. PECVD can also be used for other material-based precursors and here are some examples and applications of such depositions: the mixtures of Ti (*O-i-C₃H₇*)₄ and oxygen can be used to produce amorphous TiO₂ thin films by PECVD. The dielectric properties of TiO₂ films were put to use by assuming that a TiO₂/SiO₂ bilayer would behave as two capacitors in series. The rate of deposition was observed to decrease with oxygen concentration and RF power and whereas an increase with equivalence ratio. The film thickness was seen to influence the dielectric constant of the film and it was pretty consistent, even in the presence of an interfacial SiO₂ layer [42].

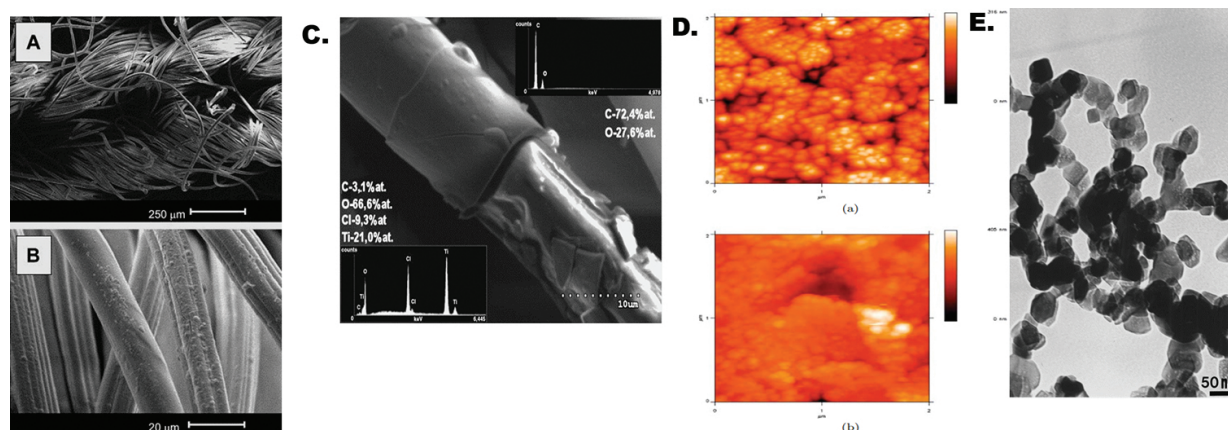

Figure 8. (A and B) Low and high magnifications SEM images of cotton knitwear deposited made of titanium oxide with RF PECVD (100 W). (C) SEM image of a single cotton fiber and it has been stripped partially. The EDX results in the two windows are for coated and uncoated fiber (reprinted with permission from [118], © 2005 Elsevier). (D) AFM pictures of the TiO₂/PECVD films made at (a) 300°C, (b) 40°C using PECVD (2 × 2 μm) (reprinted with permission from [119], © 2009 Springer). (E) TEM image of the TiO₂ powder produced using PECVD following treatment (800°C for 1.5 h) (reprinted with permission from [120], © 1999 Springer).

3.4. Biological applications

PECVD is a technique which operates at lower temperatures, suitable for the deposition of organic precursors, unlike other processes. Synthesized thin films are biocompatible, adherent, and flexible for applications such as implants [2, 65]. PECVD offers several advantages in case of deposition of ultrathin layers of macromolecular materials such as alcohols, carboxylic acids, acid chlorides, simple amines, anhydrides, and ethylene glycols [124–130]. The chemical reactivity of the deposited layer is generally based on the functional group density and various degrees of cross-link density. The chemical reactivity of these functional layers also determines shelf life of the resultant device. These plasma-polymerized thin films are utilized in various biological applications such as antimicrobial coatings, biomaterials, tissue engineering, implant coatings, and bioelectronics [2, 66, 67, 131].

3.4.1. Antimicrobial and antifouling

Antimicrobial surfaces are in demand owing to increase in bacterial colonization issues in medical devices, implants, and healthcare products. The lifetime of implanted prosthesis is brought down drastically due to bacterial infections, especially in immunocompromised patients. The use of antimicrobial surfaces has gained importance lately, because they do not lead to resistance (common example *Staphylococcus aureus* which is multidrug resistant). The PECVD process was an effective way of designing these surfaces because it can be used efficiently to control the coating properties and content of nanoparticles embedded. Biocidal activity of silver nanoclusters embedded in a PECVD deposited film is believed to be a result of effective progressive release of Ag ions from the nanoparticles in to the media surrounding it [119, 131–133]. In a recent study, polydimethylsiloxane (PDMS) surfaces were coated with PFM (pentafluorophenyl methacrylate) using PECVD with a continuous RF power (15 W), and pulsed plasma polymerization (DC of 0.5) for 3–5 min to produce a flexible and highly reactive surface with ester groups [134]. The incubation of these surfaces in an amine sugar (glucosamine) produced a controlled reductive surface capable of reducing silver salts to form micro- and nanostructured silver coatings. Gilabert et al. have demonstrated the antibacterial activity of such coatings due to their hydrophobic behavior which eliminated bacterial adhesion. The initial rapid release followed by a sustained release proved effective against *P. aeruginosa* and *S. aureus* bacterial adhesion but had no cytotoxic effects on the mammalian cell line (COS7 cells) when tested (Figure 9) [132]. Silver coatings are also commonly used on implants to avoid bacterial infections and biofilm formation [134].

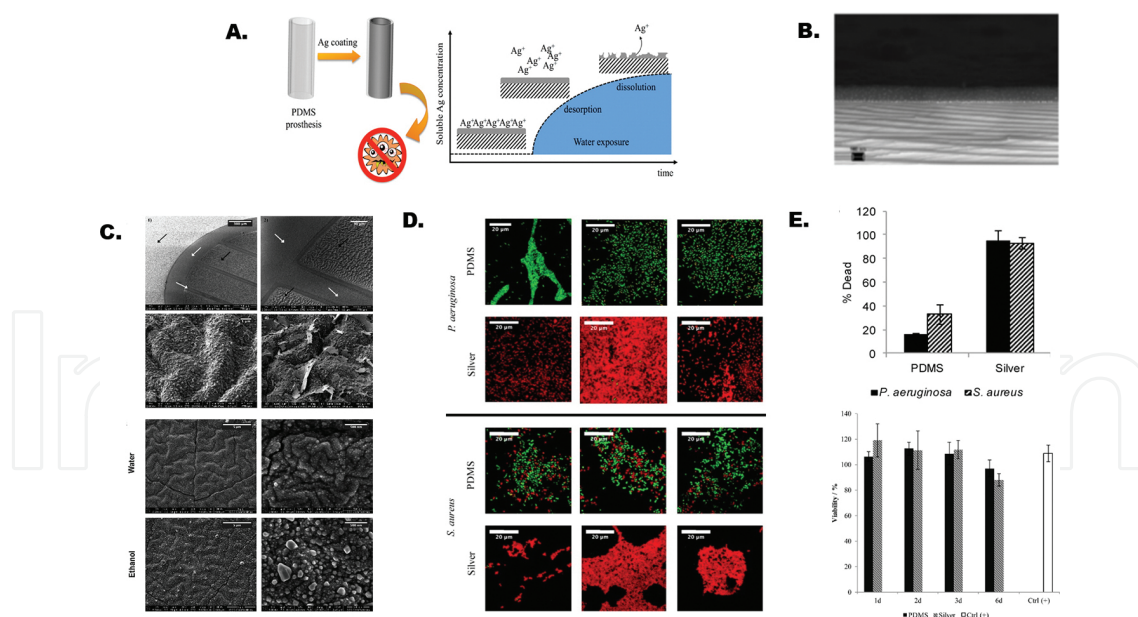

Figure 9. (A) Schematic representation of synthesis of highly hydrophobic silver nanoparticle surface and silver ion release (reprinted with permission from [132], © 2015 ACS). (B) Silver nanoparticles on silicon oxide layer, a product of APCVD plasma jet (SEM micrograph) (reprinted with permission from [131], © 2012 Wiley). (C) SEM images depicting the surface morphology of silver modified PDMS samples. (D) Confocal images showing the bacterial viability on non-coated (PDMS) and coated (silver) surfaces. (E) Antibacterial activity of coated (silver) and noncoated (PDMS) surfaces on two different strains (*P. aeruginosa* and *S. aureus*) and cell viability of COS-7 cell-line (C–E: reprinted with permission from [132], © 2015 ACS).

3.4.2. Wettability and cell adhesion

In biological systems, the hydrophobic and hydration forces play an important role in the mediation of solute, for instance, in the adsorption and adhesion of proteins and cells (**Figure 9B**) [135, 136]. Production of bioabsorbable materials is one main area where PECVD has been utilized [137–139]. The design and synthesis of various functional hybrid film systems for SiO_x film coatings with good mechanical properties at high deposition rates were reported. These SiO_x surfaces are known for their hydrophilic and smooth properties that can be modified using plasma treatment [139, 140]. The deposition of SiO_x films on poly (lactic acid) (PLA) substrate was synthesized by Chaiwong et al. using octamethylcyclotetrasiloxane (OMCTS: Si₄O₄C₈H₂₀) as the precursor and oxygen as carrier gas. Oxygen plasma treatment after deposition enhanced the wettability of the surface leading to an increased BSA protein adsorption and cell adhesion (preosteoblasts, fibroblasts) [139].

3.4.3. Biosensors

Disease diagnosis using biosensors requires functionalization of sensors' surfaces with specific antigens to detect required biomolecules. Typically, biosensors use functionally modified polymer surfaces to immobilize proteins. Use of chemical synthesis methods is time consuming, complicated, and quality of film is difficult to control during the process. PECVD, being a single-step process, provides a venue to overcome some of these obstacles. Multiple studies have used PECVD for the deposition of various end-groups such as amines, carboxylic, mercapto, epoxy, and polyethylene glycol to address the problem of nonspecific binding of single-stranded DNA or other proteins of interest. Parameters such as higher RF power lead to increase in thickness of the film due to increased rate of deposition [140, 141]. Monomers such as amino silanes, allylamine, and allyl organophosphates have been commonly used for the deposition of thin films with reactive functional groups [58, 127].

3.4.4. Bioimplants

Hydroxyapatite (HA) is a major mineral component of natural bone that can readily integrate with human tissues within just a short period after implantation. Therefore, it is widely used in bone and dental implants. Although it has multiple advantages, it has poor mechanical strength and load bearing capacity. Hence, it is used predominantly as a coating on metallic implants [142–144]. Some studies have shown that the inclusion of HA along with titanium in a plasma sputtering process promotes the formation of calcium titanate, which largely contributes to the adhesive strength between the alloy and the film. The structure and morphology of the coatings were controlled using plasma parameters such as DC substrate bias. It was observed that at higher DC (negative) bias voltages, the calcium oxide (CaO), and calcium titanate (CaTiO₃) phase concentrations in the bioceramic coating increased. This means that the change (increase) in DC bias in turn increased the ion flux (CaO⁺) leading to the increased presence of CaO and CaTiO₃ phases, and hence the biocompatibility (positive biomimetic response). Plasma-assisted RF magnetron sputtering deposition is also an efficient way of coating TiAlV orthopedic alloys with HA or any calcium phosphate-based mineral (**Figure 10A**) [144].

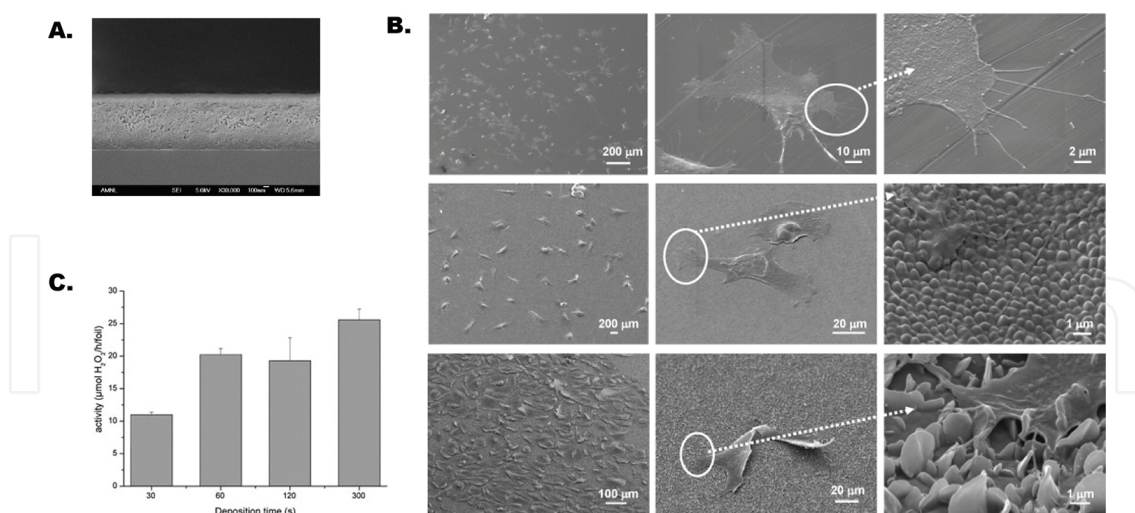

Figure 10. (A) SEM image of RF plasma deposited (RF power = 500 W). Calcium phosphate bioceramic film (1.2 μm) on an alloy ($\text{Ti}_6\text{Al}_4\text{V}$) as a bioimplant coating (reprinted with permission from [144], © 2007 Wiley). (C) Activity of immobilized GO_x in polyacetylene coating on plastic foil (AP-PECVD) after different times of deposition (reprinted with permission from [40], © 2011 Wiley). (B) SEM images of cell and PECVD deposited material interactions. Cell spreading based on surface roughness confirms the dependence of the cell behavior on surface topography (reprinted with permission from [145], © ACS).

3.4.5. Food preservation and bioactive coatings

Spoilage is a major problem in the food industry and various studies are trying to address this issue. Quintieri et al. used PECVD to coat bovine lactoferrin (BLF) and lactoferricin B (LfcinB) against spoilage by *Pseudomonas* strains. In one study, BLF and LfcinB were evaluated for their antimicrobial activity, when immobilized on plasma deposited films of ethylene/acrylic acid (pdEthAA) [146]. RF plasma with different input power, two fragmentation levels in plasma feed, and different $-\text{COOH}$ group densities were used during the coatings, to vary the amount of LfcinB and BLF immobilization on the films [146]. Heyse et al. have reported the use of APCVD to form bioactive coatings (using enzymes, proteins, and other organic precursors) [40]. Though the temperature range during deposition did not exceed 32°C , the radical chemistry due to the plasma had harsh effects on the enzymes. There was considerable effort to minimize the effect, by atomizing the enzyme solution and encompassing it in water shell ("nano shuttle" formation) which subsequently protected the enzyme from the harsh plasma conditions. These enzymes were further trapped in the growing polymer network of organic polymers acetylene or pyrrole giving rise to bioactive films. The films formed using enzymes such as glucose oxide (GO_x) (Figure 10C) and lipase were successfully used in sensor and catalysis applications. They tested it on other sensitive and hyperthermophilic proteins such as allophycocyanin and Apase [40].

The PECVD technique, as discussed has been used for a broad range of applications from photovoltaics, biological, to semiconductors. Most recently, this technique has been used in several instances where barrier properties were required for the encapsulation of organic light-emitting devices (OLED) by silicon oxide (SiO_x) and nickel oxide (NiO_x) PECVD-deposited films, organic electronic fabrication, and anticorrosive coatings. Room temperature deposition

of polymer-like carbon films (PLC) for gate dielectric applications in organic thin film transistors has also reported [148]. Improvements in the encapsulation process of various materials utilizing PECVD can lead to potential advancements in the research area of PECVD-based encapsulation. [147]. Other areas such as anticorrosion coating of metallic substrates such as copper via plasma polymeric films of dicyclopentadiene (DCPD) films is an area of future research [149]. Tailoring the surface properties of organic materials to become suitable for biomedical applications is another area in which PECVD holds promise for future applications [150].

Acknowledgements

The authors would like to acknowledge the Provost's office at the University of Dartmouth and AFOSR.

Author details

Yasaman Hamedani¹, Prathyushakrishna Macha¹, Timothy J. Bunning², Rajesh R. Naik² and Milana C. Vasudev^{1*}

*Address all correspondence to: mvasudev@umassd.edu

1 Department of Bioengineering, University of Massachusetts at Dartmouth, Dartmouth, MA, USA

2 Air Force Research Laboratory, Wright Patterson AFB, Dayton, OH, USA

References

- [1] Das D, Banerjee A. Further improvements of nano-diamond structures on unheated substrates by optimization of parameters with secondary plasma in MW-PECVD. *Surface and Coatings Technology*. 2015;272:357–65.
- [2] Vasudev MC, Anderson KD, Bunning TJ, Tsukruk VV, Naik RR. Exploration of plasma-enhanced chemical vapor deposition as a method for thin-film fabrication with biological applications. *ACS Applied Materials & Interfaces*. 2013;5(10):3983–94.
- [3] Yagüe JL, Coclite AM, Petruczok C, Gleason KK. Chemical vapor deposition for solvent-free polymerization at surfaces. *Macromolecular Chemistry and Physics*. 2013;214(3):302–12.

- [4] Eichfeld SM, Hossain L, Lin Y-C, Piasecki AF, Kupp B, Birdwell AG, et al. Highly scalable, atomically thin WSe₂ grown via metal-organic chemical vapor deposition. *ACS Nano*. 2015;9(2):2080-7.
- [5] Pierson HO. *Handbook of Chemical Vapor Deposition (CVD): Principles, Technology and Applications*. Park Ridge, NJ: Noyes Publication; 1992.
- [6] Stoffel A, Kovács A, Kronast W, Müller B. LPCVD against PECVD for micromechanical applications. *Journal of Micromechanics and Microengineering*. 1996;6(1):1.
- [7] Li X-L, Ge J-P, Li Y-D. Atmospheric pressure chemical vapor deposition: an alternative route to large-scale MoS₂ and WS₂ inorganic fullerene-like nanostructures and nanoflowers. *Chemistry – A European Journal*. 2004;10(23):6163-71.
- [8] Poole KM. Electrode contamination in electron optical systems. *Proceedings of the Physical Society Section B*. 1953;66(7):542.
- [9] Ennos AE. The source of electron-induced contamination in kinetic vacuum systems. *British Journal of Applied Physics*. 1954;5(1):27-31.
- [10] Alt LL, Ing SW, Laendle KW. Low-temperature deposition of silicon oxide films. *Journal of the Electrochemical Society*. 1963;110(5):465.
- [11] Christy RW. Formation of thin polymer films by electron bombardment. *Journal of Applied Physics*. 1960;31(9):1680-3.
- [12] Baker AG, Morris WC. Deposition of metallic films by electron impact decomposition of organometallic vapors. *Review of Scientific Instruments*. 1961;32(4):458.
- [13] Christy RW. Conducting thin films formed by electron bombardment of substrate. *Journal of Applied Physics*. 1962;33(5):1884-8.
- [14] Ing SW, Davern W. Use of low-temperature deposited silicon dioxide films as diffusion masks in GaAs. *Journal of the Electrochemical Society*. 1964;111(1):120-2.
- [15] Ing SW, Davern W. Glow discharge formation of silicon oxide and the deposition of silicon oxide thin film capacitors by glow discharge techniques. *Journal of the Electrochemical Society*. 1965;112(3):284-8.
- [16] Wertheimer MR. Plasma processing and polymers: a personal perspective. *Plasma Chemistry and Plasma Processing*. 2013;34(3):363-76.
- [17] Reinberg AR. Extended Abstracts. The Electrochemical Society Meeting, San Francisco, CA, May 12-17, 1974.
- [18] Reinberg AR. Inventor, Patent No. US3757733 A, 1973.
- [19] Pierson HO. *Handbook of Chemical Vapor Deposition (CVD)*. 2nd Ed. Norwich, NY: William Andrew Publishing; 1999. p. iii.

- [20] Vasudev MC, Koerner H, Singh KM, Partlow BP, Kaplan DL, Gazit E, et al. Vertically aligned peptide nanostructures using plasma-enhanced chemical vapor deposition. *Biomacromolecules*. 2014;15(2):533–40.
- [21] Anderson KD, Slocik JM, McConney ME, Enlow JO, Jakubiak R, Bunning TJ, et al. Facile plasma-enhanced deposition of ultrathin crosslinked amino acid films for conformal biometallization. *Small*. 2009;5(6):741–9.
- [22] Inagaki N. *Plasma Surface Modification and Plasma Polymerization*. Boca Raton, FL: CRC Press (Taylor and Francis group); 1996.
- [23] Jiang H, Eyink K, Grant JT, Enlow J, Tullis S, Bunning TJ. PECVD siloxane and fluorine-based copolymer thin films. *Chemical Vapor Deposition*. 2008;14(9–10):286–91.
- [24] Singamaneni S, LeMieux MC, Lang HP, Gerber C, Lam Y, Zauscher S, et al. Bimaterial microcantilevers as a hybrid sensing platform. *Advanced Materials*. 2008;20(4):653–80.
- [25] Anderson KD, Young SL, Jiang H, Jakubiak R, Bunning TJ, Naik RR, et al. Plasma-enhanced copolymerization of amino acid and synthetic monomers. *Langmuir*. 2012;28(3):1833–45.
- [26] Enlow JO, Jiang H, Grant JT, Eyink K, Su W, Bunning TJ. Plasma polymerized ferrocene films. *Polymer*. 2008;49(19):4042–5.
- [27] Schulz U. Coating processes for plastic optics. *Advanced Optical Technologies*. 2014;3(1):29–39.
- [28] Rossmann K. Improvement of bonding properties of polyethylene. *Journal of Polymer Science*. 1956;19(91):141–4.
- [29] Wertheimer MR, Martinu L, Klemberg-Sapieha JE, Czeremuszkin G. In Mittal KL, Pizzi A, editors. *Adhesion Promotion Techniques in Advanced Technologies*. New York: Marcel Dekker; 1998.
- [30] Nisol B, Reniers F. Challenges in the characterization of plasma polymers using XPS. *Journal of Electron Spectroscopy and Related Phenomena*. 2015;200:311–31.
- [31] Osada Y, Biederman H, editors. *Plasma Polymerization Processes*. Amsterdam: Elsevier Science and Technology Books; 1992. ISBN: 9780444887245.
- [32] Peri SR, Habersberger B, Akgun B, Jiang H, Enlow J, Bunning TJ, et al. Variations in cross-link density with deposition pressure in ultrathin plasma polymerized benzene and octafluorocyclobutane films. *Polymer*. 2010;51(19):4390–7.
- [33] Kramer PW, Yeh YS, Yasuda H. Low temperature plasma for the preparation of separation membranes. *Journal of Membrane Science*. 1989;46(1):1–28.
- [34] Merche D, Vandencastele N, Reniers F. Atmospheric plasmas for thin film deposition: a critical review. *Thin Solid Films*. 2012;520(13):4219–36.
- [35] Yasuda H. *Plasma Polymerization*. New York: Academic Press; 1985.

- [36] Peri B, Borah B, Dash RK. Effect of RF power and gas flow ratio on the growth and morphology of the PECVD SiC thin films for MEMS applications. *Bulletin of Materials Science*. 2015;38(4):1105–12.
- [37] Dams R, Vangeneugden D, Vanderzande D. Plasma deposition of thiophene derivatives under atmospheric pressure. *Chemical Vapor Deposition*. 2006;12(12):719–27.
- [38] Schutze A, Jeong JY, Babayan SE, Park J, Selwyn GS, Hicks RF. The atmospheric-pressure plasma jet: a review and comparison to other plasma sources. *IEEE Transactions on Plasma Science*. 1998;26(6):1685–94.
- [39] Groenewoud LMH, Engbers GHM, White R, Feijen J. On the iodine doping process of plasma polymerised thiophene layers. *Synthetic Metals*. 2001;125(3):429–40.
- [40] Heyse P, Van Hoeck A, Roeffaers MB, Raffin JP, Steinbüchel A, Stöveken T, et al. Exploration of Atmospheric pressure plasma nanofilm technology for straightforward bio-active coating deposition: enzymes, plasmas and polymers, an elegant synergy. *Plasma Processes and Polymers*. 2011;8(10):965–74.
- [41] Da Ponte G, Sardella E, Fanelli F, Paulussen S, Favia P. Atmospheric pressure plasma deposition of poly lactic acid-like coatings with embedded elastin. *Plasma Processes and Polymers*. 2014;11(4):345–52.
- [42] Nozaki T, Ohnishi K, Okazaki K, Kortshagen U. Fabrication of vertically aligned single-walled carbon nanotubes in atmospheric pressure non-thermal plasma CVD. *Carbon*. 2007;45(2):364–74.
- [43] Barankin MD, Gonzalez Ii E, Ladwig AM, Hicks RF. Plasma-enhanced chemical vapor deposition of zinc oxide at atmospheric pressure and low temperature. *Solar Energy Materials and Solar Cells*. 2007;91(10):924–30.
- [44] Babayan SE, Jeong JY, Tu VJ, Park J, Selwyn GS, Hicks RF. Deposition of silicon dioxide films with an atmospheric-pressure plasma jet. *Plasma Sources Science and Technology*. 1998;7(3):286.
- [45] Hiramatsu M, Hori M. Aligned growth of single-walled and double-walled carbon nanotube films by control of catalyst preparation. *Japanese Journal of Applied Physics*. 2011;46(2):12–16.
- [46] Shiji K, Hiramatsu M, Enomoto A, Nakamura M, Amano H, Hori M. Vertical growth of carbon nanowalls using rf plasma-enhanced chemical vapor deposition. *Diamond and Related Materials*. 2005;14(3–7):831–4.
- [47] Kogelschatz U. Dielectric-barrier discharges: their history, discharge physics, and industrial applications. *Plasma Chemistry and Plasma Processing*. 2003;23(1):1–46.
- [48] Jiang H, Johnson WE, Grant JT, Eyink K, Johnson EM, Tomlin DW, et al. Plasma polymerized multi-layered photonic films. *Chemistry of Materials*. 2003;15(1):340–7.

- [49] Tibbitt JM, Bell AT, Shen M. Dielectric relaxations in plasma-polymerized hydrocarbons and fluorocarbons. *Journal of Macromolecular Science: Chemistry*. 1976;A10:519–33.
- [50] Beshkov G, Lei S, Lazarova V, Nedev N, Georgiev SS. IR and Raman absorption spectroscopic studies of APCVD, LPCVD and PECVD thin SiN films. *Vacuum*. 2002;69(1–3):301–5.
- [51] Sawa G, Morita S, Ieda M. Dielectric properties of polystyrene formed in a glow discharge. *Journal of Polymer Science Polymer Physics Edition*. 1974;12:1231.
- [52] Zhang X, Chen K-S, Mark Spearing S. Thermo-mechanical behavior of thick PECVD oxide films for power MEMS applications. *Sensors and Actuators A: Physical*. 2003;103(1–2):263–70.
- [53] Domínguez C, Rodríguez JA, Muñoz FJ, Zine N. The effect of rapid thermal annealing on properties of plasma enhanced CVD silicon oxide films. *Thin Solid Films*. 1999;346(1–2):202–6.
- [54] Olbrechts B, Raskin J-P. PECVD oxide as intermediate film for wafer bonding: Impact of residual stress. *Microelectronic Engineering*. 2010;87(11):2178–86.
- [55] Richter F, Schaarschmidt G, Franke DW, Wallendorf T, Rau B. Analysis of the growth process of a-C:H layers. *Diamond and Related Materials*. 1993;2(10):1344–9.
- [56] Perrin J. Plasma and surface reactions during a-Si:H film growth. *Journal of Non-Crystalline Solids*. 1991;137–138(Part 2):639–44.
- [57] Denaro AR, Owens PA, Crawshaw A. Glow discharge polymerization—styrene. *European Polymer Journal*. 1968;4(1):93–106.
- [58] Michelmore A, Whittle J, Short R. The importance of ions in low pressure PECVD plasmas. *Frontiers in Physics*. 2015;3:3.
- [59] Gordillo-Vazquez FJ, Herrero VJ, Tanarro I. From carbon nanostructures to new photoluminescence sources: an overview of new perspectives and emerging applications of low-pressure PECVD. *Chemical Vapor Deposition*. 2007;13(6–7):267–79.
- [60] Jérôme P, Jacques S, Christoph H, Alan H, Laurent S. The physics of plasma-enhanced chemical vapour deposition for large-area coating: industrial application to flat panel displays and solar cells. *Plasma Physics and Controlled Fusion*. 2000;42(12B):B353.
- [61] Shah A, Torres P, Tscharnner R, Wyrsh N, Keppner H. Photovoltaic technology: the case for thin-film solar cells. *Science*. 1999;285(5428):692–8.
- [62] Late DJ, Liu B, Matte HR, Dravid VP, Rao C. Hysteresis in single-layer MoS₂ field effect transistors. *Acs Nano*. 2012;6(6):5635–41.

- [63] Binetti S, Acciarri M, Bollani M, Fumagalli L, Von Känel H, Pizzini S. Nanocrystalline silicon films grown by low energy plasma enhanced chemical vapor deposition for optoelectronic applications. *Thin Solid Films*. 2005;487(1):19–25.
- [64] O'Mara WC. *Liquid Crystal Flat Panel Displays: Manufacturing Science & Technology*. New York: Chapman & Hall; 1993.
- [65] Förch R, Chifen AN, Bousquet A, Khor HL, Jungblut M, Chu LQ, et al. Recent and expected roles of plasma-polymerized films for biomedical applications. *Chemical Vapor Deposition*. 2007;13(6–7):280–94.
- [66] Pryce Lewis HG, Edell DJ, Gleason KK. Pulsed-PECVD films from hexamethylcyclotrisiloxane for use as insulating biomaterials. *Chemistry of Materials*. 2000;12(11):3488–94.
- [67] Tang L, Wu Y, Timmons RB. Fibrinogen adsorption and host tissue responses to plasma functionalized surfaces. *Journal of Biomedical Materials Research*. 1998;42(1):156–63.
- [68] Sherman S, Wagner S, Mucha J, Gottscho RA. Substrate effect on plasma-enhanced chemical vapor deposited silicon nitride. *Journal of the Electrochemical Society*. 1997;144(9):3198–204.
- [69] Martins R, Aguas H, Cabrita A, Tonello P, Silva V, Ferreira I, et al. New nanostructured silicon films grown by PECVD technique under controlled powder formation conditions. *Solar Energy*. 2001;69:263–9.
- [70] Sriraman S, Agarwal S, Aydil ES, Maroudas D. Mechanism of hydrogen-induced crystallization of amorphous silicon. *Nature*. 2002;418(6893):62–5.
- [71] Marra DC, Edelberg EA, Naone RL, Aydil ES. Silicon hydride composition of plasma-deposited hydrogenated amorphous and nanocrystalline silicon films and surfaces. *Journal of Vacuum Science & Technology*. 1998:3199–210.
- [72] Kessels W, Smets A, Marra D, Aydil E, Schram D, Van De Sanden M. On the growth mechanism of a-Si: H. *Thin Solid Films*. 2001;383(1):154–60.
- [73] Martin-Palma RJ, Gago R, Torres-Costa V, Fernandez-Hidalgo P, Kreissig U, Martinez Duart JM. Optical and compositional analysis of functional SiO_xCy:H coatings on polymers. *Thin Solid Films*. 2006:2493–6.
- [74] Service RF. Patterning electronics on the cheap. *Science (Washington, DC)*. 1997;278(5337):383–4.
- [75] Kim KN, Lee SM, Mishra A, Yeom GY. Atmospheric pressure plasmas for surface modification of flexible and printed electronic devices: a review. *Thin Solid Films*. 2016;598:315–34.
- [76] Fanelli F. Thin film deposition and surface modification with atmospheric pressure dielectric barrier discharges. *Surface and Coatings Technology*. 2010;205(5):1536–43.

- [77] Seo HJ, Nam S-H, Kim S, Boo J-H. Organic and organic–inorganic hybrid polymer thin films deposited by PECVD using TEOS and cyclohexene for ULSI interlayer-dielectric application. *Applied Surface Science*. 2015;354:134–8.
- [78] Chu S-M, Louh T, Yang L-W, Yang T, Chen K-C, editors. Capacitance density and breakdown voltage improvement by optimizing the PECVD dielectric film characteristics in metal insulator metal capacitors-Chin-Tsan Yeh. In *Joint e-Manufacturing and Design Collaboration Symposium (eMDC) & 2015 International Symposium on Semiconductor Manufacturing (ISSM)*, 2015. IEEE; 2015.
- [79] Bae I-S, Cho S-H, Lee S-B, Kim Y, Boo J-H. Growth of plasma-polymerized thin films by PECVD method and study on their surface and optical characteristics. *Surface and Coatings Technology*. 2005;193(1):142–6.
- [80] Zhu W, Neumayer D, Perebeinos V, Avouris P. Silicon nitride gate dielectrics and band gap engineering in graphene layers. *Nano Letters*. 2010;10(9):3572–6.
- [81] Young DJ, Du J, Zorman CA, Ko WH. High-temperature single-crystal 3C-SiC capacitive pressure sensor. *Sensors Journal, IEEE*. 2004;4(4):464–70.
- [82] LaBarbera MA, Zorman CA, Scardelletti MC, editors. Long-term thermal mechanical stability of PECVD amorphous silicon carbide films for harsh environment microelectromechanical systems. In *Sensors*. Cleveland, OH: Case Western Reserve University; 2014.
- [83] Mandal S, Dhar S, Das G, Mukhopadhyay S, Barua A. Development of optimized n- μ c-Si: H/na-Si: H bilayer and its application for improving the performance of single junction a-Si solar cells. *Solar Energy*. 2016;124:278–86.
- [84] O'Donnell B, Yu L, Foldyna M, Cabarrocas PRI. Silicon nanowire solar cells grown by PECVD. *Journal of Non-Crystalline Solids*. 2012;358(17):2299–302.
- [85] Yamamoto K, Yoshimi M, Tawada Y, Okamoto Y, Nakajima A. Cost effective and high-performance thin film Si solar cell towards the 21st century. *Solar Energy Materials and Solar Cells*. 2001;66(1):117–25.
- [86] Maycock PD. PV review: world solar PV market continues explosive growth. *Refocus*. 2005;6(5):18–22.
- [87] Parsons R, Vossen JL, Kern W. Sputter deposition processes. *Thin Film Processes II*. 1991;2:177.
- [88] Peng S, Wang D, Yang F, Wang Z, Ma F. Grown low-temperature microcrystalline silicon thin film by VHF PECVD for thin films solar cell. *Journal of Nanomaterials*. 2015;2015:88.
- [89] Kondo M, Fukawa M, Guo L, Matsuda A. High rate growth of microcrystalline silicon at low temperatures. *Journal of Non-Crystalline Solids*. 2000;266:84–9.

- [90] Juneja S, Sudhakar S, Gope J, Lodhi K, Sharma M. Highly conductive boron doped micro/nanocrystalline silicon thin films deposited by VHF-PECVD for solar cell applications. *Journal of Alloys and Compounds*. 2015;643:94–9.
- [91] Engelhardt J, Frey A, Mahlstaedt L, Gloger S, Hahn G, Terheiden B. Boron emitters from doped PECVD layers for n-type crystalline silicon solar cells with LCO. *Energy Procedia*. 2014;55:235–40.
- [92] Matsuda A. Formation kinetics and control of microcrystallite in $\mu\text{c-Si:H}$ from glow discharge plasma. *Journal of Non-Crystalline Solids*. 1983;59:767–74.
- [93] Norris KJ, Garrett MP, Zhang J, Coleman E, Tompa GS, Kobayashi NP. Silicon nanowire networks for multi-stage thermoelectric modules. *Energy Conversion and Management*. 2015;96:100–4.
- [94] Rath J, Brinza M, Liu Y, Borreman A, Schropp R. Fabrication of thin film silicon solar cells on plastic substrate by very high frequency PECVD. *Solar Energy Materials and Solar Cells*. 2010;94(9):1534–41.
- [95] Street R. Large area electronics, applications and requirements. *Physica Status Solidi (a)*. 1998;166(2):695–705.
- [96] Yang P, Wernsberger G, Huang HC, Cordero SR, McGehee MD, Scott B, et al. Mirrorless lasing from mesostructured waveguides patterned by soft lithography. *Science*. 2000;287(5452):465–7.
- [97] Yang C-C, Lin Y-H, Lin G-R, editors. Nonstoichiometric $\text{Si}_{1-x}\text{Ge}_x$ based tunable saturable absorber for mode-locked erbium-doped fiber laser. In *CLEO. OSA Technical Digest [online]*. Optical Society of America; 2015. Paper JW2A.70.
- [98] Loerke J, Marlow F. Laser emission from dye-doped mesoporous silica fibers. 2002;14(23):1745–9.
- [99] Burt MC, Dave BC. An optical temperature sensing system based on encapsulation of a dye molecule in organosilica sol–gels. *Sensors and Actuators B: Chemical*. 2005;107(2):552–6.
- [100] Barranco A, Aparicio F, Yanguas-Gil A, Groening P, Cotrino J, González-Elipe AR. Optically active thin films deposited by plasma polymerization of dye molecules. *Chemical Vapor Deposition*. 2007;13(6–7):319–25.
- [101] Limb SJ, Lau KK, Edell DJ, Gleason EF, Gleason KK. Molecular design of fluorocarbon film architecture by pulsed plasma enhanced and pyrolytic chemical vapor deposition. *Plasmas and Polymers*. 1999;4(1):21–32.
- [102] Chen K-S, Yang M-R, Hsu ST. Fabrication and characterization of fluorine-containing films using plasma polymerization of octafluorotoluene. *Materials Chemistry and Physics*. 1999;61(3):214–8.

- [103] Kenyon A, Trwoga P, Federighi M, Pitt C. Optical properties of PECVD erbium-doped silicon-rich silica: evidence for energy transfer between silicon microclusters and erbium ions. *Journal of Physics: Condensed Matter*. 1994;6(21):L319.
- [104] Shimizu-Iwayama T, Terao Y, Kamiya A, Takeda M, Nakao S, Saitoh K. Correlation of microstructure and photoluminescence for nanometer-sized Si crystals formed in an amorphous SiO₂ matrix by ion implantation. *Nanostructured Materials*. 1995;5(3):307–18.
- [105] Vinciguerra V, Franzo G, Priolo F, Iacona F, Spinella C. Quantum confinement and recombination dynamics in silicon nanocrystals embedded in Si/SiO₂ superlattices. *Journal of Applied Physics*. 2000;87(11):8165–73.
- [106] Rezgui B, Sibai A, Nychyporuk T, Lemiti M, Brémont G. Photoluminescence and optical absorption properties of silicon quantum dots embedded in Si-rich silicon nitride matrices. *Journal of Luminescence*. 2009;129(12):1744–6.
- [107] Merkulov VI, Guillorn MA, Lowndes DH, Simpson ML, Voelkl E. Shaping carbon nanostructures by controlling the synthesis process. *Applied Physics Letters*. 2001;79(8):1178–80.
- [108] Meyyappan M, Delzeit L, Cassell A, Hash D. Carbon nanotube growth by PECVD: a review. *Plasma Sources Science and Technology*. 2003;12(2):205.
- [109] Raveh A, Klemberg-Sapieha JE, Martinu L, Wertheimer M. Deposition and properties of diamondlike carbon films produced in microwave and radio-frequency plasma. *Journal of Vacuum Science & Technology A*. 1992;10(4):1723–7.
- [110] Cui L, Chen J, Yang B, Jiao T. High current emission from patterned aligned carbon nanotubes fabricated by plasma-enhanced chemical vapor deposition. *Nanoscale Research Letters*. 2015;10(1):1–6.
- [111] Dekker C. Carbon nanotubes as molecular quantum wires. *Physics Today*. 1999;52:22–30.
- [112] Hiramatsu M, Shiji K, Amano H, Hori M. Fabrication of vertically aligned carbon nanowalls using capacitively coupled plasma-enhanced chemical vapor deposition assisted by hydrogen radical injection. *Applied Physics Letters*. 2004;84(23):4708–10.
- [113] AuBuchon JF, Daraio C, Chen L-H, Gapin AI, Jin S. Iron silicide root formation in carbon nanotubes grown by microwave PECVD. *The Journal of Physical Chemistry B*. 2005;109(51):24215–9.
- [114] Dresselhaus MS, Dresselhaus G, Eklund PC. *Science of Fullerenes and Carbon Nanotubes: Their Properties and Applications*. Cambridge, MA: Academic Press; 1996.
- [115] Kato T, Hatakeyama R. Formation of freestanding single-walled carbon nanotubes by plasma-enhanced CVD. *Chemical Vapor Deposition*. 2006;12(6):345–52.

- [116] Bo Z, Mao S, Han ZJ, Cen K, Chen J, Ostrikov KK. Emerging energy and environmental applications of vertically-oriented graphenes. *Chemical Society Reviews*. 2015;44(8): 2108–21.
- [117] Jacob MV, Rawat RS, Ouyang B, Bazaka K, Kumar DS, Taguchi D, et al. Catalyst-free plasma enhanced growth of graphene from sustainable sources. *Nano Letters*. 2015;15(9):5702–8.
- [118] Szymanowski H, Sobczyk A, Gazicki-Lipman M, Jakubowski W, Klimek L. Plasma enhanced CVD deposition of titanium oxide for biomedical applications. *Surface and Coatings Technology*. 2005;200(1):1036–40.
- [119] Hájková P, Špatenka P, Krumeich J, Exnar P, Kolouch A, Matoušek J, et al. Antibacterial effect of silver modified TiO₂/PECVD films. *The European Physical Journal D*. 2009;54(2):189–93.
- [120] Ayllon J, Figueras A, Garelik S, Spirkova L, Durand J, Cot L. Preparation of TiO₂ powder using titanium tetraisopropoxide decomposition in a plasma enhanced chemical vapor deposition (PECVD) reactor. *Journal of Materials Science Letters*. 1999;18(16):1319–21.
- [121] Williams L, Hess D. Structural properties of titanium dioxide films deposited in an rf glow discharge. *Journal of Vacuum Science & Technology A*. 1983;1(4):1810–9.
- [122] Maeda M, Watanabe T. Visible light photocatalysis of nitrogen-doped titanium oxide films prepared by plasma-enhanced chemical vapor deposition. *Journal of the Electrochemical Society*. 2006;153(3):C186–C9.
- [123] Rosler RS, Engle GM. Plasma-enhanced CVD of titanium silicide. *Journal of Vacuum Science & Technology B*. 1984;2(4):733–7.
- [124] Candan S, Beck AJ, O'Toole L, Short RD. Effects of “processing parameters” in plasma deposition: acrylic acid revisited. *Journal of Vacuum Science & Technology A*. 1998;16(3):1702–9.
- [125] Beyer D, Knoll W, Ringsdorf H, Wang JH, Timmons RB, Sluka P. Reduced protein adsorption on plastics via direct plasma deposition of triethylene glycol monoallyl ether. *Journal of Biomedical Materials Research*. 1997;36(2):181–9.
- [126] Tarducci C, Schofield W, Badyal J, Brewer S, Willis C. Synthesis of cross-linked ethylene glycol dimethacrylate and cyclic methacrylic anhydride polymer structures by pulsed plasma deposition. *Macromolecules*. 2002;35(23):8724–7.
- [127] Choukourov A, Biederman H, Slavinska D, Hanley L, Grinevich A, Boldyryeva H, et al. Mechanistic studies of plasma polymerization of allylamine. *The Journal of Physical Chemistry B*. 2005;109(48):23086–95.
- [128] van Os M, Menges B, Timmons R, Knoll W, Foerch R, editors. Variations in the film chemistry of pulsed rf plasma deposited allylamine. In 13th International Symposium on Plasma Chemistry. Beijing, China: Peking University Press; 1997.

- [129] Schiller S, Hu J, Jenkins A, Timmons R, Sanchez-Estrada F, Knoll W, et al. Chemical structure and properties of plasma-polymerized maleic anhydride films. *Chemistry of Materials*. 2002;14(1):235–42.
- [130] Wu YJ, Timmons RB, Jen JS, Molock FE. Non-fouling surfaces produced by gas phase pulsed plasma polymerization of an ultra low molecular weight ethylene oxide containing monomer. *Colloids and Surfaces B: Biointerfaces*. 2000;18(3):235–48.
- [131] Beier O, Pfuch A, Horn K, Weisser J, Schnabelrauch M, Schimanski A. Low temperature deposition of antibacterially active silicon oxide layers containing silver nanoparticles, prepared by atmospheric pressure plasma chemical vapor deposition. *Plasma Processes and Polymers*. 2013;10(1):77–87.
- [132] Gilabert-Porres J, Martí S, Calatayud L, Ramos V, Rosell A, Borrós S. Design of a nanostructured active surface against Gram-positive and Gram-negative bacteria through plasma activation and in situ silver reduction. *ACS Applied Materials & Interfaces*. 2015;8(1):64–73.
- [133] Taglietti A, Arciola CR, D'Agostino A, Dacarro G, Montanaro L, Campoccia D, et al. Antibiofilm activity of a monolayer of silver nanoparticles anchored to an amino-silanized glass surface. *Biomaterials*. 2014;35(6):1779–88.
- [134] Saulou C, Despax B, Raynaud P, Zanna S, Marcus P, Mercier-Bonin M. Plasma deposition of organosilicon polymer thin films with embedded nanosilver for prevention of microbial adhesion. *Applied Surface Science*. 2009;256(3):S35–S9.
- [135] Vogler EA. Structure and reactivity of water at biomaterial surfaces. *Advances in Colloid and Interface Science*. 1998;74(1):69–117.
- [136] Ninham BW, Kurihara K, Vinogradova OI. Hydrophobicity, specific ion adsorption and reactivity. *Colloids and Surfaces A: Physicochemical and Engineering Aspects*. 1997;123:7–12.
- [137] Jin SB, Lee JS, Choi YS, Choi IS, Han JG. High-rate deposition and mechanical properties of SiO_x film at low temperature by plasma enhanced chemical vapor deposition with the dual frequencies ultra high frequency and high frequency. *Thin Solid Films*. 2011;519(19):6334–8.
- [138] Satriano C, Marletta G, Kasemo B. Oxygen plasma-induced conversion of polysiloxane into hydrophilic and smooth SiO_x surfaces. *Surface and Interface Analysis*. 2008;40(3–4):649–56.
- [139] Sarapirom S, Lee J, Jin S, Song D, Yu L, Han J, et al. Wettability effect of PECVD-SiO_x films on poly (lactic acid) induced by oxygen plasma on protein adsorption and cell attachment. *Journal of Physics: Conference Series*. 2013;423(1):012042.
- [140] Gandhiraman R, Gubala V, Volcke C, Doyle C, James B, Daniels S, et al. Deposition of chemically reactive and repellent sites on biosensor chips for reduced non-specific binding. *Colloids and Surfaces B: Biointerfaces*. 2010;79(1):270–5.

- [141] Gandhiraman RP, Gubala V, O'Mahony CC, Cummins T, Raj J, Eltayeb A, et al. PECVD coatings for functionalization of point-of-care biosensor surfaces. *Vacuum*. 2012;86(5):547–55.
- [142] De Groot K, Geesink R, Klein C, Serekian P. Plasma sprayed coatings of hydroxylapatite. *Journal of Biomedical Materials Research*. 1987;21(12):1375–81.
- [143] Friedman RJ, Black J, Galante JO, Jacobs JJ, Skinner HB. Current concepts in orthopaedic biomaterials and implant fixation. *Journal of Bone and Joint Surgery: American*. 1993;75(7):1086–109.
- [144] Long J, Sim L, Xu S, Ostrikov K. Reactive plasma-aided RF sputtering deposition of hydroxyapatite bio-implant coatings. *Chemical Vapor Deposition*. 2007;13(6–7):299–306.
- [145] Intranuovo F, Favia P, Sardella E, Ingrosso C, Nardulli M, d'Agostino R, et al. Osteoblast-like cell behavior on plasma deposited micro/nanopatterned coatings. *Biomacromolecules*. 2010;12(2):380–7.
- [146] Quintieri L, Pistillo B, Caputo L, Favia P, Baruzzi F. Bovine lactoferrin and lactoferricin on plasma-deposited coating against spoilage *Pseudomonas* spp. *Innovative Food Science & Emerging Technologies*. 2013;20:215–22.
- [147] Yu D, Yang Y-Q, Chen Z, Tao Y, Liu Y-F. Recent progress on thin-film encapsulation technologies for organic electronic devices. *Optics Communications*. 2016;362:43–9.
- [148] Feng L, Anguita JV, Tang W, Zhao J, Guo X, Silva SRP. Room temperature grown high quality polymer-like carbon gate dielectric for organic thin-film transistors. *Advanced Electronic Materials*. 2016;2(3):1–6.
- [149] Jeong D-C, Javid A, Wen L, Choi EJ, Park SY, Kim YH, et al. Low-temperature plasma polymerization of dicyclopentadiene for anti-corrosion properties. *Polymer*. 2016;92:133–9.
- [150] Agnès T-M, Satoshi I, Bertrand-David S, Grant AC, Takuya T, Hiroyuki F, et al. Review on thin-film transistor technology, its applications, and possible new applications to biological cells. *Japanese Journal of Applied Physics*. 2016;55(4S):04EA8.