

# We are IntechOpen, the world's leading publisher of Open Access books Built by scientists, for scientists

4,800

Open access books available

122,000

International authors and editors

135M

Downloads

Our authors are among the

154

Countries delivered to

TOP 1%

most cited scientists

12.2%

Contributors from top 500 universities



WEB OF SCIENCE™

Selection of our books indexed in the Book Citation Index  
in Web of Science™ Core Collection (BKCI)

Interested in publishing with us?  
Contact [book.department@intechopen.com](mailto:book.department@intechopen.com)

Numbers displayed above are based on latest data collected.

For more information visit [www.intechopen.com](http://www.intechopen.com)



---

# Increasing Energy Efficiency by Reducing Losses and Promoting Value Propositions

---

Rune Gustavsson and Leif Marcusson

Additional information is available at the end of the chapter

<http://dx.doi.org/10.5772/59343>

---

## 1. Introduction

Energy is the base of our society and is the precondition of almost all human activities since at least a couple of centuries. Besides the benefits of energy usage we also have severe drawbacks related to negative effects on our environment. Manifested by, e.g., the climate change due to increased carbon dioxide emissions and scars and waste from coal mining and oil digging.

Energy efficiency has at least the following interpretations.

- Diminishing losses in generation, transmission and distribution of energy. It is estimated that we today have about 10% energy losses in the transmission and distribution grids of Alternating Current (AC) energy.
- Increasing performance of equipment and processes
- Increasing comfort and well being of humans

By increasing the performance of equipment we get 'more mileage' from each unit of energy. Better support tools for human activities in different areas, e.g., by smart robots, will increase the demand of energy as well as provide increased quality of work. Novel tools and techniques increase comfort and well being of humans in areas such as 'smart cities' and/or individual health-care and monitoring systems.

The following *conceptual energy triangle*, from AC technologies, supports discussions on different energy efficiency issues (Figure 1).

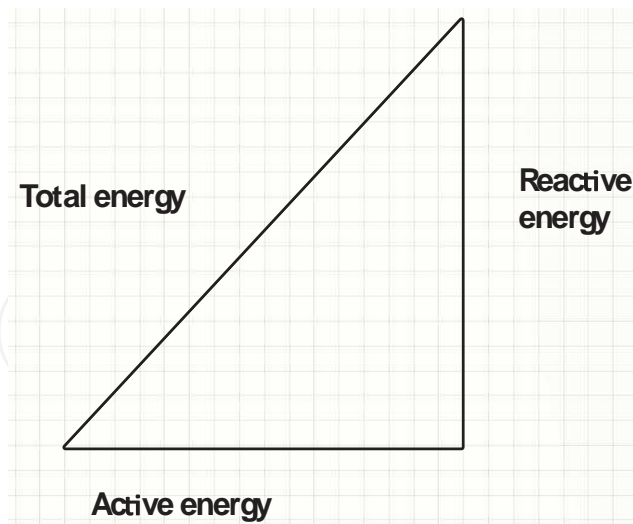

Figure 1. Conceptual energy triangle

In the case of AC generated power, *Active power* represents the power consumed by loads at customer's premises. That is, the power measured and paid for by customers. *Reactive power* is needed to continuously keep the electric balance of the power systems. Keeping this balance needs supporting equipment and real time monitoring and control provided by SCADA systems.

The following Figure 2, adopted from<sup>1</sup>, captures the basic notations related to AC systems.

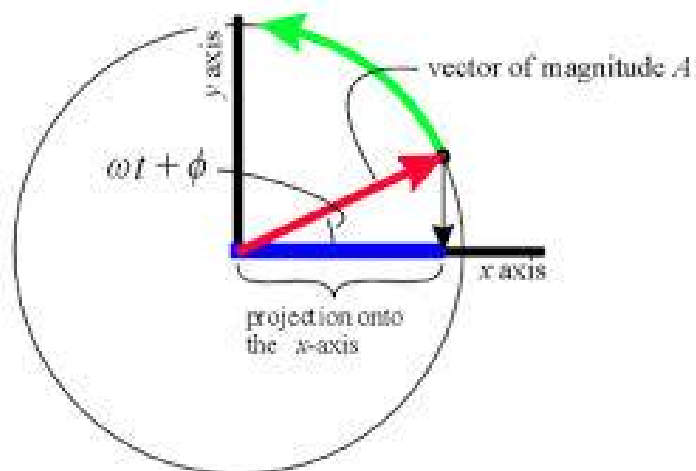

Figure 2. AC generation parameters at generators

Generators driven by an external energy source such as waterfalls typically generate AC power. The rotation in the generator causes AC generated by *interactions between magnetic and electric fields*. In Figure 2 this phenomenon is illustrated by rotations of the red total vector. Its

<sup>1</sup> [http://en.wikipedia.org/wiki/AC\\_power](http://en.wikipedia.org/wiki/AC_power)

projection on the x-axis is the *active power generated (KWs)*, whence the projection on the y-axis is the *Reactive Energy (VARs)*. The *sinusoidal waveform* of both projections have a phase angle of  $(\omega t + \Phi)$ , where  $\omega$  is the angle speed (radians/second),  $t$  denotes the time and  $\Phi$  determines the Phase Factor (PF).

A sinusoidal alternating voltage applied to a *purely resistive* load results in an alternating current that is *fully in phase* ( $F=0$ ) with the voltage. However, in many applications it is common to also have a *reactive component* in the system, that is, due to the fact that the system possesses *capacitance, inductance, or both*. These electrical properties cause the current to *change phase* ( $\Phi$ ) with respect to the voltage: capacitance tending the current to lead the voltage in phase, and inductance to lag it.

Reactive power (measured in VARs) is present in a system containing reactive (inductive or capacitive) components and can be either produced or consumed by different load/generation elements. Though 'imaginary', the reactive power has great physical significance and is essential to the operation of the electrical system as a whole.

While the real power  $P$  is used to supply the energy required to perform actual work (such as running a motor), the *reactive power regulates the voltage* in the system. If the reactive power is too low, inductive loads such as transformers will be unable to maintain voltages necessary for the generation of electromagnetic fields, leading to a 'voltage collapse' that create blackouts.

Transmission line impedances also make it necessary to provide reactive power to maintain voltage levels necessary for active power to flow through. Therefore *reactive power is essential to move active power through transmission and distribution systems* to the customer. However if reactive power in a system is too high, there is *increased heat loss in transmission lines and loads as the current flowing through the system is much higher*, creating a potentially hazardous breakdown situation. The power factor (PF) of a load tells us what *fraction* of the *apparent power* (red in Figure 2) is in the form of real power and performs actual work. A high power factor is desirable since it minimizes the amount of reactive power needed by the load, reducing heat losses and maximizing efficiency (Section 2.3 and Section 5).

In the case of vehicles the *total energy* corresponds to the distance travelled whence reactive energy corresponds to energy needed to overcome different kinds of resistance (wind, road, engine) during the journey. The demand from customers to have more energy efficient vehicles has forced manufacturers to improve the efficiency by reducing the need of total energy in driving vehicles.

The customer costs are thus, as we know, different in those two cases. In the electrical power case the customer only pays for active energy, whence reactive energy has implicit costs for the end customer and is, at present, provided by grid operators. The two energy cost models; total costs versus partial cost paid by customers, have led to different focus of transport and energy system developments [Section 6].

The total cost model has led to customer driven demands of increased energy efficiency in design and maintenance of vehicles and a transport market with transparent total cost of ownership as well as clear roles of public and private stakeholders.

In AC energy systems the increased demands by authorities to include vast amounts of *Renewable Energy Sources* (RES), e.g., by wind farms or solar cells have stressed the transmission and distribution system abilities to keep the energy balance. That is, increased the costs for maintaining necessary (not billable) reactive power. The *only incentive* for customers of emerging Smart grids, however, so far is to save *active* energy.

In short, in order for future Smart grids to really take off to meet the societal expectations we have to *reconsider current cost and revenue models* (CMs and RMs) to meet the emerging market demands, not the least from future customers [Section 5].

Energy as such has different interchangeable forms and sources. We focus on electricity markets, as it is arguably the most versatile form of energy.

The remainder of the chapter is organized as follows. In Section 2 *Introduction to Smart grids* we outline the motivations and approaches towards Smart grids. We specifically address challenges such as:

- Estimated increased demands of energy
- Meeting environmental challenges
- Reducing losses in power generation and distribution
- Architectural principles of Smart Grids

The *Smart Grid Architecture Model* (SGAM) supports design and implementation of different energy models. The business view of those can be analysed and modelled using the complementary *Business Model Framework eTransit* described in Section 4 *eTransit Framework*.

Key components of the eTransit framework are *Value Propositions* (VPs) and *Revenue Models and Cost Structures* (RMs). A given *Business Case* can be mapped onto the Layers of the SGAM Framework identifying *relevant stakeholders and infrastructures* to deliver the chosen services related to the selected VP. Issues related to *coordination and monitoring* of tasks and stakeholders are handled by design and implementation of *Service Level Agreements* (SLAs). Identification, design, implementation and monitoring of SLAs are addressed in Section 3 *Trustworthy Service Level Agreements*. Specific challenges are related to *interoperability*, assuring that stakeholders have a *shared understanding* of the monitored state of operations, and that *high-level business concepts are supported in real time while maintaining the energy balance* of the system. To specifically support *empowerment of customers* we are addressing issues related to *Cognitive Interaction Patterns* in Section 4.1.

We have now a necessary toolbox to address the issues raised earlier. That is, suitable Cost and Revenue models to meet future market demands of Smart grids. This challenge is the topic of Section 5 *Suitable Cost and Revenue models for future Smart grids*. We exemplify our findings by introducing:

- Power Quality markets (Section 5.1)
- Cutting losses in power distribution grids (Section 5.2)
- Smart Home services enabled by Service Level Agreements (Section 5.3)

The Chapter concludes with Section 6 *Conclusions and Future Work* and Section 7 *References*.

## 2. Introduction to smart grids

Current energy systems are under pressure of three challenges. *Firstly*, they must meet the expected increasing demands on energy globally (Section 2.1). *Secondly*, they must meet the demands of decreasing the negative effects on our environment (Section 2.2). Here we must, however, establish better models for evaluating and comparing *different approaches*. *Thirdly*, they have to be more efficient (Section 2.3). To meet those challenges the concept of *Smart grids* have been introduced (Section 2.4)

### 2.1. Estimated increased demands on energy

There are several prognoses of future energy demands. A recent one is provided by *U.S. Energy Information Administration* [1] In their *International Energy Outlook (IEO) 2013* the following Figure 12 is presented. According to the IEO2013 Reference case, world energy consumption has increased from 524 quadrillion ( $10^{15}$ ) Btu (Brittish thermal unit) in 2010 to expected 630 quadrillion Btu in 2020 and 820 quadrillion Btu in 2040, hence a 30-year estimated increase of 56 percent. More than 85 percent of the increase in global energy demand from 2010 to 2040 occurs among the developing nations outside the *Organization for Economic Cooperation and Development* (non-OECD), driven by strong economic growth and expanding populations. In contrast, OECD member countries are, for the most part, already more mature energy consumers, with slow anticipated economic growth, and little or no anticipated population growth.

Many economic and geopolitical circumstances add considerable uncertainty to any long-term assessment of world energy markets. Currently, there is a wide variation in the economic performance of different countries and regions around the world. In the United States and Europe, short- and long-term debt issues remain largely unsolved and are key obstacles of future growth.

### 2.2. Meeting the environmental challenges

Governments in both Europe and the United States have implemented CO<sub>2</sub> emission policies of the following three types:

1. *Renewable Incentives*. Renewable initiatives are generally not available for non-carbon initiatives such as nuclear, large-scale hydro or gas combined cycles. Yet results from a recent report, below, demonstrate clearly that these three alternatives are far more cost effective per MW or capacity in reducing carbon dioxide emissions than wind or solar. In both the United States and Europe, there is, however, political opposition to all three of these alternatives on environmental and safety grounds, despite their cost-effective superiority in reducing carbon dioxide emissions



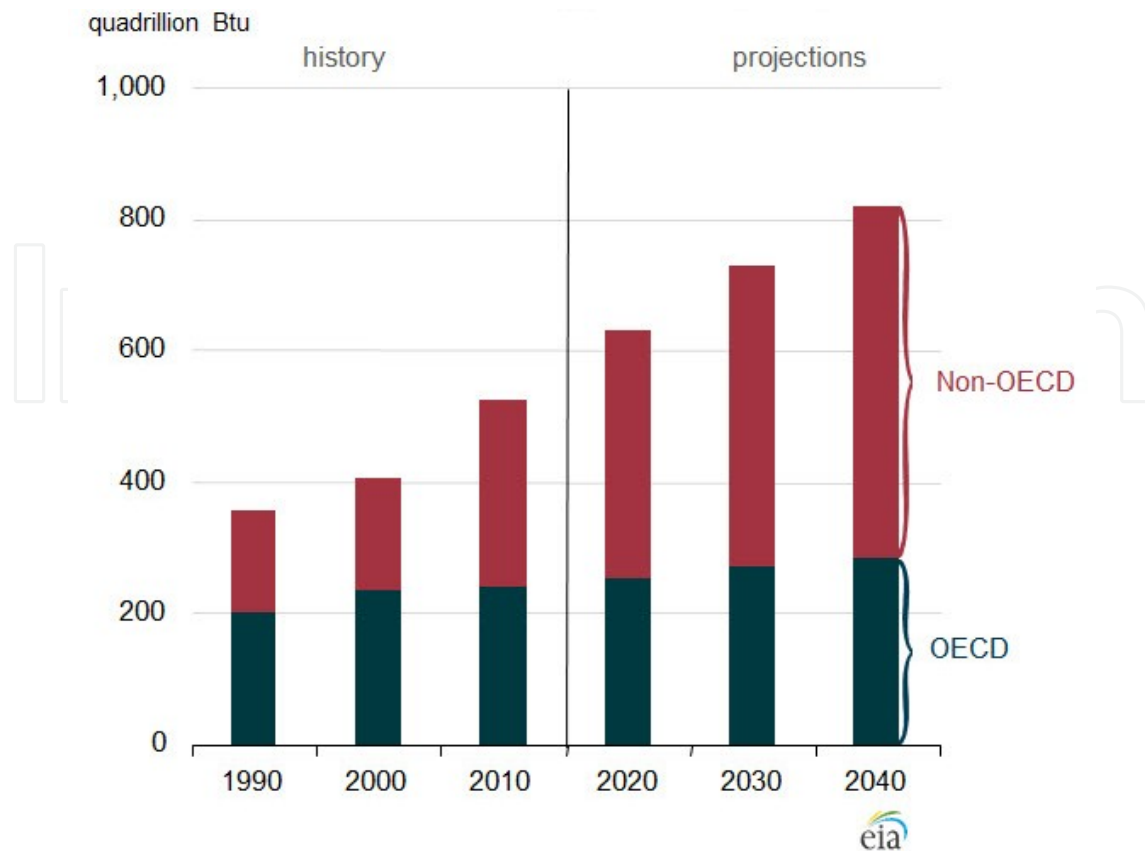

2. *Carbon Trading Systems.* There is two generally recognized methods of introducing a price for carbon dioxide emissions: (1) a *carbon tax*, or (2) a *cap-and-trade system*<sup>2</sup> for enforcing lower carbon dioxide emissions. The price of carbon emissions on the *European Trading System* (ETS) reached a peak of 30 euros in 2006 but was settled at 5 euros 2013. The reduction in the ETS carbon emission price, along with increases in the price of natural gas in Europe has *made coal more attractive* as an energy source
3. *Tighter Regulations.* The United States has failed to adopt a national carbon emission trading system because of political opposition in the U.S. Congress. However, the U.S. *Environmental Protection Agency* (EPA) is planning tighter regulations under the Clean Air Act of 1990. The proposed regulations would, in effect, have same of the same effects on coal-fired plants as a carbon price

It is likely to be *far less costly* to achieve reductions in carbon dioxide emissions through a effective carbon trading system that allows the market to determine the most effective way to reduce emissions rather than through establishment of EPA standards for emissions.

To address the environmental challenges we must *model and analyse* different aspects of energy production. The most common method for comparing cost of different electricity technologies is to compute the *Levelized Energy Cost* (LEC<sup>3</sup>). It can be defined in a single formula as:

<sup>2</sup><http://www.edf.org/climate/how-cap-and-trade-works>

$$LEC = \frac{\sum_{t=1}^n \frac{I_t + M_t + F_t}{(1+r)^t}}{\sum_{t=1}^n \frac{E_t}{(1+r)^t}}$$

where;

- $LEC$  = Average lifetime levelized electricity generation cost
- $I_t$  = Investment expenditures in year  $t$
- $M_t$  = Operations and maintenance expenditures in the year  $t$
- $F_t$  = Fuel expenditures in year  $t$
- $E_t$  = Electricity generation in the year  $t$
- $r$  = Discount rate
- $n$  = Life of the system

However, there are convincing arguments that levelized costs are not appropriate for *ranking technologies*. The trouble is that levelized costs do not take account of the costs of intermittency. Wind power is not generated on a calm day, nor solar power at night, so conventional power plants must be kept on standby—but the *associated costs* are not included in the levelized cost of renewables. Electricity demand also varies during the day in ways that the supply from wind and solar generation may not match, so even if renewable forms of energy have the same levelised cost as conventional ones, the value of the power they produce may be lower. In short, levelized costs are *poor at comparing different forms* of power generation.

In a recent report from Booking; *The Net Benefits of Low and No-Carbon electricity Technologies*, different approaches supporting comparisons of different forma of power generation are introduced and discussed [2]. The report examines five different low and non-carbon electricity technologies and present the net benefits of each under a range of assumptions. It estimates the costs per megawatt per year for wind, solar, hydroelectric, nuclear, and gas combined cycle electricity plants. To calculate these estimates the paper uses a methodology based on *avoided emissions* and *avoided costs*. Rather than comparing the more prevalent levelized costs.

The following three findings are reported:

1. *First* – assuming reductions in carbon emissions are valued at €50 per metric ton and the prize of natural gas €16 per million Bty or less – Finding: nuclear, hydro, and natural gas combined cycle have far more net benefits than either wind or solar. This is the case because solar and wind facilities suffer from very high capacity cost per megawatt, very low capacity factors and low reliability, which result in low avoided emissions and low avoided energy cost per dollar invested.
2. *Second*, low and non-carbon energy projects are most effective in avoiding emissions if a price for carbon is levied on fossil fuel energy suppliers. In the absence of appropriate

---

3 [http://en.wikipedia.org/wiki/Cost\\_of\\_electricity\\_by\\_source](http://en.wikipedia.org/wiki/Cost_of_electricity_by_source)



price for carbon, new non-carbon plants will tend to displace low-carbon as combined cycle plants rather than high-carbon coal plants and achieving only a fraction of the potential reduction in carbon emissions. The price of carbon should be high enough to make production from gas-fired plants preferable to production from coal-fired plants, both in the short term, based on relative short-term energy costs, and in the longer term, based on relative energy and capacity costs combined.

3. *Third*, direct regulation of carbon dioxide emissions of new and existing coal-fired as proposed by the U.S. Environmental Protection Agency, can have some of the same effects as a carbon price in reducing coal plant emissions, both in the short term and in the longer term as old, inefficient coal plants are retired. However, a price levied on carbon dioxide emissions is likely to be a less costly way to achieve reduction in carbon dioxide emissions.

The findings of the report is summarized in the following Figure 3 from *The Economist* July 26<sup>th</sup> – August 1<sup>st</sup> 2014, page 20.

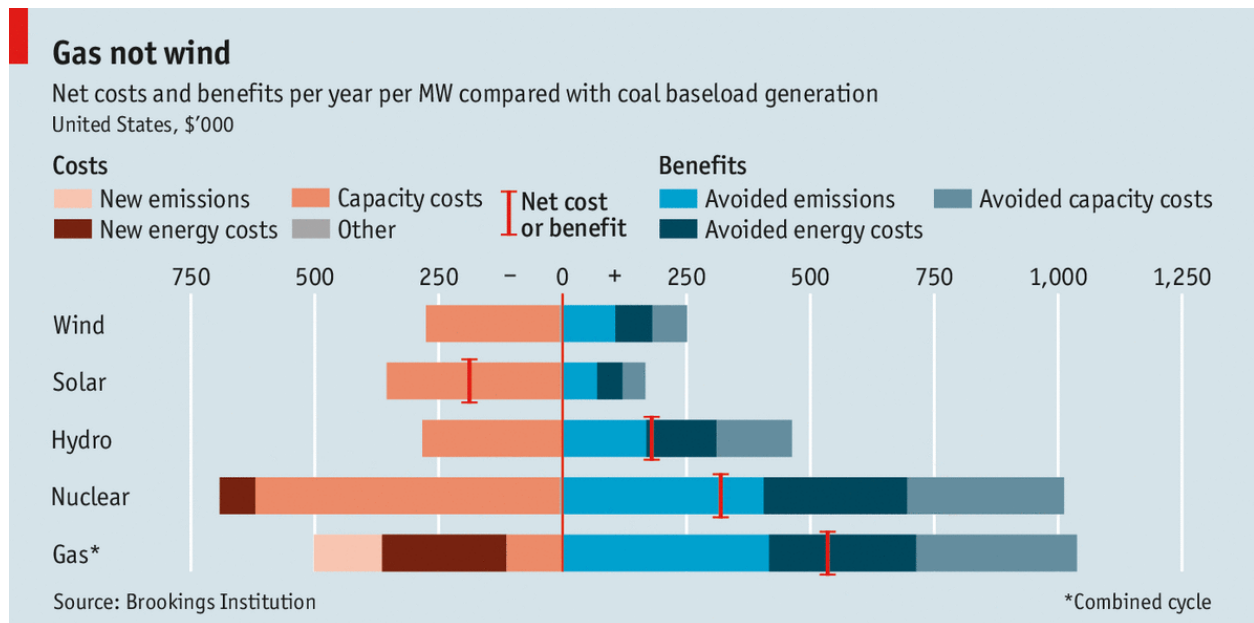

Figure 3. Cost-benefit analysis of different energy sources

If all the costs and benefits are added up using the model given in the report, solar power is by far the most expensive way of reducing carbon emissions. It costs \$189,000 to replace 1MW per year of power from coal. Wind is the next most expensive. Hydropower provides a modest net benefit. But the most cost-effective zero-emission technology is nuclear power. The pattern is similar if 1MW of gas-fired capacity is displaced instead of coal. And all this assumes a carbon price of \$50 a tonne. Using actual carbon prices (below \$10 in Europe) makes solar and wind look even worse. The carbon price would have to rise to \$185 a tonne before solar power shows a net benefit.

There are, of course, all sorts of reasons to choose one form of energy over another, including emissions of pollutants other than CO<sub>2</sub> and fear of nuclear accidents. Still, the findings have profound policy implications. At the moment, most rich countries and China subsidize solar and wind power to help stem climate change. Yet this is the most expensive way of reducing greenhouse-gas emissions. Meanwhile Germany and Japan, among others, are mothballing nuclear plants, which (in terms of carbon abatement) are cheaper. The implication of the research reported is clear: *governments should target emissions reductions from any source rather than focus on boosting certain kinds of renewable energy!*

### 2.3. Reducing losses in power generation and distribution

Power generated in power stations pass through large and complex networks of transformers, overhead lines, cables and other equipment before reaching the end users. It is fact that the Unit of electric energy generated by Power Station does not match with the units distributed to the consumers! Some percentage of the units is lost in the transmission and distribution networks. This difference in the generated and distributed units is known as *Transmission and Distribution (T&D) losses*<sup>4</sup>.

- Transmission and Distribution losses, of AC systems, are not paid by users. They only pay for the received power (part of the Active energy, Figure 1).
- The Distribution sector is considered as the weakest link in the entire power sector efficiency measurement chain. Transmission Losses is approximate 17% while Distribution Losses is approximate 50% of the generated AC power.

There are two identified types of T&D losses. The losses are identified as *Technical losses* or *Non-technical losses*.

#### 2.3.1. Technical losses<sup>5</sup>

The technical losses are due to energy dissipated in the conductors, equipment used for transmission Line, Transformer, sub- transmission Line and distribution Line and magnetic losses in transformers. Technical losses are normally 22.5%, and directly depend on the network characteristics and the mode of operation. The major amount of losses in a power system is in primary and secondary distribution lines. While transmission and sub-transmission lines account for only about 30% of the total losses. Therefore the primary and secondary distribution systems must be properly planned to ensure within limits. Losses are inherent to the distribution of electricity and cannot be eliminated [3].

Variable losses vary with the amount of electricity distributed and are, more precisely, proportional to the square of the current. Consequently, a 1% increase in current leads to an increase in losses of more than 1%. Between 2/3 and 3/4 of technical (or physical) losses on distribution networks are variable Losses. By increasing the cross sectional area of lines and

---

<sup>4</sup>[http://en.wikipedia.org/wiki/Electric\\_power\\_transmission](http://en.wikipedia.org/wiki/Electric_power_transmission)

<sup>5</sup> <http://electrical-engineering-portal.com/>

cables for a given load, losses will fall. This leads to a direct trade-off between cost of losses and cost of capital expenditure. It has been suggested that optimal average utilization rate on a distribution network that considers the cost of losses in its design could be as low as 30 percent.

### 2.3.2. Main reasons for technical losses

The main reasons for technical losses are:

- Lengthy Distribution lines
- Inadequate Size of Conductors of Distribution lines
- Installation of Distribution transformers away from loads centers
- Low Power Factor (PF) of primary and secondary distribution systems
- Bad Workmanship
- Feeder Phase Current and Load Balancing

One of the easiest loss savings of the distribution system is *balancing current* along three-phase circuits. Feeder phase balancing also tends to balance voltage drop among phases giving three-phase customers less voltage unbalance. Amperage magnitude at the substation doesn't guarantee load is balanced throughout the feeder length. Feeder phase unbalance may vary during the day and with different seasons. Feeders are usually considered "balanced" when phase current magnitudes are within a specified interval. Similarly, balancing load among distribution feeders will also lower losses assuming similar conductor resistance. This may require installing additional switches between feeders to allow for appropriate load transfer.

*Power Load Factor* (PF) [Figure 2] has several effects on losses. Power consumption of Customer varies throughout the day and over seasons. Residential customers generally draw their highest power demand in the evening hours. Some commercial customer load generally peak in the early afternoon. Because current level (hence, load) is the primary driver in distribution power losses, keeping power consumption more level throughout the day will lower peak power loss and overall energy losses. Load variation is denoted load factor and it varies from 0 to 1. *Power and energy losses are reduced by raising the load factor*, which, evens out feeder demand variation throughout the feeder.

The load factor can be increased by offerings to customer *time-of-use rates*. Companies use similar pricing power to influence consumers to shift electric-intensive activities during off-peak times (such as, electric water and space heating, air conditioning, irrigating, and pool filter pumping).

With financial incentives, some electric customers are also allowing utilities to interrupt large electric loads remotely through radio frequency or power line carrier during periods of peak use. Utilities can try to design in higher load factors by running the same feeders through residential and commercial areas.

To decrease T&D losses we need to be able to optimize the grid structure dynamically. To that end we need to implement a suitable information processing system by monitoring relevant system parameters and take appropriate actions. This is one of the goals of future Smart grids! Obviously, in reducing losses we also improve the environmental effects of power production.

In Section 5 we give an example of reducing losses in power distribution by installing 'smart equipment' and by empowerment of customers.

#### 2.4. Architectural principles of smart grids

Smart Grids are in focus of several international R&D past and present efforts since at least a decade. The EU *Smart Grids Technology Platform* [4] has recently published *SmartGrids SRA 2035* outlining R&D efforts to be met 2035 [5]. Smart Grids is a well-known metaphor for future power grids. However, the meaning, or semantics of the concept has, naturally, changed due to increased understanding of the inherent complexities of the subject matter.

The driving forces behind the efforts on Smart Grids include:

- Demands of increased energy efficiency to meet the 20-20-20 EU goals
- Demands of integrating new energy sources such as *Distributed Energy Sources* (DES) and *Renewable Energy Sources* (RES) in a massive way into generation and transmission grids of future energy systems.
- Establishment of a de-regulated customer oriented energy market, including new types of energy based service markets.

The transition from today's mostly hierarchical power grids towards tomorrow's Smart Grids poses several challenges to be properly addressed and harnessed.

Among the challenges we have systems of systems requirements such as:

- Supporting information protection and security, as well as maintaining trustworthiness of services and systems by involved stakeholders in different use cases.
- Supporting interoperability and flexibility of involved systems.

Introduction of 'Smartness' of systems, such as classical power system, requires some new views and designs of systems to be implemented in a proper way. Some decades ago those systems were mainly hierarchical stovepipe hardcoded systems with SCADA systems monitoring and controlling the generation, transmission and distribution of energy. The SCADA systems enabled operators to maintaining agreed upon Quality of Service (QoS) to the sockets at customer's premises.

A first step to allow for flexibility across and between stovepipe systems is to *decouple* hierarchical systems into open *Service-Oriented Systems* (SOS), and to introduce *open reconfigurable interfaces* between the components. That is, standard interfaces supported by tools and methods to *inspect and assess data-flows* across those interfaces (Section 4.1). Those methods also allow design and implementation of *defence-in-depth* to cater for increased system- and data security [6, 7].



A second step is to *decouple and supplement* the traditional SCADA and Protection systems into SOS and to introduce *dedicated* Information Processing Systems supplementing the SCADA systems. Its purpose is to Monitor and Control information flows supporting integration of new types of energy sources and flows of business transactions. In effect, future Smart Grids will consist of three *interconnected* types of systems:

- Systems supporting *Energy management*
- Systems supporting *information management*
- Systems supporting *Business management*

The first two types of systems are specified in Figures 4 – 7. However, the related Business management systems have so far *not been explicitly specified* to the same extent. This complementary view on Smart grid has also to be in focus in order to assess specific challenges related to *market models* of The Smart grids. We introduce to that end the *eTransit Business Model Framework* in Section 4! This allows us to specifically model *user centric case models* where we can illustrate *interdependence between all three views* of Smart grids (Section 5). In short, introduction of the eTransit Framework complements the Smart Grid Architecture Models, below, in a *crucial* aspect!

Different architectures of Smart grids have been proposed. For instance the *Smart Grid Architecture Model (SGAM)* outlined in Figure 4 and Figure 5 below [8].

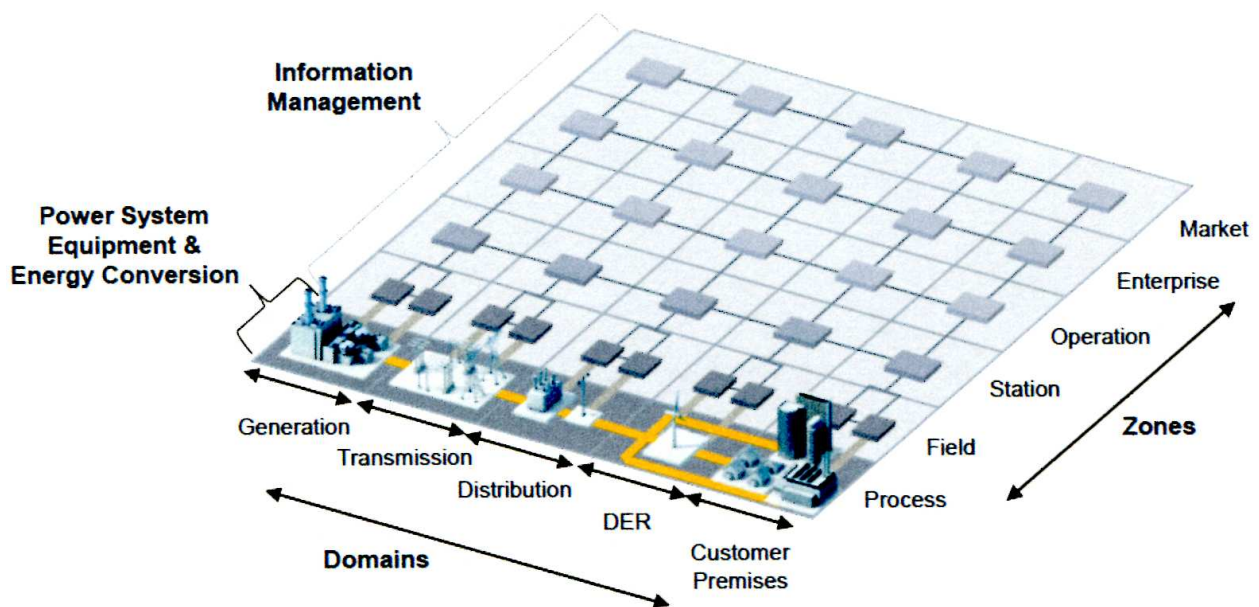

Figure 4. Smart Grid plane of SGAM

The Smart Grid plane consists of a grid with two axes of *Domains* and *Zones*. The Domain consist of components related to *Power System Equipment & Energy Conversion*, e.g., *Generation*, *Transmission* and *Distribution* as in classical power systems. However, and important *added* feature of Smart grids are the explicit components of *DER* and *Customer Premises*. The *Zones*

consists of the complementary axis to Domains, that is, generalizations of the classical components *Processes, Field, Station, Operation* complemented with *Enterprise* and *Market*.

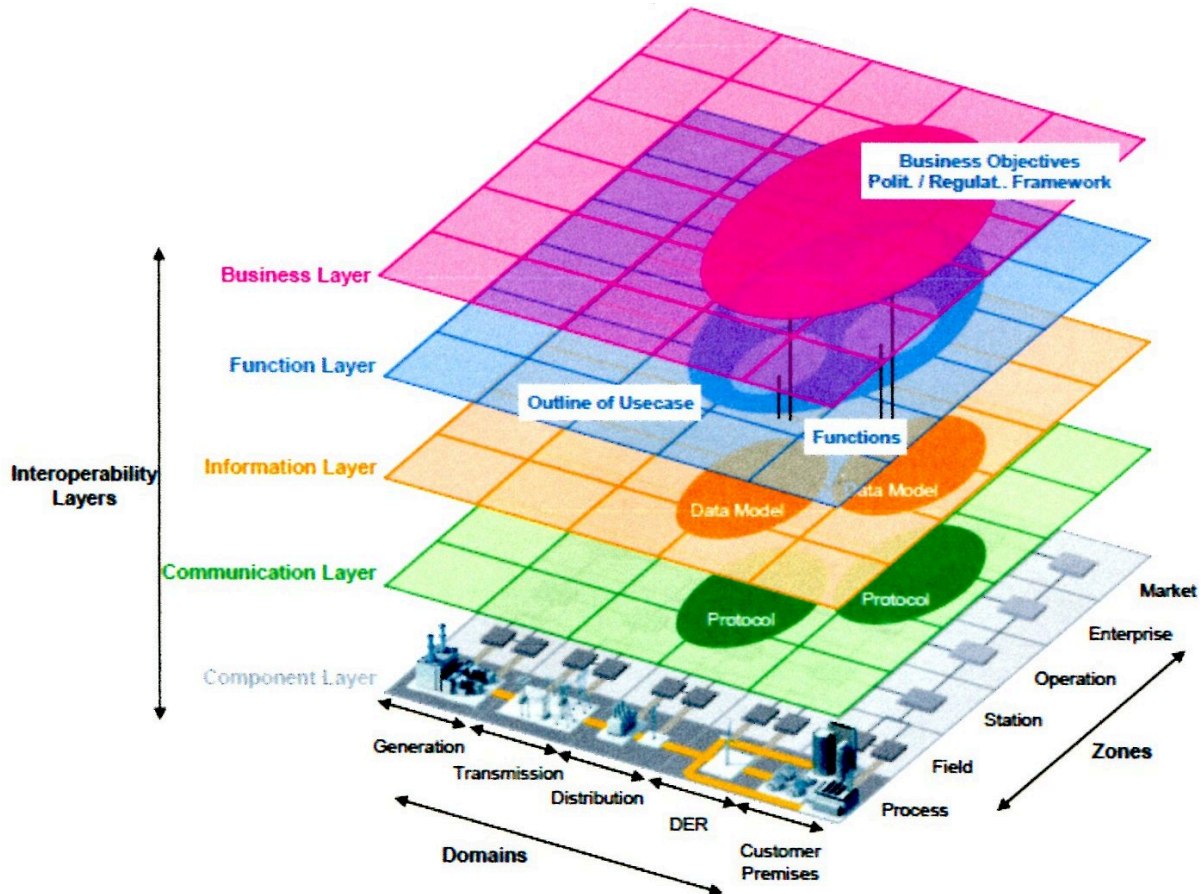

Figure 5. Layers of SGAM framework

The purpose of this Smart Grid plane is to implement and support the related *Information Management* of the individual and integrated three Infrastructures of Smart grids mentioned above. In order to cater for this very complex task we need to introduce a third axis, vertical and above, the Smart Grid plane. This axis of *Interoperability layers* is depicted in Figure 5, above.

The Interoperability layers are from bottom to top: *Component, Communication, Information, Function, and Business* layers. In Figure 5 we also have depicted a *projection from a Business Case* with stated objective down onto the SGAM framework cube.

In order to properly address issues related to Interoperability, the *Interoperability Framework* proposed by *GridWise Architecture Council*, (Figure 6), is incorporated in SGAM.

Interoperability issues are treated in some detail in Section 5.3 *Smart Home Services enabled by Service Level Agreements*.



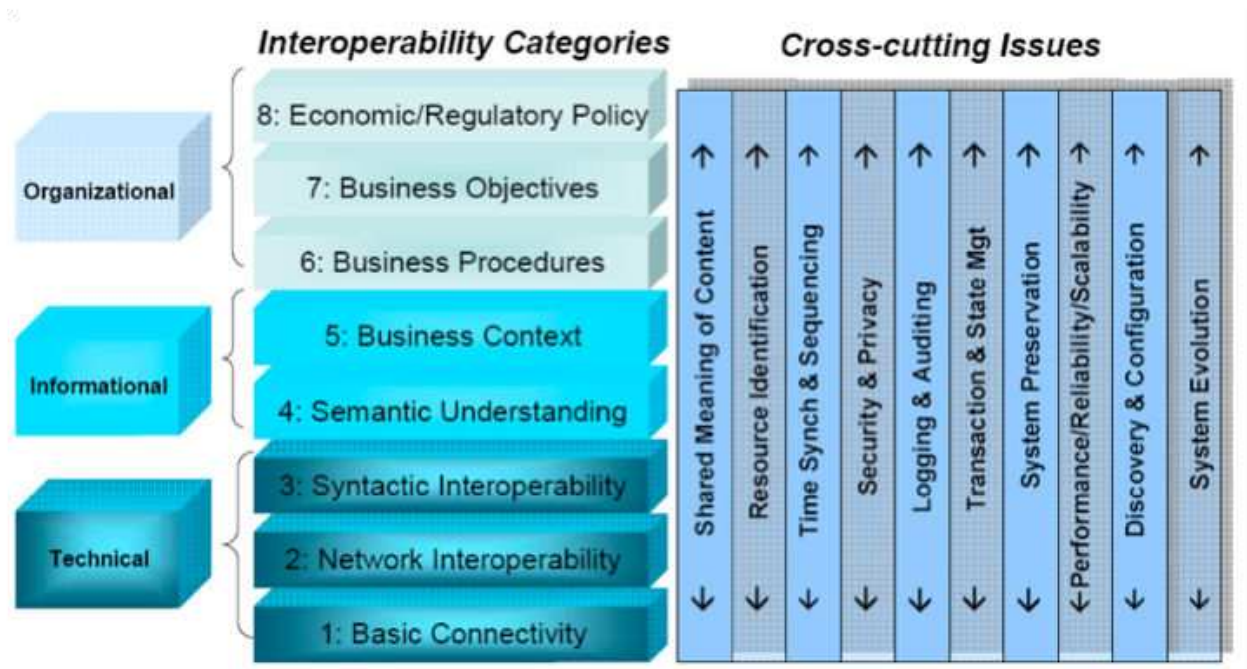

Figure 6. GWAC Interoperability Framework with a layered set of Categories and non-functional Cross-cutting Issues

In a classical power system the relevant Domain Component were *hierarchically integrated* with relevant zones into a *closed system* delivering and billing power to the customer according to relevant regulations and tariffs. The customers were just loads or 'two holes in the wall'. The necessary monitoring, control, and billing were supported by SCADA systems.

Transitions towards flexible and resilient Smart grids pose several basically hitherto unknown challenges. We know that power system engineering has been very successful during the last century in designing and maintaining the most complex human engineered infrastructures worldwide today. However, from Figure 5 and Figure 6 we can infer that this well renowned competence has to be *suitable complemented* with other competencies to meet the new challenges. Candidates include areas of computation and information sciences as well as competencies from economics and behavioral sciences and from psychological insights (Section 4.1).

Furthermore, to meet the societal demands we have to develop *suitable roadmaps* guiding political decisions related to procurement and evaluation towards understanding of relevant *socio-technical-economic* issues [5].

An illustrative example is the current focus of exploring RES to lower the CO<sub>2</sub> emissions causing the expected global warming. As we know those efforts are heavily subsidized by governments worldwide. However, *the economic and environmental end results of those efforts are still not sufficiently understood and need more modeling and analysis* (Section 2.2).

In this chapter we focus on *Empowerment of customers* as a mean to increase energy efficiency in Smart grids as well as promoting environment protection. We know that introduction of massive amounts of DER and RES, e.g., by wind farms, will demand complementing by reactive power to keep the needed energy balance of AC systems. At the moment R&D efforts on RES and DER are heavily subsidized in several countries. This might lead to unsustainable market in the near future. To that end, there are ongoing discussions to implement some full-cost services in *Ancillary Service Markets* on:

- Operation Reserve
- Frequency Control
- Reactive Power and Voltage Control
- Short – Circuit Capacity
- Voltage Quality
- Black-Start
- Island Operation of the Grid
- Inertia
- Stability

Those markets are necessary to address, for instance, reducing losses in power generation and distribution (Section 2.3) and will be further discussed in Section 5.

Empowerment of customers might also support new *energy based services* that will increase several kinds of Energy efficiency aspects mentioned above (Section 6).

### 3. Trustworthy service level agreements

Present power systems have a straightforward business model. The generation and distribution is in accordance with rules and *regulations set up and monitored by regulators*. The customers sign standardized documents and are billed based on the KWh consumption measured by meters installed at customer site and owned by a distributor. In liberated markets the bills *separates the costs into two parts* for (active) energy and for the corresponding use of network (net tariffs). The customer can choose between different energy providers and/or price incentives aiming at matching the supply/demands at peak hours (Section 2.3). The customers can also be compensated according to fixed rules in case of, for instance, blackouts.

Obviously, this simple business model cannot meet the requirements of future Smart grids! The standardized contract has to be replaced with a more flexible and market oriented concept.

We will, to that end, identify and establish a *Trustworthy Service Level Agreement* (SLA) based on a *selected Use Case* (UC) at the Business Layer in Figure 5.

Projections of a selected use cases onto lower Layers of SGAM (Figure 5) will determine:

- Relevant *stakeholders* and their concerns related to the chosen use case
- Identification of *Key Performance Indicators* (KPIs) to be monitored
- Identification of relevant functions (*business services*) at the Function layer
- Identification of supporting *information models* and *information exchange mechanisms* at the Information Layer
- Selecting relevant *communication systems and protocols* at the Communication Layer
- *Connecting and interfacing* the communication layer with selected components from the Component Layer

This process will design a business case as a *set of information processing boxes* from the Function-, Information-, and Communication Layers connecting the Use Case with components from the Component Layer. The information processing boxes (*information services*) have to be implemented and loosely coupled, to allow inspection and re-use, into a reliable information system that meet *Interoperability* (semantic) requirements as well as trustworthiness requirements from stakeholders in the use case.

The purpose of a SLA is to *coordinate and monitor* the business services and information services to meet the agreed upon requirements of the use case. We have proposed a validated methodology to negotiate and establish suitable SLAs for Smart grids [9].

From the analysis above it follows that a use case can be modeled as a *set of vertical and horizontal workflows* (*business channels*) built from *chains of services* and *connecting components* from the Component Layer *with stakeholders* at the Business Layer (Section 5). To support analysis and modeling of the relevant *flexible* information systems we need a set of *meta models* as those defined by the eTransit Framework in the next section, Section 4.

The following Figure 7 captures the contexts of SLAs. The design and implementation of SLAs are based on *Drivers and opportunities* formulated as *requirements* related to Use cases. Those requirements have to be *matched against affordances* from the infrastructures.

*A challenge is to match the high-level business requirements with low-level affordances.* Specifically *real time* constraints related to energy management sub-systems with *high-level business concepts*. To that end we have suggested a *layered structure* of the SLAs as bundles of sub-SLAs. The high-level SLAs are *coordinated, via message exchanges*, with low-level SLAs at the Information Layer of Figure 5. Some technological challenges are further discussed below (Section 5.3).

In present power systems the ICT system is mainly the SCADA system monitoring and controlling production and distribution of power. The SCADA system *integrates information from the component Domain with the Operation Zone for monitoring and control*. The operators react on information given to them with control signals down the zones. Since the use case at the business layer is a point – *a fixed contract* between customer and distributor - we do not have to consider specific business information at the operator level. Use cases where we really need more complex SLAs are further discussed in Section 5.

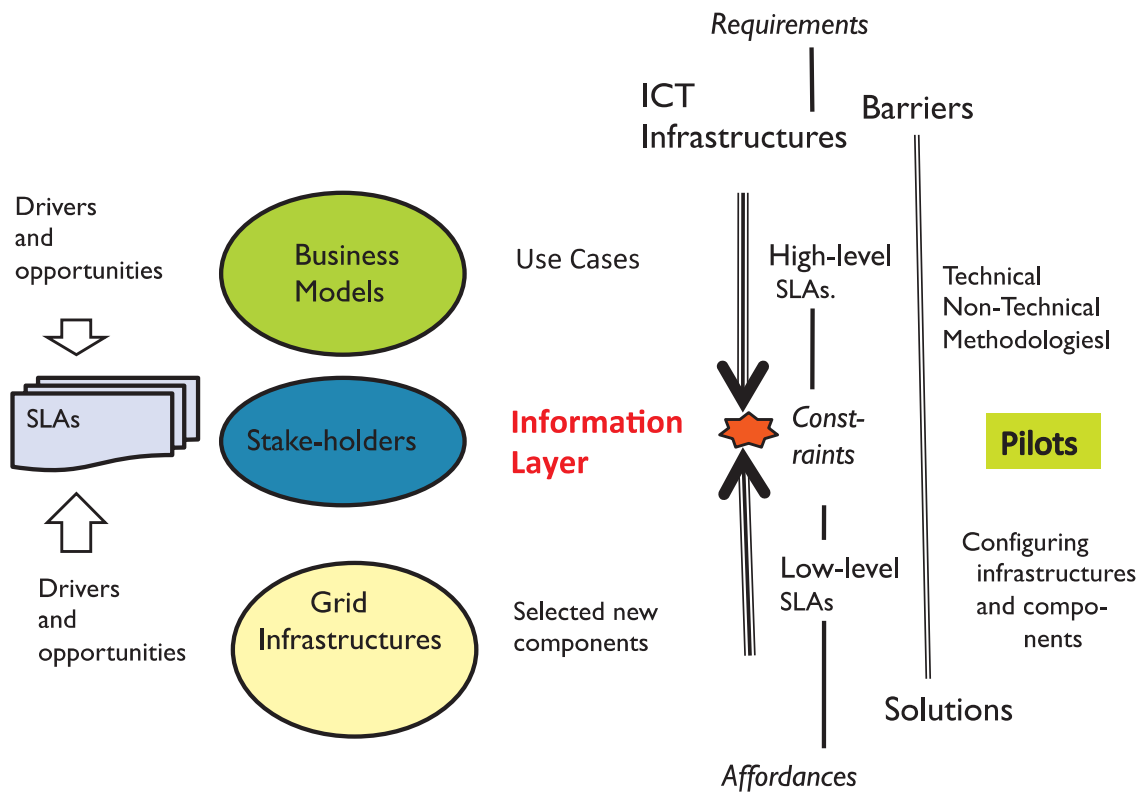

Figure 7. SLA context as coordination of bundles of high-level and low-level SLAs

#### 4. eTransit business model framework

From Section 2.4 we have seen that Smart grids can be modeled as *three* interconnected types of systems. The Energy management and Information management systems are the focus of SGAM frameworks Figures 4 – 6. To *complement* those views with a focus on *Business management* we suggest add to those these models the *eTransit Business Model Framework*. This framework was a result of the eTransit project in Sweden and Finland 2013-14 [10].

The focus of the eTransit project was to investigate the effects on the business processes of the rapidly expanding e-Commerce sector, specifically the role of mobile access points and its mutual dependencies with more traditional points of sale. A specific focus of the project was to investigate drivers and obstacle related to *transitions* between different business channels. To support those investigations we proposed the following eTransit Framework (Figure 8).

The eTransit Framework identifies a set, the *eTransit Views*, of useful aspects on Business Models (BMs). The Framework, with associated Methodology, is supporting *Requirements Engineering, Design, Implementations and Validation* of Business support systems. The *usefulness and adequacy* of the model was validated in the project as well. Since the Business management view of Smart grids, addressing energy based markets and empowerment of customers, is important, we suggest that the eTransit framework is a natural and necessary complement to the other two views of Smart grids given by SGAM (Section 2.4).

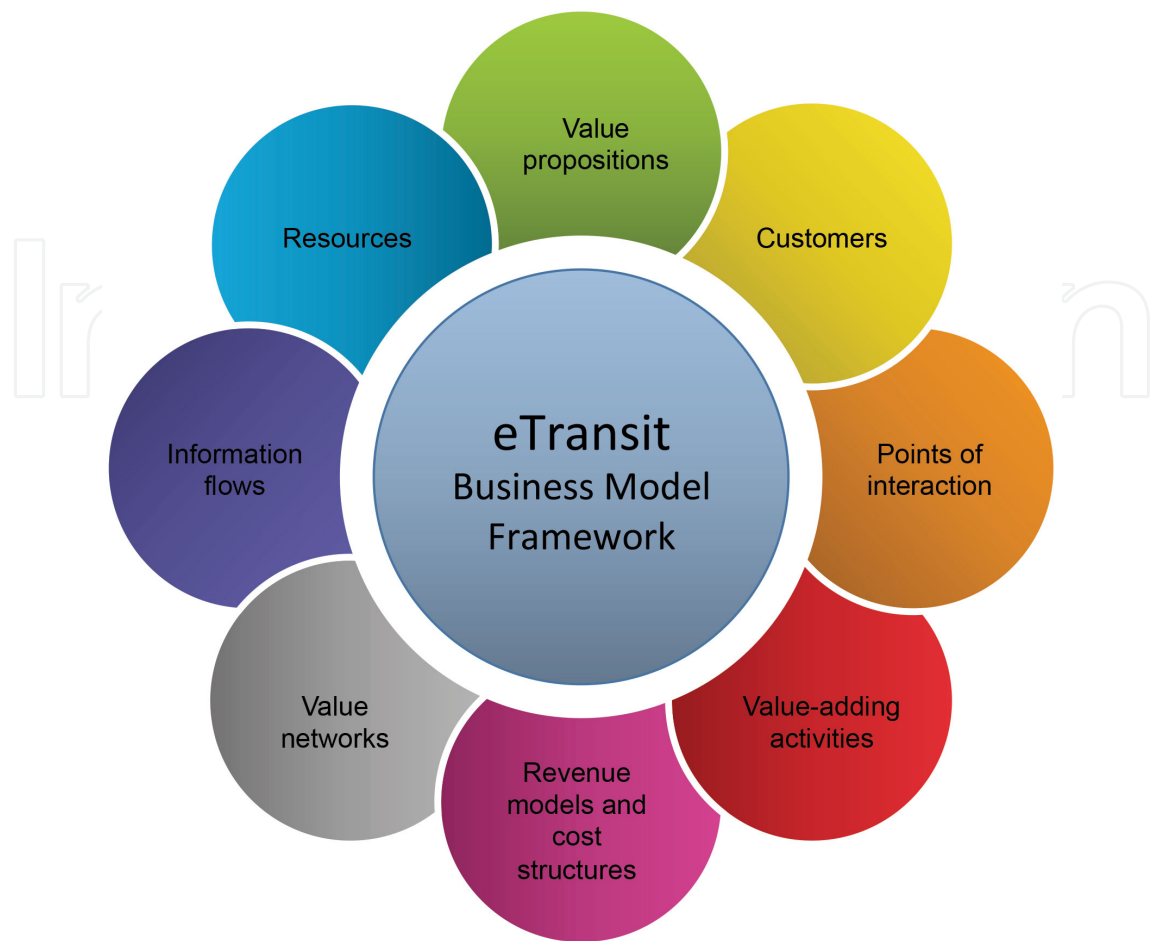

**Figure 8.** The eTransit Business Model Framework

The Framework is an extension of BMs put forward by *Place to Space* [11], *Canvas*<sup>6</sup> and *Visor*<sup>7</sup>, to allow a deeper investigation and modeling of transitions between different *business channels*, or *implemented workflows*. *Viewpoints* of the Framework are:

- Value Propositions
- Revenue models and cost structures
- Value network
- Value adding activities
- Information flows
- Resources
- Points of Interaction
- Customers

<sup>6</sup><http://www.businessmodelgeneration.com/canvas>



In our supplementary methodology we *configure* a selection of the eight different viewpoints into a solution of a given use case. This configuration constitutes *design and implementation of the corresponding SLA* of previous section.

The starting subset of eTransit supporting our specification of SLAs is (Section 3 and Section 5) is:

- *Value proposition* (VP): A package of a solution and a product / service offered to a specific customer segment of a use case
- *Revenue Model* (RM): Sources of revenue for a VP
- *Points of Interaction* (PI): Workflows related to a VP are implemented as different *channels* with information check points at PIs (Figure 9)
- *Resources* (Rs): Critical tools for a company in order to create and deliver its VP

The workflows are determined by the SLA of the use case. A workflow is a *chain of services* connected at PIs (Figure 9). The corresponding *information flow* has *inspection points* at PIs that are monitored and controlled by the SLA. Information related to *revenue models and cost structures*, of each workflow, is *collected for each stakeholder* of the SLA at the PIs.

We have suggested *separating the design and implementation of workflows in channels* (Figure 9), by using the identified BM models as *meta-models* for the channels. Specific *implementation models* for each channel are refinements of those meta-models meeting specific requirements for the selected channel (Figure 5 – 7). This allows *reuse and reconfigurations* of workflows in *different channels* with *invariant meta-models* (Figure 9). In short, it allows *cost efficient and reliable management and change of business channels*.

The starting points for design and implementation of SLAs are:

- *Identification from the use case* the related Value Proposition (VP), Revenue Models (RM), and Customer views (C)
- *Identification of Value Network* (VN) and Resources (R)
- *Identification of Information flows* (IFs), workflows (WFs) and Points of Interaction (PIs)

Key issues related to the translation of meta-models onto suitable implementation models include (Figure 6 and Figure 7):

- *Identification of suitable goal architectures* supporting flexible use
- *Identification of suitable sets of protocols* to support implementation, testing and validation
- *Agreements* on suitable *Key Performance Indicators* (KPIs) to be monitored
- *Selection* of suitable protocols and inspection methods at PIs to ensure *interoperability and trustworthiness* (Figure 9 and Figure 10)
- *Selection* of proper services to be trustworthy outsourced, e.g., payment services



The methodology has to be refined and tested but is based on similar methodologies supporting implementations of *Service Oriented Systems (SOS)* such as *Multi Agent Systems (MAS)* [6].

It is important to note that the identification of a VP, together with Revenue Models and Cost Structures, will provide a ‘skeleton model’ as a starting point. It should also be noted that *payment solutions* and the *roles and status of suppliers* are of big concerns for seller – buyers and should therefore be specifically addressed by the SLAs.

Related works in other domains are reported in [12]. In this case health care systems supporting patient oriented decision-making aiming at increasing patient safety.

#### 4.1. Cognitive interaction patterns

The following Figure 9 illustrates a VP with associated WFs, implemented as channels, with PIs generating and controlling the related information flows. The information collected and processed will monitor and control the execution of a use cases in accordance with agreed upon SLAs. Related costs and revenues are collected and distributed among stakeholders.

Our findings from evaluations of the interviews in the project eTransit [10] suggest the following two complementary strategies to implement cost efficient and resilient e-Commerce solutions:

- Preparedness for flexibility and trustworthiness
- Minimizing costs for maintenance

The separation of meta-models and implementation models also allows assessments of *transitions* between different channels (for example mobile/stationary solutions) meeting different customer needs.

A closer analysis of different policies that can be implemented at PIs of different channels can greatly influence the decisions made by customers at those points.

The purpose of our design and implementation of Cognitive Interaction Patterns is to translate a VP into Workflows to be assessed by potential customers. The goal is, of course to guide the customer to make an educated decision on the proposed VP! The next issue is thus related to decision support.

*Classical Decision support systems* are based on models of *Rational Reasoning*.

This subject has been investigated from a computational point of view since 1950’s. Research areas include *Artificial Intelligence (AI)*, *Agent technologies (AT)* and *Multi-Agent Systems (MAS)*. Rational reasoning is based on formal (mathematical) models such as different logics or statistical models. The strength is that we can reason about the reasoning (proofs or validations) [13, 14]. A weakness is that human decision-making is not always rational in the objective sense but often *subjective rational*.

There is at present high international focus on developing ‘smart’ distributed networked systems in areas such as Smart grids and Smart healthcare. Those kinds of ‘smartness’ can be

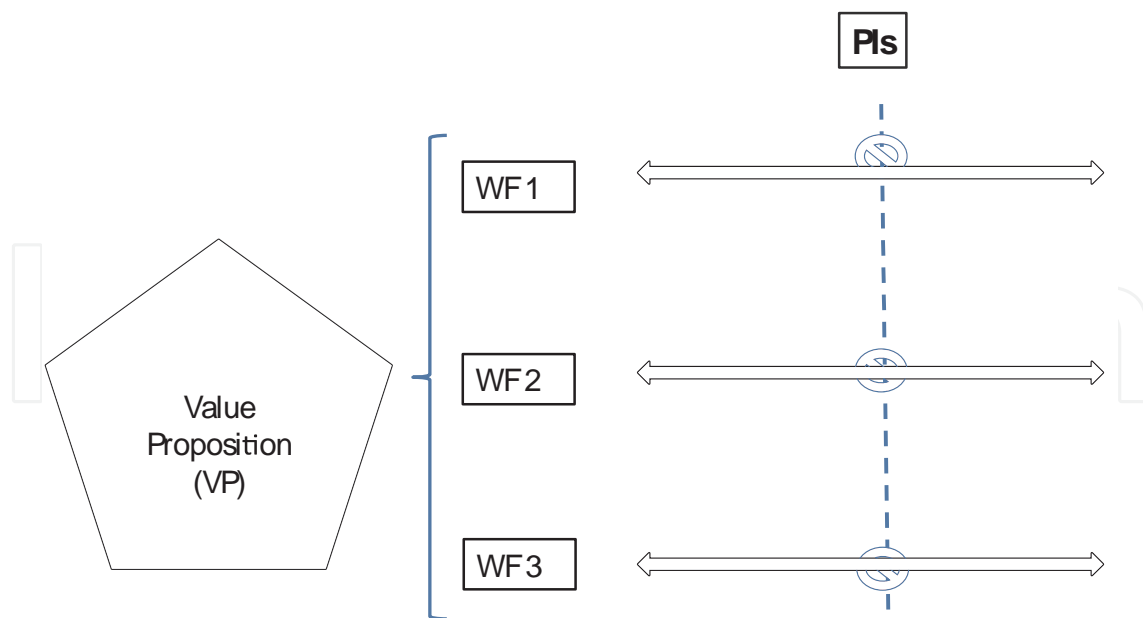

Information exchange at PIs related to Workflows

**Figure 9.** Some relations between VP, WFs and PIs

modelled as service oriented systems (Multi-agent Systems) with intelligent interfaces (APIs) implemented using AI technologies [15].

*Behavioural and experimental economists* have in recent years successfully challenged the conventional view that individual actors make decisions purely by trading off expected costs and benefits (i.e., the “unbounded rationality” model) and suggested that behavioural predictions should be based on a *bounded rationality* framework instead [16]. The bounded rationality framework has generated a range of insights that apply to design and implementations of suitable PIs related to selected VPs!

By definition a *default* is a condition that is imposed when an individual fails to make a decision. Research and practice show that it is possible to *significantly impact people’s behaviour* by carefully setting the default. For example, when asking for consent to store personal data online for marketing purposes, consent rates are higher when consent is the default (i.e., a “presumed consent” model) compared to a situation where the default is no consent (i.e., an *explicit consent* model) [17, 18, 19].

The bottom line is that designers of IP policies for e-Commerce applications should learn how to *customize* Interaction Patterns in a proper way to empower and learn more about their customers. In short we can combine rational information sharing between system components and bounded rational information sharing with or between human actors while maintaining interoperability assuring *shared and common understanding* of states of a use case [20, 21]. These insights are important in addressing Increasing Energy Efficiency by Reducing Losses and Promoting Value Propositions in future Smart grids.

## 5. Suitable cost and revenue models for future smart grids

Value Propositions and related workflows are illustrated in the following Figure 10. Inspection of message contents and distribution of messages to involved stakeholders of a VP is taken place at *Points of Interaction* (PIs) along the workflow. The workflow is implemented on suitable channels of the information systems.

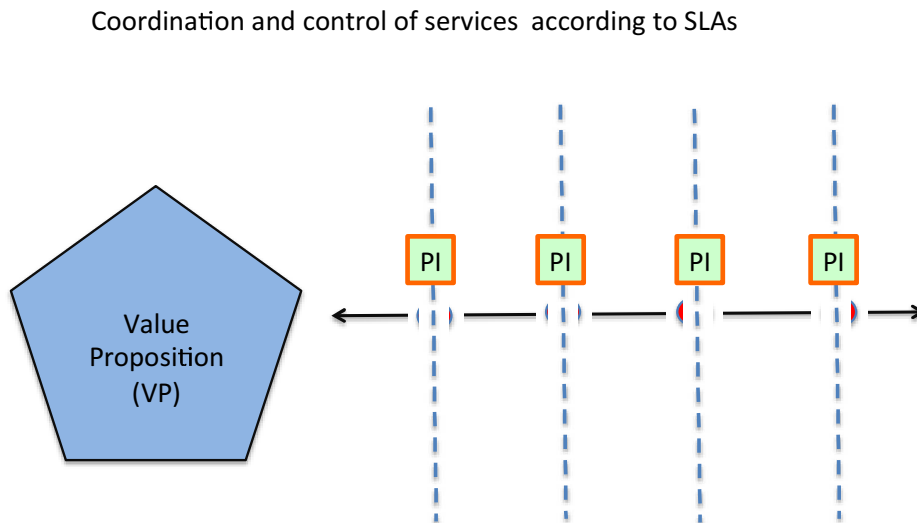

Information inspections and exchanges along Workflows are at Points of Interaction (Pis)

**Figure 10.** A VP of a use case involves stakeholders and services and information flows defined by the SLA.

The information monitoring and control of the workflow, governed by the SLA, is managed at the Points of Interaction (PIs) along the workflow (Figure 10). The information management to all stakeholders of the VP is supported by suitable cognitive interaction patterns (Section 4.1).

There are different aspects of customer oriented Value Propositions. *Firstly*, we have VPs in application areas directly related to energy services. *Secondly*, we have VPs of services utilising parts of the Smart grid infrastructures to support, for example, comfort of living and/or health care.

In this chapter we focus on the following customer oriented VPs related to energy services:

- Power Quality (Section 5.1)
- Cutting losses in power distribution (Section 5.2)
- Smart Home Services enabled by Service Level Agreements (Section 5.3)

## 5.1. Power quality

In order to maintain the grid and to meet system performance requirements, the following set of ancillary services have been identified and implemented:

- Operational reserve
- Frequency control
- Reactive power and voltage control
- Short-circuit capacity
- Voltage quality
- Black-start
- Island operation of the grid
- Inertia
- Stability

The responsible stakeholders for quality and efficiency of the traditional regulated power systems are the utilities (TSOs and DSOs). Besides the main tasks of generation, transmission and distribution of power, the utilities also are responsible for *ancillary services related to system protection, Supervision and Control (SCADA), and billing*. Today, most of the ancillary support systems are hence *closed and proprietary*. In the traditional regulated power market those ancillary services were provided by the (state-own) utilities. The specific costs were implicit and as such hidden from the customers.

One of the main traits that differentiate existing power markets from the vertically integrated monopoly of the past is the *changing ownership of the product*, electric energy, as it moves from the generating plants (sources) to users premises. Although ownership changes hand with price variations, electrical energy is regarded as a homogenous product irrespective of which generating source it comes from and what resources are used to produce it. This is fortunately a sufficient definition for the power market to operate on as it is not necessary to have any differentiation when dealing with units of energy only.

However, this model is not suitable for handling power quality by itself. Power quality is classically not a sellable product. It is an attribute or value-added feature of another product, electrical energy. On the other hand, modern industrial processes with new types of electrical equipment are *increasingly adversely affected by poor power quality* than the traditional equipment. In addition integrated manufacturing supported by extensive automations and our today's individual way of life are more dependent on good quality of electricity than ever.

The goal of deregulation is to enhance competition and to bring to customers new choices and economic benefits. We argue that *Markets of Services based on power quality* could be based on *generalized* bilateral agreements between customers and providers. Those Service Level Agreements (SLAs) could become an *coordination and monitoring* mechanism between stakeholders of different energy based markets [27]. In the paper *A conceptual view of Power Quality*

*Regulation Using Market-Driven Mechanism* [25] the authors suggest to employ market mechanisms to regulate power quality. However, in order to successfully identify and sell power quality services we have to identify and market value added Value Propositions (VPs) to customers. Those issues are treated in Section 4 and later in this section.

Challenges related to Ancillary services of Smart grids are mainly due to the distributed character of such systems involving new types of stakeholders and Distributed and Renewable resources (DER/RES) supporting active *prosumers* (*producers – consumers*) in agile and changing energy based business processes. The roles, stakeholders, responsibilities and business models of Smart grids are evidently completely different from those homogenous utility-based models of classical power grids. Focus of current R&D on Smart grids have been on energy-centric services and related smart energy markets. *Market models* related to *ancillary services* of Smart grids, e.g., business and cost models, remains to be identified and implemented. This will, of course, require changes of the corresponding regulatory frameworks. This necessary transition also requires deeper insights in the economic, societal, technical and environmental constraints to be assessed and resolved [23, 24].

Future smart grids will be based on two key ingredients: *intelligence* and *power electronics*. Intelligence or ‘smartness’ will be based on *agent technologies* applied to *components and interfaces* to allow context dependent configurations and instantiations of service based systems coordinated by Service Level Agreements [9].

Energy losses in the present power grid T&D are typically around 10%. Those losses are mainly due to resistance and imbalance of active and reactive power. The use of *FACTS* (Flexible AC Transmission Systems) has been successful for the Transmission net [22] and are now also investigated for the Distribution nets.

The importance of issues related to Power Quality (PQ) is mainly due to the increasing number of disturbing loads and increasing number of RES/DER. Main references are *Power Quality Indices in Liberalized markets* [23], *A Conceptual View of Power Quality Regulation Using Market Driven Mechanism* [25] and *Quality of Electricity Supply as a Service* [26].

We adopt the following definition of PQ [27]:

- The ability of power systems to operate loads without disturbing or damage them.
- The ability of loads to operate without disturbing or reducing the efficiency of the power system.

That is: PQ is a *common concern* between producers and consumers of power. That is, *suitable to address* as SLAs!

Power quality disturbances defined by *indices and objectives* are important tools in our demonstrators supporting Power quality Markets [23]. PQ indices represent a *compact way* to describe the characteristics of PQ disturbances as single numbers

An important class of PQ disturbances is due to voltage sags. Identifying and detecting voltage sags are therefore an important issue in identifying and monitoring SLAs between producers and consumers in a PQ Market. Proposed methods identifying sources of voltage sags

(inferring responsibilities in cases of low probability of simultaneous disturbances) are based on, e.g., the following models [23]:

- Disturbance power and energy approach
- Slope of the system trajectory approach
- Real current component approach
- Resistance relay approach

As a case study we shortly describe the main features of the *Resistance sign* approach. The following Equivalent circuit for sag source detection is from [23].

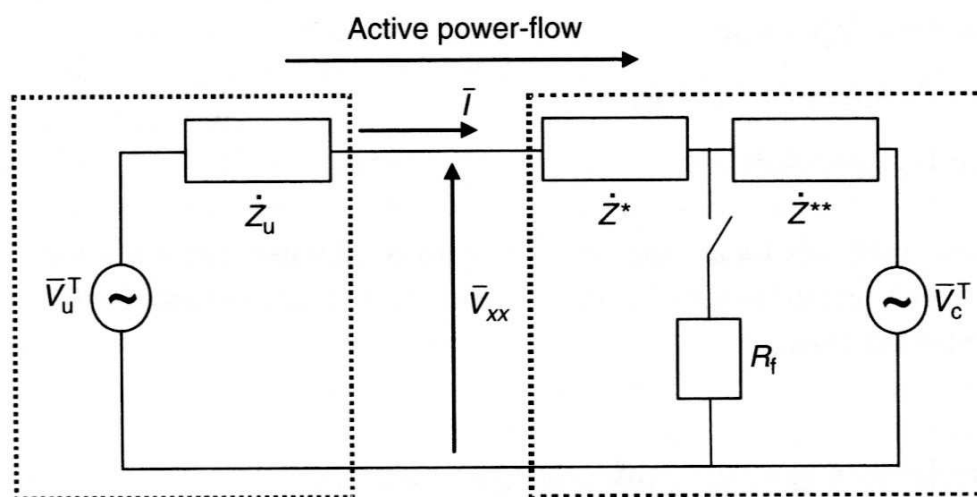

**Figure 11.** Equivalent circuit for voltage sag detection

Let us refer to Figure 11 in which the right side represents the customer installation ( $Z^* + Z^{**} = Z_c$ ), while the left side represents the utility supply system. Setting up the equations *at the customer side*, before and after a fault, and performing some calculations ([23] pp. 128 -129), we can deduce that:

- If  $\text{Real}(Z_c) < 0$ , the impedance (multiplied by -1) is the *utility impedance* and the *fault is on the customer side*.
- If  $\text{Real}(Z_c) > 0$ , the impedance is the *customer impedance* and the *fault is on the utility side*.

More examples of modelling and detecting responsibilities, related to Power Quality indices, between customer and utility are given in [24].

Economic aspects of PQ disturbances, based on economic schemes, have become increasingly important due to the current capability to quantifying the economic consequences associated with disturbances in power systems [23]. The true economic value of PQ markets is linked to the effects that PQ disturbances have on equipment and other loads:

- Downtime disturbances causing lost production



- Additional costs related to maintaining equipment and reducing the effects of disturbances
- Existing methods for economic evaluation of PQ disturbances are mainly focused on voltage dips and harmonics

We argue that SLAs are useful tools to set up and maintain PQ markets. The PQ concerns between stakeholders in a use/business case can be expressed as SLAs using suitable indices and concerns. We can use our frameworks (Chapters 4 and 5) for setting up and monitoring suitable SLAs. In short:

- PQ agreements establish a *common concern* between producers and consumers of power. For example settling the investment costs on either side.
- Those concerns related to power disturbances can be expressed by selections of *suitable indices* and objectives
- The indices are composed by *measurable attributes* of the indices

The following Figure 12 captures the main ideas. The red rectangle illustrates the footprint of a SLA Coordinating services and stakeholders of a given use/business case (e.g., Power Quality markets). The footprint identifies interoperability Categories, layers of the GSAM framework (Figure 6), and selected Cross-cutting Issues identified by the SLA. The SLAs orchestrates Coordination, Monitoring and QoS of the services. Proper data aggregation, handling and transformations support semantic interoperability across the Smart Grid plane (Figure 5 and Figure 7).

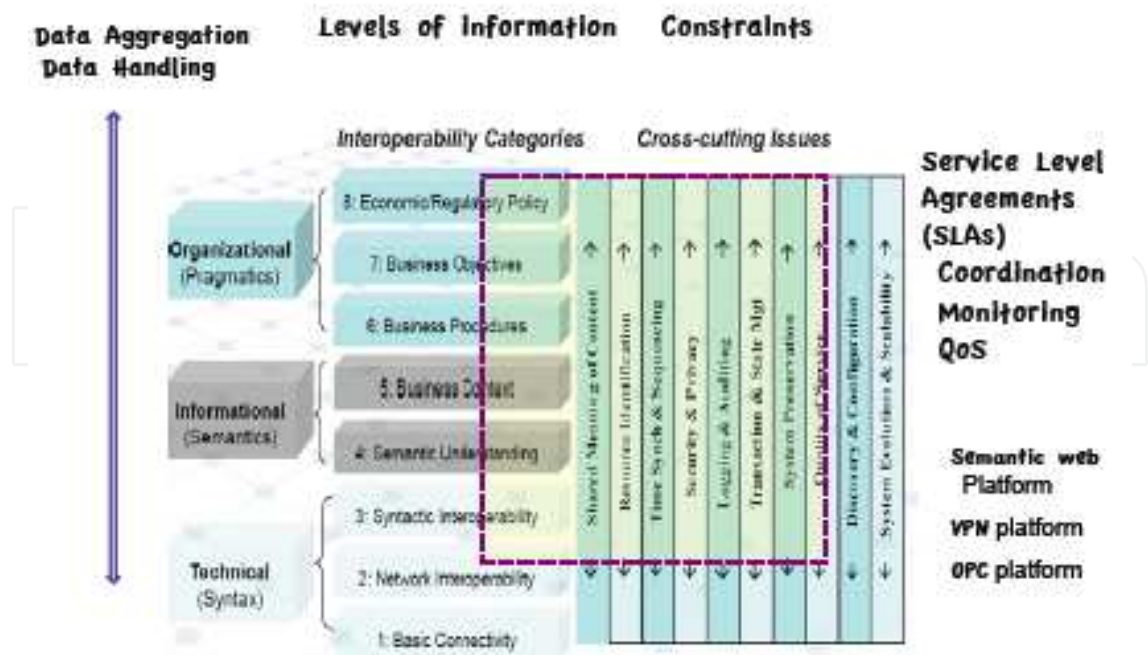

Figure 12. Footprint of SLA in the Interoperability framework

Furthermore, during the different development phases the components of the SLA have been addressed. Specifically, issues related to *resolving potential conflicts* (investments) or interoperability issues.

## 5.2. Cutting losses in power distribution grids

*State estimation* of the power system from real-time measurements is one of the most important elements of modern Energy Management Systems and are currently deployed and used by electric utility companies.

A promising technology to cut losses in power systems is to introduce *Phasor Measurement Units* (PMUs) to enhance efficiency, performance, and reliability in existing electric power system infrastructure<sup>8</sup>. A *Phasor* refers to *measurable AC power components* of Figure 2. The PMUs are connected in *Wide Area Networks* (WAN) to allow for large area views of the network. Comparing data between points on an electric system is a good way to reveal stress on the system and home in on the source of the problem. PMUs *monitor the characteristics of electricity flowing through a particular location*, for instance, at the point where a generator connects to the bulk power system, or at a substation. The ability to compare *time-synchronized* data on the same timescale, among widely separated locations, is a relatively new achievement, based on:

- *Speed*. PMUs make measurements at short time intervals – typically 30 times per second – significantly faster than traditional SCADA systems
- *Synchronization*. All PMUs across an interconnection are kept in precise time synchronization using GPS. This synchronization provides the capability to easily compare systems data among geographically dispersed units, creating wide-area visibility across large power systems. This was not previously possible using older technology

The synchronized phasor measurement (PMU) technology is relatively new, and consequently several research groups around the world are actively developing applications of this technology. It seems clear that many of these applications can be conveniently grouped as follows:

- Power system monitoring
- Advanced network protection
- Advanced control schemas

The *North American SynchroPhasor Initiative* (NASPI) supervises instalments and assessments of several PMU installations [28].

A PMU collects and time-stamps data at a point. This data is then *processed and reacted on* according to a selected application.

In a *self-healing system* we have to implement the following cycle of tasks:

1. *Detection* of a fault

---

<sup>8</sup> [http://en.wikipedia.org/wiki/Phasor\\_measurement\\_unit](http://en.wikipedia.org/wiki/Phasor_measurement_unit)

2. *Localisation of the fault*
3. *Repairing of the fault*
4. *Restart of system*

The PMUs can directly assist in the first two steps for grids. The remaining steps have to be addressed as add-ons to the PMU system.

We have designed and implemented a pilot of self-healing on Smart grids in the EU Project INTEGRAL [29].

#### 5.2.1. *Microgrids and renewable energy sources*

We can think of the *Microgrid* as the great equalizer between consumers and the electrical companies. With centralized local power generation, businesses, communities and even towns can have a say in the generation and distribution of local energy.

A Microgrid is a scaled down version of the traditional power grid that most people are familiar with. A Microgrid can be as simple as having a power source like a generator hooked up to a load like a commercial business. A Microgrid can also consist of distributed energy resources (DER) like solar PV systems and wind turbines that have several electrical loads. These Microgrids can operate independently or in parallel with the traditional power grid.

Because Microgrids can rely on local sources of power generation and also pose a lower demand on the grid infrastructure, large institutions like prisons, campuses and military operations, large commercial and industrial markets or remote settings that are off grid are realizing the benefits of building and maintaining their own Microgrid.

Benefits of Microgrids include:

- Increased efficiency – with the source of generated electricity so close to the use, very little energy is lost in transmission
- With fewer load sources, demand on the Microgrid infrastructure is less than a typical grid
- By being smaller and closer to source and demand and being able to use power generation more specific to the location, the system has higher reliability and is able to respond to demand more quickly
- Microgrids are laid out in a modular manner making expansion and updating more efficient
- With local control, both design and future planning are specific to the needs of the entities participating in the Microgrid
- Because the Microgrid can shut itself off from the main grid (islanding) it is less vulnerable to outside attacks, being cyber or physical

Barriers to the development and running Microgrids include:

- Lack of standards from operations, safety and integration to data on power quality from different sources.

- Legislation and regulations need to be addressed for regulating the operation of Microgrids in many countries.
- Installation costs of distributed energy resources such as solar and wind, may be too great for some areas.
- Lack of technical experience, infrastructure and communication protocols.
- Possibility of market monopoly if no infrastructure is in place to guard against pricing abuse.

Microgrids have to be fitted into the modernization of the current electrical grids that service the world. With increasing volatility to brown or black outs and physical or cyber attacks, Microgrids can keep important services running during any disruptions to the main grid.

We are presently testing technologies of Microgrids with basic components delivered by Hughes Power Systems [30]. We will implement a *Tests site* aiming at implementing smart protection and detection systems enabling, for instance, cutting losses in the distribution system. Specifically by installing products for minimising the number of interruptions (SAFI), the number of interruption minutes (SAIDI) and distribution losses.

We aim at implementing *self-healing capabilities of faults*. That is, *Smart Protection Systems for Microgrids*. Detection and Localisation is facilitated by new 3-Phase *Autoreclosers* (Vacuum Interupter Modules). Smart *automatic sectionalising* is enabled by Autoreclosers together with *distribution transformers* (with very low losses and with on-load tap). We will address a selected subset of the Technical losses listed in Section 2.3.2. Specifically losses related to:

- Lengthy Distribution lines
- Inadequate Size of Conductors of Distribution lines
- Installation of Distribution transformers away from loads centers
- Low Power Factor (PF) of primary and secondary distribution systems
- Bad Workmanship
- Feeder Phase Current and Load Balancing

The configuration of the Test site is given in Figure 13.

The *Repair, Restoring and Reporting* services will be implemented as a set of suitable smart knowledge bases enabling collecting and handling the local information generated by the Autoreclosers.

Repairing might include reconfiguration of the distribution net to cut losses or increase performance. The reporting module also incorporates a learning mechanism to improve the total performance.

The experimental environment will also be a test bed for selected business cases related to energy based service markets.

### Small Scale Embedded Production Units (SSEPU)

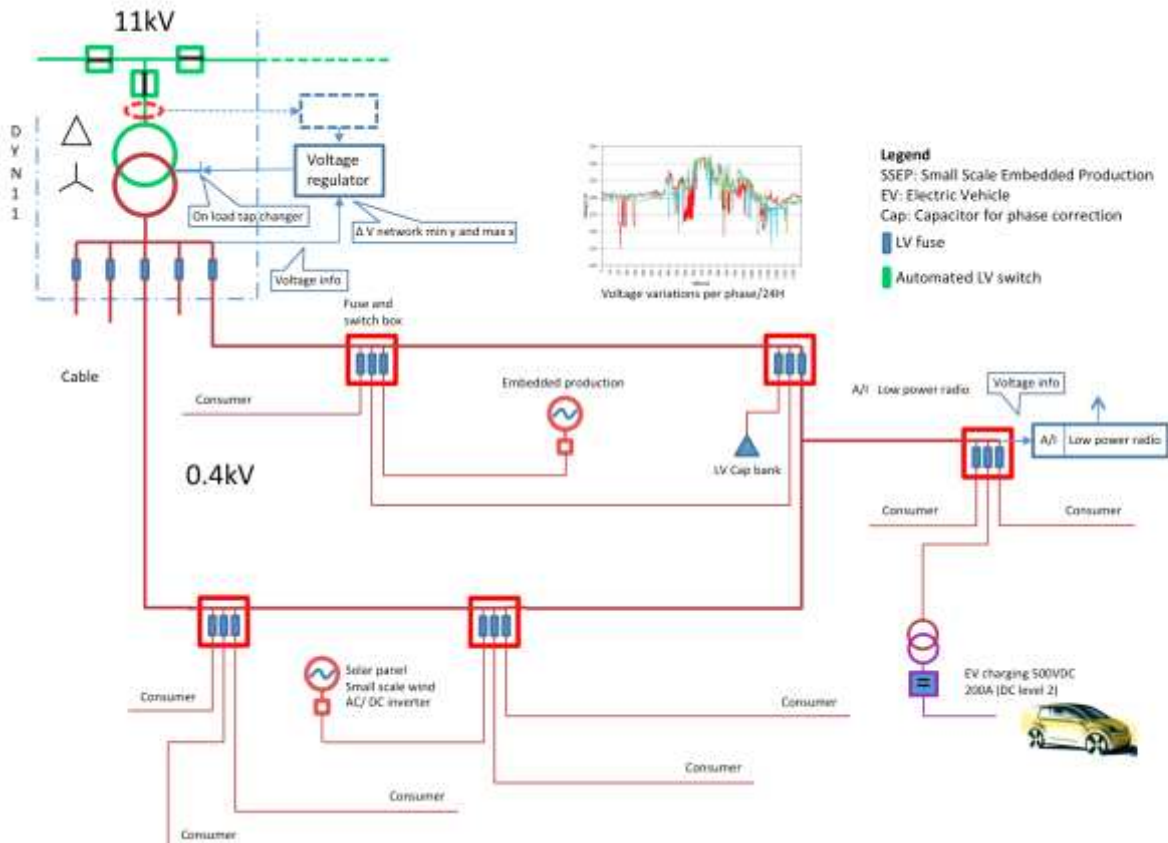

Figure 13. Smart equipment supporting cutting losses in distribution grids

### 5.3. Smart home services enabled by service level agreements

Smart and Green Building are active areas of R&D related to future Smart grids and active customers<sup>9</sup> (Figure 14). We will select a use case illustrating *Comfort management* in Smart buildings, main own reference are [9, 31 and 32].

The concepts of Service Level Agreements (SLAs) have gain recognition and acceptance with the increasing demand of services in our societies. It is noticeable from ICT business offers, that tariffs are regarded as an old inflexible generic form of service level agreements. The deregulation of the telecommunication sector highlights the issues related to services and related technologies to meet the demands of new business opportunities. As a consequence, the organization *TeleManagement Forum* (TM Forum) has developed a set of technologies and tools, such as *Frameworks*, to support running and renewing service businesses in that sector.

Understandably, the work and results from TM Forum, including SLA management, are valuable inputs to design and implementation of SLAs for Smart grids. For instance, Smart grids presuppose a deregulation of the electric power market towards a service-oriented

<sup>9</sup> [http://ec.europa.eu/information\\_society/activities/sustainable\\_growth/docs/sb\\_publications/smartbuildings-1d.pdf](http://ec.europa.eu/information_society/activities/sustainable_growth/docs/sb_publications/smartbuildings-1d.pdf)



market, similar to the deregulation of the telecommunication market. However, there are some fundamental differences between the domains.

TM Forum work on SLAs is an important input to SLAs supporting Smart grids. However, due to the different nature of smart grid we have to address the following specific additional challenges:

- SLAs between different groups of multiple stakeholders
- SLAs involving different sets of real-time constraints. That is, interactions between high- and low-level SLAs.
- SLAs supporting setting up and validating interoperability in Smart grids.

Firstly, formulation of agreements needs business cases with identified stakeholders (roles, capabilities and responsibilities). Secondly, relevant tasks to be coordinated among stakeholders should be identified. Thirdly, non-functional constraints (performance, security, Quality of Service, etc.) should be identified and taken into account. To do that, the stakeholders should agree upon KPI (Key Performance Indicators) to be implemented and monitored according to the agreements.

Important application areas of Smart Grids are Smart and Green Buildings, Figure 14.

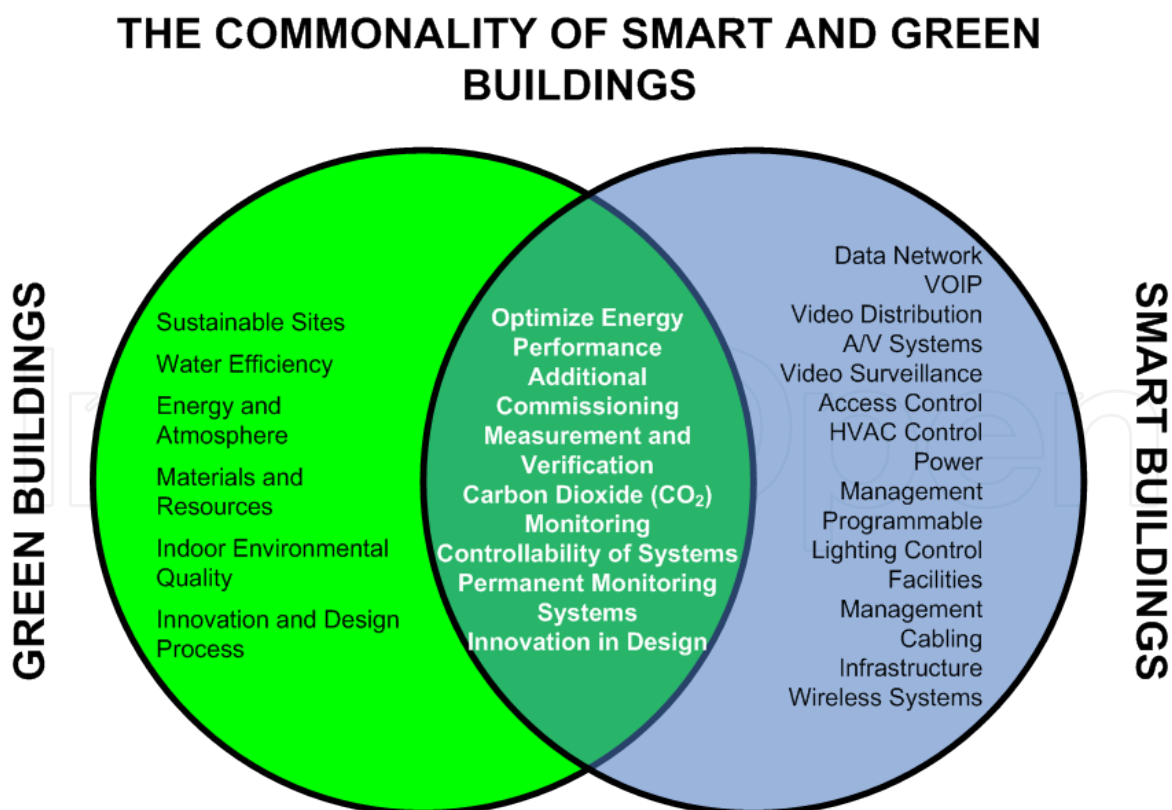

Figure 14. Common application areas of Smart and Green Buildings

Our selected use case, smart home services, is a typical example where we need coordination between high-level and low-level SLAs (Figure 7). The high-level SLA guarantees that the *user perceives and accepts* the desired comfort level, set by the control system. The low-level SLA monitors and *controls the settings of the associated physical system*. Thus we have to address and solve the *challenge of trustworthy translation between perceived subjective parameters and settings of physical objective parameters*.

As presented in Figure 7, the key drivers in more complex business cases of Smart grids are SLAs that holds a strong interaction between the higher-level business cases and low-level affordances of the infrastructure.

We model our use case as follows:

#### *Stakeholders*

- Customer (C)
- Smart house agent (SHA)
- Market aggregator (MA)
- Operation agent (DSO)
- Service provider (SP)

#### *Scenario*

The Market Aggregator (MA) offers a range of services (VPs Figure 8) to the Customer (C). Among those is Comfort management. This service is delivered to C by the SHA in cooperation with SP. SP is responsible for instalment, monitoring and control of smart equipment at customer premises. DSO, together with SHA and MA monitor and control the energy flow associated with a given service. The MA is also responsible for the monitoring and billing of the services to C.

#### *Implementation*

The Comfort management systems is modelled and implemented as a *Multi Agent System* (MAS) consisting of the agents C, MA, SHA, DSO and SP. The coordination and control of the MAS is governed by the factual set of High-level and Low-level SLAs. Agents are grouped into the two bundles of SLAs. Firstly, a high-level business related set, SLA-high, between the agents C, SHA, SP, and MA. Secondly, a real-time constrained set represented as SLA-low, between agents MA, DSO, SP, and SHA. SP runs coordination between the SLA sets.

#### *Challenges*

The comfort level identified by the customer is represented in a *set* {good, acceptable, not acceptable, not-good}. The following physical (objective) parameters of the customer premises are monitored and controlled by SP:

- Temperature
- Lighting

- Sound
- Humidity
- Air circulation
- Allergy indicators
- Movement indicators

A design challenge is to *identify, implement and validate* an *accepted translation* between the objective sensor readings and the subjective customer values (Figure 5 and Figure 7). This implemented mechanism provides *trustworthy interoperability* of meaning and fulfilment of services according to the SLA (Figure 6).

#### *Requirement Engineering and Validation*

Negotiation of a SLA provides a methodology supporting requirement engineering of SLAs. SLA negotiation tools provides a mechanism to *identify* the concerns of the involved stakeholders in a given use case. Typically, those concerns are expressed in *stakeholder case specific concepts* (ontologies). The next step is to negotiate a common understanding among stakeholders of related concepts.

There are in principle two ways to discover and validate this pattern-matching; *model based* or *experimental based*.

A model-based approach is based on establishing a *formal function* between the different types of parameters. That is:

Comfort is defined by an analytic function  $F$ :

$F(\text{objective\_parameters})$  with value-set {Good, Acceptable, Not acceptable, Not good}

However, this approach is *neither easy nor flexible*. In an *experimental setting* we provide a flexible front-end to the customer with the SP operating the sensor net at the premises of C. By performing a rich enough *calibration* between sets of objective parameters and the customer perceived comfort level we derive a set of tuples  $\Sigma$ , or patterns, connecting objective parameter settings and subjective comfort levels.

$\Sigma(\text{objective parameter values, comfort levels})$

Proper analysis of this set will reveal *sufficient rich patterns to support design of corresponding SLA rule sets*. Setting up the front-end to the customer can *support validation* of the rule sets (Figure 6). Maintenance of the rule sets could also be supported with a similar set up.

#### *Management of SLAs*

After calibration and validation, the system build substantial knowledgebase that can facilitate decision-making based on historic data of the user's behaviour further supporting negotiations of the corresponding SLAs. The customer is given a set of choices to select the desired type of SLA related to comfort levels and price. That is, the *Value Proposition!*

After the negotiation, the system provides monitoring mechanism of SLA to ensure proper QoS of the service (Figure 10).

Exception Handling: In case of indication of system comfort output of “Not acceptable” or “Not good”, generate alerts. The same holds if there is detection of malfunctions of system components.

## 6. Conclusions and future work

This chapter is about Increasing Energy Efficiency by *Reducing Losses* and *Promoting Value Propositions* in AC power systems. *Reducing losses* relates to the *physical processes* of generating, transmission and distribution of electric power. *Promoting Value Propositions* relates to identifying customer oriented value added business cases and processes based on energy based services.

The core of the emerging Smart grid [5] is addressing the challenges of balancing a very complex physical system in real time while meeting customers and societies expectations on energy and energy related reliable services. The overall constraint, however, is meeting the environmental challenges!

In order to give perspectives on those societal challenges we have given some technological as well as business and societal backgrounds and illustrated our suggested solutions with some implemented examples.

Future Smart grids will consist of the following three interconnected types of systems:

1. Systems supporting *Energy management*
2. Systems supporting *Information management*
3. Systems supporting *Business management*

The technological background of systems of types 1 and 2 are grounded in *Smart Grid Reference Architecture* (SGAM) Figure 4, Figure 5 and Figure 6 [4]. Those architecture models illustrate the *inherent complexity* of designing, implementing and maintaining Smart grid solutions.

To complement the views of the SGAM architectures of system 1 and 2 we suggest an *extension* of the SGAM model sets with the *eTransit Business Model framework* (Section 4). This enables modelling the views of System 3 and but also the *interactions* between all three types of system (Section 5).

To deal with this complexity, in *time, space and cyberspace*, we propose *Service Level Agreements* (SLAs) as a *coordinating and monitoring mechanism of business cases*. Figure 7 illustrate how bundles of SLAs can manage the different aspects and types of business use cases.

SLAs can be properly identified and modelled by a vertical and horizontal mapping of a use case onto the SGAM (Section 3). To proper model business cases from different viewpoints we

propose the eTransit Business Model, Figure 8. This framework allows for implementing SLAs into Workflows, Channels and Information flows (Figure 9 and Figure 10).

In this chapter we focus on models supporting *trustworthy information exchange between stakeholders in a business case*. In coordination of a use case interoperability is the *shared understanding by stakeholders of the state of the executed use case*. This requirement is extremely important [20, 21]. A key technology is here designing and implementing *Cognitive Interaction Patterns* (Section 4.1)

Societal demands on Smart grids include requirements on *inclusion of Renewable Energy Resources (RES)* and efforts to decrease the environmental negative effects of energy production. To illustrate some of the challenges we indicate the expected total energy consumption 1990-2040 (Section 2.1). *Challenges and problems in comparing* different energy sources are discussed in Section 2.2.

In Section 5 we give some examples of customer centric use cases (Value Propositions) to increase energy efficiency and/or to add customer value:

- *Power Quality* (Section 5.1)
- *Cutting losses in power distribution* (Section 5.2)
- *Smart home Services* (Section 5.3)

Future work includes investigations of *Value Propositions (VPs)* in areas of comfort or Health. Those VPs can be based on energy systems such as Microgrids (Section 5.2.1 and Section 5.3) as in Figure 14.

In defining and discussing proper *Cost and Revenue Models* we refer to Figure 1 with the interpretations; *Total Cost*, *Customer paid cost* (Value Proposition) and *Investment cost* (Private & Public) giving a balance that drives societal acceptable products and services.

Finally, it should be observed that future Smart grids have some commonalities and differences with systems classified as instances of *Cloud computing*<sup>10</sup>. In this setting Smart grids could be modelled *three interacting Platform – as – a – Service (PaaS)* cloud systems. That is, as we earlier have stated: Energy system management, Information management systems and Business management systems. Having said that, we believe that Smart grids and Cloud computing systems could benefit from sharing lessons learned.

This observation is enforced by the *Report on the public consultation for the EU H2020 Work Programme 2016-17: Cloud Computing and Software*, Final version 2014-12-04<sup>11</sup>, that states:

“Attention should be placed on the non-functional aspects of cloud-based applications and services including SLAs and performance optimisation of real-time, cloud based applications and services, and increased energy efficiency through the exploitation of hardware advances, lightweight virtualisation techniques, and intelligent auto-scaling algorithms.”

---

<sup>10</sup>[http://en.wikipedia.org/wiki/Cloud\\_computing](http://en.wikipedia.org/wiki/Cloud_computing)

<sup>11</sup> EGI recommendations for the Horizon 2020 Work Programme 2016-2017, <https://documents.egi.eu/document/2320>



## Acknowledgements

We gratefully acknowledge the cooperation in the eTransit project with our colleagues from the School of Business and Economics at Linneaus University in Sweden and Institute for Advanced Management Systems Research (IAMSR) at Åbo Akademi University in Finland with the support from Peter Wallenbergs Foundation.

## Author details

Rune Gustavsson<sup>1\*</sup> and Leif Marcusson<sup>2</sup>

\*Address all correspondence to: rune.gustavsson@lnu.se

1 KTH, Stockholm, Sweden

2 Linneaus University, Kalmar, Sweden

## References

- [1] U.S. Energy Information Administration (2013): *International Energy Outlook 2013*. DOE/EIA 0484(2013)
- [2] Frank, C. R (2014): *The Net Benefits of Low and No-Carbon Electricity Technologies*. Global Economy and Development at Brookings. Working Paper 73, May 2014.
- [3] Parmar, J (2013): Total losses in Power Distribution and Transmission Lines. In *Transmission and Distribution Electrical Engineering Portal (EEP)*. Posted August 19, 2013
- [4] European Smart Grids Technology Platform: Home page [http://cordis.europa.eu/technology-platforms/smartgrids\\_en.html](http://cordis.europa.eu/technology-platforms/smartgrids_en.html)
- [5] European Technology Platform (2012): *SmartGrids SRA 2035 – Strategic Research Agenda*. Update of the SmartGrids SRA 2007 for the needs by the year of 2035
- [6] Gustavsson, R. and Hussain, S. (2014): The Proper Role of Agents in Future *Multi-Agent Systems PAAMS 2014 International Workshops*, pp. 226 – 237. Springer Verlag.
- [7] Gustavsson, R. (2012): Promoting Increased Energy Efficiency in Smart Grids by Empowerment of Customers. Invited book chapter in *Modeling and Optimization of Renewable Energy Systems*. InTech Open Access Publisher, 2012, ISBN 7978-953-308-487-9
- [8] CEN-CENELEC-ETSI Smart Grid Coordination Group (2012): Smart Grid Reference Architecture (SGAM), v 3.0. November 2012
- [9] Gustavsson, R., Hussain, S. and Nordström, L (2011): Engineering of Trustworthy Smart Grids Implementing Service Level Agreements. In *Proceedings of 16<sup>th</sup> Conference*

- on Intelligent System Applications to Power Systems*. September 25 – 28, 2011, Greece, 2011
- [10] The eTransit project (2013): A collaboration project between School of Business and Economics Linneaus University in Sweden and Institute for Advanced Management Systems Research (IAMSAR) Åbo Akademi University in Finland with a grant from Peter Wallenbergs Foundation
- [11] Weill, P. and Vitale, M. (2001): *Place to Space. Migrating to eBusiness Nodels*. Harvard Business School Press; Boston, Massachusetts
- [12] Ådahl, K. and Gustavsson, R. (2011): Decision Support by Visual Incidence. Invited book chapter in *Efficient Decision Support Systems: Practice and Challenges – From Current to Future*. InTech Open Access Publisher
- [13] Shapiro, S.C (Editor) (1992): *Encyclopedia of Artificial Intelligence*. John Wiley & Sons, Inc.
- [14] Pearl, J. (2000): *Causality Models, Reasoning, and Inferences*. Cambridge University Press.
- [15] Wooldridge, M. (2002): *An introduction to MultiAgent Systems*. John Wiley & Sons Ltd.
- [16] Kahneman, D., (2011): *Thinking Fast and Slow*. Penguin Books.
- [17] Brown, C., and Krishna, A. (2004): The skeptical shopper: A metacognitive account for the effects of default options on choice. *Journal of Consumer Research*, 31, 529-539.
- [18] Herrmann, A., Goldstein, D.G., Stadler R., Landwehr, J.R., Heitman, M., Hofstetter, R., and Huber, F. (2011): He effect of default options on choice – Evidence from on-line product configuration. *Journal of Retailing and Consumer Services*, 18, 483-491.
- [19] Menzel, S. (2013): Are emotions to blame? – The impact of non-analytic information processing on decision-making and implications for fostering sustainability. *Ecological Economics*, 96, 71-78
- [20] Lundberg, J. and Gustavsson, R. (2009): Robust approach toward context dependent information sharing in distributed environments. In *Proceedings of 11<sup>th</sup> International Conference on Enterprise Information Systems*, Milan, Italy, 2009
- [21] Lundberg, J. and Gustavsson, R. (2011): Challenges and opportunities of sensor based user empowerment. In *Proceedings of 8<sup>th</sup> International Conference on Networking, Sensing and Control ICSNSC 2011*, Delft, The Netherlands, 2011
- [22] P.K Steimer, P.K. (2011): Enabled by High Power Electronics – Energy efficiency, Renewables and Smart Grids. *Proceedings of The 2011 International Power Electronics Conference*.
- [23] Pierluigi, C., Carpinelli, G., and Verde, P. (2009): *Power Quality Indices in Liberalized Markets*. Wiley 2009. ISBN: 978-0-47003395-1
- [24] Caramia, P., Carpinelli, G., and Verde, P. (2009): Assessing Responsibilities between Customer and Utility. Book Chapter in *Power Quality Indices in Liberalized Markets*. Wiley 2009.
- [25] Chen, S., Wang, C.J., and Lie, L.T. (2006): A Conceptual View of Power Quality Regulation Using Market Driven Mechanism. *Proceedings of PowerCon 2006*.

- [26] E. Sersen, E. Voric, J. (2008): Quality of Electricity Supply as a Service. In *Proceeding of International Conference on Renewable Energy and Power Quality (ICREPQ-08)*, 2008
- [27] Gustavsson, R., Hussain, S. and Saleem, A. (2013): Ancillary Services for Smart Grids – Power Quality Markets. In *Proceedings of PowerTech 2013, Grenoble*
- [28] NASPI homepage: <https://www.naspi.org/>
- [29] INTEGRAL Report: [http://www.integral-eu.com/fileadmin/user\\_upload/downloads/Presentations/E-Energy2010\\_-\\_Integral\\_\\_Oct-2010\\_.pdf](http://www.integral-eu.com/fileadmin/user_upload/downloads/Presentations/E-Energy2010_-_Integral__Oct-2010_.pdf)
- [30] Hughes Power Systems. Home page: <http://www.hughespowersystem.com/en/>
- [31] Hussain, S., Gustavsson, R., and Nordström, L. (2012): Smart Home Services Enabled by Service Level Agreements. In *Proceedings of First International Workshop on Intelligent Agent Technology. Power Systems and Energy Markets (IATEM 2012)*. Vienna 4<sup>th</sup> September 2012.
- [32] Gustavsson, R. and Hussain, S: (2014): The Proper Role of Agents in Future Resilient Smart Grids. In *Proceedings of Multi-agent Applications for Smart Grids and Sustainable Energy Systems (MASGES 14)*. Salamanca 4 – 6 June 2014.