

We are IntechOpen, the world's leading publisher of Open Access books Built by scientists, for scientists

4,800

Open access books available

122,000

International authors and editors

135M

Downloads

Our authors are among the

154

Countries delivered to

TOP 1%

most cited scientists

12.2%

Contributors from top 500 universities



WEB OF SCIENCE™

Selection of our books indexed in the Book Citation Index
in Web of Science™ Core Collection (BKCI)

Interested in publishing with us?
Contact book.department@intechopen.com

Numbers displayed above are based on latest data collected.

For more information visit www.intechopen.com



Positron Emission Tomography-Computed Tomography Data Acquisition and Image Management

Todd Faasse

Additional information is available at the end of the chapter

<http://dx.doi.org/10.5772/57119>

1. Introduction

Combined and optimized Positron Emission Tomography and Computed Tomography (PET-CT) exams are among the more complex of the radiographic modalities utilized in both body oncology and neurology settings. A distinct and targeted workflow is essential to successful data acquisition, processing, and related image management and reporting [1, 2]. This chapter will review the primary considerations involved in acquisition, processing, and archiving of PET-CT raw data and image data in a clinical PET-CT environment primarily centered on oncology and neurology.

2. Raw data acquisition

The method utilized for the creation of PET images is steeped in proprietary acquisition techniques available from a very limited number of PET-CT scanner manufacturers. Regardless of the manufacturer, successful PET-CT acquisition depends on a consistent quality assurance and quality control program as well as an attentive technologist staff and supportive physicist. Routine and careful quality control at daily intervals is at the center of any high performing PET-CT department. The pinnacle of PET quality control is the acquisition and evaluation of PET sinograms that comprise the raw data. PET-CT raw data consists of gigabyte sinogram data sets that are used to generate image sets consisting of transverse slices. Each transverse slice maps to a sine wave frequency. These frequencies on the sinogram can be practically visualized as displacements or rows on the x axis and an angle on the y-axis which represent a projection through the object being imaged. At the smallest level, each pixel in the sinogram corresponds to specific line-of-response (LOR) based on the byproducts of a positron

annihilation event detected in the scanner PET crystals. The resulting pixel rendering is considered image data. Additional or revised reconstructions of different slice thickness or overlap can only be rendered from *raw* data. Image data slice thickness cannot be changed once rendered. Figure 1 illustrates a sinogram rendered from daily quality control procedures.

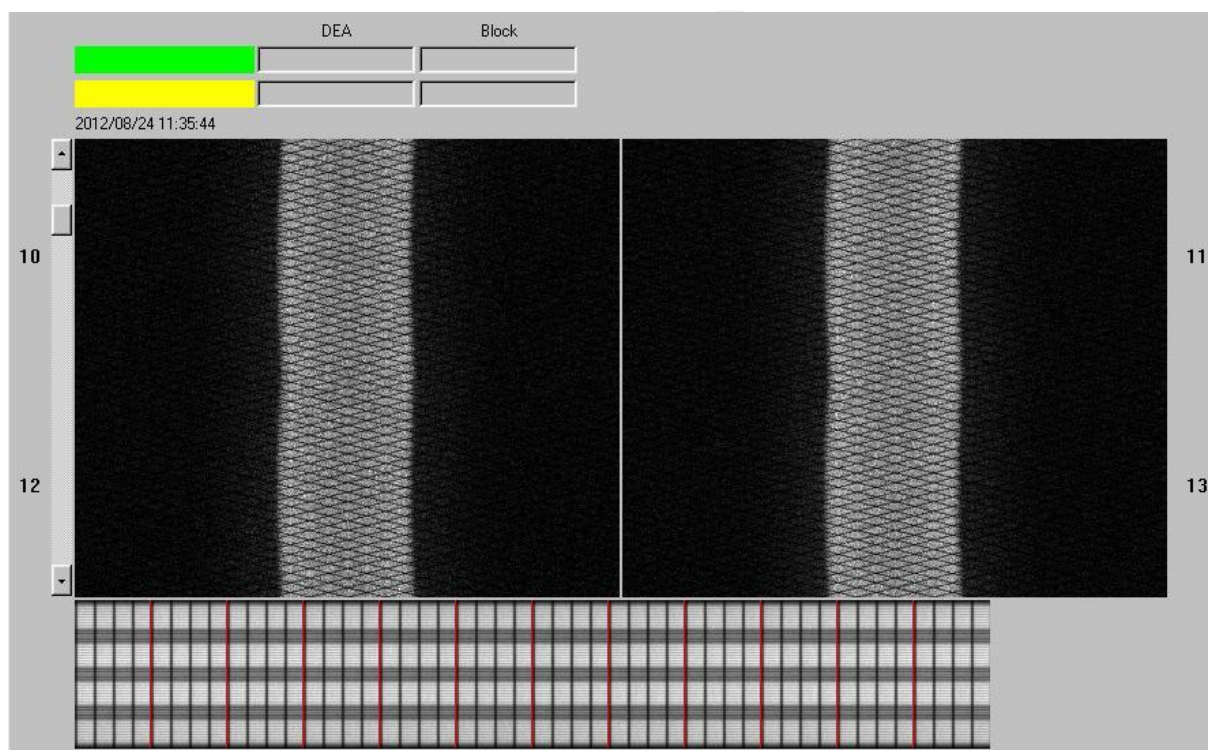

Figure 1. Normal PET sinogram

The PET sinogram will reveal excessive and non-uniform fluctuations occurring in the gantry crystal detector architecture. Any significant change in the detector crystals will be manifest as a “stripe” of non-uniformity. In most cases, this stripe indicates a detector block failure. The presence of a failed detector block will require a repeat of the quality control to attempt to verify scanner malfunction. Block failure is a serious malfunction that in most cases requires the intervention of a PET service engineer. The block will either need to have the corresponding electronics tuned or the block will require replacement in order to continue with scanning. Figure 2 depicts a PET sinogram with a failed block artifact.

PET scintillation crystals are especially susceptible to failure due to environmental conditions such as dramatic alterations in ambient temperature, humidity, or cooling infrastructure. As a result, the technologist should intermittently but frequently review a gantry interface that provides a continuous report of gantry status and conditions. In particular, the technologist should be mindful of alterations in gantry temperature or dew point as well as substantial changes in the voltage of the detector electronics. Maintaining vigilance in monitoring gantry conditions can be an important part of early troubleshooting to minimize delays and eventual

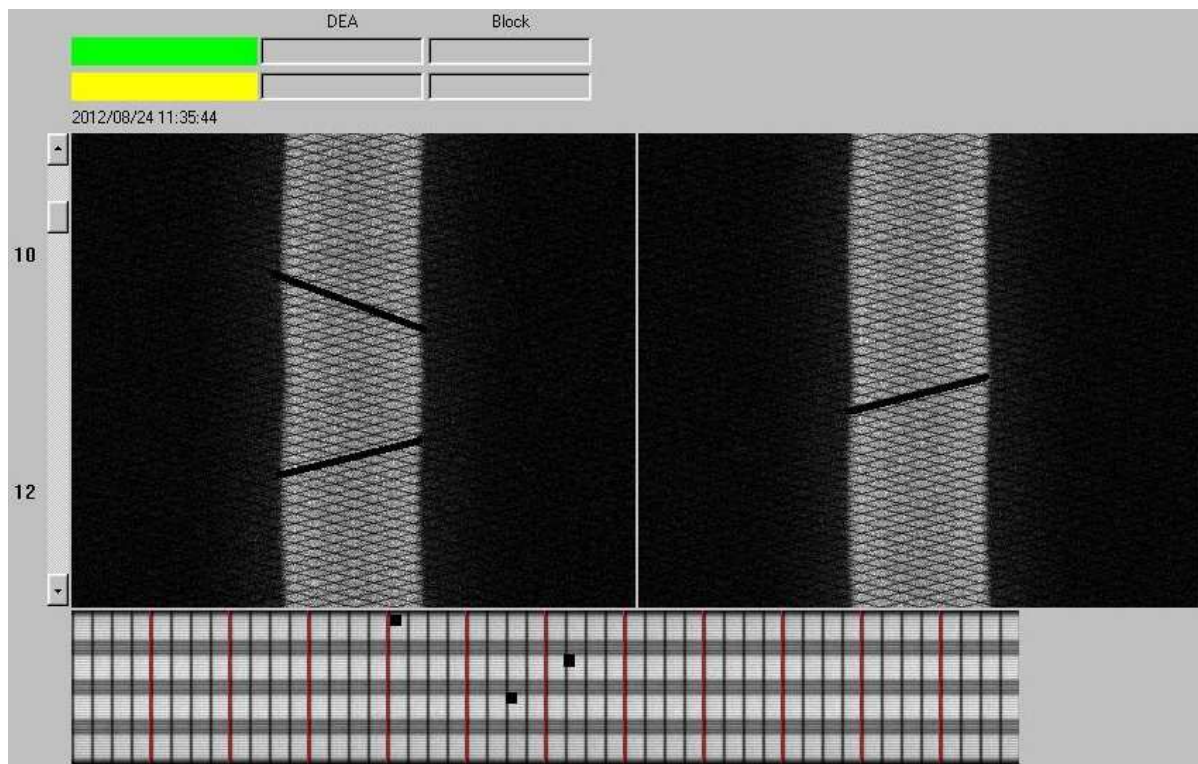

Figure 2. PET sinogram with failed block (“stripes” with no activity)

downtime. Figure 3 demonstrates a typical positron emission tomography acquisition interface.

3. Raw data reconstruction into processed image data

Once an appropriate sinogram data set has been acquired and confirmed as meeting the manufacturer and site-specific quality control requirements, reconstruction of slices from the data can be commenced. Common and clinically useful reconstructions include filtered back projection corrected and uncorrected images as well as iterative reconstructions. With iterative reconstructions, manufacturers are also bringing to bear time of flight capabilities made possible as a result of the very latest and most progressive reconstruction algorithms. Regardless of the vendor or reconstruction methodology employed, any actions necessary to correct for random events, scatter, decay, normalization, and dead time will be applied.

Two dimensional (2D) versus three dimensional (3D) acquisitions continue to play a role in image reconstruction management with 3D gaining primacy and near routine usage for all PET reconstructions [3]. In the earlier days of PET, 2D imaging was the most desirable and feasible means of imaging. This was true because, too many events would be detected within the PET crystal array with excessive dead time and image degradation in adjacent PET detector rings. This was overcome by placing septa comprised of tungsten or lead in between the detector rings. Along with these septa, the scanner electronics were configured to only detect

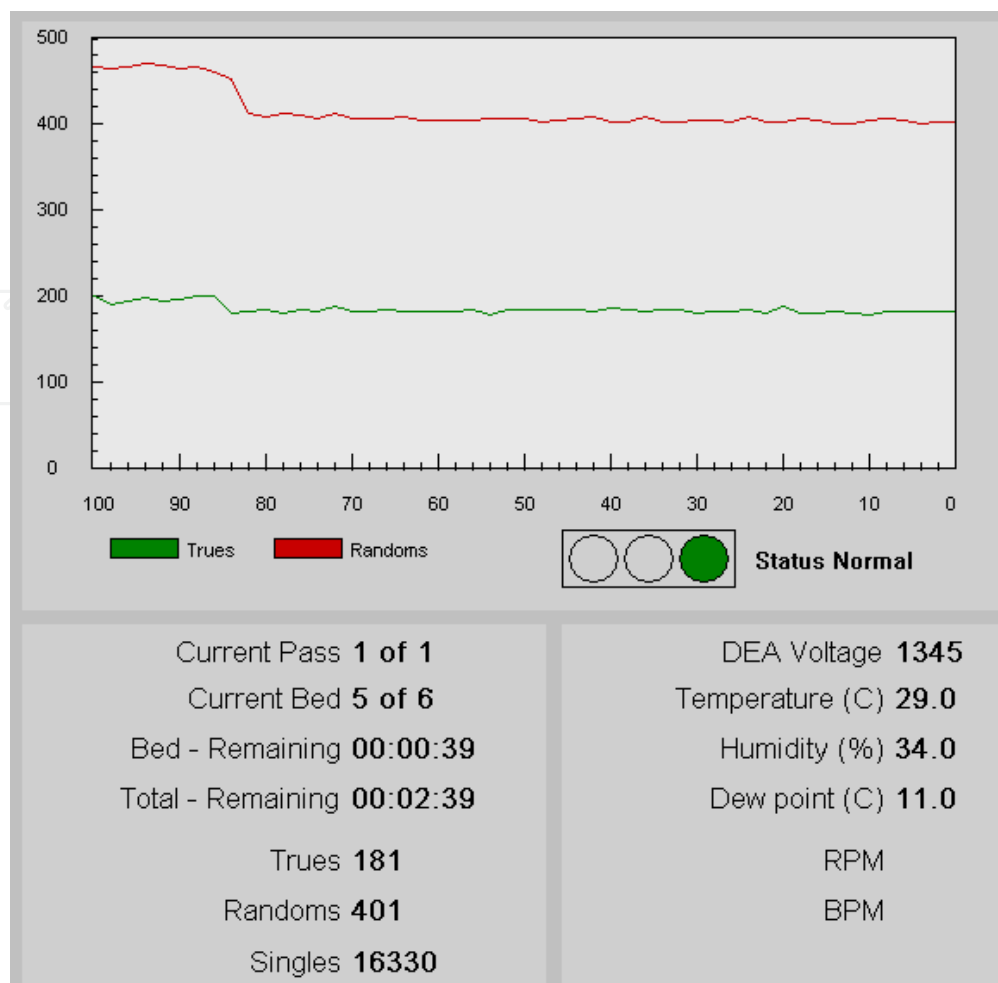

Figure 3. PET acquisition interface. In addition to critical benchmarks such as gantry temperature and dew point, the technologist may also view PET prompt information such as random, true, and single events.

coincidence events from within a limited plane to exclude non-collinear events. This also reduced the sensitivity of coincidence detection and corresponding image resolution. With improvements in crystal technology and detector electronics, it became possible to remove the septa that separated PET rings and detect collinear events in the adjacent PET rings. This could occur without concomitant dead time affects and allowed for a nearly quadruple increase in sensitivity. Figure 4 depicts 2D mode imaging (left) and 3D mode (right):

Attenuation corrections methods must also be implemented routinely or the PET axial images will have a muted or dim appearance for those structures that are more towards the center and deeper aspects of the patient's anatomy. The most simple attenuation correction method is that of filtered back projection whereby the body is assumed to be an ellipse of relatively uniform density. This "Chang technique" works well in uniformly dense anatomic structures but is woefully slow and inadequate in portions of the anatomy that contains variable density structures. Therefore, for both speed and accuracy, measured attenuation is preferable via the use of a CT source. The historical arc of PET-CT attenuation projection has progressed from usage of an external transmission rod source to "modern" CT scanners that are now commer-

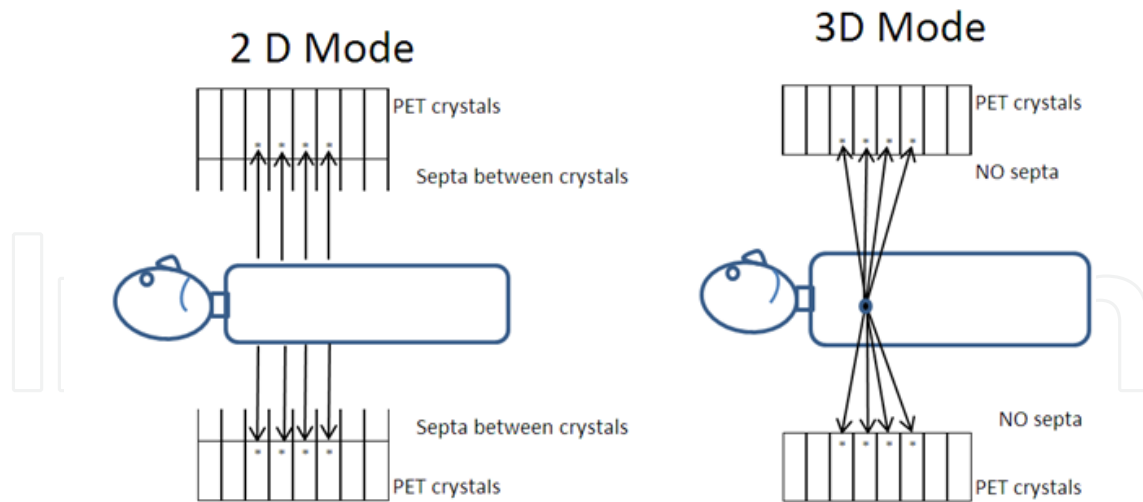

Figure 4. PET detection modes

cially available and integrated with PET-CT. CT detector architecture utilizing upwards of 128 rows can now be found on commercially available PET-CT scanners [4]. In the earlier days of PET, Ge-68 or Cs-137 rod sources were used to generate a transmission scan through each slice of the patient's body resulting in a measurement of attenuation correction for each pixel. Typically, the rod source was maintained within a shielded portion of the gantry. Upon the issuing of a transmission command from the scanner operating software, the shielded rod would be extended and rotated about the patient for a predefined time per bed position, usually 3-4 minutes per bed. This was a lengthy process that commonly took upwards of 30 minutes to complete. Modern PET scanners no longer utilize transmission rod sources and PET scanners containing CT infrastructure are the norm due to the dramatically increased speed of acquisition and resulting attenuation correction map [5]. Figure 5 depicts transmission scan created with a rotating radioactive rod source assembly.



Figure 5. PET rod transmission source scan: Contemporary PET scanners no longer make use of rod-based transmission because CT has become the sole source of transmission-based attenuation correction.

The advantage of the traditional transmission rod source was that the patient received much less radiation dose with a transmission rod source compared to modern CT transmission methods [6]. Additionally, the transmission data were acquired in the native 511 keV energy obviating the need for segmentation that is required for CT. Segmentation involves smoothing the transaxial CT images to approximate the spatial resolution of the PET scanner. This segmentation is necessary because the energy settings of 80-140 keV inherent to CT are much lower than the 511 keV energies common to PET. The pixel values of these regions are altered and replaced with the known linear attenuation coefficient for the imaged tissue or other internal materials such as a prosthetic (joint replacement, pacemaker etc.). The process of replacing the pixel values eliminates a considerable amount of noise inherent in the "raw" image. The segmented CT attenuation map is scaled to the 511 keV and applied as attenuation correction to the PET images.

As mentioned previously, the PET-CT scanning acquisition results in the creation of raw projection data. This raw projection data is processed and rendered into reconstructed image sets. It is common practice at most clinical imaging institutions to retain the CT raw projection data for a limited number of days. This permits sufficient time to elapse such that the corresponding reconstructed images can be reviewed by the interpreting physician. It is particularly important to retain the raw data for those limited but important circumstances that the interpreting physician requests an additional reconstruction for better elucidation of a particular abnormality prior to generating the final scan interpretation. Reconstructed axial images may also be utilized to create additional projections including coronal and sagittal image sets. If the images are to be used outside of the oncology realm that PET-CT has principally been concerned with, the image data will be rendered into vertical and horizontal long axis images to accompany the usual transverse/transaxial image sets. However, certain institutions due to internal protocols or to adhere to specific research protocols must retain the raw data indefinitely. In this case, a reliable and timely means of archiving of all of the raw data generated by a scan will be necessary. There are myriad options available for archiving of said data. Reliable and timely archiving and retrievability will figure prominently in deciding which type of archiving solution is appropriate. Despite the increasing availability of robust and inexpensive computer memory, these data sets quickly deplete available hard drive space and create a pressing need for removal. This is because the CT raw data sets are much larger when compared to a corresponding PET acquisition of the same axial coverage. Archival and retrieval methods and strategies will be covered later in this chapter.

The amount of raw image data space required for each PET-CT examination depends on both the particular scanner configuration as well as the scan protocols in general usage by a facility. Each PET bed will require fewer than 10 megabytes (MB) of storage for lower matrix acquisitions. Lower matrices are usually those that are lower than 256. A lower matrix would be commonly used for axial coverage necessary for torso-based oncology such as breast, colorectal, and lymphoma staging and restaging. Higher matrices, such as those used for head & neck oncology or neurology imaging on the very latest and modern PET-CT scanners, are as high as 512. These high, fine matrices will require in excess of 70 MB for a single PET bed position. Figure 6 shows lower and higher matrix image examples.

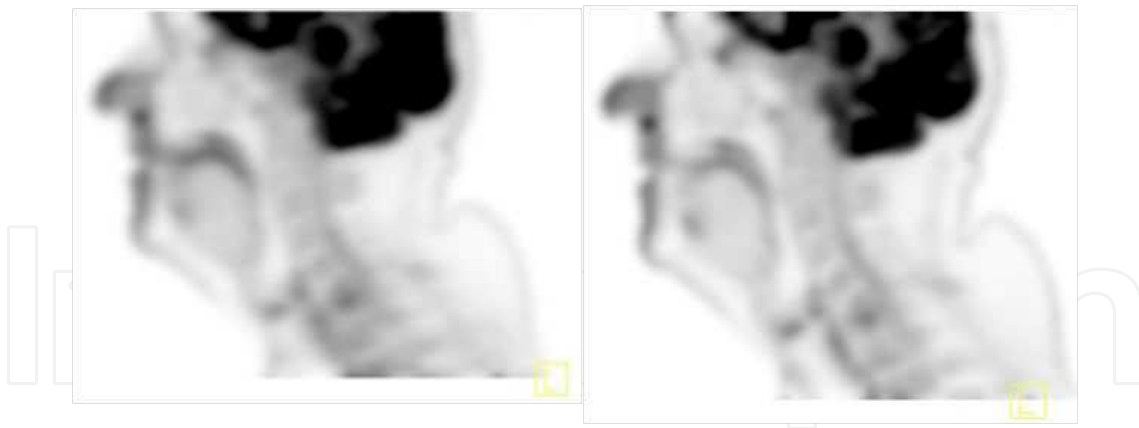

Figure 6. PET low (128 matrix) PET high (400 matrix)

CT raw data requires substantially more space, with modern 64-row scanner used in PET-CT generating upwards of 70 MB of projection data per second. As a result, the typical whole torso PET-CT examination can readily require in excess of 2 gigabytes (GB) of hard drive storage space for the raw data alone when there is a single CT acquisition created for the entire torso axial coverage (Table 1). With the addition of other CT acquisitions which may include lung breath hold, multiple contrast phases or longer axial coverage, the raw data space consumed increases accordingly to 4 GB and greater. The reconstructed images consume considerably less hard drive space; an entire image set, including different PET and CT image reconstructions occupy less than 500 MB. Common PET image reconstructions include attenuation corrected iterative and non-attenuation corrected filtered back projection. Figure 7 depicts the transaxial PET reconstructions commonly used in body oncology imaging.

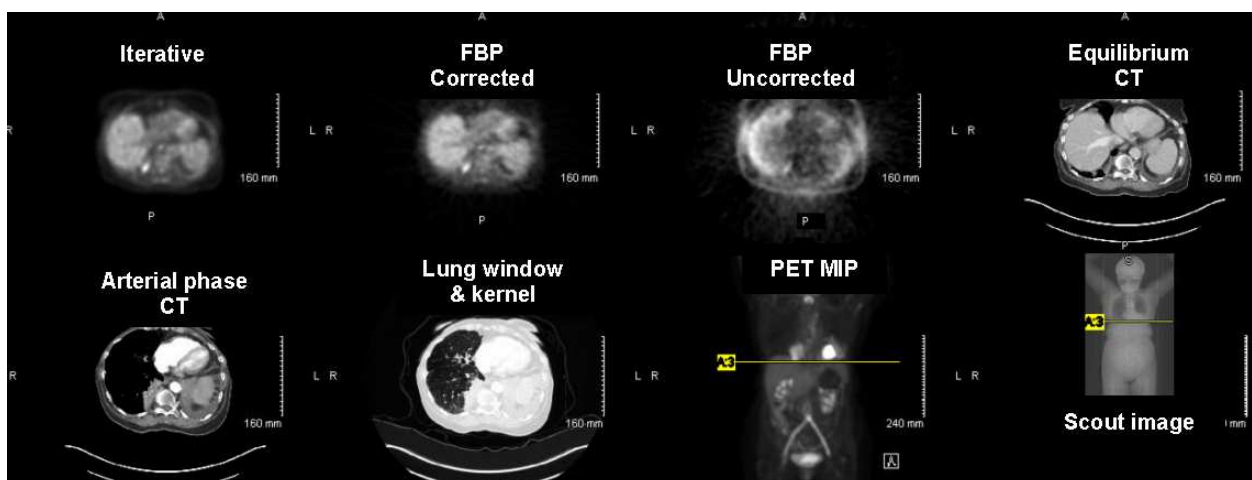

Figure 7. Typical transaxial PET-CT image reconstructions. Note CT was acquired with both arterial and equilibrium contrast phases and rendered in multiple kernels and windows

In a very active practice in which 10 or more patients are imaged per scanner, several GB of hard drive space can be easily filled in the course of a day [1]. If the PET-CT technologist does

not routinely transfer raw data sets and reconstructed image sets to other storage sites or delete them from the hard drive space on a routine basis, system functionality can be severely hampered. In some cases, intensive hard drive utilization may cause database corruption resulting in significant interruptions and possibly downtime. Table 1 depicts a comparison of both PET and CT raw and reconstructed file sizes.

# of PET beds	CT scanning time in seconds	PET raw data set size in MB	CT raw data set size in MB	Total PET-CT file size in MB
1	3	70	210	280
2	6	140	420	560
3	9	210	630	840
4	12	280	840	1120
5	15	350	1050	1400
*6	18	420	1260	1680
7	21	490	1470	1960
8	24	560	1680	2240
9	27	630	1890	2520
10	30	700	2100	2800
11	33	770	2310	3080
12	36	840	2520	3360
13	39	910	2730	3640
14	42	980	2940	3920
15	45	1050	3150	4200

File size assumptions: A PET bed occupying approximately 10 cm of axial coverage requires 70 MB. A CT of the corresponding PET axial coverage is 3 times as large or ~ 210 MB. *The typical PET-CT would be of the torso ("skull base to thighs") and would be approximately 5-6 bed positions. Depending on the axial field of view, wholebody (skull vertex to toes) imaging may require as many as 15 or more bed positions to provide sufficient axial coverage.

Table 1. Comparison of both PET and CT raw and reconstructed file sizes

Common and scalable raw and image data archiving strategies and solutions will be discussed later in this chapter.

4. Time-of-flight PET

The PET scanner crystals remain the primary limiting factor in both image resolution and speed of acquisition capabilities [7]. The development and implementation of Time-of-Flight (ToF)

technology has been the primary strategy targeted at improving image resolution and acquisition speed [8, 9]. The concept of time of flight dates back many years and was utilized for limited applications employing very fast and expensive crystal arrays [8, 9]. The economics of crystal manufacture combined with more affordable and rapid computer processors and memory have made ToF feasible to deploy among virtually all of the mainstream PET-CT manufacturers. The crystal standard for many years in PET technology was the bismuth germinate crystal. It had the advantage of having good 511 keV stopping power, universal availability and was well-tested within PET gantry design. However, it lacked the fast scintillation capabilities that are essential to ToF PET. Lutetium oxyorthosilicate (LSO) or cerium-doped lutetium yttrium orthosilicate (LYSO) have emerged as the industry standard capable of the rapid scintillation times necessary to support ToF [10].

The principle advantage of ToF is the ability to dramatically improve the positioning of annihilation events that occur outside of the line of response (LOR). This is accomplished by locating the annihilation photon energy deposition on the opposing sides of the ring of crystals in the PET gantry and determining the difference in arrival times of those events.

It is important to understand that ToF allows for better lesion detectability not because of improvement in resolution but as a result of improved signal-to-noise definition inherent in improved timing resolution. For this to occur in contemporary PET scanners, the coincidence timing window must be configured to be very short (4–6 nanoseconds) to improve the fraction of randoms detected and resultant improvement in image contrast.

5. Quantitative PET imaging: Considerations for optimizing and rendering the standardized uptake value (SUV)

Provided accurate attenuation correction is performed, PET scanners provide the opportunity to generate semi-quantitative measurements of tumor metabolism. These measurements, known as standardized uptake values (SUVs) continue to be the primary and most universally accepted method for generating semi-quantitative measurements that depict tumor metabolism [11]. The default unit of measurement in all PET scanners is kilobecquerels per milliliter. This unit of measurement together with the quantity of injected radioactivity, patient weight, and decay time is used to compute the SUV. Considerable error inherent to all of the aforementioned criteria can result in badly flawed measurements and ultimately, false tumor metabolism quantification. In order to reduce the likelihood of introducing error in SUVs, at a minimum, the following must be evaluated and effectively implemented in the SUV calculation [11]:

- Scanner cross-calibration: procedure performed to ensure that dose calibrator dose assays match the radioactivity measured by the PET scanner.
- Measurement of residual syringe activity: This occurs immediately subsequent to administering the dose to the patient. The residual syringe activity is subtracted and the total

quantity administered is recorded in the radiopharmaceutical administration record. This same resulting quantity is used for all SUV calculations.

- Synchronization of all clocks utilized in reporting injection time
- Assurance of proper infusion of radiopharmaceutical (no dose extravasation)
- Accurate patient weight
- Accurate patient dose

The equation for SUV calculation is as follows:

SUV= Region of interest of radiopharmaceutical concentration

(Tracer dose/patient weight)

Because radiopharmaceutical dose and patient weight are in the denominator, these are among the 2 most important values to optimize to reduce the magnitude of error inherent to the calculation.

6. Computed Tomography acquisitions considerations for PET-CT

Prior to 1998 and the prototype development of the PET-CT at the University of Pittsburgh, PET-only systems had primacy given that those systems were the only offering available [3]. The genesis of PET combined with CT derived from the suggestion of a Swiss oncology surgeon. During the development of the PET-CT, the oncologist opined that a CT scanner in the voids between the banks of the PET detectors might provide useful anatomical information familiar to oncology surgeons. This suggestion was a catalyst to the advent of the modern-day PET-CT. Dr. David Townsend and Ron Nutt began creating a prototype PET-CT in 1991 but it would not be a viable device for use clinically until 1998 [3].

Since that time, the practice of PET-CT could be considered more largely to be PET-**ct** in which the CT portion of the scan is used primarily for attenuation correction and anatomic localization. However, the original intent of Townsend and colleagues was to generate *clinical* CT and *clinical* PET scans in the course of a single scanning session using a single machine. Moreover, the desired purpose of the CT was to provide clinical patient information rather than only attenuation correction and anatomic localization. Indeed, CT for attenuation correction was a secondary to the main purpose of developing a clinical PET-CT scanner [3]. High-quality, optimized CT was possible routinely even on 2 row CT units that were commonly available and interfaced with the PET gantry at that time [3].

There has been considerable divergence over the routine integration of optimized, contrast enhanced CT with PET. However, over the course of the past decade, the literature has repeatedly borne out the superior quality and efficacy of optimized CT used in conjunction with PET [12, 13]. The most strident objection to performing optimized, contrast-enhanced CT with PET is that the oral and/or intravenous contrasts utilized on the CT creates artifacts in the

PET images. More specifically, it was proposed that the intravenous contrast or oral barium sulfate attenuation correction artifacts diminished the readability of the PET [14, 15]. While there are limited examples of attenuation correction artifacts from oral or intravenous contrast, experienced PET-CT readers have learned to utilize filtered back projection uncorrected images to differentiate artifacts versus clinically relevant findings [16]. The emergence of routinely used dual syringe intravenous contrast injectors that permit the injection of a normal saline “chaser” after the initial intravenous contrast have virtually eliminated intravenous contrast artifacts on the attenuation corrected images [17].

There are substantial requirements and preparations necessary to incorporating optimized CT into PET-CT practice [2]. The most ideal approach has been to have truly-dually trained and boarded radiologists and technologists working together to produce the PET-CT images. Regrettably, this situation is rarely achievable given the time investment necessary to garner nuclear medicine physician and radiologist credentials or for similar circumstances to be available to nuclear medicine technologists. Nevertheless, it is possible to routinely incorporate optimized CT into the PET-CT practice provided there can be collaboration between nuclear medicine and CT departments.

Critical considerations for optimizing CT acquired along with PET include configuring scanner parameters for the best quality image while dosing the patient safely. Technologist staff should become knowledgeable regarding basic CT principles such as pitch and slice overlap, CT dose index (mGy and mAs or mA), slice thickness and noise inter-relationship, and x-ray penetration characteristics (keV setting). Intravenous contrast administration requires careful screening of each patient both at the time the patient’s appointment is scheduled as well as during the actual appointment. Internal protocols should be developed to optimize the patient’s ingestion of oral contrast, administration of intravenous contrast for optimized bolus timing, as well as persistent awareness of the potential for contrast reactions. Figure 8 illustrates a protocol for PET-CT incorporating optimized CT:

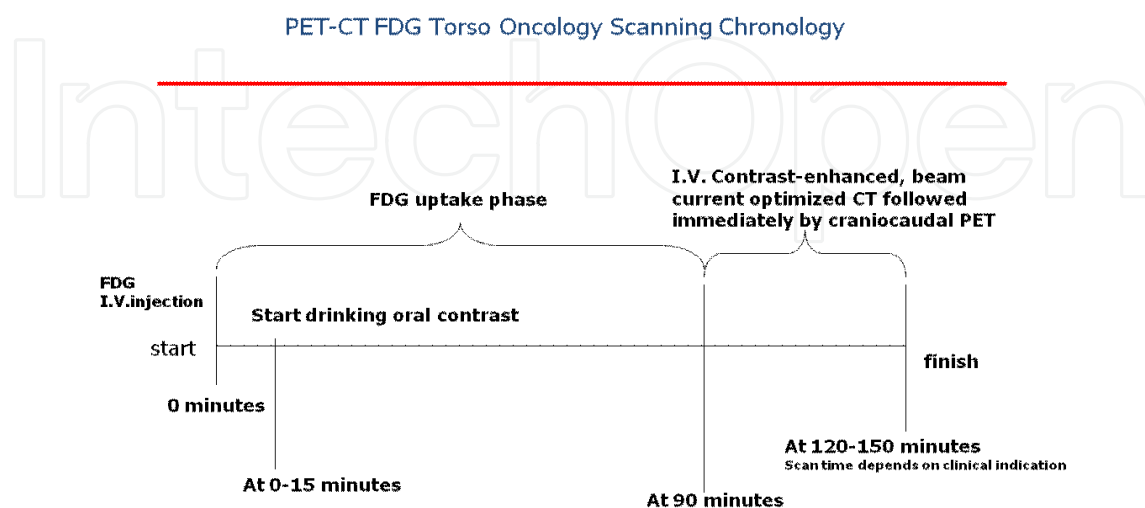

Figure 8. Optimized CT-PET protocol

A final consideration for performing optimized CT is patient safety given clinically significant findings. In the course of performing optimized CT, it is not uncommon to encounter a large pleural effusion (fluid in the lungs) or a pneumothorax (collapsed region of lung) or similar life-threatening circumstance. PET-CT technologists must be vigilant and trained to routinely evaluate the CT images for obvious significant findings and report these findings to a radiologist for appropriate follow up. Figure 9a illustrates a pleural effusion and Figure 9b shows a pneumothorax:

On rare occasions, pulmonary emboli are also encountered and must be reported but these findings are often extremely subtle even to the experienced imager.

Along with noticing clinically significant findings during and subsequent to the scan, it is vital that the technologist provide the utmost in safety while administering intravenous contrast. The threat of intravenous contrast extravasation, allergic reactions, or renal compromise are the foremost dangers for the patient. It has been well-documented that intravenous contrast extravasations of 100 milliliters or greater almost always require a plastic surgery consult as localized tissue necrosis may occur [18]. This is because the osmolality of commonly used non-ionic intravenous contrast (~650 mOsm/kg) is often vastly different from osmolality of blood (~285 mOsm/kg) creating conditions for unfavorable osmotic gradients to occur [19]. The majority of intravenous contrast extravasations can be avoided entirely by verifying venous patency prior to and during the administration of contrast [1]. Figure 10 demonstrates a graphical depiction of the venous patency both *before* (10a) and *during* (10b) contrast administration. Figure 10c reveals an example of a steeply sloped, worrisome curve that may indicate an extravasation event will occur.

Additionally, though uncommon, allergic reactions to intravenous contrast range from localized mild urticaria to anaphylactic shock [20]. Also, patients at risk for renal insufficiency such as those who have diabetes, hypertension, solitary kidney, or any combination of the aforementioned are at substantial risk for developing contrast induced nephropathy (CIN) [21]. Therefore, *all* patients must be carefully screened prior to receiving contrast. This will include a thorough review of the patient's medical history as well as assessment of creatinine and estimated glomerular filtration rate ideally within 30 days of administering intravenous contrast [22].

7. Image fusion

Prior to the introduction and routine utilization of modern PET-CT scanners, the technologist or similar staff used third party programs in post-processing attempts targeted at aligning PET and CT or PET and MR image sets that had been acquired on different scanners. In addition, the radiologist was also tasked with customary mental alignment of image metabolism structures, so called "mental fusion" [23]. The fully integrated and combined PET-CT has allowed for practical and real-time image fusion that is considered commonplace in contemporary imaging [24]. Unfortunately, this has not obviated the need for third party image fusion systems because fusion of IR, MR or other modality fusion is now considered standard-of-care.

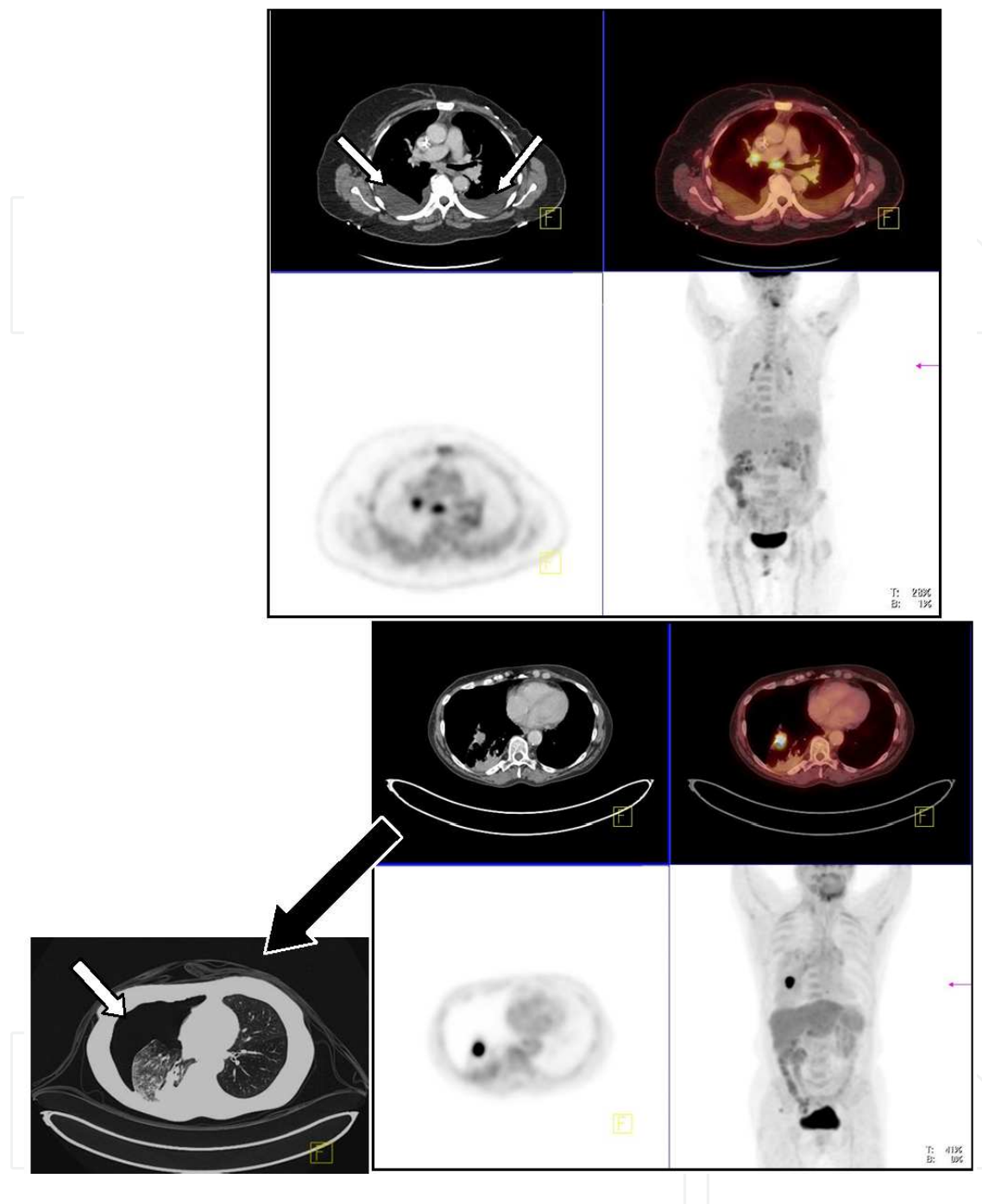
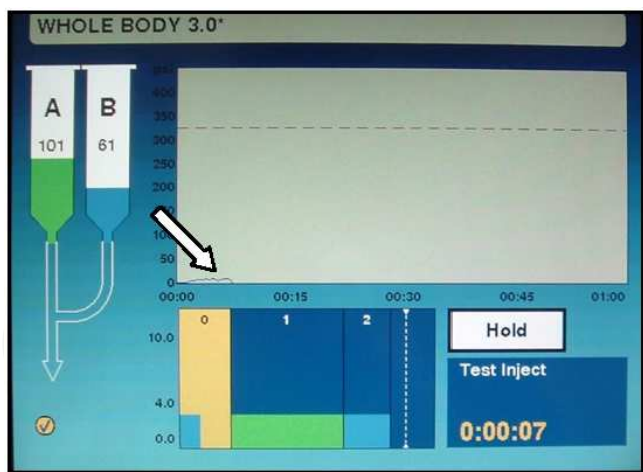
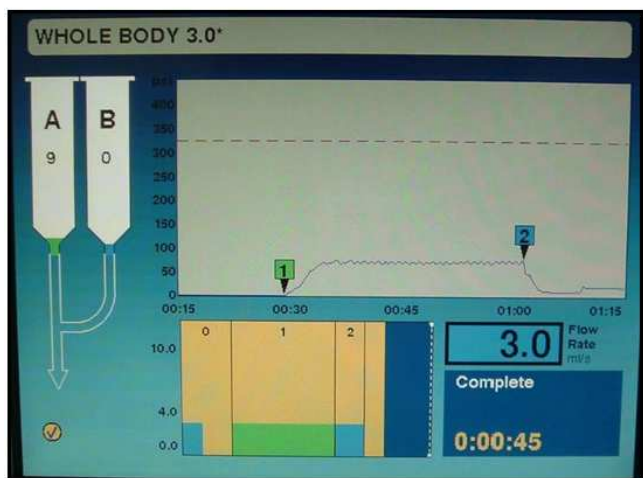

Figure 9. (a.) Bilateral pleural effusions encountered during viewing of CT images; (b.) Pneumothorax. Note that this clinically-significant finding is *only fully revealed* upon application of a CT kernel and appropriate windowing.

This is increasingly becoming the case in multidisciplinary oncology environments as well as neurology subspecialty environments that include an epileptologist as part of a multidisciplinary epilepsy team. Until recently, rigid fusion was the only possible fusion option. Rigid fusion involves image landmark matching to achieve the closest best fit among anatomic structures and metabolic activity. This is achievable by using software to co-register multiple image volumes against a reference volume. However, due to myriad alterations in patient



(a)



(b)

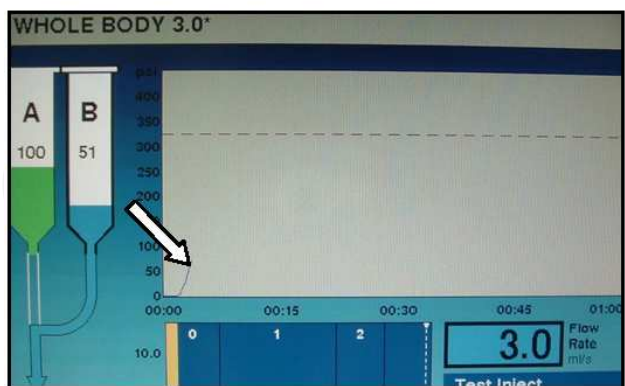

(c)

Figure 10. a. Saline test bolus phase, b. Intravenous contrast bolus phase, c. Non-patent I.V.: Administering intravenous contrast when the test bolus has a rapidly increasing slope that does not level off is an imminent indicator of extravasation Venous patency tracing viewed both during test bolus of saline (a), injection of intravenous contrast (b) and non-patent IV (c). For maximum safety, the technologist should actually palpate the injection site during an initial bolus of normal saline while also reviewing the time versus pressure tracing.

position between scanners, patient weight changes, and surgical variants rigid fusion frequently reveals undesirable matches between image sets. In contrast, deformable fusion has emerged and permits more favorable metabolic and structural alignment by incorporating virtual stretch algorithms. This involves mutual information algorithms that function at the pixel and/or voxel level to “warp” the image data [25].

Figure 11 demonstrates a post-processed PET-CT fusion image while Figure 12 illustrates a post-processed PET-MR deformably fused image.

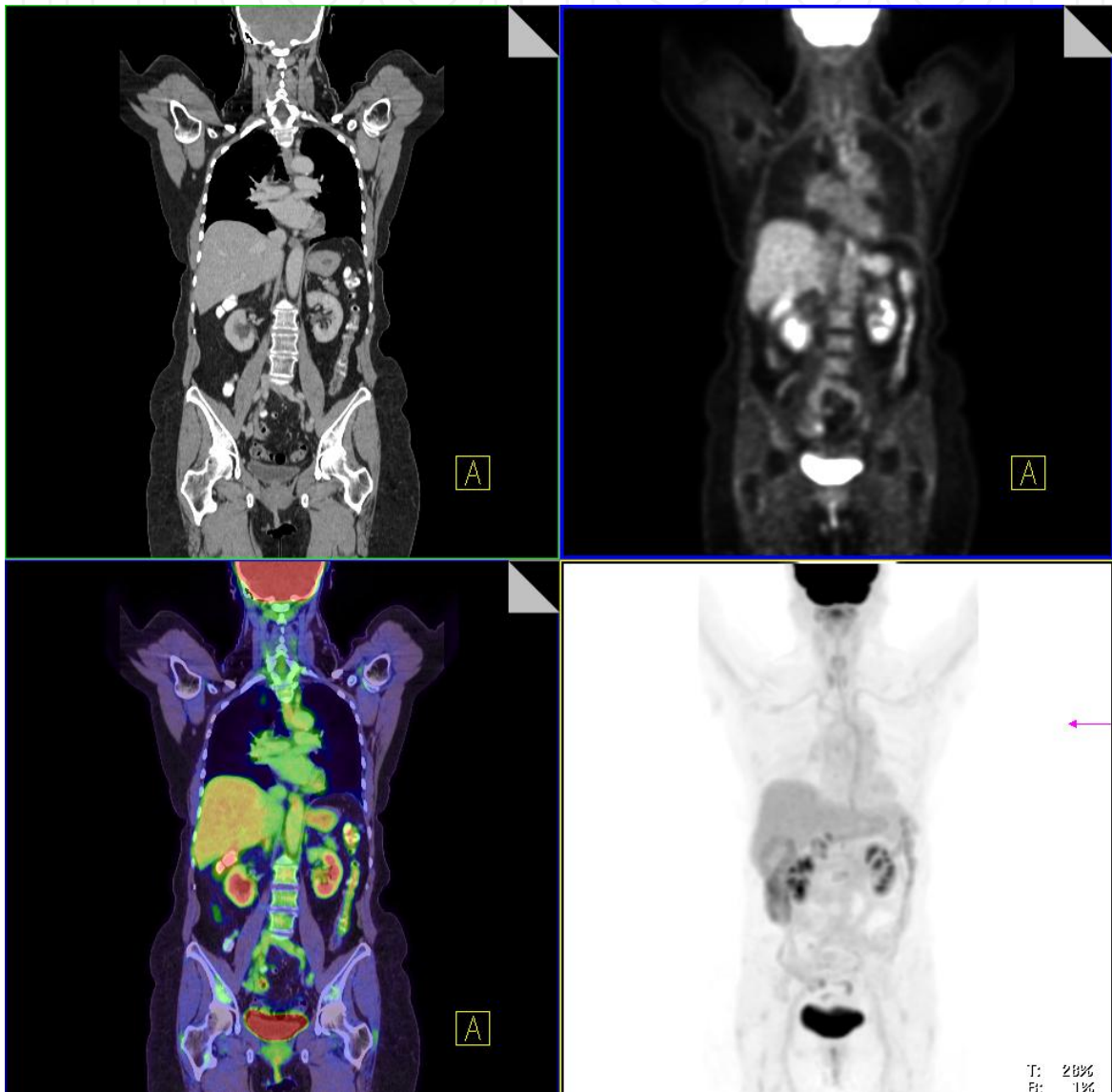

Figure 11. PET-CT fusion images: Images were acquired during co-registered acquisition and fused during post-processing

Provided the processed image matrices are similar, deformable fusion is routinely achievable and permits for favorable and clinically useful alignment of morphological and metabolic image sets across multiple cross-sectional modalities [26].

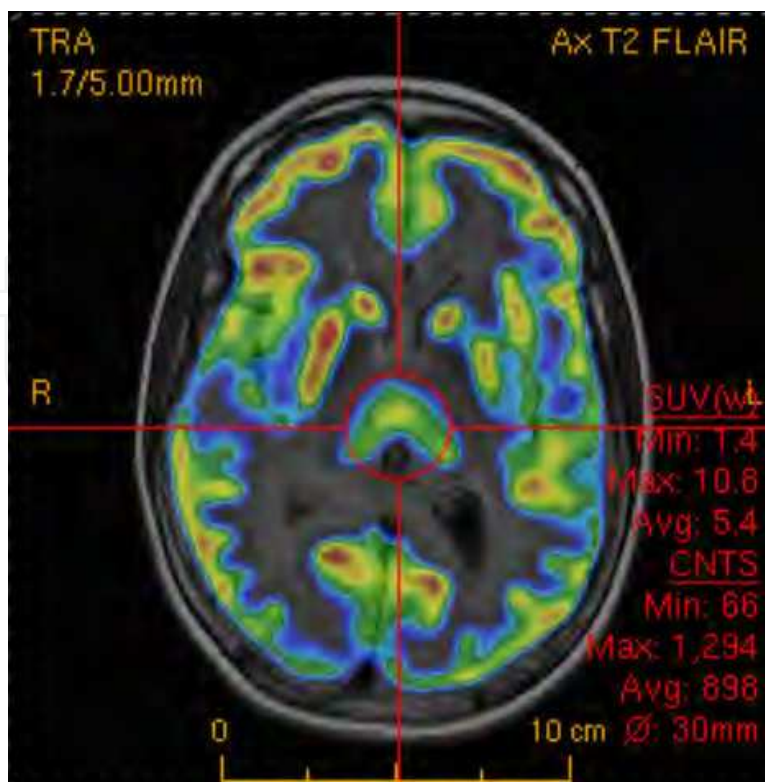

Figure 12. PET-MR fusion images-the PET and MR were acquired separately and fused utilizing deformable fusion post-process application software.

8. Workflow and the optimized PET-CT acquisition: The United States perspective

If PET-CT experienced a “golden age” it was immediately following more widespread adoption of PET-CT in the early 2000s. Numerous PET-CT facilities had business models based upon as few as 3 patients per day due to robust reimbursement that prevailed up until 2005. This was an ephemeral but important time of prosperity, growth, and development for PET-CT. At that time, the per scan fee provided by the Centers for Medicare and Medicaid Services (CMS) was at an all time high. This period was destined for an eventual phase out but was hastened by the implementation and enforcement of the Deficit Reduction Act (DRA) [26, 27, 28, 29]. The DRA of 2005 (signed into law February of 2006) was implemented as part of a broader strategy targeted at limiting the unnecessary expenditure of funds thought to be redundant in patients’ care [26]. The ultimate result of this policy was that reimbursement for PET-CT was reduced by nearly one half in the non-hospital, free-standing imaging environment [26]. Many independent imaging centers that once prospered by only performing 3 or 4 patients per day no longer could achieve a margin to sustain a solvent business model. In the ensuing aftermath of full phase in of DRA policy, many of these facilities were either assimilated by larger institutions or simply became insolvent and bankrupt.

In addition to the DRA of 2005, a second blow to PET-CT arrived in the form of the major economic downturn and crisis of 2008. This dramatically reduced the borrowing power of

institutions as well as the number of patients with healthcare insurance who could afford to have PET-CTs. What emerged was a new paradigm of very efficient, higher volume imaging workflows in PET-CT in both public and private hospital industry. Institutions with targeted and efficient workflows have been able to weather the continued acrimonious economic conditions as funds for both full time equivalents (FTEs) and capital infrastructures such as scanners continues to diminish. PET-CT has continued to grow although the percentage increase has tended to decrease each year since 2005 [30]. This environment is indeed the new normal and will likely persist for several years to come.

9. Specialized acquisition circumstances: Pediatrics, radiation therapy planning, and inpatients

9.1. Pediatrics

Pediatric PET-CT acquisition requires all of the same precautions as those that accompany adult PET-CT *plus* specific considerations for PET emission times, matrix, and minimization of movement artifacts. Despite the fact that pediatric patients tend to be shorter and have much lower body mass than adult patients, acquisition paradoxically takes longer. This is because ideally, a higher and finer matrix will be used to image the smaller bodies of pediatric patients. As a general guideline, if the matrix size is doubled there should be concomitant quadrupling of acquisition time in order to achieve appropriate imaging statistics and image quality. Given these considerations, achieving high-quality, motion-free images may require coordination of sedation services, immobilization devices and/or considerable psychosocial support from the PET-CT staff as well as accompanying patient guardian(s) [31]. Within a conventional scheduling paradigm, high quality pediatric scanning invariably requires more planning and imaging time. These needs cannot be underestimated and should be an integral part of the pediatric PET-CT scheduling process.

In any pediatric PET-CT imaging environment, there should be age and weight-specific criteria for dosing the patient with radiopharmaceuticals. One method that can be used is to standardize the pediatric dose to the “standard man” of 70 kilograms while also setting absolute low and high dose limits. As an example, an institution might designate 74 MBq (2 mCi) as the minimum dose and 370 MBq (10 mCi) as the maximum dose. The dose would then be computed with the following equation:

Pediatric radiopharmaceutical dose=370 MBq x child’s weight in kg/150 kg

It is helpful to use any number of commercially available spreadsheet programs to extrapolate all values of radiopharmaceutical dosing based on this equation for ease of reference.

Pediatric PET-CT will also require careful consideration of radiation dose delivered in the CT portion of the exam. This is of the utmost importance if the institution has incorporated optimized or diagnostic CT parameters because dose from CT will be nearly twice the radiation dose from the 511 keV emitting radiopharmaceutical such as fluorine-18 2-deoxy-2-fluoro-D-

glucose (^{18}F FDG) [32]. There are now well-established “Image Gently” protocols available from the American College of Radiology that can assist any facility in creating protocols that provide age-appropriate CT dosing. In recent years, these protocols have become increasingly common in many pediatric-based radiology departments although the adoption of optimized or diagnostic CT parameters in PET-CT has been slower to emerge [33]. Integrated applications to reduce CT dose should be routinely incorporated into the imaging of pediatric patients to maintain their dose as low as reasonably achievable (ALARA). Low dose pediatric CT is generally accepted to be 5 mSv or below for the typical torso axial coverage [34]. This is easily achievable in younger and smaller pediatric patients who possess a lower body mass index (BMI) but becomes considerably more difficult in imaging older and higher BMI pediatric patients. An ongoing and continuing dialogue with a health physicist and radiologist is essential to providing safe and lower dose CT in the pediatric PET-CT environment [35].

9.2. Radiation therapy planning

Similar to pediatric PET-CT, radiation therapy (RT) planning may be a very small portion of image volume but requires considerable additional time and attention to execute properly. PET-CT has been playing an increasingly important role in the radiation therapy process, especially in multidisciplinary oncology centers [36, 38]. One of the essential advantages that PET-CT offers over CT alone is the detection of smaller lymph nodes that would not likely be considered positive on CT by size criteria [36]. Additionally, there is now ample evidence that PET-CT consistently locates unsuspected distant metastatic disease that is not visible on CT alone [36]. There are several possible approaches to incorporating radiation therapy planning into the PET-CT environment but 2 primary methods have emerged in more routine PET-CT clinical practice. The simplest method is to complete the PET-CT on a flat RT therapy planning pallet with the patient positioned in a manner approximating the positioning established or anticipated in the patient’s RT planning [36-39]. Figure 13 depicts a PET-CT scanner equipped with the RT pallet.

This approach requires no additional preparation other than the PET-CT staff receiving notification in advance to place the patient on the RT pallet. A more complex method is to position the patient in the same RT apparatus as created for the patient’s original simulation. In this case, the patient is instructed to bring their simulation position device with them to their PET-CT appointment.

The primary limiting factor for this approach is usually the bore of the PET-CT gantry [36, 40]. Most manufacturers now offer RT-sized PET-CT gantries because of the emerging complementary nature of RT and PET-CT [36]. This approach permits the most accurate but also most complex and time-intensive approach with the simulation and PET-CT occurring all in one session. In this environment, the dosimetrist or radiation therapist will position the patient in their custom radiation therapy body cradle, thermoplastic mask, or similar radiation therapy simulation apparatus [36-38]. Figure 13 a and b depict a patient who has been fitted with the same thermoplastic mask as used in the patient’s actual radiation therapy. Figure 14 shows the fiducials together with RT planning “B pillar” viewed on the reconstructed images. The PET-CT image sets are then migrated to the radiation therapy planning software

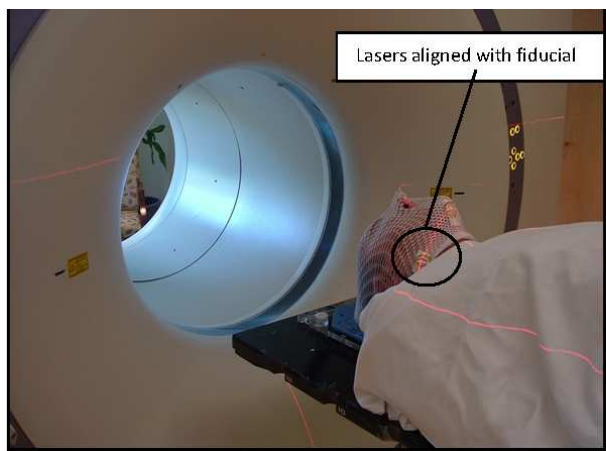

Figure 13. PET-CT equipped with RT pallet. Note radiation therapy planning laser adjacent to scanner (left) that will be used in aligning patient.

and used by the radiation oncologist and dosimetrist for the patient's radiation therapy sessions. The advantage of this approach is that the PET-CT images acquired are the *actual* simulation or planning images and PET with respect to a simulation CT will contain no error [36]. The disadvantage is that the additional time required to perform a full PET-CT simulation of this type can be upwards of 30 minutes. Moreover, the radiation exposure the dosimetrist and technologist receive while setting the patient up can be significant and unacceptable if performed routinely. Additionally, scanner time is expensive and in a busy institution, the additional time necessary for true PET-CT RT may create significant scheduling backlogs or patient scanning delays. For this approach to be practical, the PET-CT scanner may even be sited in the RT department.

9.3. Inpatients in the PET-CT environment

A final but important consideration for PET-CT acquisition is the additional maneuvers required for inpatient scanning. Inpatients will almost always require more time to ambulate, transition, and position in the PET-CT scanner. A corresponding increase in staff time must be planned for given the higher level of acuity inherent to inpatient scanning. A variety of imaging workflows and paradigms exist for incorporating inpatients into a busy imaging practice. One approach is to have an inpatient-only scanner dedicated exclusively to performing inpatient requests. This approach is more readily integrated in a large academic institution that has the resources for multiple scanners allocated for specific purposes. It is not well-suited to the typical, smaller imaging environment that relies on higher volume and more closely sequenced outpatients. Nevertheless, as the result of diminishing funds and resources, it has become increasingly common to perform inpatient studies in the outpatient setting. In any case, many institutions have found that a radiology RN is vital link in the preparation necessary to create



(a)

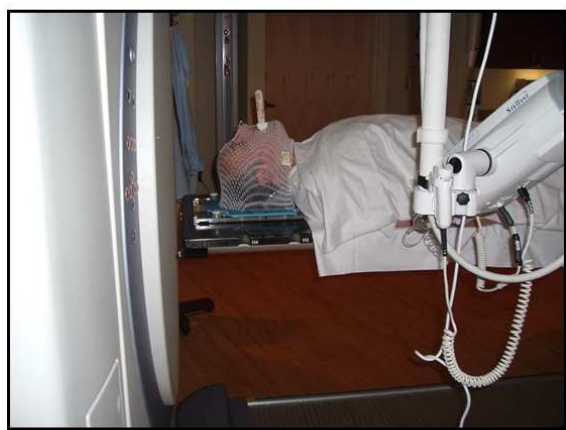

(b)

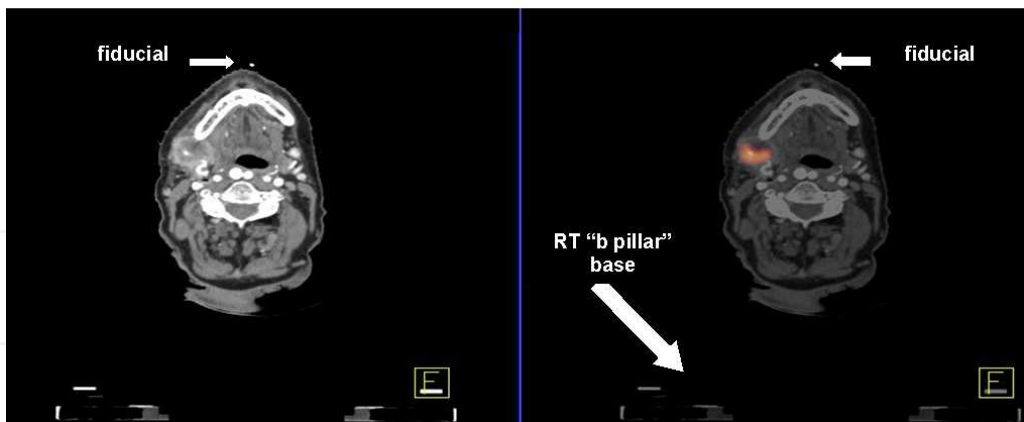

Figure 14. a: Patient positioned for RT planning on RT pallet with simulation position device. Note that external RT planning laser array has been aligned to patient's fiducials. b: Additional view of patient positioned for RT planning on RT pallet with simulation position device. Note patient has been fitted with thermoplastic mask that will be utilized for each RT treatment event. Intravenous contrast dual injector has also been positioned and is ready to use for optimized CT. Fiducials visualized on axial reconstructed images

a high-quality PET-CT scan. The RN should be available to perform a true peer-to-peer interaction with the patient's RN prior to the patient's actual arrival. This helps to insure the

patient can be transported and maintained in the PET-CT department safely. Primary considerations include but are not limited to the following:

Ambulation and falls: Minimizing falls is at the center of patient safety in any clinical service and becomes especially important when caring for inpatients. The public health and hospital safety literature have repeatedly reported the poor outcomes and compromised care that falls cause in the hospital setting [41-43]. The prevention of falls has arisen to such a level that it has garnered the attention of the Joint Commission as a National Patient Safety Goal [44]. Preventing falls for inpatients undergoing PET-CT will require a peer-to-peer RN interaction whenever possible to reduce the likelihood of the patient falling upon transition to the PET-CT environment.

Diabetes: In an oncology setting, diabetes can be the single most challenging inpatient management regimen as the patient's medication schedule and diet must be carefully controlled to achieve a euglycemic state compatible with high quality ^{18}F FDG PET-CT imaging. If blood glucose levels exceed 200 mg/dL, the PET imaging cannot be undertaken [45]. This is true because image quality will be suboptimal as endogenous glucose competes with the same binding sites as exogenous ^{18}F FDG [45].

Medications: Many inpatients receive intravenous medications in an excipient such as dextrose that will make the PET-CT impossible to perform due to glucose receptor saturation. There are also numerous medications that create difficult circumstances for blood sugar control and achieving the desired serum glucose level prior to the PET-CT. These include but are not limited to corticosteroids, chemotherapy infusions, and insulin [45].

Telemetry: Contemporary higher acuity inpatient practice has incorporated routine usage of telemetry as a proactive means of discovering and treating cardiac events. In the peer-to-peer interaction, a plan must be formulated either for safely and temporarily discontinuing the telemetry or sending a specialized individual with the patient to monitor for cardiac events.

Patient line status: Inpatients will have a variety of ostomies, surgical drains, catheters and the like that will require maintenance and specialized positioning within the scanner. Because these devices will contain patient secretions that may be radioactive, additional caution to minimize the likelihood of contamination in the scanner will be required.

Isolation: In an era of increasingly resistant microorganisms, more and more inpatients will be discovered to be colonized with bacteria that cannot be treated with conventional antibiotics. The vast majority of hospital infection control protocols require that once a patient has been characterized as having a resistant microorganism, the patient must be isolated from other patients and staff. The more common resistant bacteria include methicillin resistant staph aureus (MRSA) and vancomycin resistant enterococcus (VRE) [46-48]. Clostridium difficile (C. diff.) isolation also has become problematic in these same hospital scenarios [49]. Since many hospital organizations cannot afford multiple PET-CT scanners, the prospect of needing to scan isolation patients in the midst of a busy outpatient workflow is not uncommon. Internal protocols that uphold cleaning the patient's uptake room, PET-CT scan room, and scanner itself must be consistently applied to reduce

the likelihood that immuno-compromised outpatients do not contract a resistant bacterial strain from a scheduled inpatient.

Attire: Inpatients will typically be attired in standard hospital gowns which may contain metal snaps that can result in beam hardening and scatter on the CT phase of the imaging. This same metal can also introduce artifacts into the attenuation corrected PET-CT images. Therefore, it is beneficial to proactively remove said gowns or provide alternative attire such as scrubs prior to the scanning event.

Pain management: Given the higher acuity of inpatients as compared to outpatients, it is not surprising that a greater degree of patient pain management may be required. It is helpful to identify additional pain management needs in a peer-to-peer interaction prior to the inpatient's arrival. This will be paramount to maximizing patient comfort such that motion is minimized and a successful PET-CT scanning event will occur. Along with the pain evaluation, the RN can ascertain the patient's need for anxiolytics targeted at minimizing claustrophobia-related distress. To standardize the care of inpatients and enhance a safe time for the patient in PET-CT, it is highly desirable to collect, review, and access all of the aforementioned information prior to the patient's arrival. Figure 15 shows an example of an inpatient criteria sheet that assists the PET-CT staff with determining if an inpatient can safely be transported and scanned:

10. PET-CT image data distribution

Once the PET-CT image data has been acquired and processed, a convenient, rapid, and reliable system must exist to archive the image data. The historical arc of image archiving has spanned from hard-copy radiographic film systems to present day systems that permit viewing digital soft-copies of PET-CT images in Picture Archiving and Communication Systems (PACS). In most radiology and medical imaging settings, PACS has emerged as the preferred archival strategy although there continues to be a diversity of images rendered in the varied hospital and imaging center environments across the United States and globally.

PACS has been configured to support the extensive tomographic image production which is the result of torso axial coverage in the typical PET-CT. This has been especially important as multi-detector CT associated with PET has advanced and resulted in thinner and increased number of slices. It is not unusual for the combined PET-CT image set to contain in excess of 2000 image slices that require rapid transfer to the PACS server and corresponding distribution to image review workstations. Image transfer rates and efficiency will be a function of the bandwidth available throughout the hospital or imaging system network. Rate of image transfer is central to availability of image data on centralized and remote workstations. System slow-downs will also impact the performance of the PET-CT acquisitions if the processed data cannot be rapidly transferred to the PACS. This phenomenon is both vendor and system topology dependant but best practices require that an entire study be transmitted in under 5 minutes for a busy PET-CT imaging center. Figure

PET-CT Protocol:

Whole torso:

Lung protocol:

Wholebody:

Head & Neck:

SPN:

Other:

Approved by: Dr. _____

PET-CT Inpatient Process & Pt Criteria for RNs

CRITICAL REMINDERS:

Did you call PT TRANSPORT? (xxxxx)?

Did you call RT to coordinate? (xxxxx)?

Did you contact CSAS PET POD?

Did you remind the pt's RN to contact CARE MANAGEMENT?

Patient's Name: _____ **Height:** _____ **Weight (lbs):** _____

DOB: _____ **MRN #** _____

Room # _____ **Floor Telephone #** _____

Nurse or Contact Person: _____

Sedation: **Yes** **No**

Misc:

1. RN to RN report must occur prior to Inpatients having a PET scan
2. The PET RN will utilize the following criteria to insure patient safety.
3. The PET RN will complete a focused assessment upon arrival of the Inpatient that at a minimum will include : B/P, Heart rate, Respiratory rate, Patient concern

Inpatient Criteria for PET	Highlighted areas <i>require</i> a patient care provider to accompany patient for PET	
1. Patient is awake and alert?	Yes	No
2. Patient is able to follow instructions?	Yes	No
3. Patient status :		
a. Fall risk (check Powerchart/carefully question floor)?	Yes	No
b. Has swallowing deficits (needs suctioning)?	Yes	No
c. Has restraints applied?	Yes	No
d. Does patient have telemetry?	Yes	No
4. Does patient require frequent pain medications (i.e. < every 4 hours)?	Yes	No
5. Does patient have Med-Surgical status (non-cardiac, post-op, stable)?	Yes	No
6. Patient ambulates independently?	Yes	No
7. Did patient have insulin in the last 12 hours?	Yes	No
8. Does the patient have any IV drips that contain dextrose?	Yes	No
9. Is patient claustrophobic & in need of anxiolysis?	Yes	No
10. Does the patient require ISOLATION?!?	Yes	No
11. Is the patient incontinent/require frequent toileting?!?	Yes	No

Notes: _____

Nurse to accompany patient: YES or NO

*Pt needs at least a 20 gauge IV (22 gauge for peds). All TPN, glucose IV's and feeding tubes must be stopped 6 hours prior to procedure.

Figure 15. Inpatient criteria sheet example

16 graphically depicts the relationship between image data transfer rate and transfer time. There is a clear exponential relationship which is quickly realized within the imaging

workflow because transfer rate and time delays can cause backlogs and impair overall PET-CT system performance.

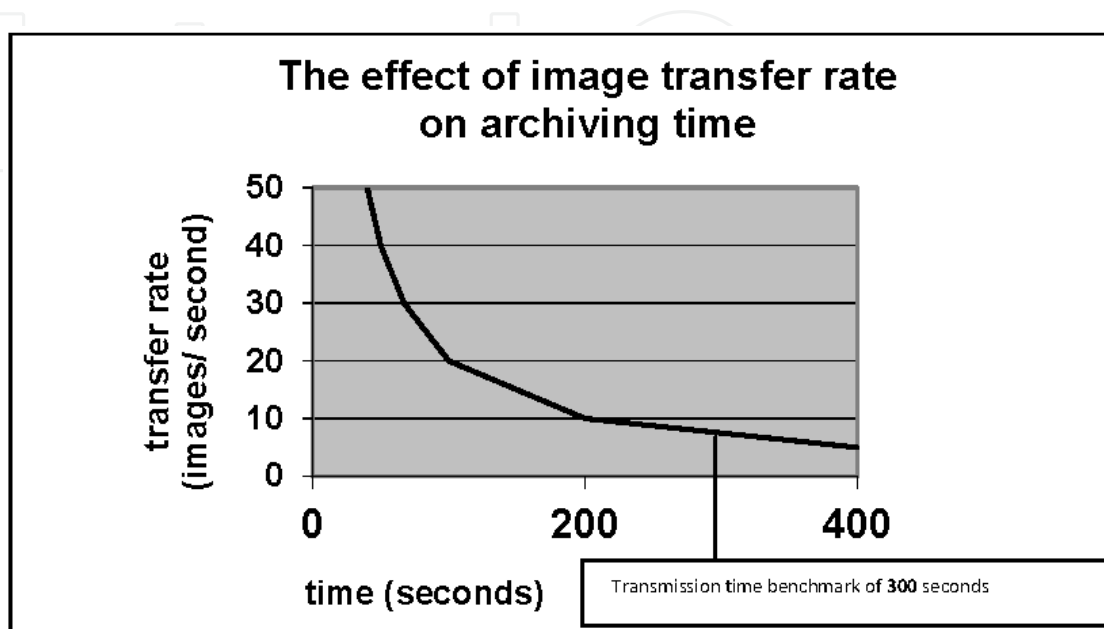

Figure 16. Relationship between rate of image transfer and archival time:

Given the opportunity, PET-CT, medical informatics professions, and information technology professionals should begin to collaborate early in the process of configuring PET-CT operations. This working relationship has become an imperative as image acquisition and corresponding PET-CT report turn-around-time have become an important metric in quantifying standard-of-care. The shape and layout of the network and nodes (topology) should be considered both before and during the establishing of the PET-CT infrastructure. For large hospital systems with multiple sites and remote viewing requirements, having a scalable network with very high bandwidth and redundancies will be paramount. This becomes a complicated and expensive undertaking as network cabling, switches, servers, and all manner of information technology infrastructure will need to be considered, purchased, deployed, and maintained over the course of many years. Figure 17 illustrates an example of the configuration of a typical PET-CT system topology and interconnectivity. A clear understanding of the connectivity, dependence, and relationship of both hardware and software items is vital to initial troubleshooting during system failure. Many issues such as physical disconnection between devices due to loose cabling or locating of devices requiring a reboot can be identified simply by knowing the system topology and understanding the interrelationship of system components.

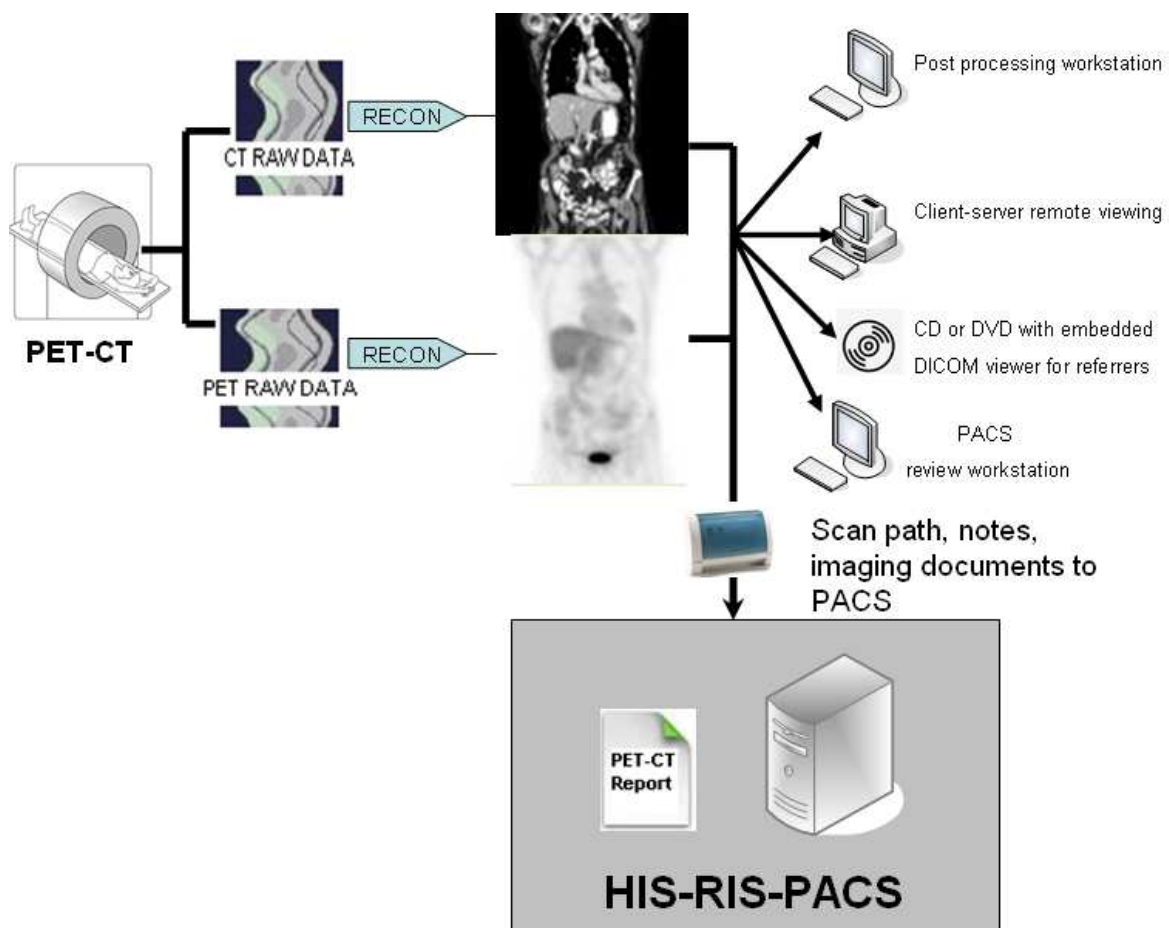

Figure 17. Example PET-CT system topology

11. PET-CT image archiving and retrieval

11.1. PACS workflows

A consistent, reproducible, and accessible PACS workflow should be conceived and followed by the PET-CT staff who generate the images. In particular, it will be important to consider ancillary information that the radiologist requires to read the images and the accessibility of said materials [1, 38]. The PET-CT images are certainly the centerpiece of the exam but additional information such as pathology reports, consults, and imaging reports augment the interpretation process. There are three approaches to incorporating this information into the PACS workflow effectively. The first option will be to simply printout and provide the radiologist with any ancillary clinical information that will be used to render the report. This is the least desirable method because it involves a substantial shuffling of paper and usage of printer resources. However, many institutions still use the standard paper method because of the imaging culture of the institution. The 2nd option will be to forego any printing of documents and deliver these to the radiologist in a purely “paperless” or soft format. This will

require a favorable and convenient adjacency of the Health Information System/Radiology Information System (HIS/RIS) to the PACS workstation. It also requires support staff to scan in any documents that are not native to the hospital or imaging center. The third option that occurs in highly integrated healthcare environments is a merger of PACS, HIS, & RIS all within the PACS environment. This requires maximum collaboration and cooperation of Radiology and Medical Informatics as well as appropriately planned monitor and screen real estate. In a well-planned and executed fully integrated PACS/HIS/RIS, the radiologist can readily navigate and among the aforementioned applications with minimal paper waste and streamlined workflow. Figure 18 shows a fully functional PACS/HIS/RIS configuration.

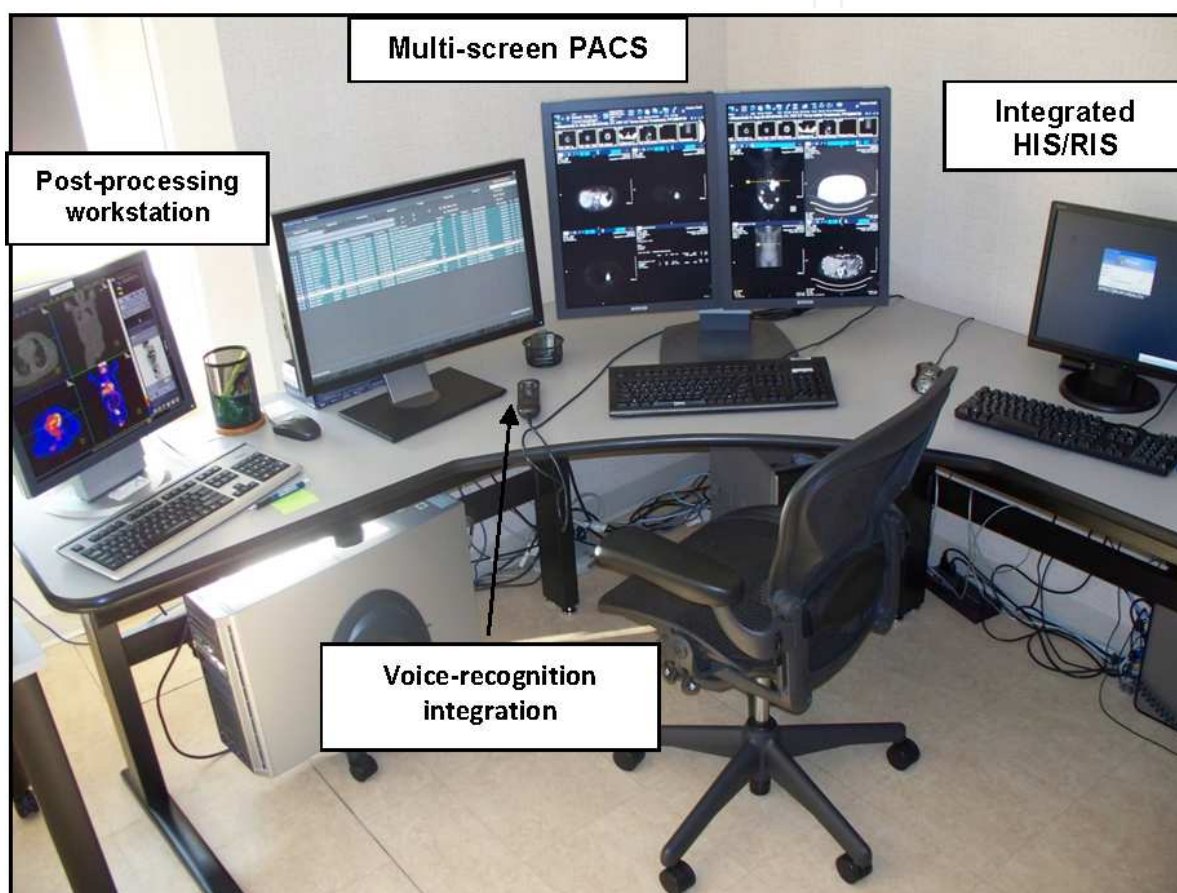

Figure 18. Fully-integrated PACS together with HIS & RIS. Note that full voice recognition transcription functionality has also been incorporated into the process for the most optimized report turn-around-time.

11.2. Non-PACS image distribution methodologies

In addition to PACS-based image viewing systems, it is inevitably necessary to view PET-CT images in other venues where PACS may not be available. Given that all data is DICOM-based, the best solution is to obtain the images on a solid-state media such as compact disk (CD) or digital video disk (DVD) and upload the data to PACS for viewing. This option also has the advantage of being executed on the user's computer regardless of bandwidth limitations.

Hospital or imaging centers with virtual private networking (VPN) capability may use file transfer protocol (FTP) as a means of securely and reliably transferring image data. With contemporary firewall systems, this often becomes a challenging undertaking fraught with information technology issues that will require an advanced user with administrative system access capabilities. Invariably, however, many institutions lack a full PACS or means of securely transmitting image data via ftp. This includes many surgical suites outside of the hospital or imaging center where the PET-CT originated, as well as community-based oncology groups, and virtually any location beyond the reach of native PACS. For such situations, the next best option for viewing images will be client-server based viewing capabilities. This will involve providing the remote user with a username and password to authenticate with the PACS server and then streaming data to the remote user's monitor. The distinct disadvantage of this method is that almost no PC-based client server monitors possess the appropriate resolution inherent to a PACS monitor that has true DICOM gray scale standard rendering [50, 51].

12. Internal archival methods

There are instances in which PACS does not provide a desirable location for storage. This is particularly true in instances whereby raw data sets such as PET or CT sinograms must be stored. This situation will commonly occur and be an imperative for research protocols that require the original raw data to be available in perpetuity. Sending the PET and/or CT sinograms across the network from the modality to PACS invariably results in raw data corruption resulting either in transmission failure or unusable data. Offline storage devices such as Redundant Arrays of Independent Disks (RAID) or terabyte hard drives are viable solutions in these cases. The compatibility of these options must first be vetted with the PET-CT scanner vendor to ensure long-term stability and recoverability of the raw data. These systems do have the advantage of being scalable as additional disk space can be added both to RAID and other types of offline hard drive systems [1, 38, 40].

13. Conclusion

From PET's primary research-oriented imaging in the 1970s and 1980s to contemporary PET-CT routinely used for oncology and neurology, PET continues to play an important role in the management of and characterization of a wide variety of disease processes. PET-CT as practiced today remains one of the most challenging and complex type of imaging studies performed in most hospital or imaging center environment. This derives largely from the integration of 2 somewhat divergent modalities along with the multifaceted diagnostic requirements of patients in oncology and neurology. An understanding of the acquisition, processing, and archiving of PET-CT data is central to sustaining a safe, patient-centered and high-quality PET-CT image product.

Acknowledgements

The author wishes to thank Dr. Paul Shreve and the staff of the Spectrum Health Lemmen Holton PET-CT Cancer Pavilion for their insight and support in writing this chapter.

Author details

Todd Faasse*

Address all correspondence to: todd.faasse@spectrumhealth.org

Spectrum Health, Grand Rapids, Michigan, USA

References

- [1] Faasse T. and Shreve, P., Positron Emission Tomography-Computed Tomography Patient Management and Workflow. Sem. in Ultrasound CT MR. 29(4):277-82, 2008
- [2] Shreve P., Establishing a PET-CT Practice. AJR 184(5):146-151, 2005.
- [3] Townsend D. Combined PET/CT: A Historical Perspective. Sem. in Ultrasound CT MR. 29(4): 232-235, 2008.
- [4] Bendriem B., Townsend, D. editor-The Theory and Practice of 3D PET. Kluwer Academic Publishers, 26-38
- [5] Bacharach, Stephen. PET/CT Attenuation Correction: Breathing Lessons. J. Nucl. Med. 48(5): 677-679, 2007
- [6] Kinehan P. Quantitative Attenuation Correction for PET/CT Using Iterative Reconstruction of Low-Dose Dual-Energy CT. Institute of Electrical and Electronics Engineers (IEEE). <http://web.eecs.umich.edu/~fessler/papers/files/proc/04/web/kinahan-04-qac.pdf> (accessed 20 August 2012).
- [7] Moses W. Nucl. Instrum. Methods Phys. Res. A. 648(1): 236-240, 2011 <http://www.ncbi.nlm.nih.gov/pmc/articles/PMC3144741/> (accessed 29 August 2012).
- [8] Moses W. Recent Advances and Future Advances in PET Time-of-Flight. Nucl. Instrum. Methods Phys. Res. A. 580(2): 919-924, 2007 <http://www.ncbi.nlm.nih.gov/pmc/articles/PMC2084388/> (accessed 29 August 2012).
- [9] Karp J. Benefit of Time-of-Flight in PET: Experimental and Clinical Results. J. Nucl. Med. 49(3): 462-470. <http://jnm.snmjournals.org/content/49/3/462.full>
- [10] Melcher C. Scintillation Crystals for PET. J. Nucl. Med. 2000 Jun;41(6):1051-1055

- [11] Kinehan P., Positron Emission Tomography-Computed Tomography Standardized Uptake Values in Clinical Practice and Assessing Response to Therapy. Sem. in Ultrasound CT MR. 31(6) 496-505, 2010
- [12] Buchs M, Value of contrast-enhanced 18F-fluorodeoxyglucose positron emission tomography/computed tomography in detection and presurgical assessment of pancreatic cancer: A prospective study. Journal of Gastroenterology and Hepatology 26(4) 657-662, 2011 <http://onlinelibrary.wiley.com/doi/10.1111/j.1440-1746.2010.06525.x/abstract> (accessed on 29 August 2012)
- [13] Wechalekar K., PET/CT in Oncology-a major advance. Clinical Radiology 60, 1143–1155, 2005 <http://www.ectsia.org/radac/jc28020602.pdf> (accessed 29 August 2012)
- [14] Nehmeh SA. Correction for oral contrast artifacts in CT attenuation-corrected PET images obtained by combined PET/CT. J Nucl. Med. 44(12):1940-1944, 2003
- [15] Antoch G. Focal Tracer Uptake: A Potential Artifact in Contrast-Enhanced Dual-Modality PET/CT Scans. J. Nucl. Med. 43(10):1339–1342, 2002
- [16] Wiley G. Disruptive Technology: The Conflict Over PET/CT. Imaging Economics. http://www.imagingeconomics.com/issues/articles/2005-06_02.asp (accessed 30 August 2012)
- [17] Wong T., Practical Approach to Diagnostic CT Combined with PET. AJR.188(3) 622-629, 2007
- [18] Wang C, Frequency, Management, and Outcome of Extravasation of Nonionic Iodinated Contrast Medium in 69 657 Intravenous Injections. Radiology, 243(1), 80-87, 2007
- [19] Solomon R., The role of osmolality in the incidence of contrast-induced nephropathy: a systematic review of angiographic contrast media in high risk patients. Kidney Int. 68(5):2256-63, 2005.
- [20] American College of Radiology Manual on Contrast Media: Treatment of Contrast Reactions: <http://www.acr.org/Quality-Safety/Resources/Contrast-Manual> (accessed 31 August 2012)
- [21] Gleeson T., Contrast Induced Nephropathy. AJR 183(6) 1673-168, 2004.
- [22] American College of Radiology: Practice Guideline for the Use of Intravascular Contrast Media. http://www.acr.org/~media/ACR/Documents/PGTS/guidelines/IV_Contrast.pdf (accessed 31 August 2012)
- [23] Gustav K., Integrated PET/CT: Current Applications and Future Directions. Radiology, 238(2), 405-422, 2006.
- [24] Antoch G., Whole Body Positron Emission Tomography-CT-Optimized CT Using Oral And IV Contrast Materials, AJR 179(6):1555-1560, 2002.

- [25] Computers in Radiology Series: PACS, RIS/HIS, DR/CR (Part 2) <http://www.ceessentials.net/article10.html> (accessed 31 August 2012).
- [26] Deficit Reduction Act. <http://www.cms.gov/Regulations-and-Guidance/Legislation/DeficitReductionAct/index.html?redirect=/deficitreductionact/> (accessed 31 August 2012).
- [27] Renard S., A bigger bang: DRA sending shock waves, 'reduction without proper representation' to radiology, oncology communities. http://radiology-services.com/pdf/Bay_area_oncology_news_12-06.pdf (accessed on 31 August 2012).
- [28] Timmerman R. editor. Image-Guided and Adaptive Radiation Therapy, Lippincott, Williams, and Wilkins, 2009, 4-10.
- [29] Walsh B., PET/CT: Charting the Treatment Course. http://www.healthimaging.com/index.php?option=com_articles&view=article&id=6589 (accessed 31 August 2012).
- [30] IMV Medical PET Benchmark report. <http://www.imvinfo.com/index.aspx?sec=pet&sub=def> (accessed 31 August 2012).
- [31] Nadel H., Pediatric Positron Emission Tomography-Computed Tomography Protocol Considerations. *Seminars in Ultrasound, CT and MRI*. 29(4) 271-276, 2008
- [32] Fahey FH. Dosimetry of Pediatric PET/CT. *J Nucl. Med.* 50(9):1483-1491. <http://jnm.snmjournals.org/content/50/9/1483.full.pdf>. (accessed 31 August 2012).
- [33] McQuattie S. Pediatric PET/CT Imaging: Tips and Techniques. *J. Nucl. Med. Technol.*; 36:171-178, 2008.
- [34] What are the Radiation Risks from CT? <http://www.fda.gov/radiation-emittingproducts/radiationemittingproductsandprocedures/medicalimaging/medicalx-rays/ucm115329.htm>, (accessed 31 August 2012).
- [35] The Alliance for Radiation Safety in Pediatric Imaging-Image Gently. <http://www.pedrad.org/associations/5364/ig/>. (accessed 31 August 2012).
- [36] Blodgett T., Best Practices: Consensus on Performing Positron Emission Tomography-Computed Tomography for Radiation Therapy Planning and for Therapy Response Assessment. *Sem. in Ultrasound CT MR*. 31(6):506-515, 2010
- [37] Yoo D., The Role of Adaptive and Functional Imaging Modalities in Radiation Therapy: Approach and Application from a Radiation Oncology Perspective. *Sem. in Ultrasound CT MR*. 31(6):444-461, 2010
- [38] Faasse T., Patient and Image Data Management in Positron Emission Tomography-Computed Tomography for Radiation Therapy and Therapy Response Assessment. *Sem. in Ultrasound CT MR*. 31(6):480-489, 2010
- [39] Segall G., Therapy Response Evaluation with Positron Emission Tomography-Computed Tomography. *Sem. in Ultrasound CT MR*. 31(6):490-495, 2010.

- [40] Shreve P., Positron Emission Tomography-Computed Tomography Protocols for Radiation Therapy Planning and Therapy Response Assessment. Sem. in Ultrasound CT MR. 31(6):468-479, 2010.
- [41] Gray-Micelli D. Preventing falls in acute care. Evidence-based geriatric nursing protocols for best practice. 3rd ed. New York (NY): Springer Publishing Company; 2008. p. 161-98, 2008.
- [42] Degelau J, Belz M, Bungum L, Flavin PL, Harper C, Leys K, Lundquist L, Webb B, Institute for Clinical Systems Improvement (ICSI). Prevention of falls (acute care). Health care protocol. Bloomington (MN): Institute for Clinical Systems Improvement (ICSI); 2012 Apr. 43 p.
- [43] Nadzam D., Preventing Falls-Patient Safety and Quality Care. Joint Commission Resources. <http://www.jcrinc.com/Preventing-Patient-Falls/> (accessed 1 September 2012).
- [44] Joint Commission National Patient Safety Goals. http://www.jointcommission.org/standards_information/npsgs.aspx (accessed 1 September 2012).
- [45] Shreve P., Clinical PET-CT in Oncology. New York. Springer: 2008.
- [46] Murray BE., Vancomycin-resistant enterococcal infections. N. Engl. J Med. 342:710–21, 2000.
- [47] Rice LB., Antimicrobial resistance in gram-positive bacteria. Am. J. Infect Control 34(5 Suppl. 1):11-9; discussion 64-73. 2000.
- [48] David, M., Community-Associated Methicillin-Resistant Staphylococcus aureus: Epidemiology and Clinical Consequences of an Emerging Epidemics. Clin. Microbiol. Rev. 23(3) 616-687, 2010.
- [49] Lipp MJ, The impact of hospital-acquired Clostridium difficile. J. Gastroenterol. Hepatol. 2012 Jul 31.
- [50] Lowe J., Variations in Performance of LCDs Are Still Evident After DICOM Gray-Scale Standard Display Calibration. AJR 195(1): 181-187, 2010.
- [51] Indrajit R., Monitor Displays in Radiology: Part 2. Indian J. Radiol. Imaging. 19(2): 94–98, 2010.

