

We are IntechOpen, the world's leading publisher of Open Access books Built by scientists, for scientists

4,800

Open access books available

122,000

International authors and editors

135M

Downloads

Our authors are among the

154

Countries delivered to

TOP 1%

most cited scientists

12.2%

Contributors from top 500 universities

**WEB OF SCIENCE™**Selection of our books indexed in the Book Citation Index
in Web of Science™ Core Collection (BKCI)

Interested in publishing with us?
Contact book.department@intechopen.com

Numbers displayed above are based on latest data collected.

For more information visit www.intechopen.com

The Role of the Statistical Method of Motor Unit Number Estimation (MUNE) to Assess the Potential Therapeutic Benefits of Riluzole on Patients with Pre-symptomatic Familial Amyotrophic Lateral Sclerosis

Arun Aggarwal

Additional information is available at the end of the chapter

<http://dx.doi.org/10.5772/56559>

1. Introduction

Amyotrophic lateral sclerosis (ALS) is a fatal neurodegenerative disease which attacks the motor system. There is a family history in approximately 10% percent of cases and 20% of such families have point mutations in the Cu, Zn superoxide dimutase 1 (SOD1) gene. Pre-symptomatic loss of motor neurons has been identified prior to the onset of symptoms in SOD1 mice. This loss was biphasic with initial loss in the pre-symptomatic phase followed by a period of stabilisation and then gradual loss at time of weakness to death. (Kong & Xu, 1998).

In order to determine the time course of motor neurone loss prior to symptomatic onset of disease, a longitudinal study of at-risk asymptomatic individuals (i.e. SOD1 mutation carriers with no neurological symptoms or signs as determined by a neurologist) was performed. There was no detectable difference in the number of motor units in SOD1 mutation carriers compared to their SOD1 negative family controls. (Aggarwal & Nicholson, 2001). This may indicate that mutation carriers have undetectable loss of motor neurones until rapid and widespread cell death of motor neurones occurs, coinciding with the onset of symptomatic features. This implies that the disease is not the end result of the slow attrition of motor neurones. (Aggarwal, 2009).

This longitudinal study was extended on 20 asymptomatic carriers of the Cu, Zn superoxide dimutase 1 (SOD1) point mutation. There was a sudden reduction in MUNE, several months prior to the onset of weakness. (Aggarwal & Nicholson 2002) and (Aggarwal, 2009). This suggests that gradual pre-clinical loss of motor neurones does not occur in asymptomatic SOD1

mutation carriers and supports the observation that sudden, catastrophic loss of motor neurones occurs immediately prior to the onset of symptoms and the development of the disease, rather than a gradual attrition of motor neurones over time. These results suggest that there may be a biological trigger initiating rapid cell loss, just prior to the onset of symptoms.

Current treatment for sporadic ALS or Cu, Zn superoxide dimutase 1 (SOD 1 mutation) familial ALS, produces only a modest increase in survival. The excitatory amino acid neurotransmitter, glutamate, may be involved in the pathogenesis of ALS. Riluzole, an anti-glutamate agent, remains the only disease modifying therapy available for ALS and has been used since 1995. (Cheah et al, 2010). Treatment of human ALS patients or transgenic Cu, Zn superoxide dimutase 1 (SOD 1) mice, most commonly produce a modest but significant increase in survival. (Bensimon et al, 1994). It has also been shown to have a small beneficial effect on bulbar function, but not muscle strength.

Using the statistical motor unit number estimation (MUNE) technique, (Daube, 1995), a longitudinal study was performed to determine whether early institution of Riluzole can reduce that rate of motor unit loss in familial amyotrophic lateral sclerosis (fALS). Motor unit numbers were estimated from the right abductor pollicis brevis (APB) and right extensor digitorum brevis (EDB) muscles. Our subjects had a presumptive diagnosis of fALS, as electromyography (EMG) was "normal" with an absence of fasciculation and fibrillation potentials, normal motor unit potentials and normal recruitment. MUNE is more sensitive than EMG and once changes occur on conventional EMG studies, the window of opportunity to influence the progression of this condition has been missed. They were all commenced on Riluzole therapy in the pre-symptomatic phase, as soon as loss of motor units was detected using motor unit number estimation (MUNE). After commencing Riluzole, "symptomatic" improvement occurred, especially a decrease in muscle fasciculations and an improvement in MUNE. Riluzole is not a disease altering agent but possibly if given early in the pre-symptomatic phase of the disease, before significant motor neurone loss has occurred, it may have some therapeutic benefit.

This effect may have implications for the management of asymptomatic carriers of the SOD 1 gene, as these subjects are at risk of developing ALS.

Regular follow-up of SOD1 carriers with MUNE may lead to early diagnosis, creating an opportunity for future approaches and therapies aimed at preserving motor neurones rather than replacing lost motor neurones. Detecting the onset of motor neurone loss in asymptomatic individuals will identify those who may benefit from early institution of an active management program to improve their quality of life, until more effective treatment modalities are available for this devastating condition.

2. Background

Amyotrophic lateral sclerosis (ALS) is a group of fatal, neurodegenerative disorders, which is characterised pathologically by progressive degeneration and loss of motor neurones in the

anterior horn cells of the spinal cord, motor nuclei of the brainstem and the descending pathways within the corticospinal tracts. The term amyotrophic lateral sclerosis (ALS) is used synonymously with motor neurone disease (MND) in the USA, but in the UK and Australia is used only to refer to patients who have a combination of upper and lower motor neurone dysfunction. (Talbot, 2002).

It is primarily a condition of middle to late life, with onset of symptoms between the ages of 50 and 70 and a mean age of onset of 57.4 years. (Ringel et al., 1993). Occasionally, it arises as early as the 2nd decade or as late as the 9th decade. In a natural history study, the overall median survival is 4.0 years from the onset of symptoms, but only 2.1 years from the time of diagnosis. (Ringel et al., 1993). In a study performed at the Mayo clinic, approximately 50% of patients died within 3 years of referral, but 20% were still alive at 5 years and 10% were still alive at 10 years. (Mulder & Howard, 1976).

Aging, motor neurone diseases and many peripheral neuropathies are all associated with loss of motor neurones or axons. When the disorders are recent or rapidly progressive, the extent of the loss may be indicated by weakness and wasting. In slowly progressive denervating conditions, like MND, loss of more than 50-80% of motor units may occur with little or no clinically apparent weakness.

It has been showed that patients with substantial chronic denervation could maintain normal muscle twitch tension until loss of about 70-80% of motor units occurred. (McComas, 1971). The surviving motor neurones enlarge their territories, through collateral sprouting (reinnervation) to keep pace with cell loss, to maintain the muscle maximum compound muscle action potential (CMAP), until late in the disease. At this point, collateral reinnervation is no longer able to provide full functional compensation. (Campbell et al., 1973).

In MND, needle electromyography often reveals evidence of chronic reinnervation (increased motor unit action potential amplitudes and duration with reduced recruitment), but provides little direct evidence to the extent of motor neurone and axonal loss. The supramaximal CMAP amplitude also provides little direct evidence of the extent of motor neurone loss. Normal CMAP amplitudes might mistakenly suggest that motor neurone loss has not occurred yet. (Shefner, 2001).

Motor unit number estimation (MUNE) is a more reliable method for following changes in neurogenic disorders than the CMAP amplitude. It estimates the number of functioning lower motor neurones innervating a muscle or a group of muscles i.e. the number of motor units, which can be excited by electrical stimulation. It is therefore an indirect measure of motor neurone loss, rather than a measure of primary pathology. It can identify that the number of motor units may be well below normal, in the presence of normal CMAP amplitudes. (Brown, 1972).

Pre-symptomatic loss of motor neurones has been identified in an animal model of the disease (transgenic mice expressing mutant human SOD1-G93A). The initial loss in the pre-symptomatic phase related to severe motor axonal degeneration due to vacuolar changes in motor neurones and a slow decrease in CMAP amplitudes. After a period of stabilisation, there was a gradual loss of motor neurones and a rapid decrease in CMAP amplitude, at the onset of

weakness due to myelin alteration. At this point, there was a striking loss of motor units. There was also decrease in evoked motor potentials (an indirect measure of the number of motor units), prior to the onset of symptoms. The onset of disease in transgenic G93A mice involves a sharp decline of muscle strength and a transient explosive increase in vacuoles derived from degenerating mitochondria, but little motor neurone death. These did not die until the terminal stage. (Kong & Xu, 1998). The decline exhibited kinetics consistent with both a constant and exponentially decreasing risk of neuronal death. An escalating risk forced by cumulative damage was not responsible for cell death. (Azzouz et al., 1997).

It is possible that the high metabolic activity in motor neurones, combined with the toxic oxidative properties of the mutant SOD1, causes massive mitochondrial vacuolation in motor neurones, resulting in degeneration, earlier than other neurones, triggering the onset of weakness. The involvement of mitochondrial degeneration in the early stages is consistent with a direct effect of toxicity, mediated by properties gained by the mutant enzyme in catalysing redox reactions. (Beckman et al., 1993).

Until recently, it has not been possible to address this in humans, as pre-symptomatic diagnosis was not possible. Now, with the ability to identify Cu, Zn superoxide dismutase 1, (SOD1) mutation carriers, a group of human pre-symptomatic subjects can be studied to determine whether there was gradual lifelong pre-symptomatic loss of motor neurones or whether sudden catastrophic loss of motor neurones occurs just prior to the onset of clinical symptoms.

3. Familial ALS

The only forms of MND in which a clear cause has been established are the genetic variants. 20% of all familial cases are the dominantly inherited adult onset form of MND, which is clinically indistinguishable from the sporadic form of MND. These are due to a point mutation in the cytosolic Cu, Zn superoxide dismutase 1, (SOD1) gene on long arm of chromosome 21 (21q22.1). (Siddique & Deng, 1996). Mutations in other genes, alsin and the heavy subunit of neurofilament (NEFH) can also result in motor neurone degeneration in humans. Two other genes that have been investigated are the other isoforms of SOD. MnSOD (SOD2) maps to chromosome 6q25 and is primarily located in mitochondria and extracellular SOD (SOD3) maps to chromosome 4p15.2. Neither of these genes have yet to be linked to FALS. (Hand & Rouleau, 2002). There is however genetic heterogeneous and other causal genes remain to be found to explain the vast majority of FALS cases. (Siddique et al., 1989).

The initial study to establish a causal link between the SOD1 gene and familial MND (FALS) identified a total of 11 missense mutations in two exons studied in 13 autosomal dominant MND families. (Rosen et al., 1993). This led to an explosion of SOD1 gene screening in MND pedigrees. To date 112 different mutations in the SOD1 have been found which can lead to changes throughout the protein. There have been 99 substitutions, 5 polymorphisms, 3 insertions, 4 deletions and 1 compound mutation types identified. Mutations have been identified in all five exons of the gene. These include 20 on exon 1, 13 on exon 2, 8 on exon 3, 39 on exon 4 and 29 on exon 5 (Figure 1). There have also been 2 non-exon mutations identified

on intron 4 and intron 1 and 14 'apparently' sporadic cases described with 6 different SOD1 mutations. (Shaw et al., 1998).

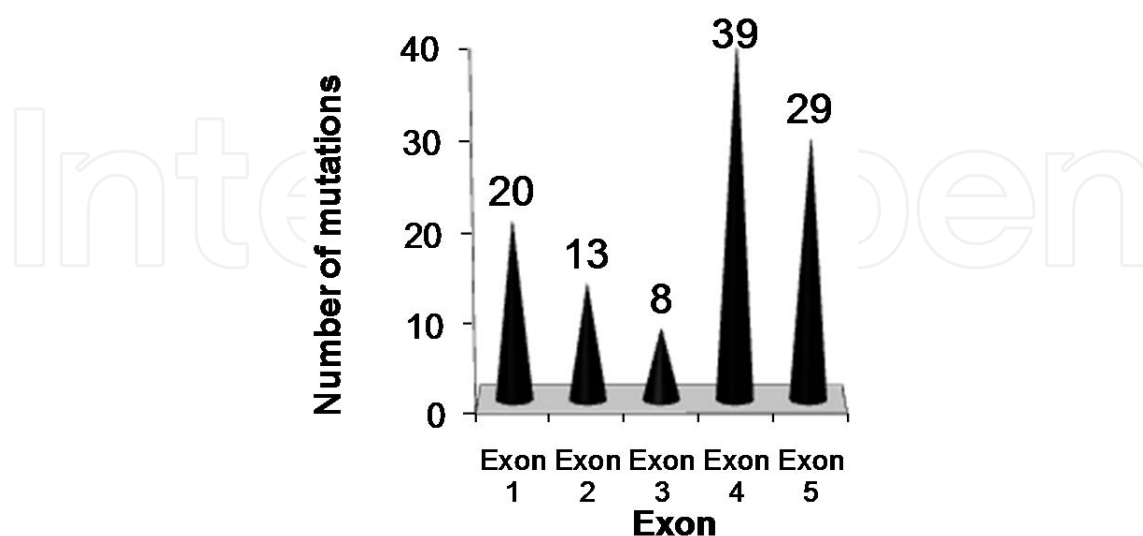

Figure 1. Number of SOD1 mutations identified for each exon

Most are autosomal dominant in inheritance, but there is one confirmed autosomal recessive mutation, the D90A mutation in exon 4. This is unique in that it exists in dominant families in a heterozygous state, but in a number of pedigrees, specifically those of Scandinavian ancestry, homozygous mutations are required for disease. (Andersen et al., 1997).

Mutations in the heavy polypeptide 200kDa subunit of neurofilaments (NEFH) have been identified in sporadic MND cases, (Figlewicz et al., 1994) and in one FALS case. (Al-Chalabi et al., 1999). Accumulation of neurofilaments in cell bodies and axons of motor neurons is a pathological hallmark of early stages of many neurodegenerative diseases. These mutations lie in the region of the protein involved in cross-linking and thus may disrupt normal aggregation of filaments. Thus far, 1 insertion and 5 deletion mutations have been identified on exon 4. Analysis of the NEFH locus on chromosome 22 however has failed to detect linkage in MND families. (Vechio et al., 1996). Genome search on a large pedigree with autosomal dominant juvenile onset MND found strong evidence for linkage to chromosome 9q34 (ALS4). The average age of onset is 17 years, with slow progression of disease. (Chance et al., 1998). There is also an autosomal recessive, juvenile onset MND, with linkage to a locus on chromosome 15 (ALS5). (Hentati et al., 1998).

The other 90% of all MND patients have the sporadic form. There is no recognisable phenotypic difference between FALS and sporadic MND. The male: female ratio is 1:1 in FALS and 1.7:1 in sporadic MND. (De Bellerocche et al., 1995). This decreases with increasing age of onset and approaches 1:1 after the age of 70. (Haverkamp et al., 1995). The site of onset is variable. Survival does not seem to be affected by age or gender, but rather the site of symptom onset. Generally, bulbar onset disease has a worse prognosis, and upper limb onset is more favourable. (Mulder et al., 1986).

It has been postulated that sporadic MND may be the final development of a chain of events that may be set in motion at one or more places in the central nervous system by endogenous and exogenous causes, or both. The aetiology of MND however remains unknown and is probably multifactorial. (Eisen 1995). There is no evidence to support the cause of sporadic MND being due to accumulation of heavy metals in the environment, (Needleman, 1997), deficiencies or excess of essential trace metals, (Mena et al., 1967) or exposure to environmental poisons and industrial solvents. (Leigh, 1997). There is also no evidence to support the cause of sporadic MND being due to excessive physical activity or antecedent trauma.

4. Possible patterns of motor neurone loss

In normal healthy individuals, it has been shown that there is little loss of functioning motor neurones before the age of 60. The normal aging process then accounts for loss of approximately 3.9% of the original motor neurone pool per annum after the age of 60. (Brown, 1972). In this situation, the number of motor neurones remain fairly constant up to the age of 60, after which there is a gradual steady decline with age.

MND may be due to a slow attrition of motor neurones over time (Pattern 1 in Figure 2). If this were the case, pre-symptomatic motor neurone loss may be identifiable in SOD1 mutation carriers, as eventually there may be a gradual decline over time (Figure 2).

Another possible course of MND is that normal numbers of motor neurones are maintained until sudden, rapid multi-focal cell death of motor neurones occurs, corresponding with the development of symptoms (Pattern 2 in Figure 2). If this situation, it would be expected that SOD1 mutation carriers have a normal number of motor neurones during the pre-symptomatic phase. In this case, cell death occurs as neurones gradually accumulate damage, secondary to the mutation, which ultimately overwhelms cellular homeostasis. This is the cumulative damage hypothesis. (Clarke et al., 2000).

One of the mechanisms most frequently proposed to underlie cumulative damage is oxidative stress, in which an imbalance between the production of reactive oxygen species and cellular antioxidant mechanisms results in chemical modifications of macromolecules, thereby disrupting cellular structure and function. (Robberecht, 2000). A key prediction of the cumulative damage hypothesis is that the probability that any individual neurone will become committed to apoptosis increases as damage accrues within it. A mutant neurone in an older patient will have accumulated a greater amount of damage and is therefore more likely to die than in a younger patient. Consequently, early in the course of disease, the chance of a cell containing a sufficient amount of damage to initiate apoptosis is small, and the rate of cell loss is correspondingly low. However, as the amount of intracellular damage increases, the chance that a cell will die also increases.

It has been shown that the kinetics of neuronal death in a number of inherited neurodegenerative diseases was best explained by models in which the risk of cell death remains constant throughout life of the neurone and that cell death occurred randomly in time and was

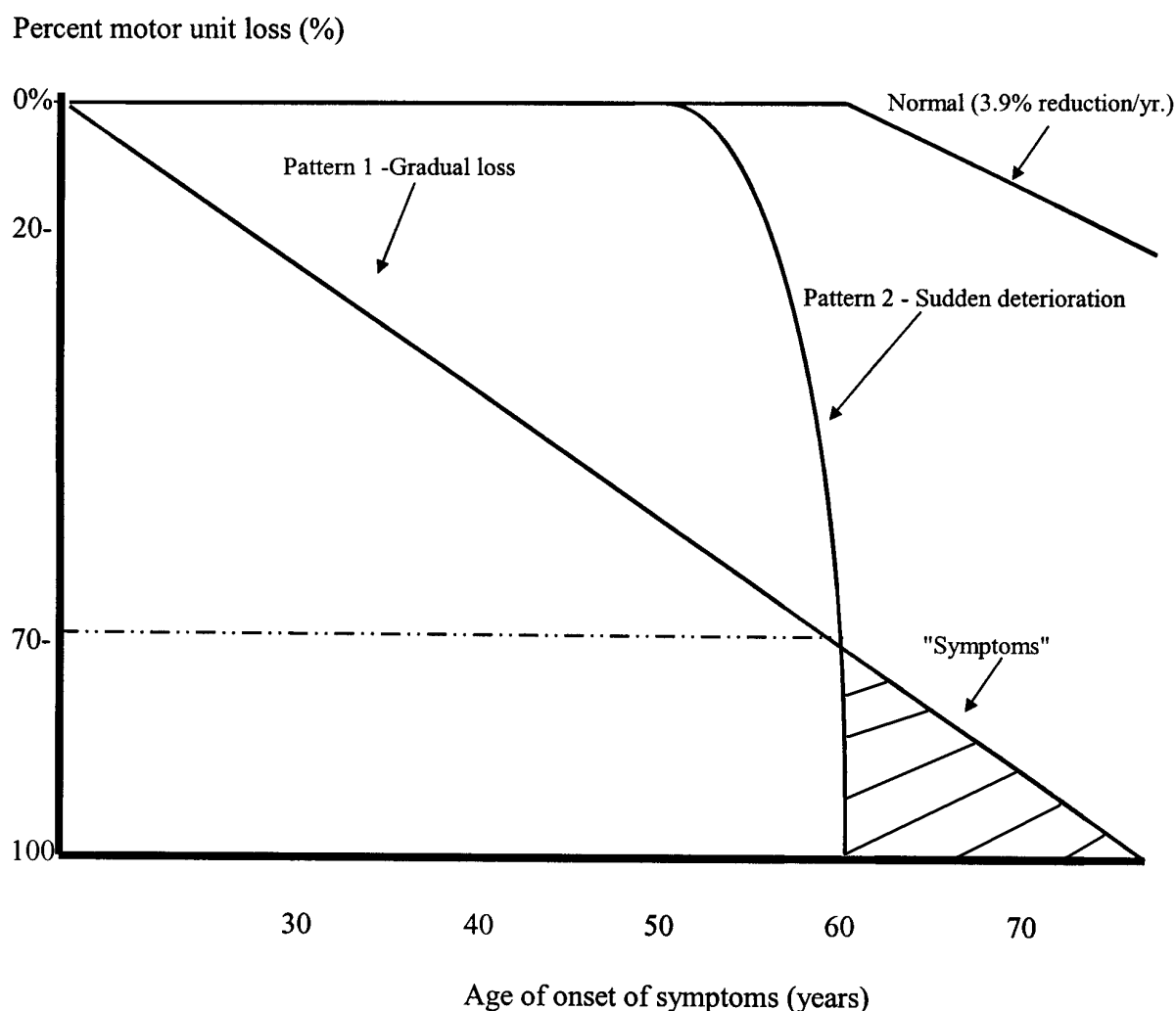

Figure 2. Diagrammatic representation of possible patterns for motor neurone loss in an individual.

independent of any other neurone. This implies a “one-hit” biochemical phenomenon in which the mutant imposes an abnormal mutant steady state on the neurone and a single catastrophic event randomly initiates cell death and apoptosis. The principal features of the mutant steady state are that the living mutant neurones function very well for years or even decades and that the predominant feature of the mutant neurones is that they are all at a risk of death. This argues against the multiple environmental factors hypothesis as a cause of MND, as a random process is probably responsible for the initiation of disease. (Clarke et al., 2001).

5. Cu/Zn Superoxide Dismutase (SOD1) mutations

Linkage studies for familial MND (FALS) on chromosome 21q22.1 led to the identification of point mutations in the gene for Cu/Zn superoxide dismutase (SOD1) as a cause of MND. (Siddique 1991). Superoxide (O_2^-) is an unstable and highly active molecule, which causes

oxidation of cell constituents either directly or through toxic and stable derivatives. The major superoxide dismutase activity in cytoplasm is from SOD1, which consists of 5 small exons that encode 153 highly conserved amino acids with a molecular weight of 16Kda. SOD1 is a homodimer. Within each monomer, there is an active site containing one atom each of copper and zinc. (Radunovic & Leigh, 1996).

The most common SOD1 gene mutation seen in FALS is an alanine to valine shift at codon 4 (Ala4Val). This accounts for 50% of all mutations in the USA. (Rosen, 1993). Of all the clinical variables, only bulbar onset and three specific mutations seem to influence age of onset of MND. Bulbar patients are older when their illness begins, whereas the Gly37Arg and Leu38Val mutations predict an earlier age of onset. Leu38Val is associated with the earliest onset (mean 35.5 years) and Ile113Thr with the latest onset (mean 58.9 years).

In terms of survival, Ala4Val correlated with the shortest survival of 1.5 years. Whereas, Gly37Arg, Gly41Asp, and Gly93Ala mutation predicted longer survival. The mutations that predict earlier onset are not the same as those that correlate with shortest duration of disease. (Cudkowicz et al., 1997). This suggests that the factors that influence onset of disease differ from those that influence the rate of progression of the disease.

Determining the mechanism by which mutations in the Cu/Zn superoxide dismutase (SOD1) gene triggers the destruction of motor neurones causing MND remains a challenging and complex problem. Five primary hypotheses have been postulated for the pathogenesis of FALS (Figure 3). (Hand & Rouleau, 2002). At present the favoured hypothesis is that the mutation causes disease as a result of a toxic gain of function by the mutant SOD1 provoking selective neurotoxicity, probably disrupting the intracellular homeostasis of copper and/or protein aggregation. (Cleveland, 1999).

The mutant SOD1 enzyme has altered reactivity with certain substrates, (Noor et al., 2003), in addition to the major superoxide dismutase activity. The SOD1 enzyme catalyses the reduction of hydrogen peroxide (H_2O_2), therefore acting as a peroxidase. This leads to the formation of hydroxyl radicals that can also alter the neurofilament network. Motor neurones have high-energy requirements and thus contain many mitochondria that generate superoxide radicals (O_2^-) through normal metabolism. SOD1 is an anti-oxidant defence which catalyses conversion of superoxide free radical anion (O_2^-) to hydrogen peroxide (H_2O_2), which is reduced to H_2O and O_2 by catalase. Mutations at SOD1 binding sites, alter the redox behaviour of the enzyme and destabilise the SOD1 ligand, leading to increased oxidative damage as hydrogen peroxide and its derivatives are toxic to the cell. (Yim et al., 1990).

This supports the hypothesis that the pathogenesis of SOD1 related FALS may be due to increased peroxidase activity of mutant SOD1 resulting in oxidative damage mainly to lipids of the cell membrane.

Mapping of the mutation sites predicted that these mutations destabilise the protein structure, leading to a less active enzyme i.e. "loss of function". This is however not supported by the fact that transgenic mice over expressing SOD1 gene developed disease similar to MND in humans, while those over-expressing normal SOD1 remained unaffected. This suggests that the mutant mice develop the disease independent of the level of SOD1 activity and suggests

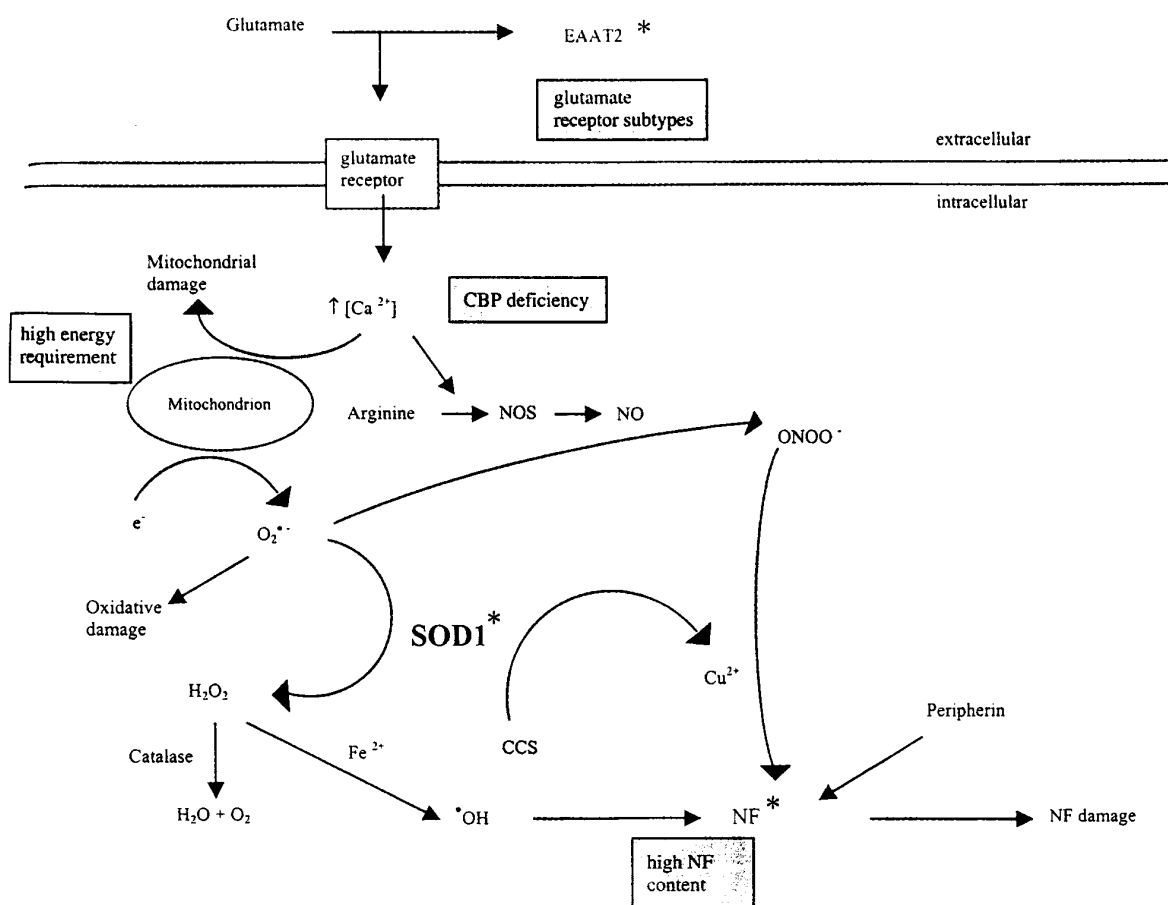

Figure 3. Pathways that have been implicated in motor neurone cell death in amyotrophic lateral sclerosis (Reproduced from Hand CK. Familial Amyotrophic Lateral Sclerosis. *Muscle Nerve* 2002; 25:137).

that the mutant protein itself is selectively toxic to motor neurones and that there is a “gain of toxic function” rather than a “loss of function”. (Gurney et al., 1994). Also, although most mutations in SOD1 gene cause decrease in steady state of cytosolic SOD1 activity, Gly37Arg and Asp90Ala, have no significant decrease in SOD1 activity. (Shaw et al., 1998).

As most SOD1 mutations destabilise SOD1 protein (except Asp90Ala), it is possible that the mutant protein, with altered conformation may become unstable and precipitate to form aggregates or inclusions in motor neurones. These aggregates may then disturb normal cell function and lead to cell death. They are easily formed when SOD1 protein stability is decreased because this protein exists in large amounts accounting for 0.5-1% of total cytosolic protein in neurones. Alterations in the length of the coding sequence, folding, solubility or degradation results in the formation of aggregates. (Yim et al., 1990). Structural changes of mutant SOD1 may distort the rim of the electrostatic guidance channel and allow the catalytic site to become exposed and shallow. Molecules that are normally excluded may gain access to the catalytic reactive site. This results in less buffering of copper and zinc, which then become neurotoxic. (Radunovic & Leigh, 1996).

The nitric oxide (NO) produced by nitric oxide synthase (NOS) reacts spontaneously with O_2^- to generate peroxynitrite (ONOO⁻), which nitrosylates proteins leading to damage. Excess NO may also cause an increase in O_2^- production by inhibition of mitochondrial electron flow, resulting in further generation of peroxynitrite. This facilitates nitrosylation of tyrosine residues of critical cytosolic proteins thus injuring cells. This reaction is copper dependent. The source of free copper may be mutant SOD1, which cannot accept the ion from the copper chaperone (CCS) protein. Mutant SOD1 possibly exhibit metal mediated cytotoxicities by disrupting the intracellular homeostasis of Cu and Zn, which are potential neurotoxins. (Gurney & Tomasselli, 1994).

The target proteins for nitrosylation include the neurofilament (NF) subunits, which may result in abnormal NF accumulation and subsequent disruption of the NF network and axonal transport, as there is a high neurofilament content in motor neurones. It has also been demonstrated that transgenes encoding mutant NF subunits can directly cause selective degeneration and death of motor neurones. (Cleveland, 1999). Conformational changes have been described in the mutations, Ala4Val, Gly37Arg and His6Arg that may affect the rim of the electrostatic guidance channel coded by exon 3. (Sjalander et al., 1995).

Glutamate is released from the presynaptic terminal activates the glutamate receptor on the postsynaptic cell membrane. It is then cleared from the synaptic cleft by specific glutamate transporters such as EAAT2. (Trotti et al., 1999). Astrocyte (glial cell) dysfunction may result in selective loss of EAAT2, interfering with the normal clearance of glutamate and allowing it to accumulate in the cell membrane and continue to activate the receptor. (Bruijin et al., 1997). Once activated, the glutamate receptor causes a calcium influx and a cascade of toxicity. The neurone does not have the capacity to buffer this efficiently due to a deficiency in calcium binding proteins (CBP's). This results in disturbances in mitochondrial metabolism and as a consequence, motor neurone cell death. (Beal, 1996).

To date, the only effective approved treatment for amyotrophic lateral sclerosis is Riluzole, (Cheah et al., 2010), which has a neuroprotective role, possibly due to pre-synaptic inhibition of glutamate release. (Doble, 1996). Treatment of human ALS patients or transgenic Cu, Zn superoxide dimutase 1 (SOD 1) mice, most commonly produce a modest but significant increase in survival. (Bensimon et al., 1994). It has also been shown to have a small beneficial effect on bulbar function, but not muscle strength. (Miller et al., 2007).

Apoptosis is characterised by a series of cellular changes leading to non-inflammatory cell death. Mitochondrial involvement in the apoptotic pathway also leads to the release of cytochrome c, an activator of the initiator caspase-9, which in turn activates caspase-3, which are executioners in the breakdown of essential cellular proteins. There is evidence that the mutant SOD1 transgene causes motor neurone death in mice through caspase-mediated programmed cell death. (Li et al., 2000). This may then be a target for inhibiting the apoptotic cascade, as it has been shown in a SOD1 transgenic mouse model that a small peptide caspase inhibitor (*zVAD-fmk*), prolonged survival after onset of disease by nearly 70%. (Kosti et al., 1997). It has also been reported that there are elevated levels of *bax* protein in MND spinal motor neurones, which promotes apoptosis. (Mu et al., 1996).

6. Methods

The Department of Molecular Medicine at Concord hospital had a large database of family members with a known family history of MND, who had blood samples collected for DNA, as part of a previous linkage study. From this database, family members were contacted by telephone by the department's genetic counsellor and informed about the study.

The regional committees for Ethics in Medical Research from Central Sydney Area Health Service, Royal North Shore Hospital and Prince Charles Hospital, approved this study.

All individuals participated without knowledge of their mutation status and on the understanding that this would not be revealed to them. Subjects were also aware that the results obtained from the study would not be available to them and that the information would only be used for research purposes. New consents were obtained from all individuals who participated in the study. The neurologist performing the MUNE studies also had no knowledge of their mutation status. The mutation status was only used in the final analysis of results. Subsequently, they were divided into "SOD1 negative family controls" and "asymptomatic SOD1 mutation carriers".

In addition, studies were also carried out on normal individuals, such as department technicians, spouses of SOD1 family members and individuals from the general population who attended MND support meeting and had an interest in helping to advance research into MND. This group was used as "population controls", to test the validity and reproducibility of the MUNE technique used.

Sporadic MND subjects were also initially studied once the MUNE technique had been validated to demonstrate that the MUNE technique used was able to detect a loss of motor neurones, when present. These were used as "positive controls".

6.1. Motor unit number estimation

Motor unit number estimation (MUNE) estimates the number of functioning lower motor neurones innervating a muscle or a group of muscles and is a measure of the primary pathologic process of motor neurone loss. The concept of motor unit number estimation (MUNE) originated in 1967. At the time there was no satisfactory method of assessing the extent of denervation in muscles during life. Analysis of the density of the electromyographic interference pattern during maximal effort was not quantitative, and required the full co-operation of the patient.

The principle of MUNE is that if one can measure the mean single motor unit amplitude (SMUP), it is possible to obtain an estimate of the total number of motor units in the muscle. The results achieved were comparable with estimates of alpha motor fibres obtained by counting axons in specimens of motor nerves. (McComas, 1971).

MUNE has been performed in a number of different ways, each with their advantages and limitations. (Stein & Yang, 1990). The choice of technique depends on the speed and simplicity of the technique, as well as its accuracy and reproducibility. Some methods sample a very small

proportion of the number of motor units innervating a muscle (typically 10-20). The coefficient of variation associated with different methods range from 10-45%. (McComas, 1991). If the variability is too large, then the technique cannot be used to follow motor unit loss reliably over time.

The way the average single motor unit potential (SMUP) size is obtained distinguishes the several techniques available. Most employ electrical stimulation of the motor nerve to determine the sizes of the SMUP, but a few use needle EMG.

Each method measures both the average size of the potentials generated by single motor units - single motor unit potentials (SMUP) and the size of the compound muscle action potential (CMAP) obtained with maximal stimulation of a motor nerve.

The motor unit number estimate is calculated by:

$$\text{MUNE} = \frac{\text{Maximum CMAP amplitude (or area)}}{\text{Average single motor unit potential (SMUP) amplitude or area.}}$$

Whereas the methods of measuring the average SMUP differ, they have common assumptions about the measurement of the supramaximal CMAP and the measurement of the average SMUP.

- i. Maximal stimulation of any peripheral motor nerve activates all the muscles innervated by that nerve distal to the point of stimulation. Therefore, measurements of the CMAP are the summation of activity from multiple muscles and the MUNE is more accurately an estimate of the number of motor units in a group of muscles rather than in a single muscle.

For example, the median CMAP recorded at abductor pollicis brevis (APB) is more correctly a "thenar MUNE", as it is a summation of the activity of APB, opponens pollicis, flexor pollicis brevis, and to a lesser extent, the lateral lumbricals.

Extensor digitorum brevis (EDB) on the other hand, is a muscle innervated by the deep peroneal nerve. The only source of interfering muscle action potential is from extensor hallucis longus, which can be reduced by correct position of the stimulating electrodes. The muscle belly is flat in profile, eliminating deeper motor units as a cause of small potentials. The recording electrode is placed transversely across the innervation zone, resulting in a simple biphasic negative-positive M wave.

- ii. The motor unit potentials used in the calculation of the average SMUP are representative of those generated by the total population of units. All methods, select a subset of the total population of motor units, measure their sizes and calculate an average SMUP for that subgroup.
- iii. Finally, there is a phenomenon caused "alternation". This refers to fluctuations in the CMAP amplitude of the same motor unit with similar stimulation intensities. The thresholds of the first few motor axons excited are not sufficiently separate from one another, so that when graded increases in the stimulus intensity occur, the motor axons excited often overlap and add more than one SMUP to the CMAP being

recorded. This can result in an underestimation of the mean SMUP size, as it may appear that there are 7 or 8 motor units when there are only 2 or 3 present, which in turn results in an over-estimation of the MUNE.

6.2. Statistical MUNE method

We used the statistical electrophysiological technique of motor unit number estimation (MUNE), (Daube, 1998), was used to estimate the number of motor units in thenar and extensor digitorum brevis muscles. The statistical method estimates the average size of SMUP's and the number of motor units in a group of muscles innervated by the nerve being stimulated, based on the normal variation of the submaximal CMAP evoked with constant stimuli. No attempt is made to identify individual motor unit potentials. The method relies on the known relation between the variance of multiple measures of step functions and the size of the individual steps when the steps have a Poisson distribution. S.D. Poisson was a French mathematician (1781-1840).

Poisson statistics are useful when the distribution arising for events occur randomly in time or when small particles are distributed randomly in space. They have been used to calculate the number of quanta released from a nerve terminal at the neuromuscular junction when the individual quanta are too small to be distinguished, as in myasthenia gravis. (Lomen-Hoerth & Slawnych, 2003).

In pure Poisson statistics, the size of a series of measurements is multiples of the size of a single component. In a Poisson distribution there is a discrete asymmetrical distribution in which responses are found at some levels and others where there are no responses (Figure 4). (McNeil, 1996).

A pure Poisson distribution has decreasing numbers at higher values. In Poisson distribution, the variance of these 30 measurements is equal to the size of the individual components making up each measurement. The variance can thus provide an estimate of the average size of the SMUP's.

The statistical method looks only at variance of the CMAP and does not require identification of individual components. It can be used when the sizes of SMUP's are too small to be isolated. The statistical method assumes that each motor unit has a similar size and that it is the same size each time it is activated.

Sequences of 30 submaximal stimuli are given. The inherent variability of the threshold of individual axons causes variations in the size of the CMAP. The average change in the submaximal CMAP amplitude caused by alternation (addition and subtraction of motor axons) is derived by Poisson statistics.

The occurrence of alternation with changing units that are activated does not modify the accuracy of the statistical method, because the method is a statistical measurement, a different result is found with each series of 30 stimuli. Therefore, multiple trials are needed to obtain the most accurate measurement. (Olney et al., 2000).

Experimental testing with trials of >300 stimuli has shown that repeated measurement of groups of 30 until the standard deviation of the repeated trials is <10% provides a close estimate of the number obtained with many more stimuli.⁸⁶ Estimates of the SMUP size and of the number of motor units are also most reliable if made at multiple different stimulus intensities to test axons with different thresholds.

MUNE is calculated with the number weighted statistical method, where the mean SMUP amplitude at each level is multiplied by the number of motor units estimated at each level.

The steps in statistical MUNE are as follows:

1. Recording surface electrodes are applied as for standard nerve conduction studies.
2. An initial scan of the CMAP is performed using a series of 30 submaximal stimuli at 1 Hz, increasing in equal increments to identify unusually large steps at which further information is required.
3. On the basis of the scan, three or four 10% stimulus ranges are identified, according to an internal algorithm. Usually, one range includes the smallest step and the other ranges where the steps are >15% (Figure 4).
4. At each intensity, groups of 30 responses are captured at a rate of 3Hz. Estimates are most reliable if 10 groups of 30 responses are recorded. To minimise patient discomfort, however, repetition is repeated until the standard error of the MUNE SMUP size is less than 10%.
5. Statistical MUNE estimates the average size of SMUP's and the number of motor units in a group of muscles innervated by the nerve being stimulated, based on the normal variation of the sub-maximal CMAP evoked with constant stimuli (Figure 5).

The statistical technique of estimating the size of the SMUP was performed using proprietary software on a Nicolet Viking IV electromyography machine. This technique uses direct stimulation of the motor nerve. The low frequency filter was set at 2 Hz and the high frequency filter at 5 kHz. The gain for extensor digitorum brevis was set at 2 mV/div and for abductor pollicis brevis studies at 5 mV/div. The sweep speed was 2 ms/div. This method had excellent test-retest reproducibility (+/-2.8%). The method was quick to use and well tolerated.

This technique has been greatly modified since its original description, but numerous studies have shown that MUNE can change systematically in ALS patients when used by experienced technicians, even though evaluator bias needs to be taken into account. (Shefner et al., 2004). The statistical MUNE method has also been shown to be unreliable in the presence of clinical weakness due to motor unit instability. (Shefner, 2009).

Our study however was performed on asymptomatic patients, without clinical weakness.

6.3. MUNE Technique

Motor unit numbers were estimated in abductor pollicis brevis (resulting in a thenar MUNE) and the extensor digitorum brevis (EDB) muscle. These muscles were used, as both are easily

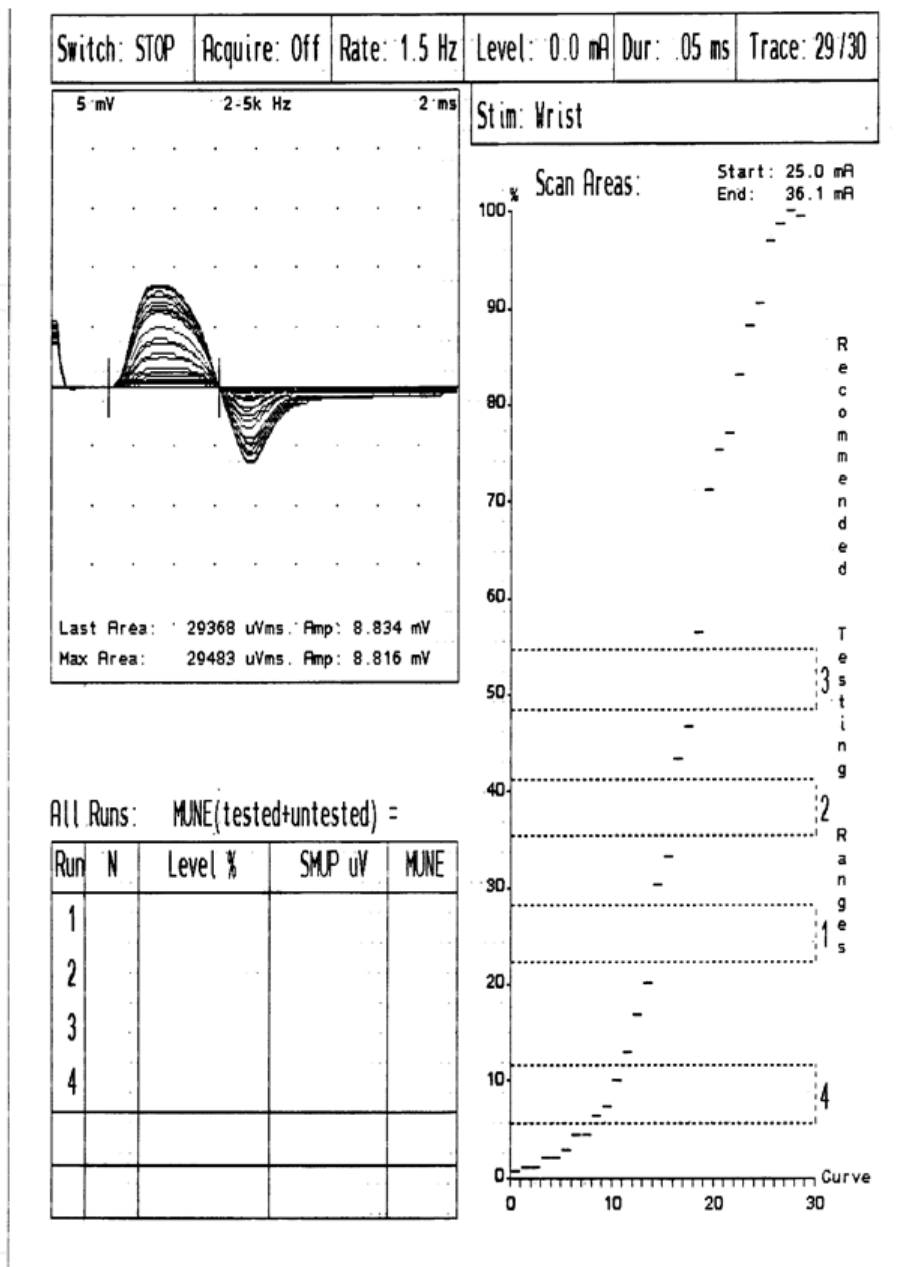

Figure 4. An initial scan of the CMAP (right) recorded from APB muscles in response to 30 sub-maximal stimuli (x-axis) with equal increments between threshold and maximum stimulation. On the basis of the scan, 10% stimulus ranges are identified, according to an internal algorithm. The CMAP increments are shown at the top left and the eventual table of results in the bottom left corner.

accessible distal muscles. The electrical activity can be recorded without interference, and in the case of EDB, the muscle belly is flat.

Self-adhesive surface recording electrodes (G1) were placed transversely across the innervation zone of each muscle, resulting in a simple biphasic negative-positive M wave, with G2 placed over a bony prominence. The deep peroneal nerve was stimulated just above the ankle and the median nerve at the wrist with a surface stimulator. This was performed by strapping

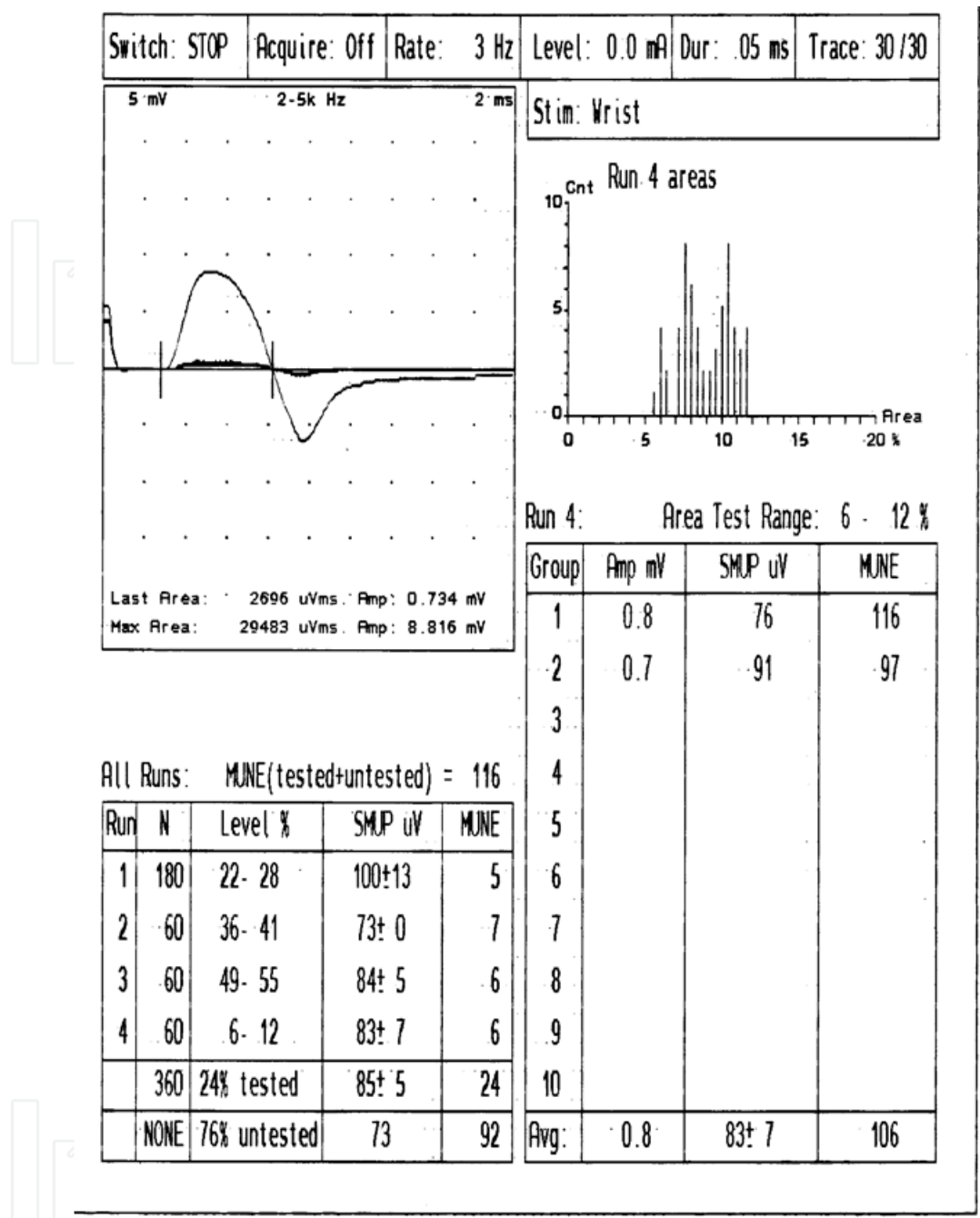

Figure 5. At each intensity level (runs 1-4), groups of 30 responses are captured at a rate of 3Hz. The CMAP amplitudes are shown at the top left, with the histogram of results at the top right. The thenar MUNE results from repeated trials are shown in the bottom left table.

the stimulating electrode onto the surface of the skin, at the point where the threshold of the nerve to electrical stimulation was at its' lowest. A hand-held stimulator was not used, as reproducibility is enhanced when the stimulating electrodes are fixed to the surface of the skin.

Initially, bilateral thenar and EDB MUNE's were obtained from all subjects. After the reproducibility phase of the study, generally only right-sided studies were performed. Once a

reduction in MUNE was identified, bilateral studies were once again performed on selected subjects. The protocol was also modified depending on the subjects' tolerance to the procedure.

Median nerve stimulation at the wrist for thenar MUNE was generally well tolerated by most subjects, as the stimulation intensity required to obtain an adequate response was generally less than 20mA with duration of 0.05-0.1ms.

Peroneal nerve stimulation required for EDB MUNE resulted in slightly more discomfort, as the nerve is located further away from the surface of the skin. The stimulus intensity required, in some cases was up to 50-80mA with duration of between 0.1-0.3ms. Some subjects indicated that they were unwilling to continue to participate in the study due to the discomfort caused by performing EDB MUNE. In these subjects, only thenar MUNE's were performed.

To assess the test-retest reproducibility of the technique, SOD1 family members and population controls were followed over a 1-year period, with thenar and EDB MUNE tests repeated every 3 to 6 months. The difference between MUNE results from the first and second study, and if possible, first and third studies were divided by the MUNE of the first study, and expressed as a percentage change. The results were analysed using Pearson and Spearman correlation coefficients.

All results were entered into a database and analysed using a standard statistical software package (SPSS 9.05 for Windows). For the initial part of the study, the MUNE results from asymptomatic SOD1 mutation carriers were grouped together. Although different mutations in SOD1 have different effects on the progression of the disease once symptoms occur, these different mutations do not influence on the age of onset of symptoms.⁶⁷

Motor unit estimates in carriers were compared to age and sex matched family controls without the SOD1 mutation, and sporadic (non-SOD1) MND patients. To determine whether groups had different numbers of motor units, an unpaired t-test was used. Although there were some outlying results, the distributions were not sufficiently skewed to contradict the use of the t-test. Statistical significance was accepted at a p-value of <0.05.

The group of asymptomatic SOD1 mutation carriers were followed over the next 2 to 5 years, depending on the volunteers' motivation, both clinically and by MUNE. Results were compared to their initial baseline MUNE and the date of the study when this reduction was first detected, was used as the date when motor neurone loss commenced.

6.4. Maximal voluntary isometric contraction testing

It has been suggested that the traditional neurological examination is inadequate for documenting motor performance impairment with reliability. (Hanten et al., 1999). Generally, manual motor testing used in a standard neurological motor examination does not allow objective documentation of change in performance, as it may be influenced by the patient's history and progress. Major changes are apparent, but subtle changes are difficult to determine with accuracy.

There are a number of methods that have been developed to quantify maximal voluntary isometric contraction (MVIC). It has been proposed that this is a clinically useful, reliable,

reproducible, time efficient and quantitative measure for monitoring disease progression in MND. (Hoagland et al., 1997). This would be surprising, given that in a slowly progressive denervating process, patients with substantial chronic denervation could maintain normal muscle twitch tension until loss of about 70-80% of motor units occurs. (McComas, 1971).

The methods used to quantify maximal voluntary isometric contraction have included an electronic strain-gauge tensiometer and a hand-held Jamar hydraulic dynamometer. In this study, maximum bilateral isometric grip strength was obtained using the Jamar hydraulic dynamometer to determine whether this correlated with the number of functional motor neurones in the thenar group of muscles, as measured by MUNE. Standardised (middle handle) positioning and instructions were given to all subjects. Handgrip force was measured with subjects in the sitting position and with the arm flexed at 90 degrees. Two trials were performed on each hand, and the best result used for analysis. This method was used as previous studies of grip strength reliability showed that there was no significant difference in reliability between one attempt, the mean score of two or three attempts, or the highest score of three attempts. (Hamilton et al., 1994).

Clinical neurological examination was performed, with power of thumb abduction, finger flexion and finger abduction measured according to the Medical Research Council (MRC) grading system and compared to thenar (APB) MUNE.

Felice showed that in twenty one MND patients, changes in thenar MUNE was the most sensitive outcome measure for following disease progression, when compared to other quantitative tests, such as CMAP, isometric grip strength, forced vital capacity and Medical Research Council manual muscle testing. (Felice, 1997).

7. Results

7.1. Demographics

A total of eighty-eight (88) subjects (45 males and 43 females) gave informed consent. The subjects were divided into four test groups.

1. 24 population controls;
2. 32 SOD1 negative (normal) family controls;
3. 20 asymptomatic (pre-clinical) SOD1 mutation carriers (test group),
 - a. 5 subjects with point mutation in exon 4, codon 100, GAA to GGA, Glu to Gly) – glu100gly;
 - b. 5 subjects with point mutation in exon 4, codon 113, ATT to ACT, Ile to Thr) – ile113thr;
 - c. 5 subjects with point mutation in exon 5; codon 148, GTA to GGA, Val to Gly) – val148gly;
 - d. 5 subjects with point mutation in exon 5, codon 148, GTA to GGA, Val to Ile) val148ile.

	Thenar (APB) muscle	
	Cases	MUNE (Range)
Population Controls	24	148 (115-254)
SOD1 Negative Family Controls	32	138 (106-198)
SOD1 Mutation Carriers	20	144 (109-199)
Sporadic MND patients	12	45 (5-84)

Table 1. Thenar (APB) motor unit number estimates (MUNE number represents mean MUNE).

4. 12 sporadic symptomatic MND patients (positive controls).

There was no statistically significant difference in age distribution between these groups, with a range of 16 to 73 years of age.

7.2. Motor units in asymptomatic FALS (SOD1) carriers

For the initial part of the study, the baseline MUNE results were grouped together and the means of the groups were compared. The initial aim of the study was to determine if MND was due to a slow gradual attrition of motor neurones over time. If this were the case, the group of asymptomatic SOD1 mutation carriers, would be expected to have a reduced number of motor units, indicating the presence of pre-clinical motor neurone loss. Motor unit estimates in the group of asymptomatic SOD1 mutation carriers were compared to age and sex matched family controls without the SOD1 mutation, and sporadic (non-SOD1) MND patients. To determine whether groups had different numbers of motor units, an unpaired t-test was used. Statistical significance was accepted at a p-value of <0.05.

The numbers of motor units in the groups of population controls, SOD1 negative family controls and asymptomatic SOD1 mutation carriers were similar. In population controls the mean thenar MUNE was 148 with a range of 115 - 254, in SOD1 negative family controls was 138 with a range of 106 - 198 and in asymptomatic SOD1 mutation carriers, 144 with a range of 109 - 199. There was no detectable difference in the mean number of thenar motor units in the group of asymptomatic SOD1 mutation carriers compared to the group of SOD1 negative family controls (thenar $p > 0.46$), or population controls (thenar $p > 0.70$) (Table 1 and Figure 6).

In population controls the mean EDB MUNE was 138 with a range of 119 - 169, in SOD1 negative family controls was 134 with a range of 107 - 180 and in asymptomatic SOD1 mutation carriers, 136 with a range of 111 - 187.

Once again, there was no detectable difference in the mean number of EDB motor units in the group of asymptomatic SOD1 mutation carriers compared to the group of SOD1 negative family controls (EDB $p > 0.95$), or population controls (EDB $p > 0.50$) (Table 2 and Figure 7).

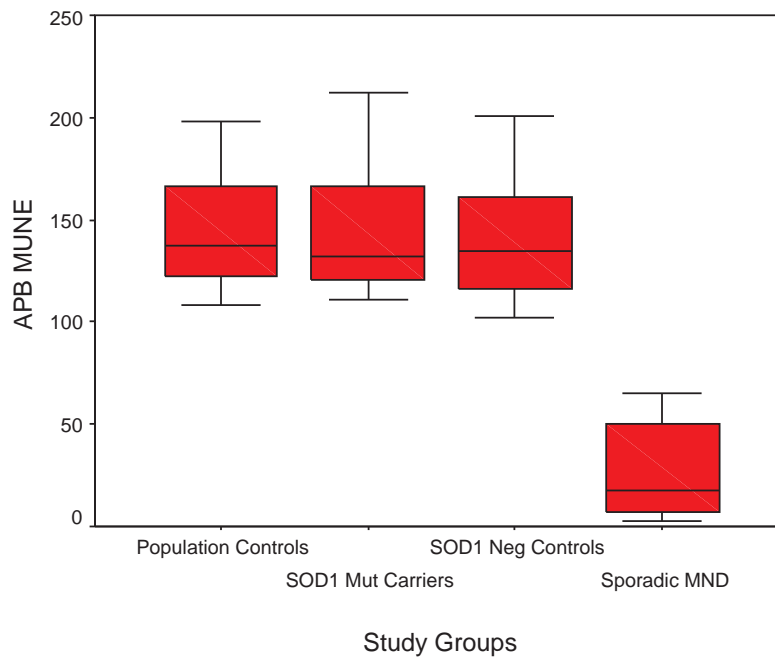

Figure 6. Baseline thenar (APB) MUNE subdivided into study groups (The lower boundary of the box is the 25th percentile, and the upper border is the 75th percentile of MUNE. The horizontal line inside the box represents the median MUNE. The whiskers represent the largest and smallest observed values, i.e. the range). Data is shown in Table 1.

	Extensor Digitorum Brevis	
	Cases	MUNE (Range)
Population Controls	13	138 (119-169)
SOD1 Negative Family Controls	30	134 (107-180)
SOD1 Mutation Carriers	14	136 (111-187)
Sporadic MND patients	9	70 (8-82)

Table 2. EDB motor unit number estimates (MUNE number represents mean MUNE).

Symptomatic sporadic MND subjects showed a definite loss of motor units with fewer motor units compared to all other groups ($p < 0.0001$) with a mean thenar MUNE of 45 with a range of 5 - 84 and a mean EDB MUNE of 70 with a range of 8 - 82 (Tables 1 and 2).

There was no cross over between thenar and EDB MUNE results in symptomatic and asymptomatic subjects.

7.3. Reproducibility of MUNE technique

To assess the test-retest reproducibility of the technique, 69 of the 88 SOD1 family members and population controls were followed over a 1-year period, with thenar and extensor

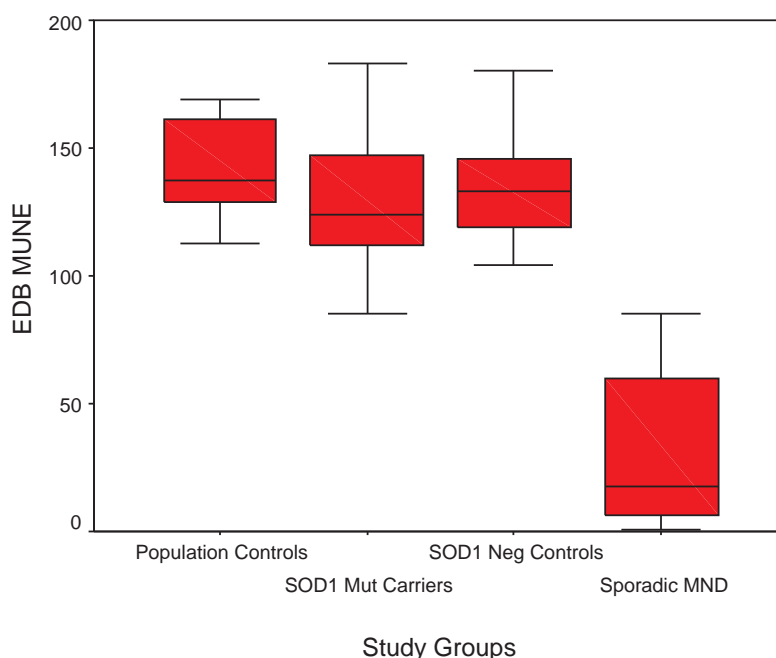

Figure 7. Baseline EDB MUNE subdivided into study groups (The lower boundary of the box is the 25th percentile, and the upper border is the 75th percentile of MUNE. The horizontal line inside the box represents the median MUNE. The whiskers represent the largest and smallest observed values, i.e. the range). Data is shown in Table 2.

digitorum brevis (EDB) MUNE tests repeated every 3-6 months, depending on patient availability. The difference between MUNE results from the first and second study, and if possible, first and third studies were divided by the MUNE of the first study, and expressed as a percentage change. The results were analysed using Pearson and Spearman correlation coefficients.

The test-retest correlation of thenar MUNE in asymptomatic subjects was high with a Pearson correlation coefficient of 0.93. The mean difference between MUNE results on separate occasions on the same individual was +/- 3.6%, with a range of 0-11.7% (Table 3).

	Number of Cases	Mean MUNE
Thenar 1	88	145.7
Thenar 2	69	140.1
Thenar 3	33	140.0
Thenar Change	Range (0 - 11.7%)	3.6%

Table 3. Reproducibility of mean thenar (APB) motor unit number estimates in asymptomatic subjects on separate reviews over a one-year period.

For EDB MUNE, the Pearson correlation coefficient was also high, 0.88, with a mean difference between MUNE results on separate occasions on the same individual of +/- 4.6%, with a range

of 0-15.7%. The test-retest correlation was high with a Pearson correlation coefficient of 0.91, when groups were broken down into the different study groups.

7.4. Maximal voluntary isometric contraction

Maximal voluntary isometric contraction (MVIC), using the Jamar hand dynamometer was used to measure isometric grip strength to determine whether this correlated with the number of functional motor neurones in the thenar group of muscles as measured by MUNE. Isometric grip strength tests, thenar MUNE and MRC power were performed on 69 asymptomatic subjects twice within a 3-6 month period to assess the test-retest reproducibility of this technique. Pearson correlation coefficients between study 1 and study 2 of right hand grip strength was 0.941, left hand grip strength 0.910 and thenar MUNE results 0.937. These results indicate that the reproducibility of these techniques was high.

Right hand grip strength correlated with left hand grip strength, with Pearson correlation coefficients of 0.959 and Spearman correlation coefficients of 0.956. Two-way analyses of variance showed a no significant difference between the right and left hands (Figure 8). There was no correlation between right grip strength and right thenar motor unit number, with Pearson correlation coefficients of 0.483 and Spearman correlation coefficient of 0.34 (Figure 9).

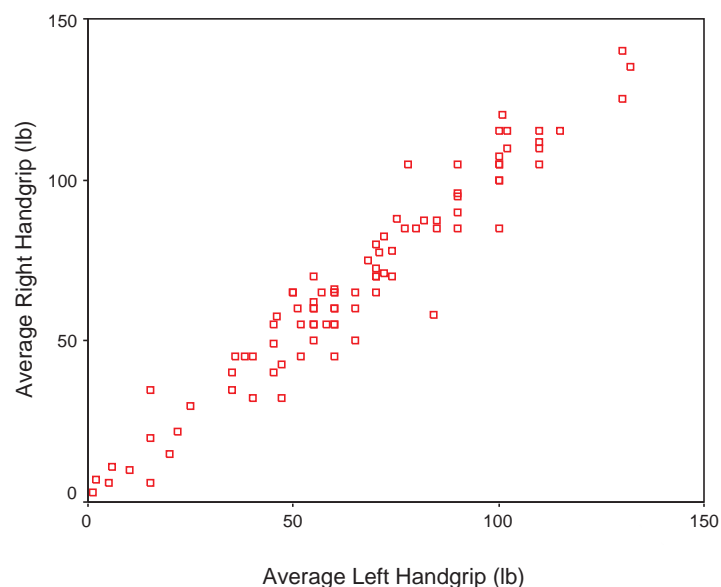

Figure 8. Graph showing the correlation between right and left handgrip

7.5. Detection of pre-symptomatic motor neurone loss in SOD1 mutation carriers

The MUNE results, after validating their reproducibility, were used as a baseline to follow the number of motor units over time in individual pre-symptomatic SOD1 mutation carriers over the next 2-5 years, to determine whether pattern of motor neurone loss is either a slow attrition of motor neurones over time or whether normal numbers of motor neurones are maintained

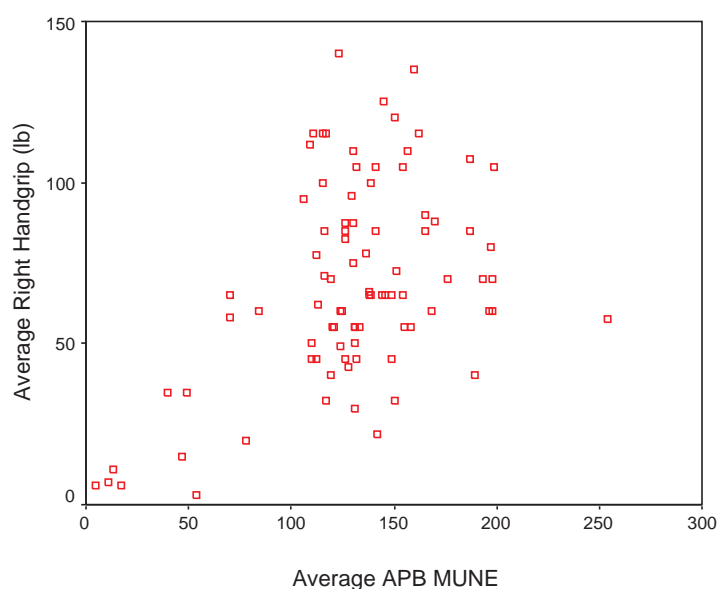

Figure 9. Scatter graph showing the lack of correlation between right handgrip and right thenar (APB) MUNE

until sudden, rapid multi-focal cell death of motor neurones occurs, corresponding with the development of symptoms.

During the course of the study, 5 of the SOD1 mutation carriers developed leg weakness. A significant fall in motor unit number was detected in these 5 SOD1 mutation carriers, were there was a detectable reduction of motor units, 4-10 months prior to the onset of weakness and the diagnosis of familial ALS being made. There was no detectable loss of motor units in the other 15 SOD1 mutation carriers or in the group of SOD1 mutation negative relatives, during the study period.

In individual cases, there was:

51% loss of motor units, 4 months prior to onset of weakness in Case 1

37% loss of motor units, 10 months prior to onset of weakness in Case 2

28% loss of motor units, 6 months prior to onset of weakness in Case 3

46% loss of motor units, 6 months prior to onset of weakness in Case 4

68% loss of motor units, 8 months prior to onset of weakness in Case 5

There was further motor unit loss as weakness progressed, at which point the diagnosis of MND was confirmed.

7.5.1. Case study 1

A 43-year-old sister of case 1. She had the same strong family history of ALS, with a point mutation in SOD1 gene at val148gly. Her pedigree is shown in Figure 10. She was asymptomatic at the time of recruitment with a normal neurological examination, and no evidence of

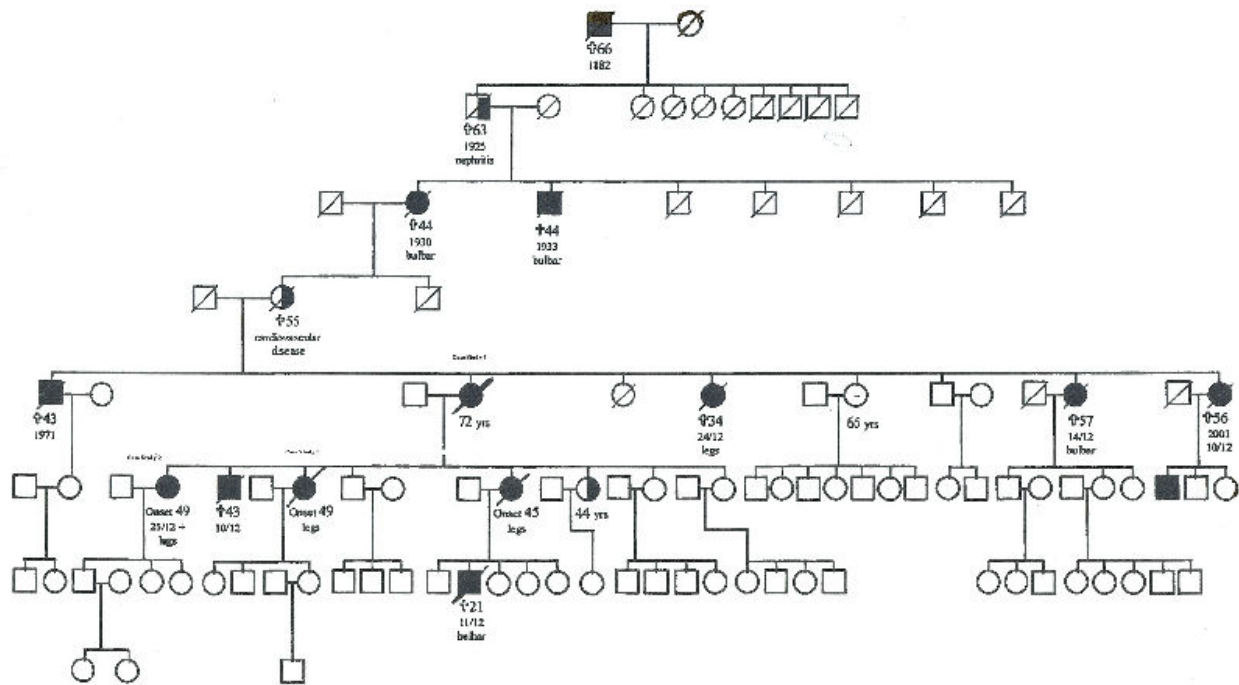

Figure 10. Pedigree of cases 1, 2 and 3

wasting, weakness or fasciculation. Her right and left thenar MUNE's remained stable for the first 2½ years of the study at around 115-120 motor units. Progress MUNE results are shown in Table 4 and Figures 11.

Over the next 6 months, there was a reduction in her right thenar MUNE to 96 (20%) and her left thenar MUNE to 89 (19%), with no detectable weakness. Her right EDB MUNE also dropped from 111 to 92 (17%), but she only had detectable weakness 10 months later of MRC grade 4+/5 in right dorsiflexors, at which time her right EDB MUNE had dropped further to 71 motor units (35%). The left EDB MUNE also dropped from a baseline of 112 (2 years previously) to 89 (20%), but with no detectable weakness.

An independent neurologist performed needle EMG examination, which showed high amplitude motor units with reduced recruitment in vastus medialis, tibialis anterior and extensor carpi radialis longus, bilaterally but no fibrillation potentials were seen. It was felt that these changes were not enough to make the diagnosis of ALS.

In view of her strong family history, a presumed diagnosis of familial ALS was made and she was commenced on Riluzole in February 2002.

Over the next 3 years, her EDB MUNE results have stabilised. Her weakness has not progressed significantly. In February 2004, she still had MRC grade 4+/5 power of her right dorsiflexors and no symptomatically apparent weakness in her left dorsiflexors or upper limbs.

Months pre and post weakness 1st detected	-42	-40	-37	-29	-20	-10	0	+11	+21	+27
Date of study	Oct-98	Dec-98	Mar-99	Nov-99	Jul-00	Jan-01	Nov-01	Oct-02	Aug-03	Feb-04
R Handgrip	60	60	65	65	60	70	65	65	65	65
R Thenar MUNE	111	111	117	119	120	114	96	97	86	85
L Handgrip	60	55	60	65	63	65	65	60	60	60
L Thenar MUNE	117				119	111	89	86	79	81
R EDB power	5/5	5/5	5/5	5/5	5/5	5/5	4+/5	4+/5	4+/5	4+/5
R EDB MUNE	104	111	119	108	104	92	71	75	75	65
L EDB power	5/5	5/5	5/5	5/5	5/5	5/5	5/5	5/5	5/5	5/5
L EDB MUNE	112						89	80	80	81

Table 4. Case 1 progressive handgrip, dorsiflexion power and thenar and EDB MUNE results

7.5.2. Case study 2

A 57-year-old man with a strong family history of ALS dating back 3 generations, had a point mutation in exon 4, codon 100, GAA to GGA, Glu to Gly) – glu100gly. He was initially recruited into the study in 1998, but as he was unable to tolerate the EDB MUNE test, he elected not to continue to participate in the study. He represented 11 years later with a 3 month history of lower limb weakness, which he noticed only when he walked long distances and up stairs. He had also been experiencing lower limb cramps and muscle fasciculations for years.

On examination, he had no evidence of wasting, but there were muscle fasciculations seen in his right quadriceps. His tone was normal in the upper and lower limbs and he had MRC grade 5/5 power in all muscle groups, proximally and distally. His sensory examination was normal to touch, vibration and position. His gait was normal.

Nerve conduction studies performed by independent neurologist were normal, with no evidence of a large fibre peripheral neuropathy and normal CMAP amplitudes. Needle EMG studies was also normal, with no evidence of active or chronic denervation in bilateral distal and proximal muscles sampled. Using the same MUNE machine and computer algorithm, as 1998, a reduction in his APB MUNE was detectable. Despite the “normal EMG” findings, a presumptive diagnosis of fALS was made. He was commenced on Riluzole therapy 50 mg twice a day. Within 3 months, he noticed an improvement in the symptoms and there was a detectable improvement in MUNE by 40-52%. He was able to walk up stairs easier, walk 100 metres without stopping and lower limb cramps and fasciculations disappeared. Unfortunately, due to poor tolerance, further studies have not been possible. MUNE results are shown in Table 5.

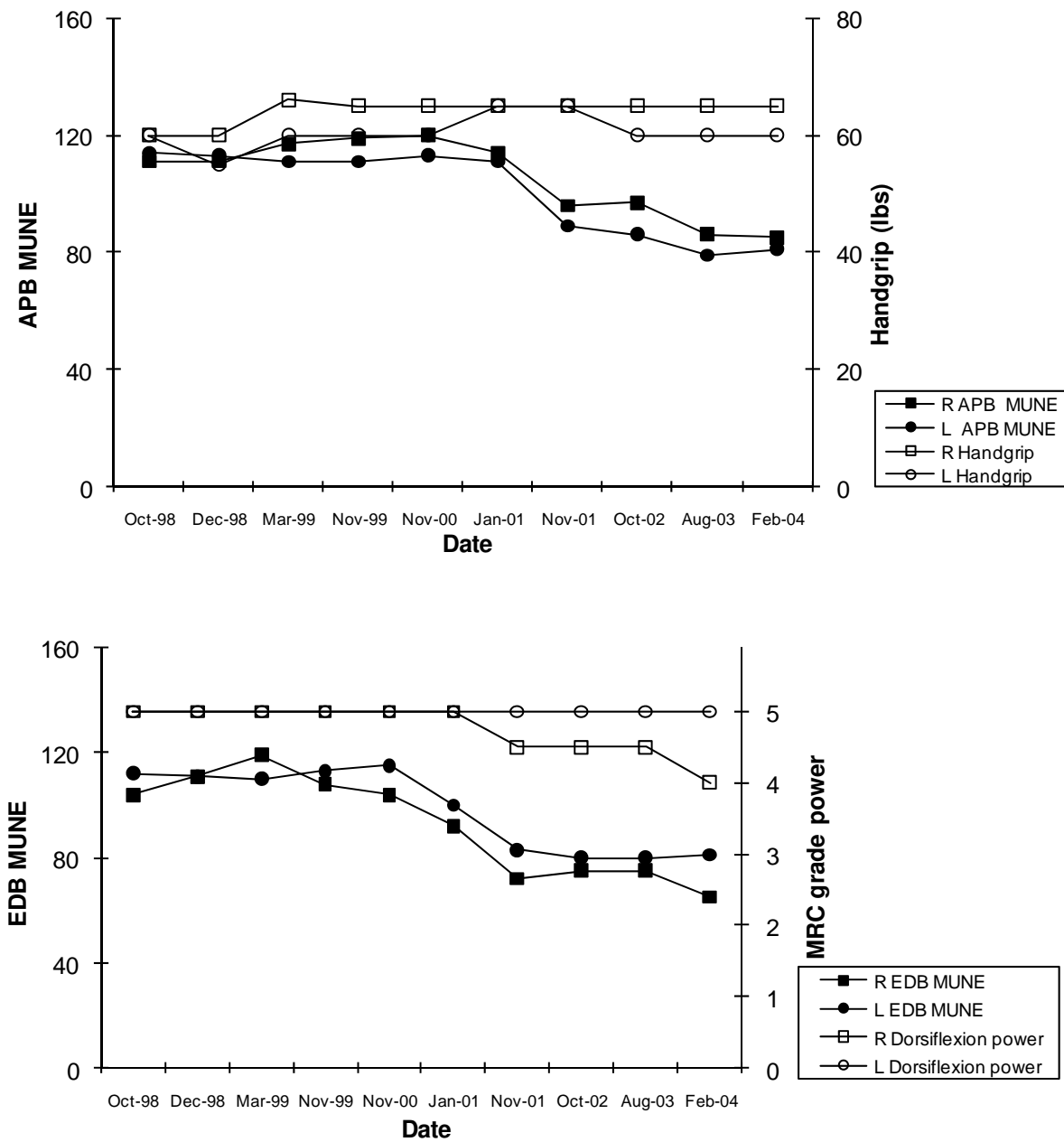

Figure 11. Progressive results of case 1 showing the change in APB and EDB motor unit estimates over time in relation to handgrip strength and power. There is a reduction of APB and EDB MUNE even though strength has remained stable.

7.5.3. Case study 3

A 43-year old lady with an extensive family history of ALS dating back 4 generations, had a point mutation in exon 5, codon 148, GTA to GGA, Val to Gly) – val148gly. She presented with generalised muscle fasciculations, but no weakness or cramps.

On examination, she had no wasting or fasciculations. Her tone, power, reflexes and sensation in the upper and lower limbs were normal. Her gait was steady and she was able to walk on her heels and toes. Tandem walking was normal and Romberg’s sign was negative.

	May-98	July-09	Nov-09
Months	Baseline	13 months	4 months
Riluzole commenced			
R Handgrip	105	95	80
L Handgrip	110	105	90
R APB MUNE	198	86 (56% decrease)	125 (45% increase)
L APB MUNE		88	124
R ADM MUNE	110	95	
L ADM MUNE		85	
R EDB MUNE	Not tolerated	59	90 (52% increase)
L EDB MUNE		67	94 (40% increase)
Needle EMG	Normal	Normal	

Table 5. showing progressive handgrip, dorsiflexion power, thenar and EDB MUNE and needle EMG results of Case 2 (Normal EMG refers to the absence of fasciculation and fibrillation potentials, normal motor unit potentials and normal recruitment)

Nerve conduction studies performed by independent neurologist were normal, with no evidence of a large fibre peripheral neuropathy. Needle EMG studies was also normal, with no evidence of active or chronic denervation in bilateral distal and proximal muscles sampled.

On her initial MUNE testing, results were within normal values, but 5 months later, there was a detectable reduction in her MUNE's from baseline of between 13-23%. As the MUNE change was greater than our re-test reliability limits (<5%), a presumptive diagnosis fALS was made and commenced on Riluzole therapy. This resulted in an improvement in her fasciculations and MUNE's over the next 6 months, 14-41%. Her MUNE results have remained stable over the next 12 months. Progress MUNE results are shown in Table 6.

7.5.4. Case study 4

A 47-year-old lady with a family history of dominantly inherited non-SOD 1 ALS, (father aged 68 and brother aged 45, both died of ALS). A point mutation in the SOD 1 gene has not been currently detected. She presented with a 1-year history of generalised muscle fasciculations and occasional lower limb cramps. She had generalised tiredness and muscular aches and pains, but no weakness, numbness or paraesthesia. Her gait was steady. As a result of her symptoms, she ceased work in March 2004.

	Sept-08	Feb-09	Aug-09	Aug-10
Months	Baseline	5 months	6 months	12 months
Riluzole commenced				
R Handgrip	65	70	68	65
L Handgrip	62	70	62	65
R APB MUNE	126	109 (13% decrease)	124 (14% increase)	131
L APB MUNE	136	105 (23% decrease)	123 (17% increase)	124
R EDB MUNE	107	97 (18% decrease)	134 (38% increase)	134
L EDB MUNE	104	90 (13% decrease)	127 (41% increase)	117
Needle EMG	Normal			

Table 6. showing progressive handgrip, dorsiflexion power, thenar and EDB MUNE and needle EMG results of Case 3 (Normal EMG refers to the absence of fasciculation and fibrillation potentials, normal motor unit potentials and normal recruitment)

On examination, she had no evidence of wasting, but there were generalised fasciculations, especially in the triceps and quadriceps regions. Her tone was normal in the upper and lower limbs. She had no clinical weakness with MRC grade 5/5 power in all muscle groups, proximally and distally. Her sensory examination was normal to touch, vibration and position. Her reflexes were all present and symmetrical. Her gait was normal, as she was able to walk on her heels and toes. She was able to perform tandem walking and Romberg's sign was negative.

Nerve conduction studies performed by independent neurologist were normal, with no evidence of a large fibre peripheral neuropathy. Needle EMG studies was also normal, with no evidence of active or chronic denervation in bilateral distal and proximal muscles sampled.

Initial EDB MUNE was reduced with normal APB MUNE's. Despite this, a clinical diagnosis on fALS was not made given her normal needle EMG study, and she was observed over the next 6 months. Over this time, she developed MRC grade 4/5 weakness of ankle dorsiflexion, bilaterally and her EDB MUNE dropped by 14-20%. Despite this reduction, compound muscle action potential amplitudes were maintained. Needle EMG studies were repeated and once again normal there was no spontaneous activity (fibrillation potentials) and motor unit recruitment was normal, despite the presence of weakness.

Given her family history, a presumptive diagnosis of non-SOD 1 fALS was made and commenced on Riluzole therapy. This resulted in an improvement in clinical symptoms of tiredness and fasciculations, allowing her to return to work. Her EDB MUNE improved by 34-60%, and increased further over the next year. Despite this, her treating neurologist considered this was a placebo effect and ceased Riluzole. Within 2 weeks, her generalised aches

and pains and fasciculations recurred. Her subsequent MUNE study was blinded, as the operator was unaware that Riluzole had been ceased and found that her EDB MUNE's had reduced once again. She then had a 3rd needle EMG study, which was once again normal. She also had a MRI scan of her brain and full spine that showed no significant abnormality. She was recommenced on Riluzole, which resulted in a slow and steady improvement in her MUNE, which she has been maintained. Progress MUNE results are shown in Table 7 and Figure 12.

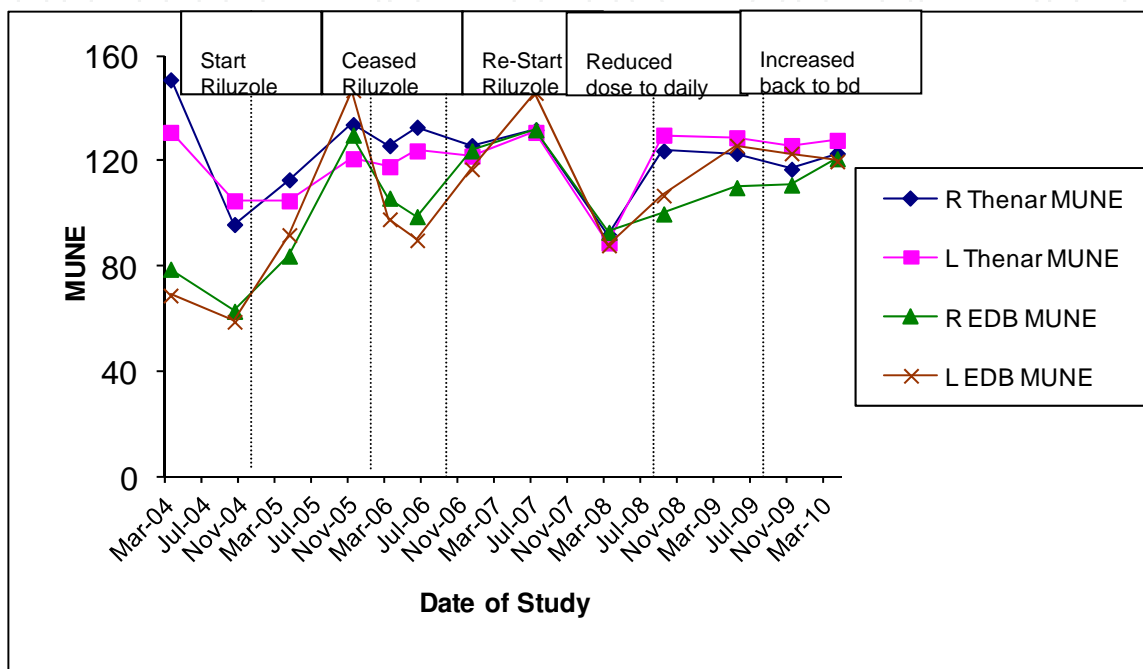

Figure 12. showing progressive thenar and EDB MUNE changes in relation to changes in the dose of Riluzole in Case 4

8. Conclusion

Motor neurone disease (MND) is a group of fatal, progressive neurodegenerative disorders, with an overall median survival is approximately 4.0 years from the onset of symptoms. By the time most patients with MND are aware of clinical weakness and seek review by their primary physician or neurologist, a significant proportion of motor units have already been lost. Early detection of motor neurone loss in clinically apparently unaffected muscles is therefore important to establish an early diagnosis of the condition.

Motor unit number estimates in the group of asymptomatic SOD1 mutation carriers were compared to age and sex matched family controls without the SOD1 mutation, and sporadic (non-SOD1) MND patients. There was no detectable difference in the number of thenar motor units in the group of asymptomatic SOD1 mutation carriers compared to the group of SOD1 negative family controls (thenar $p > 0.46$), or population controls (thenar $p > 0.70$). In addition,

	Mar-04	Oct-04	Apr-05	Nov-05	Mar-06	Jun-06	
Months	Baseline	7 months	6 months	7 months	4 months	3 months	
Riluzole changes		Riluzole Started		Riluzole Ceased		Riluzole Recommended Apr-06	
R Handgrip	50	20	50	40	40	35	
R Thenar MUNE	151	96 (36% decrease)	113	134	126	133	
L Handgrip	40	20	40	38	40	30	
L Thenar MUNE	131	105	105	121	118	124	
R EDB power	5/5	4/5	4/5	4/5	4/5	4/5	
R EDB MUNE	79	63 (20% decrease)	84 (33% increase)	130 (34% increase)	106	99 (23% decrease)	
L EDB power	5/5	4/5	4/5	4/5	4/5	4/5	
L EDB MUNE	69	59 (14% decrease)	92 (56% increase)	147 (60% increase)	98	90 (39% decrease)	
Needle EMG	Normal	Normal				Normal	
Date of study	Dec-06	Jul-07	Mar-08	Sept-08	May-09	Nov-09	Apr-10
Months	6 months	7 months	8 months	6 months	8 months	6 months	5 months
Riluzole changes			Riluzole Daily	Riluzole BD			
R Handgrip	55	45	25	34	40	40	40
R Thenar MUNE	126	132	92 (30% decrease)	124	123 (34% increase)	117	123
L Handgrip	50	45	25	35	45	30	32
L Thenar MUNE	122	131	89 (32% decrease)	130	129 (45% increase)	126	128
R EDB power	4/5	4/5	4/5	4+/5	4/5	4+/5	4+/5
R EDB MUNE	124 (25% increase)	132	93 (30% decrease)	100	110 (18% increase)	111	121
L EDB power	4/5	4/5	4/5	4+/5	4+/5	4+/5	4+/5
L EDB MUNE	117 (30% increase)	146	88 (40% decrease)	107	126 (43% increase)	123	120

Table 7. showing progressive handgrip, dorsiflexion power, thenar and EDB MUNE and needle EMG results of Case 4 (Normal EMG refers to the absence of fasciculation and fibrillation potentials, normal motor unit potentials and normal recruitment)

there was no detectable difference in the number of EBD motor units in the group of asymptomatic SOD1 mutation carriers compared to the group of SOD1 negative family controls (EDB $p>0.95$), or population controls (EDB $p>0.50$). Symptomatic sporadic MND subjects showed a definite loss of motor units with fewer motor units compared to all other groups ($p<0.001$). There was no overlap between MUNE results in symptomatic and asymptomatic subjects.

These results indicate that the group of asymptomatic carriers of the SOD1 mutation have no significant difference in the number of motor neurones, when compared to age and sex matched controls. All carriers had a full complement of motor neurones during the asymptomatic phase, indicating that mutation carriers have normal survival of motor neurones and that symptomatic MND is not the end result of a slow attrition of motor neurones. This implies that gradual pre-symptomatic loss of motor neurones does not occur in asymptomatic SOD1 mutation carriers. This supports the observation that sudden, catastrophic loss of motor neurones occurs immediately prior to the onset of symptoms and the development of the disease, rather than a gradual attrition of motor neurones over time. These results suggest that there may be a biological trigger initiating rapid cell loss, just prior to the onset of symptoms. This observation is an important contribution to the current understanding of the pathogenesis of MND. (Aggarwal & Nicholson, 2001).

The statistical MUNE technique was used for the study. This technique has been greatly modified since its original description, but numerous studies have shown that MUNE can change systematically in ALS patients when used by experienced technicians, even though evaluator bias needs to be taken into account. It has been suggested that the statistical MUNE is unreliable in the presence of clinical weakness due to motor unit instability. (Shefner, 2009). The difference is that our study was performed on asymptomatic patients, without clinical weakness.

MUNE has been performed in a number of different ways over the years, each with their advantages and limitations. The choice of technique depends largely on the speed and simplicity of the technique, as well as its accuracy and reproducibility. The way the average single motor unit potential (SMUP) size is obtained distinguishes the several techniques. Most employ electrical stimulation of the motor nerve to determine the sizes of the SMUP, but a few use needle EMG. The statistical MUNE technique was used for the study. (Daube, 1995). This technique has been compared to the multiple point stimulation method and found to be more reproducible (7% vs. 12%) and faster to administer. (Lomen-Hoeth & Olney, 2000). The technique has been greatly modified since its original description, (Shefner et al, 2004), but numerous studies have shown that MUNE can be used to monitor change in ALS patients when used by experienced technicians, even though evaluator bias needs to be taken into account. (Shefner et al., 2004).

There have been studies performed indicating that the statistical MUNE is unreliable in the presence of clinical weakness due to motor unit instability in ALS. (Shefner et al., 2011). In our previous study, we showed that there was no detectable difference in the number of motor units in 19 SOD 1 mutation carriers as a group, compared to their 34 SOD 1 negative family controls (APB $p>0.46$ and EDB $p>0.95$), or 23 population controls (APB, $p>0.70$ and EDB, $p>0.50$). (Aggarwal & Nicholson, 2001). It also showed that MUNE may be used as a reliable

method of pre-symptomatic detection of motor unit loss in SOD1 mutation carriers. Following 69 SOD1 family members and population controls over a 1-year period, with thenar and EDB MUNE tests repeated every 3 to 6 months, assessed the test-retest reproducibility of the technique. The mean difference between thenar MUNE results on separate occasions in asymptomatic subjects was $\pm 3.6\%$, with a range of 0-11.7%, and $\pm 4.6\%$, with a range of 0-15.7% in EDB MUNE. Our test-retest correlation was high, with Pearson correlation coefficients of 0.93 for APB MUNE and 0.78 for EDB MUNE. (Aggarwal, 2009). This indicates that there is reproducibility of our statistical MUNE technique, despite recent revisions and reservations. The results can be used as a baseline for progressive MUNE studies and any change in MUNE of greater than 5% should not be considered as a variation in measurement. This is contrary to a recent report indicating that the statistical MUNE cannot be used to detect mild to moderate motor unit loss. (Blok et al., 2010).

During the course of the study, a significant fall in motor unit number was detected in 5 of the SOD1 mutation carriers, several months before the onset of weakness and the diagnosis of motor neurone disease (MND) being made. There was no detectable loss of motor units in the other 15 SOD1 mutation carriers or in the group of SOD1 mutation negative relatives. From the study, a threshold MUNE of less than 100 was considered to imply that symptoms were imminent.

In individual cases, there was a reduction of 68% 8 months prior, 51% 4 months prior, 46% 6 months prior, 35% 10 months prior and 28% 6 months prior to the onset of weakness. Further motor unit loss occurred as weakness progressed and the diagnosis of MND being made.

We followed 3 subjects with a family history of ALS, 2 of which had a documented SOD 1 point mutation, who were commenced on Riluzole therapy when loss of motor units were detected using motor unit number estimation (MUNE), before the onset of symptoms i.e. pre-symptomatic phase. A reduction in sequential MUNE was shown to improve with a therapeutic intervention, Riluzole. Currently, the only effective approved treatment for MND is Riluzole, which has a neuroprotective role, possibly due to pre-synaptic inhibition of glutamate release. Riluzole is an anti-glutamate agent that has been approved for the treatment of patients with amyotrophic lateral sclerosis in most countries. Treatment of human ALS patients or transgenic Cu, Zn superoxide dimutase 1 (SOD 1) mice, most commonly produce a modest but significant increase in survival. (Bensimon et al., 1994). There have been a least three large randomised trials involving hundreds of patients that have been unable to show that Riluzole is a disease altering agent nor does it have any restorative reports. (Miller et al., 2007).

Cases 1 and 2 are SOD 1 positive mutation carriers who developed non-specific symptoms of muscle fasciculations with no clinical weakness, but had reductions in MUNE on sequential testing. Needle EMG studies were "normal", with no evidence of active or chronic denervation in muscles sampled from bilateral distal and proximal muscles. Normal EMG was defined as the absence of fasciculation and fibrillation potentials, normal motor unit potentials and normal recruitment. A presumptive diagnosis of fALS was made, even though there are reports on incomplete penetrance. In case 3, one could argue that there is no clear evidence that she has fALS, even though she has a strong family history of ALS with an autosomal dominant pattern of inheritance. Her episodic weakness and fasciculations improved after

commencing Riluzole and recurred after discontinuing Riluzole. She also had an improvement in MUNE and subsequent decline in MUNE, which are temporally associated with the administration of Riluzole.

After commencing Riluzole, there was an improvement in symptoms and MUNE. It is therefore possible that if treatment is commenced prior to significant motor neurone loss, the progression of disease can be slowed down.

In case 3, MUNE dropped when treatment was ceased on two separate occasions and improved when treatment was recommenced, with the operator being unaware of the Riluzole dose changes.

In our series, we noted an improvement in symptoms, especially a decrease in muscle fasciculations and an increase in MUNE number after commencing Riluzole. We suggest that previous trials have been performed in the symptomatic phase of the disease when 70-80% of motor units have already been lost, rather than in the pre-symptomatic phase of the disease, when the therapeutic benefit might be possible. If "treatment" is commenced prior to significant motor neurone loss occurring, the progression of disease may be able to be slowed down. MUNE is believed to reduce because of remodelling of the motor units and in our study, the compound muscle action potential amplitudes were maintained despite a reduction in MUNE. This is because early in the disease, the rate of cell death is low. (Cheah et al., 2010). The increase in MUNE may be either due to reinnervation of the damaged muscles or repair of poorly functioning synapses, at the early stage of the disease, without resulting in a change in CMAP.

In one of the cases in the study, Riluzole was commenced once she developed mild weakness. At the time, there was a slight reduction in MUNE, but conventional needle EMG examination did not fulfil the criteria to make the diagnosis of MND. In view of her strong family history and positive genetic testing, a presumed diagnosis of MND was made. Since commencing Riluzole there has been no significant reduction in her EDB MUNE over the last 2 years, and her weakness of right dorsiflexors has only progressed marginally from MRC grade 4+/5 to 4/5 power. It is possible that since "treatment" was commenced prior to the loss of a significant number of motor neurones, this may have slowed down the progression of the disease in this individual case. Early in the course of ALS, the rate of cell death is low as the amount of neuronal damage caused by the mutation is small. As the amount of intracellular damage increases, a critical threshold is reached, which overwhelms cellular homeostasis, resulting in rapid apoptosis and cell death. The increase in MUNE numbers may be either due to reinnervation of the damaged muscle or repair of poorly functioning synapses, at the early stage of the disease, without resulting in a change in CMAP.

Maximum isometric grip strength was also obtained using the Jamar hydraulic dynamometer with standardised (middle handle) positioning and instructions. Maximum isometric grip strength did not reduce, even when MUNE dropped, once again supporting McComas' theory that patients can maintain normal muscle twitch tension until loss of about 70-80% of motor units, before collateral reinnervation was unable to provide functional compensation. (McComas et al., 1971). Maximum isometric grip strength using the Jamar hydraulic dynamometer also does not correlate with the number of functional motor neurones in the thenar group

of muscles as measured using the statistical method of MUNE, indicating that MUNE is a more sensitive test than MVIC for monitoring disease progression in MND. It has also been shown that MUNE is able to identify deterioration in functional motor units before handgrip maximal voluntary isometric contraction (MVIC).

This confirms McComas' observation that patients with substantial chronic denervation could maintain normal muscle twitch tension until loss of about 70-80% of motor units occurs. (McComas, 1971). This suggests that handgrip MVIC is not as sensitive as thenar MUNE for monitoring disease progression, as it is unable to detect early motor neurone loss due to the presence of compensatory mechanisms. The surviving motor neurones enlarge their territories, through collateral sprouting (reinnervation) until late in the disease, when collateral reinnervation is no longer able to provide full functional compensation. Thenar MUNE however does examine all of the motor units that are involved in handgrip MVIC, as forearm flexors and ulnar-innervated muscles are involved in the generation of handgrip MVIC. It also confirms Felice's study which showed that in patients with MND, changes in thenar MUNE was the most sensitive outcome measure for following disease progression, when compared to other quantitative tests, such as CMAP, isometric grip strength, forced vital capacity and Medical Research Council manual muscle testing. (Felice, 1997).

This study also shows that there can be substantial loss in MUNE and still have an essentially normal EMG with minimal signs of acute denervation or motor unit potential remodelling, as one would expect that at a minimum, the muscles with transiently reduced MUNE numbers should have reduced recruitment during EMG studies.

As there is no corroboration with needle EMG in the pre-symptomatic stage of the disease in this study, this requires a paradigm shift in the traditional concept that needle EMG is the "gold" standard for the diagnosis of ALS. McComas showed that patients with substantial chronic denervation could maintain normal muscle twitch tension until loss of about 70-80% of motor units, before collateral reinnervation was unable to provide functional compensation (McComas, 1971). The function of motor neurons remains normal because the remaining motor units incorporate more muscle fibres by collateral sprouting. This should result in larger motor unit potentials, firing at higher rates with fewer motor units active i.e. reduced recruitment. Traditional neurologists and neurophysiologists will find it hard to understand physiologically how there can be substantial loss in MUNE and still have normal EMG with no signs of acute denervation or motor unit potential remodelling.

As MUNE is a measure of the primary pathologic process of motor neurone loss and can identify that the number of motor units are reduced, even in the presence of a non-diagnostic needle EMG. Needle electromyography may reveal evidence of chronic reinnervation, but provides little direct evidence to the extent of motor neurone and axonal loss. These cases clearly indicate that loss of motor neurones is detectable in the pre-symptomatic phase, which is detectable before significant needle EMG changes of pathology. In addition, compound muscle action potential amplitudes were maintained, despite a significant reduction in MUNE. Even though some may argue that a reduction in MUNE cannot be used to support the diagnosis of ALS, our previous study, suggests that once changes start to occur on conventional

EMG studies, the window of opportunity to influence the progression of this condition has been missed.

We would argue that previous trials have all be performed in the symptomatic phase of the disease when 70-80% of motor units have already been lost, rather than in the pre-symptomatic phase of the disease, when the therapeutic benefit might change, as "treatment" is commenced prior to significant motor neurone loss occurring and therefore, the progression of disease can be slowed down. MUNE numbers are believed to reduce because of remodelling of the motor unit and in our study, the compound muscle action potential amplitudes (CMAP) were retained as early in the course of the disease, the rate of cell death is low. The increase in MUNE numbers may be either due to reinnervation of the damaged muscle or repair of poorly functioning synapses, at the early stage of the disease, without resulting in a change in CMAP.

Therapies aimed at preserving motor neurones may be more feasible than trying to replace lost motor neurones. A number of treatment or preventative strategies have been suggested, such as measures to diminish SOD 1 aggregation or interactions to specifically reduce apoptosis in motor neurones. As motor neurone loss at this stage is rapid and precipitous, any potential treatment ideally should be given much earlier in SOD 1 mutation carriers. Larger randomised trials are necessary to study this question in a prospective, blinded fashion.

Even though MUNE evaluations were performed in an unblinded fashion, the statistical MUNE technique is performed with the assistance of an algorithm, which reduces operator bias. The main author has been using this technique for over 10 years and any operator bias is unintentional and unlikely to explain the marked differences in sequential MUNE.

Early in the course of ALS, the rate of cell death is low as the amount of neuronal damage caused by the mutation is small. As the amount of intracellular damage increases, a critical threshold is reached, which overwhelms cellular homeostasis, resulting in rapid apoptosis and cell death. (Clarke, 2001). The mutant neurones appear to function normally for decades, with weakness only occurring once apoptosis and cell death occurs due to a gradual accumulation of damage within the cell. (Kong & Xu, 1998).

As motor neurone loss once it occurs is rapid and precipitous, any potential treatment will need to be given early to SOD1 mutation carriers. Once the disease progresses, resulting in functional impairment and disability, restorative treatments to replace lost motor neurones becomes less feasible. To date there have been a number of drugs which have undergone clinical trials in MND, for which there is no evidence of benefit. These include creatinine, high dose vitamin E, Gabapentin and nerve growth factors such as brain derived neurotrophic factor and insulin-like growth factor-1. If effective treatment for MND were to be developed to arrest the process of degeneration, therapies aimed at preserving functional motor neurones would be more feasible. This requires the ability to be able to identify individuals at risk of developing the disease, which currently are SOD1 mutation carriers.

This longitudinal study showed that it was possible to detect loss of motor neurones in the pre-symptomatic stage of MND in humans. This study provided further evidence that considerable motor neurone loss occurred just before the onset of symptoms or weakness. (Aggarwal, 2009).

This study indicates that SOD1 mutation carriers have normal survival of motor neurones, with as carriers had a full complement of motor neurones during the asymptomatic phase. Significant pre-symptomatic loss of motor neurones did not occur in asymptomatic SOD1 mutation carriers. Sudden and widespread motor neurone death occurs at the time development of the symptomatic symptoms, rather than life-long motor neurone loss. Sudden, catastrophic and multifocal loss of motor neurons occurs immediately prior to the onset of symptoms and the development of MND. This suggests that there may be a biological trigger initiating rapid cell loss, just prior to the onset of symptoms, rather than life-long motor neurone loss. Also, if the trigger initiating motor neurone loss can be identified, it may be possible to prevent motor neurone loss in familial ALS and develop treatments for sporadic MND. The mutant SOD1 protein itself cannot be the trigger, as it is constantly expressed. There may however be a gradual accumulation of a toxic product, possibly SOD1, which has changed into a new toxic conformation or aggregate, resulting in neuronal damage. The possibility of an individual neuron undergoing apoptosis increases as damage accumulates. This cumulative damage may be due to oxidative stress, resulting in disruption of the cellular structure and function.

Neurofilament heavy polypeptide (NF-H) is an abundant stable cytoplasmic protein located in neuronal cells in large axons and may be used as a cell type marker. Abnormal accumulation of NF-H in motor neurones is associated with ALS, but it is unclear to what extent these contribute to human disease. Analysis of blood serum markers looking for increased levels of NF-H was not performed in this study, but would be interesting to be done in the future to the compare levels of NF-H in the carriers.

The results of this study indicate that the risk of cell death probably remains constant throughout life of the neurone and that cell death occurs randomly in time and is independent of that of any other neurone. This suggests a "one-hit" biochemical phenomenon in which the mutation imposes an abnormal mutant steady state on the neurone and a single catastrophic event randomly initiates cell death and apoptosis. Early in the course of MND, the rate of cell death is low as the amount of neuronal damage caused by the mutation is small. The delay in clinical onset was thought to reflect the gradual accumulation of damage within the neurones, as a result of the mutation, which ultimately overwhelms cellular homeostasis leading to cell death. The living mutant neurons function very well for years or decades but the probability that an individual neurone undergoes apoptosis increases as damage accumulates within it. A mutant neurone in an older patient will have accumulated a greater amount of damage and will therefore be more likely to die than in a younger patient. Consequently, early in the course of disease, the chance of a cell containing a sufficient amount of damage to initiate apoptosis is small, and the rate of cell loss is correspondingly low. The mutant neurones appear to function normally for decades, with weakness only occurring once apoptosis and cell death occurs due to a gradual accumulation of damage within the cell. Therapies aimed at preserving motor neurones may be more feasible than trying to replace lost motor neurones. A number of treatment or preventative strategies arise, such as measures to diminish SOD1 aggregation or interactions to specifically reduced apoptosis in motor neurones. As motor neurone loss at

this stage is rapid and precipitous, any potential treatment will need to be given much earlier in SOD1 mutation carriers.

Determining the mechanism by which mutations in the Cu/Zn superoxide dismutase (SOD1) gene triggers the destruction of motor neurones causing MND remains unknown. At present, the favoured hypothesis is that the mutation causes disease as a result of a toxic gain of function by the mutant SOD1 provoking selective neurotoxicity, probably disrupting the intracellular homeostasis of copper and/or protein aggregation. However, as the amount of intracellular damage increases, the chance that a cell will die also increases. This cumulative damage may be due to oxidative stress, in which an imbalance between the production of reactive oxygen species and cellular antioxidant mechanisms results in chemical modifications of macromolecules, thereby disrupting cellular structure and function. It is possible that the high metabolic activity in motor neurones, combined with the toxic oxidative properties of the mutant SOD1, causes massive mitochondrial vacuolation in motor neurones, resulting in degeneration, earlier than other neurones, triggering the onset of weakness. Prominent cytoplasmic intracellular inclusions in motor neurones and within astrocytes surrounding them developed by the onset of clinical disease and in some cases represented the first pathological sign of disease. These aggregates increased in number as the disease progressed. This indicates that the mutant SOD1 toxicity is mediated by damage to mitochondria in motor neurones and this damage triggers the functional decline of motor neurones and the clinical onset of symptoms. The absence of motor neurone death in the early stages of the disease indicates that the majority of motor neurones could be rescued after early clinical diagnosis.

Regular follow-up of SOD1 carriers with MUNE may lead to early diagnosis, creating an opportunity for future novel approaches and therapies aimed at preserving motor neurones rather than replacing lost motor neurones. If the trigger initiating motor neurone loss can be identified, it may be possible to prevent motor neurone loss in familial ALS. At this stage, detecting the onset of motor neurone loss in asymptomatic individuals will identify those who may benefit from early institution of an active management program to improve their quality of life, until more effective treatment modalities become available for this devastating condition. This observation is an important contribution to the current understanding of the pathogenesis of MND, as it shows that motor neurone disease does not seem to be the end result of slow attrition of motor neurones. MUNE may be able to be used as a method of pre-symptomatic testing of individuals who on genetic testing are SOD1 mutation carriers. Regular follow-up of SOD1 carriers with MUNE may lead to early diagnosis, creating an opportunity for future novel approaches and therapies aimed at preserving motor neurones rather than replacing lost motor neurones.

Acknowledgements

Prof. Garth Nicholson who introduced me to research into motor neurone disease and his continuing support. Prof. David Burke and Assoc. Prof. Alastair Corbett for their professional guidance and Prof. Jasper Daube for his technical assistance regarding the technique used in

this research. The research was supported by the Motor Neurone Disease Association of NSW (Northern Region), ANZAC Health and Medical Research Foundation, Motor Neurone Disease Research Institute of Australia Inc. and the Nerve Research Foundation.

Author details

Arun Aggarwal

University of Sydney, Australia

References

- [1] Aggarwal, A, & Nicholson, G. A. (2001). Normal complement of motor units in asymptomatic familial (SOD1 mutation) amyotrophic lateral sclerosis. *J. Neurology, Neurosurgery and Psychiatry*. 17 (4), 472-48.
- [2] Aggarwal, A. (2009). Detection of pre-clinical motor unit loss in familial amyotrophic lateral sclerosis. *Supplements to Clinical Neurophysiology*. , 60, 171-179.
- [3] Aggarwal, A. & G. Nicholson. ((2002). Detection Of pre-clinical motor neurone loss in SOD1 mutation carriers using motor unit number estimation. *J of Neurology, Neurosurgery & Psychiatry*. , 73(2), 199-201.
- [4] Aggarwal, A. (2009). Motor unit number estimation in asymptomatic familial amyotrophic lateral sclerosis. *Supplements to Clinical Neurophysiology*. , 60, 163-169.
- [5] Al-chalabi, A, Andersen, P. M, Nilsson, P, Chioza, B, Andersson, J. L, Russ, C, Shaw, C. E, Powell, J, & Leigh, P. N. (1999). Deletions of the heavy neurofilament subunit tail in amyotrophic lateral sclerosis. *Hum Mol Genet.*, 8, 157-164.
- [6] Andersen, P. M, Nilsson, P, Keranen, M. L, Forsgren, L, Hagglund, J, Karlsborg, M, Ronnevi, L. O, Gredal, O, & Marklund, S. L. (1997). Phenotypic heterogeneity in motor neurone disease patients with CuZn superoxide dismutase mutations in Scandinavia. *Brain*. , 120, 1723-1737.
- [7] Azzouz, M, Leclerc, N, Gurney, M, Warter, J, Poindron, M, & Borg, P. J. ((1997). Progressive motor neuron impairment in an animal model of familial amyotrophic lateral sclerosis. *Muscle Nerve.*, 20, 45-51.
- [8] Beal, M. F. (1996). Mitochondria, free radicals and neurodegeneration. *Curr Opin Neurobiol.* , 6, 661-666.
- [9] Beckman, J. S, Carson, M, Smith, C. D, & Koppenol, W. H. (1993). ALS, SOD and peroxynitrate. *Nature*.364: 584.

- [10] Bensimon, G, Lacomblez, L, & Meiniger, V. (1994). A controlled trial of Riluzole in amyotrophic lateral sclerosis. ALS/Riluzole study group. *N Engl J Med.* , 330(9), 585-591.
- [11] Blok, J. H, Van Dijk, J. P, Drenthen, J, Maathuis, E. M, & Stegeman, D. F. Size does matter: the influence of motor unit potential size on statistical motor unit number estimates in healthy subjects. *Clin Neurophysiol.* (2010). Oct; , 121(10), 1772-80.
- [12] Brown, W. F. (1972). A method for estimating the number of motor units in the thenar muscles and the changes in motor unit counting with aging. *J Neurol Neurosurg Psychiatry.*, 35, 845-852.
- [13] Bruijn, L. I, Becher, M. W, Lee, M. K, Anderson, K. L, Jenkins, N. A, Copeland, N. G, Sisodia, S. S, Rothstein, J. D, Borchelt, D. R, Price, D. L, & Cleveland, D. W. (1997). ALS-linked SOD1 mutant G85R mediates damage to astrocytes and promotes rapidly progressive disease with SOD1-containing inclusions. *Neuron.* , 18, 327-338.
- [14] Campbell, M. J, McComas, A. J, & Petito, F. (1973). Physiological changes in ageing muscles. *J Neurol Neurosurg Psychiatry.* , 36, 174-182.
- [15] Chance, P. F, Rabin, B. A, Ryan, S. G, Ding, Y, Scavina, M, Crain, B, Griffith, J. W, & Cornblath, D. R. (1998). Linkage of the gene for an autosomal dominant form of juvenile amyotrophic lateral sclerosis to chromosome 9q34. *Am J Hum Genet.* , 62, 633-640.
- [16] Cheah, B. C, Vucic, S, Krishnan, A. V, & Kiernan, M. C. (2010). Riluzole, neuroprotection and amyotrophic lateral sclerosis. *Curr Med Chem* , 17(18), 1942-49.
- [17] Clarke, G, Collins, R. A, Leavitt, B. R, Andrews, D. F, Hayden, M. R, Lumsden, C. J, & McInnes, R. R. ((2000). A one hit model of cell death in inherited neuronal degenerations. *Nature.* , 406, 195-199.
- [18] Clarke, G, Lumsden, C. J, & McInnes, R. R. (2001). Inherited neurodegenerative disease: the one hit model of neurodegeneration. *Human Molecular Genetics.* , 10, 2269-2275.
- [19] Cleveland, D. W. (1999). From Charcot to SOD1: Mechanisms of selective motor neuron death in ALS. *Neuron.* , 24, 515-520.
- [20] Cudkovicz, M. E, McKenna-yasek, D, Sapp, P. E, Chin, W, Geller, B, Hayden, D. L, Schoenfeld, D. A, Hosler, B. A, Horvitz, H. R, & Brown, R. H. Jr. ((1997). Epidemiology of mutations in superoxide dismutase in amyotrophic lateral sclerosis. *Ann Neurol.* , 41, 210-221.
- [21] Daube, J. R. (1995). Estimating the number of motor units in a muscle. *J Clin Neurophysiol.* , 12(6), 585-594.
- [22] De Bellerocche, J, Orrell, R, & King, A. J. (1995). Medical Genetics. Familial amyotrophic lateral sclerosis/motor neurone disease (FALS): a review of current developments. *J Med Genet.* , 32, 841-847.

- [23] Doble, A. (1996). The pharmacology and mechanism of action of riluzole. *Neurology*, 47: S, 233-241.
- [24] Eisen, A. (1995). Amyotrophic lateral sclerosis is a multifactorial disease. *Muscle Nerve*, 18, 741-752.
- [25] Felice, K. J. (1997). A longitudinal study comparing thenar motor unit number estimation to other quantitative tests in patients with amyotrophic lateral sclerosis. *Muscle Nerve*, 20, 179-185.
- [26] Figlewicz, D. A, Krizus, A, Martinoli, M. G, Meisinger, V, Dib, M, Rouleau, G. A, & Julein, J. P. (1994). Variants of the heavy neurofilament subunit are associated with the development of amyotrophic lateral sclerosis. *Hum Mol Genet*, 3, 1757-1761.
- [27] Gurney, M. E, Pu, H, & Chiu, A. Y. Dal Canto, M.C., Polchow, C.Y., Alexander, D.D., Caliendo, J., Hentati, A., Kwon, Y.W., Deng, H.X., Chen, W., Zhai, P., Sufit, R.L. & Siddique, T. ((1994). Motor neuro degeneration in mice that express a human Cu/Zn superoxide dismutase mutation. *Science*, 264, 1772-1775.
- [28] Gurney, M. E, Tomasselli, A. G, & Heinrichson, R. L. (1994). Stay the Executioner's hand. *Science* 2000; , 288, 283-284.
- [29] bojan Hamilton, A, Balnave, R, & Adam, R. Grip strength reliability. *J Hand Therapy*, 7(3), 163-170.
- [30] Hand, C. K, & Rouleau, G. A. (2002). Familial Amyotrophic Lateral Sclerosis. *Muscle Nerve*, 25, 135-159.
- [31] Hanten, W. P, Chen, W. Y, Austin, A. A, Brooks, R. E, Carter, H. C, Law, C. A, Morgan, M. K, Sanders, D. J, Swan, C. A, & Vanderslice, A. L. (1993). Maximum grip strength in normal subjects from 20 to 64 years of age. *J. Hand Therapy*, 12(3), 193-200.
- [32] Haverkamp, L. J, Appel, V, & Appel, S. H. (1995). Natural history of amyotrophic lateral sclerosis in a database population. Validation of a scoring system and a model for survival prediction. *Brain*, 118, 707-719.
- [33] Hentati, A, Pericak-vance, M. A, Nijhawan, D, Ahmed, A, Yang, Y, Rimmler, J, Hung, W-Y, Schlotter, B, & Ahmed, A. Ben Hamida, M., Hentati, F., Siddique, T. ((1998). Linkage of a commoner form of recessive amyotrophic lateral sclerosis to chromosome 15q15-q22 markers. *Neurogenetics*, 2, 55-60.
- [34] Hoagland, R. J, Mendoza, M, Armon, C, Barohn, R. J, Byran, W. W, Goodpasture, J. C, Miller, R. G, Parry, G. J, Petjan, J. H, & Ross, M. A. the Syntex / Synergen Neuroscience Joint Venture rhCNTF ALS Study Group. ((1997). Reliability of maximal isometric contraction testing in multicenter study of patients with amyotrophic lateral sclerosis. *Muscle Nerve*, 20, 691-695.

- [35] Kong, J, & Xu, Z. (1998). Massive mitochondria degeneration in motor neurons triggers the onset of amyotrophic lateral sclerosis in mice expressing a mutant SOD1. *J Neurosci.* , 18, 3241-3250.
- [36] Kosti, V, Jackson-lewis, V, & Bilbao, F. D. (1997). Bcl-2: prolonging life in a transgenic mouse model of familial amyotrophic lateral sclerosis. *Science.* 227: 577.
- [37] Leigh, P. N. Amyotrophic lateral sclerosis and other motor neurone diseases. ((1997). *Current Opinion Neuro Neurosurg.* 3: 567.
- [38] Li, M, Ona, V. O, Gueng, C, Chen, M, Jackson-lewis, V, Andrews, L. J, Olszewski, A. J, Steig, P. E, Przedborski, S, & Friendlander, R. M. (2000). Functional role of caspase-1 and caspase-3 in an ALS transgenic mouse model. *Science.* , 288, 335-339.
- [39] Lomen-hoerth, C, & Slawnych, M. P. (2003). Statistical motor unit number estimation: From theory to practice. *Muscle Nerve.* , 28, 263-272.
- [40] Lomen-hoerth, C, & Olney, R. K. Comparison of multiple point and statistical motor unit number estimation. *Muscle Nerve.* (2000). Oct; , 23(10), 1525-33.
- [41] Mccomas, A. J. (1971). Functional compensation in partially denervated muscles. *J Neurol Neurosurg Psychiatry* , 34, 453-460.
- [42] Mccomas, A. J. (1991). Motor unit estimation: Methods, results and present status. *Muscle Nerve.* , 14, 585-597.
- [43] Mccomas, A. J, Fawcett, P. R. W, Campbell, M. J, & Sica, R. E. P. (1971). Electrophysiological estimation of the number of motor units within a human muscle. *J. Neurology, Neurosurgery and Psychiatry.* , 34, 121-131.
- [44] Mcneil, D. (1996). *Statistical Methods.* 1st Edition. New York. *Wiley & Sons*; 184.
- [45] Mena, I, Marin, O, Fuenzalida, S, & Cotzias, G. C. (1967). Chronic manganese poisoning. Clinical picture and manganese turnover. *Neurology.* , 17, 128-136.
- [46] Miller, R. G, Mitchell, J. D, Lyon, M, & Moore, D. H. (2007). Riluzole for amyotrophic lateral sclerosis (ALS / motor neuron disease (MND)). *Cochrane Database Syst Rev.* 1: CD001447.
- [47] Mu, X, He, J, & Anderson, M. (1996). Altered expression of bcl-2 and bax mRNA in amyotrophic lateral sclerosis spinal cord motor neurones. *Ann Neurol.* 40: 379.
- [48] Mulder, D. W, & Howard, F. M. Jr. ((1976). Patient resistance and prognosis in amyotrophic lateral sclerosis. *Mayo Clin Proc.*, 51, 537-541.
- [49] Mulder, D. W, Kurland, L. T, Offord, K. P, & Beard, C. M. (1986). Familial adult motor neurone disease: amyotrophic lateral sclerosis. *Neurology.* , 38, 511-517.
- [50] Needleman, H. L. (1997). Exposure to lead: Sources and effects. *N Engl J Med.* , 297, 943-945.

- [51] Noor, R, Mittal, S, & Iqbal, E. (2003). Superoxide dismutase- applications and relevance to human diseases. *Med Sci Monit.* , 8(9), 210-215.
- [52] Olney, R. K, Yuen, E. C, & Engstrom, J. W. (2000). Statistical motor unit number estimation: Reproducibility and sources of error in patients with amyotrophic lateral sclerosis. *Muscle Nerve.* , 23, 193-197.
- [53] Radunovic, A, & Leigh, P. N. (1996). Cu/Zn superoxide dismutase gene mutations in amyotrophic lateral sclerosis: correlation between genotype and clinical features. *J. Neurology, Neurosurgery and Psychiatry.* , 61, 565-572.
- [54] Ringel, S. P, Murphy, J. R, Alderson, M. K, Byran, W, England, J. D, Miller, R. G, Petajan, J. H, Smith, S. A, Roelofs, R. I, Ziter, F, Lee, M. Y, Brinkmann, J. R, Almada, A, Gappmaier, E, Graves, J, Herbelin, L, Mendoza, M, Mylar, D, Smith, P, & Yu, P. (1993). The natural history of amyotrophic lateral sclerosis. *Neurology.* , 43, 1316-1322.
- [55] Robberecht, W. (2000). Oxidative stress in amyotrophic lateral sclerosis. *J. Neuro.* 247 (Suppl. 1): 111-116.
- [56] Rosen, D. R, Siddique, T, Patterson, D, Figlewicz, D. A, Sapp, P, Hentati, D, Donaldson, D, Goto, J, Regan, O, Deng, J. P, Rahmani, H. X, Krizus, Z, Mckenna-yasek, A, Cayabyab, D, Gaston, A, Berger, S, Tanzi, M, Halperin, R. E, Herzfeldt, J. J, Van Den, B, Bergh, R, Hung, W. Y, Bird, T, Deng, G, Mulder, D. W, Smyth, C, Laing, N. G, Soriano, E, Pericak-vance, M. A, Haines, J, Rouleau, G. A, Gusella, J. S, & Horvitz, H. R. Brown R.H., Jr. ((1993). Mutations in Cu, Zn superoxide dismutase gene are associated with familial amyotrophic lateral sclerosis. *Nature.*, 362, 59-62.
- [57] Shaw, C. E, Enayat, Z. E, Powell, J. F, Anderson, V. E, Radunovic, A, Powell, J. F, & Leigh, P. N. (1998). Mutations in all five exons of SOD1 may cause ALS. *Ann Neurol.* , 43, 390-394.
- [58] Shefner, J. M. (2001). Motor unit number estimation in human neurological diseases and animal models. *Clin Neurophysiol.* , 112, 955-964.
- [59] Shefner, J. M, Cudkowicz, M. E, Zhang, H, Schoenfield, D, & Jillapalli, D. (2004). Northeast ALS Consortium. The use of statistical MUNE in multicentre clinical trials. *Muscle Nerve.* , 30, 463-9.
- [60] Shefner, J. M. (2009). Statistical motor unit number estimation and ALS trials: the effect of motor unit instability. *Suppl Clin Neurophysiol.*, 60, 135-41.
- [61] Shefner, J. M, Watson, M. L, Simionescu, L, Caress, J. B, Burns, T. M, Maragakis, N. J, Benatar, M, David, W. S, Sharma, K. R, & Rutkove, S. B. Multipoint incremental motor unit number estimation as an outcome measure in ALS. *Neurology.* (2011). Jul 19; , 77(3), 235-41.
- [62] Sica, R. E. P, Mccomas, A. J, Upton, A. R. M, & Longmire, D. (1974). Motor unit estimations in small muscles of the hand. *J Neurol Neurosurg Psychiatry.*, 37, 55-67.

- [63] Siddique, T, & Deng, H. X. (1996). Genetics of amyotrophic lateral sclerosis. *Human Mol Gen.* , 5, 1465-1470.
- [64] Siddique, T, Pericak-vance, M. A, & Brooks, B. R. (1989). Linkage analysis in familial amyotrophic lateral sclerosis. *Neurology.* , 39, 919-925.
- [65] Siddique, T, Figlewicz, D. A, Pericak-vance, M. A, Haines, J. L, Rouleau, G. A, Jeffers, A. J, Sapp, P, Hung, W. Y, Bebout, J, Mckenna-yasek, D, Deng, G, Horvitz, H. R, Gussella, J. S, & Brown, R. H. Jr., Roses, A.D. and Collaborators. ((1991). Linage of a gene causing familial amyotrophic lateral sclerosis to chromosome 21 and evidence of genetic locus heterogenicity. *N Engl J Med.* , 324, 1381-1384.
- [66] Sjalander, A, Beckman, G, & Deng, H. Z. A mutation results in a polymorphism of Cu/Zn superoxide dismutase that is prevalent in northern Sweden and Finland. *Hum Mol Genet* 1995; , 4, 1105-1108.
- [67] Stein, R. B, & Yang, J. F. (1990). Methods of estimating the number of motor units in human muscles. *Ann Neurol.* , 28, 487-495.
- [68] Talbot, K. (2002). Motor neurone disease. *Muscle Nerve.* , 25, 513-519.
- [69] Trotti, D, Rolfs, A, Danbolt, N. C, & Brown, R. H. Jr, Hediger, M.A. ((1999). SOD1 mutations linked to amyotrophic lateral sclerosis selectively activates a glial glutamate transporter. *Na Neurosci.* , 19, 427-433.
- [70] Vechio, J. D, Bruijn, L. I, Xu, Z, & Brown, R. H. Jr, ((1996). Cleveland,D.W. Sequence variants in the human neurofilament proteins: absence of linkage to familial amyotrophic lateral sclerosis. *Ann Neurol* 1996; , 40, 603-610.
- [71] Yim, M. B, Chock, P. B, & Stadtman, E. R. (1990). Copper, zinc superoxide dismutase catalyses hydroxyl radical production from hydrogen peroxide. *Proc Natl Acad Sci.* , 87, 5006-5010.

