

We are IntechOpen, the world's leading publisher of Open Access books Built by scientists, for scientists

4,800

Open access books available

122,000

International authors and editors

135M

Downloads

Our authors are among the

154

Countries delivered to

TOP 1%

most cited scientists

12.2%

Contributors from top 500 universities



WEB OF SCIENCE™

Selection of our books indexed in the Book Citation Index
in Web of Science™ Core Collection (BKCI)

Interested in publishing with us?
Contact book.department@intechopen.com

Numbers displayed above are based on latest data collected.

For more information visit www.intechopen.com



Application of 2^K Experimental Design and Response Surface Methodology in the Optimization of the Molar Mass Reduction of Poly (3-Hydroxybutyrate-co-3-Hydroxyvalerate) (PHBHV)

Sérgio Roberto Montoro, Simone de Fátima Medeiros,
Amilton Martins Santos, Messias Borges Silva and Marli Luiza Tebaldi

Additional information is available at the end of the chapter

<http://dx.doi.org/10.5772/56532>

1. Introduction

Biodegradable and biocompatible polymers have attracted great attention, both from scientific and technological fields. Developing new biodegradable materials to replace petrochemical derivatives is demanding and also a challenge for chemists worldwide as well as to developing more efficient synthesis processes with the aim to reduce their production cost. Besides environmental effects due to plastic wastes, there is great interest in the development of biocompatible and biodegradable materials for biomedical applications or in other biomaterials. Regarding such materials, polyhydroxyalkanoates (PHAs) are good examples among them. They are polyesters of hydroxyalkanoic acid, globally manufactured in industrial scale using microbial biosynthesis deriving from renewable carbon sources, in form of storage materials as shows Figure 1. The accumulation of such polymers in granules shape are found in the cell's cytoplasm, their diameter show a wide range variation, from 0.2-0.5 μ m and they work as glycogen synthesizers and are stored by mammals [1-3].

1.1. General PHAs properties

Awareness of PHAs physical, chemical and biological properties is important, mainly in regards to the development of controlled release systems, once they directly influence, among other factors, microencapsulation processes selection and drug release mechanisms [4-5].

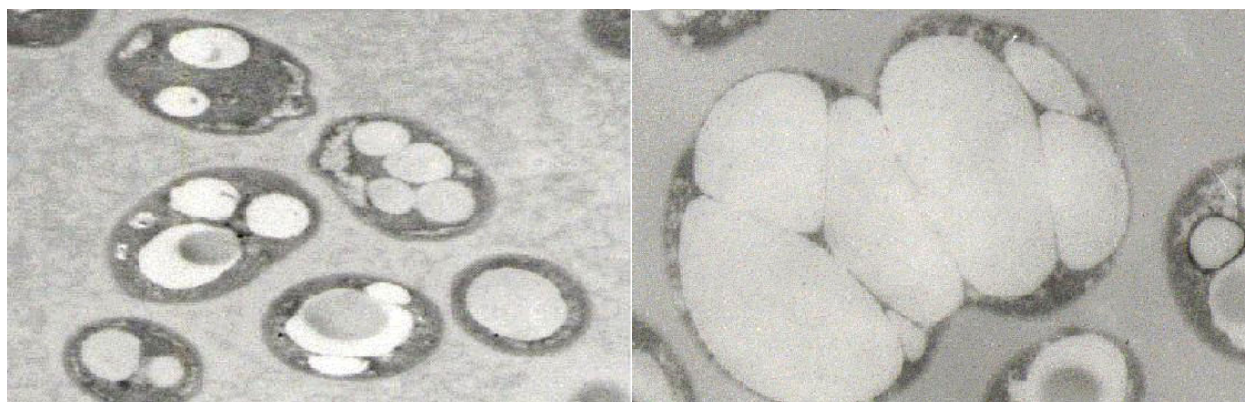

Figure 1. Exponential growth phase containing about 40 - 50% PHB (left) and final accumulation phase containing about 93% PHB (right).

Usually, PHAs are crystalline structures, so their brittleness and low flexibility set limits their application in some biomedical procedures. Thus, lack of superior mechanical proprieties, require modifications, mainly, for medical applications [6].

PHAs molar mass is a crucial factor, once such parameter directly affects mechanical strength, swelling capacity and the ability to undergo hydrolysis, as well as polymers biodegradation rates. Molar mass is related to PHA's crystallinity. Therefore, developing a controlled drug delivery system using PHAs requires an essential preliminary molar mass reduction step. An important factor showing molar mass dependence of biodegradable polymers degradation rates dues to a direct proportionality between this parameter and the polymers T_g , i.e., the lower the polymer molar mass, the lower the T_g value. In addition, degradation rates increasing leads to complex ingredients release rates increasing, having these polymers as polymeric matrixes, they will be promptly absorbed by the body [4]. Moreover, low molar mass PHAs can be used as components on several architecture constructions, such as block and grafted copolymers [7].

1.2. PHB and PHBHV copolymers

Poly(3-hydroxybutyrate) (PHB) and its copolymers with hydroxyvalerate (HV) are the most studied PHAs in literature [8]. PHB and PHBHV are completely biodegradable and produced by a variety of bacteria's fermentation, [1] degrading throughout natural biological processes, turning them into excellent candidates for bioactive molecules release system's production [9-15]. Both poly(3-hydroxybutyrate) (PHB) and poly(3-hydroxybutyrate-co-3-hydroxyvalerate) (PHBHV) are biodegradable thermoplastic polyesters produced by a bacteria known as *Ralstonia eutropha* or *Alcaligenes latus* [16]. PHBHV has emerged as a new generation of PHA in which the surface morphology combined with its lower crystallinity when compared to PHB homopolymers fastens degradation processes. Furthermore, copolymers physical properties can be manipulated by varying the HB and HV's composition [17]. Such advantages make the use of PHBHV copolymers suitable for many applications, once compared to PHB homopolymers. Nevertheless, ISO 10993 highlighted such polymers as safe and non toxic materials

indicated to be used in animal's controlled drug release tests [18]. The PHBV structure is shown in Figure 2.

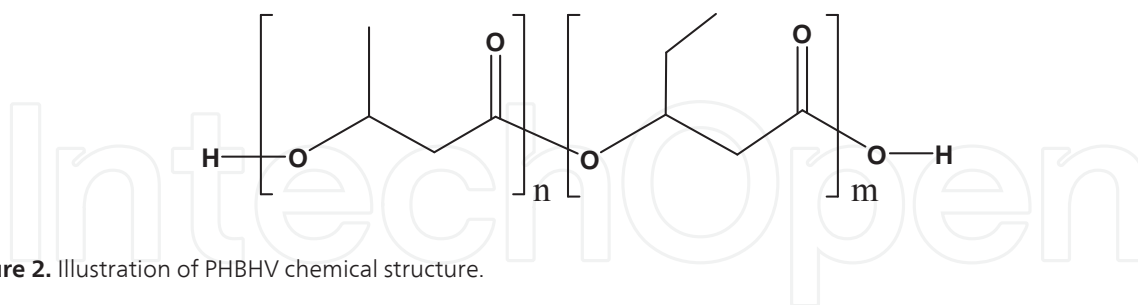

Figure 2. Illustration of PHBV chemical structure.

Polymers used as carrier agents play a very important role in active ingredients controlled delivery systems, determining, among other factors, drug release rates. In fact, drug release can be performed by different mechanisms: diffusion through the swelled polymer network, erosion/biodegradation of polymer chains as well as a combination of mechanisms. Basically, the difference between erosion and biodegradation mechanisms is established based on the macromolecule degradation ones. Polymer matrix erosion results, in a macroscopic level, in mass loss, with no modifications on macromolecular units. It can happen in two different ways: either by breaking intermolecular bonds in cross-linked systems, where matrixes are gradually eroded from the external surface, or by main chain's side group hydrolysis, resulting in polymers dissolution, without reducing its molar mass [19].

According to such context, biodegradable polymers are those where chain's breaking results in monomeric units in which molar masses are small enough to be eliminated by normal metabolic pathways. Such breakage can occur by hydrolysis (hydrolytic degradation) or enzymatic attack (enzymatic degradation). Erosive or degradable systems, particularly those that degrade in biological mediums (biodegradable) have found great utility in controlled release systems development.

Polymers natural elimination, after total drug release, is an advantage once it avoids the inconvenience of surgical interventions to remove it. Thus, micro and nano-structured as well as biodegradable and biocompatible systems (microspheres, microcapsules, nano-capsules, nano-spheres) have been developed for drug controlled release [20].

The role that polymers play during the formulation (modulation) of these controlled release systems is very different if compared to an inert conventional excipient for pharmaceutical formulations. Polymers influence not only drug kinetics release, as expected, but also the drug's stability, toxicity and the compatibility between biopolymers and living organism.

Innumerable techniques have been proposed in literature, regarding polymeric micro and nanostructured materials for drug controlled delivery systems preparation [21].

The most common method used for systems based on PHAs, such as PHB and PHBV, is called micellization, i.e., - preparation of small micelles through self-assembly of amphiphilic chains in water [7]. Inside amphiphilic structures of polymeric micelles, hydrophobic drug molecules are distributed within the hydrophobic cores, whereas the shell keeps a hydration

barrier that protects the integrity of each micelle. The use of amphiphilic block copolymers is advantageous because they possess unique physicochemical features such as self-assembly and thermodynamic stability in aqueous solution [22]. In order to get amphiphilic structures, surface changes on the hydrophobic segment with a hydrophilic, which is able to stabilize particles, nontoxic and blood compatible materials essential to avoid macrophages recognition, prolonging blood circulation time and sustaining encapsulated drugs release. Many hydrophilic polymers have been suggested for such application. Poly(ethylene glycol) (PEG), for example, is widely used as a hydrophilic nontoxic segment once combined with hydrophobic biodegradable aliphatic polyesters. It was found that incorporated hydrophilic mPEG groups, showing resistance against opsonization and phagocytosis, also presenting prolonged residence time in blood if compared to nanoparticles prepared without mPEG. Nevertheless, it has been demonstrated that surface modifications of a polymer with this nontoxic material reduces side effects risk in comparison to the non-modified polymers [15].

Low molar mass biodegradable block copolymers, in form of amphiphilic micro and nanoparticles, were a suggestion of use as sustained release for a variety of hydrophobic drugs [22]. Encapsulate active ingredients in polymeric nanoparticles aims to turn the delivery of effective doses of pharmacologically active substance to a particular site possible, mainly in tumors, for a sustained period of time, avoiding innumerable side effects associated with multiple drug dosing. The defective and leaky structure of tumor vessels and impaired lymphatic system facilitates internalization of polymeric nanoparticles containing drugs, which enhances active agent local effects and protects healthy cells [4].

1.3. Why PHB and PHBHV need modifications?

Besides PHBHV lower crystallinity when compared to other PHAs, its crystalline percentage (55–80%) also needs to be considered. Moreover, it may suffer degradation by conventional melt processing, which limits its use in many specific applications [15]. In order to minimize such problems, PHB and PHBHV are often blended [13-14, 23-26] or used with a mixture of substances such as natural rubber, it is also used in the preparation of composites, [27] or it can be changed through a number of strategies such as using click chemistry [28-29] or modifying the surface and subsequent graftization in a series of monomers [30-35] as well as along with agents: plasticizers, lubricants, antioxidants, photostabilizers and other miscible polymers [36]. PHBHV were modified with natural rubber producing composites with enhanced mechanical proprieties [27]. Ke *et al.* [33] studied thermal properties and *in vitro* degradation of amide, amine, and collagen-modified PHBHV films aiming to improve biodegradation rates on cytocompatible biomaterials. Biodegradation rates of modified PHBHV were greater than pure PHBHV, offering an alternative to improve such materials properties.

Linhart and *co-authors* [37] showed that amorphous calcium phosphate (ACP) composites and PHB or PHBHV (PHB-ACP or PHBHV-ACP) would be potential bone substitution materials. As it is known, PHAs intrinsic hydrophobic properties restrict some of their applications *in vivo*. Consequently, these materials could be improved by either chemical modification with functional group's introduction or by modifying the topographic surface. PHBHV surfaces

were modified with triarylsulfonium salts upon UV irradiation. The process forms species that abstract hydrogen atoms from the PHBHV surface, generating primary radicals which are able to initiate monomer's polymerization by UV-mediation allowing wettability control of produced films, improving their ability for cellular interaction [32]. Vergnol G. *et al.* [10] described the use of PHAs as stent coatings containing the sirolimus drug. Natural PHBHV, poly(3-hydroxyoctanoate) functionalized with carboxylic groups, PHO₇₅COOH₂₅, and diblock copolymer PHBHV-*b*-(lactic acid) were sprayed onto metallic stents. P(HBHV-*b*-LA) as coating, enhanced the drug release profile by limiting sirolimus release. Bilayer systems were proposed, it seemed to be very promising, especially in systems with PHBHV and P(HBHV-*b*-LA). Gracida J. *et al.* [24] studied blends of PHBHV/PHEMA's degradation by fungal activity using the ASTM method and CO₂ measurements to determine biodegradability. Studies showed that PHBHV/PHEMA blends are biodegradable in a ASTM method context.

As previously mentioned, to tailor PHB thermal and mechanical properties, its copolymerization with 3HV is commonly performed. Currently, much research work has been published reporting various methods of obtaining a range of PHBHV copolymers with different 3HV content using different carbon nutrition conditions [1,38]. However, molar mass in biosynthesis is typically high and not suitable for systems of drug controlled release. Moreover, commercial PHBHV shows some disadvantages, such as poor thermal stability and high melting temperature. PHBHV's thermal degradation temperature is close to 160°C and their melting temperature is around 150°C, resulting in a small processing window [39].

In addition, in PHBHV's biosynthesis only highly hydrophobic polymers are produced and this is unfavorable to the interaction between a biomaterial surface and cells or some other *in vivo* applications. Such polymers need much more versatile modifications in order to obtain new materials with improved mechanical and thermal properties, besides increasing the hydrophilic character [1].

To achieve this goal, the main procedure aims to perform PHBHV molar mass reduction.

1.3.1. Molar mass reduction and further modifications

In this context, aiming to solve the aforementioned problems, polymers molar mass reduction is a fundamental requirement. Such procedure offers, as its main advantage, the possibility to carry a series of modifications including polymer functionalization with terminal vinyl groups, which are highly reactive, in further modification reactions [40].

Many efforts have been made in order to provide PHB molar mass reduction and to improve its copolymers properties or to prepare the material for further modifications.

PHB and PHBHV molar mass reductions can be obtained by thermal degradation [34,41], acid hydrolysis [4, 42-43], transesterification with glycols [44] reduction with NaBH₄ [6, 45] or also *in vivo* esterification with PEG [46].

One promising approach to improve their physical properties, adjusting degradation rates, dues to synthesizing block copolymers using telechelic PHB or PHBHV of low molar mass through chemical routes. These modifications involve reactions with bromide or chloride

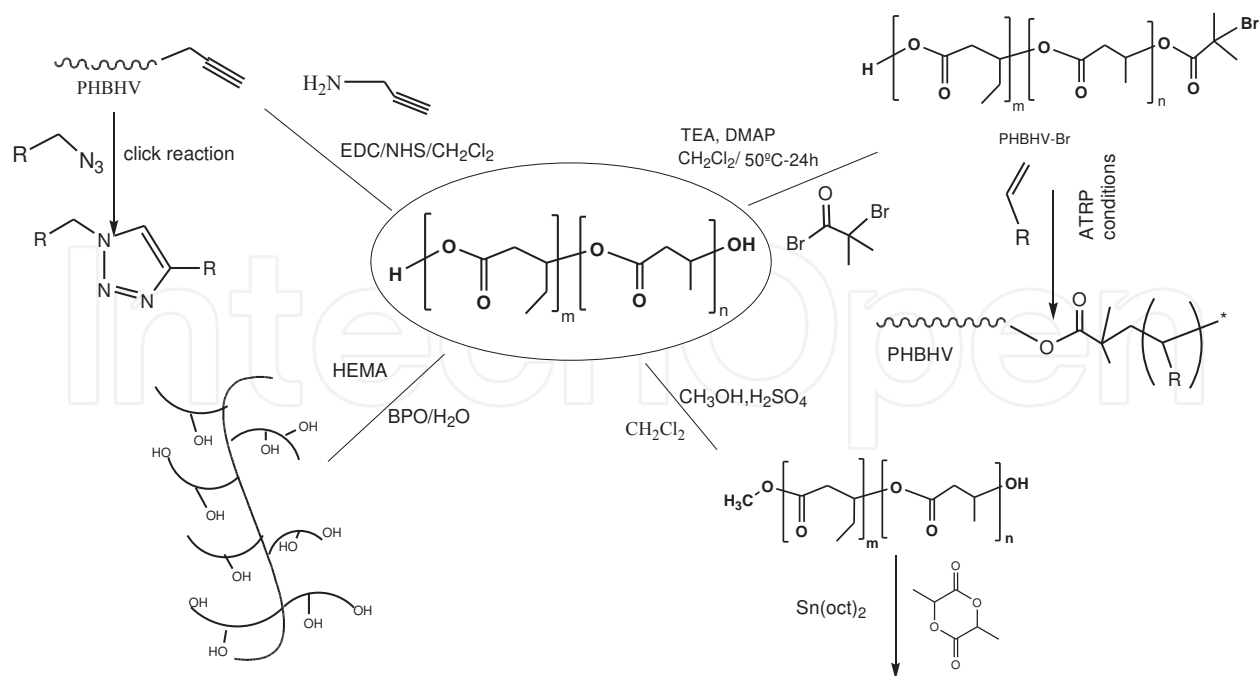

Figure 3. Possible modification reactions in PHBHV with low molar mass.

molecules turning these polymers macro-initiators, which can trigger a new polymerization with various monomers in order to obtain new materials type graft [30-31] or block [12,29,47-48] copolymers with specific properties, for example, amphiphilic systems for drug carrier. Figure 3 shows some possible modifications that can be done to improve PHBHV with low molar mass proprieties.

Arslan H. and *co-authors* prepared lower molar mass PHB-Cl by using a depolymerization process (heating it under reflux with 1,2-dichlorobenzene) and by subsequent chlorination by means of passing chlorine gas through PHB solutions. The chlorinated PHB (PHB-Cl) were used as macro-initiators in methyl methacrylate (MMA) polymerization aiming to obtain PHB-*g*-PMMA graft copolymers by the atom transfer radical polymerization (ATRP) method [31]. ABA triblock copolymers were prepared through three consecutive steps. Firstly, natural PHB with high molar mass, was converted into low molar mass PHB-diol by trans-esterification with diethylene glycol. In the next step, PHB-diol pre-polymers were reacted with 2-bromo-2-methylpropionylbromide to obtain PHB-Br macro-initiators which were used to carry out the *tert*-butyl acrylate (*t*BA) polymerization by ATRP. The degradation rate was adjusted according to PHB contents [48]. Spitalský, Z. *et al.* [44] prepared PHB oligomers by alcoholysis using two types of alcohol in the presence of *p*-toluene sulfonic acid as catalyst, which can be used for further crosslinking and chain-extension reactions. Reeve, MS. *et al.* [49] synthesized PHB macro-initiators of low molar mass by methanolysis followed by reactions with AlEt_3 , which were used to obtain biodegradable diblock copolymers. Hirt, TD. *et al.* [50] obtained telechelic OH- terminated PHB and PHBHV by trans-esterification in order to prepare precursors with reactive end groups which were used to synthesize high-molar mass block copolymers by chain extension. PHB oligomers were prepared and reacted with 2-hydroxyethyl methacrylate

(HEMA) to form macro-monomers with two unsaturated end groups and afterwards grafted with methyl methacrylate to obtain materials that can be used as constituents in acrylic bone cements for use in orthopaedic applications [34]. Oliveira, AM. and *co-authors* synthesized PHBHV-*b*-PNIPAAm block copolymers reacting hydroxyl-capped PHBHV of low molar mass and carboxyl-capped PNIPAAm obtained via reversible addition-fragmentation chain transfer (RAFT) polymerization. The thermo-responsive particles were loaded with dexametasone acetate (DexAc) and showed drug delivery behaviour dependent of temperature, suggesting that these polymeric micelles can be utilized as drug delivery systems [12]. Baran, ET. *et al.* [45] prepared PHBHV of low molar mass via mechanisms of degradation by sodium borohydride (NaBH₄). Nanocapsules of PHBHV of low molar mass was prepared and tested for the entrapment of therapeutically active proteins such as those used in cancer therapy. The studies indicated that the use of low molar mass PHBHV was more favorable in increasing entrapment and entrapment efficiency and enzyme activity [46]. Montoro, SR. *et al.* [42] used the methods of acid hydrolysis and trans-esterification with ethylene and hexyleneglycol and also by reductions with sodium borohydride [4,6] to obtain PHBHV with molar mass reduced in order to develop materials suitable to be used as carriers in active systems. Liu, Q. *et al.* [39] synthesized telechelic PHBHV-diols with various molar mass by trans-esterification with ethylene glycol. The results showed that PHBHV-diol was more stable than original PHBHV and the melt-processing window increase gradually with molar mass decrease.

Lemechko, P. *at al.* prepared dextran-*graft*-PHBHV amphiphilic copolymers using two "grafting onto" methods. In the first one, PHBHV oligomers were reacted with SOCl₂ to obtain chloride terminated PHBHV with subsequent esterification with dextran. In the second method, PHBHV oligomers were functionalized with alkyne end groups and grafted onto functionalized dextran via click chemistry reaction. The presence of reactive groups could be interesting to bind bioactive molecules in order to develop heterofunctional nanoparticles [28]. Babinot, J. *at al.* synthesized amphiphilic diblock copolymers with different PHAs of low molar mass. The authors firstly prepared the PHAs oligomers by thermal treatment (190°C) varying the time of reaction and after that, the oligomers were functionalized with alkine function by click chemistry reaction conducting to graftitization with MeO-PEG [29].

The reduction of PHB's molar mass *in vivo* is another strategy, which was used by Ashby RD. *et al.* [46]. The authors controlled PHB's molar mass by adding PEG segments in the incubation medium. PEG interacts with the cellular biosynthetic system which is responsible for P3HB synthesis and regulates the molar mass. A series of PEGs with different molar mass were added to the *Alcaligenes latus* DSM 1122 incubation medium. Such strategy resulted in products of P3HB-PEG diblock copolymers type with reduced molar mass.

Shah *et al.* [15], synthesized amphiphilic biodegradable core-shell nanoparticles by emulsification-solvent evaporation technique using poly(3-hydroxybutyrate-*co*-3-hydroxyvalerate) or poly(3-hydroxybutyrate-*co*-4hydroxybutyrate) diblock copolymers. Copolymers were coupled to monomethoxy poly(ethylene glycol) (mPEG) via trans-esterification reactions. Nanoparticles were found to be assembled in aqueous solution into an outer hydrophilic shell of mPEG, connected to the interior hydrophobic polyhydroxyalkanoate (PHA) copolymer core. Moreover, the morphological examination, by means of atomic force microscope,

revealed the nanoparticle's smooth spherically shape. The average particle sizes and zeta potentials of amphiphilic nanoparticles were in the range of 112–162 nm and -18 to -27 mV, respectively. Finally, a hydrophobic drug (thymoquinone) was encapsulated in the nanoparticles and its release kinetics was studied.

In this context, this section presents a study on optimization of ideal PHBHV molar mass reduction due to temperature changes and in concentration of the reducing agent (NaBH_4). From a statistical experimental design (2^k Full Factorial) and Response Surface Methodology (RSM), it was determined which of these variables had a greater influence in reducing the molar mass of PHBHV.

Actually, these PHAs are produced in Brazil (pilot-scale), and are considered one of the most promising alternatives due to its properties and low cost.

2. 2^k factorial design

Factorial designs are often used in experiments involving several factors that demand the study of their total effects over a certain response. However, special cases regarding factorial design - in general - are important due to the fact that they are widely used by researchers and because they represent the basis for other considerably valorous planning.

K factor's case is the most important one among them all. Each one presents only two levels. Such levels may be quantitative - two temperature, pressure or time values, etc. - or qualitative - two machines, two operators, a factor's "high" and "low" level-, or, yet the presence and absence of a factor. A complete replication of planning requires $2 \times 2 \times \dots \times 2 = 2^k$ observations and is known as 2^k factorial design.

2^k design is particularly useful in some experiment's early stages, when many factors are, probably, observed. It provides a lower amount of turns in which k factors can be studied - by means of a complete factorial design - once there are only two levels of each factor. We must assume that the response is basically linear, considering the chosen factor's ranges [51-54].

2.1. 2^2 design

2^k factorial design simplest type is the 2^2 - two factors, A and B , each one of them holding two levels. We usually think about such levels as "low" and "high" values. Figure 4 illustrates the 2^2 planning. Note that "plans" can be geometrically represented as squares in which $2^2 = 4$ runs - or treatment combinations, forming the square's vertices. Regarding 2^2 planning, it is usual to highlight A and B factors as "low" and "high" levels, using (-) and (+) signs to demonstrate them, respectively. Sometimes it is called "geometric concept for planning".

A special concept is used to underline treatment combinations. In general, a treatment combination is represented by a series of lowercase fonts. If a certain font is shown, the corresponding factor is ran at that treatment combination's high level; if it is absent, the factor is ran at its low level. For example, treatment combination (a) indicates that factor A is at high

level and that factor *B* is at low level. The treatment combination using both factors at low level is represented by (1). Such notation will be used throughout the whole 2^k design's series. For example, a 2⁴ treatment, having *A* and *C* at high level, as well as *B* and *D* at low level, is highlighted by (*ac*) [51,52].

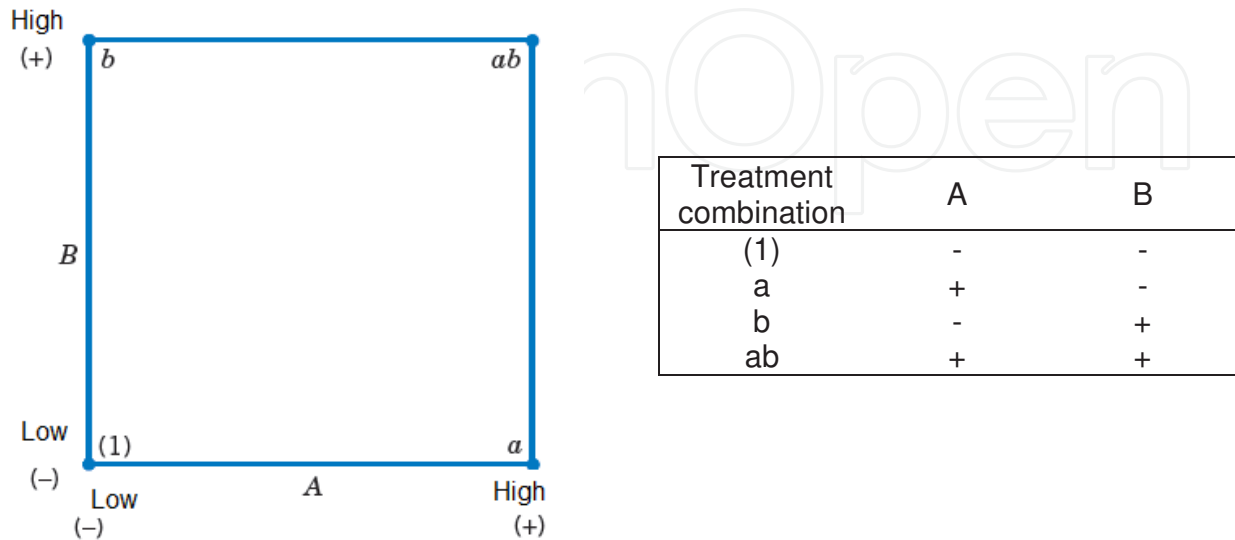

Figure 4. Treatment combinations in a 2² design [adapted 51]

The interest in 2² factorial design's effects regards *A* and *B* effects, as well as *AB* second order's interaction factor. According to cases in which fonts (1), *a*, *b*, *ab* are the total of all (*n*) observations performed over these planning points. It is easy to estimate such factor's effects. In order to estimate *A* factor's main effect, it is necessary to find the observation's average on the right side of the square (Figure 4), - having *A* at high level - and subtract such average from the observation's average on the left side of the square, where *A* is at low level, or:

A factor's main effect: 2² Factorial design

$$A = \bar{y}_{A+} - \bar{y}_{A-} = \frac{a + ab}{2n} - \frac{b + (1)}{2n} = \frac{1}{2n} [a + ab - b - (1)] \quad (1)$$

Similarly, *B*'s main effect is found taking the observations' average at the top of the square, being - having *B* at high level -, and subtract the observations' average at the bottom of the square - having *B* at low level:

B factor's main effect: 2² Factorial design

$$B = \bar{y}_{B+} - \bar{y}_{B-} = \frac{b + ab}{2n} - \frac{a + (1)}{2n} = \frac{1}{2n} [b + ab - a - (1)] \quad (2)$$

Finally, AB interaction is estimated by finding the difference from diagonal's averages seen on Figure 4, or:

AB effect's interaction: 2^2 Factorial design

$$AB = \frac{ab + (1)}{2n} - \frac{a + b}{2n} = \frac{1}{2n} [ab + (1) - a - b] \quad (3)$$

The equations quantities in brackets (1), (2) and (3) are called contrasts. For example, A contrast is: $\text{Contrast}_A = a + ab - b - (1)$.

According to such equations, the contrasts' coefficients are always (+1) or (-1). A plus (+) and minus (-) signs table, such as on Table 1, can be used to determine the sign of each treatment combination for a particular contrast. The columns names on Table 1 are A and B main effects, AB interaction and I - representing the total. The lines names are treatment combinations. Note that signs on the AB column are the product of A and B columns. In order to generate the contrast from this table, it is demanding to multiply the signals from the appropriate column on Table 1 by the treatment combinations listed on the lines and add. For example, $\text{contrast}_{AB} = [(1)] + [a] + [b] + [ab] = ab + (1) - a - b$ [51,52].

Treatment Combination	Factorial Effects			
	I	A	B	AB
(1)	+	-	-	+
a	+	+	-	-
b	+	-	+	-
ab	+	+	+	+

Table 1. Algebraic signs for calculating effects in 2^2 Design.

Contrasts are used to calculate effects estimations and the squares sums for A , B and AB interaction. Regarding any 2^k design with (n) replications, effects estimations are calculated from:

Relation between a contrast and an effect

$$\text{Effect} = \frac{\text{Contrast}}{n2^{k-1}} \quad (4)$$

And, the sum of any effect's square is:

Any effect's square sum

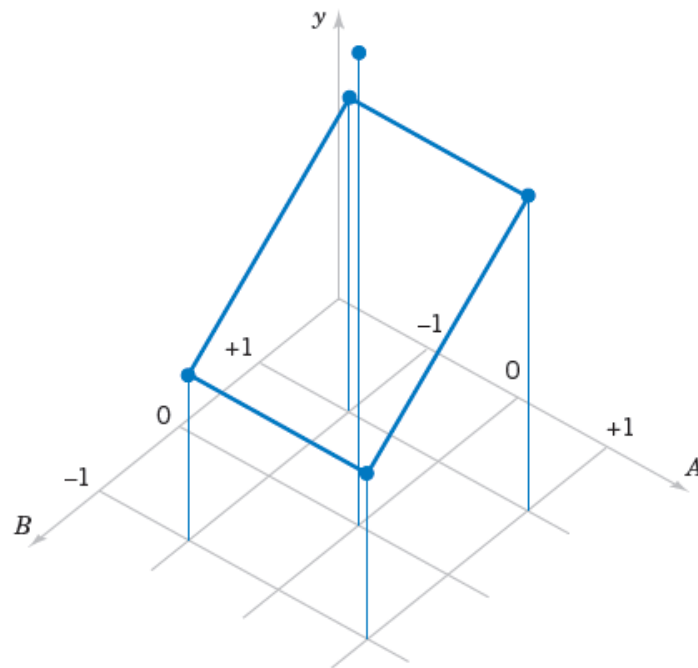

Figure 5. Design with central points [51].

$$SS = \frac{(\text{Contrast})^2}{n2^k} \quad (5)$$

There is a level of freedom associated to each effect (two levels minus one), so that the error's mean square to each effect is equal to the sum of the squares. The variance analysis is completed by calculating the total sum of squares SS_T (with $4n - 1$ level of freedom), as usual, and by getting the squares' error sum SS_E (with $(4n - 1)$ levels of freedom) by subtraction means [51,52].

2.2. Adding central points to 2^k designs

A potential concern in the use of two levels factorial designs is the linearity assumption of linearity in factors effects. Naturally, perfect linearity is unnecessary and the 2^k system will work out well, even when linearity's assumption is approximately kept. However, there is a method to replicate certain points in the 2^k factor. It avoids bending as well as allows estimation, regardless the errors that can be obtained. The method consists in adding points to the 2^k central planning. They consist on replicas races $n_c = 0$ at point x_i ($i = 1, 2, \dots, k$). An important reason to add replicated races to the planning's center, due to the fact that the central point do not affect usual estimations regarding 2^k planning effects. We consider k factors as quantitative ones. Aiming to illustrate the approach, it was considered a 2^2 plan, with one observation on each one of the factorial points $(-, -)$, $(+, -)$, $(-, +)$ and $(+, +)$ and (n_c) observations on the central points $(0, 0)$. Figure 5 illustrates the situation. \bar{y}_F is the average of four runs on the four factorial points and \bar{y}_C is the average of n_c runs at the midpoint [51,52]

If the difference $\bar{y}_F - \bar{y}_C$ is small, the central point will be at or near the flat plane passing through the factorial points and, therefore, there will be no quadratic curve. On the other hand, if $\bar{y}_F - \bar{y}_C$ is large, then a quadratic curve will be present. Squares sums –with an unique freedom degree – to a curve is given by:

Sum of squares sums for curves

$$SS_{Pure_quadratic} = \frac{n_F n_C (\bar{y}_F - \bar{y}_C)^2}{n_F + n_C} = \left(\frac{\bar{y}_F - \bar{y}_C}{\sqrt{\frac{1}{n_F} + \frac{1}{n_C}}} \right)^2 \quad (6)$$

when, in general, n_F is the amount of factorial design points. Such quantity can be compared to error's mean square error in order to test the curve. Note that when the Equation (6) is divided by $\hat{\sigma}^2 = MS_E$ the result will be similar to t -statistic's square, used to compare two means. To be more specific, when points are added to the center of 2^k design, the model that can be found is:

$$Y = \beta_0 + \sum_{j=1}^k \beta_j x_j + \sum_{i < j} \beta_{ij} x_i x_j + \sum_{j=1}^k \beta_{jj} x_j^2 + \varepsilon$$

once β_{jj} are the pure quadratic effects.

Such squares sum may be incorporated to ANOVA and may be compared to error's mean square, aiming to test pure quadratic curves. When points are added to the center of the 2^k design the matrix for curve (using equation 6) actually tests the hypotheses:

$$H_0: \sum_{j=1}^k \beta_{jj} = 0$$

$$H_1: \sum_{j=1}^k \beta_{jj} \neq 0$$

Furthermore, if the factorial design points are not replicated, n_C central point can be used in order to find an error estimation with $n_C - 1$ level of freedom. A t -test can also be used to test curves [51,52].

3. Response surface planning and methods (RSM)

Response surface methodology, or RSM, is a collection of mathematical and statistical techniques that are useful for modeling and analyzing applications in which the interest response is influenced by several variables and the target is to optimize this response. For example, think of a chemical engineer willing to find temperature degrees (x_1) and pressure

(x_2) to maximize a process' performance (y). The process performance is a function between temperature degrees and pressure, such as in:

$$Y = f(x_1, x_2) + \varepsilon$$

where ε represents the noise or the observed error in the response Y . If we denote the expected response by $E(Y) = f(x_1, x_2) = \eta$, then the surface represented by $\eta = f(x_1, x_2)$ is called "response surface".

We usually, graphically, represent "response surface" as shown on Figure 6, where η is plotted against the x_1 and x_2 levels. Such response surface plots were seen represented on a surface graph in a three dimensional environ.

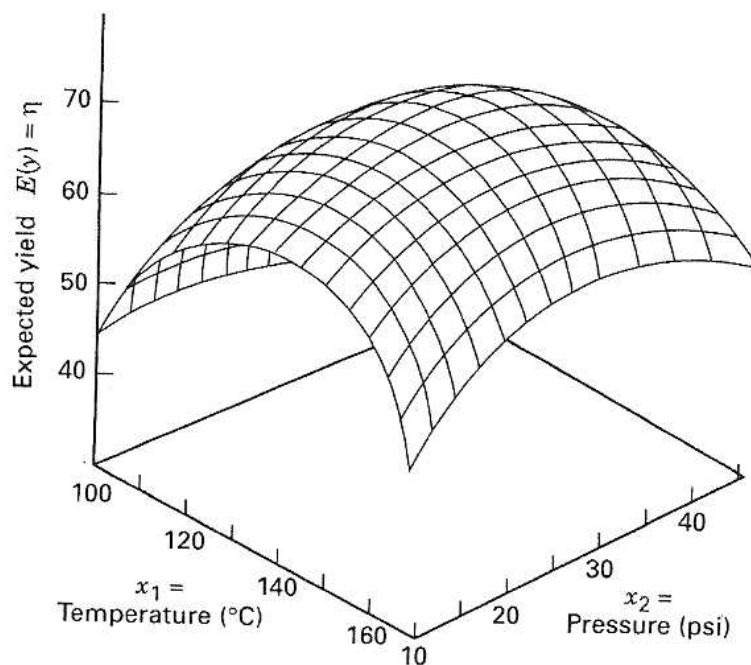

Figure 6. A three-dimensional response surface showing the expected performance (η) as a function between temperature (x_1) and pressure (x_2) [52].

Aiming to observe a response surface plot - particularly in the chapters on factorial designs - to help visualizing its shape, we often plot the response surface's contour, as shown on Figure 7. Regarding the contour's plot, constant response lines are drawn in the x_1, x_2 plane. Each contour corresponds to a response surface particular height. We have seen the utility of contours plots already.

In most of RSM problems, the relation between response and independent variables is unknown. Thus, RSM's first step means finding an adequate rapprochement to the real relationship between Y and the independent variables. Generally, a polynomial of low degree is applied to some independent variables areas. If the answer is well modeled by independent variables linear functions, then the rapprochement function will be the first-order model:

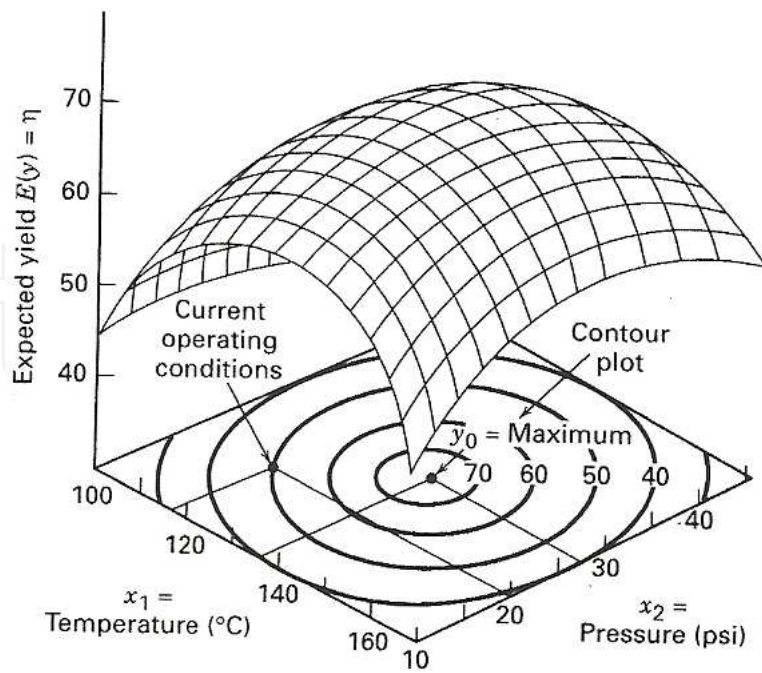

Figure 7. A contour plot of a response surface [52].

$$Y = \beta_0 + \beta_1x_1 + \beta_2x_2 + \dots + \beta_kx_k + \varepsilon \tag{7}$$

If there is curve in the system, then a higher degree polynomial must be used, such as in the second-order model:

$$Y = \beta_0 + \sum_{i=1}^k \beta_i x_i + \sum_{i=1}^k \beta_{ii} x_i^2 + \sum_{i < j} \beta_{ij} x_i x_j + \varepsilon \tag{8}$$

Almost all RSM problems use one or both of these models. Of course, it is not feasible that a polynomial model could be a reasonable rapprochement to a real functional relationship regarding the whole independent variables environ. However, regarding a relatively small area, they usually work out quite well.

The minimum squares method is used to estimate parameters to polynomial rapprochements. Response surface analysis is then performed in terms of adjusted surfaces. If the adjusted surface is an adequate rapprochement of the response’s true functions, the adjusted surfaces will be almost equivalent to the real system analysis. The model parameters can be estimated most effectively if proper experimental design is used in order to collect data. A design for adjusted response surface is called response surface design [51,52].

RSM is a sequential procedure. Often, whenever we are located on a point on a response surface far from optimum - such as the current operating conditions in Figure 8 -, there is little curving

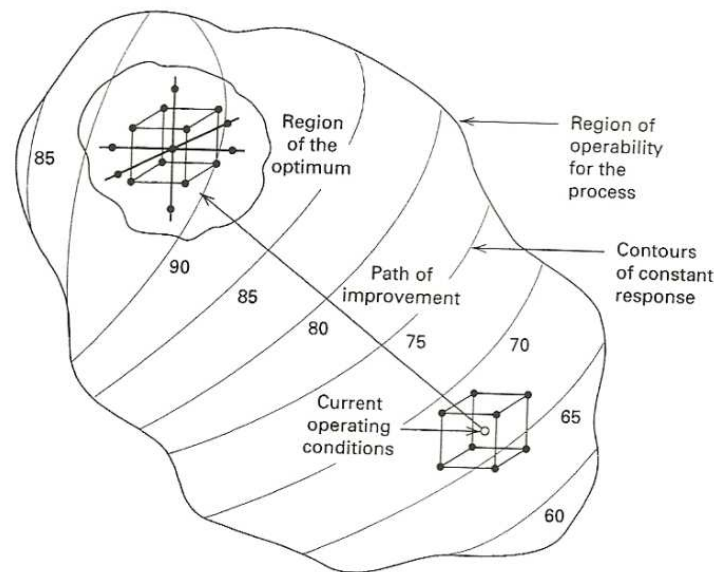

Figure 8. The sequential nature of RSM [52].

in the system and the first-order model will be appropriate. Our goal here is to fast and efficiently lead the experimentalist to optimum's surroundings. Once optimum's region has been found, a more elaborate model - such as the second-order model -, may be applied, and an analysis may be performed to locate the optimum. On Figure 8, we see that the analysis of a response surface can be seen as "climbing a hill" - the top of the hill represents the point of maximum response. If a real optimum is a point of minimum response, then we may think of it as "going down a valley".

RSM further goal dues to determine optimum operating conditions for systems far from the real optimum or to determine an area in the factorial environ, in which operating requirements are fulfilled. Also note that the word "optimum" in RSM is used in a particular sense. "Climbing a hill" RSM procedures aiming to ensure convergence only to an "optimum" place [51,52].

More extensive RSM presentations can be found in Myers and Montgomery (2002), Khuri and Cornell (1996), and Box and Draper (1987). And review paper by Myers et al. (2004) is also a useful reference.

3.1. Steepest ascent method

Frequently, optimal operating conditions initial estimation to the system will be far from real optimum. In such circumstances, the experimentalist's goal is to rapidly move to optimum's general surroundings. We wish to use a simple and economically efficient experimental procedure. When we are away from the optimum, we usually assume that a first-order model is an adequate rapprochement to the true surface in X 's small region [51,52].

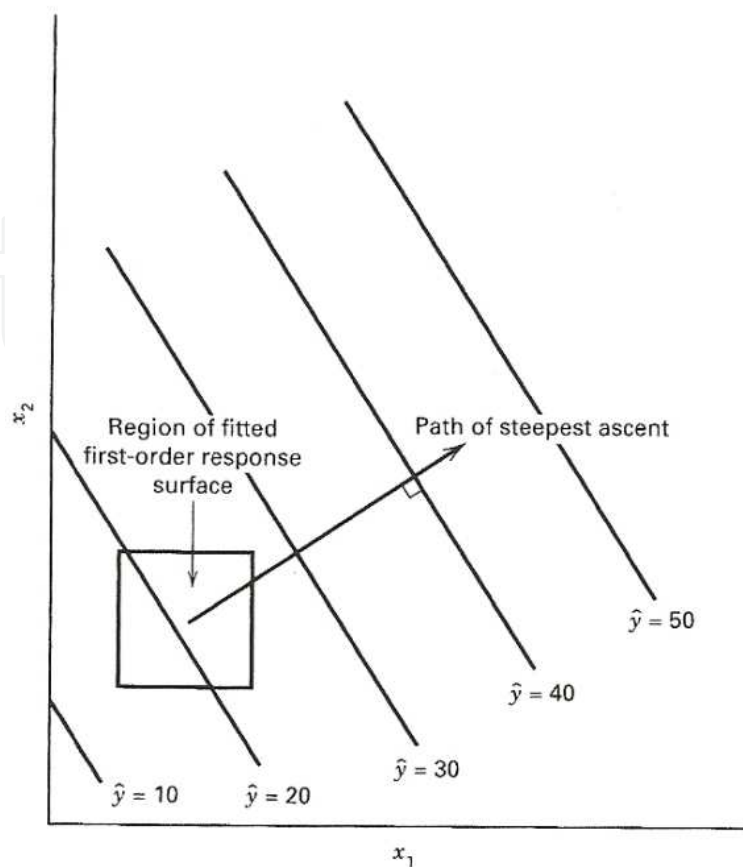

Figure 9. First-order response surface and path of steepest ascent [51,52].

The steepest ascent method is a procedure to sequentially move towards a maximum increase in the response. Of course, if minimization is desired, then we call the technique “steepest descent” method. The adjusted first-order model is:

$$\hat{y} = \hat{\beta}_0 + \sum_{i=1}^k \hat{\beta}_i x_i \quad (9)$$

and the first-order response surface, that is, \hat{y} contours, a series of parallel lines such as those shown on Figure 9. Steepest ascent direction is the one in which \hat{y} rapidly increases. The direction is normal due to adjusted response surface contours. We usually take the line that passes through the center of the interest area and that also is normal to adjusted surface contours as the steepest ascent path. So, steps taken along the path are proportional to the regression coefficients $\hat{\beta}_i$. The real step size is determined by the experimentalist, based on process knowledge or other practical considerations.

Experiments are done throughout the steepest ascent path, until no more increase is observed in the response. Then a new first-order model can be adjusted, a new direction to the steepest

ascent is determined, and the procedure continues. Eventually, the experimentalist will reach optimum's surroundings. It is usually indicated by first-order model's lack of adjustment. At this point, additional experiments are performed in order to obtain a more precise optimum estimation [51,52]

4. Experimental methods

4.1. Solvents and reagents

PHBHV (Biocycle®) was the PHA used in the current work, containing 6% HV. The used polymer had a weight average (M_w) and number average (M_n) molar masses of 294.275 and 198.168, respectively, polydispersity index (PI) of the 1,48, melting temperature of 164°C and crystallinity of 55%. The reducing agent used was sodium borohydride, NaBH₄ (Colleman) with 97% purity. Solvent chloroform was used as PA (purity >99%) and to polymer purification it was used methyl alcohol PA (Anidrol) (~96% purity). All solvents and other chemicals were used without prior purification by presenting analytical purity.

4.2. General methodology to reduce PHBHV molar mass

Reducing PHBHV molar mass was done by NaBH₄ reduction. The methodology used in the procedure was described in Montoro's, SR *et al.* work [4,6,55]

4.3. Statistical design

To optimize the conditions of the current process, we used an experimental design, which included a 2² factorial design, with high (+) and low (-) levels, three central points (average) (Table 2), resulting in seven experiments (Table 3).

Factors	Low Level (-)	Medium level (0)	High level (+)
A: NaBH ₄ concentration (%)	2	4	6
B: Temperature (°C)	50	52,5	55

Table 2. Factors and their respective control levels.

Molar mass and the polydispersity index (PI) were determined by means of Gel Permeation Chromatography (GPC) in a Waters Breeze System equipment.

5. Results and analysis

The experimental matrix for the factorial design is illustrated in Table 4. It is noteworthy that the experiments were performed randomly and an error experimental design was obtained

Experiment number	Factors	
	A	B
1	-	-
2	+	-
3	-	+
4	+	+
5	0	0
6	0	0
7	0	0

Table 3. Parameters used in the 2^k Full Factorial method.

through the mean and standard deviations on repeated central points. The use of factorial design and statistical analysis allowed expressing effectiveness of PHBHV molar mass reduction in molar mass as a linear and quadratic response that can be described as a function with significant variables.

Experiment	% NaBH ₄	Temperature (°C)	M _n (Da)	M _w (Da)	PI
1	2	50	5804	7576	1,31
2	6	50	4269	4766	1,11
3	2	55	4356	6267	1,44
4	6	55	3848	4052	1,05
5	4	52,5	4521	5190	1,15
6	4	52,5	4545	5244	1,15
7	4	52,5	2994	3920	1,30

Table 4. An experimental matrix for factorial design.

According to results expressed in Table 4 and using Statistica software, there was values regarding parameters for each effect were found (% of NaBH₄ and temperature) due to the effectiveness of PHBHV molar mass (M_n and M_w) reduction process. We conducted an analysis parameters influence, based on two responses. Therefore, it was necessary to determine which parameters influence really showed statistical significance at a 95% level, it can be observed using a Pareto diagram (Figures 10 and 11).

It can be seen that NaBH₄ concentration and temperature variables were statistically significant in response M_n (Figure 11). However, response M_w (Figure 10) showed that NaBH₄ percentage showed higher significance if compared to temperature, therefore, both parameters reached significant ranges of statistical significance, adopting 95%. It was observed that the interaction

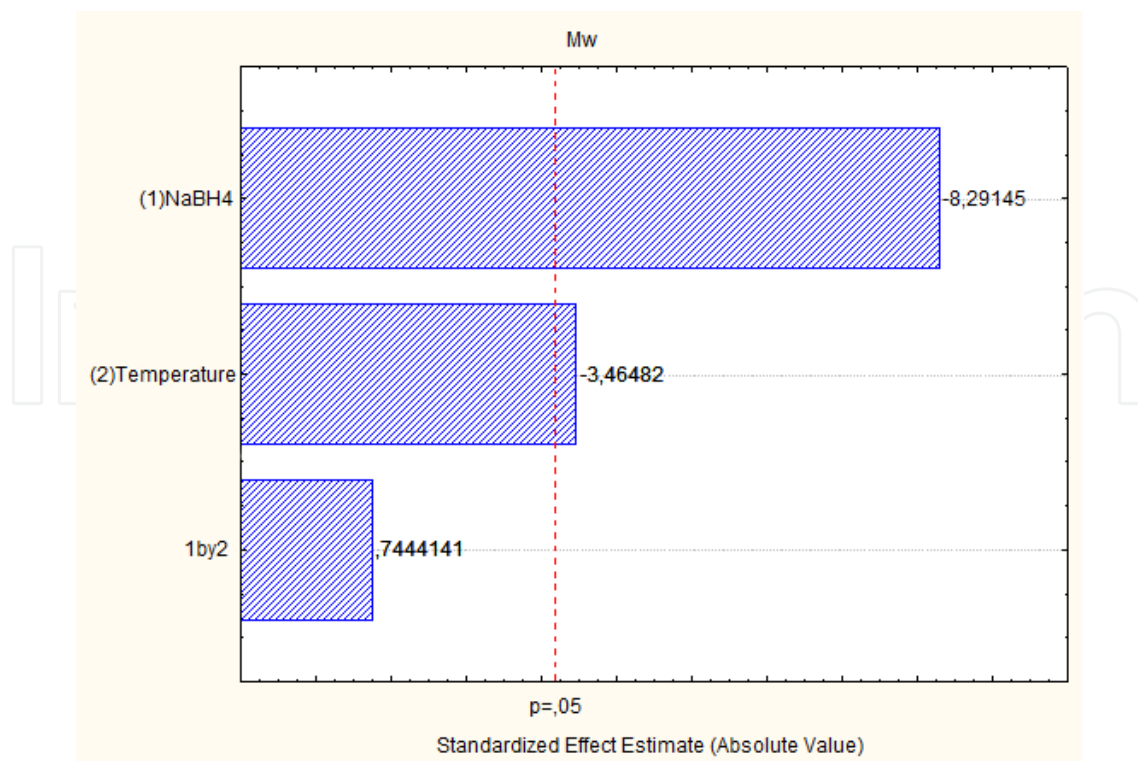

Figure 10. Pareto diagram by M_w .

between NaBH_4 variables and temperature showed no importance the PHBHV molar mass reduction process.

Data from factorial design also underwent variance and regression analysis as well as F_0 testing. It has been found - according to data presented on Table 5 - that a PHBHV molar mass reduction model presents coefficients (P -value) and satisfactory regression statistically significant at 95% confidence.

The use of RSM allows the investigation of two variables simultaneously [54] determining regions and molar mass maximum reduction. Figures 12 and 13 show, respectively, the response surface regarding M_w and M_n results, all obtained in PHBHV molar mass reduction experiments, using NaBH_4 as the reducing agent.

Results obtained by the experiments have confirmed NaBH_4 efficiency, both in reducing PHBHV molar mass and in the uniformity of splitting polymer chains, thereby generating low polydispersity index (PI) values - as presented in Table 4. Montoro *et al.* [6] also showed NaBH_4 effectiveness, in both in reducing PHBHV molar mass of PHBHV and the uniformity of splitting polymer chains, if compared to other molar mass reduction means, such as acid hydrolysis and trans-esterification with catalyzed glycols acid.

It was observed that NaBH_4 temperature and concentration parameters have strong influence on PHBHV molar mass reduction processes. The response surface analysis gotten from results (Figures 12 and 13) revealed by NaBH_4 temperature and concentration higher levels showed

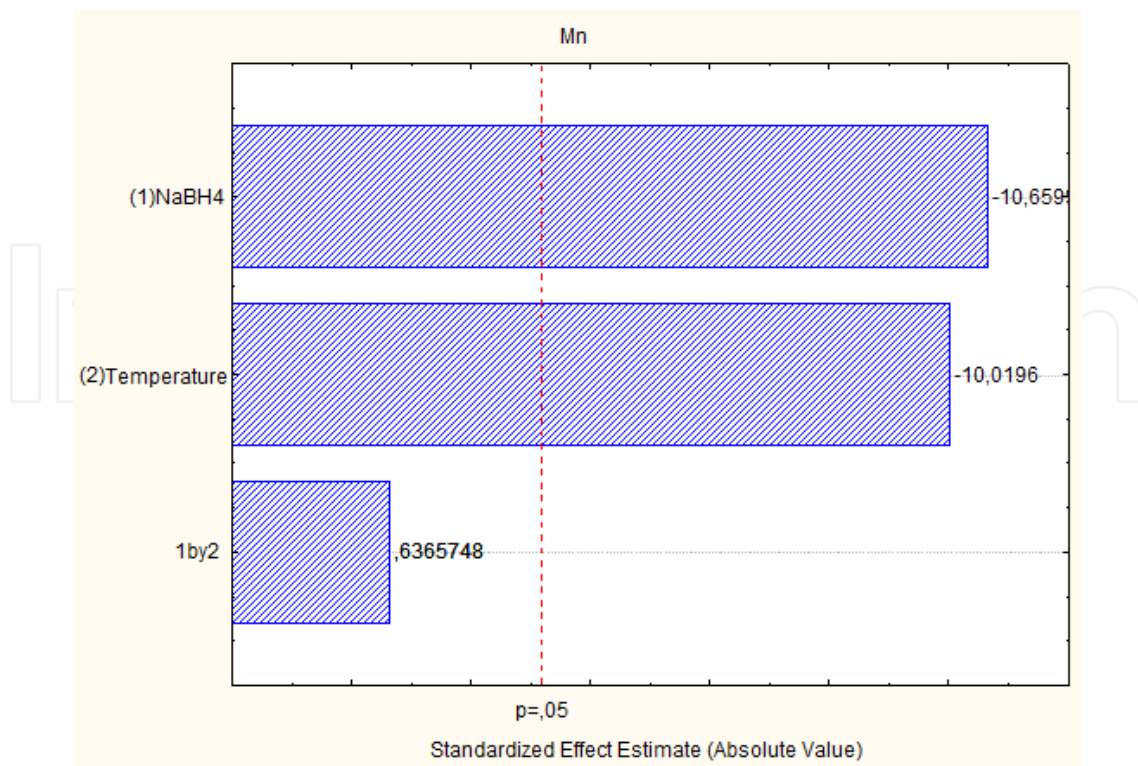

Figure 11. Pareto diagram by M_n .

	Source of Variation	Sum of Squares	Levels of Freedom	Mean Square	F_0	<i>P-Value</i>
M_n	(1) NaBH ₄	2098152	1	2098152	113,6328	0,001765
	(2) Temperature	1853682	1	1853682	100,3927	0,002116
	1 X 2	7482	1	7482	0,4052	0,569649
	Error	55393	3	18464		
	SS TOTAL	4014710	6			

	Source of Variation	Sum of Squares	Levels of Freedom	Mean Square	F_0	<i>P-Value</i>
M_w	(1) NaBH ₄	6648662	1	6648662	68,74822	0,003675
	(2) Temperature	1161006	1	1161006	12,00499	0,040498
	1 X 2	53592	1	53592	0,55415	0,510633
	Error	290131	3	96710		
	SS TOTAL	8153392	6			

Table 5. Analysis on variances for table 4 experiment.

greater reduction in PHBV molar mass. In the current study’s specific case, it was found that molar mass reduction optimization occurred in a PHBV reaction under a 55°C temperature, using 6% NaBH₄.

IntechOpen

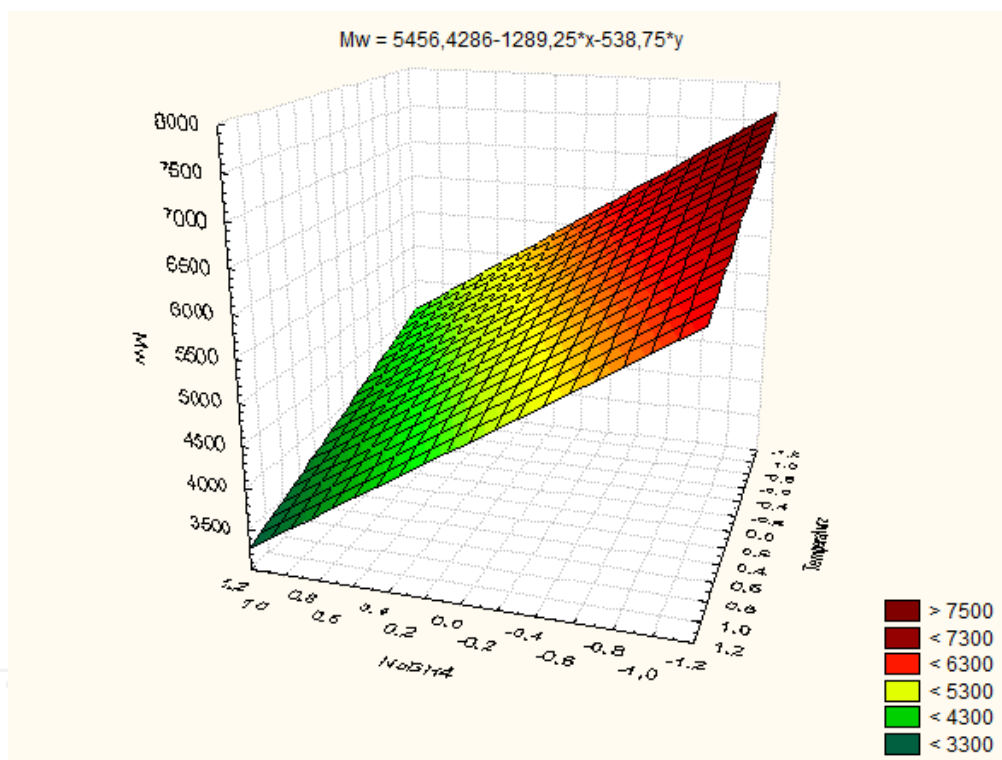

Figure 12. A three-dimensional response surface showing PHBHV molar mass reduction (M_w) as a NaBH_4 and temperature function.

IntechOpen

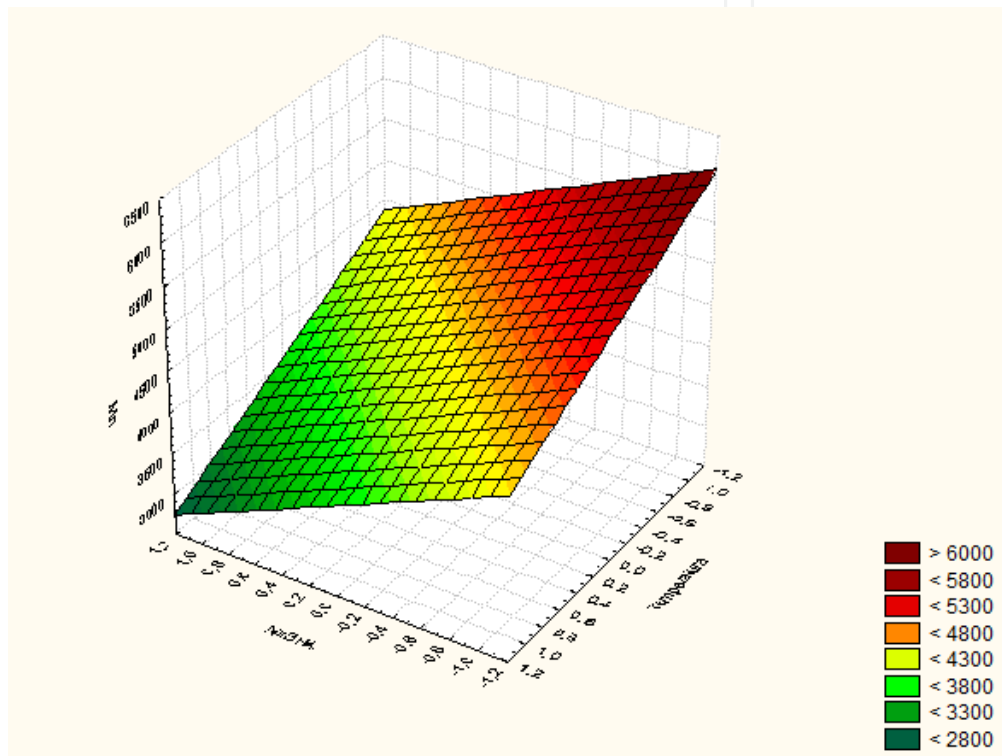

Figure 13. A three-dimensional response surface showing PHBV molar mass reduction (M_n) as a NaBH_4 and temperature function.

IntechOpen

6. Conclusion

Factorial designs are often used in experiments involving several factors where it is necessary to study the joint effect of factors on a response. However, several special cases of factorial design, in general, are important because they are widely used in research and because they form the basis for other considerable practical value's plans.

The 2^k design is particularly useful in experimental work early stages, when many factors are probably investigated. It provides the lowest number of runs in which k factors can be studied due to a complete factorial design. There are only two levels of each factor, we have to assume that the response is approximately linear in the range of chosen factors levels.

The use of RSM allows the investigation of two variables, simultaneously, thus determining regions and the maximum reduction in PHBHV molar mass.

The results obtained from the experiments have confirmed the efficiency of NaBH₄, both in reducing PHBHV molar mass of and in the uniformity of splitting polymer chains, thereby generating low polydispersity index (PI) values.

It was observed that NaBH₄ temperature and concentration parameters have strong influence on PHBHV molar mass reduction processes. The analysis of the response surface gotten from final outcomes revealed NaBH₄ temperature and concentration high levels, it increases PHBHV molar mass reduction.

Based in the 2² factorial design, ANOVA and RSM techniques, all optimized to reduce PHBHV molar mass. Regression models - the 95% confidence limit – explained data variation (*P*-Value) for M_w and M_n values. Regarding the response surface analysis, it was found that PHBHV molar mass reduction optimization happened in higher levels of temperature (55°C) and NaBH₄ concentration (6%). In general, increasing levels of temperature and NaBH₄ concentration resulted in major reductions of PHBHV molar mass.

Acknowledgements

The authors thank CNPq and FAPESP (Process 141794/2010-0 and 2010/15680-9, respectively). We thank the student Ana Valéria Freitas Maia for your collaboration in this work.

Author details

Sérgio Roberto Montoro^{1,2*}, Simone de Fátima Medeiros¹, Amilton Martins Santos¹, Messias Borges Silva¹ and Marli Luiza Tebaldi³

*Address all correspondence to: srmontoro@dequi.eel.usp.br ; montoro.sergio@gmail.com

1 Department of Chemical Engineering, Lorena Engineering School - University of São Paulo, Lorena, São Paulo, Brasil

2 UNESP - Univ Estadual Paulista, Guaratinguetá Engineering School, Department of Materials and Technology, Guaratinguetá, São Paulo, Brasil

3 Federal University of Itajubá-UNIFEI, Advanced Campus of Itabira, Minas Gerais, Brasil

References

- [1] Salehizadeh H, Van Loosdrecht MCM. Production of polyhydroxyalkanoates by mixed culture: recent trends and biotechnological importance. *Biotechnology Advances* 2004; 22, 261-279.
- [2] Sudesh K, Abe H, Doi Y. Synthesis, structure and properties of polyhydroxy alkanates: biological polyesters. *Progress in Polymer Science* 2000; 25, 1503-1555.
- [3] Chandra R, Rustgi R. Biodegradable Polymers *Progress in Polymer Science* 1998; 23:1273-1335.
- [4] Montoro S. Redução da massa molar do poli(3-hidroxibutirato-co-3-hidroxivalerato) (PHBHV) para sua posterior utilização no desenvolvimento de sistemas de liberação controlada. PhD Thesis. Engineering School of Lorena 2005.
- [5] Terada M, Marchessault M H. Determination of solubility parameters for poly(3-hydroxyalkanoates). *International Journal of Biological Macromolecules* 1999; 25(1-3) 207-215.
- [6] Montoro S R, Sordi M L T, Santos A M, Ré M I. Estudo Cinético da Redução da Massa Molar do Poli(3-Hidroxibutirato-co-3-Hidroxivalerato) (PHBHV). *Polímeros: Ciência e Tecnologia* 2010; 20(1) 19-24.
- [7] Riess G. Micellization of block copolymers. *Progress and Polymer Science* 2003; 25(8) 1107-1170.
- [8] Vidhate S, Innocentini-Mei L, Souza N A. Mechanical and Electrical Multifunctional Poly(3-hydroxybutyrate-co-3-hydroxyvalerate)-Multiwall Carbon Nanotubes Nanocomposites, *Polymer Engineering and Science* 2012; 52(6)1367-1374.
- [9] Grillo R, Pereira AES, Melo NFS, Porto RM, Feitosa LO, Tonello PS, Dias NLF, Rosa AH, Lima R, Fraceto LF. Controlled release system for ametryn using polymer microspheres: Preparation, characterization and release kinetics in water. *Journal of Hazardous Materials* 2011 186, 1645-1651.
- [10] Vergnol G, Sow H, Renard E, Haroun F, Langlois V. Multilayer approach for tuning the drug delivery from poly(3-hydroxyalkanoate)s coatings. *Reactive & Functional Polymers* 2012; 72, 260-267.
- [11] Kurth N, Renard E, Brachet F, Robic D, Guerin Ph, Bourbouze R. Poly(3-hydroxyoctanoate) containing pendant carboxylic groups for the preparation of nanoparticles aimed at drug transport and release. *Polymer* 2002; 43, 1095-1101.
- [12] Oliveira AM, Oliveira PC, Santos AM, Zanin MHA, Ré MI. Synthesis And Characterization of Thermo-Responsive Particles of Poly (Hydroxybutyrate-co-Hydroxyvalerate)-*b*-Poly(N-Isopropylacrylamide). *Brazilian Journal of Physics* 2009; 39, 217-222.

- [13] Simioni AR, Vaccari C, Re MI, Tedesco AC. PHBHV/PCL microspheres as biodegradable drug delivery systems (DDS) for photodynamic therapy (PDT). *Journal of Materials Science* 2008; 43(2) 580-585.
- [14] Poletto FS, Jäger E, Ré MI, Guterres SS, Pohlmann AR. Rate-modulating PHBHV/PCL microparticles containing weak acid model drugs. *International Journal of Pharmaceutics* 2007; 345(1) 70-80.
- [15] Shah M, Naseer M I, Choi M H, Kim M O, Yoon S C. Amphiphilic PHA-mPEG copolymeric nanocontainers for drug delivery: Preparation, characterization and in vitro evaluation. *International Journal of Pharmaceutics* 2010; 400,165 -175.
- [16] John L, Foster R. Biosynthesis, properties and potential of natural-synthetic hybrids of polyhydroxyalkanoates and polyethylene glycols. *Applied Microbiology and Biotechnology* 2007; 75,1241-1247.
- [17] Pouton C W, Akhtar S. Biosynthetic polyhydroxyalkanoates and their potential in drug delivery. *Advanced Drug Delivery Reviews* 1996; 28(1)133 -162.
- [18] Pötter M, Steinbüchel A. Poly(3-hydroxybutyrate) granule-associated proteins: impacts on poly(3-hydroxybutyrate) synthesis and degradation. *Biomacromolecules* 2005; 6(2) 552-560.
- [19] Porte H, Couarraze G. Microencapsulation processes for the manufacture of systems providing modified release of the active constituent. In: Chulia D, Delail M, Pourcelet Y. (eds) *Powder technology and pharmaceutical processes*. Elsevier Science, Amsterdam 1994; 513-543.
- [20] Benoit M A. Biodegradable Microspheres: Advances in Production Technology, In: Benita S. (ed) *Microencapsulation: Methods and Industrial Applications*. Marcel Dekker Inc., NY 1996; 35-72.
- [21] Poletto F S, Fiel L A, Donida B, Ré M I, Guterres S S, Pohlmann A R. Controlling the size of poly(hydroxybutyrate-co-hydroxyvalerate) nanoparticles prepared by emulsification-diffusion technique using ethanol as surface agent. *Colloids and Surfaces A: Physicochemical and Engineering Aspects* 2008; 324(2) 105-112.
- [22] Liechty W B, Kryscio D R, Slaughter D V, Peppas N A. *Polymers for Drug Delivery Systems*. Department of Chemical Engineering, University of Texas, Austin, Texas 78712-1062. *Annual Review of Chemical and Biomolecular Engineering* 2010; 1,149-173.
- [23] Srubar III WV, Wright ZC, Tsui A, Michel AT, Billington SL, Frank CW. Characterizing the effects of ambient aging on the mechanical and physical properties of two commercially available bacterial thermoplastics. *Polymer Degradation and Stability* 2012, 97, 1922-1929.
- [24] Gracida J, Alba J, Cardoso J, Perez-Guevara F. Studies of biodegradation of binary blends of poly(3-hydroxybutyrate-co-3-hydroxyvalerate) (PHBHV) with poly(2-hy-

- droxyethyl metacrilate) (PHEMA). *Polymer Degradation and Stability* 2004; 83, 247-253.
- [25] Wang S, Ma P, Wang R, Wang S, Zhang Y, Zhang Y. Mechanical, thermal and degradation properties of poly(d,l-lactide)/poly(hydroxybutyrate-co-hydroxyvalerate)/poly(ethyleneglycol) blend. *Polymer Degradation and Stability* 2008; 93, 1364-1369.
- [26] Shi Q, Chen C, Gao L, Jiao L, Xu H, Guo W. Physical and degradation properties of binary or ternary blends composed of poly(lactic acid), thermoplastic starch and GMA grafted POE. *Polymer Degradation and Stability* 2011; 96, 175-182.
- [27] Coelho JFJ, Góis JR, Fonseca AC, Gil MH. Modification of Poly(3-hydroxybutyrate)-co-Poly(3-hydroxyvalerate) with Natural Rubber. *Journal of Applied Polymer Science* 2010; 116: 718-726.
- [28] Lemechko P, Renard E, Guezennec J, Simon-Colin C, Langlois V. Synthesis of dextran-graft-PHBHV amphiphilic copolymer using click chemistry approach. *Reactive & Functional Polymers* 2012; 72, 487-494.
- [29] Babinot J, Renard E, Langlois V. Controlled Synthesis of Well Defined Poly(3-hydroxyalkanoate)s-based Amphiphilic Diblock Copolymers Using Click Chemistry. *Macromolecular Chemistry and Physics* 2011; 212, 278-285.
- [30] Lao HK, Renard E, Linossier I, Langlois V, Vallée-Rehel K. Modification of Poly(3-hydroxybutyrate-co-3-hydroxyvalerate) Film by Chemical Graft Copolymerization" *Biomacromolecules* 2007, 8, 416-423.
- [31] Arslan H, Yesilyurt N, Hazer B. The Synthesis of Poly(3-hydroxybutyrate)-g-poly(methylmethacrylate) Brush Type Graft Copolymers by Atom Transfer Radical Polymerization Method. *Journal of Applied Polymer Science* 2007, 106, 1742-1750.
- [32] Versace DL, Dubot P, Cenedese P, Lalevée J, Soppera O, Malval JP, Renard E, Langlois V. Natural biopolymer surface of poly(3-hydroxybutyrate-co-3-hydroxyvalerate)-photoinduced modification with triarylsulfonium salts. *Green Chemistry* 2012,14, 788-798.
- [33] Ke Y, Wang Y, Ren L, Wu G, Xue W. Surface modification of PHBV films with different functional groups: Thermal properties and in vitro degradation. *Journal of Applied Polymer Science* 2010; 118(1) 390-398.
- [34] Nguyen S, Marchessault RH. Synthesis and Properties of Graft Copolymers Based on Poly(3-hydroxybutyrate) Macromonomers. *Macromolecular Bioscience* 2004; 4, 262-268.
- [35] Koseva NS, Novakov CP, Rydz J, Kurcok P, Kowalczyk M. Synthesis of aPHB-PEG Brush Co-polymers through ATRP in a Macroinitiator-Macromonomer Feed System and Their Characterization. *Designed Monomers & Polymers* 2010; 13, 579-595.
- [36] Srubar III WV, Wright ZC, Tsui A, Michel AT, Billington SL, Frank CW. Characterizing the effects of ambient aging on the mechanical and physical properties of two

- commercially available bacterial thermoplastics. *Polymer Degradation and Stability* 2012; 97, 1922-1929.
- [37] Linhart W, Lehmann W, Siedler M, Peters F, Schilling AF, Schwarz K, Amling M, Rueger JM, Epple M. Composites of amorphous calcium phosphate and poly(hydroxybutyrate) and poly(hydroxybutyrate-co-hydroxyvalerate) for bone substitution: assessment of the biocompatibility. *Journal of Materials Science* 2006; 41, 4806-4813.
- [38] Bonartsev AP, Myshkina VL, Nikolaeva DA, Furina EK, Makhina TA, Livshits VA, Boskhomdzhiev AP, Ivanov EA, Iordanskii AL, Bonartseva GA. Biosynthesis, biodegradation, and application of poly(3-hydroxybutyrate) and its copolymers - natural polyesters produced by diazotrophic bacteria. *Communicating Current Research and Educational Topics and Trends in Applied Microbiology* 2007 (2).
- [39] Liu Q, Shyr TW, Tung CH, Liu Z, Zhan G, Zhu M, Deng B. Particular thermal properties of poly(3-hydroxybutyrate-co-3-hydroxyvalerate) oligomers. *Journal Polymer Researcher* 2012; 19(1) 1-9.
- [40] Hazer DB, Kiliçay E, Hazer B. Poly(3-hydroxyalkanoate)s: Diversification and biomedical applications A state of the art review. *Materials Science and Engineering C* 2012; 32, 637-647.
- [41] Nguyen S, YU G, Marchessault RH. Thermal degradation of poly(3-hydroxyalkanoates): preparation of well-defined oligomers. *Biomacromolecules* 2002; 3, 219-224.
- [42] Montoro SR, Tebaldi ML, Alves GM, Barboza JCS. Redução da massa molecular e funcionalização do Poli(3-Hidroxibutirato-co-3-Hidroxivalerato) (PHBHV) via hidrólise ácida e transesterificação com glicóis. *Polímeros* 2011; 21(3) 182-187.
- [43] Lauzier C, Revol JF, Debzi EM, Marchessault RH. Hydrolytic degradation of isolated poly(β -hydroxybutyrate) granules. *Polymer* 1994; 35: 4156-4162.
- [44] Spitalský Z, Lacík I, Lathová E, Janigov I, Chodák I. Controlled degradation of polyhydroxybutyrate via alcoholysis with ethylene glycol or glycerol. *Polymer Degradation and Stability* 2006; 91, 856-861.
- [45] Baran ET; Ozer N, Hasirci V. Poly(hydroxybutyrate-co-hydroxyvalerate)nanocapsules as enzyme carriers for cancer therapy: an in vivo study. *Journal of Microencapsulation* 2002; 19, 363-376.
- [46] Ashby RD, Shi F, Gross RA. Use of Poly(ethylene glycol) to Control the End Group Structure and Molecular Weight of Poly(3-hydroxybutyrate) Formed by *Alcaligenes latus* DSM 1122. *Tetrahedron* 1997; 53(45)15209-15223.
- [47] Zhang X, Yang H, Liu Q, Zheng Y, Xie H, Wang Z, I Cheng R. Synthesis and Characterization of Biodegradable Triblock Copolymers Based on Bacterial Poly[(R)-3-hydroxybutyrate] by Atom Transfer Radical Polymerization. *Journal of Polymer Science: Part A: Polymer Chemistry* 2005, 43, 4857- 4869.

- [48] Adamus G, Sikorska W, Janeczek H, Kwiecien M, Sobota M, Kowalczyk M. Novel block copolymers of atactic PHB with natural PHA for cardiovascular engineering: Synthesis and characterization. *European Polymer Journal* 2012; 48, 621-631.
- [49] Reeve MS, McCarthy SP, Gross RA. Preparation and Characterization of (R)-Poly(β -hydroxybutyrate)-Poly(ϵ -caprolactone) and (R)-Poly(3-hydroxybutyrate)-Poly(lactide) Degradable Diblock Copolymers. *Macromolecules* 1993; 26, 888-894.
- [50] Hirt TD, Neuenschwander P, Suter UW. Telechelic diols from poly[(R)-3-hydroxybutyric acid] and poly{[(R)-3-hydroxybutyric acid]-co-[(R)-3-hydroxyvaleric acid]}. *Macromolecular Chemistry and Physics* 1996; 197, 1609-1614.
- [51] Montgomery DC, Runger GC. *Estatística Aplicada e Probabilidade para Engenheiros*, 5ª ed. Rio de Janeiro: LTC; 2012.
- [52] Montgomery DC. *Design and Analysis of Experiments*, 6ª Ed. EUA: John Wiley & Sons, Inc; 2005.
- [53] Dean AM, Voss DT. *Design and Analysis of Experiments*. EUA: Springer; 1999.
- [54] Neto BB, Scarminio IS, Bruns RE. *Como Fazer Experimentos - Pesquisa e Desenvolvimento na Ciência e na Indústria*, 4ª ed. Porto Alegre: Bookman; 2010.
- [55] Montoro SR, Maia AVF, Benini KCCC, Tebaldi ML, Silva MB. 11º CBPol 2011: conference proceedings, October, 16-20, 2011, Campos do Jordão/SP-Brazil.