

We are IntechOpen, the world's leading publisher of Open Access books Built by scientists, for scientists

4,800

Open access books available

122,000

International authors and editors

135M

Downloads

Our authors are among the

154

Countries delivered to

TOP 1%

most cited scientists

12.2%

Contributors from top 500 universities



WEB OF SCIENCE™

Selection of our books indexed in the Book Citation Index
in Web of Science™ Core Collection (BKCI)

Interested in publishing with us?
Contact book.department@intechopen.com

Numbers displayed above are based on latest data collected.

For more information visit www.intechopen.com



New Scuffing Test Methods for the Determination of the Scuffing Resistance of Coated Gears

Remigiusz Michalczewski, Marek Kalbarczyk,
Michał Michalak, Witold Piekoszewski,
Marian Szczerek, Waldemar Tuszynski and
Jan Wulczynski

Additional information is available at the end of the chapter

<http://dx.doi.org/10.5772/54569>

1. Introduction

1.1. Scuffing of gear teeth

In modern machines the problems of the prevention of scuffing of the gear teeth is still very important. One of the reasons is that for many years the technique development is related to increasing the loading of the friction surfaces accompanied by decreasing their size [1]. In the case of gears, the risk of scuffing occurrence rises because of potential design and assembly mistakes, unexpected overloads, as well as extremely different speeds of the rotation of gears, because both very high speeds and very low speeds may cause scuffing [2]. The occurrence of one of the mentioned factors may lead to very serious gear failures.

Apart from the above mentioned factors, the problems of using proper lubricating oils, with high extreme-pressure (EP) properties cannot be neglected.

In gears, the surface destroyed by scuffing appears at the addendum and dedendum of the tooth. This results from the sliding speed of the meshing teeth that reaches the highest values at these places of the gear tooth.

Failures of the gear teeth flanks due to scuffing are shown in Figure 1.

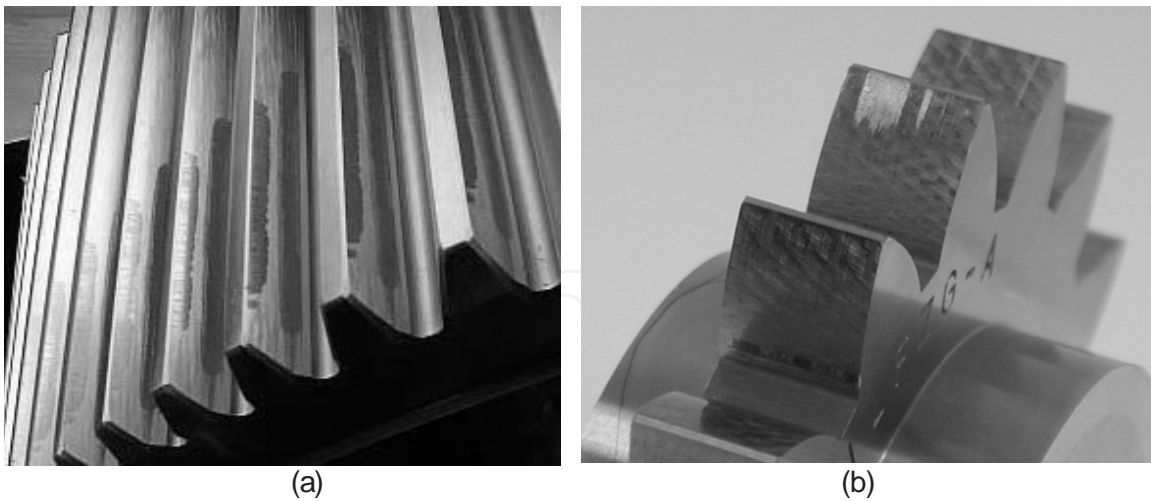

Figure 1. Photographs of failures of the gear teeth flanks due to scuffing: a) “non-symmetric” scuffing observed in gear service, resulting from the incorrect distribution of load along the tooth [3], b) scuffing on the flank of the test gear due to poor extreme-pressure (EP) properties of the tested gear oil during the gear scuffing experiments performed by the authors

Another example of scuffing of gears concerns the rudder speed brake power drive unit of a space shuttle, observed during its inspection after grounding [4]. Figure 2 a) shows the pinion and ring gear of the power drive unit of the space shuttle. Figure 2 b) presents the pinion tooth with wear at the tip and scuffing on dedendum. It was postulated that early shutdown of one of three hydraulic motors driving the gearbox could cause scuffing - in a differential gearbox, early shutdown of one motor could cause the overloading with potential for scuffing.

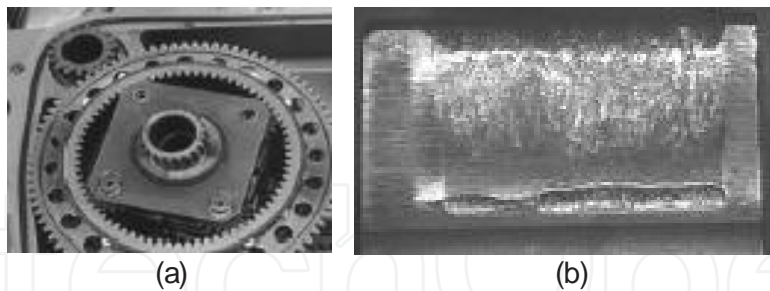

Figure 2. Photographs of the components of the rudder speed brake power drive unit of a space shuttle: a) pinion and ring gear of the power drive unit, b) damaged pinion tooth [4]

From the above example, it is absolutely apparent that the prevention of scuffing is still an important challenge, even in the high-tech sector.

1.2. Scuffing – How is it brought about?

To better understand scuffing, Figure 3 presents the interpretative models of the phenomena in different phases of this process, caused by the continuously increasing load. The models

concern the contact between two balls of the four-ball tribosystem (the rotating upper ball with one of the three stationary lower balls) during the testing of the automotive gear oils of API GL-4 and GL-5 performance levels. Such oils contain chemically active extreme-pressure (EP) lubricating additives to prevent scuffing. API GL-4 oils are used to lubricate synchronised manual transmissions of European cars and contain up to 4% of EP additives. API GL-5 oils containing up to 6.5% of EP additives are employed to lubricate automotive gears especially susceptible to scuffing, i.e. hypoid gears, in axles operating under various combinations of high-speed/shock-load and low-speed/high-torque conditions.

It should be emphasised here that a four-ball tribosystem is very often used for tribological testing of the performance of automotive gear oils.

The lower graph in Figure 3 presents the friction torque curve (M_t) obtained at continuously increasing load (P). The brackets over the graph indicate particular phases of the scuffing process. In these phases, the friction coefficient values (μ) were determined, and they are given in the red rectangles in the graph area. The thick red line below the graph denotes the time from the beginning of the run until the occurrence of the scuffing initiation reflected by a sharp rise in the friction torque.

The interpretative models of phenomena related to scuffing are presented over the graph in Figure 3. Because the models concern the contact zone between two balls of the four-ball tribosystem where the upper ball rotates and the lower ball is stationary, the direction of the movement was indicated in the upper part of the models by an arrow. If there is no arrow, the given model illustrates no movement of the balls, i.e. at the beginning of the run (before the motor of the tribotester starts).

For the phase “scuffing initiation,” the upper model in Figure 3 illustrates the surface that did not exhibit very rough topography typical of scuffing (shown in the surface topography image), while the lower one concerns the surface already destroyed by scuffing.

In the models, three characteristic zones in the wear scar surface layer were identified: a chemically modified zone through the action of the lubricating additives and the steel surface, a zone of plastic deformation, and a zone of elastic deformation. All of these zones are described in the legend above the models in Figure 3.

1.2.1. Phase: “Beginning of run”

After immersing the test balls in the tested gear oil and applying the initial load close to 0, a phenomenon known as physical adsorption or physisorption appears. In this phase, adsorbed molecules constitute the boundary layer on the friction surface, which protects the surface asperities against direct contact. The model with the heading “Beginning of run” in Figure 3 illustrates this, reflecting the situation before the start of the relative movement of the test balls.

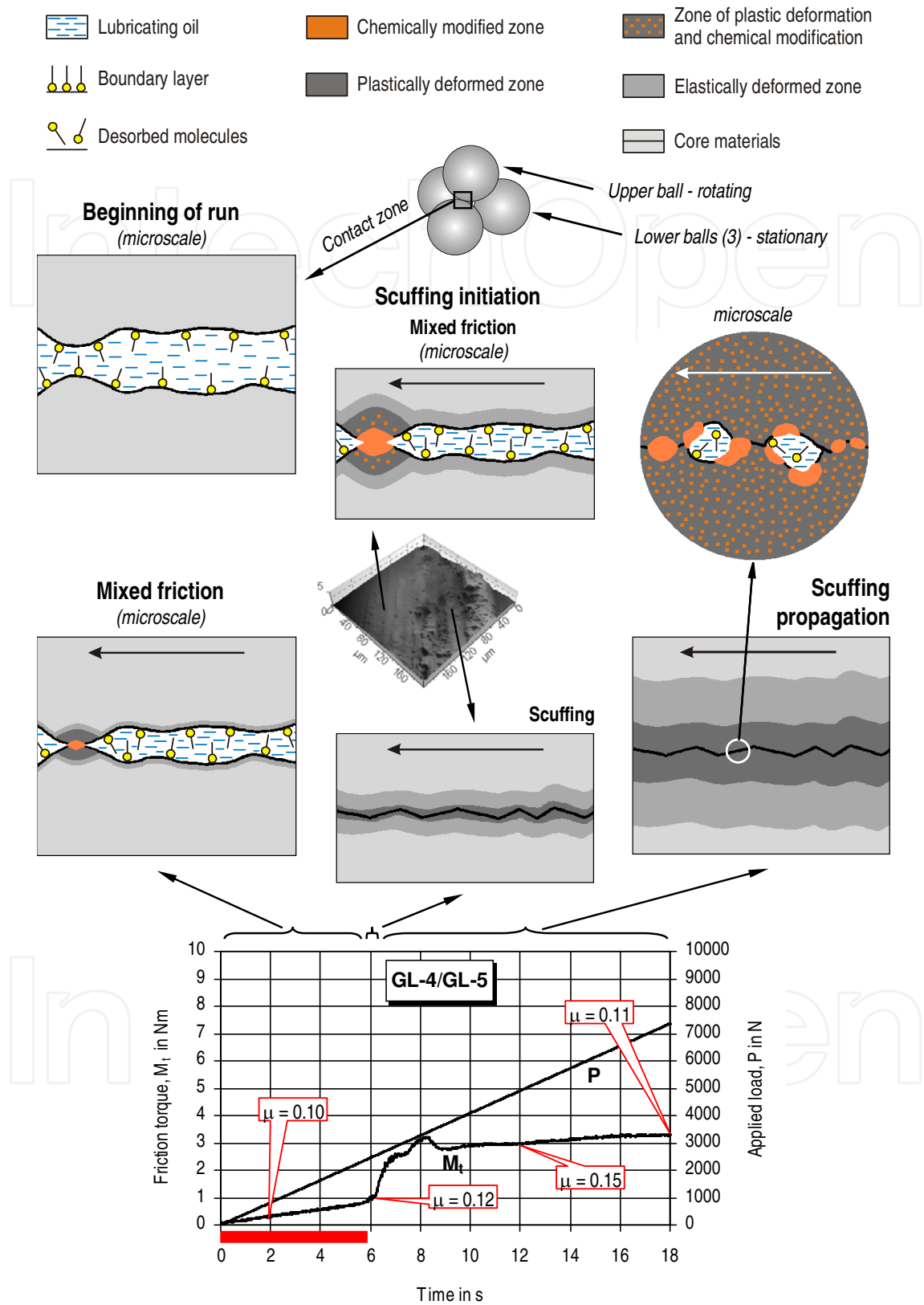

Figure 3. Models of scuffing in different phases for the automotive gear oils of the API GL-4 and GL-5 performance levels

1.2.2. Phase: "Mixed friction"

In publications, the terms "mixed friction" and "mixed lubrication" are often used equivalently and concern the same phenomena. For the purpose of this chapter, one can assume that occurrences during the regime of the mixed lubrication result in the mixed friction with its specific friction coefficient.

The phase "Mixed friction" concerns the first stage of the run from the moment of the start of the relative movement between the test balls to the scuffing initiation reflected by a sharp rise in the friction torque. Its duration is denoted by the thick red line below the graph with the friction torque (M_t) and applied load (P) - Figure 3.

In this phase the mixed friction occurs. This can be stated on the basis of the fundamental criterion that is the friction coefficient value. The friction coefficients typical of particular types of friction were adopted from the work [5], where the four-ball tribosystem was also employed. From that work, it implies that the mixed friction occurs in the four-ball tribosystem when the friction coefficient is in the range between 0.07 and 0.1. Thus, the authors determined the friction coefficient at the 2nd second of the four-ball experiment, being 0.1, denote the mixed friction.

It is worth noting here that the idea of the occurrence of the mixed friction regime (instead of EHL, i.e. elastohydrodynamic lubrication) at the very start of the relative movement between the test balls (load is close to 0) is also supported in the mentioned work [5]. From that work it is apparent that "pure" EHL occurs in the four-ball tribosystem only under conditions of a low load and high speed.

At mixed friction, the micro-EHL films mainly carry the load and the mating surfaces are protected from direct contact by the boundary layer. But at some micro-zones, due to the failure of the micro-EHL film surface, asperities locally collide, which is illustrated in the model with the heading "Mixed friction" in Figure 3.

Due to collisions of surface asperities, the temperature in the micro-contact rises. At a higher temperature, physically adsorbed molecules may be attracted to the surface with greater forces, and chemical adsorption or chemisorption appears. The decomposition of the active compounds in the lubricating additives catalyses the transformation of some chemically adsorbed molecules into chemical compounds at higher temperatures.

The collision of the surface asperities and the local high pressure of the oil induced by the approaching asperities bring about elastic (reversible) and plastic (irreversible) deformations of the contacting surface. Due to the thermal (temperature rise) and mechanical activation (plastic deformation causing surface defects), the conditions exist for the initiation of the diffusion of "active" atoms from the lubricating compounds (e.g. sulphur atoms) into the surface layer.

The described phenomena lead to the formation of inorganic chemical compounds of iron with sulphur, phosphorus, and oxygen, coming from EP lubricating additives in the tested gear oil. Such additives (based on organic S-P compounds) form e.g. iron sulphide FeS [6]. FeS compounds, apart from hampering the creation of adhesive bonds with their shear strength

being $1/5^{\text{th}}$ that of steel and their hardness being $1/4^{\text{th}}$ that of steel, facilitate shearing of the chemically modified surface asperities, and the shear plane is transferred to the thin FeS layer, which protects the surface from tearing out the material from deeper layers, reducing the wear intensity.

For the tested oil, containing EP lubricating additives, the surface asperities are covered by the protective layer of the above mentioned chemical compounds. This is illustrated in the respective model in Figure 3. Due to this, for the gear oils with EP lubricating additives, the scuffing initiation is delayed to appear at much higher loads than in the case of oils without lubricating additives (e.g. API GL-1 ones, not presented here).

1.2.3. Scuffing phase: "Scuffing initiation"

In this phase, scuffing initiates - the friction torque (M_t) sharply increases and measured friction coefficient values exceed the maximum value assumed for the mixed friction, i.e. 0.1 [5].

The scuffing initiation occurs at a load called the scuffing load, which is characteristic for each tested lubricating oil. At this load, the lubricating film collapses, the number of colliding surface asperities drastically increases, and the destruction changes its occurrence from the micro- to macro-scale and scuffing appears. Initially only part of the friction surface undergoes scuffing. It can be observed in the surface topography image of the border between the surface that did not exhibit very rough topography typical of scuffing (left side) and the surface destroyed by scuffing (right side) - Figure 3.

The described phenomena leading to scuffing are illustrated in the models with the heading "Scuffing initiation" in Figure 3. The upper model concerns the surface that did not exhibit very rough topography typical of scuffing, where still the mixed friction exists, while the lower one refers to the surface already destroyed by scuffing.

The upper model shows that the micro-scale phenomena in the zone intact by scuffing are similar to those described in the phase "Mixed friction" apart from the thickness of elastic and plastic deformations which increased due to rising load. Probably, in view of plastic deformation that causes surface defects, the reactive diffusion of "active" atoms from the EP lubricating additives (e.g. sulphur atoms) into the surface layer takes place and iron sulphides form, which is confirmed by other researchers, e.g. in the work [7]. The diffusively modified micro-zones inside the highest asperities are plastically deformed and are indicated in the respective model as orange spots - Figure 3.

By observing phenomena in the part of the friction surface that undergoes scuffing, one can indicate that the situation changes radically. The lower model illustrates that, in the first phase of scuffing, the lubricating film no longer exists, nor is there any boundary layer. This leads to a rapid intensification of the material destruction. Much plastic deformation appears, turning into the transfer, flowing and mingling of the material of the rubbing test balls. For the tested oils with EP lubricating additives, much of the surface layer starts to be chemically modified. This will be decisive for the scuffing propagation character.

1.2.4. Scuffing phase: "Scuffing propagation"

This phase refers to the scuffing process, after its initiation. It is reflected by a sharp increase in the friction torque (M_i), accompanied by a high intensity of the lower test balls wear - Figure 4 a, b). This situation is illustrated in the models with the heading "Scuffing propagation" in Figure 3.

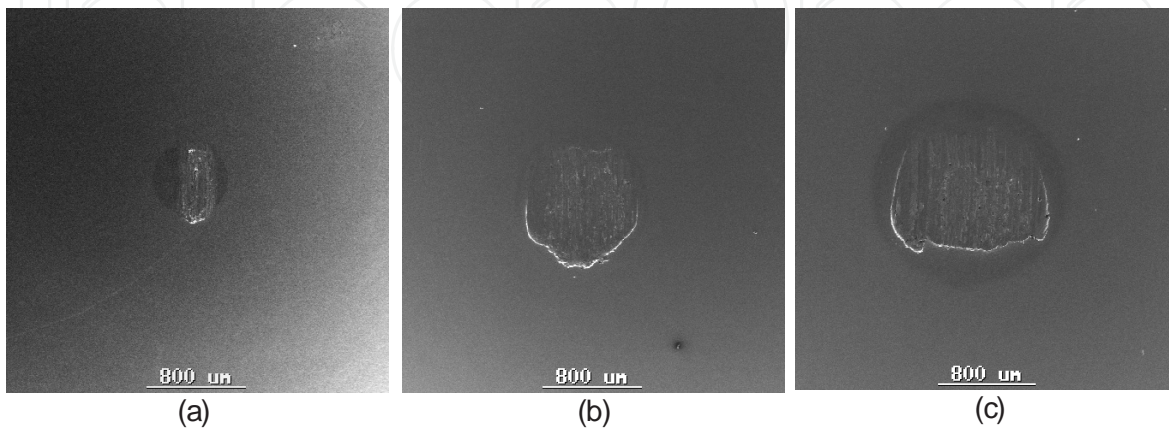

Figure 4. Development of the wear of the lower test balls due to scuffing: a) at scuffing initiation, b) at 12th seconds of the run (scuffing propagation), c) at the end of the run; images obtained at the same magnification

For the tested gear oils, after the scuffing initiation due to rapid chemical reactions of their EP additives with the surface, a rise in the friction torque is mitigated to quickly stabilise at relatively low value - Figure 3. It is accompanied by continuously evolving wear of the lower test balls that is not intensive - Figure 4 b, c). A drop in the pressure in the contact zone due to wear, brings about the possibility of oil introduction into the contact zone and the regeneration of the boundary layer on much of the friction surface. Such an action is indicated by the friction coefficient within the range 0.11 to 0.15, typical of boundary friction. On the basis of the work [5], which also concerns four-ball experiments, it was assumed that the boundary friction occurs in the four-ball tribosystem when the friction coefficient is in the range between 0.09 and 0.15. The determined values of the friction coefficient being in the middle and upper limit typical of boundary friction denote that some part of the friction surface must have undergone scuffing; It can be assumed from [5] that "full scuffing" occurs when the friction coefficient exceeds 0.3. The specific state of the surface layer in this phase is called the "Secondary Boundary Layer" (SBL) in the work [8]. The round model in the micro-scale concerning the scuffing propagation (Figure 3) illustrates the places of oil appearance in the contact zone. Let us call them "the micro-pockets." One can presume that inside the oil micro-pockets the following phenomena take place: the intensive adsorption and desorption of the base oil and lubricating additives molecules on/from the steel surface, chemical reactions of the lubricating additives with the surface, and - in view of plastic deformation that causes surface defects - the diffusion of "active" atoms from the lubricating compounds (e.g. sulphur atoms) into the surface layer. In view of the transfer and mingling of the material of the rubbing test balls, the chemically modified zones appear across the entire zone of plastic deformations - orange spots.

For the API GL-4 and GL-5 gear oils, the effective chemical modification of the surface mitigates the increase of the wear scar diameter - Figure 4 b, c) - in the phase of the SBL formation, accompanied by a mitigated rise in the friction torque and a decreasing friction coefficient (Figure 3).

1.3. Gear tests of scuffing

Nowadays, two manners of the improvement of the resistance to scuffing of gears are in use in the world. One is focused on the improvement of extreme-pressure (EP) properties of gear oils. The other one is related to the improvement of the properties of gear materials, e.g. by the deposition of thin hard coatings onto the tooth flank surface.

The verification of the quality of gear oils and new techniques of surface engineering of the tooth surface of gears requires that gear testing should be used. The most known is a unique complex of gear test methods developed in the Gear Research Center (FZG) at the Technical University of Munich. Approximately, 500 FZG gear test rigs are used around the world [9].

The most often used and popular gear tests for lubricating oils are performed using the FZG A/8.3/90 scuffing test method. Unfortunately, this method makes it impossible to differentiate between gear oils having very good extreme-pressure (EP) properties, from the point of view of the resistance to gear scuffing [10]. This is why various scientific centres have developed their own test methods [10-13].

Recognising the problem of the low resolution of A/8.3/90 scuffing test, the FZG has developed two new scuffing methods denoted as A10/16.6R/90 and S-A10/16.6R/90 (S - *shock*). The new test methods are described in detail in the literature, e.g. [14-19]. They are carried out under much severer conditions compared to the A/8.3/90 test. This is a result of the reduced face width of the small gear (pinion), doubling rotational speed, and reversing the direction of rotation. Additionally, according to the S-A10/16.6R/90 method, the test is started at once with a load at which the failure is expected, hence the name "scuffing shock test." Shock loading prevents the test gears from running-in and in turn increases their susceptibility to scuffing, which further increases the method resolution.

Nowadays, one of the research directions in numerous scientific centres in the world is an improvement in the scuffing resistance of toothed gears, achievable by the deposition of thin, hard, low-friction coatings onto the gear teeth, e.g. the a-C:H:W or MoS₂/Ti coatings [20-22]. For the last several years, intensive research work has also been performed on this subject in the Tribology Department of ITeE-PIB. Until now, the FZG A/8.3/90 gear scuffing test method has been used most often in various scientific centres, which, like in the case of testing gear oils, exhibits a resolution that is too low to differentiate between the coated gears from the point of view of their resistance to scuffing [23-25] - Figure 5. It should be explained here that a-C:H:W and a-C:H coatings are DLC (diamond-like carbon) coatings, and the a-C:H:W coating has an outermost DLC layer doped with W (tungsten).

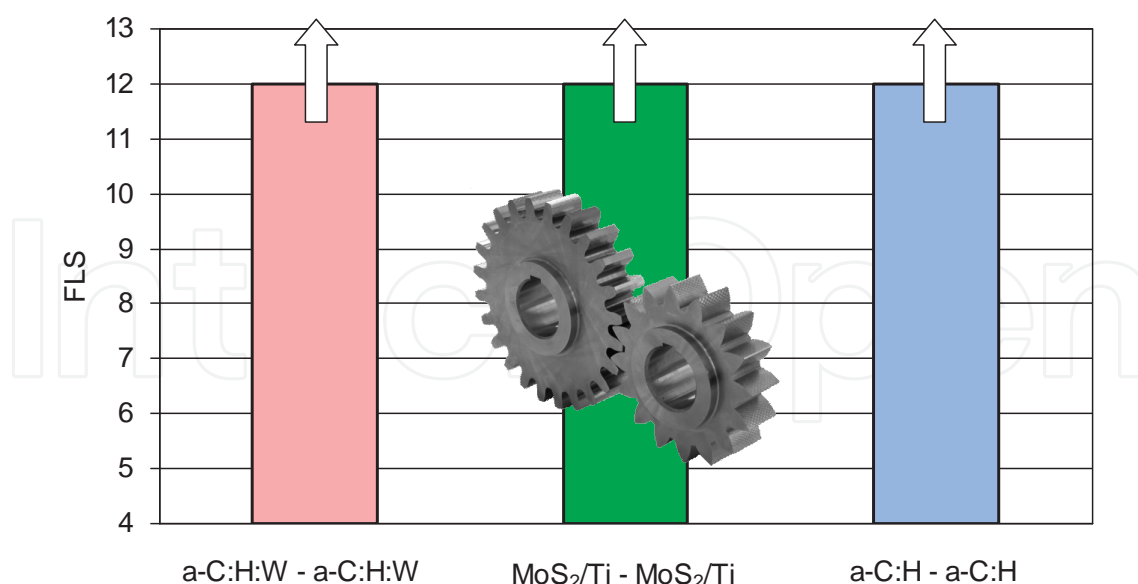

Figure 5. Failure load stages (FLS) obtained for the tested coatings (both gears coated) - FZG A/8.3/90 test method; data compiled from [23-25]

It is apparent from Figure 5 that the failure load stages (FLS), indicating the gear resistance to scuffing exceed the maximum number 12, so that it is impossible to differentiate between the coated gears using the FZG A/8.3/90 test method.

To solve this problem, in the Tribology Department of ITeE-PIB, research was undertaken to apply the new FZG scuffing tests for coated gears to differentiate between their resistance to scuffing. Because the FZG test methods are dedicated exclusively to lubricating oils, their application for testing coated gears required introducing significant modifications - unique test methods have been developed, being the subject of this chapter. They are called the "Gear Scuffing EP Test for Coatings" and "Gear Scuffing Shock Test for Coatings."

2. New test methods

2.1. Idea of the methods

The main difference between the test methods designed by the authors and the gear scuffing tests A10/16.6R/90 and S-A10/16.6R/90, developed by FZG, is a rise in the initial oil temperature to 120 °C, adoption of a failure criterion related to wear of the wheel (big gear), and resigning from the criterion of invalidation of the test results when wear of the wheel exceeds 20 mg.

The tests are performed on a pair of lubricated test gears with a coating (it can be applied on one or both the gears) at a constant rotational speed, and at the initial temperature of the lubricating oil identical for all the runs - until a failure load stage (FLS) is determined, i.e., such a load at which at least one of the failure criteria is met. In the Gear Scuffing EP Test for Coatings, based on the FZG S-A10/16.6R/90 test, the load is increased stepwise, from the lowest

to the highest value. According to the Gear Scuffing Shock Test for Coatings, based on the FZG S-A10/16.6R/90 test the load is not increased in stages from the lowest value, but the expected failure load is applied to an unused gear flank (hence, the name “shock test”). In the shock test, each change of the load requires an unused gear flank; therefore, before subsequent runs, the test gears should be disassembled and reversed or replaced with new ones.

Although the authors have introduced some significant changes to the FZG gear scuffing tests, the core procedures of performing the tests are the same as in the FZG tests, and they can be found in the relevant publications, e.g. in [14].

To better explain the differences between the “old” FZG gear scuffing test A/8.3/90 and the new test methods designed by the authors, the test conditions according to each method and the failure criteria are specified in Table 1.

After starting the run, the oil in the test chamber is heated by the heaters and friction. The oil temperature is allowed to rise freely. No cooling system is used in the tests.

Like in the FZG gear scuffing tests, if the failures are observed only within 1 mm from the tooth addendum, they are only scratches, or the failures are so small that the original criss-cross-grinding pattern (Figure 6) is still intact, they should be neglected when calculating the total area of the failures.

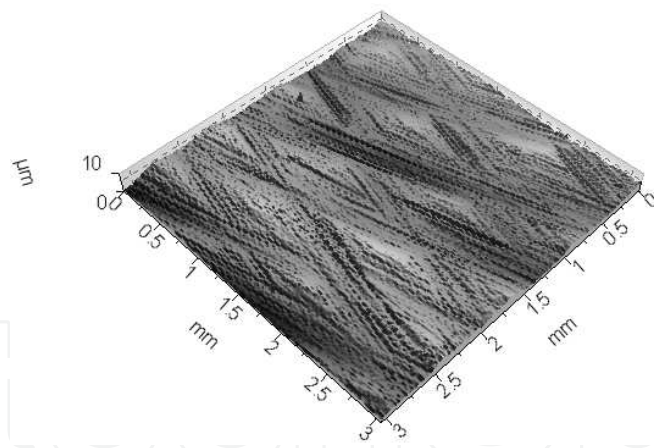

Figure 6. Original criss-cross-grinding pattern on the test gear teeth - stylus profilometry image

The failure load stage (FLS) is the main measure of the resistance of the test gears to scuffing. According to the Gear Scuffing EP Test for Coatings, the FLS is such a load at which the main failure criterion specified in Table 1 has been met. According to the Gear Scuffing Shock Test for Coatings, the FLS is such a load at which at least one of the failure criteria has been met and, when at the load stage lower by 1, neither of the failure criteria has been met.

When there is significant decohesion of the coating due to poor adhesion to the surface, the run should be invalidated.

	Gear scuffing test FZG A/8.3/90	Gear Scuffing EP Test for Coatings based on FZG A10/16.6R/90	Gear Scuffing Shock Test for Coatings based on FZG S-A10/16.6R/90
Purpose of test	Testing lubricating oils	Testing coatings deposited on gears	Testing coatings deposited on gears
Test gear type	FZG A-type (pinion and wheel width 20 mm)	FZG A10-type (pinion width 10 mm, wheel width 20 mm)	FZG A10-type (pinion width 10 mm, wheel width 20 mm)
Test materials	20MnCr5	20MnCr5, but at least one gear coated	20MnCr5, but at least one gear coated
Motor rotational speed	1500 rpm	3000 rpm	3000 rpm
Circumferential speed	8.3 m/s	16.6 m/s	16.6 m/s
Direction of motor rotation	"Normal"	"Reversed" (R)	"Reversed" (R)
Run duration	15 min.	7 min. 30 s	7 min. 30 s
Maximum load stage	12	10	12
Maximum loading torque	535 N·m	373 N·m	535 N·m
Maximum Hertzian pressure	1.8 GPa	2.2 GPa	2.6 GPa
Loading type	Stepwise, from load stage 1	Stepwise, from load stage 1	Shock (i.e. starting with a load at which the failure is expected)
Initial lubricating oil temperature	90 °C	120 °C	120 °C
Temperature stabilisation during the run by cooling	No	No	No
Type of lubrication	Dip lubrication	Dip lubrication	Dip lubrication
Main failure criterion for FLS determination	$A_p \geq$ area of one pinion tooth (≈ 200 mm^2) ^a	$A_p >$ area of one pinion tooth ($\approx 100 \text{ mm}^2$)	$A_p >$ area of one pinion tooth ($\approx 100 \text{ mm}^2$), or $W_w >$ 200 mg ^b
Additional criteria of failure assessment	None	Failures on the pinion teeth	Failures on the pinion teeth
Criterion of invalidation of the run	None	Significant decohesion of the coating	Significant decohesion of the coating

^a A_p - total area of failures on the pinion

^b W_w - wear (mass loss) of the wheel

Table 1. Comparison of the FZG gear scuffing test and the methods designed by the authors

After run completion at a given load stage, the failures on the pinion teeth should be noted using the symbols from Table 2. These data are used for additional failure assessment, complementarily to FLS.

Mode of wear	Symbol	Appearance
Polishing	W	
Scratches	R	
Scoring	B	
Scuffing	Z	

Table 2. Modes of wear of the test pinion (small gear)

Polishing can be identified when the “mirror-like” surface on the tooth flank is observed with the disappearing criss-cross-grinding pattern shown in Figure 6.

Scratches appear as shorter or longer fine lines in the sliding direction of the tooth flanks.

Scoring marks run in the same direction as scratches. On the basis of CEC L-07-95 standard [26], it can be adopted that they occur singly or in zones as light, medium or deep grooves continuing towards the tip of the tooth and having a rougher appearance than the criss-cross-grinding pattern (Figure 6).

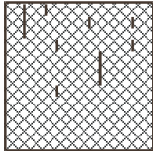
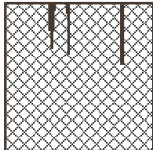
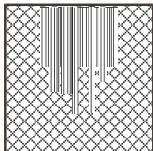
Scuffing marks occur as single, fine marks or strips, or areas covering a part or all of the flank width. According to CEC L-07-95 standard, they appear as dull areas with the roughness much greater than the original criss-cross-grinding pattern shown in Figure 6. In this case, the grinding pattern is no longer visible.

The difference between scuffing and scoring is that scuffing originates from the adhesive bond creation between the mating surfaces, which are then sheared, and scoring results from mechanical abrasion of the surface by the very hard wear particles under conditions of a very high load. Like scuffing, scoring is one of the most dangerous modes of gear wear.

When both test gears are uncoated, a respective standardised test method A10/16.6R/90 or S-A10/16.6R/90, developed by FZG should be used. However, to compare the results with the new test methods, it is necessary to start a run at the initial oil temperature of 120 °C rather than 90 °C.

2.2. Test gears

A photograph of the FZG A10 scuffing test gears employed in the tests according to the developed methods is shown in Figure 7.



Figure 7. Photograph of the FZG A10 scuffing test gears

The A10 test gears are made of 20MnCr5 steel. They are carburized, case hardened, tempered and Maag criss-cross ground. The surface hardness is HRC = 60 + 2 and the case hardness depth (CHD) is 0.6 to 0.9 mm (Eht). The effective face width of the pinion is 10 mm, and the wheel is 20 mm. The number of pinion teeth is 16, and wheel 24. The gears are identical to the ones used to perform tests according to the FZG A10/16.6R/90 and S-A10/16.6R/90 methods.

2.3. Test equipment

For the complex testing of gears, a back-to-back gear test rig, denoted as T-12U, was designed in the Tribology Department of ITeE-PIB in Radom. Its photograph is presented in Figure 8 and kinematic schemes are presented in Figure 9.

The T-12U test rig is equipped with a control-measuring system, which consists of measuring transducers (thermocouple, speed transducer) and the controller (Figure 8).



Figure 8. Photograph of the T-12U gear test rig

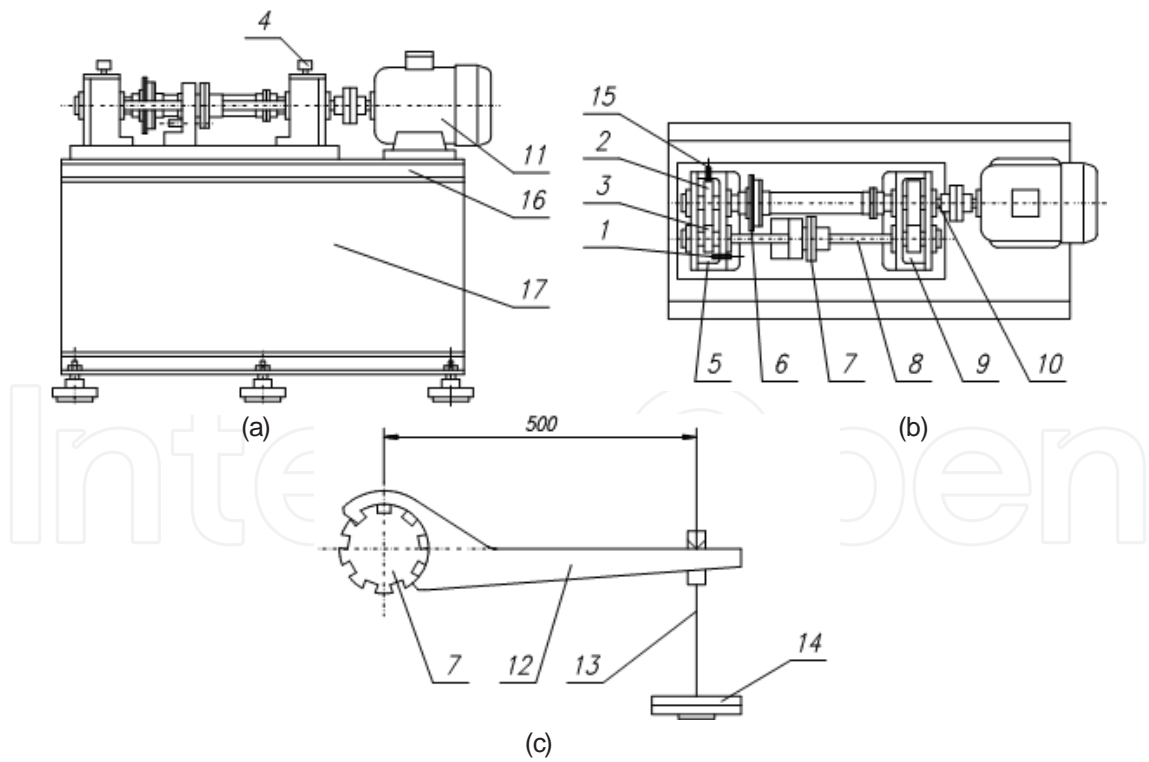

Figure 9. Kinematic schemes of the T-12U gear test rig: a) front view, b) top view, c) loading equipment; 1 - thermocouple, 2 - test wheel, 3 - test pinion, 4 - vent, 5 - test chamber, 6 - shafts torsion angle indicator, 7 - load clutch, 8 - front shaft, 9 - slave chamber, 10 - drive clutch, 11 - electric motor, 12 - loading lever, 13 - weight hanger, 14 - weights, 15 - heaters, 16 - frame, 17 - concrete base

During runs, the following quantities are measured: rotational speed, lubricating oil temperature, motor current load, time, and the number of motor revolutions. The measured values are displayed on the controller.

The test rig is mounted on the concrete base equipped with vibration-dumping feet.

The T-12U gear test rig is a back-to-back rig (Figure 9) where the test gears (2) and (3), located in the test chamber (5), are connected by two shafts to the slave gears, located in the chamber (9). The front shaft (8) has two parts. Between them there is the load clutch (7). To apply the loading torque between the meshing gears, before the run, one part of the shaft (the left part of the front shaft (8) is fixed to the base with the lock-pin via the clutch and its support. A round-shaped loading lever (12) is placed on the right part of the clutch (7), and then the weight hanger (13) is suspended and the appropriate number weights (14) put on it. They give a static loading torque by twisting the shafts, which is measured indirectly using the torsion angle indicator (6). When the load has been applied, the two halves of the clutch (7) are firmly fixed against each other with the bolts. Then, the lock-pin is removed to close the safety cover. During the run, this loading torque “circulates” between the gears. In the back-to-back solution the motor (11) must overcome only the friction between gears, rolling bearings, and some minor components of friction (friction against seals, internal friction in the oil). Thus, the whole design is very simple and compact.

An AC squirrel-cage motor (11) of the nominal rotational speed of 3000 rpm is used to drive the rig. It is controlled by the frequency converter, which enables to change the rotational speed within a wide range.

In the gear scuffing tests the test gears are dip lubricated. In the test chamber where the test gears are located, there are heaters (15) to heat up the lubricating oil. The thermocouple (1), with the measuring point inserted in the lubricating oil, is to measure the oil temperature. A PID regulator is used to protect against overheating of the lubricating oil.

The motor (11) of the machine is automatically stopped when the preset time elapses. The required time is set on the controller panel. Additionally, the operator can read out the number of motor revolutions to confirm the correct duration of the run. The number of motor revolutions is displayed on the controller panel (Figure 8) connected to the speed transducer.

In the T-12U machine, the friction torque can be measured indirectly by measurement of the motor current load, which can be assumed to be proportional to the friction torque.

The test rig has a special support on the side cover of the test chamber (5) for mounting vibration transducers (accelerometers) to enable the operator to monitor the level of vibrations along different axes. However, now there is no possibility to automatically stop the motor when the vibration level is very high. This feature (together with other features like direct measurement of the friction torque) will be included in a new test rig, denoted as T-12UF, being developed at present.

Additional equipment includes a mass comparator for a very precise determination of the mass loss (wear) of the wheel.

2.4. Test materials

The gears coated with the low-friction a-C:H:W coating (trade name: WC/C) of DLC type and composite low-friction MoS₂/Ti coating (trade name: MoST) were tested. All material combinations were tested: coating-coating (both gears coated), coating-steel, steel-coating, and steel-steel for reference (both gears without the coating). In all cases, mineral, automotive gear oil of API GL-5 performance level and of SAE 80W-90-viscosity grade was used for lubrication.

2.5. Statistical analysis

To check statistical differences between the results obtained (FLS values), the uncertainty of measurement was assessed for the both developed test methods. This was done according to the procedures specified in the document EA-4/16 G:2003, which are binding in the accredited laboratories meeting the requirements of ISO/IEC 17025:2005.

Once the uncertainty of measurement has been calculated, the test result “y” and the uncertainty of measurement “U” should be reported as “y ± U.”

As a normal practice, the uncertainty of measurement is given in relation to the average value of the measurement. For example, in the case of the gear scuffing shock tests, the respective formula derived by the authors is expressed as follows:

$$U = 0.45 + 0.06 * FLS \quad (1)$$

where:

U - uncertainty of measurement,

FLS - failure load stage.

According to ILAC-G8:03/2009, if the uncertainty intervals expressed by U do not overlap each other, one can say that the compared results are statistically different.

3. Results and discussion

3.1. Gear Scuffing EP Test for Coatings

3.1.1. Material combinations with the a-C:H:W coating

Failure load stages (FLS) obtained for the tested material combinations with the a-C:H:W coating are presented in Figure 10. The coated gear is dark grey coloured, and the uncoated one is light grey.

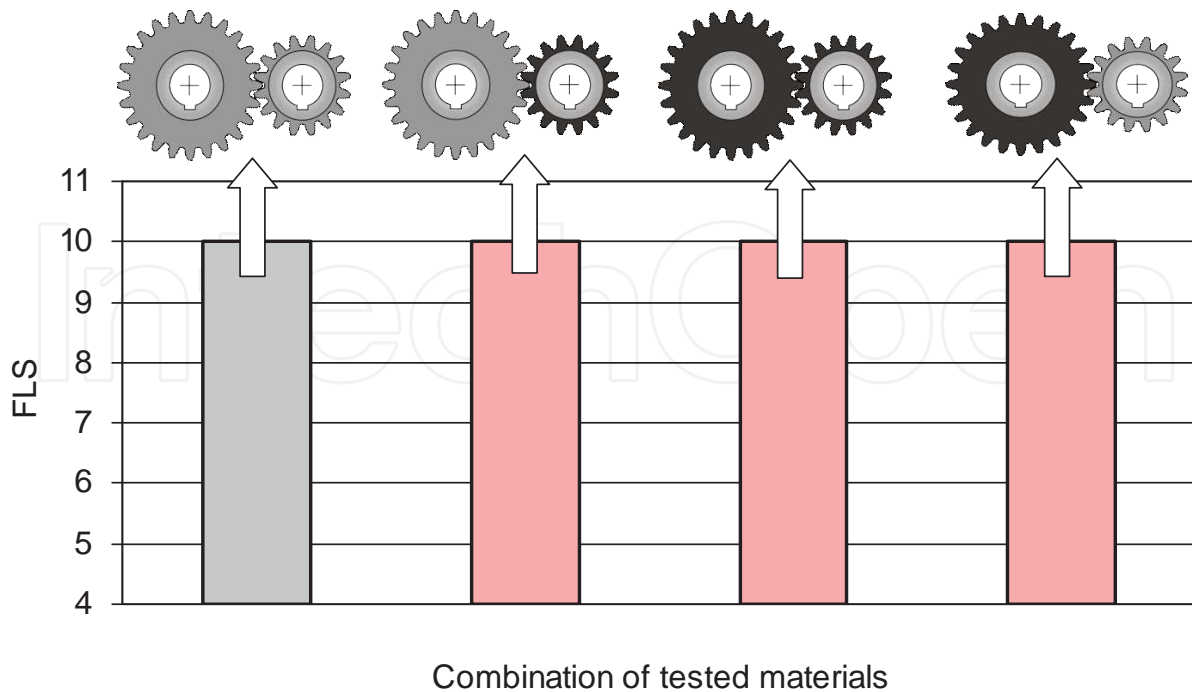
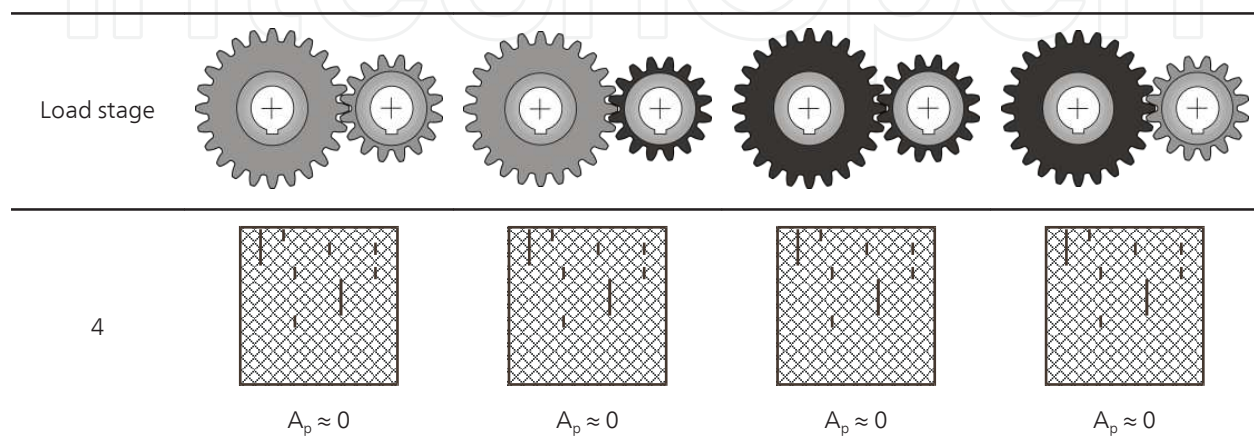

Figure 10. Failure load stages (FLS) obtained using the Gear Scuffing EP Test for Coatings for the tested material combinations with the a-C:H:W coating

Figure 10 shows that the Gear Scuffing EP Test for Coatings is unable to differentiate between the tested material combinations from the point of view of the main criterion - FLS. All the FLS values exceed the maximum load stage, i.e. 10th. Thus, the additional criteria of failure assessment, related to the wear of the pinion after runs at particular load stages, were taken into account - Table 3. The table presents the symbolic modes of the wear of the test pinion at particular load stages for the tested material combinations with the a-C:H:W coating, and the mode of wear that appeared most often on the pinion teeth was considered. Below are the symbols of the wear modes, the total area of failures on the pinion (A_p) are given. The used symbols of wear were presented earlier in Table 2.



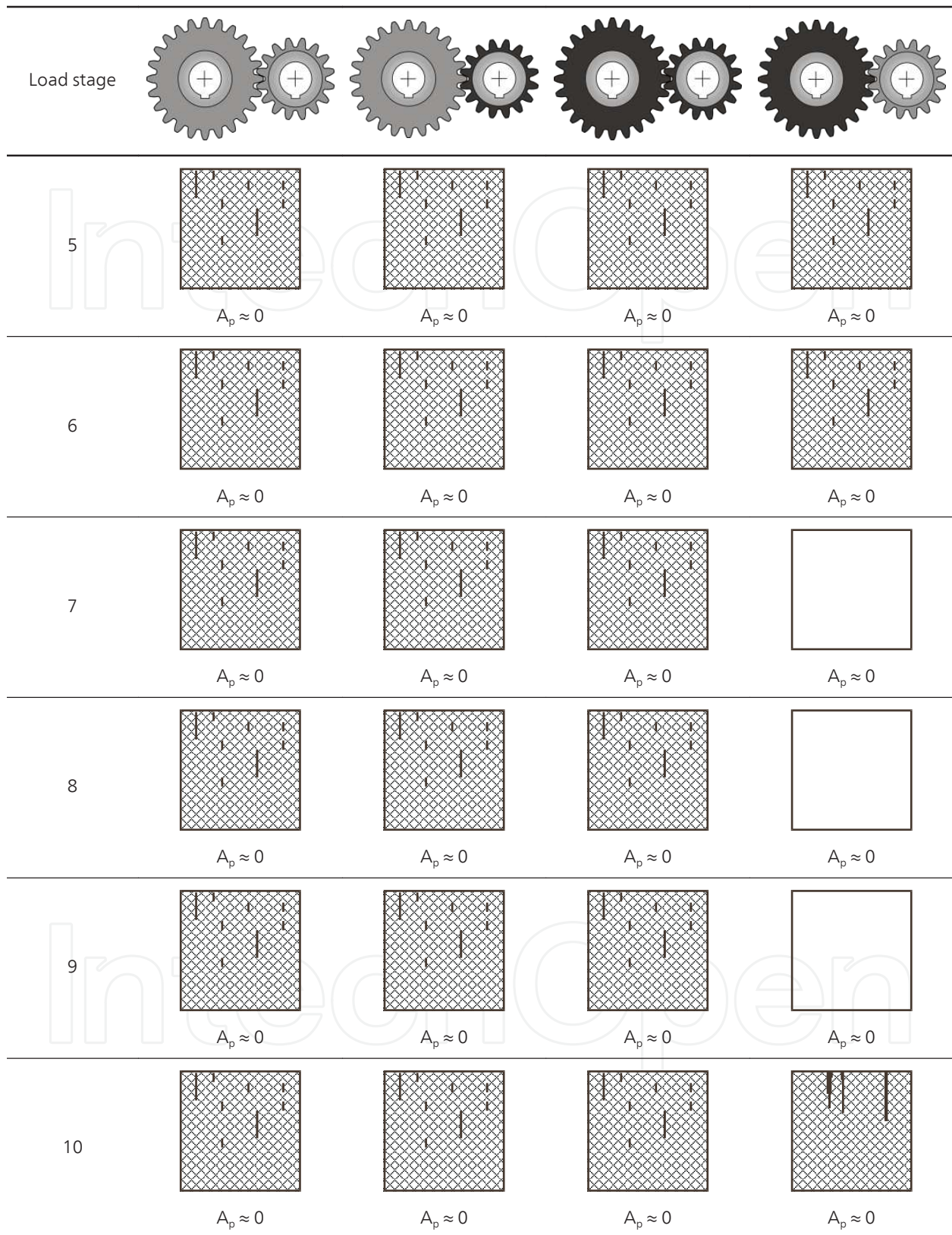

Table 3. Modes of the wear of the test pinion at particular load stages for the tested material combinations with the a-C:H:W coating, together with the total area of failures on the pinion (A_p); Gear Scuffing EP Test for Coatings

As can be observed in Table 3 for the tested material combinations, the three modes of wear that appear most often on the pinion teeth are scratches, polishing, and scoring. The uncoated pinion undergoes the process of polishing through the rubbing by the hard a-C:H:W coating deposited on the meshing wheel. Similar action was observed on the uncoated wheel meshing the coated pinion (results not shown here). The role of such polishing is to be explained in further experiments planned by the authors.

To sum up this part of the experiment, the Gear Scuffing EP Test for Coatings gives minor differences between the tested material combinations with the a-C:H:W coating, observed only when the pinion is uncoated and the wheel is coated. From the point of view of the practical applications of the a-C:H:W coating in gears, the situation when the both gears are coated seems to be better than in the case of one of the gears uncoated, because it is exposed to the abrasive action of the meshing coated gear, which results in polishing and scoring.

3.1.2. Material combinations with the MoS₂/Ti coating

Failure load stages (FLS) obtained for the tested material combinations with the MoS₂/Ti coating are presented in Figure 11. The coated gear is dark grey coloured, and the uncoated one is light grey.

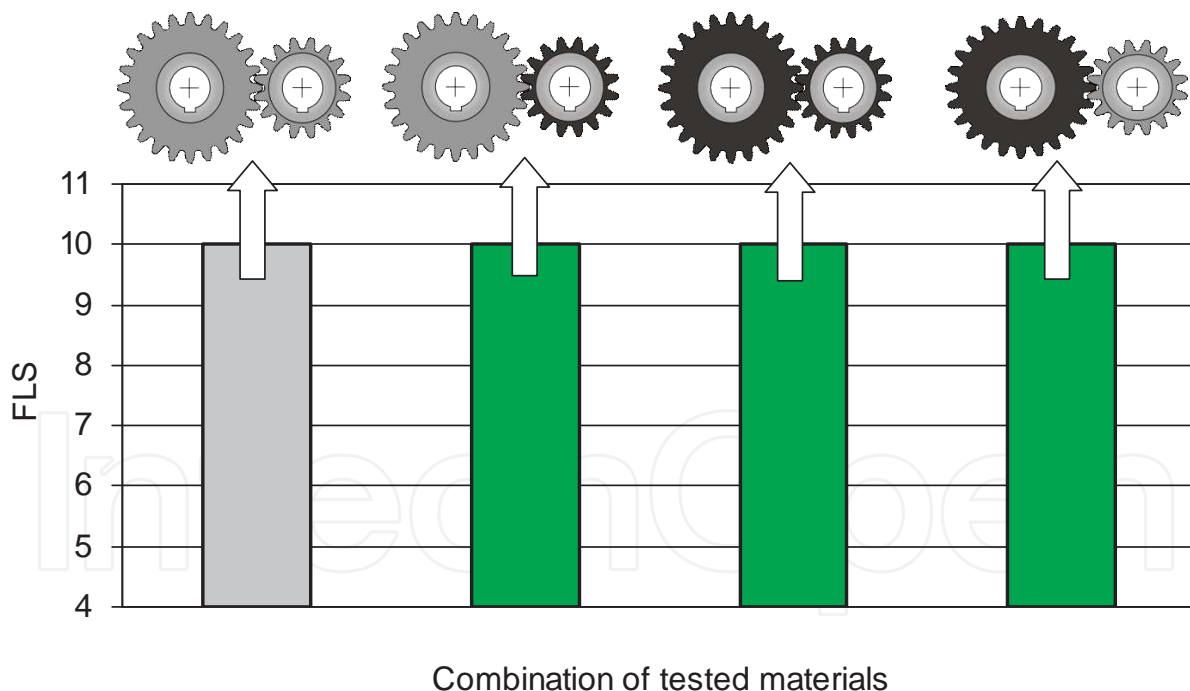
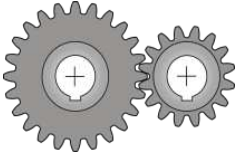
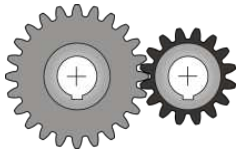
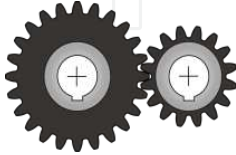
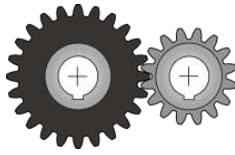
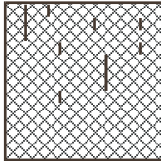
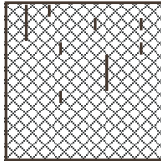
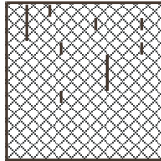
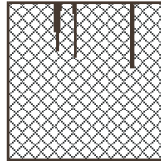
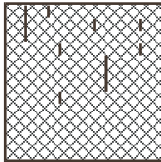
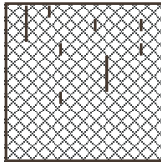
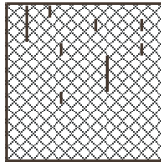
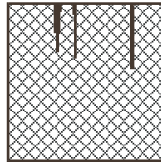
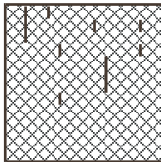
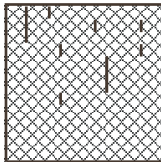
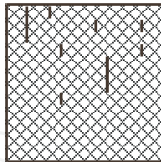
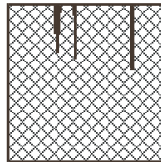
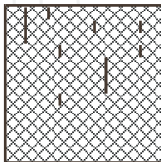
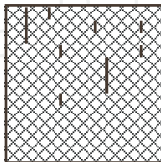
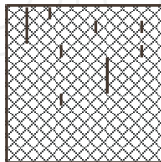
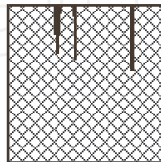
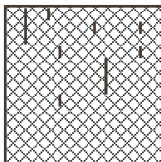
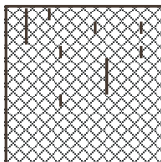
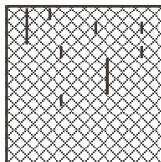
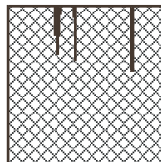

Figure 11. Failure load stages (FLS) obtained using the Gear Scuffing EP Test for Coatings for the tested material combinations with the MoS₂/Ti coating

Figure 11 shows that the Gear Scuffing EP Test for Coatings is unable to differentiate between the tested material combinations from the point of view of the main criterion - FLS. As in the case of testing the a-C:H:W coating, all the FLS values exceed the maximum load

stage, i.e. 10th. Thus, the additional criteria of failure assessment, related to the wear of the pinion after runs at particular load stages, were taken into account - Table 4. The table presents the symbolic modes of the wear of the test pinion at particular load stages for the tested material combinations with the MoS₂/Ti coating, which is the mode of wear that appeared most often on the pinion teeth was considered. Below are the symbols of the wear modes, and the total area of failures on the pinion (A_p) are given. The used symbols of wear were presented earlier in Table 2.

Load stage				
4	 $A_p \approx 0$	 $A_p \approx 0$	 $A_p \approx 0$	 $A_p \approx 0$
5	 $A_p \approx 0$	 $A_p \approx 0$	 $A_p \approx 0$	 $A_p \approx 0$
6	 $A_p \approx 0$	 $A_p \approx 0$	 $A_p \approx 0$	 $A_p = 5 \text{ mm}^2$
7	 $A_p \approx 0$	 $A_p \approx 0$	 $A_p \approx 0$	 $A_p = 10 \text{ mm}^2$
8	 $A_p \approx 0$	 $A_p \approx 0$	 $A_p \approx 0$	 $A_p = 10 \text{ mm}^2$

Load stage				
9	 $A_p \approx 0$	 $A_p \approx 0$	 $A_p \approx 0$	 $A_p = 10 \text{ mm}^2$
10	 $A_p \approx 0$	 $A_p \approx 0$	 $A_p \approx 0$	 $A_p = 10 \text{ mm}^2$

Table 4. Modes of the wear of the test pinion at particular load stages for the tested material combinations with the MoS₂/Ti coating, together with the total area of failures on the pinion (A_p); Gear Scuffing EP Test for Coatings

As can be observed in Table 4 for the tested material combinations, the two modes of wear that appear most often on the pinion teeth are scratches and scoring. In the material combination of the uncoated pinion meshing the coated wheel, the pinion bears the mark of scoring caused by the rubbing by the hard coating deposited on the meshing wheel.

Thus, the Gear Scuffing EP Test for Coatings gives minor differences between the tested material combinations with the MoS₂/Ti coating, observed only when the pinion is uncoated and the wheel is coated. From the point of view of the practical applications of the MoS₂/Ti coating in gears, the situation when the both gears are coated seems to be better than in the case of one of the gears uncoated as it is exposed to the abrasive action of the meshing coated gear, which results in scoring. However, when one of the gears needs to remain uncoated, using the a-C:H:W coating is more preferable than MoS₂/Ti, because a-C:H:W causes less wear of the uncoated gear.

3.2. Gear scuffing shock test for coatings

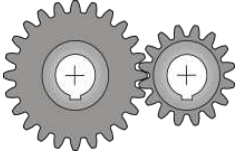
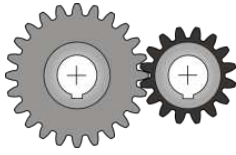
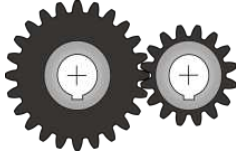
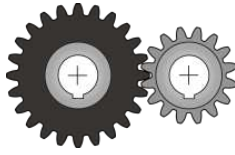
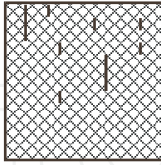
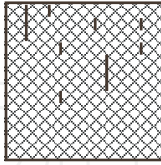
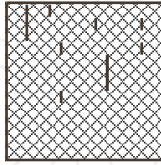
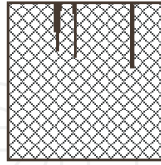
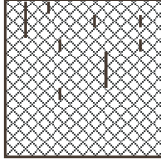
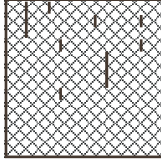
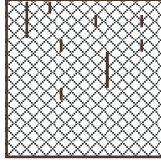
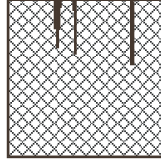
3.2.1. Material combinations with the a-C:H:W coating

Failure load stages (FLS) obtained for the tested material combinations with the a-C:H:W coating are presented in Figure 12. The coated gear is dark grey coloured, and the uncoated one is light grey. The assessed uncertainties of measurement for each result obtained are also shown in the Figure.

Figure 12 shows that the Gear Scuffing Shock Test for Coatings makes it possible to differentiate between the tested material combinations. The best resistance to scuffing (highest FLS) is observed when both gears are coated.

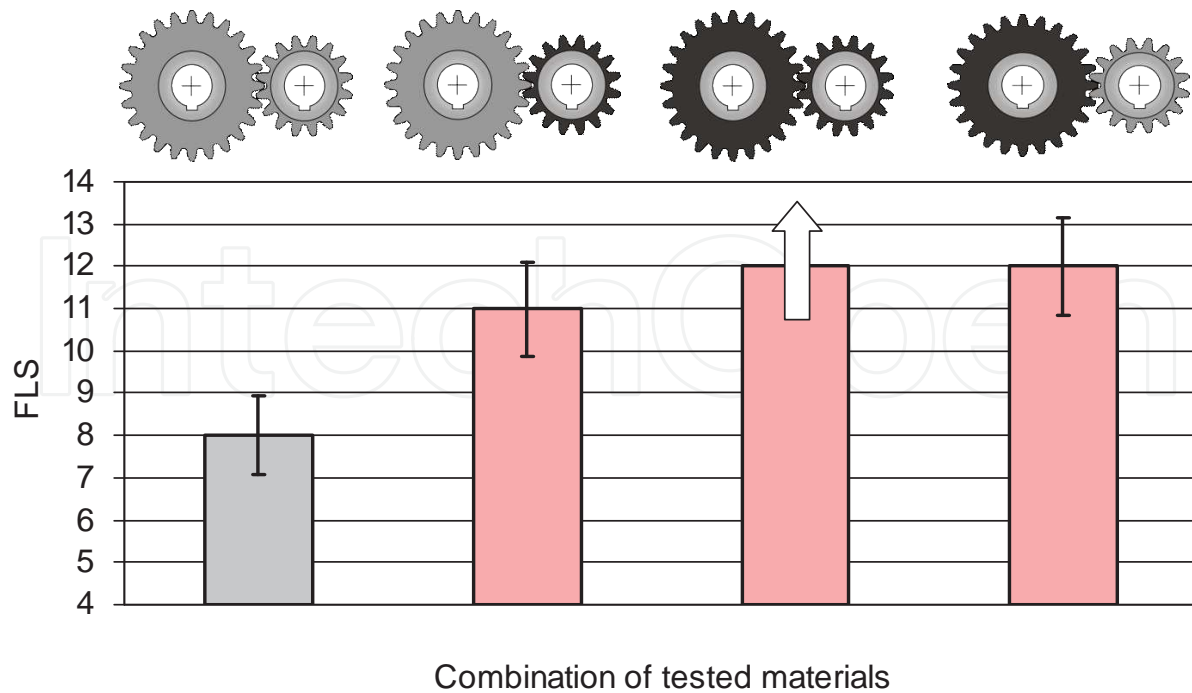

Figure 12. Failure load stages (FLS) obtained using the Gear Scuffing Shock Test for Coatings for the tested material combinations with the a-C:H:W coating

Under “shock” conditions, when the pinion is uncoated and the wheel is coated with the a-C:H:W coating, the resistance to scuffing is slightly higher than in the case when the pinion is coated and the wheel is uncoated. Hypothetically, there is a transfer of graphite (solid lubricant) from the a-C:H:W coated gear to the teeth of the uncoated one, which is more effective for the wheel coated than in the opposite situation, because the area of the coated steel surface of the wheel (larger gear with 24 teeth) is greater than in the case the coating is deposited on the pinion (small gear having only 16 teeth). However, one must have in mind that the difference in the scuffing resistance of the two material combinations is not statistically significant, because the measurement uncertainties overlap each other.

In comparison to the case of the both gears uncoated, when the a-C:H:W coating is deposited on one or two gears, much higher resistance to scuffing is observed. This is a result of a high surface energy for metals (here for steel) promoting adhesive bonding in the steel-steel contact, and smaller affinity in the different materials than when both of them are identical (i.e. steel-steel), which protects the surface from adhesive bonding. Yet another phenomenon can be attributed to it. When one of the mating materials (coating) is much harder than the other one (steel), or when two very hard materials are in contact (coating-coating) there is a reduction in the tendency to adhesive bonding, hence scuffing.

The additional criteria of failure assessment, related to the wear of the pinion after runs at particular load stages, were also taken into account - Table 5. The table presents the symbolic modes of the wear of the test pinion at particular load stages for the tested material combinations with the a-C:H:W coating, which is the mode of wear that appeared most often on the

pinion teeth was taken into account. The photographs of the most often appearing mode of wear of the pinion at the highest load stage are shown also shown in the table. Red-shadowed cells in the table denote the failure load stage (FLS). Below are given the symbols of the wear modes, the total area of failures on the pinion (A_p), and wear of wheel (W_w). The used symbols of wear were presented earlier in Table 2.

As can be observed in Table 5 for the tested material combinations, the three modes of wear that appear most often on the pinion teeth are scratches, scuffing, and scoring. When one or both gears are a-C:H:W-coated, only scratches and scoring predominate on the pinion teeth.

What was observed also during the Gear Scuffing EP Test for Coatings, and what seems to be typical of “the action” of the a-C:H:W coating, the uncoated gear undergoes the process of polishing or scoring through the rubbing by the hard coating deposited on the meshing gear. The polishing on the wheel teeth flanks can be seen in Figure 13.

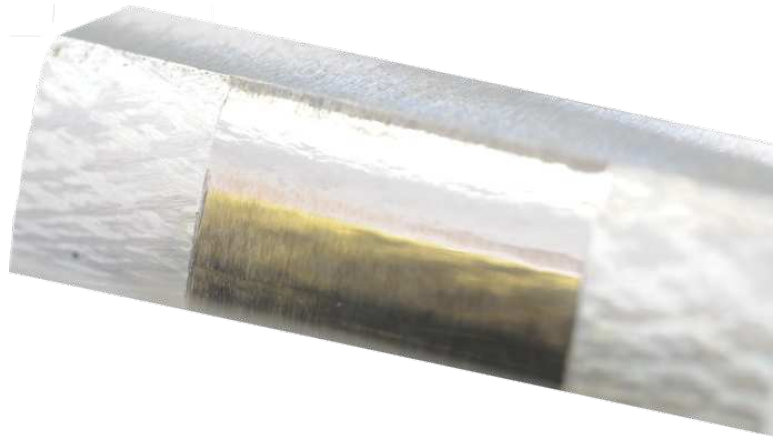
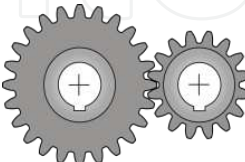
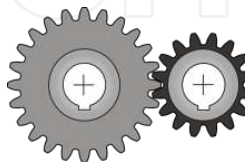
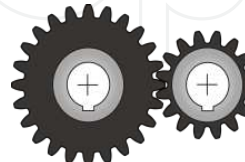
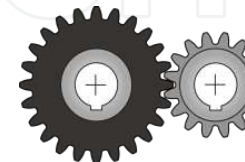
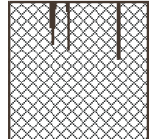

Figure 13. Photograph of the tooth flank of the uncoated wheel, polished by the a-C:H:W-coated pinion; Gear Scuffing Shock Test for Coatings

	IntechOpen			
Load stage				
7	 $A_p = 26 \text{ mm}^2$ $W_w = 1 \text{ mg}$			

Load stage			
8	 $A_p = 703 \text{ mm}^2$ W_w - not measured		
9			
10		 $A_p \approx 0$ $W_w = 180 \text{ mg}$	
11	 $A_p \approx 0$ $W_w = 338 \text{ mg}$	 $A_p = 5 \text{ mm}^2$ $W_w = 76 \text{ mg}$	 $A_p \approx 0$ $W_w = 2 \text{ mg}$
12		 $A_p = 6 \text{ mm}^2$ $W_w = 145 \text{ mg}$	 $A_p = 318 \text{ mm}^2$ $W_w = 3 \text{ mg}$

Table 5. Modes of the wear of the test pinion at particular load stages for the tested material combinations with the a-C:H:W coating, together with the total area of failures on the pinion (A_p), and wear of wheel (W_w), obtained in the Gear Scuffing Shock Test for Coatings; red-shadowed cells - the failure load stage (FLS)

Scuffing is observed only when both gears are uncoated - Table 5. This is one of the most dangerous modes of gear wear. As mentioned earlier, scuffing marks occur as single, fine marks or strips, or areas covering a part or all of the flank width. They appear as dull areas with the roughness much greater than the original criss-cross-grinding pattern shown in Figure 6. In this case, the grinding pattern is no longer visible.

To sum up this part of the experiment, the Gear Scuffing Shock Test for Coatings gives a much better resolution than the Gear Scuffing EP Test. However, one needs to have in mind that the cost of the former is about four-times higher than in the case of the latter, because the “shock tests” require more test gears to be used. From the point of view of the practical applications of the a-C:H:W coating in gears, the situation when the both gears are coated seems to be better than in the case of one of the gears uncoated, because it is exposed to the abrasive action of the meshing coated gear, which results in polishing or scoring. This positively verifies the observations taken during performing the Gear Scuffing EP Test for Coatings.

3.2.2. Material combinations with the MoS₂/Ti coating

Failure load stages (FLS) obtained for the tested material combinations with the MoS₂/Ti coating are presented in Figure 14.

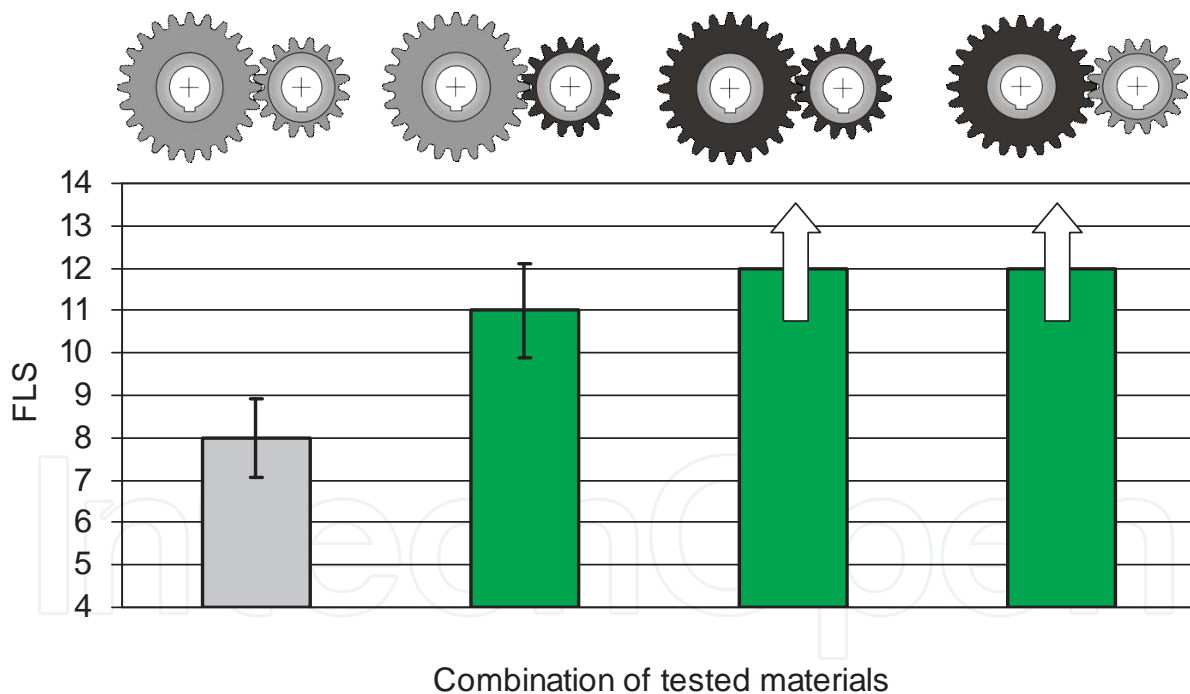

Figure 14. Failure load stages (FLS) obtained using the Gear Scuffing Shock Test for Coatings for the tested material combinations with the MoS₂/Ti coating

Figure 14 shows that the best resistance to scuffing (highest FLS) is observed when both gears are coated with the MoS₂/Ti coating, or when the uncoated pinion meshes the coated wheel.

As in the case of the a-C:H:W coating, when only the wheel is MoS₂/Ti-coated, under “shock” conditions the resistance to scuffing is higher than in the situation when only the pinion coated.

Hypothetically, there is a transfer of MoS_2 (solid lubricant) from the teeth of the coated gear to the uncoated one. The transfer is more effective in the case of the MoS_2/Ti -coated wheel meshing the uncoated pinion than in the opposite situation, because the area of the coated steel surface of the larger gear (wheel) is greater than in the case when the coating is deposited on the small gear (pinion).

In comparison to the case when both gears are uncoated, a much higher resistance to scuffing is observed when the MoS_2/Ti coating is deposited on one or two gears. The respective mechanisms of this behaviour were described earlier.

Table 6 presents the symbolic modes of wear of the test pinion at particular load stages for the tested material combinations with the MoS_2/Ti coating. As in the case of the a-C:H:W coating, the mode of wear that appeared most often on the pinion teeth was taken into account. The photographs of the most often appearing mode of wear of the pinion at the highest load stage are also shown in the table. Red-shadowed cells in the table denote the failure load stage (FLS). Below are given the symbols of the wear modes, the total area of failures on the pinion (A_p) and wear of wheel (W_w). The symbols of wear were presented earlier in Table 2.

As can be observed in Table 6 for the tested material combinations, the two modes of wear that appear most often on the pinion teeth are scuffing and scoring. When one or both gears are coated, only scoring predominates on the pinion teeth.

When the pinion is coated and the wheel is uncoated, and when both the gears are coated, identical results were obtained for the two investigated coatings - FLS values are respectively 11 and higher than 12 (Figures 12 and 14). Therefore, the main criterion of assessment of the resistance to scuffing (FLS) makes it impossible to differentiate between these two situations. Under these circumstances, the analysis of additional criteria of failure assessment, related to the modes of wear at particular load stages, like in the previous cases can give additional, valuable information. In the case of the material combinations with the a-C:H:W coating, the predominating mode of wear of the pinion were only scratches. For the material combinations with the MoS_2/Ti coating, the pinion wear was much more severe, and scoring instead of scratches could be met most often. Thus, the a-C:H:W coating provides better protection against severe wear than MoS_2/Ti , especially when it is deposited on the both gears. This positively verifies the observations taken during performing the Gear Scuffing EP Test for Coatings.

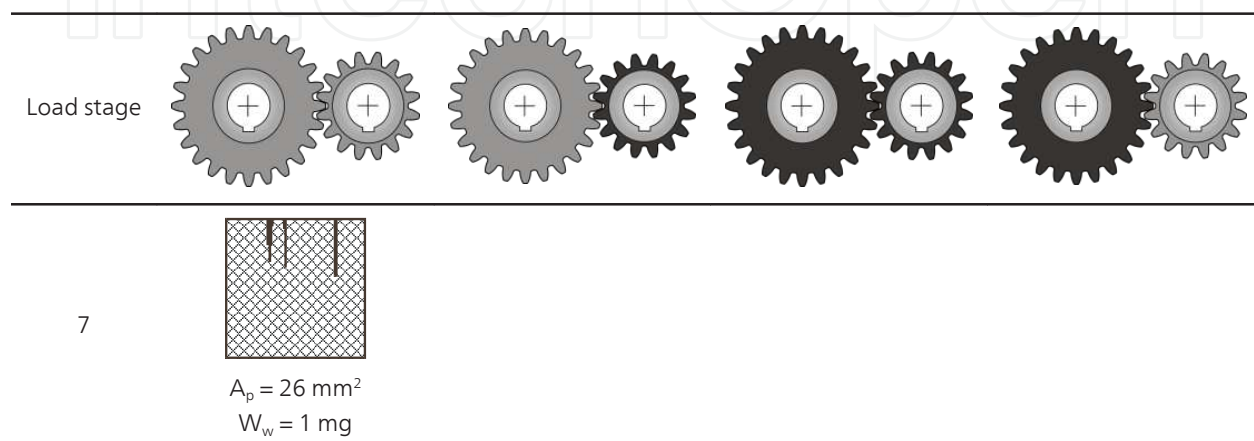

Load stage			
8	 $A_p = 703 \text{ mm}^2$ W_w - not measured		
9			
10	 $A_p = 32 \text{ mm}^2$ $W_w = 11 \text{ mg}$		
11	 $A_p = 109 \text{ mm}^2$ $W_w = 25 \text{ mg}$	 $A_p \approx 0$ $W_w = 16 \text{ mg}$	 $A_p \approx 0$ $W_w = 9 \text{ mg}$
12		 $A_p \approx 0$ $W_w = 16 \text{ mg}$	 $A_p \approx 0$ $W_w = 9 \text{ mg}$

Table 6. Modes of wear of the test pinion at particular load stages for the tested material combinations with the MoS₂/Ti coating, together with the total area of failures on the pinion (A_p), and wear of wheel (W_w), obtained in the Gear Scuffing Shock Test for Coatings; red-shadowed cells - the failure load stage (FLS)

4. Summary and conclusions

The authors have developed unique test methods, being the subjects of this chapter. They are called the “Gear Scuffing EP Test for Coatings” and “Gear Scuffing Shock Test for Coatings.”

The analysis of the values of the failure load stage (FLS), reflecting the resistance to scuffing, shows that the developed Gear Scuffing EP Test for Coatings has too little resolution to differentiate between the tested material combinations - coating-coating (both gears coated), coating-steel, steel-coating, and also steel-steel (both gears without a coating). Additional criteria of failure assessment need to be employed to reveal minor differences between the tested material combinations observed only when the pinion is uncoated and the wheel is coated.

In comparison, Gear Scuffing Shock Test for Coatings makes it generally possible to differentiate between the tested material combinations from the point of view of the main criterion of assessment of the gear resistance to scuffing, i.e. FLS. Thus, this test method has a sufficient resolution. However, as in the case of the Gear Scuffing EP Test for Coatings, apart from the analysis of only FLS values, analysis of the additional criteria of failure assessment related to predominating modes of wear at particular load stages is recommended and may give additional, valuable information. For the two coatings tested (a-C:H:W and MoS₂/Ti), the best resistance to scuffing/scoring (FLS > 12) is observed when both gears are coated; however, the a-C:H:W coating gives a slightly better protection against severe wear than MoS₂/Ti - only scratches instead of scoring are observed for a-C:H:W.

Although the Gear Scuffing Shock Test for Coatings gives a much better resolution than the Gear Scuffing EP Test, one needs to have in mind that the cost of the former is about four-times higher than in the case of the latter, because the “shock tests” require more test gears to be used.

In the both tests, when one or both gears are coated, three modes of wear occur most often on the pinion teeth - polishing, scratches, or scoring. Scuffing is observed only when the two gears are uncoated.

The following conclusions can be drawn:

- The developed Gear Scuffing Shock Test for Coatings has been successfully verified by the testing of thin, hard coatings deposited on the gears; therefore, it can be implemented in the laboratories of the R&D centres devoted to surface engineering and the engineering of advanced materials intended for modern toothed gears, having in mind that this test is rather expensive.
- If the coating is intended for application on gears, from the point of view of the highest achievable resistance to scuffing/scoring, it is recommended that both meshing gears are a-C:H:W-coated.
- Although the T-12U gear test rig has been effectively employed in the performed research, it is suggested that its research capacities should be extended by the measurement and data

acquisition of the friction torque, which will make it possible to investigate, as postulated by gear transmissions manufacturers, the possibility of the reduction of friction between the meshing teeth by the application of a low-friction coating. At present, a new version of the T-12U test rig, denoted as T-12UF, is being developed within the framework of the Strategic Programme executed at ITeE-PIB in Radom, and the planned deadline of this work is in 2013.

- Both the differentiation between the tested objects (lubricating oils, material combinations) and the predictability of gear failures in real applications (transmissions) are important when assessing gear tests. This is why the authors plan to verify the results obtained by application of coated gears in transmissions (speed reducers) of different devices manufactured by one of the Polish producers. What is more, at present another test rig - a back-to-back bevel gear test rig, denoted as T-30 - is being developed in the Tribology Department of ITeE-PIB in Radom with the deadline in 2012. The reason is that until now widely used test devices and methods have allowed researchers to perform runs on only spur gears having the tooth geometry significantly different than the geometry of bevel gears. The new tribotester will allow researchers to better predict the failures of bevel gears.

Acknowledgements

Scientific work was financed:

- From the means of the Minister of Science and Higher Education, executed within the Strategic Programme "Innovative Systems of Technical Support for Sustainable Development of the Country's Economy" within Innovative Economy Operational Programme.
- By the National Centre for Research and Development (NCBiR) within the scope of the R&D project No. N R03 0019 06.

The authors wish to express their thanks also to Dr. Maksim Antonov from Tallinn University (Estonia) for his support with the gear scuffing tests and helpful discussions, within the framework of Marie Curie RTN (6th EU FP); Contract No MRTN-CT-2006-035589.

Author details

Remigiusz Michalczewski*, Marek Kalbarczyk, Michal Michalak, Witold Piekoszewski, Marian Szczerek, Waldemar Tuszyński and Jan Wulczyński

*Address all correspondence to: remigiusz.michalczewski@itee.radom.pl

Institute for Sustainable Technologies - National Research Institute (ITeE-PIB), Tribology Department, Radom, Poland

References

- [1] Pytko S., Sroda P. Classification and Evaluation of Machines for Investigation of Materials for Production of Gear Wheels. ZEM 1975; 1 39-58 (*in Polish*).
- [2] Tomaszewski J., Drewniak J., editors. Scuffing of Gears. Gliwice: CMG KOMAG; 2007 (*in Polish*).
- [3] ARTEC Machine Systems. Failure by scuffing due to poor distribution of load. http://www.artec-machine.com/images/failure_due_to_poor_distribution_of_load_1.pdf (accessed 22 September 2012).
- [4] Kratz S.H., Wedeven L.D., Black W.F., Carlisle D.J., Wedeven G.G. Simulation of Space Shuttle Gear Performance. In: proceedings of the III World Tribology Congress, 2005, Washington, USA.
- [5] Kuo W.F., Chiou Y.C., Lee R.T. A Study on Lubrication Mechanism and Wear Scar in Sliding Circular Contacts. Wear 1996;201 217-226.
- [6] Ku P.M., editor. Interdisciplinary Approach to Friction and Wear. Washington D.C.: Southwest Research Institute; 1968.
- [7] Makowska M., Matuszewska A., Gradkowski M. Migration of Active Elements from a Lubricant to the Material of the Friction Pair. Tribologia 2011;4 163-176 (*in Polish*).
- [8] Wachal A. Analysis of Boundary Layer Estimating Criteria in Lubricating Oils Investigations. ZEM 1983;3 325-332.
- [9] Höhn B.-R., Oster P., Schedl U. Pitting Load Capacity Test on The FZG Gear Test Rig with Load-Spectra and One-Stage Investigations. Tribotest journal 1999;5-4 417-430.
- [10] Szczerek M., Tuszynski W. A Method for Testing Lubricants under Conditions of Scuffing. Part I. Presentation of the Method. Tribotest journal 2002;8-4 273-284.
- [11] Piekoszewski W., Szczerek M., Tuszynski W. The Action of Lubricants under Extreme Pressure Conditions in a Modified Four-Ball Tester. Wear 2001;249 188-193.
- [12] Tuszynski W., Michalczewski R., Piekoszewski W., Szczerek M. Effect of Ageing Automotive Gear Oils on Scuffing and Pitting. Tribology International 2008;41 875-888.
- [13] Bisht R.P.S., Singhal S. A Laboratory Technique for the Evaluation of Automotive Gear Oils of API GL-4 Level. Tribotest journal 1999;6-1 69-77.
- [14] Method to Assess the Scuffing Load Capacity of Lubricants with High EP Performance Using an FZG Gear Test Rig. FVA Information Sheet No. 243 Status June 2000.
- [15] Höhn B.-R., Michaelis K., Eberspächer C., Schlenk L. A Scuffing Load Capacity Test with the FZG Gear Test Rig for Gear Lubricants with High EP Performance. Tribotest journal 1999;5-4 383-390.

- [16] Michaelis K., Höhn B.-R., Graswald C. Scuffing Tests for API GL-1 to GL-5 Gear Lubricants. In: proceedings of the 13th International Colloquium Tribology, 2002, Ostfildern, Germany.
- [17] Michaelis K., Höhn B.-R., Oster P. Influence of Lubricant on Gear Failures - Test Methods and Application to Gearboxes in Practice. Tribotest journal 2004;11-1 43-56.
- [18] Höhn B.-R., Oster P., Tobie T., Michaelis K. Test Methods for Gear Lubricants. Goriva i maziva 2008;47-2 141-152.
- [19] Tuszynski W. Performance Classification of Automotive Gear Oils Using the Gear Scuffing Shock Test. Tribologia 2009;2 259-274 (*in Polish*).
- [20] Kalin M., Vižintin J. The Tribological Performance of DLC-Coated Gears Lubricated with Biodegradable Oil in Various Pinion/Gear Material Combinations. Wear 2005;259 1270-1280.
- [21] Martins R.C., Moura Paulo S., Seabra J.O. MoS₂/Ti Low-Friction Coating for Gears. Tribology International 2006;39 1686-1697.
- [22] Martins R., Amaro R., Seabra J. Influence of Low Friction Coatings on The Scuffing Load Capacity and Efficiency of Gears. Tribology International 2008;41 234-243.
- [23] Szczerek M., Michalczewski R., Piekoszewski W. The Problems of Application of PVD/CVD Thin Hard Coatings for Heavy-Loaded Machine Components. In: proceedings of the ASME/STLE International Joint Tribology Conference, 2007, San Diego, USA.
- [24] Michalczewski R., Piekoszewski W., Szczerek M., Tuszynski W. The Lubricant-Coating Interaction in Rolling and Sliding Contacts. Tribology International 42;2009 554-560.
- [25] Michalczewski R., Piekoszewski W., Szczerek M., Tuszynski W. Scuffing Resistance of DLC Coated Gears Lubricated with Ecological Oil. Estonian Journal of Engineering 2009;15-4 367-373.
- [26] CECL-07-95: Load Carrying Capacity Test for Transmission Lubricants (FZG Test Rig).

