

We are IntechOpen, the world's leading publisher of Open Access books Built by scientists, for scientists

4,800

Open access books available

122,000

International authors and editors

135M

Downloads

Our authors are among the

154

Countries delivered to

TOP 1%

most cited scientists

12.2%

Contributors from top 500 universities



WEB OF SCIENCE™

Selection of our books indexed in the Book Citation Index
in Web of Science™ Core Collection (BKCI)

Interested in publishing with us?
Contact book.department@intechopen.com

Numbers displayed above are based on latest data collected.
For more information visit www.intechopen.com



Using Overall Equipment Effectiveness for Manufacturing System Design

Vittorio Cesarotti, Alessio Giuiusa and Vito Introna

Additional information is available at the end of the chapter

<http://dx.doi.org/10.5772/56089>

1. Introduction

Different metrics for measuring and analyzing the productivity of manufacturing systems have been studied for several decades. The traditional metrics for measuring productivity were *throughput* and *utilization rate*, which only measure part of the performance of manufacturing equipment. But, they were not very helpful for “*identifying the problems and underlying improvements needed to increase productivity*” [1].

During the last years, several societal elements have raised the interest in analyze the phenomena underlying the identification of productive performance parameters as: capacity, production throughput, utilization, saturation, availability, quality, etc.

This rising interest has highlighted the need for more rigorously defined and acknowledged productivity metrics that allow to take into account a set of synthetic but important factors (availability, performance and quality) [1]. Most relevant causes identified in literature are:

- The growing attention devoted by the management to cost reduction approaches [2] [3];
- The interest connected to successful eastern productions approaches, like *Total Productive Maintenance* [4], *World Class Manufacturing* [5] or *Lean production* [6];
- The importance to go beyond the limits of traditional business management control system [7];

For this reasons, a variety of new performance concepts have been developed. The total productive maintenance (TPM) concept, launched by Seiichi Nakajima [4] in the 1980s, has provided probably the most acknowledged and widespread quantitative metric for the measure of the productivity of any production equipment in a factory: the *Overall Equipment Effectiveness* (OEE). OEE is an appropriate measure for manufacturing organizations

and it has been used broadly in manufacturing industry, typically to monitor and control the performance (time losses) of an equipment/work station within a production system [8]. The OEE allows to quantify and to assign all the time losses, that affect an equipment whilst the production, to three standard categories. Being standard and widely acknowledged, OEE has constituted a powerful tool for production systems performance benchmarking and characterization, as also the starting point for several analysis techniques, continuous improvement and research [9] [10]. Despite this widespread and relevance, the use of OEE presents limitations. As a matter of fact, OEE focus is on the single equipment, yet the performance of a single equipment in a production system is generally influenced by the performance of other systems to which it is interconnected. The time losses propagation from a station to another may widely affect the performance of a single equipment. Since OEE measures the performance of the equipment within the specific system, a low value of OEE for a given equipment can depend either on little performance of the equipment itself and/or time losses propagation due to other interconnected equipments of the system.

This issue has been widely investigated in literature through the introduction of a new metric: the Overall Equipment Effectiveness (OTE), that considers the whole production system as a whole. OTE embraces the performance losses of a production system both due to the equipments and their interactions.

Process Designers need usually to identify the number of each equipments necessary to realize each activity of the production process, considering the interaction and consequent time losses a priori. Hence, for a proper design of the system, we believe that the OEE provides designer with better information on each equipment than OTE. In this chapter we will show how OEE can be used to carry out a correct equipments sizing and an effective production system design, taking into account both equipment time losses and their propagation throughout the whole production system.

In the first paragraph we will show the approach that a process designer should face when designing a new production system starting from scratch.

In the second paragraph we will investigate the typical time-losses that affect a production system, although are independent from the production system itself.

In the third part we will define all the internal time losses that need to be considered when assessing the OEE, along with the description of a set of critical factors related to OEE assessment, such as buffer-sizing and choice of the plant layout.

In the fourth paragraph we will show and quantify how time losses of a single equipment affects the whole system and vice-versa.

Finally, we will show through the simulation some real cases in which a process design have been fully completed, considering both equipment and time losses propagation.

2. Manufacturing system design: Establish the number of production machines

Each process designer, when starting the design of a new production system, must ensure that the number of equipments necessary to carry out a given process activity (e.g. metal milling) is sufficient to realize the required volume. Still, the designer must generally ensure that the minimum number of equipment is bought due to elevated investment costs. Clearly, the performance inefficiencies and their propagation became critical, when the purchase of an extra (set of) equipment(s) is required to offset time losses propagation. From a price strategy perspective, the process designer is generally requested to assure the number of requested equipments is effectively the minimum possible for the requested volume. Any not necessary over-sizing results in an extra investment cost for the company, compromising the economical performance.

Typically, the general equation to assess the number of equipments needed to process a demand of products (D) within a total calendar time C_t (usually one year) can be written as follow (1):

$$n_i = \text{int} \left[\frac{D * ct_i}{C_t * \vartheta * \eta_i} \right] + 1 \quad (1)$$

Where:

- D is the number of products that must be produced;
- ct_i is theoretical cycle time for the equipment i to process a piece of product;
- C_t is the number of hours (or minutes) in one year.
- ϑ is a coefficient that includes all the external time losses that affect a production system, precluding production.
- η_i is the efficiency of the equipment i within the system.

It is therefore possible to define L_t , Loading time, as the percentage of total calendar time C_t that is actually scheduled for operation (2):

$$L_t = C_t * \vartheta \quad (2)$$

The equation (1) shows that the process designer must consider in his/her analysis three parameters unknown a priori, which influence dramatically the production system sizing and play a key role in the design of the system in order to realize the desired throughput. These parameters affect the total time available for production and the real time each equipment request to realize a piece [9], and are respectively:

- External time losses, which are considered in the analysis with ϑ ;

- The theoretical time cycle, which depends upon the selected equipment(s);
- The efficiency of the equipment which depends upon the selected equipments and their interactions, in accordance to the specific design.

This list highlights the complexity implicitly involved in a process design. Several forecasts and assumptions may be required. In this sense, it is a good practice to ensure that the ratio in equation (3) is always respected for each equipment:

$$\frac{\left(\frac{D^{ct}_i}{L_i \eta_i} \right)}{n_i} < 1 \quad (3)$$

As a good practice, to ensure (3) being properly lower than 1 allows to embrace, among others, the variability and uncertainty implicitly embedded within the demand forecast.

In the next paragraph we will analyze the External time losses that must be considered during the design.

3. External time losses

3.1. Background

For the design of a production system several time-losses, of different nature, need to be considered. Literature is plenty of classifications in this sense, although they can diverge one each others in parameters, number, categorization, level of detail, etc. [11] [12]. Usually each classification is tailored on a set of sensible drivers, such as data availability, expected results, etc. [13].

One relevant classification of both external and internal time losses is provided by Grando et al. [14]. Starting from this classification and focusing on external time losses only, we will briefly introduce a description of common time-losses in Operations Management, highlighting which are most relevant and which are negligible under certain hypothesis for the design of a production system (Table 1).

The categories LT1 and LT2 don't affect the performance of a single equipment, nor influence the propagation of time-losses throughout the production system.

Still, it is important to notice that some causes, even though labeled as external, are complex to asses during the design. Despite these causes are external, and well known by operations manager, due to the implicit complexity in assessing them, these are detected only when the production system is working via the OEE, with consequence on OEE values. For example, the lack of material feeding a production line does not depend by the OEE of the specific station/equipment. Nevertheless when lack of material occurs a station cannot produce with consequences on equipment efficiency, detected by the OEE. (4).

Symbol	Name	Description	Synonyms
Lt1	Idle times resulting from law regulations or corporate decisions	Summer vacations, holidays, shifts, special events (earthquakes, flood);	System External Causes
Lt2	Unplanned time	Lack of demand; Lack of material in stocks; Lack of orders in the production plan; Lack of energy; Lack of manpower (strikes, absenteeism); Technical tests and manufacturing of nonmarketable products; Training of workers;	System External Causes
Lt3	Stand by time	Micro-absenteeism, shift changes; physiological increases; man machine interaction; Lack of raw material stocks for single machines; Unsuitable physical and chemical properties of the available material; Lack of service vehicle; Failure to other machines;	Machine External Causes; System External Causes

Table 1. Adapted from Grando et al. 2005

3.2. Considerations

The external time losses assessment may vary in accordance to their categories, historical available data and other exogenous factors. Some stops are established for through internal policies (e.g. number of shift, production system closure for holidays, etc.). Other macro-stops are assessed (e.g. Opening time to satisfy forecasted demand), whereas others are considered as a forfeit in accordance to the Operations Manager Experience. It is not possible to provide a general magnitude order because, the extent of time losses depend from a variety of characteristic factor connected mainly to the specific process and the specific firm. Among the most common ways to assess this time losses we found: Historical data, Benchmarking with similar production system, Operations Manager Experience, Corporate Policies.

The Calendar time C_t is reduced after the external time losses. The percentage of C_t in which the production system does not produce is expressed by $(1 - \vartheta)$, affecting consequently the L_t (2).

These parameters should be considered carefully by system designers in assessing the loading time (2). Although these parameters do not propagate throughout the line their consideration is fundamental to ensure the identification of a proper number of equipments.

3.2.1. *Idle times*

There is a set of idle times that result from law regulations or corporate decisions. These stops are generally known a-priori, since they are regulated by local law and usually contribute to the production plant localization-decision process. Only causes external to the production system are responsible for their presence.

3.2.2. *Unplanned times*

The unplanned time are generally generated by system external causes connected with machineries, production planning and production risks.

A whole production system (e.g. production line) or some equipment may be temporarily used for non marketable product (e.g. prototype), or they may are not supposed to produce, due to test (e.g. for law requirements), installation of new equipments and the related activities (e.g. training of workers).

Similarly, a production system may face idle time because of lack of demand, absence of a production schedule (ineffectiveness of marketing function or production planning activities) or lack of material in stock due to ineffectiveness in managing the orders. Clearly, the presence of a production schedule in a production system is independent by the Operations manager and by the production system design as well. Yet, the lack of stock material, although independent from the production system design is one of the critical responsibility of any OM (inventory management).

Among this set of time losses we find also other external factors that affect the system availability, which are usually managed by companies as a risk. In this sense occurrence of phenomenon like the lack of energy or the presence of strikes are risks that companies well know and that usually manage according to one of the four risk management strategy (avoidance, transfer, mitigation acceptance) depending on their impact and probability.

3.2.3. *Stand by time*

Finally, the stand-by time losses are a set of losses due to system internal causes, but still equipment external causes. This time losses may affect widely the OTE of the production line and depend on: work organization losses, raw material and material handling.

Micro-absenteeism and shift changes may affect the performances of all the system that are based on man-machine interaction, such as the production equipments or the transportation systems as well. Lack of performance may propagate throughout the whole system as other equipment ineffectiveness. Even so, Operations manager can't avoid these losses by designing a better production line. Effective strategies in this sense are connected with social science that aim to achieve the employee engagement in the workplace [15].

Nonetheless Operations Manager can avoid the physiological increases by choosing ergonomic workstations.

The production system can present other time-losses because of the raw material, both in term of lack and quality:

- Lack of raw material causes the interruption of the throughput. Since we have already considered the ineffective management of the orders in “Unplanned Time”, the other related causes of time-losses depend on demand fluctuation or in ineffectiveness of the suppliers as well. In both cases the presence of safety stock allows operations manager to reduce or eliminate their effects.
- Low raw material standard quality (e.g. physical and chemical properties), may affect dramatically the performance of the system. Production resource (time, equipment, etc) are used to elaborate a throughput without value (or with a lower value) because of little raw material quality. Also in this case, this time losses do not affect the design of a production system, under the hypothesis that Operations Manager ensures the raw material quality is respected (e.g. incoming goods inspection). The missed detection of low quality raw materials can lead the Operations Manager to attribute the cause of defectiveness to the equipment (or set of equipment) where the defect is detected.

Considering the Vehicle based internal transport, a broader set of considerations is requested. Given two consecutive stations i - j , the vehicles make available the output of station i to station j (figure 1).

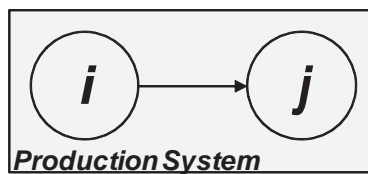

Figure 1. Vehicle based internal transport: transport the output of station i to the station j

In this sense any vehicle can be considered as an equipment that is carrying out the transformation on a piece, moving the piece itself from station i to station j (Figure 2).

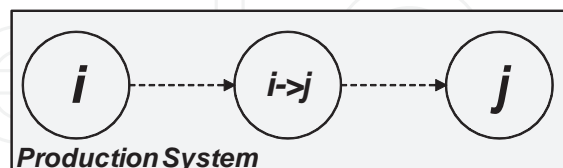

Figure 2. Service vehicles that connect i - j can be represented as a station itself amid i - j

The activity to transport the output from station i to station j is a transformation (position) itself. Like the equipments, also the service vehicles affect and are affected by the OTE. In this sense successive considerations on equipments losses categorization, OEE, and their propagations throughout the system, OTE, can be extended to service vehicles. Hence, the design of service vehicles would be carried out according to the same guidelines we provide in successive section of this chapter.

4. The formulation of OEE

In this paragraph we will provide process designer with a set of topics that need to be addressed when considering the OEE during the design of a new production system. A proper assessment a-priori of the OEE, and the consequent design and sizing of the system demand process designer to consider a variety of complex factors, all related with OEE. It is important to notice that OEE measures not only the internal losses of efficiency, but is also detects time losses due to external time losses (par.2.1, par.2.2). Hence, in this paragraph we will firstly define analytically the OEE. Secondly we will investigate, through the analysis of relevant literature, the relation between the OEE of single equipment and the OEE of the production system as a set of interconnected equipments. Then we will describe how different time losses categories, of an equipment, affect both the OEE of the equipment and the OEE of the Whole system. Finally we will debate how OEE need to be considered with different perspective in accordance to factors as ways to realize the production and plant layout.

4.1. Mathematical formulation

OEE is formulated as a function of a number of mutually exclusive components, such as *availability efficiency*, *performance efficiency*, and *quality efficiency* in order to quantify various types of productivity losses.

OEE is a value variable from 0 to 100%. An high value of OEE indicates that machine is operating close to its maximum efficiency. Although the OEE does not diagnose a specific reason why a machine is not running as efficiently as possible, it does give some insight into the reason [16]. It is therefore possible to analyze these areas to determine where the lack of efficiency is occurring: breakdown, set-up and adjustment, idling and minor storage, reduced speed, and quality defect and rework [1] [4].

In literature exist a meaningful set of time losses classification related to the three reported efficiencies (availability, performance and quality). Grando et al. [14] for example provided a meaningful and comprehensive classification of the time-losses that affect a single equipment, considering its interaction in the interaction system. Waters et al. [9] and Chase et al. [17] showed a variety of acknowledged possible efficiency losses schemes, while Nakajima [4] defined the most acknowledged classification of the "6 big losses".

In accordance with Nakajima notations, the conventional formula for OEE can be written as follow [1]:

$$OEE = A_{eff} Pe_{eff} Q_{eff} \quad (4)$$

$$A_{eff} = \frac{T_u}{T_t} \quad (5)$$

$$Pe_{eff} = \frac{T_p}{T_u} * \frac{R_{avg}^{(a)}}{R_{avg}^{(th)}} \quad (6)$$

$$Q_{eff} = \frac{P_g}{P_a} \quad (7)$$

Table 2 summarizes briefly each factor.

Factor	Description
A_{eff}	Availability efficiency. It considers failure and maintenance downtime and time devoted to indirect production task (e.g. set up, changeovers).
Pe_{eff}	Performance efficiency. It consider minor stoppages and time losses caused by speed reduction
Q_{eff}	Quality efficiency. It consider loss of production caused by scraps and rework.
T_u	Equipment uptime during the T_t . It is lower than T_t because of failure, maintenance and set up.
T_t	Total time of observation.
T_p	Equipment production time. It is lower than T_t because of minor stoppages, resets, adjustments following changeovers.
$R_{avg}^{(a)}$	Average actual processing rate for equipment in production for actual product output. It is lower than theoretical ($R_{avg}^{(th)}$) because of speed/production rate slowdowns.
$R_{avg}^{(th)}$	Average theoretical processing rate for actual product output.
P_g	Good product output from equipment during T_t .
P_a	Actual product units processed by equipment during T_t . We assume that for each product rework the same cycle time is requested.

Table 2. OEE factors description

The OEE analysis, if based on single equipment data, is not sufficient, since *no machine is isolated in a factory, but operates in a linked and complex environment* [18]. A set of inter-dependent relations between two or more equipments of a production system generally exists, which leads to the propagation of availability, performance and quality losses throughout the system.

Mutual influence between two consecutive stations occurs even if both stations are working ideally. In fact if two consecutive stations (e.g. station A and station B) present different cycle times, the faster station (eg. Station A = 100 pcs/hour) need to reduce/stop its production rate in accordance with the other station production rate (e.g. Station B = 80 pcs/hour).

Station A	Station B
100 pcs/hour	80 pcs/hour

In this case, the detected OEE of station A would be 80%, even if any efficiency loss occurs. This losses propagation is due to the unbalanced cycle time.

Therefore, when considering the OEE of equipment in a given manufacturing system, the measured OEE is always the performance of the equipment within the specific system. This leads to practical consequence for the design of the system itself.

A comprehensive analysis of the production system performance can be reached by extending the concept of OEE, as the performance of individual equipment, up to factory level [18]. In this sense OEE metric is well accepted as an effective measure of manufacturing performance not only for single machine but also for the whole production system [19] and it is known as *Overall Throughput Effectiveness* OTE [1] [20].

We refer to OTE as the OEE of the whole production system.

Therefore we can talk of:

- Equipment OEE, as the OEE of the single equipment, which measures the performance of the equipment in the given production system.
- System OEE (or OTE), which is the performance of the whole system and can be defined as the performance of the bottleneck equipment in the given production system.

4.2. An analytical formulation to study equipment and system OEE

$$\text{System OEE} = \frac{\text{Number of good parts produced by system in total time}}{\text{Theoretical number of parts produced by system in total time}} \quad (8)$$

The System OEE measures the systemic performance of a manufacturing system (productive line, floor, factory) which combines activities, relationships between different machines and processes, integrating information, decisions and actions across many independent systems and subsystem [1]. For its optimization it is necessary to improve coordinately many interdependent activities. This will also increase the focus on the plant-wide picture.

Figure 3 clarify which is the difference between Equipment OEE and System OEE, showing how the performance of each equipment affects and is affected by the performances of the other connected equipments. These time losses propagation result on a Overall System OEE. Considering the figure 3 we can indeed argue that given a set of $i=1,\dots,n$ equipments, OEE_i of the i^{th} equipment depends on the process in which it has been introduced, due to the availability, performance and quality losses propagation.

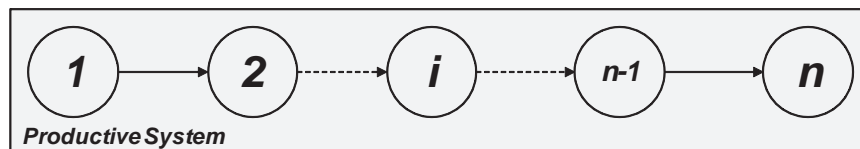

Figure 3. A production system composed of n stations

According to the model proposed by Huang et al in [1], the System OEE (OTE) for a series of n connected subsystems, is formulated in function of theoretical production rate $R_{avg(F)}^{(th)}$ relating

to the slowest machine (the bottleneck), theoretical production rate $R_{avg(N)}^{(th)}$ and OEE_n of n^{th} station as shown in (9):

$$OTE = \frac{OEE_n \times R_{avg(n)}^{th}}{R_{avg(F)}^{th}} \quad (9)$$

The OEE_n computed in (9) is the OEE of n^{th} station introduced in the production system (the OEE_n when n is in the system and it is influenced by the performance of other $n-1$ equipments).

According to (9) the only measure of OEE_n is a measure of the performance of the whole system (OTE). This is true because performance data on n are gathered when the station n is already working in the system with the other $n-1$ station and, therefore, its performance is affected from the performance of the other $n-1$ prior stations. This means that the model proposed by Huang, could be used *only when the system exists and it is running*, so OEE_n could be directly measured on field.

But during system design, when only technical data of single equipment are known, the same formulation in (9) can't be used, since without information on the system OEE_n is unknown a-priori. Hence, in this case the (9) couldn't provide a correct value of OTE.

4.3. How equipment time-losses influence the system performance and vice-versa

The OEE of each equipment, *as isolated machine* (independent by other station) is affected only by (5),(6) and (7) theoretical intrinsic value. But once the equipment is part of a system its performance depends also upon the interaction with other $n-1$ equipments and thus on their performance. It is now more evident why, for a correct estimate and/or analysis of equipment OEE and system OEE, it is necessary to take into account losses propagation. These differences between single subsystem and entire system need to be deeply analyzed to understand real causes of system efficiency losses. In particular their investigation is fundamental during the design process, because a correct evaluation of OEE and for the study of effective losses reduction actions (i.e. buffer capacity dimensioning, quality control station positioning); but also during the normal execution of the operations because it leads to correct evaluation of causes of efficiency losses and their real impact on the system.

The table 3 shows how efficiency losses of a single subsystem (e.g. an equipment/ machine), given by Nakajima [4] can spread to other subsystem (e.g. in series machines) and then to whole system.

In accordance to table 3 a relevant lack of coordination in deploying available factory resources (people, information, materials, and tools) by using OEE metric (based on single equipment) exists. Hence, a wider approach for a holistic production system design has to focus also *on the performance of the whole factory* [18], resulting by the interactions of its equipments.

	Single subsystem	Entire system
Availability	Breakdown losses Set-up and adjustment	Downtimes losses of upstream unit could slackening production rate of downstream unit without fair buffer capacity Downtimes losses of downstream unit could slackening production rate of upstream unit without fair buffer capacity
Performance	Idling and minor stoppages Reduced speed	Minor stoppages and speed reduction could influencing production rate of the downstream and upstream unit in absence of buffer
Quality	Quality defects and rework Yield losses	Production scraps and rework are losses for entire process depends on where the scraps are identified, rejected or reworked in the process

Table 3. Example of propagation of losses in the system

This issue have been widely debated and acknowledged in literature [1] [18]. Several Authors [8] [21] have recognized and analyzed the need for a coherent, systematic methodology for design at the factory level.

Furthermore, the following activities, according to [18] [21] have to be considered as OTE is also started at the factory design level:

- Quality (better equipment reliability, higher yields, less rework, no misprocessing);
- Agility and responsiveness (more customization, fast response to unexpected changes, simpler integration);
- Technology changes;
- Speed (faster ramp up, shorter cycle times, faster delivery);
- Production cost (better asset utilization, higher throughput, less inventory, less setup, less idle time);

At present, there is not a common well defined and proven methodology for the analysis of System OEE [1] [19] *during the system design*. By the way the effect of efficiency losses propagation must be considered and deeply analyzed to understand and eliminate the causes before the production system is realized. In this sense the *simulation* is considered the most reliable method, to date, in designing, studying and analyzing the manufacturing systems and its dynamic performance [1] [19]. Discrete event simulation and advanced process control are the most representatives of such areas [22].

4.4. Layout impact on OEE

Finally, it is important to consider how the focus of the design may vary according the type of production system. In flow-shop production system the design mostly focuses on the OTE of the whole production line, whereas in job-shop production system the analysis may focus either on the OEE of a single equipment or in those of the specific shop floor, rather than those of the whole production system. This is due to the intrinsic factors that underlies a layout configuration choice.

Flow shop production systems are typical of high volume and low variety production. The equipment present all a similar cycle time [23] and is usually organized in a product layout where interoperation buffers are small or absent. Due to similarity among the equipments that compose the production system, the saturation level of the different equipments are likely to be similar one each other. The OEE are similar as well. In this sense the focus of the analysis will be on loss time propagation causes, with the aim to avoid their occurrence to rise the OTE of the system.

On the other hand, in *job shop production systems*, due to the specific nature of operations (multi-flows, different productive paths, need for process flexibility rather than efficiency) characterized by higher idle time and higher stand-by-time, lower values of performances index are pursued.

Different products categories usually require a different sequence of tasks within the same production system so the equipment is organized in a process layout. In this case rather than focusing on efficiency, the design focuses on production system flexibility and in the layout optimization in order to ensure that different production processes can take place effectively.

Generally different processes, to produce different products, imply that bottleneck may shift from a station to another due to different production processes and different processing time of each station in accordance to the specific processed product as well.

Due to the shift of bottleneck the presence of buffers between the stations usually allows different stations to work in an asynchronous manner, consecutively reducing/eliminating the propagation of low utilization rates.

Nevertheless, when the productive mix is known and stable over time, the study of plant layout can embrace bottleneck optimization for each product of the mix, since a lower flexibility is demanded.

The analysis of quality propagation amid two or more stations should not be a relevant issue in job shop, since defects are usually detected and managed within the specific station.

Still, in several manufacturing system, despite a flow shop production, the equipment is organized in a process layout due to physical attributes of equipment (e.g. manufacturing of electrical cables showed in § 4) or different operational condition (e.g. pharmaceutical sector). In this case usually buffers are present and their size can dramatically influence the OTE of the production system.

In an explicit attempt to avoid unmanageable models, we will now provide process designers and operations managers with useful hints and suggestion about the effect of inefficiencies propagation among a production line along with the development of a set of simulation scenarios (§ 3.5).

4.5. OEE and OTE factors for production system design

OEE is formulated as a function of a number of mutually exclusive components, such as availability efficiency, performance efficiency, and quality efficiency in order to quantify various types of productivity losses.

During the design of the production system the use of intrinsic performance index for the sizing of each equipment although wrong could seem the only rational approach for the design. By the way, this approach don't consider the interaction between the stations. Someone can argue that to make independent each station from the other stations through the buffer would simplify the design and increase the availability. Still, the interposition of a buffer between two or more station may not be possible for several reason. Most relevant are:

- logistic (space unavailability, huge size of the product, compact plant layout, etc.);
- economic (the creation of stock amid each couple of station increase the WIP and consequently interest on current assets);
- performance;
- product features (buffer increase cross times, critical for perishable products);

In our model we will show how a production system can be defined considering availability, performance and quality efficiency (5),(6), (7) of each station along with their interactions. The method embraces a set of hints and suggestions (best practices) that lead designers in handle interactions and losses propagation with the aim to rise the expected performance of the system. Furthermore, through the development of a simulation model of a real production system for the electrical cable production we provide students with a clear understanding of how time-losses propagate in a real manufacturing system.

The design process of a new production system should always include the simulation of the identified solution, since the simulation provides designer with a holistic understanding of the system. In this sense in this paragraph we provide a method where the design of a production system is an iterative process: the simulation output is the input of a successive design step, until the designed system meet the expected performance and performance are validated by simulation. Each loss will be firstly described referring to a single equipment, than its effect will be analyzed considering the whole system, also throughout the support of simulation tools.

4.5.1. Set up availability

Availability losses due to set up and changeover must be considered during the design of the plant. In accordance with the production mix, the number of set-up generally results as a trade-off between the set up costs (due to loss of availability + substituted tools, etc.) and the warehouse cost.

During the design phase some relevant consideration connected with set-up time losses should be considered. A production line is composed of n stations. The same line can usually produce more than one product type. Depending on the difference between different product types a changeover in one or more stations of the line can be required. Usually, the more negligible the differences between the products, the lower the number of equipments subjected to set up (e.g. it is sufficient the set up only of the label machine to change the labels of a product depending on the destination country). In a given line of n equipments, if a set up is requested

in station i , loss availability can interest only the single equipment I or the whole production line, depending on the buffer presence, their location and dimension:

- If buffers are not present, the set up of station i implies the stop of the whole line (figure 4). This is a typical configuration of flow shop process realized by one or more production line as food, beverages, pharmaceutical packaging,....
- If buffers are present (before and beyond the station i) and their size is sufficient to decouple the station i by the other $i-1$ and $i+1$ station during the whole set up, the line continues to work regularly (figure 5).

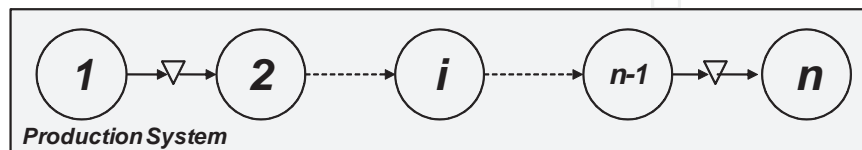

Figure 4. Barely decoupled/Coupled Production System (buffer unimportant or null)

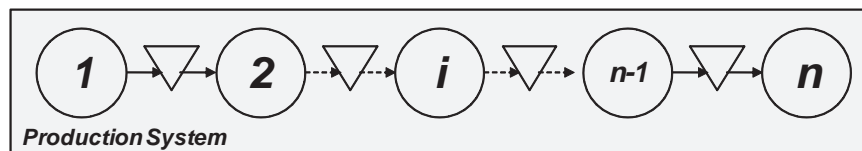

Figure 5. Decoupled Production System

Hence, the buffer design plays a key role in the phenomena of losses propagation throughout the line not only for set-up losses, but also for other availability losses and performance losses as well. The degree of propagation ranges according to the buffer size amid zero (total dependence-maximum propagation) and maximum buffer size (total independence-no propagation). It will be debated in the following (§ 3.5.3), when considering the performance losses, although the same principles can be applied to avoid propagation of minor set up losses (mostly for short set-up/changeover, like adjustment and calibrations).

4.5.2. Maintenance availability

The availability of an equipment [24] is defined as $A_{eff} = \frac{T_u}{T_t}$. The availability of the whole production system can be defined similarly. Nevertheless it depends upon the equipment configurations. Operations Manager, through the choice of equipment configurations can increase the maintenance availability. This is a design decision, since different equipments must be bought and installed according to desired availability level. The choice of the configuration usually results as a trade-off between equipment costs and system availability. The two main equipment configuration (not-redundant system, redundant system) are debated in the following.

Not redundant system

When a system is composed of non redundant equipment, each station produces only if the equipment is working.

Hence if we consider a line of n equipment connected a s a series we have that the downtime of each equipment causes the downtime of the whole system.

$$A_{system} = \prod_{i=1}^n A_i \quad (10)$$

$$A_{system} = \prod_{i=1}^n A_i = 0,7 * 0,8 * 0,9 = 0,504 \quad (11)$$

The availability of system composed of a series of equipment is always lower than the availability of each equipment (figure 6).

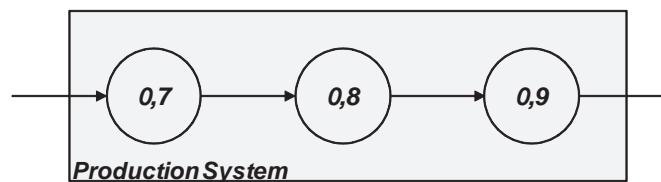

Figure 6. Availability of not redundant System

Total redundant system

Oppositely, to avoid failure propagation amid stations, designer can set the line with a total redundancy of a given equipment. In this case only the contemporaneous downtime of both equipments causes the downtime of the whole system.

$$A_{system} = 1 - \prod_{i=1}^n (1 - A_i) \quad (12)$$

In the example in figure 7 we have two single equipments connected with a redundant system of two equipment (dotted line system).

Hence, the redundant system availability (dotted line system) rises from 0,8 (of the single equipment) up to:

$$A_{parallel} = 1 - \prod_{i=1}^n (1 - A_i) = (1 - 0,8) * (1 - 0,8) = 0,96 \quad (13)$$

Consequently the availability of the whole system will be:

$$A_{system} = \prod_{i=1}^n A_i = 0,7 * [0,96] * 0,9 = 0,6048 \quad (14)$$

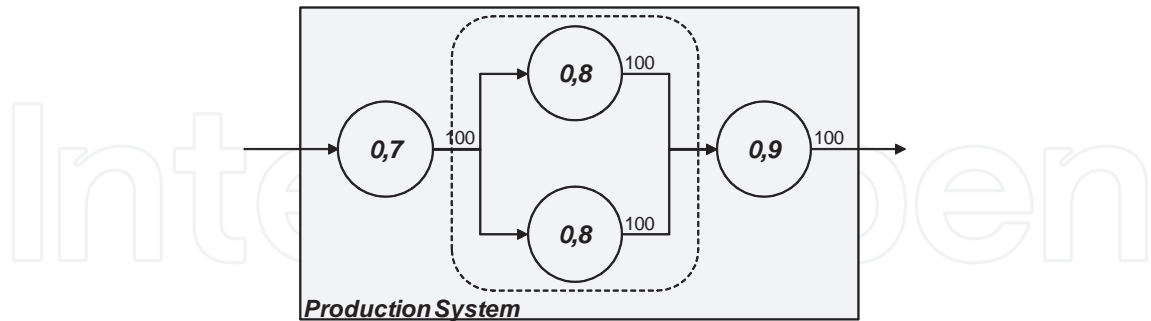

Figure 7. Availability of totally redundant equipments connected with not redundant equipments

To achieve an higher level of availability it has been necessary to buy two identical equipments (double cost). Hence, the higher value of availability of the system should be worth economically.

Partial redundancy

An intermediate solution can be the partial redundancy of an equipment. This is named K/n system, where n is the total number of equipment of the parallel system and k is the minimum number of the n equipment that must work properly to ensure the throughput is produced. The figure 8 shows an example.

The capacity of equipment b' , b'' and b''' is 50 pieces in the referral time unit. If the three systems must ensure a throughput of 100 pieces, it is at least necessary that $k=2$ of the $n=3$ equipment produce 50 pieces. The table 4 shows the configuration states which ensure the output is produced and the relative probability that each state manifests.

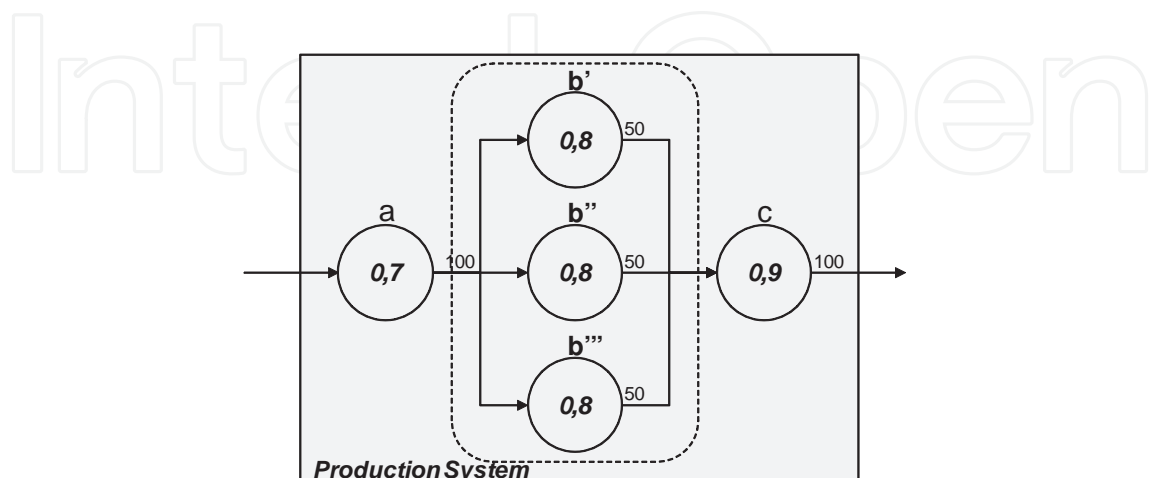

Figure 8. Availability of partially redundant equipments connected with not redundant equipments

b'	b''	b'''	Probability of occurrence	[*100]
UP	UP	UP	0,8*0,8*0,8	0,512
UP	UP	DOWN	0,8*0,8*(1-0,8)	0,128
UP	DOWN	UP	0,8*(1-0,8)*0,8	0,128
DOWN	UP	UP	(1-0,8)*0,8*0,8	0,128
Total Availability				0,896

Table 4. State Analysis Configuration

In this example all equipments b have the same reliability (0,8), hence the probability the system of three equipment ensure the output should have been calculated, without the state analysis configuration (table 4), through the binomial distribution:

$$R_{k/n} = \sum_{j=k}^n \binom{n}{j} R^j [1-R]^{n-j} \quad (15)$$

$$R_{2/3} = \binom{3}{2} 0,8^2 [1-0,8] + \binom{3}{3} 0,8^3 = 0,896 \quad (16)$$

Hence, the availability of the system (a, b'-b''-b''', c) will be:

$$A_{system} = \prod_{i=1}^n A_i = 0,8^3 [0,896] = 0,56448 \quad (17)$$

In this case the investment in redundancy is lower than the previous. It is clear how the choice of the level of availability is a trade-off between fix-cost (due to equipment investment) and lack of availability.

In all the cases we considered the buffer as null.

When reliability of the equipments (b in our example) the binomial distribution (16) is not applicable, therefore the state analysis configuration (table 4) is required.

Redundancy with modular capacity

Another configuration is possible.

The production system can be designed as composed of two equipment which singular capacity is lower than the requested but which sum is higher. In this case if it is possible to modulate the production capacity of previous and successive stations the expected throughput will be higher than the output of a singular equipment.

Considering the example in figure 9 when b' and b'' are both up the throughput of the subsystem $b'-b''$ is 100, since capacity of a and c is 100. Supposing that capacity of a and c is modular, when b' is down the subsystem can produce 60 pieces in the time unit. Similarly, when b'' is down the subsystem can produce 70. Hence, the expected amount of pieces produced by $b'-b''$ is 84,8 pieces (table 5).

When considering the whole system if either a or c are down the system cannot produce. Hence, the expected throughput in the considered time unit must be reduced of the availability of the two equipments:

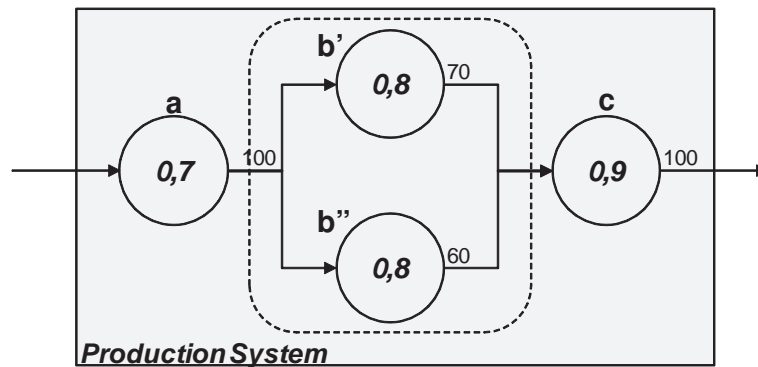

Figure 9. Availability of partially redundant equipments connected with not redundant equipments at modular capacity

b'	b''	Maximum Throughput	Probability of occurrence	[*100]	Expected Pieces Produced
UP	UP	100	$0,8 \cdot 0,8$	0,64	64
UP	DOWN	70	$0,8 \cdot (1-0,8)$	0,16	11,2
DOWN	UP	60	$(1-0,8) \cdot 0,8$	0,16	9,6
Expected number of Pieces Produced					84,8

Table 5. State Analysis Configuration

4.5.3. Minor stoppages and speed reduction

OEE theory includes in performance losses both the cycle time slowdown and minor stoppages. Also time losses of this category propagate, as stated before, throughout the whole production process.

A first type of performance losses propagation is due to the propagation of minor stoppages and reduced speed among machines in series system. From theoretical point of view, between two machines with the same cycle time ¹and without buffer, minor stoppage and reduced speed propagate completely like as major stoppage. Obviously just a little buffer can mitigate the propagation.

Several models to study the role of buffers in avoiding the propagation of performance losses are available in *Buffer Design for Availability* literature [22]. The problem is of scientific relevance, since the lack of opportune buffer between the two stations can indeed affect dramatically the availability of the whole system. To briefly introduce this problem we refer to a production system composed of two consecutive equipments (or stations) with an interposed buffer (figure 10).

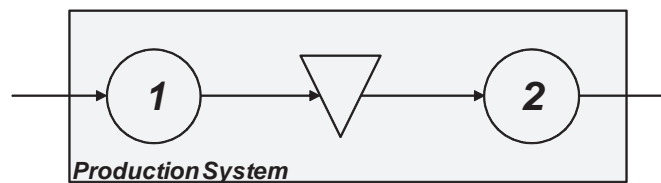

Figure 10. Station-Buffer-Station system. Adapted by [23]

Under the likely hypothesis that the ideal cycle times of the two stations are identical [23], the variability of speed that affect the stations is not necessarily of the same magnitude, due to its dependence on several factors. Furthermore Performance index is an average of the T_t , therefore a same machine can sometimes perform at a reduced speed and sometimes an highest speed². The presence of this effect in two consecutive equipments can be mutually compensate or add up. Once again, within the propagation analysis for production system design, the role of buffer is dramatically important.

When buffer size is null the system is in series. Hence, as for availability, speed losses of each equipment affect the performance of the whole system:

$$P_{system} = \prod_{i=1}^n P_i \quad (18)$$

Therefore, for the two stations system we can posit:

1 As shown in par. 3.1. When two consecutive stations present different cycle times, the faster station works with the same cycle time of slower station, with consequence on equipment OEE, even if any time losses is occurred. On the other hand, when two consecutive stations are balanced (same cycle time) if any time loss is occurring the two stations OEE will be 100%. Ideally, the higher value of performance rate can be reached when the two stations are balanced.

2 This time losses are typically caused by yield reduction (the actual process yield is lower than the design yield). This effect is more likely to be considered in production process where the equipment saturation level affect its yield, like furnaces, chemical reactor, etc.

$$P_{system} = \prod_{i=1}^2 P_i \quad (19)$$

But when the buffer is properly designed, it doesn't allow the minor stoppages and speed losses to propagate from a station to another. We define this Buffer size as Bmax. When, in a production system of n stations, given any couple of consecutive station, the interposed buffer size is Bmax (calculated on the two specific couple of stations), then we have:

$$P_{system} = \text{Min}_{i=1}^n (P_i) \quad (20)$$

That for the considered 2 stations system is:

$$P_{system} = \text{Min} (P_1, P_2) \quad (21)$$

Hence, the extent of the propagation of performance losses depends on the buffer size (j) that is interposed between the two stations. Generally, a bigger buffer increases the performance of the system, since it increases the decoupling degree between two consecutive stations, up to j=Bmax is achieved (j =0,..,Bmax).

We can therefore introduce the parameter

$$\text{Rel.P}(j) = \frac{P(j)}{P(B_{max})} \quad (22)$$

Considering the model with two station, figure 11, we have that:

$$\text{When } j = 0, \text{ Rel.P}(0) = \frac{P(0)}{P(B_{max})} = P(1) * P(2) / \min(P(1); P(2)); \quad (23)$$

$$\text{When } j = B_{max}, \text{ Rel.P}(B_{max}) = \frac{P(B_{max})}{P(B_{max})} = 1; \quad (24)$$

Figure 11 shows the trend of *Rel.P(j)* depending on the buffer size (j), when the performance rate of each station is modeled with an exponential distribution [23] in a flow shop environment. The two curves represent the minimum and the maximum simulation results. All the others simulation results are included between these two curves. Maximum curve represents the configuration with the lowest difference in performance index between the two stations, the minimum the configuration with the highest difference.

By analyzing the figure 11 it is clear how an inopportune buffer size affect the performance of the line and how increase in buffer size allows to obtain improve in production line OEE. By the way, once achieved an opportune buffer size no improvement derives from a further increase in buffer. These considerations of Performance index trend are fundamental for an effective design of a production system.

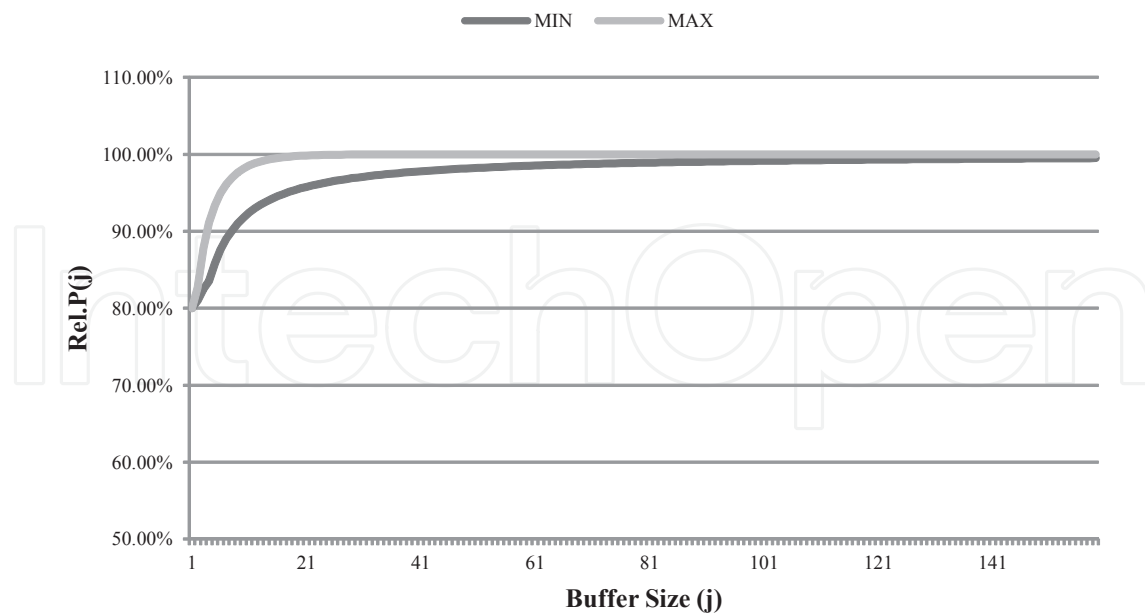

Figure 11. Rel OEE depending on buffer size in system affected by variability due to speed losses

4.5.4. Quality losses

In this paragraph we analyze how quality losses propagate in the system and if it is possible to assess the effect of quality control on OEE and OTE.

First of all we have to consider that quality rate for a station is usually calculated considering only the time spent for the manufacturing of products that have been rejected in the same station. This traditional approach focuses on stations that cause defects but doesn't allow to point out completely the effect of the machine defectiveness on the system. In order to do so, the total time wasted by a station due to quality losses should include even the time spent for manufacturing of good products that will be rejected for defectiveness caused by other stations. In this sense quality losses depends on where scraps are identified and rejected. For example, scraps in the last station should be considered loss of time for the upstream station to estimate the real impact of the loss on the system and to estimate the theoretical production capacity needed in the upstream station. In conclusion the authors propose to calculate quality rate for a station considering as quality loss all time spent to manufacture products that will not complete the whole process successfully.

From a theoretical point of view we could consider the following case for calculation of quality rate of a station that depends on types of rejection (scraps or rework) and on quality controls positioning. If we consider two stations with an assigned defectiveness S_j and each station reworks its scraps with a rework cycle time equal to theoretical cycle time, quality rate could be formulate as shown in case 1 in figure 12. Each station will have quality losses (time spent to rework products) due its own defectiveness. If we consider two stations with an assigned defectiveness S_j and a quality control station at downstream each station, quality rate could be formulate as shown in case 2 in figure 12. The station 1, that is the upstream station, will

have quality losses (time spent to work products that will be discarded) due to its own and station 2 defectiveness. If we consider two stations with an assigned defectiveness S_i and quality control station is only at the end of the line, quality rate quality rate could be formulate as shown in case 3 in figure 12. In this case both stations will have quality losses due to the propagation of defectiveness in the line. Case 2 and 3 point out that quality losses could be not simple to evaluate if we consider a long process both in design and management of system. In particular in the quality rate of station 1 we consider time lost for reject in the station 2.

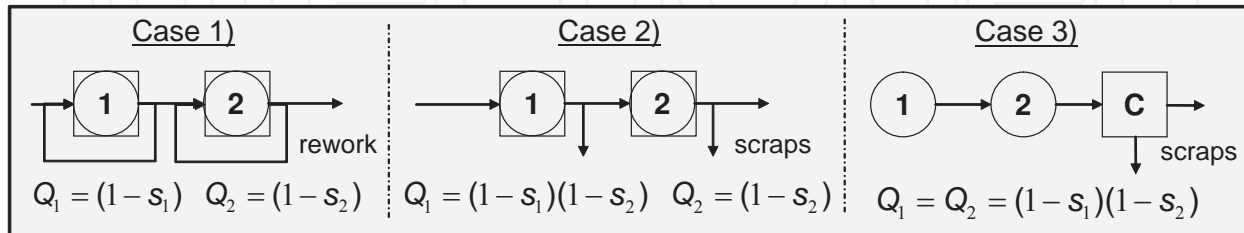

Figure 12. Different cases of quality rate calculation

Finally, it is important to highlight the different role that the quality efficiency plays during the design phase and the production.

When the system is producing, Operations Manager focuses his attention on the causes of the delectability with the aim to reduce it. When it is to design the production system, Operations Manager focuses on the expected quality efficiency of each station, on the location of quality control, on the process (rework or scraps) to identify the correct number of equipments or station for each activity of the process.

In this sense, the analysis is vertical during the production phase, but it follows the whole process during the design (figure 13).

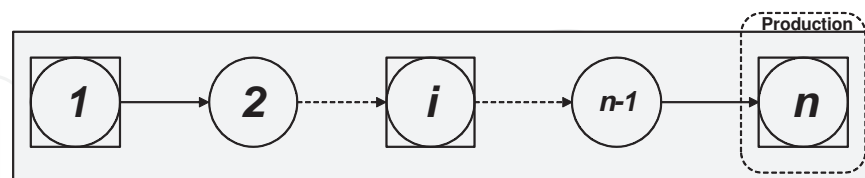

Figure 13. Two approaches for quality efficiency

5. The simulation model

To study losses propagation and to show how these dynamics affect OEE in a complex system [25] this chapter presents some examples taken from an OEE study of a real manufacturing system carried out by the authors through a process simulation analysis [19].

Simulation is run for each kind of time losses (Availability, Performance and Quality), to clearly show how each equipment ineffectiveness may compromise the performance of the whole system.

The simulation model is about a manufacturing plant for production of electrical cable. In particular we focus on production of unipolar electrical cable that takes place by a flow-shop process. In the floor plant the production equipment is grouped in production areas arranged according to their functions (process layout). The different production areas are located along the line of product flow (product layout). Buffers are present amongst the production areas to stock the product in process. This particular plant allows to analyze deeply the problem of OEE-OPE investigation due to its complexity.

In terms of layout the production system was realized as a job shop system, although the flow of material from a station to another was continuous and typical of flow shop process. As stated in (§2) the reason lies on due to the huge size of the products that passes from a station to another. For this reason the buffer amid station, although present, couldn't contain huge amount of material.

The process implemented in the simulation model is shown in figure 14. Entities are unit quantity of cable that have different mass amongst stations. Parameters that are data input in the model are equipment speed, defectiveness, equipment failure rate and mean time to repair. Each parameters is described by a statistical distribution in order to simulate random condition. In particular equipment speed has been simulated with a triangular distribution in order to simulate performance losses due to speed reduction.

The model evaluates OTE and OEE for each station as usually measured in manufacturing plant. The model has been validated through a plan of tests and its results of OEE has been compared with results obtained from an analytic evaluation.

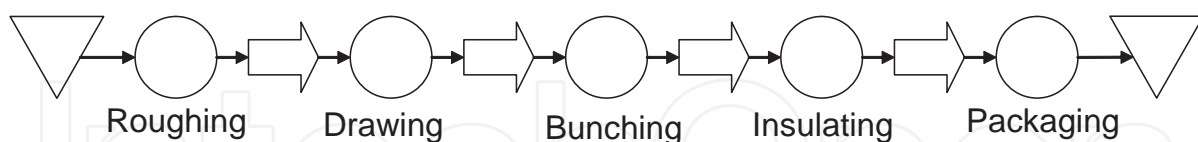

Figure 14. ASME representation of manufacturing process

5.1. Example of availability losses propagation

In accordance with the proposed method (§ 3.5) we show how availability losses propagate in the system and to assess the effect of buffer capacity on OEE through the simulation. We focus on the insulating and packaging working stations. Technical data about availability of equipment are: mean time between failure for insulating is 20000 sec while for packaging is 30000 sec; mean time between repair for insulating is 10000 sec while for packaging is 30000 sec. The cycle time of the working stations are the same equal to 2800 sec for coil. The quality rates are set to 1. Idling, minor stoppages and reduced speed are not considered and set to 0.

Considering equipment isolated from the system the OEE for the single machine is equal to its availability; in particular, relating to previous data, machines have an OEE equal to 0,67 and 0,5 respectively for insulating and packaging. The case points out how the losses due to major stoppage spread to other station in function of buffer capacity dimension.

A simulation has been run to study the effect of buffer capacity in this case. Capacity of buffer downstream of insulating has been changed from 0 to 30 coils for different simulations. The results of simulations are shown in figure 15a. The OEE for both machines is equal to 0,33 with no buffer capacity. This results is the composition of availability of insulating and packaging (0,67 x 0,5) as expected. The OEEs increase in function of buffer dimension that avoids the propagation of major stoppage and availability losses propagation. Also the OTE is equal to 0,33 that is, according to formulation in (1) and as previously explained, equal to OEE of the last station but assessed in the system.

Insulating and packaging increase rapidly OEEs since a structural limits of buffer capacity of 15 coils; from this value OEEs of two stations converge on value of 0,5. The upstream insulating station, that has an availability greater than packaging, has to adapt itself to real cycle time of packaging that is the bottleneck station.

It's important to point out that in performance monitoring of manufacturing plant the propagation of the previous losses is often gathered as performance losses (reduced speed or minor stoppage) in absence of specific data collection relating to major stoppage due to absence of material flow. So, if we consider also all other efficiency losses ignored in this sample, we can understand how much could be difficult to identify the real impact of this kind of efficiency losses monitoring the real system. Moreover simulation supports in system design in order to dimension buffer capacity (e.g. in this case structural limit for OEE is reached for 16 coils). Moreover through simulation it is possible to point out that the positive effect of buffer is reduced with an higher cycle time of machine as shown in figure 15b.

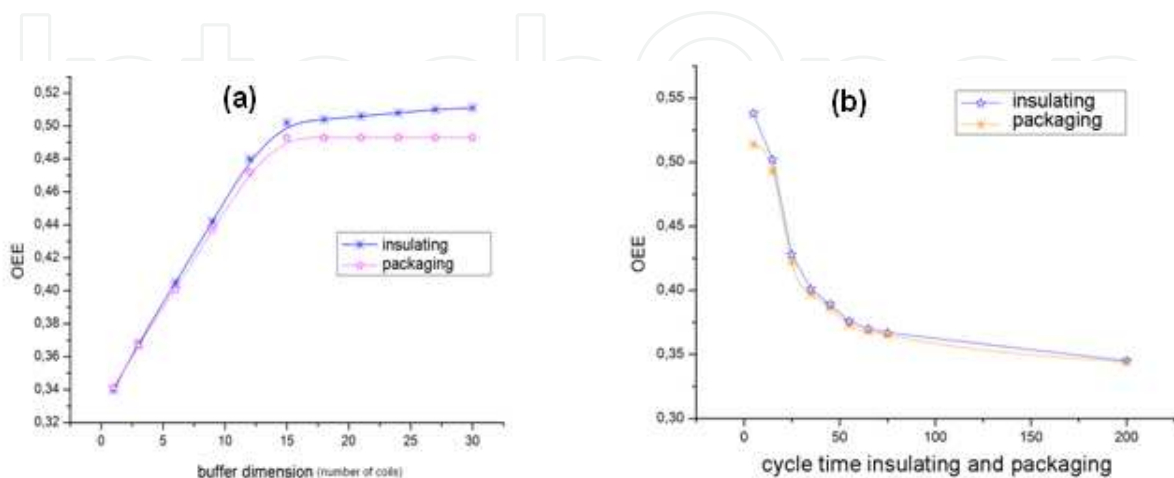

Figure 15. OEE in function of buffer dimension (a) and cycle time (b)

5.2. Minor stoppages and speed reduction

We run the simulation also for the case study (§ 4). The simulation shown how two stations, with the same theoretical cycle time (200 sec/coil) affected by a triangular distribution with a performance rate of 52% as single machine, have: 48% of performance rate with a capacity buffer of 1 coil and 50% of performance rate with a capacity buffer of 2 coils. But if we consider two stations with the same theoretic cycle time but affects by different triangular distributions so that theoretic performance rates differ, simulation shows how the performance rates of two stations converge towards the lowest one as expected (19), (20).

Through the same simulation model we considered also the second type of performance losses propagation, due to the propagation of reduced speed caused by unbalanced line. Figure 16 shown the effect of unbalanced cycle time of stations relating to insulating and packaging. The station have the same P as single machine equal to 67% but different theoretical cycle time. In particular insulating, the upstream station, is faster than packaging. Availability and quality rate of stations is set to 1. The buffer capacity is set to 1 coil. A simulation has been run to study the effect of unbalancing station. Theoretical cycle time of insulating has been changed since theoretical cycle time of packaging that is fixed in mean. The simulation points out that insulating has to adapt itself to cycle time of packaging that is the bottleneck station. This results in the model as a lower value for performance rate of insulating station. The same happens often in real systems where the result is influenced by all the efficiency losses at the same time. The effect disappears gradually with a better balancing of two stations as in figure 16.

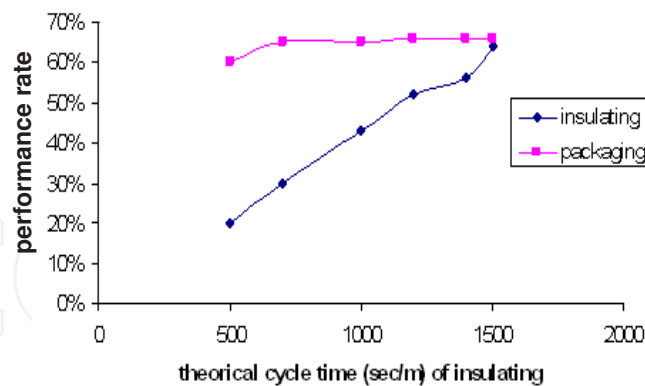

Figure 16. Performance rate of insulating and packaging in function of insulating cycle time

5.3. Quality losses

In relation to the model, this sample focuses on the drawing and bunching working stations that have defectiveness set to 5%, the same cycle times and no other efficiency losses. The quality control has been changed simulating case 2 and 3. The results of simulation for the two

cases are shown in table 6 in which the proposal method has compared with the traditional one. The proposal method allowed to identify the correct efficiency, for example to dimension the drawing station, because it considers time wasted to manufacture products rejected in bunching station. The difference between values of Q_2 and OTE is explained by the value of $P_2=0,95$ that is due to the propagation of quality losses for the upstream station in performance losses for the downstream station. Moreover about positioning of quality control the case 2 has to be prefer because the simulation shows a positive effect on the OTE if the bunching station is the system bottleneck (as it happens in the real system).

	Proposal method			Traditional method		
	Q1	Q2	OTE	Q1	Q2	OTE
Case 2)	0,95 ²	0,95	0,95 ²	0,95	0,95	0,95 ²
Case 3)	0,95 ²	0,95 ²	0,95 ²	--	0,95 ²	0,95 ²

Table 6. Comparison of quality rate calculation and evaluation of impact of quality control positioning on quality rates and on OTE

6. Conclusions

The evaluation of Overall Equipment Effectiveness (OEE) and Overall Throughput Effectiveness (OTE) can be critical for the correct estimation of workstations number needed to realize the desired throughput (production system design), as also for the analysis and the continuous improvement of the system performance (during the system management).

The use of OEE as performance improvement tool has been widely described in the literature. But it has been less approached in system design for a correct evaluation of the system efficiency (OTE), in order to study losses propagation, overlapping of efficiency losses and effective actions for losses reduction.

In this chapter, starting by the available literature on time losses, we identified a simplified set of relevant time-losses that need to be considered during the design phase. Then, through the simulation, we shown how OEE of single machine and the value of OTE of the whole system are interconnected and mutually influencing each other, due to the propagation of availability, performance and quality losses throughout the system.

For each category of time losses we described the effects of efficiency losses propagation from a station to the system, for a correct estimation and analysis of OEE and OTE during manufacturing system design. We also shown how to avoid losses propagation through adequate technical solutions which can be defined during system design as the buffer sizing, the equipment configuration and the positioning of control stations.

The simulation model shown in this chapter was based on a real production system and it used real data to study the losses propagation in a manufacturing plant for production of electrical

cable. The validation of the model ensures the meaningful of the approach and of the identified set of possible solutions and hints.

By analyzing and each time losses we also shown how the choices taken during the design of the production system to increase the OTE (e.g. buffer size, maintenance configuration, etc.) affect the successive management of the operations.

Acknowledgements

The realization of this chapter would not have been possible without the support of a person whose cooperated with the chair of Operations Management of University of Rome "Tor Vergata" in the last years, producing valuable research. The authors wish to express their gratitude to Dr. Bruna Di Silvio without whose knowledge, diligence and assistance this work would not have been successful.

Author details

Vittorio Cesarotti¹, Alessio Giuiusa^{1,2} and Vito Introna¹

1 University of Rome "Tor Vergata", Italy

2 Area Manager Inbound Operations at Amazon.com

References

- [1] H. H. S., «Manufacturing productivity improvement using effectiveness metrics and simulation analysis,» 2002.
- [2] B. I., «Effective measurement and successful elements of company productivity: the basis of competitiveness and world prosperity,» *International Journal of Production Economics*, vol. 52, pp. 203-213, 1997.
- [3] Jeong, P. D. K.Y., «Operational efficiency and effectiveness measurement,» *International Journal of Operations and Production Management*, n. 1404-1416, (2001). , 21
- [4] N. S., *Introduction to TPM- Total Productive Maintenance*, Productivity Press, 1988.
- [5] S. R.J., *World Class Manufacturing. The lesson of simplicity Applied*, The Free Press, 1987.
- [6] Womack, J. D. J.P., *Lean Thinking*, Simon & Schuster, (1996).

- [7] Dixon, N. A. V. J.R., The new performance challenge. Measuring operations for world-class competition, Dow Jones Irwin, (1990).
- [8] S. D., «Can CIM improve overall factory effectiveness,» in *Pan Pacific Microelectronic Symposium*, Kauai, HI, 1999.
- [9] Waters, W. D. D.J., Operations Management, Kogan Page Publishers, (1999).
- [10] Chase, A. N. J. F. R.B., Operations Management, McGraw-Hill, (2008).
- [11] A. V. A., Semiconductor Manufacturing Productivity- Overall Equipment Effectiveness (OEE) guidebook, SEMATECH, 1995.
- [12] Rooda, D. R. A. J. J.E., «Equipment effectiveness: OEE revisited,» *IEEE Transactions on Semiconductor Manufacturing*, n. 1, (2005). , 18 , 189-196.
- [13] Gamberini, G. L. R. B. R., «Alternative approaches for OEE evaluation: some guidelines directing the choice,» in *XVII Summer School Francesco Turco*, Venice, (2012).
- [14] Grando, T. F. A., «Modelling Plant Capacity and Productivity,» *Production Planning and Control*, n. 3, (2005). , 16 , 209-322.
- [15] Spada, C. V. C., «The Impact of Cultural Issues and Interpersonal Behavior on Sustainable Excellence and Competitiveness: An Analysis of the Italian Context,» *Contributions to Management Science*, (2008). , 95 - 113 .
- [16] Badiger, G. R. & Proposal, A. , «A. evaluation of OEE and impact of six big losses on equipment earning capacity,» *International Journal Process Management & Benchmarking*, (2008). , 235 - 247 .
- [17] Jacobs, A. N. C. B. & Operations, R. F. and supply chain management, McGraw-Hill, A cura di, (2010).
- [18] Oechsner, R. From overall equipment efficiency(OEE) to overall Fab effectiveness (OFE),» *Materials Science in Semiconductor Processing*, (2003). , 5 , 333-339.
- [19] Introna, D. S. B. C. V, & Flow-shop, V. process oee calculation and improvement using simulation analysis,» in *MITIP*, Florence, (2007).
- [20] R. MA, «Factory Level Metrics: Basis for Productivity Improvement,» in *Proceedings of the International Conference on Modeling and Analysis of Semiconductor*, Tempe, Arizona, USA, 2002.
- [21] Scott, P. R. D., «Can overall factory effectiveness prolong Moore's Law?,» *Solid State Technology*, (1998). , 41 , 75-82.
- [22] B. D., «Buffer size design linked to reliability performance: A simulative study,» *Computers & Industrial Engineering*, vol. 56, p. 1633-1641, 2009.
- [23] Introna, G. A. V. V., «Increasing Availability of Production Flow lines through Optimal Buffer Sizing: a Simulative Study,» in *The 23rd European Modeling & Simulation Symposium (Simulation in Industry)*, Rome, (2011).

- [24] Connor, P. D. T. O. *Practical Reliability Engineering (Fourth Ed.)*, New York: John Wiley & Sons, (2002).
- [25] Kane, J. O. Simulating production performance: cross case analysis and policy implications,» *Industrial Management & Data Systems*, n. 4, (2004). , 104 , 309-321.
- [26] Gondhinathan, B. A, & Proposal, R. , «A. evaluation of OEE and impact of six big losses on equipment earning capacity,» *International Journal Process Management & Benchmarking*, n. 3, (2008). , 2 , 235-247.

IntechOpen