

# We are IntechOpen, the world's leading publisher of Open Access books Built by scientists, for scientists

**4,800**

Open access books available

**122,000**

International authors and editors

**135M**

Downloads

Our authors are among the

**154**

Countries delivered to

**TOP 1%**

most cited scientists

**12.2%**

Contributors from top 500 universities



**WEB OF SCIENCE™**

Selection of our books indexed in the Book Citation Index  
in Web of Science™ Core Collection (BKCI)

Interested in publishing with us?  
Contact [book.department@intechopen.com](mailto:book.department@intechopen.com)

Numbers displayed above are based on latest data collected.

For more information visit [www.intechopen.com](http://www.intechopen.com)



---

# Bandwidth Optimization of Aperture-Coupled Stacked Patch Antenna

---

Marek Bugaj and Marian Wnuk

Additional information is available at the end of the chapter

<http://dx.doi.org/10.5772/54661>

---

## 1. Introduction

The microstrip antennas have been one of the most innovative fields of antenna techniques for the last three decades. Microstrip antennas have several advantages such as lightweight, small-volume, and that they can be made conformal to the host surface. In addition, these antennas are manufactured using printed-circuit technology, so that mass production can be achieved at a low cost. Microstrip antennas, which are used for defense and commercial applications, are replacing many conventional antennas [1]. However, the types of applications of microstrip antennas are restricted by the narrow bandwidth (BW). Accordingly, increasing the BW of the microstrip antennas has been a primary goal of research for many years. This is reflected in the large number of papers on the subject published in journals and conference proceedings. In fact, several broadband microstrip antennas configurations have been reported in the last few decades. They have additional advantages: simplicity of production, small weight, narrow section, easiness of integration of radiators with feeding system. However, this construction also has the following disadvantages: narrow band, limited power capacity, not sufficient efficiency of radiation. Still ongoing search for solutions to obtain a broad range of work in the microstrip antenna. The aim of this study is to demonstrate that it is possible to build a microstrip antenna with wide range of work.

The basic configuration of microstrip antenna consists of metallic strip printed on thin earthed dielectric base. The feeding is accomplished through concentric cable, it runs perpendicularly through a substrate or a strip line runs on a substrate in the plane of aerial [15]. The aperture coupling feed was proposed by Pozar and it has many advantages over other types of feeds. These include shielding of the antenna from spurious feed radiating, the use of suitable substrates for feed structure and the antenna, and the use of thick substrates for increasing the antenna bandwidth [5].

The methods of analysis and projection of microstrip antennas have developed simultaneously with the development of aerials. Nowadays several methods of analyzing the antennas on dielectric surface are used, however, the most commonly used ones are the full wave model based on Green's function and the method of moments where analysis relies on solution of integral equation, concerning electric field, with regard to unknown currents flowing through elements of the antenna and its feeding system [7].

Millimeter wave printed antennas can take on many forms, including microstrip patch elements and a variety of proximity coupled printed radiators. The microstripline-fed printed slot and the aperture coupled patch are examples of the latter type and may be useful in certain planar array applications [2].

The paper presents the model of the antenna on which the influence of parameters on antenna bandwidth simulation was conducted (the influence of changes permittivity and thickness of every layer). One of the most important parameters which have been calculated is the bandwidth. Its value depends on antenna parameters (thickness and permittivity of every layer). The paper shows that as a result of optimization which has been demonstrated we can create a planar antenna with wide range of work. The analysis process of multilayer microstrip antennas is complex and time consuming[4,11].

One of the main problems associated with the use of planar antennas in radio links is their relatively narrow frequency band of operation, it has been indicated at the outset of this chapter. This problem has been described in literature, in books such as monographs [6] or [9, ch. 3 and 6] and in paper such as [8]. The next literature is worth noting the work of Borowiec and Słobodzian, who described [10] a method of increasing bandwidth of planar antennas. Unfortunately, the bandwidth of the antenna work, which was obtained only at 15-18 %. Increasing the frequency band planar antenna work can be done through the use of:

- Tuning frequency planar radiators,
- Dual frequency transmitters,
- Multilayer structures.

## 2. Analyzed antenna

Aperture coupling antenna feeding method was first suggested in 1985 by David.M. Pozar [9]. Using this method of feeding antenna we have hope to obtain a wide operating bandwidth  $B$ , which has tried to prove, by various authors [9]. The basic condition for obtaining satisfactory results is to optimize the parameters of multilayer antennas.

An exploded view of this type antenna is shown in Figure 1. The antenna consists of four layers with two radiators. Radiators are microstrip patches; they are on layers of  $h_2$  and  $h_4$ . The microstrip patch is feed by microstrip line trough slot in the common ground plane. The width microstrip line is  $W$  and is printed on a substrate described by  $h_1$  and  $\epsilon_1$ . Coupling of the slot

to the dominant mode of the patch and the microstrip line occurs because the slot interrupts the longitudinal current flow in them[3].

For an analyzed planar structure activity of the antenna is more important than surrounding space, so the analyzed area is not to large. But it is large enough so that the results would reflect analyzed area precisely and strictly, taking into account limited computing power of a computer. One of the most important parameters, which will be calculated, is bandwidth whose value is dependent from parameters of antenna. The described aerial is structure multi resonance.

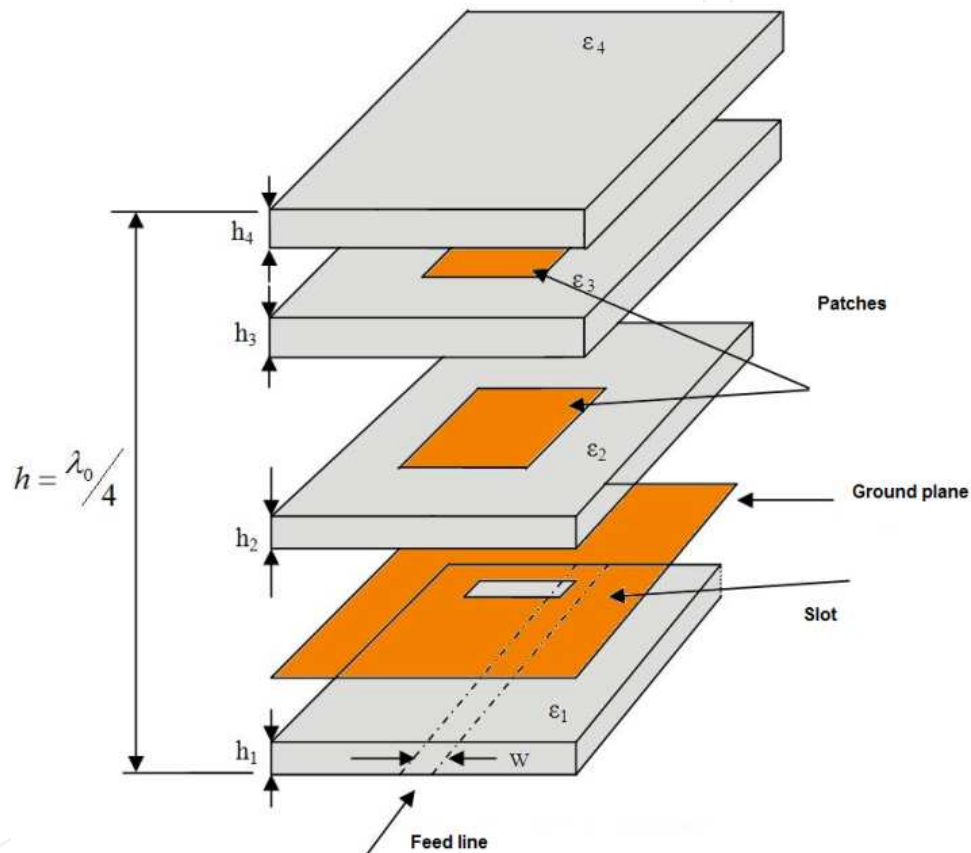


Figure 1. An aperture coupled microstrip patch antenna.

### 3. Optimization

Choice of laminates and other materials for the implementation of the antenna and antenna system is one of the most important steps in the process of designing microstrip antennas. Planar microstrip antenna can be built with the theoretically infinite number of layers. This solution, unfortunately, leads to a reduction in antenna efficiency and leads to excitation of surface waves. In order to provide the required bandwidth efficiency of the antenna work and

we need to limit the number of layers to this, to obtain both wide bandwidth operation and high efficiency.

In this case the optimization is folded, since all possible combinations of parameters will be examined. This optimization is time-consuming and complex process. In Figure 2 an algorithm of the optimization was presented. Bandwidth planar antenna can be expressed using the equation (1):

$$B = \frac{VSWR - 1}{\frac{c\sqrt{\epsilon_e}}{4f_0h}} \quad (1)$$

where:

$Q$  - quality factor

$f_0$  - center frequency of band

$\epsilon_e$  - permittivity

$h$  - thickness of antenna

Optimization parameters:

- Layers permittivity:  $\epsilon_1, \epsilon_2, \epsilon_3, \epsilon_4$
- Layers thickness:  $h_1, h_2, h_3, h_4$  (Fig.1)

In order to optimize the iterative method was used. It is time consuming but allowed us to investigate the effect of dielectric parameters of the antenna operating band (fig.3). In the optimization process the following steps of changes of input parameters were accepted:

- electric penetrability of layers ( $\epsilon_1, \epsilon_2, \epsilon_3, \epsilon_4$ ) – 0.05
- thickness of layers ( $h_1, h_2, h_3, h_4$ ) – 0.05 [mm]

#### 4. Limitations of the optimization

Permeability and thickness of each layer are limited typical values offered by various manufacturers such as ROGERS, ARLON, etc. Different companies offer dielectrics with very similar structural parameters. Therefore, the values of  $h$  and  $\epsilon_r$  values are limited discrete values occurring in the family.

As a result of computational series this way conducted for every of layers three-dimensional graphs giving the full image and the inspection of all possible combinations to the thickness

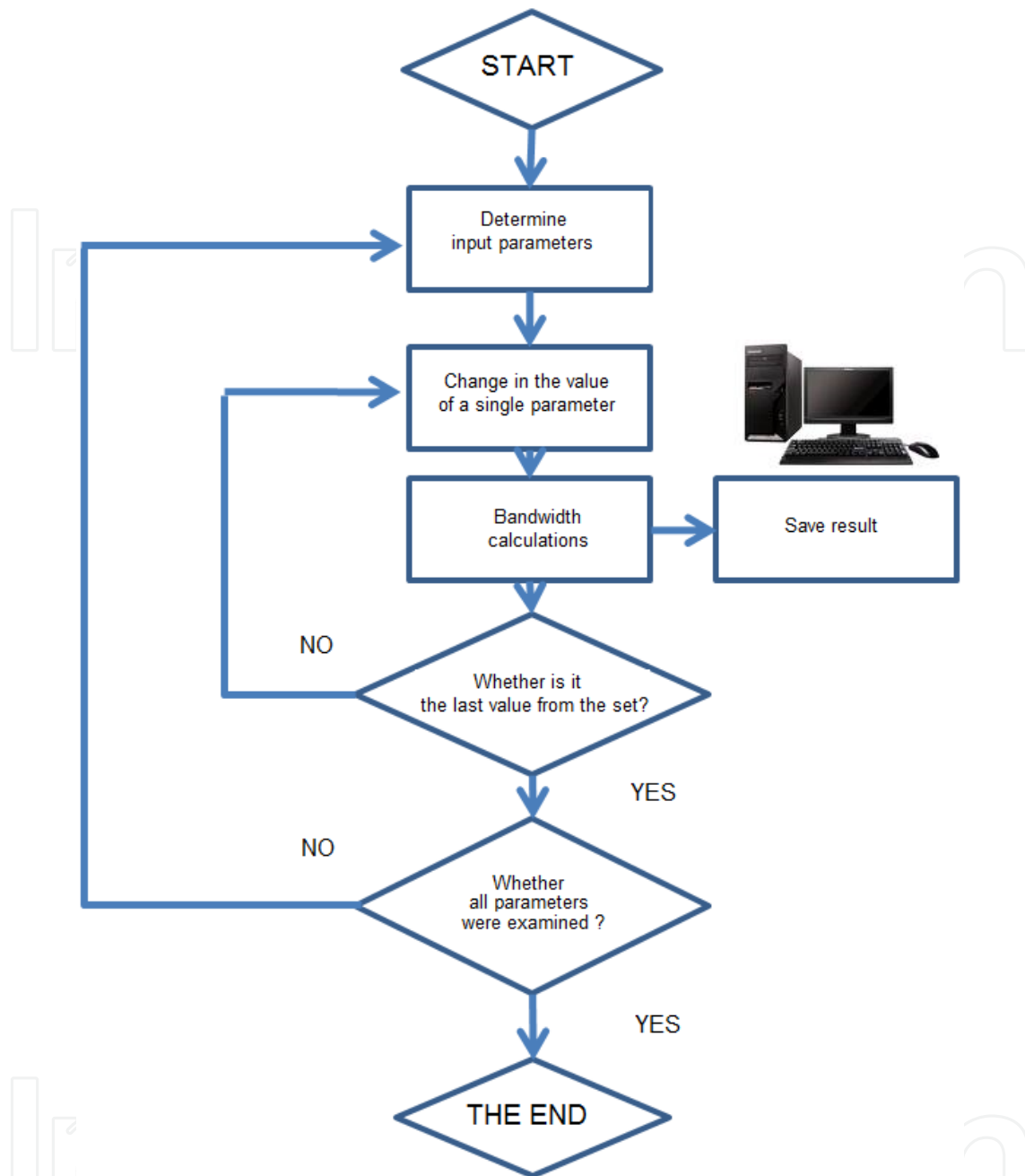


Figure 2. Algorithm of the optimization

and permittivity (Figure 3). On each of graphs optimum areas marked on the color red. Layer  $h_3$  has the optimum area smallest of all examined layers.

## 5. The results of the optimization process

The object of the study is primarily broadband properties of the antenna input impedance and directional properties, which determine the further use of the model. Particular attention is

paid to the bandwidth of the work, which was the basic parameter determining the final construction of the structure. Using the current state of knowledge should lead to the use of dielectrics with relatively lowest values of electrical permittivity. Optimization was carried out by examining the every of the layers in structure. The results to optimize were presented on the graphs below. The optimization process was as follows: for each layer has been studied sufficiently large set of combinations of thickness and permeability, and for each of them determined the bandwidth of operation. As a result of a series of calculations for each of the layers was formed three-dimensional graphs which give a complete picture and review all possible combinations of thickness and permeability. On each of the graphs obtained areas with the best bandwidth - in the diagrams shown in red. As can be seen in the following analysis for each layer there is at least some optimum combinations. A limitation of choosing the right laminate is the availability of mass-produced laminates of sufficient thickness and permeability. Laminates as well as other electronic components such as resistors and capacitors are produced in the so-called series with typical values, with defined thicknesses and permittivity. This is some major difficulty for designers.

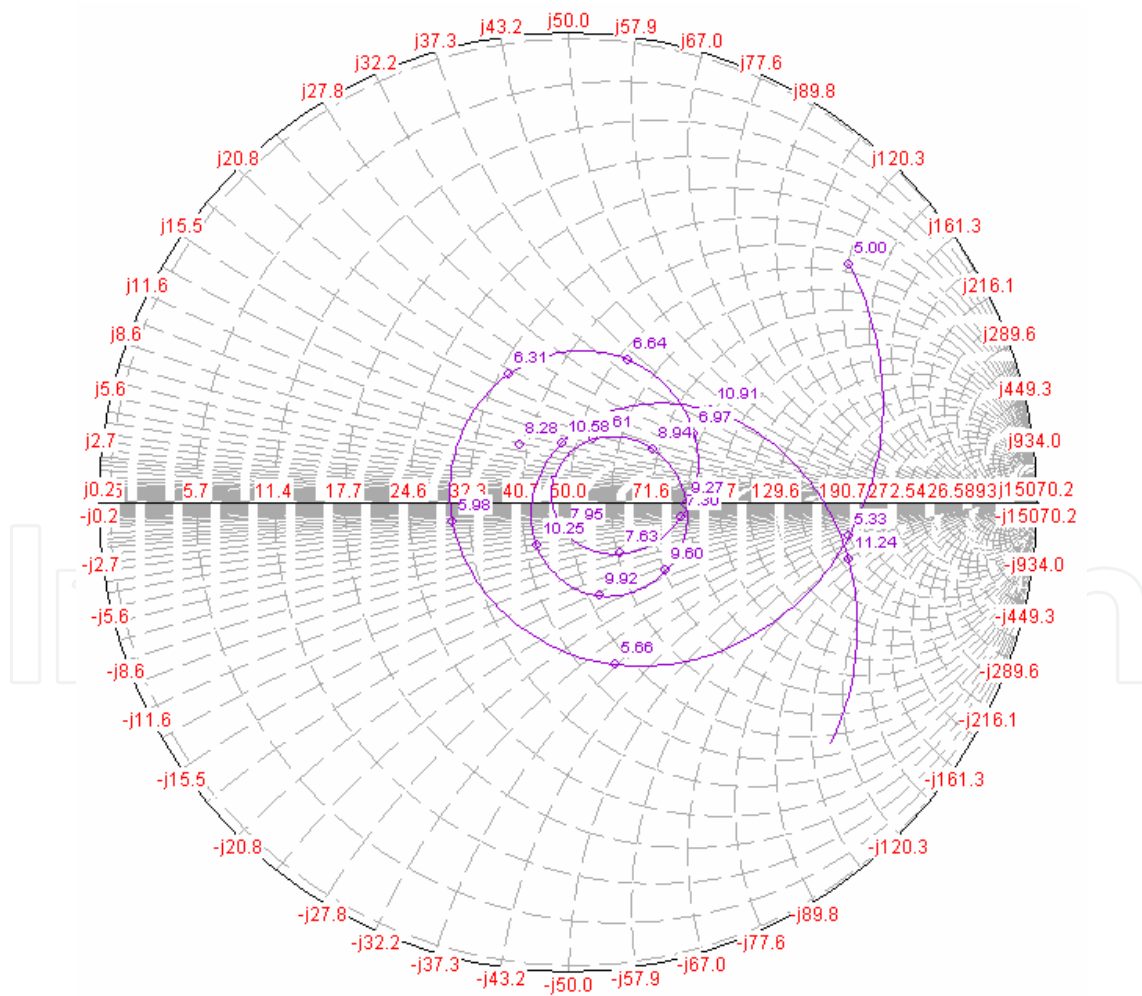


Figure 3. Results of optimization for the parameters of the four layers of the aperture-coupled microstrip antenna



The results also show how little room for maneuver there is for choosing the right laminate structure. For some structures may unfortunately find that the physical realization is impossible because in our area of interest is not in any laminate. Then we would look for a solution by changing the dimensions of the radiating elements so as to be able to use existing laminates.

As a result of optimization selected the following dielectrics:

$h_1=1,57$  mm,  $\epsilon_1 =2.2$  - Rogers-RT/duroid 5880

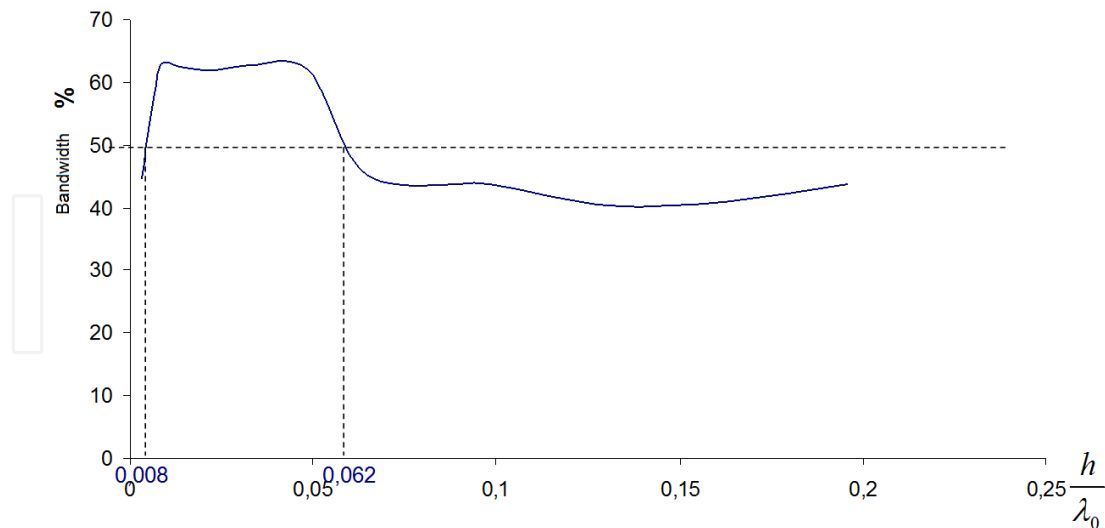
$h_2=3,048$  mm,  $\epsilon_2 =2.6$  -Rogers-RT/ULTRALAM 2000

$h_3=3$  mm,  $\epsilon_3 =1.07$ - polymethacrylamid hard foam.

$h_4=0,25$ mm,  $\epsilon_4 =3.50$  - Rogers/RO3035

## 6. Influence of dielectric parameters on antenna bandwidth

The thickness of layers in a multilayer structure is one of the more important elements affecting directly on the bandwidth of the work the whole structure of radiation. Analysis the impact of the thickness the layers on the bandwidth in the structure consisted of the cyclic change in thickness (in steps of 0.05 mm) layer and setting the bandwidth (VSWR <2) when the other elements in the construction of the antenna in the same state. Maintaining other elements of the antenna can be sure that the effect is obtained only from changes in thickness. The analysis was performed for all layers occurring in the structure. For obtained in the optimization process the parameters of laminates determined parameters of the antenna.

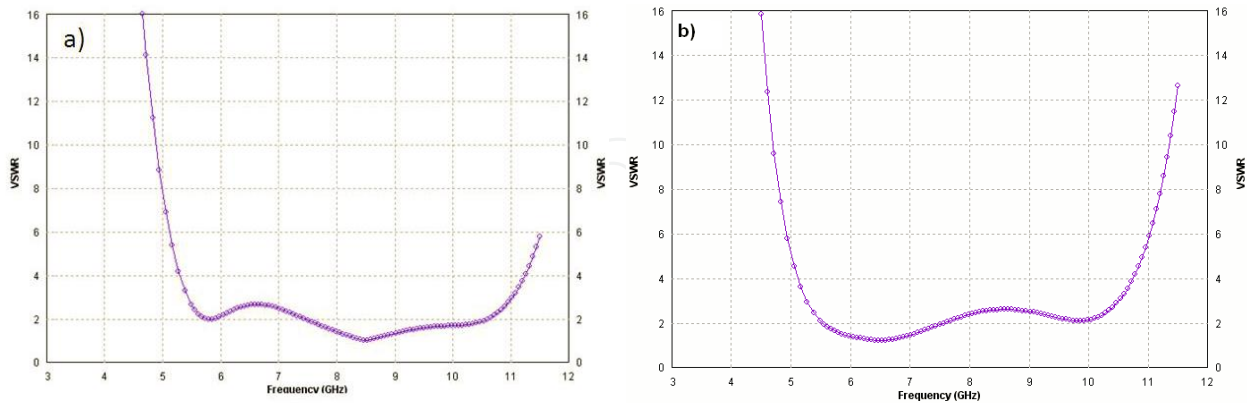


**Figure 4.** Influence thickness of  $h_4$  layer on bandwidth

The first was analyzed  $h_4$  layer. It is located at the top of the antenna. The results are illustrated in Figure 4. The results can be concluded that the bandwidth of the work at a level above 50% can be achieved by changes in the thickness of this layer in the range from 0.008 to 0.062 $\lambda_0$ .



When we increase the thickness of the layer above the limit then the range bandwidth is narrows in the area of the upper frequencies.



**Figure 5.** VSWR for values outside of the optimal range (a) thickness  $>0.062\lambda_0$  (b) thickness  $<0.008\lambda_0$

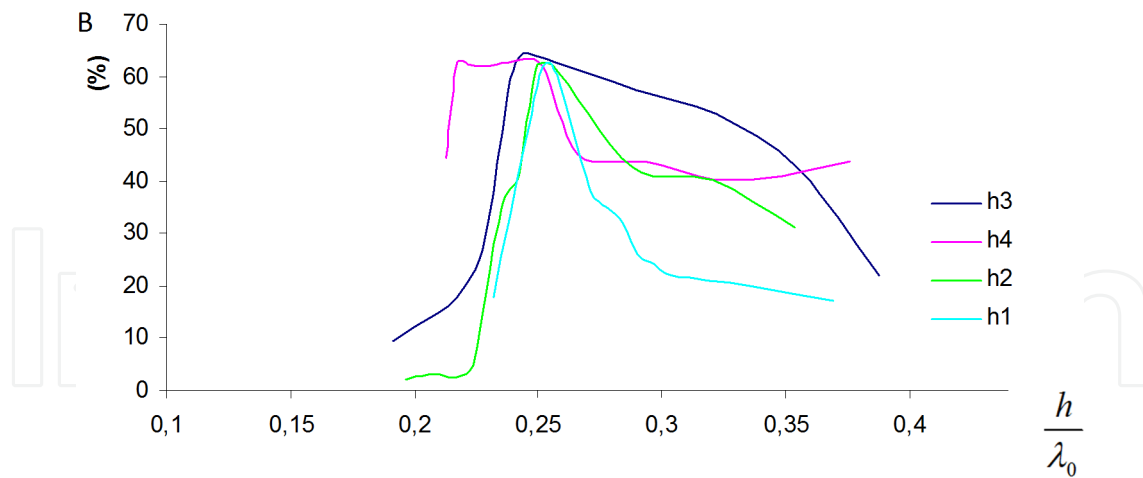
Using the same calculation process, we determined the influence of thickness  $h_3$  to  $h_1$  on the bandwidth of the antenna.

## 7. Study the impact of the total thickness of the antenna operating bandwidth

Using the results obtained during the optimization and additional numerical calculations can be concluded that the multilayer structure achieves the highest bandwidth for the measured quantity of work, as the ratio of thickness of the antenna to the wavelength and containing in the range of  $0.21-0.27\lambda_0$ . When the thickness of the structure has a value outside this range is rapidly declining bandwidth operation. For all layers of optimum thickness ratio of the total structure to the radiated wave length (center frequency 8.27 GHz antenna operation) at which it achieves the greatest band of operation is in all cases very close to the value of  $0.25\lambda_0$  (fig.6)

Mistake how we can make when selecting layer  $h_1$  and  $h_2$  is the smallest of all the layers, both in terms of thickness and permeability. Minor deviations from the optimum value (due to the bandwidth of operation) the effect of limiting the bandwidth of operation well below 50%. For working bandwidth  $> 50\%$  of the thickness and permittivity of each layer should contain, respectively, in the intervals:

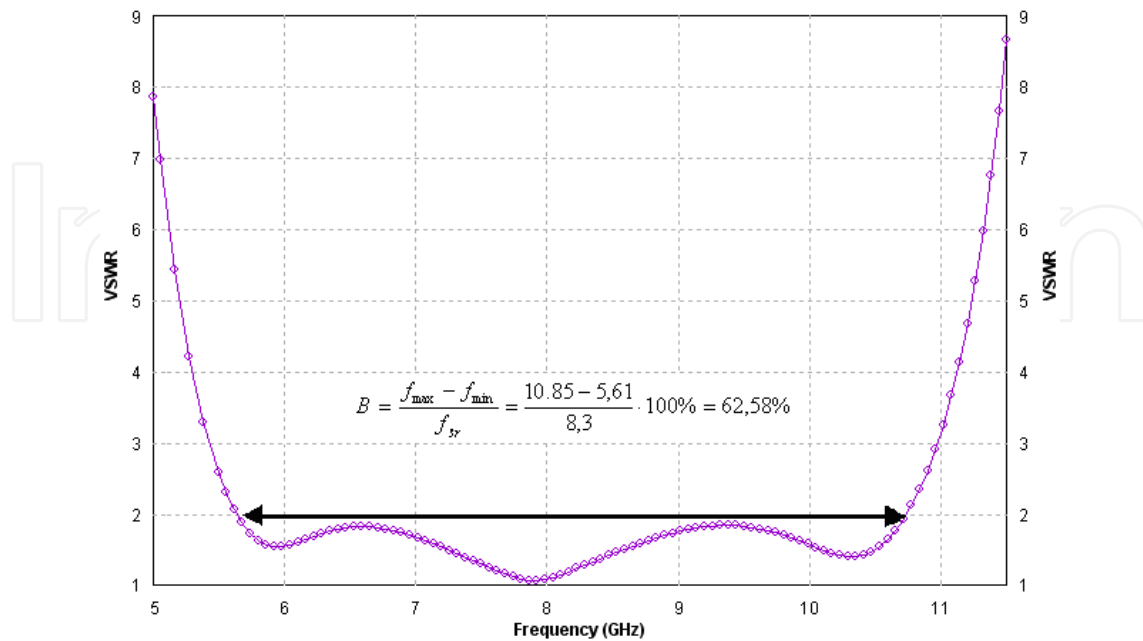
- layer  $h_1$ : thickness from  $0.041$  to  $0.062\lambda_0$  and permittivity  $\epsilon_{r1}$  from  $1.78$  to  $2.62$ ;
- layer  $h_2$ : thickness from  $0.084$  to  $0.121\lambda_0$  and permittivity  $\epsilon_{r2}$  from  $2.28$  to  $2.77$ ;
- layer  $h_3$ : thickness from  $0.077$  to  $0.176\lambda_0$  and permittivity  $\epsilon_{r3}$  from  $1$  to  $1.36$ ;
- layer  $h_4$ : thickness from  $0.008$  to  $0.062\lambda_0$  and permittivity  $\epsilon_{r4}$  from  $2.05$  to  $4.62$ ;



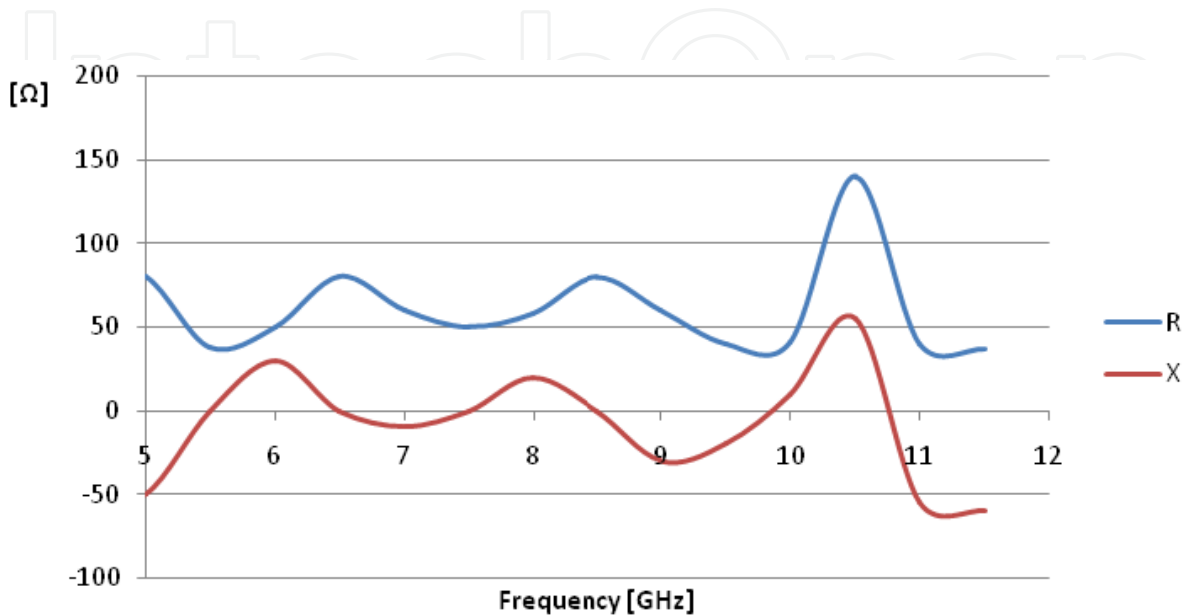
**Figure 6.** Bandwidth as a function of thickness of the multilayer structure due to the change in thickness of each layer.

### 8. Calculation of parameters for optimum model

For optimized model antenna the electrical parameters were determined: VSWR, impedance, characteristic of radiation. Figure 6 shows the VSWR of optimal single patch antenna. However, the input impedance is shown in Figures 7 (reactance and resistance). Resistance in the range of work fluctuates around the value of 50Ω. the reactance value fluctuates around the value of the 0.



**Figure 7.** VSWR of optimal single patch antenna.



**Figure 8.** Reactance and resistance of optimal single patch antenna.

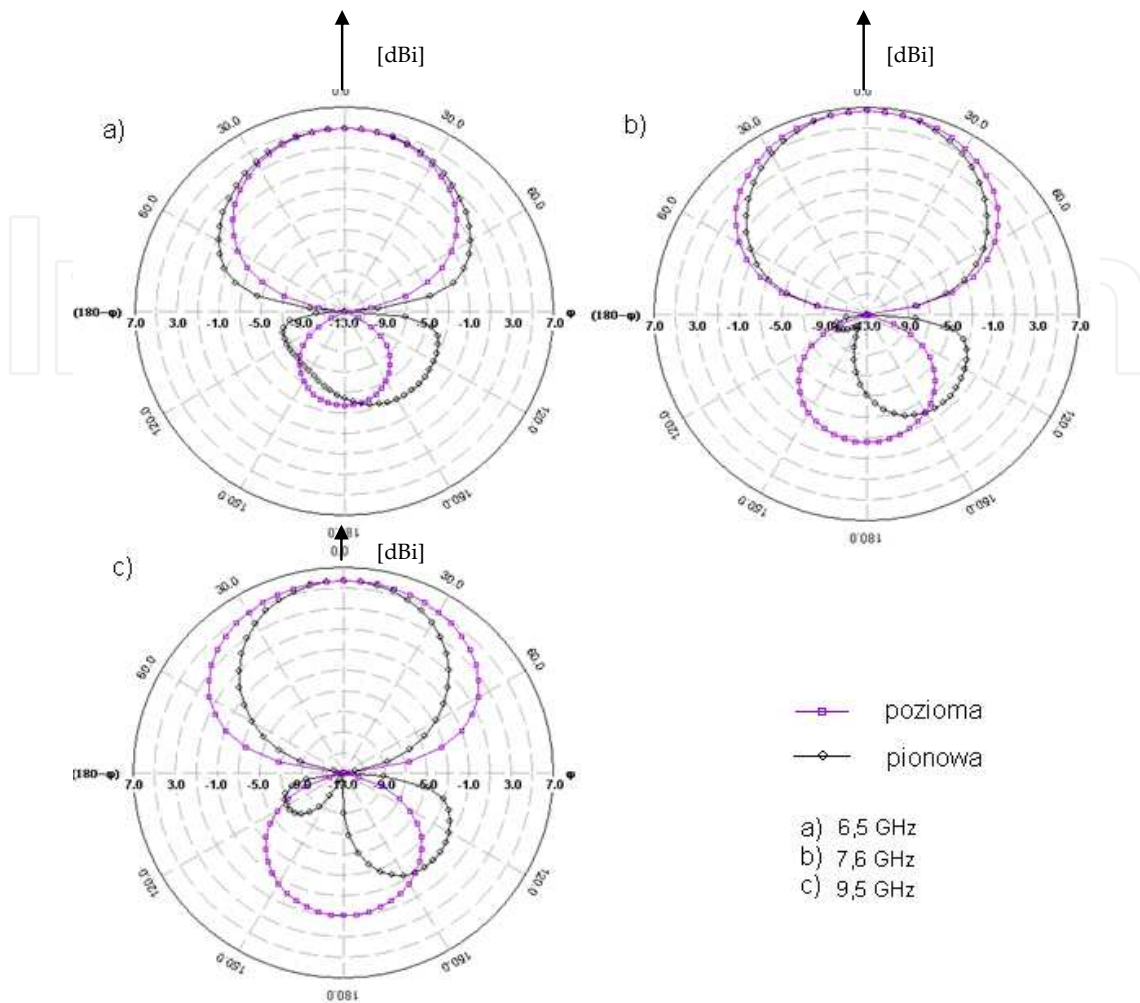
The resultant input impedance allows the full use of the antenna in the whole range of work. As a result of optimizing the working range was achieved 62.5% (VSWR<2).

The process of optimization and testing of all parameters of the antenna was carried out using IE3D software (Zeland Software) based on the method of moments. In order to verify the correctness of their analysis before the construction of physical model of antenna we one more time made calculations the VSWR and radiation characteristics of the final model using a different calculation method (fig.10 and 11). To perform calculations in order to verify the selected software CST Microwave Studio based on FDTD method. Smith chart of wideband multilayer antenna is show in figure 9.

Input impedance of the antenna in operating band varies in the range of 30 to 70 [Ω]. This input impedance makes full use of the antenna in the whole operating band. Such changes in the impedance is a side effect for maximum bandwidth. It should be noted that despite these changes the antenna VSWR <2.

The radiation pattern of antenna has stable shape in the whole operating band. In the whole frequency range the gain of antenna (calculated) is around 5 [dBi]. The width of the radiation characteristics (- 3dB) is around 100 °.





**Figure 11.** Radiations pattern of multilayer antenna-simulations

Selection of components of the antenna (thickness and permeability layers) gives the value of  $VSWR < 2$ . The antenna's radiating patch has very similar level and distribution of currents. The main radiating element is side edges of the patches are the same as in single-layer structures. The distribution of currents guarantees consistent with the direction of the feed line.

## 9. Physical model of the antenna

In the figure 13 shows the antenna layers. First from left is put layer h1 with coupling slot. Holes in layers of the antenna were carried out intentionally with a view to precise connecting with oneself layers, they aren't bringing changes of parameters of the aerial in.

In Figure 13 a ready model of the aerial was described, the structure of aerials is coated with foamed PCV. They aren't bringing changes of parameters of the aerial in (checked in measurements).

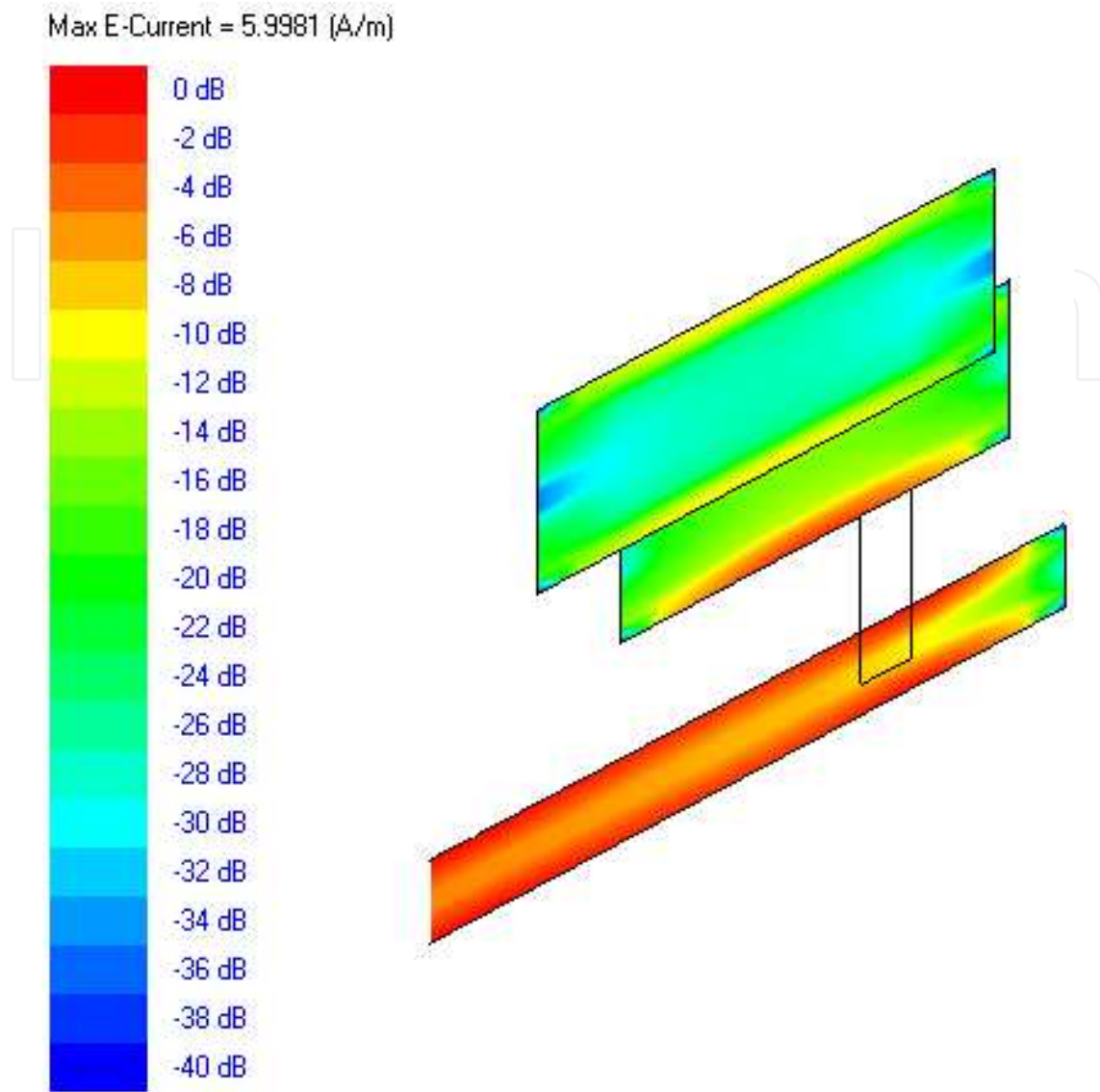


Figure 12. Current distribution in antenna elements

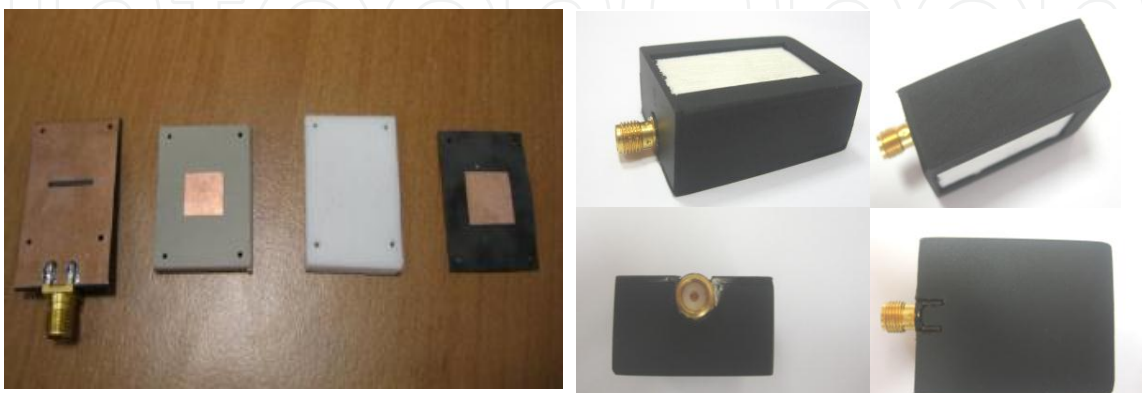
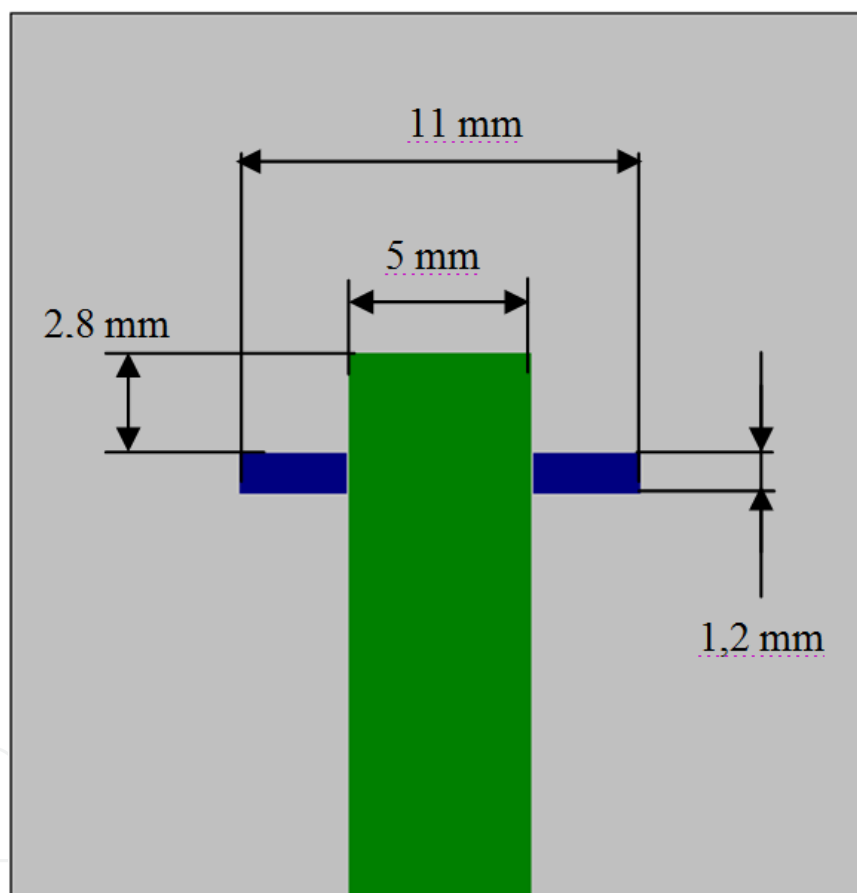


Figure 13. Layers of antenna and model of antenna.



Obtained in a multi-layer band work is not possible in single layer antennas [2]. In the whole range of work input impedance of the antenna is stable. Antenna input impedance in the band of work is changing in the range of 36 to 67 [ $\Omega$ ]. Such changes in the impedance are a side effect for a maximum bandwidth of work.

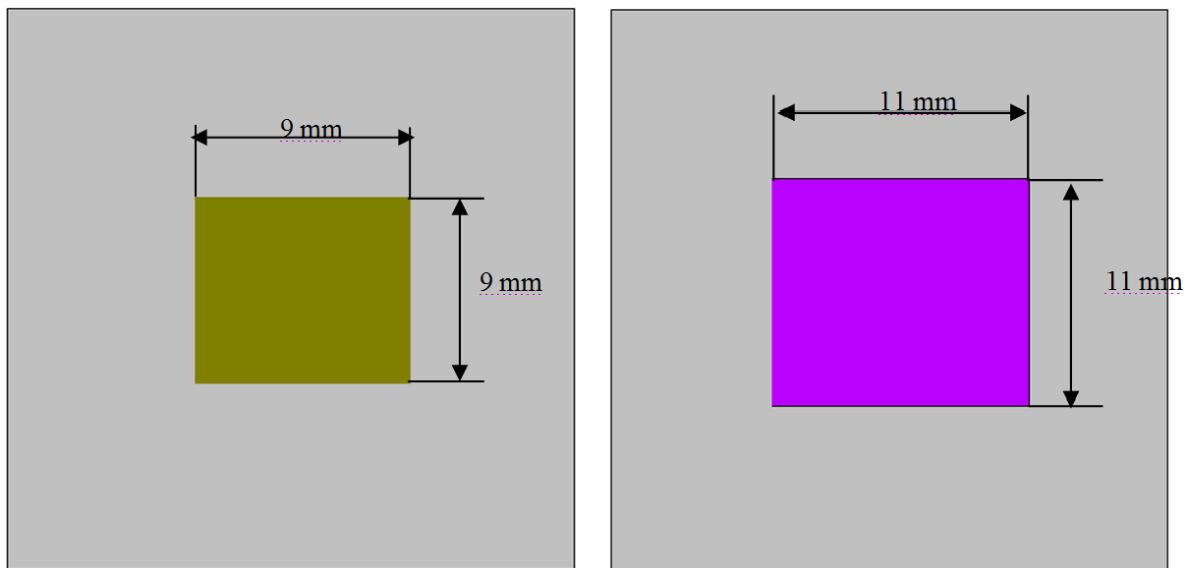
The result for the physical model confirms the correctness of the analysis and calculations obtained using the calculation method based on the method of moments. Three of the four laminates used in its construction include teflon, and one of the layers is made of polimethacrylamid foam. This caused some difficulties in the technological process of joining them together and generates small inaccuracies in the contact of subsequent layers. This gave slight differences between calculations and measurements.



**Figure 14.** Dimension of  $h_1$  layer

The resulting optimization model of the antenna is shown in Figures 9, 10 and 11. The antenna is a multi-layered structure having in its construction of two radiating elements in the form of "patches" located on successive layers of the dish. Patch located in the  $h_2$  layer is fed by a line through a gap made in the plane of the masses. Above it there is another patch that by using the resonance (of another already in the structure) greatly improves the bandwidth of operation. The power supply line located on the layer defined by the  $h_1$  and  $\epsilon_1$ .





**Figure 15.** Dimension of  $h_2$  and  $h_4$  layers

The  $h_2$  layer is made of foam, which cannot be applied metallization. Therefore, the patch was placed on the bottom layer of  $h_4$ . In result the radiating patch will be located between the layers  $h_3$  and  $h_4$ .

## 10. Result of measurements

Measurement of parameters and antenna characteristics were carried out at the Laboratory for Electromagnetic Compatibility of the Electronics Department of the Military Technical Academy equipped with an anechoic chamber. A prototype is made and the following measured results in the frequency range (5,5-11,5 GHz) for :

- Standing wave ratio VSWR
- Input impedance Z
- Resistance R
- Reactance X
- Radiation patterns

Figure 16 shows the model of antenna VSWR during measurements. In the next Figure 17 shows the results of measurements of VSWR, which reaches a value of less than 2 in frequency range from 5.8 GHz to 10.15 GHz. during the measurement parameters and antenna characteristics of dielectric parameters was also studied based on the methodology described in the articles[12,13,14].



Figure 16. Model of antenna during VSWR measurements.

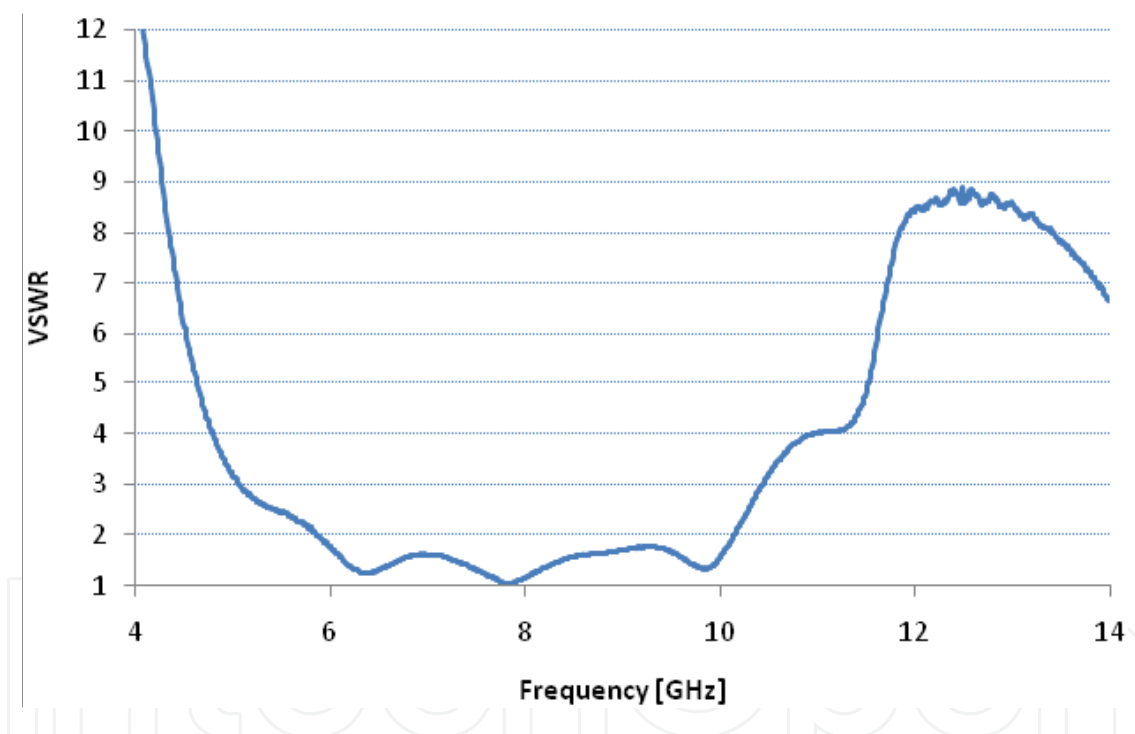
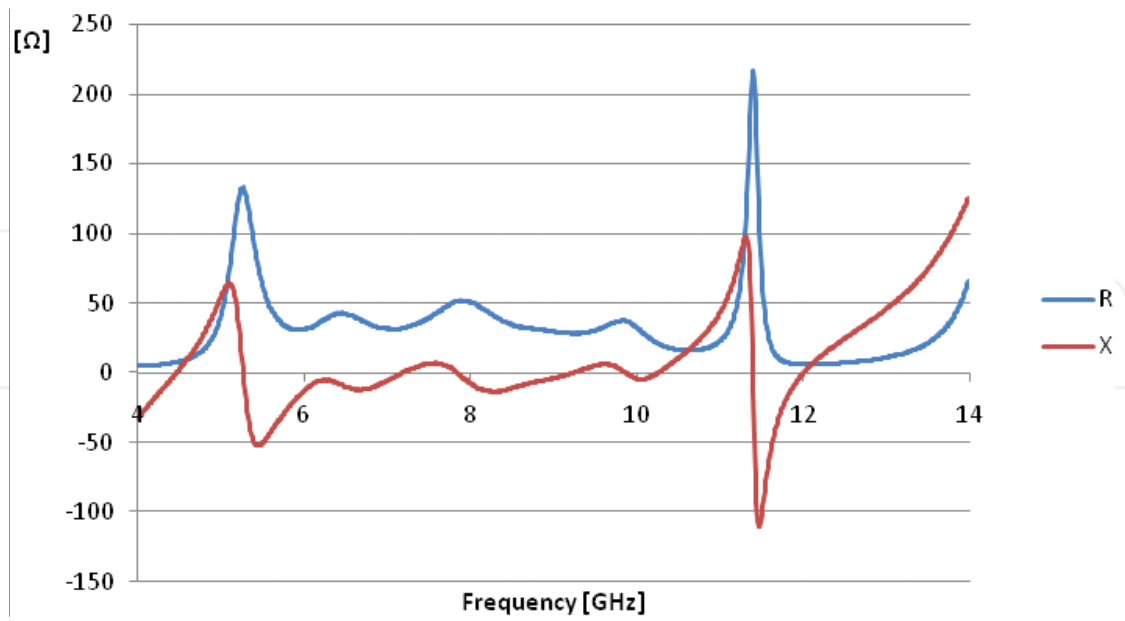


Figure 17. Measured VSWR of optimal single patch.

Obtained in the measurement bandwidth of the work is:

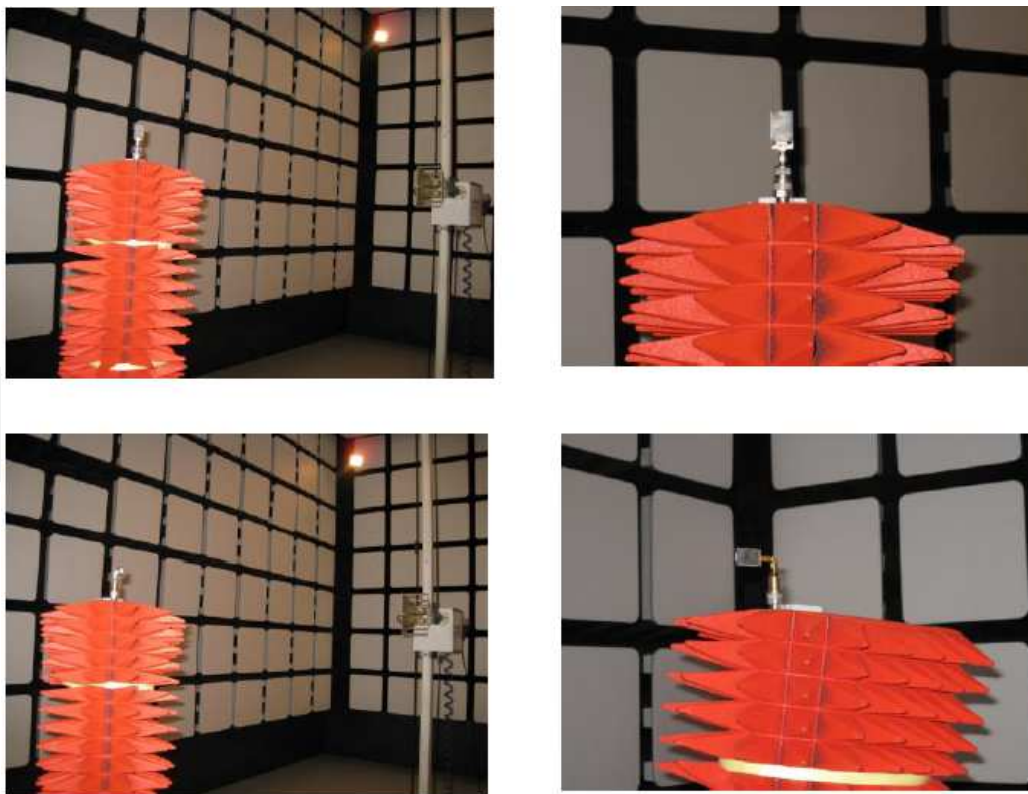
$$B = \frac{2(f_{\max} - f_{\min})}{f_{\max} + f_{\min}} \cdot 100\% = \frac{2(10150 - 5800)}{(10150 + 5800)} \cdot 100\% = \frac{2 \cdot 4350}{15950} \cdot 100\% \approx 55\% \tag{2}$$

Figure 18 shows the measured values of resistance and reactance of antenna model.



**Figure 18.** Measured input impedance of optimal single patch antenna.

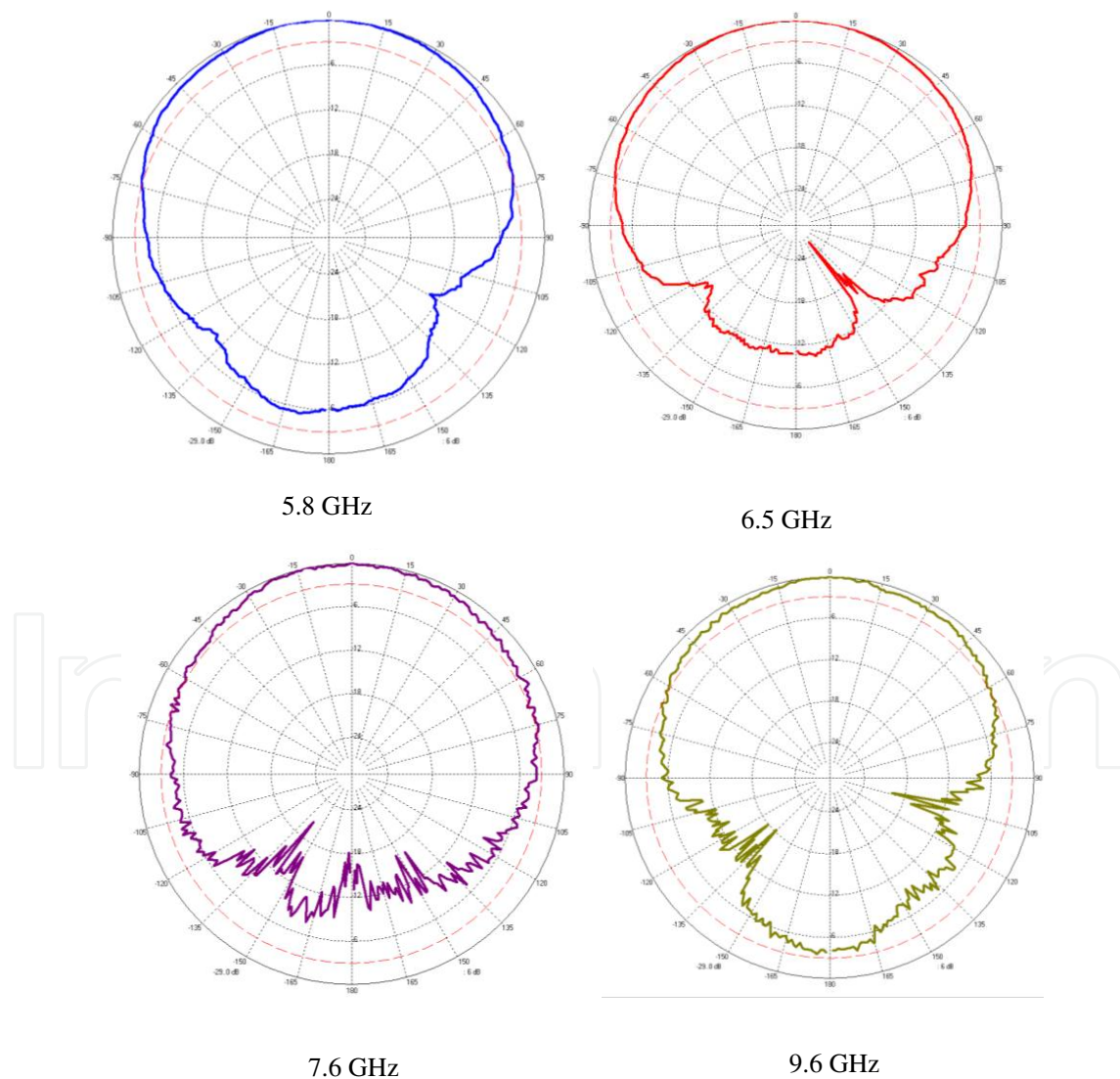
Figure 18 shows the measured values of resistance and reactance of antenna model. The measured resistance value ranges from 35 to 55 ohms. Reactance varies in the range from -10 to 5 ohms.



**Figure 19.** Photos of the antenna during measurements in the anechoic chamber.

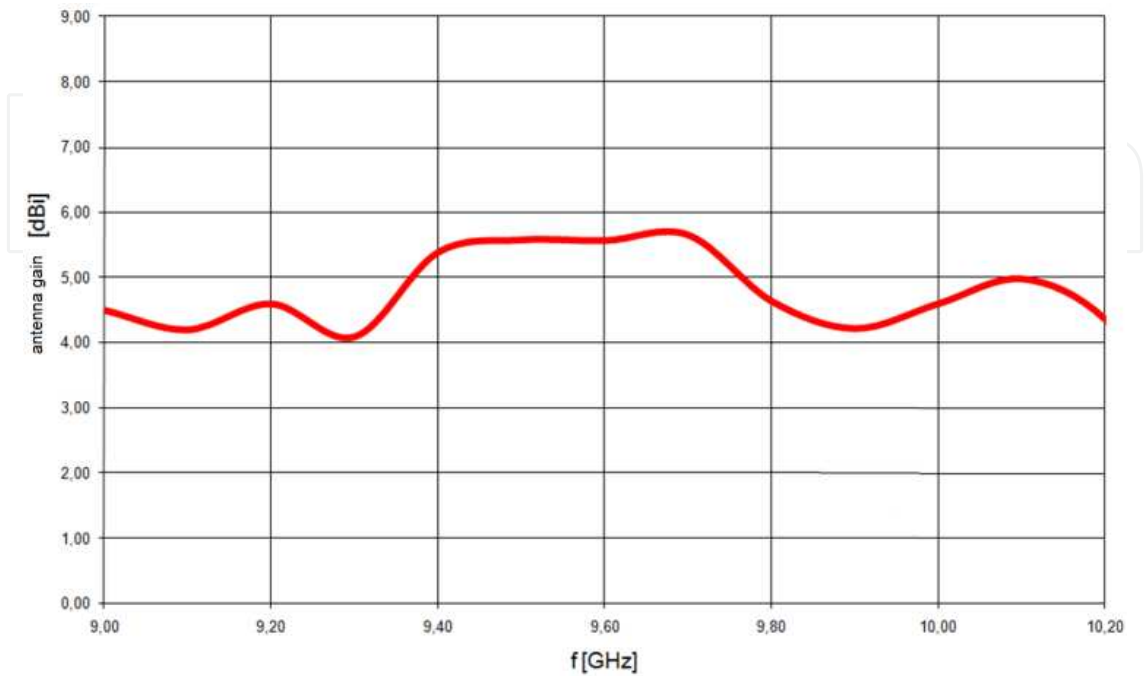
The subject carried out by the author to primarily study broadening the antenna bandwidth properties, which confirm the elimination of the problem of narrowband in the structures of planar antennas and directional properties. Particular attention is paid to the impedance properties defined by examining the standing wave ratio (VSWR) in the bandwidth of the antenna, the ratio was determined relative to a standard value of impedance  $50\Omega$ . Radiation characteristics were investigated for frequencies from 5.5 GHz to 11.5 GHz in steps of 1 GHz. The paper presents the characteristics for a center frequency band operation (7.6 GHz) and for two frequencies distant by about 1 GHz bandwidth from the ends of the work, the frequency of 6.5 GHz and 9.5 GHz. For the same frequency were also determined and presented in the work sheet in the computer simulations.

Figure 20 shows the far field radiation characteristics of the antenna at the center frequency (7.6 GHz) and at 6.5 and 9.5 GHz



**Figure 20.** Radiation patterns(H - plane).

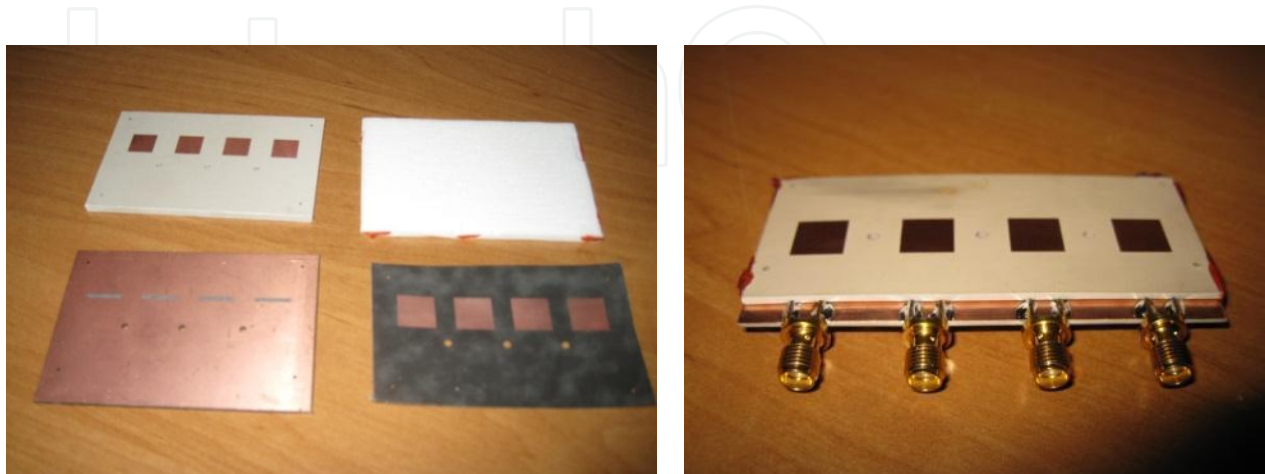
Width of the main lobe at the level of -3 [dB] in the whole operating band is approximately 140 °. Radiation pattern has a stable shape in the frequency domain.



**Figure 21.** Measured antenna gain versus frequency.

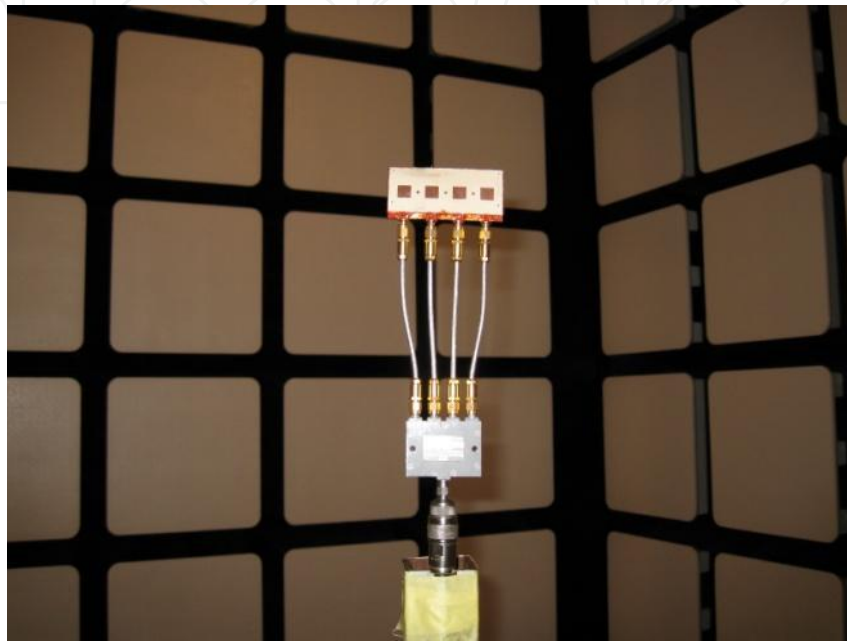
Antenna gain is in the range from 4 dBi to 5.7 dBi. For multilayer structure with a bandwidth greater than 50% this is considered to be very good gain values.

Presented in a multi-layer structure despite the complex structure can be used to construct the antenna array, thereby increasing antenna gain. For this purpose, designed four element array, whose design is shown in Figure 21.

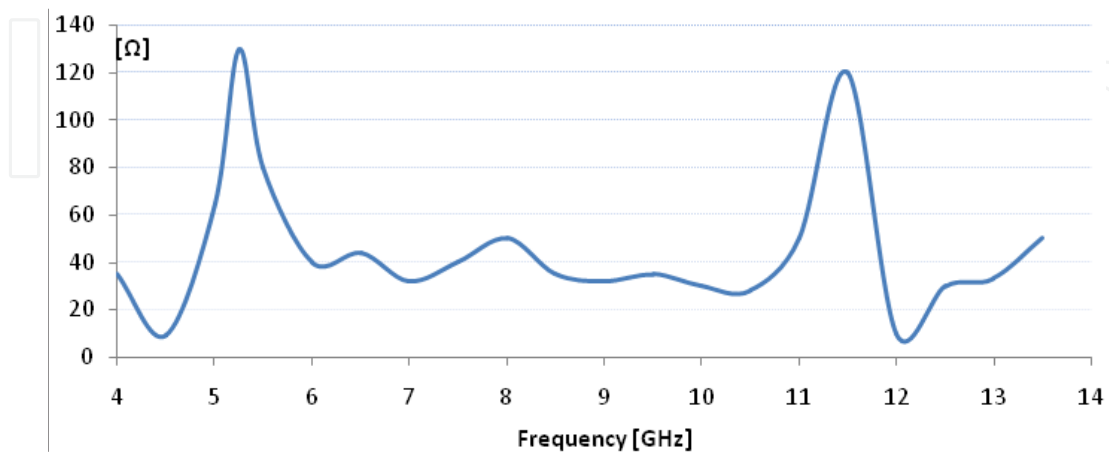


**Figure 22.** Antenna array.

Parameters and characteristics of the antenna array were also measured in the anechoic chamber (fig.21). For the model was made the following we measured in this same frequency range (5,5-11,5 GHz) following parameters: standing wave ratio VSWR, input impedance  $Z$ , resistance  $R$ , reactance  $X$ , radiation patterns. Measurement results are shown in Figures 23 and 24.



**Figure 23.** Antenna array during measurements in anechoic chamber.



**Figure 24.** Impedance of antenna array- measurements.



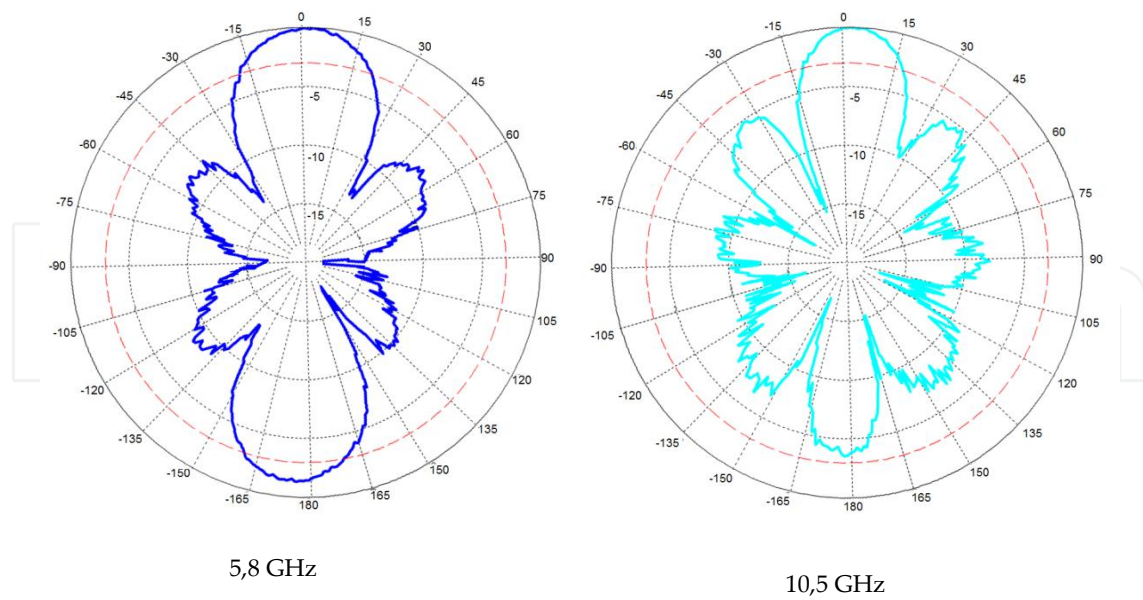


Figure 25. Radiation patterns of array.

## 11. Comparison of simulations and measurements

The most important parameter in view of the article is the course of VSWR as a function of frequency. The result obtained for the physical model confirms the correctness of the analysis and calculations obtained using the calculation method based on the method of moments, as well as the FDTD method.

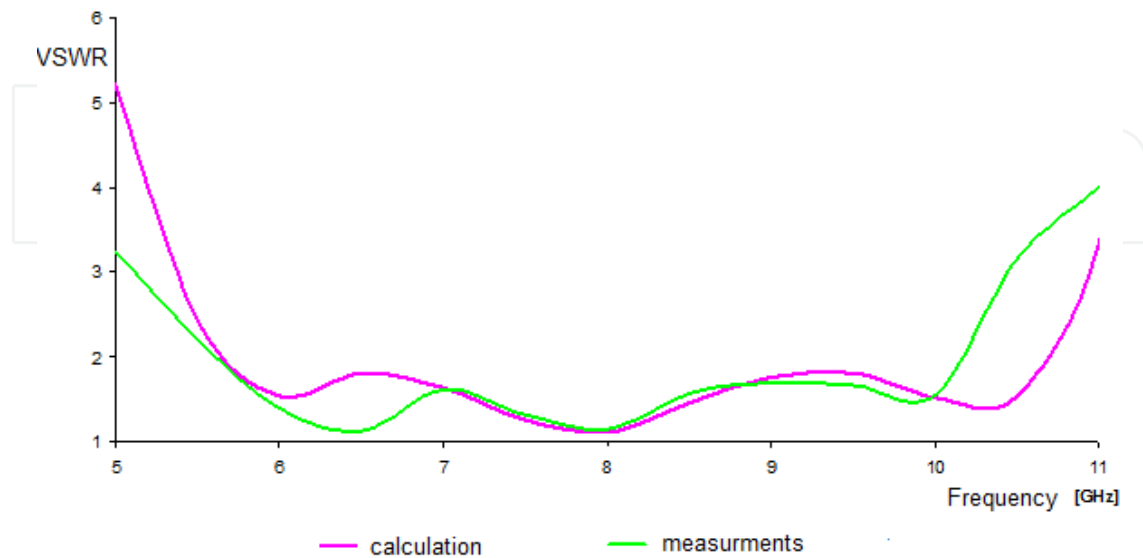
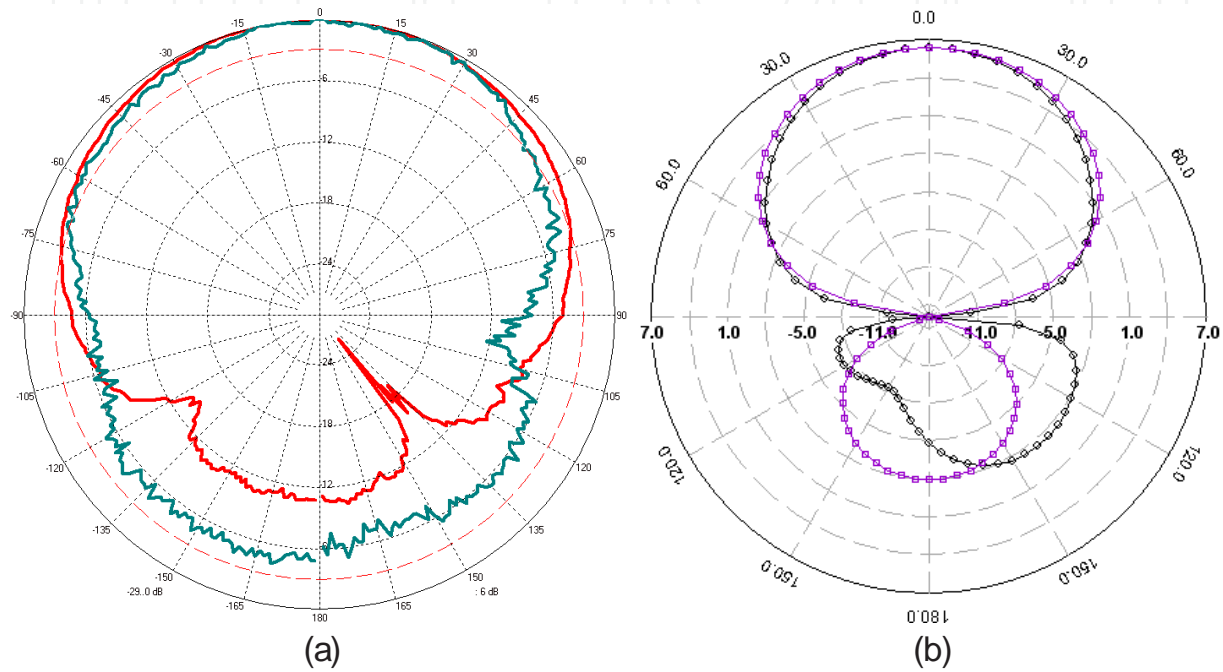


Figure 26. VSWR – simulations and measurements.



Reduction of bandwidth in the upper-frequency of band (as confirmed by further simulations and calculations exploring the effects of precision interfaces between layers of the antenna on its parameters), the inaccuracy of the interfaces between layers of the dish. Three of the four laminates used in its construction include Teflon, and one of the layers is made of foam polimethacrylamid. This causes some technological difficulties in the process of connecting them together and produce a minimum of contact inaccuracy of subsequent layers. The simulations confirm the situation.



**Figure 27.** Radiation patterns of antenna measurements (a) and simulations (b).

## 12. Conclusion

This article presents issues related to the theory and technique of multilayer planar antennas fed by the slot. This paper describes multilayer configuration to increase the BW of the antenna. This configuration has many advantages, including wide BW, reduction in spurious feed network radiation, and a symmetric radiation pattern with low cross-polarization. The antenna configuration with a resonant aperture yields wide BW by proper optimization of the coupling between the patch and the resonant slot. The basic characteristics and the effects of various parameters on the overall antenna performance are discussed.

The results of the study are satisfactory. The paper describes a clear advantage of multilayer antennas over monolayer ones, where the bandwidth is significantly narrower. The coupling aperture antenna after optimization can result in a considerable increase of bandwidth. The bandwidth of aerial is the outcome of the way feed as well as the utilization to build the multi-

layer substrates and their parameters. Calculations show how difficult it is to choose optimal values for laminates when we want to obtain wide band. Permittivity and thickness are equally important for bandwidth antenna. The analysis of the antenna was done by the usage of IE3D - Zeland Software (method of moments - MoM). The method has been applied to the microstrip-fed slot antenna and to the aperture coupled antenna with a good result when compared with measured data.

The model of antenna allows use of all the positive properties of planar antennas with simultaneous work in a wide frequency range, which so far has been the main element to eliminate this type of the antenna of use in many designs. Given the trend for miniaturization of antenna devices and the development of radio technology and integrated systems presented in the paper of construction seems to be very prospective. The design of this antenna is a modern solution to the antenna, which is especially important in the use of the moving objects. The results of experimental studies measuring fully confirm the possibility of constructing planar antenna with wide bandwidth operation. In addition, ease of implementation of antenna arrays using planar antennas opens up new possibilities in the use of this construction. Designed antenna operates in X-band and certainly could be an interesting alternative to the currently used antenna antennas operating in this band.

## Author details

Marek Bugaj\* and Marian Wnuk

\*Address all correspondence to: [marek.bugaj@wat.edu.pl](mailto:marek.bugaj@wat.edu.pl)

Faculty of Electronics, Military University of Technology, Warsaw, Poland

## References

- [1] Turker, N, Gunes, F, & Yildirim, T. "Artificial Neural Design of Microstrip Antennas", *Turk J Elec Engin*, (2006). , 14(3)
- [2] Kumar, G, & Ray, K. P. "Broadband Microstrip Antennas" Artech House, (2003). 1-58053-244-6
- [3] Garg, R. pp. Bhartia, I. Bahl "Microstrip antenna design handbook" Artec Hause, INC
- [4] Bi, Z, & Wu, K. Ch. Wu, J. Litva "And dispersive boundary condition handicap microstrip component analysis using the FDTD method", *IEEE Trans. Antennas and Propagation*, (1992). , 40, 774-777.

- [5] Kin-Lu Wong Compact and broadband microstrip antennas", (2002). by John Wiley & Sons, Inc., New York, 0-47122-111-2
- [6] Pozar, D. M. Microstrip Antenna Aperture-Coupled to a microstrip line", *Electron. Lett.*, (1985). , 21, 49-50.
- [7] Pozar, D. M. A Reciprocity Method of Analysis for Printed Slot and Slot-Coupled Antennas," *IEEE Trans. Antennas Propag.*, Dec. (1986). , AP-34(12)
- [8] Wood, C. Improved Bandwidth of Microstrip Antennas using Parasitic Elements", *IEE Proc., Pt.H*, 4/(1980). , 127
- [9] Pozar David MA Microstrip Antenna Aperture Coupled to a Microstrip line", *Electron. Lett.* Jan. 17 (1985). , 21, 49-50.
- [10] Borowiec, R, & Slobodzian, P. Multilayer microstrip structure" Phd. dissertation Institute, of Telecommunications and Acoustics, University of Wroclaw
- [11] Bugaj, M, & Wnuk, M. The analysis of microstrip antennas with the utilization the FDTD method" in XII Computational Methods Experimental Measurements, WIT Press 1746-4064 page 611-620
- [12] Kubacki, R, Nowosielski, L, & Przesmycki- Technique, R. for the electric and magnetic parameter measurement of powdered materials, Computational methods and experimental measurements XIV (2009). Wessex Institute of Technology, Anglia, str. 241÷250, 0174-3355X,., 48
- [13] Kubacki, R, Nowosielski, L, Przesmycki, R, & Frender- The, R. technique of electric and magnetic parameters measurements of powdered materials, *Przegląd Elektrotechniczny (Electrical Review)*, 0033-2097R. 85 NR 12/(2009).
- [14] Przesmycki, R, Nowosielski, L, & Kubacki-, R. The improved technique of electric and magnetic parameters measurements of powdered materials, *Advances in Engineering Software*, November (2011). 0965-9978, 42(11)
- [15] Gupta, K, & Benalla, A. Microstrip Antenna Design", Artech House, London (1980).