

We are IntechOpen, the world's leading publisher of Open Access books Built by scientists, for scientists

4,800

Open access books available

122,000

International authors and editors

135M

Downloads

Our authors are among the

154

Countries delivered to

TOP 1%

most cited scientists

12.2%

Contributors from top 500 universities



WEB OF SCIENCE™

Selection of our books indexed in the Book Citation Index
in Web of Science™ Core Collection (BKCI)

Interested in publishing with us?
Contact book.department@intechopen.com

Numbers displayed above are based on latest data collected.
For more information visit www.intechopen.com



Advanced Applications in the Field of Structural Control and Health Monitoring After the 2009 L'Aquila Earthquake

Vincenzo Gattulli

Additional information is available at the end of the chapter

<http://dx.doi.org/10.5772/55438>

1. Introduction

The earthquake, which has been occurred on 6 April 2009, has been a catastrophic event for both the city and the University of L'Aquila [1]. Nevertheless, the disaster have to be transformed in a tremendous opportunity to revitalize the area, with important benefit for the national and international scientific community to experience the effectiveness of new systems and technologies, and consequently to base, on these results, new developments in several different fields.

The present chapter aims to summarizes the observations made at L'Aquila regarding the dissemination of new technologies belonging to the structural control and health monitoring fields, immediately after the earthquake and in the reconstruction phase [2].

Two synthetic databases are presented and discussed regarding, respectively, the installed seismic protection systems and the structural monitoring experiences, available to the author personal knowledge, and probably mostly incomplete at this moment. Firstly, the large use of new seismic protection systems, using both base isolation and energy dissipation devices, in the new construction and in the retrofitting of existing structures, mainly made in reinforced concrete, is categorized and the main features of the installed systems are synthesized. Secondly, the efforts done in the area of structural monitoring, especially for strongly damaged monumental churches and building, are described and, based on the available information, the characteristics of the used instrumentation, either for permanent or not permanent installation, are classified.

Finally, the results acquired during the development of two different case studies, by a research group of the University of L'Aquila, are presented in detail.

In the first one, the use of energy dissipation devices, such as nonlinear fluid viscous dampers, in a peculiar configuration scheme that make use of the concept of dissipative interconnection in adjacent structures, is illustrated. Indeed during the seismic event of 6th April 2009, the edifices of the Engineering Faculty have suffered particularly for seismic induced large structural displacements and accelerations which have brought them out of order due, mainly, to the failure of non-structural elements [3,4], the breakage of wiring and piping systems and the destruction of furniture and machineries. In particular, among the three recently built buildings of the campus, erected in the early 90's, the so-called "Edifice A" presents the most critical damage scenario, which has been objective of a significant rehabilitating intervention. The critical choice during the design stage and testing are illustrated through several analysis conducted with the aim to construct reliable numerical models reproducing the experienced seismic behaviour and the expected enhancement due to the retrofitting. In particular, the main results of a dynamical testing campaign [5] used to calibrate a series of finite element models, able to reproduce the structural behaviour of the Edifice A, at low oscillation amplitude, are here discussed. Nonlinear static and dynamic structural analysis has been used in the evaluation of the structural performance [4] and of the proposed structural control effectiveness [6]. Device testing [7] and installation procedures have been considered in the overall process to reach high level of confidence in the matching of the rehabilitation goals with the realistically installed seismic protection system.

In the second one, the use of a wireless sensor network (WSN) for permanent structural health monitoring (SHM) of historic buildings in a seismic area is considered, evidencing the conducted specific activities to customize the system for the continuous assessment of the damaged conditions. On the basis of a defined design strategy [8-10], a permanent structural monitoring systems has been installed on the damaged *Basilica of S. Maria di Collemaggio*, at L'Aquila and it is currently working during the whole day. The main findings in the design, delivery, installation and management of the monitoring systems are presented. A series of tests has been conducted for the monitoring systems and the acquired data have been used for structural identification purpose on the basis of clearly stated procedure [11]. Several registrations acquired with the systems during local aftershock or more distant, relatively strong, shocks, as for example the recent Emilia earthquake (20-05-2012), are used to demonstrate the possibility given by the dynamic monitoring to produce valuable information for the structural assessment of historical monuments which can be in strongly damaged condition, such as the case of the Basilica.

2. The use of base-isolation and energy dissipation technologies at L'Aquila

The large number of losses in the property assets caused by the 2009 earthquake, particularly in the case of strategic structures (Hospital, Governance offices, School and University Buildings, infrastructures, Bank Buildings, etc) has demonstrate the large seismic vulnerability of the L'Aquila territory. Probably, the case of the University buildings it is emblematic because these structures were extremely "strategic" from the point of view of the caused disturbance

to the local equilibrium reached, before the earthquake, at any level (social, economical, etc). Indeed, the 27000 students attending the classes in the building of the several Faculties constitute a large revitalizing effect for the production realized in the territory of L'Aquila. In contrast the damage suffered by this extremely strategic institution for its territory through the scarce seismic performance of the entire property asset [1] has had consequence in the reconstruction phase. Notwithstanding the large losses, many projects have been started, immediately after the earthquake, to react immediately to the catastrophic event. Due to a long period of aftershock swarm, still continuing in the area, the main idea, which it was followed, is the realization of safer structures with affordable costs. Therefore, several projects have been realized exploiting the use of passive control for seismic protection, either through the concept of base isolation or by enhancing the dissipation capacity of the structural system. These interventions have been conducted both for buildings devoted to public services and to residential buildings. The realizations using a base isolation system as main seismic protection strategy, available to the author knowledge, are summarized in Table 1 while the structural systems enhanced through dissipative devices are described in Table 2.

Immediately after the earthquake one of the main problems, is to find the right compromise between temporary or definitive construction of houses, which can be used to maintain the population at the site. In the case of L'Aquila a peculiar solution to the problem has been provided directly by the National Government, the Project CASE, consisting in 185 buildings constructed in record time to provide a right accommodation to a large amount of the population through the realization of 4.500 apartments in 185 buildings [12]. Every building has the same structure at the ground floor (columns with seismic isolators and a rigid slab), while the superstructures have been made with different construction solutions and materials.

Among public buildings, the new venue of ANAS, the Italian Infrastructure Public Authority for the management of the road network, has been built in a very short time. It has a circular plant and a base isolation system. Furthermore, it was carried out the demolition and reconstruction of a portion of the Court Law Building, the construction of the new venue of the Faculty of Letters (with the process started in 2006) and the retrofitting of the Faculty of Engineering, project extensively discussed in the following section 4. As important as the public buildings, there were several retrofitting interventions in residential damaged buildings. Among these, quite interesting it is the case of the condominium in via Rauco, being one of the first examples of a peculiar technology application for the uplift of the buildings. During the realization thanks to hydraulic jacks, it was possible to uplift the building of 60 cm and insert seismic isolators at ground floor level. Another example is the case of condominium Habitat, consisting in 10 buildings of different heights connected to one another by 9 bodies scale, arranged to make a semicircular plant all together. The intervention has been characterized by the realization of a single rigid slab to the level of the first deck and the cutting of the columns on the ground floor level, to allow insertion of the devices. In this way it was possible to realize a unique isolation system for all the bodies of the condominium.

The data collected regarding structural control systems, recently, realized in L'Aquila are summarized in Tables 1 and 2, in which is specified, for each construction, the type of intervention, the type and quantity of the devices used and, for some of them, the available specific design characteristics.

Table 1. Examples of interventions using a base isolation system in the city of L'Aquila.

Building	Design and Construction Period	Type of Intervention	Construction Material		Superstructure Number Floors	Seismic Protection Device	Number of Bearings	Base Isolation Vibration Period (sec)	First Mode Vibration Period (sec)	Bearing δ max (mm)	Bearing Max Vertical Load (kN)	
			Substructure	Superstructure								
C. A. S. E. Project	2009-2010	Buildings for Homeless (185 buildings)	Steel and reinforced concrete columns, reinforced concrete rigid slab.	Wood, steel, or concrete.	3	Friction Pendulum Bearings	40x28 buildings=1120 Type I (r. c. columns)	4	0.5	260	3000	
							40x91 buildings=3640 Type I (steel columns)				3000	
							32x3 buildings=96 Type I (steel columns)				3000	
							40x61 buildings=2440 Type II (steel columns)					
							32x1 buildings=32 Type II (steel columns)				3000	
ANAS	2009 - 2010	New construction	Reinforced concrete	Reinforced concrete	3	Elastomeric Bearings - HDRB	60					
Auditorium	2010 - 2012	New construction	Reinforced concrete	Laminated wood	Single building	Elastomeric Bearings	14					
Car Dealership Ford	2011	New construction	Reinforced concrete	Reinforced concrete		Elastomeric Bearings	18					
Residential Building	2012	New construction	Reinforced concrete	Reinforced concrete		Elastomeric Bearings	17					
Condominium Habitat	2011	Retrofitting (19 bodies connected)	Reinforced concrete	Reinforced concrete	3 (edges) and 5 (center)	Friction Pendulum Bearings	277 (4 different sizes)	2.75		300		
Residential Building via Rauco	2011	Retrofitting	Reinforced concrete	Reinforced concrete	6	Friction Pendulum Bearings	32					
Condominium Domus Prima	2011	Retrofitting	Reinforced concrete	Reinforced concrete		Friction Pendulum Bearings	47 (3 different sizes)			390		
Condominium Fortuna 2	2012	Retrofitting	Reinforced concrete	Reinforced concrete		Elastomeric Bearings - HDRB	21					
Condominium Borgo dei Tigli	2012	Retrofitting	Reinforced concrete	Reinforced concrete		Elastomeric Bearings - HDRB	42 (2 different sizes)					
Condominium Aguglia	2012	Retrofitting	Reinforced concrete	Reinforced concrete		Friction Pendulum Bearings	30			350		
Condominium Amiterno	2012	Retrofitting	Reinforced concrete	Reinforced concrete	Single building	Friction Pendulum Bearings	26			300		
Condominium Barattelli	2012	Retrofitting	Reinforced concrete	Reinforced concrete		Friction Pendulum Bearings	66 (3 different sizes)			355		
Condominium Leonardo	2012	Retrofitting	Reinforced concrete	Reinforced concrete		Friction Pendulum Bearings	44			350		
Condominium Acrie - Building C2	2012	Retrofitting	Reinforced concrete	Reinforced concrete		Elastomeric Bearings - HDRB	26					
Condominium Andromeda	2012	Retrofitting	Reinforced concrete	Reinforced concrete		Elastomeric Bearings - HDRB	19 (2 different sizes)					
Faculty of Letter	2006 - 2012	Demolition and reconstruction	Reinforced concrete	Reinforced concrete	6 (build. A,B)-7 (build. D)-1 (build. C)	Elastomeric Bearings (HDRB) and sliders	77 + 34		2.6	1	492	14000
Court Law Building - Building B	2011	Demolition and reconstruction	Reinforced concrete	3 Buildings: 1 in steel, 2 in reinforced buildings.	3	Friction Pendulum Bearings	-					
3 Buildings via Francia	2011	Demolition and reconstruction	Reinforced concrete	Reinforced concrete	3	Elastomeric Bearings	72 (2 different sizes)					
Building via Cadorna	2012	Demolition and reconstruction	Reinforced concrete	Reinforced concrete	3	Elastomeric Bearings	17					
Condominium S. Antonio - Building A	2012	Demolition and reconstruction	Reinforced concrete	Reinforced concrete		Elastomeric Bearings	52 (4 different sizes)					

Building	Design and Construction Period	Type of Intervention	Construction Material	Number Floors of Superstructure	Seismic Protection System	Number of Devices	Device δ max (mm)	Device Max Horizontal Load (kN)
Edifice A Engineering Faculty	2011	Retrofitting	Reinforced concrete	4	Viscous Dampers	18 (Type I)	90	200
						17 (Type II)	60	100
						8 (Type III)	130	400
Condominium Avenia	2012	Retrofitting	Reinforced concrete	4	Elasto Plastic Devices	2 (Type I)	15	130
						12 (Type II)		170
						18 (Type III)		370
Building corso Federico II	2012	Retrofitting	Reinforced concrete	3	Elasto Plastic Devices	14 (Type I)	15	270
						18 (Type II)		340
						20 (Type III)		480
						10 (Type IV)		560
						22 (Type V)		720
						24 (Type VI)		820
						18 (Type VII)		940
						18 (Type VIII)		1170
Condominium via Milonia, 4	2012	Retrofitting	Reinforced concrete	4	Elasto Plastic Devices	4 (Type I)	20	460
						8 (Type II)	20	130
						10 (Type III)	25	130
						2 (Type IV)	25	460
Condominium via Milonia, 2	2012	Retrofitting	Reinforced concrete	4	Elasto Plastic Devices	4 (Type I)	20	460
						8 (Type II)	20	130
						12 (Type III)	25	130
Condominio La Casetta	2012	Retrofitting	Reinforced concrete	5	Elasto Plastic Devices	24	20	150
Building via Rosana - Gioia dei Marsi (AQ)	2012	Retrofitting	Reinforced concrete	4	Elasto Plastic Devices	9	15	560

Table 2. Examples of interventions using passive energy dissipation systems

The data are evidencing the impact of the structural control technology either in the immediate intervention after the earthquake and in the longer reconstruction phase. To the author knowledge, at the city of L'Aquila during the earthquake, base isolation systems or passive energy dissipation devices were not protecting any in-service structure. Only the building of the Faculty of Letter of the University of L'Aquila was under construction, with the isolators on-site but with the superstructure incomplete and the edifice not finished [13]. To have a complete picture, it can be cited that two hysteretic metallic force limiters were installed in the year 2000 at the end of a light truss structure connecting transversally the slender walls of the nave of S. Maria di Collemaggio [14]. The performance of these devices under the earthquake is still under investigation by different research groups, due to the partial collapse occurred in the area of the transept of the Basilica.

Therefore, immediately after the earthquake the base isolated system at L'Aquila, excluding the peculiar project CASE, reaches the number of 20 interventions with a total number of one thousand (1000) installed devices (as reported in Table 1). The data permits to notice that two main classes of seismic bearing insulator have been installed based on viscoelastic behavior (rubber bearing - RB) or friction (sliding pendulum bearing - SPB). The installed devices are almost the same number in each of the two classes (45% RB – 55% SPB). Several data are missed, because are currently not available, as for instance, the average design period of the base isolation systems. Table 2 shows a synthesis of the realized interventions using passive energy dissipation devices. To the author knowledge, three hundred (300) passive devices have been already installed after the earthquake, mostly based on reaching dissipation through the

exploitation of confined material in the elasto-plastic regime during the earthquake. Only in the case of the Edifice A of the Engineering Faculty Building forty-three (43) nonlinear viscous fluid dampers of three different types have been installed looking for the increase of dissipation through the relative velocity of adjacent sub-structures.

3. Structural monitoring systems installed at L'Aquila

Before the 2009 L'Aquila earthquake a strong network of seismic accelerometers were functioning close to the epicenter, mostly managed by the Italian Institute of Geophysics and Volcanology (INGV) [15], while very few structure were equipped by a permanent structural monitoring managed by Department of Civil Protection (DPC) [16] (see, also, Table 3). In particular, the response of the Pizzoli Town Hall during the main shock has been recorded and analyzed by DPC, giving special insights on the potentiality of these systems for immediate evaluation of the damaged occurred during an earthquake. The large amount of installed, temporally or permanently, devices of different type (accelerometers, smart wireless devices, displacement and velocity transducers, inclinometers, etc) reach a number of around three hundred (300) evidencing a large impact of this technology in the post-earthquake emergency phase, especially during the earthquake swarms. In particular several monitoring systems have been installed in the emergency phase, during the construction of temporary scaffolding, in order to verify the efficacy of the added structural system especially in the case of monumental building (see for example [17]). Because of this scope, in many cases, the permanent monitoring has worked only for a limited number of months (in the Table 3, the period is not always precisely known to the author and sometimes it should be considered indicative). In other cases, the monitoring system is permanently installed on the structure and it can be used also to determine the change that will occur in the structural behavior during the reconstruction phase [8,9].

In several cases, the structural monitoring system uses only accelerometers, starting from very few measures (three channels in the minor case) to larger number of devices with different characteristics and sensitivity. Instead more complex monitoring systems are used in complex monumental churches and buildings where accelerometers are joined with crackmeters, inclinometers, and temperature measurement devices, etc.

4. Energy dissipation devices installed at university of L'Aquila buildings

Among several interventions, designed with the intent of increasing the dissipative capacity of the structure through seismic protection elements, the case of the Edifice A of the Engineering Campus has been here selected as case study. The peculiarity of this intervention should be searched on the idea of enhancing the control performance through the dissipative connection of adjacent structures. Indeed, the last two decades increasing attention on the mitigation of seismic or wind induced vibrations in adjacent structures through their "smart"

MONITORED STRUCTURE	Building type	Developer/Owner	Prevalent structural material	Monitoring time interval	Overall number of measurement devices	Number of Accelerometers	Number of wireless devices
Pizzoli Town Hall	Building	DPC/Town Council	Masonry	Currently working	17	17 monoaxial	0
Navelli Town Hall	Building	DPC/Town Council	Reinforced concrete	2 months	4	4 triaxial	4
Pianola	Sports Ground Building	DPC/Town Council	Reinforced concrete	2 months	1	1 triaxial	1
Coppito (AQ)	Finance Police School: Sport Palace	DPC/Town Council	Reinforced concrete	2 months	1	1 triaxial	1
Coppito (AQ)	Finance Police School: Auditorium	DPC/Town Council	Reinforced concrete	2 months	1	1 triaxial	1
Reiss-Romoli (AQ)	Building	DPC/Private	Reinforced concrete	2 months	1	1 triaxial	1
School San Demetrio ne Vestini (AQ)	Building	DPC/Town Council	Reinforced concrete	2 months	3	1 triaxial + 2 biaxial	3
Anime Sante	Monumental church	IUAV/Town Council	Masonry	24 months	20+8	16 monoaxial + 4 triaxial	8
Duomo	Monumental church	Private/Town Council	Masonry	daily	4+8	8 monoaxial	4
S. Biagio D'Amiterno Church	Monumental church	UNIPAD/Town Council	Masonry	2 months	6+10	6 monoaxial	0
S. Marco Church	Monumental church	UNIPAD/Town Council	Masonry	2 months	6+10	6 monoaxial	0
S. Agostino Church	Monumental church	UNIPAD/Town Council	Masonry	2 months	16+10	16 monoaxial	0
S. Silvestro Church	Monumental church	UNIPAD/Town Council	Masonry	24 months	11+8	8 monoaxial	0
Palazzo Margherita	Monumental building	UNIVAQ/Town Council	Masonry	daily	8	8 monoaxial	0
Palazzo Camponeschi	Monumental building	UNIVAQ/UNIVAQ	Masonry	12 months	2+2	2 triaxial	2
Scuola De Amicis	Monumental building	UNIVAQ/Town Council	Masonry	Currently working	12+22	12 monoaxial	0
S. Maria di Collemaggio	Monumental church	UNIVAQ/Town Council	Masonry	Currently working	16+11	16 triaxial	27
Forte Spagnolo	Monumental building	UNIPAD/Town Council	Masonry	5 months	8+6	8 monoaxial	0
New Building ANAS	Public building	ANAS	Reinforced concrete	Currently working	12	6 biaxial + 6 triaxial	0

Table 3. Examples of structural monitoring systems installed at L'Aquila

coupling has been examined. Several studies have been devoted to optimize the dynamic performance of slender structures, such as skyscrapers or tall buildings, introducing dissipation systems acting on the relative motion and aiming to reduce the maximum displacements at the higher floors. Different applications of similar concepts have been applied in the retrofitting of existing adjacent structures. The placements of viscous-type coupling devices into seismic joints have been proposed to dissipate energy and to avoid hammering phenomena [18-21]. In all cases "smart" coupling between adjacent structures has been exploited using passive, semi-active, and active control systems with different features and performances.

Focusing the attention on the passive coupling of adjacent structures, different modelling approaches have been used. The synthetic description of the main problem features through a pair of simple oscillators interconnected by means of a springs and dashpot in series or parallel fashion has been proposed by many authors [22-25]. The use of a simple oscillator pair has been pursued by the research group of L'Aquila both for the proposal of a new design method [26-28] and the use of it at the preliminary stage of the design of the more complex

system installed at the Edifice A of the Engineering Faculty [6]. In the following the entire process has been summarized.

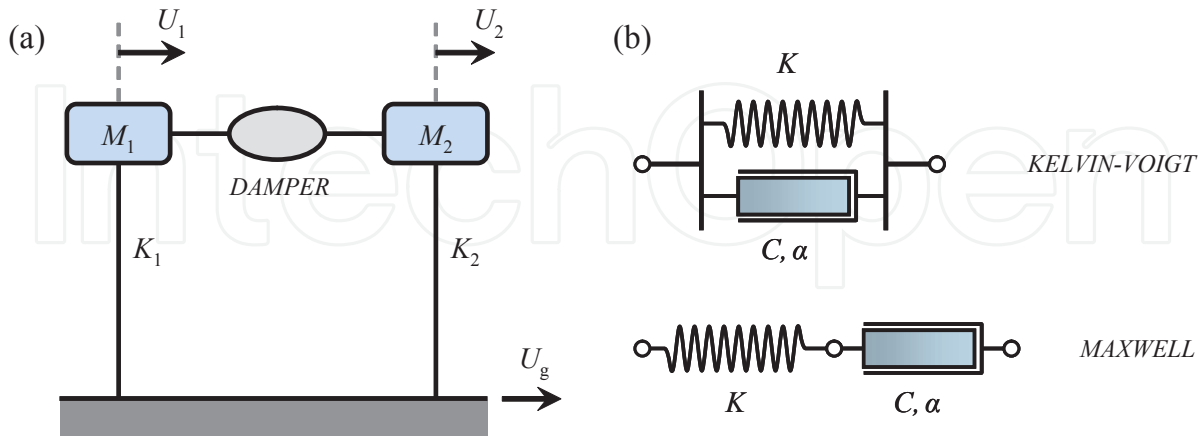

Figure 1. Passive control of adjacent structures: (a) two-dofs model, (b) damper models.

4.1. Simple model of two coupled oscillators for preliminary design

Consider two simple linear oscillators with mass M_j and stiffness K_j ($j=1,2$), coupled by a passive damper (Figure 1a). Denoting U_1 and U_2 the relative horizontal displacements and F the mutual force applied by the coupling damper, the dynamic response of the two-degrees-of-freedom (*dofs*) system to a synchronous horizontal ground displacement U_g is governed by the equations

$$\begin{aligned} M_1 \ddot{U}_1 + K_1 U_1 - F &= -M_1 \ddot{U}_g \\ M_2 \ddot{U}_2 + K_2 U_2 + F &= -M_2 \ddot{U}_g \end{aligned} \quad (1)$$

where dot indicates derivative with respect to time t . Denoting L a convenient reference length, and the following dimensionless variables and parameters can be introduced

$$u_j = \frac{U_j}{L}, \quad u_g = \frac{U_g}{L}, \quad \omega_j^2 = \frac{K_j}{M_j}, \quad \beta = \frac{\omega_2}{\omega_1}, \quad \rho = \frac{M_2}{M_1}, \quad u = \frac{F}{\omega_1^2 M_1 L}, \quad \tau = \omega_1 t \quad (2)$$

where the dimensionless force u is understood as the control variable, and the relevant parameters ρ and β stand for the mass and frequency ratio between the two uncoupled oscillators, respectively. The equations of motion can be rewritten in the synthetic form

$$\mathbf{M}\ddot{\mathbf{u}} + \mathbf{K}\mathbf{u} + s\mathbf{u}(\mathbf{u}, \dot{\mathbf{u}}) = -\mathbf{M}\mathbf{r}\ddot{u}_g \quad (3)$$

where \mathbf{u} is the displacement vector, \mathbf{M} and \mathbf{K} are the mass and stiffness matrices, \mathbf{s} and \mathbf{r} are the position vectors of the control and external forces

$$\mathbf{M} = \begin{bmatrix} 1 & 0 \\ 0 & \rho \end{bmatrix}, \quad \mathbf{K} = \begin{bmatrix} 1 & 0 \\ 0 & \rho\beta^2 \end{bmatrix}, \quad \mathbf{u} = \begin{Bmatrix} u_1 \\ u_2 \end{Bmatrix}, \quad \mathbf{r} = \begin{Bmatrix} 1 \\ 1 \end{Bmatrix}, \quad \mathbf{s} = \begin{Bmatrix} -1 \\ 1 \end{Bmatrix} \quad (4)$$

Different rheological models of the coupling damper are introduced to define the constitutive law $u(\mathbf{u}, \dot{\mathbf{u}})$, relating the control force to the displacement/velocity vector. Adopting a state-space representation, with the use of the state vector $\mathbf{x} = \{\mathbf{u}^T, \dot{\mathbf{u}}^T\}^T$ the equation (3) can be rewritten as

$$\dot{\mathbf{x}} = \mathbf{A}\mathbf{x} + \mathbf{b}u + \mathbf{h}\ddot{u}_g \quad (5)$$

where the state matrix \mathbf{A} , the allocation control vector \mathbf{b} the external input vector \mathbf{h} are, respectively

$$\mathbf{A} = \begin{bmatrix} \mathbf{0} & \mathbf{I} \\ -\mathbf{M}^{-1}\mathbf{K} & \mathbf{0} \end{bmatrix}, \quad \mathbf{b} = \begin{Bmatrix} \mathbf{0} \\ -\mathbf{M}^{-1}\mathbf{s} \end{Bmatrix}, \quad \mathbf{h} = \begin{Bmatrix} \mathbf{0} \\ -\mathbf{r} \end{Bmatrix} \quad (6)$$

Constitutive models describing with increasing complexity the damper behaviour can be formulated joining, in different combination schemes, simple elements: a linear spring with elastic constant K , and a linear dashpot with viscous constant C . Introducing the dimensionless parameters

$$\eta = \frac{K}{\omega_1^2 M_1}, \quad \gamma = \frac{C}{2\omega_1 M_1} \quad (7)$$

the KV and the Ma model correspond to the alternative parallel or series combination of the spring and the dashpot, respectively. Consequently, the constitutive law reads

- KV model $u = \eta(u_2 - u_1) + 2\gamma(\dot{u}_2 - \dot{u}_1)$
- Ma model $u = 2\gamma\left(\dot{u}_2 - \dot{u}_1 - \frac{\dot{u}}{\eta}\right)$

It is worth noting that the Ma model entails an increment of the model dimension due to the damper internal dynamics, described by a supplementary half degree-of-freedom. It can be demonstrated that in the KV case, the design coupling parameters can be chosen according to the following equations

$$\eta_c = \frac{\rho(1-\beta^2)(1-\rho^2\beta^2)}{(1+\rho)(1+\rho\beta^2)}; \quad \gamma_c = \frac{\rho}{1+\rho} \left(1 + \eta_c + \beta^2 + \frac{\eta_c}{\rho} - 2 \left(\beta^2(1+\eta_c) + \frac{\eta_c}{\rho} \right)^{1/2} \right)^{1/2} \quad (8)$$

in order to assure for the coupled system specific features with respect to the base excitation [28].

Similar characteristics have been found in the *Ma* case for which only numerical analysis have been performed to determine the design coupling parameters η_c or γ_c .

4.2. Seismic protection of Edifice A through nonlinear viscous dampers

During the seismic event of 6th April 2009, the edifices of the Engineering faculty have suffered particularly for seismic induced large structural displacements and accelerations which have brought them out of order due to the failure of non-structural elements [4], the breakage of wiring and piping systems and the destruction of furniture and machineries. In particular, among the three recently-built buildings of the campus, erected in the early 90's, the so-called "Edifice A" presents the most critical damage scenario, which needs a significant rehabilitating intervention.

Edifice A is a four-story building with the resistant structure made of reinforced concrete frames, sitting on a sloping site. Several seismic joints divide the structure into seven independent substructures (Figure 2); some of them are structurally featured by a frame-shear-wall interactive system. In the substructures, the walls are widely used to reinforce and to stiffen the acute corners, the rounded staircases close to the elevator cores and the lower floors. The plan is characterized by asymmetry, with uneven distribution of stiffness and vertical irregularities, and double- or triple-height rooms. The amphitheater facing the main entrance, on the north-west side, is sustained by an independent structure. Concrete slabs are used to realize all the horizontal planes including the roof.

The most evident damages in the Edifice A of Engineering Faculty were found to be localized in the main facade, which has lost large portions of the veneer masonry, made of heavy split-face bricks (Figure 3), laying bare the underlying reinforced concrete structure, remained practically undamaged. All the results collected during the early inspections confirmed that the structure underwent an excessive displacement and acceleration level, surely incompatible with the resistance of many non-structural elements. The massive inward cascade of heavy bricks and sharp glass, fallen down from the facade and the wall of the internal stairs, has realized an unpleasant dangerous scenario [1,4].

Aiming to understand the structural reasons for this inadequate behavior, it should be considered that the design concept follows the idea to have the planar structure sustaining the principal facade rigidly coupled with the three-dimensional frame of the building behind.

Horizontal steel tubes, functioning as interconnecting rods at different floor levels, ensured the coupling between the two substructures (Figure 3c). The bolted anchorages at the rod ends were probably under-dimensioned for the exceptional seismic action, since many of them

failed under the combined effects of the unexpected cyclic axial loads and the repeated impacts of the bricks falling down from above. In the progression of the damage the failure of the connection played a great role facilitating the augment of both relative displacements between the two structures (facade and three-dimensional frame) and absolute displacements and acceleration on the facade.

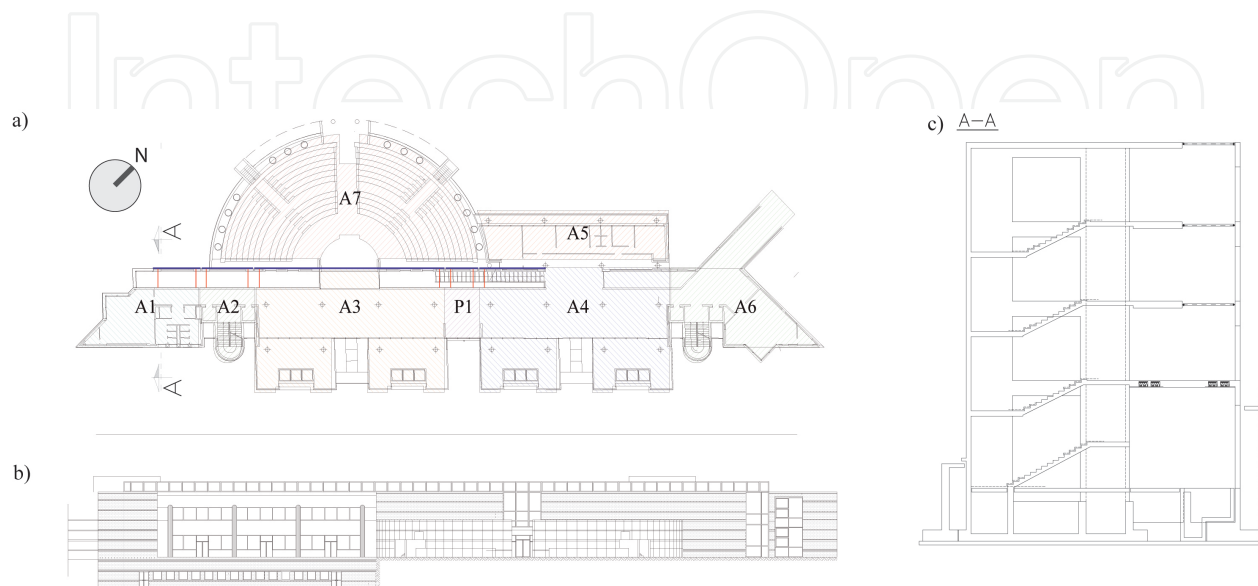

Figure 2. Edifice A: a) plan view at the main entrance level 0, b) facade view c) section A-A



Figure 3. Damages caused by 2009 earthquake to the Edifice A: a) internal view of the main facade, b) internal partitioning walls c) heavy bricks fallen down inside the building from the facade.

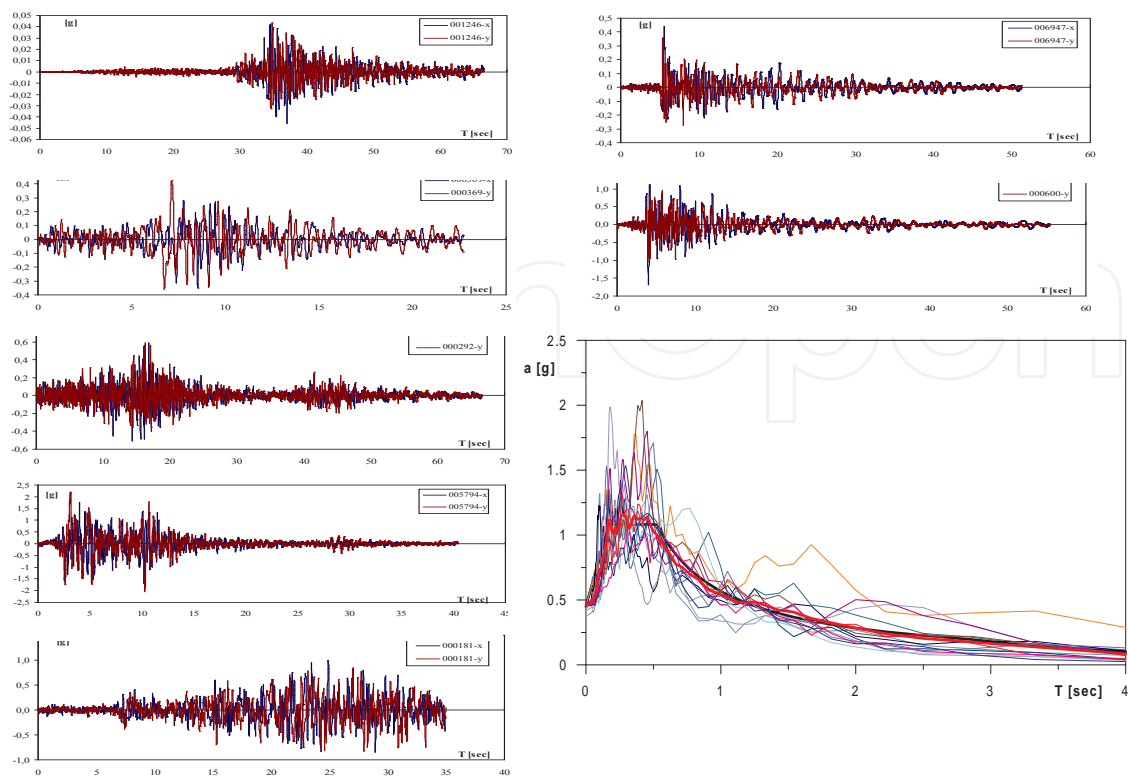

Figure 4. Seven natural earthquake realizations with an average spectrum compatible with the design one used for the evaluation of the seismic protection performances.

Moreover, the overall dynamical phenomenon was probably emphasized by the different mechanical properties of the coupled substructures.

A deep knowledge of the structures has permitted to design an optimized retrofitting intervention, able to satisfy high performance criteria defined in the current Italian National Code [29]. Before the retrofitting interventions, the most vulnerable aspects of the original design have been detected through the comparison with the limitations imposed by the newest national design code. Finite element models for each independent substructure were used, based on the previously obtained information, to verify both the operational limit state and ultimate limit state requests in terms of inter-storey drifts and ultimate strength of each element, respectively. These analyses put into evidence excessive deformation levels of the higher floors, while the other substructures have resulted lower flexible, due to the stiffening presence of fully-height shear walls. The other substructures satisfy the maximum inter-story drift requirements at operational limit state [4]. The effectiveness of the connection between the principal three-dimensional structure and the planar frame sustaining the facade has been recognized as the critical issue to be addressed for the enhancement of the seismic performance.

The limited efficacy of the original metallic tubes, which rigidly couple the facade with the main structure, evidences, also through the occurred damage, large absolute facade displacements and accelerations with high frequency content. This occurrence has suggested considering and comparing different alternatives in reconstructing the damaged coupling elements,

exploring new geometric arrangements and technical solutions. After several discussions taking into account comparative criteria (including structural performance, aesthetic outcome and economic aspects), dissipative steel bars, embedding viscous dampers and arranged in a stiff K-shaped configuration, reproducing a planar truss structure, have been selected to restore the facade-structure connection. The leading idea is to realize a dissipative coupling between two adjacent structures with different stiffness, that is the stiff principal three-dimensional structure and the flexible planar frame sustaining the facade. Here, a complete analysis on the benefits reached by the K-shaped dissipative configuration is performed by means of direct time-integration of the nonlinear motion equation numerically obtained through a classical finite element approach in both the case of rigid or dissipative interconnection, for which the nonlinear constitutive relation is fully supported by experimental evidence of the assumed coefficients in the analysis [5]. Seven different acceleration time histories, with different time records (35s-70s) and described through 200 samples per second, have been used to describe the base motion, with spectrum characteristics compatible with the site (Figures 4) [4]. The numerical simulations carried out looking at the complete dynamic structural response (see for example Figure 5) have used as first starting value, the stiffness and viscous coefficient design parameters of the *Ma* linear model obtained through the method mentioned above for the preliminary design.

However, the final assessment of the viscous coefficient c characterizing mainly the nonlinear viscous dampers (Figure 5d) has been determined from a multistep iterative process, which has allowed the selection of its optimal values [6]. The fractional exponent α has been considered with fixed in the design process ($\alpha=0.15$), because the manufacturer has assigned it. Selection criteria including both the minimization of the displacements/accelerations at the highest floor, and the reduction of the base section shear stresses have been used.

The analyses show a good performance of the dissipative coupling if both the adjacent structures are subject to significant absolute and relative displacements, as verified in substructures A3 and A4. Differently, when the natural frequencies of the coupled structures are appreciably different, as occurred in the stiffer substructures A1, A2 and A6, despite the dissipation is potentially maximized; low displacements are associated to lower dissipated energy.

To reduce the displacements in the longitudinal direction on substructures A3 and A4, a proper coupling to the adjacent A2 and A6 substructures has been designed. The frequency difference in the dominant longitudinal modes of substructures A2 and A3, A4 and A6 has permitted to enhance the efficiency of the dampers in reducing the inter-storey drift in the higher floors. The dampers were installed at the third and fourth floor on the elevator tube-section (A2 and A6), or the frame (A3 and A4). The definition of three synthetic performance indices (J_i), the ratios between the structural performance of each original undamaged and retrofitted substructures, in terms of peak displacements (J_1), accelerations (J_2), and based shear forces (J_3), allow to clearly emphasize the achieved enhancement in the seismic behavior. Moreover, an additional index (J_4) represents the average of previous indices.

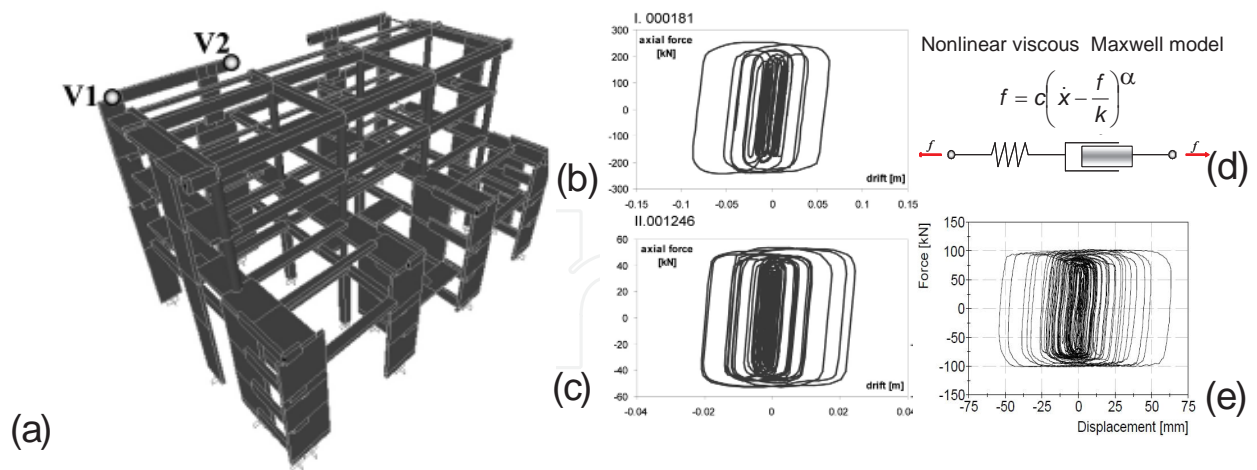

Figure 5. Numerical simulations: a) finite element model of substructure A3, b) c) numerically simulated dissipative cycles for the nonlinear viscous devices, d) nonlinear *Ma* model, e) experimental dissipative cycles.

	J_1	J_2	J_3	J_4
Longitudinal	0.74	0.85	0.73	0.78
Transversal	0.58	0.81	0.96	0.78

Table 4. Performance indices evaluated for the adopted solution.

The rewarding enhancement of seismic structural behavior of substructure A3 and A4, are demonstrated in Table 4, evidencing the effect of viscous coupling in the principal directions, monitored on the top floor. The designed retrofitting reduces substantially the maximum peak displacement (see J_1 in Table 4), particularly in transversal direction, out of plane of the coupled facade frame. The stiffer substructure A2 and substructure A6 contribute, through the viscous coupling, to reduce the maximum displacement in the longitudinal direction. Similar beneficial effects are registered in the peak acceleration reduction, both in transversal and longitudinal direction (see J_2 in Table 4) while the transverse shear force at the base of vertical resistant elements appears not significantly reduced by the viscous coupling (J_3 in Table 4). Figures 5b and c show selected dissipative cycles evaluated during the numerical simulation for a given different base excitation within the seven cases. One of the simulated behavior for a selected device has been also reproduced (Figure 5e) during the campaign tests for the mechanical characterization of the installed devices confirming the expected performances [7].

The use of the performance indexes have permitted to determine an optimized solution which take into account the possibility of having a limited number of different type of dampers, for production reasons. Figures 6a, b and c show the designed constitutive relations for the three selected dampers in the final solution furnished to the manufacturer. Figure 6d shows the results obtained during the test campaign [7].

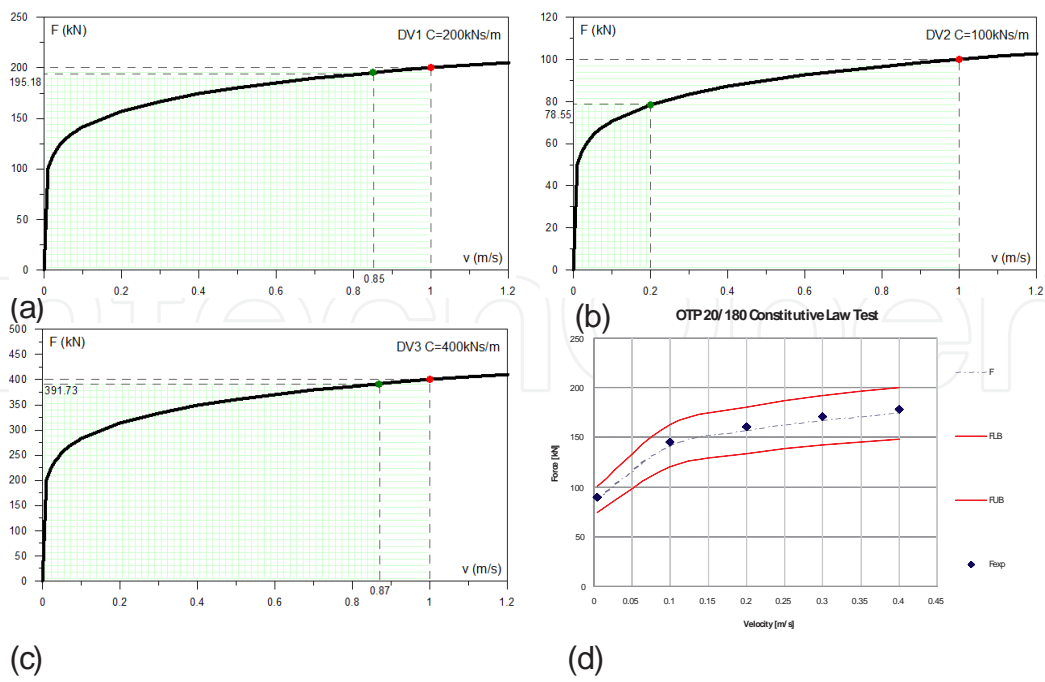

Figure 6. Design force-velocity relations for the three types of nonlinear viscous dampers; a) DV1 b) DV2 c) DV3 d) experimental data from the characterization tests [7].

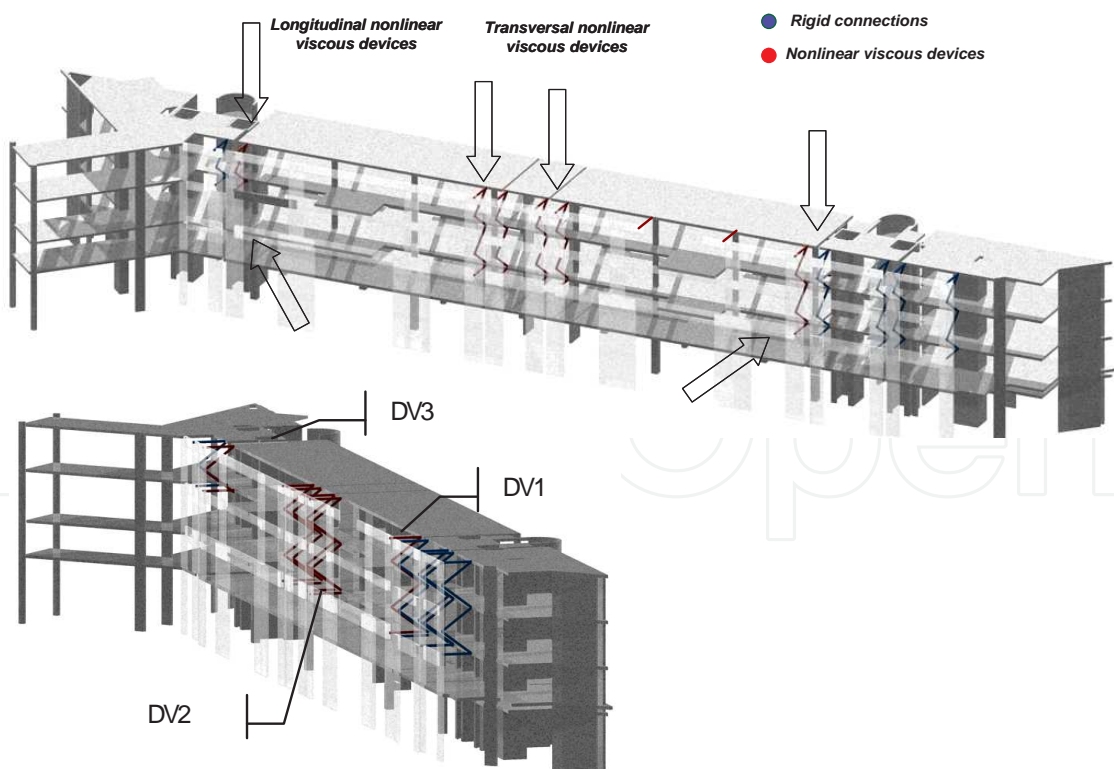

Figure 7. Three-dimensional sketch drawings reporting fluid viscous dampers locations in the structural retrofitting of the Edifice A of the Engineering Faculty of University of L'Aquila.

Figure 7 clarifies the location of the 43 devices: 18 DV1 (Type I); 17 DV2 (Type II); 8 DV3 (Type III) (as also reported in Table 2). In particular, in the transversal direction are working 18 DV1 devices in the higher positions (in the A3 substructure: 10 DV1, 4 horizontal and 6 oblique; in the A4 substructure 8 DV1, 2 horizontal and 6 oblique) and 17 DV2 in the lower positions and along the alignment of the slabs P1 (see Figure 2a) (in the A3 substructure: 4 DV2, 2 horizontal and 2 oblique; in the A4 substructure: 1 DV2 oblique; in contrast with the P1 slabs 12 DV2, 4 horizontal and 2 oblique) while 8 DV3 devices are working in the longitudinal direction positioned between A3-A2 and A4-A5.

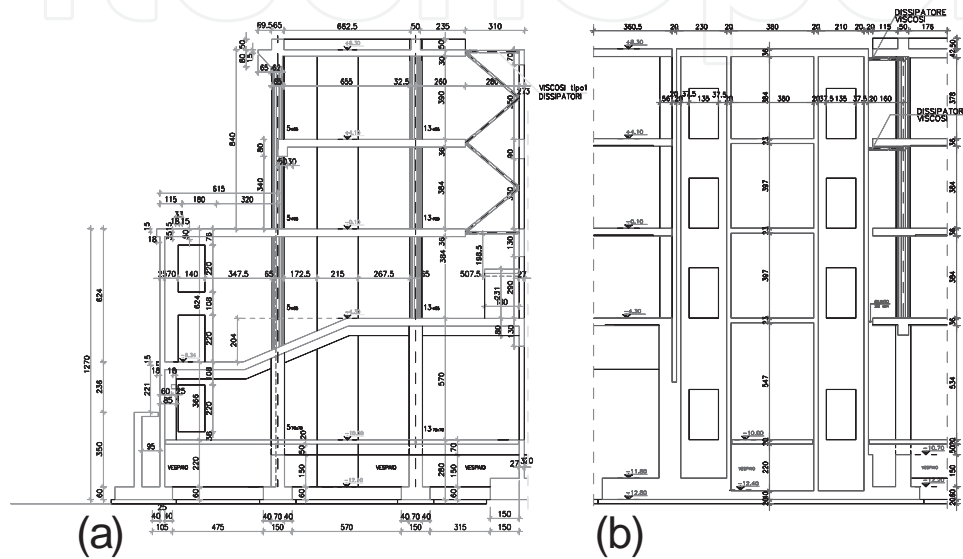

Figure 8. Nonlinear viscous damper placement: a) transversal; b) longitudinal.

Figure 8 shows a transversal and a longitudinal section where the protective devices are installed. In particular in Figure 8 it can be noted that a pair of DV3 devices is positioned at each of the two last level working in contrast between the substructures A3 and A2 thanks to the presence of a relevant seismic joint (depth= 20cm).

Figure 9 summarizes some relevant information such as: the large damage scenario appearing in the morning of April 7, 2009 immediately after the earthquake at the main facade of the Edifice A (Figure 9a); the facade completely rebuilt in a picture taken during the reconstruction (September 2011); of the same period two pictures presenting a close view of a DV1 horizontal device in the P1 zone (Figure 9c) and the four alignments of the dissipative trusses that following the perspective belongs the first one to the substructure A3 followed by two alignments in the P1 zone and completed by the last alignment which is the first one for the sub-structure A4 (Figure 9d). It can be noticed that in the last alignment due to the presence to the light stairs coming from the under floor the horizontal device is missed, this occurrence justifies the even total number of installed devices.

Together with the main structural seismic protection, here illustrated, the rehabilitation of the Edifice A has been conducted through the use of several technological applications to avoid



Figure 9. Reconstruction at Edifice A: a) damage scenario involving the facade, b) reconstruction of the facade, c) close view of the installed device, d) dissipative truss structures.

failure at the non-structural elements especially through the connection of both the reconstructed and the remained brick cladding with the reinforced concrete structures to avoid local failure due to the overturning of wall portion. The partition walls inside the building have been completely substituted with plasterboard fixed to aluminum profiles well anchored to the structural elements. Even if in the other two buildings (A and C) it was not necessary the use of seismic devices for structural protection, the approach followed in the work done in the Edifice A through the direct action of a non profit organization, have been extended to the other cases making realizable the return to the campus in the 2013 spring semester.

5. Structural health monitoring research activities at university of L'Aquila

A group of researchers of CERFIS (www.cerfis.it) with complementary skills is conducting a wide plan of activities in the field of dynamic testing under environmental loading and structural health monitoring for a series of buildings, with strategic or historical value, at L'Aquila. In the following a synthetic description of the most challenging findings is reported.

In order to achieve adequate level of confidence on the structural dynamic behaviour of the studied buildings a schedule of consequent activities are currently performed: (i) on-site dynamic testing under environmental actions with standard equipments [5,9,11,30]; (ii) finite element modelling based on exhaustive survey and material testing; (iii) definition of SHM-WSN sensor features; (iv) laboratory dynamic testing on 1:3 scaled frame in order to validate

procedures and wireless monitoring sensors; (v) deployment of structural health monitoring systems with wireless smart sensors; (vi) development and installation by remote programming of modal and damage identification procedures taking into account temperature variation effects.

All activities are at different stages of development, therefore in the following a synthetic description for each of them is presented, while the achieved results for the structural health monitoring of the Basilica di Collemaggio are finally reported.

5.1. On-site dynamic testing

The clear comprehension of structural behavior is a consequence of a deep investigation of the different aspects involved. However dynamic testing in operational condition, conducted recording only absolute accelerations at different significant points, can be very helpful [30]. Within the group, the data-recording is generally conducted using a multi-channel acquisition system. Servo-accelerometers (SA107LN-Columbia) have been used in previous experiences [5,30]. The on-site experiences have been recently completed by a comparative studies conducted on real experimental data on the most popular output-only identification procedures for modal model and their use to identify finite element parametrical model [11]. On this basis, the identification of modal parameters from ambient vibration data is currently carried out using two main procedures: Enhanced Frequency Domain Decomposition (EFDD) and Stochastic Subspace Identification (SSI)

The Enhanced frequency domain decomposition is a stochastic technique, operating in the frequency domain, based on the evaluation of the spectral matrix, collecting the frequency-depending power cross-spectral densities of the experimental structure response at different measurement points. The key point of the method is the assumption that, at a certain frequency, only a few significant modes (typically one or two) contribute to determine the spectral matrix.

Instead, the data driven Stochastic Subspace Identification method, representing a time domain technique, allows the modal identification of a structure through the eigenproperties of several stochastic state space models, built to reproduce its experimental response, and characterized by increasing order n . Therefore, the order of the model (or the subspace dimension), which better approximates the experimental response, is a matter of identification too.

5.2. Finite element modeling and updating

The assessment of a representative physical model differs from modal identification in a few conceptual and procedural aspects. Modal models consist of global information, and a few frequencies and mode shapes are expected to capture the dominant structural behaviour. In contradistinction, physical models include local information, such as the stiffness and mass spatial distribution, which in principle should be wholly reconstructed.

The simplifying hypotheses introduced in the modellization phase fix the model dimension, and rigidly determine the inherent structure of the stiffness and mass matrices. Such matrices can be initially evaluated according to nominal, or even estimated values of the mechanical

parameters. Forcing the reference model to match the experimental frequencies and modes, the identification process reduces to the calibration, or updating, of the initial parameter values, while the model dimension and the structure of the governing matrices remain unchanged.

Depending on the number, quality, and nature of the available information from the modal identification, different approaches to the physical model updating can be pursued [17]. Generally, the finite element models are used as a reference, taking advantage of the higher flexibility and computational efficiency of the numerical environment to explore different updating schemes [15], corresponding to different sets of free parameters. The data-to-unknowns redundancy is fully exploited, recurring to iterative techniques to minimize purposely-defined objective functions, expressing the error of the updated model in emulating the experimental modal data.

5.3. Definition of SHM-WSN sensor features

Vibration-based SHM requires sensed data that well represents the physical response of the structure both in amplitude and phase. The measurements must have sample resolution to characterize the structural response and must be recorded with a consistent sample rate that is synchronized with other sensed data from the structure. The sensor hardware needs for a sensor board with higher resolution and more accurate sampling rates designed specifically for SHM applications.

The ST Microelectronics LIS344ALH capacitive-type MEMS accelerometer with DC to 1500 Hz measurement range, was chosen for the SHM-A board. This type of accelerometer utilizes the motion of a proof mass to change the distance between internal capacitive plates, resulting in a change of output voltage in response to acceleration. Though MEMS accelerometers are available with lower noise levels, the ST Micro accelerometer offers an excellent price/performance ratio. In addition, it provides three axes of acceleration on a single chip. The specifications for the accelerometer are given in Table 5. The SHM-A sensor board has been designed for monitoring civil infrastructure through the Illinois SHM Project, an interdisciplinary collaborative effort by researchers in civil engineering and computer science at the University of Illinois at Urbana-Champaign [31].

Two hardware configurations of smart sensor nodes are required for the wireless communication and sensing: a gateway node for sending commands and receiving wireless data from network, and the battery powered nodes remote to the base station. To increase the communication range, both nodes are equipped with an antenna, which covers the communication in a range of 30m and a SMA connector to install an external additional antenna. In the CERFIS configuration a watertight partial-gauzy box, allowing an in-the-distance visibility of light sensor to check the efficiency of the remote node, protects the boards. An external cable connecting both the 220V electric web and an energy store box, composed by three rechargeable 1.5V batteries IND alkaline D size with capacity of 20500mAh each, to assure a continuous registration procedure during earthquake events, powers each node. The sensor location, inside historical monuments, does not allow an autonomous powered, as trough the well-

known solar panels. An additional USB receptacle is installed to allow the link with a PC. The wireless communication is entrusted to an ADC converter.

Parameter	Value
Axes	3
Measurement range	$\pm 2g$
Resolution	0.66 V/g
Power supply	2.4 V to 3.6 V
Noise density, x-and y-axes	22 – 28 $\mu g/Hz$
Noise density, z-axis	30 – 60 $\mu g/Hz$
Temperature range	-40 to 85°C
Supply current	0.85 mA

Table 5. Accelerometer specifications.

5.4. Laboratory dynamic testing and wireless sensor characterization

Preliminary tests are conducted using a modular structural steel frame located at the CERFIS laboratory of University L'Aquila to characterize a SHM-WSN. In particular two different types of test have been performed. In the first series a direct comparison one single wireless sensor (the above described IMOTE 2 type) and one wired accelerometer (SA107LN-Columbia) has been conducted (Figure 10). Within this configuration the frame responses both to a little impulse in longitudinal direction and under environmental noise have been recorded. Others tests have been made using six wireless sensors, two for each slab, placed at diagonally opposite corners. This particular experimental setup has been used to identify the main modal frequencies, shapes and damping. Again both impulsive and ambient tests have been performed. The results are here not reported for sake of brevity. Moreover, in all tests, the wireless sensors, installed in the prototype structure, transfer the collected data to a single wireless node (gateway mode) linked to the acquisition card.

The investigation in the lab environment will be conducted on new sensor configurations fully developed by the CERFIS group. As is well known, one of the major limitations of wireless nodes are the limited performances. Therefore, the idea is to use configurable hardware devices (e.g. FPGA) for the creation of hw/sw mixed service based architecture, with processing services directly implemented in hardware. In practice, we want to combine the mote processor with a set of ad-hoc developed co-processors specifically designed for the implementation of various processing modules. We think that this strategy will significantly increase monitoring efficiency, not only allowing a real-time processing, but also enabling the simultaneous support of different analysis techniques addressed to a wide range of application scenarios, from the pure structural health monitoring up to the emergency management, which imply often divergent specific requirements.

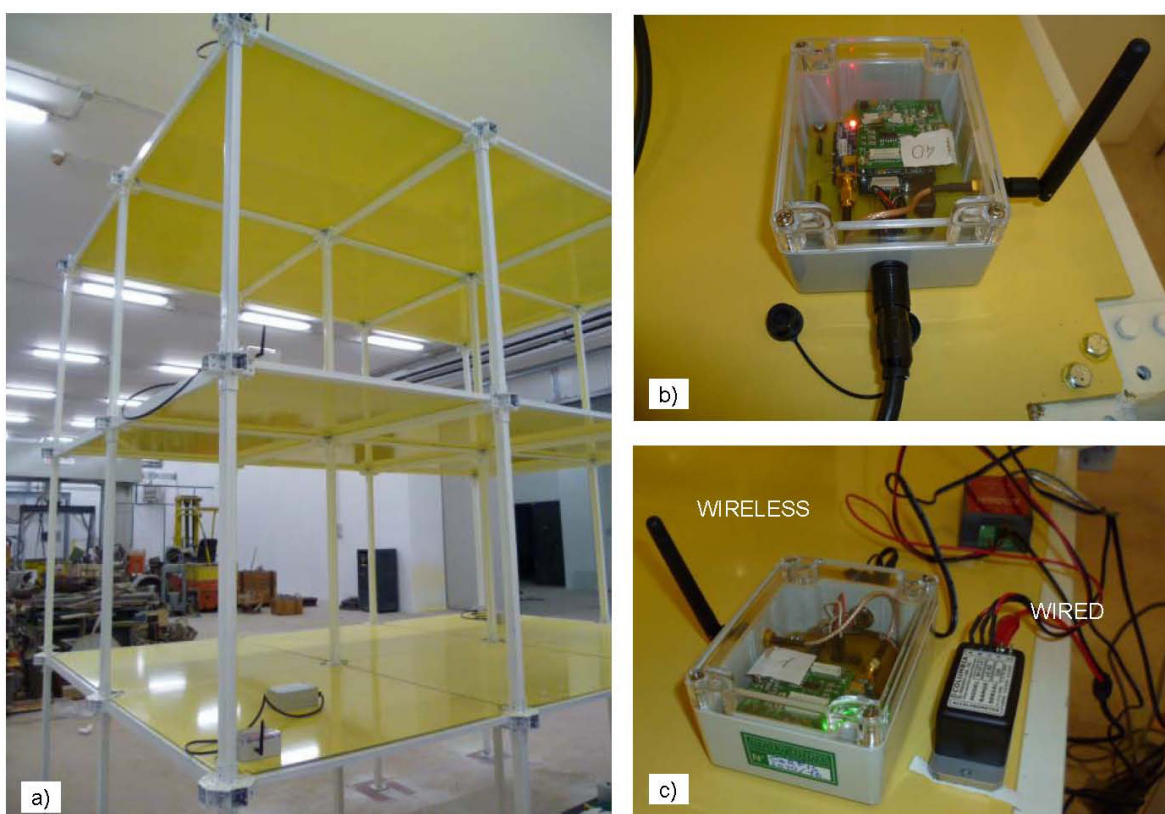

Figure 10. Light model (scale 1:3) of modular steel-made three-dimensional frame: (a) basic configuration, (b) sensor-node of wireless network; (c) comparison with sensor of traditional wired network

5.5. SHM-WSN deployment on strategic and historical structures

Traditionally, a grid of sensor was deployed across a building and the measured data were conveyed via a cable connection to a central processing system (e.g. a personal computer). Recently, Wireless Sensor Networks (WSN) emerged as a possible attractive alternative solution, mainly due to the lower cost, lower size of the systems and ease of setup respect traditional wired systems thanks to the multi-hop connection capabilities which allow the nodes to organize themselves in a network where each node can be source, destination and also a router for the information flowing within the network.

Current wireless monitoring systems are usually based on off the shelf sensor nodes equipped with new generation low cost, small sensors (e.g. MEMS accelerometers). Although these systems are not specifically designed for structural monitoring applications, they can still provide good performances. For example, Illinois Structural Health Monitoring Project (ISHMP) has shown the potential of WSN in several real monitoring scenarios [31]; they used a network of Imote2 motes equipped with a specifically design sensor board (ISM400) and an embedded processing software (ISHMP Toolsuite) based on TinyOS.

Data processing is a key point in the future development of wireless monitoring systems. Many wireless implementations adopt a traditional processing paradigm, with data transmitted from

the sensor nodes to a central gateway connected to a PC that performs the entire processing. However, modern sensor nodes are equipped with a microprocessor, allowing them to carry out local processing of data. In other words, data processing can be distributed across the network.

The wireless systems, in fact, have progressed very rapidly in recent years and are now considered the enabling technology for realizing the pervasive ubiquitous computing environment that should support advanced distributed applications in many domains, especially for advanced distributed applications.

Therefore, owing to unprecedented design challenges and potentially large revenues, wireless sensor networks are calling huge interest in both the scientific and the industrial world. Besides a secure optimization of transmission (as shown by ISHMP work, whose software is already partially decentralized), processing de-centralization can bring the advantage of being able to quickly detect local phenomena, even in case of network splitting as a consequence of critical phenomena as an earthquake. This capability can be extremely useful in security systems or, generally, in the field of emergency management.

A series of activities are still under development to rethink structural modal analysis techniques, towards the goal of a distributed processing within the network, which could efficiently support real-time monitoring and safety oriented services [10]. Firstly, moving from the achievements and contributions of ISHMP, an iMote2-based monitoring system was developed. Moreover, the ISHMP software tools will be integrated with ad-hoc applications, in order to achieve an efficient distributed processing within our network. Moreover, optimizations of limited energy resources may be achieved through suited techniques of data compression and aggregation, providing reduced energy costs of communications and lower channel capacity for data delivery.

The choice of the ISHMP software tools is not simply determined by the convenience of having a ready-to-use, decentralized-oriented middleware, but has a deeper reason. In fact, given the particular characteristics of the processing, the ISHMP Toolsuite was designed as a service-based software architecture. In other words, the various processing steps are implemented as services, and each application is just a collection of independent modules.

6. The structural health monitoring of the Basilica di Collemaggio

The Basilica S. Maria di Collemaggio is one of the most attractive churches in Centre Italy. It dates from the XV century. The Basilica has a nave and two side aisles. The dimension of the nave is 61m in length and 11.3m in width; its height reaches 18.25m. The two side aisles are 7.8 and 8m in width; two external walls both 12.5m high delimit them. Seven columns, not evenly distanced, on each side separate the nave and two side aisles. The columns are about 5.25m high; a layer of well-laid stone, made of a calcareous material arranged irregularly in a poor quality mortar, encloses their core; the transverse section, approximately circular, is on average 1.00 m in diameter. The thickness of masonry varies from 0.95 m to 1.05 in the external

walls; it is 0.9m in the two walls of the nave, over the columns. The four walls are connected on one side to the facade of the Basilica and, on the other side, to the transept. The facade is joined to a thick octagonal tower on the right corner; another masonry building is adjacent to a part of the wall, about 40% of it, behind the tower. The wooden roof is supported from trusses placed in a cross-sectional direction to the walls.

Before the occurring of the 6th April 2009 earthquake a numerical and experimental study has permitted to characterize the dynamic behavior of the Basilica [32-34]. The experimental data were firstly used to identify a modal model and then to determine suitable FE models able to predict and frame the dynamical response of the church. Preliminary numerical analyses were carried out on the basis of several assumptions regarding: (1) mechanical parameters of masonry, (2) timber trusses of the roof, (3) restraints in walls and columns, (4) links among structural components. Afterwards the Basilica was excited at a low level by an instrumented hammer and a mechanical vibration exciter (vibrodyne). Several tests have been carried out, with different positions of the instruments and impact locations, in order to excite and to measure as many modes as possible.

The vibrodyne was located on the top of a lateral wall. The frequency responses were directly measured around the first two modes; these are the most important ones that describe the dynamic response of the church. Experimental data have been used to identify natural

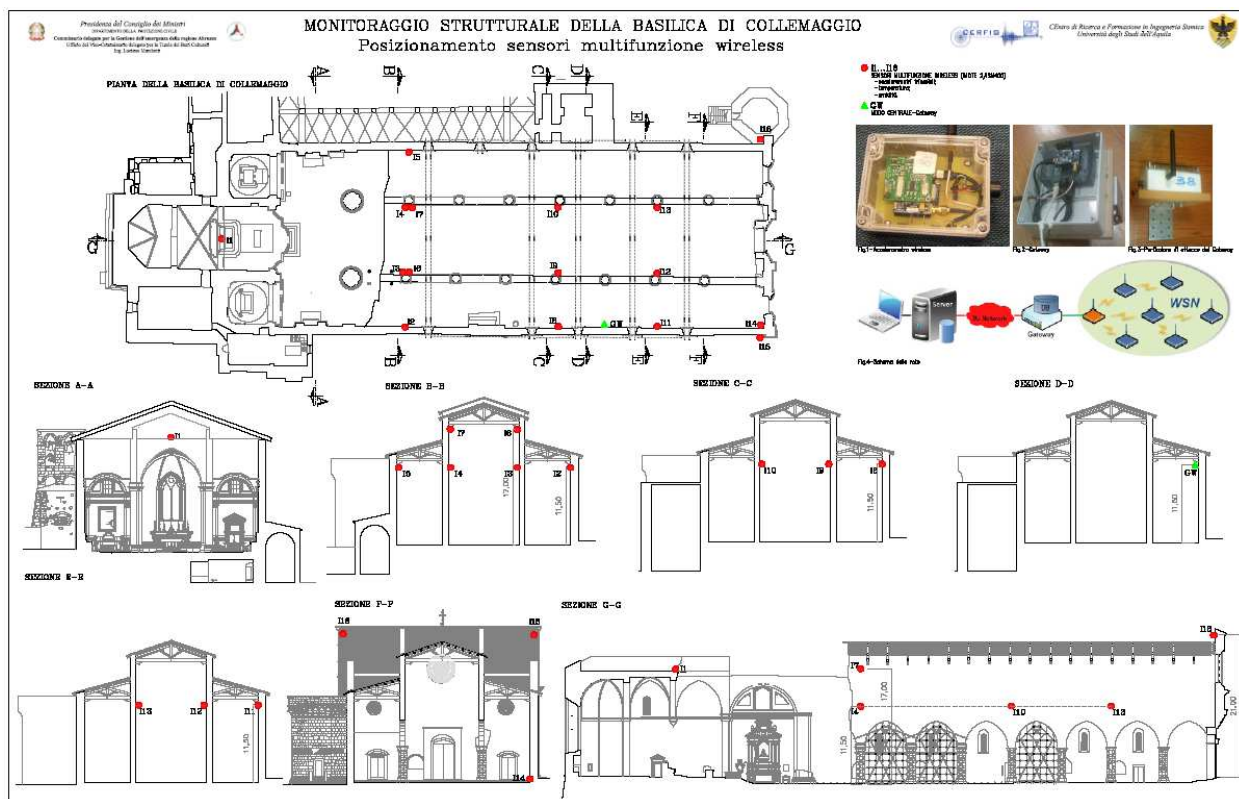

Figure 11. Drawings for the locations of the 16 smart sensors mounting tri-axial MEMS accelerometers, humidity and temperature measuring instruments, installed at the Basilica di S. Maria di Collemaggio, at L'Aquila, Italy.

frequencies, modal displacements and damping factors. The first campaign of tests [32] have permitted to recognise at least four major resonance peaks in the range 0.8÷3.0 Hz.

The first two peaks are around frequencies values, about 1.25 and 1.7 Hz. Other peaks are present over 2 Hz. Two of them, around 2.5 and 2.7 Hz, are well defined in all tests. Secondary peaks, around 2.2, 2.3 and 2.6 Hz, are not always visible in all the responses; they indicate the occurrence of highly coupled modes. These peaks, however, are estimated to be less important: numerical analysis indicates that the participating mass of first two modes is at least 85% of total mass in the transverse direction of the church.

After retrofitting, all peaks are shifted to higher frequencies [33]. The first two are around 1.45 Hz and 2.12 Hz respectively. Other peaks are clearly visible around 2.6 and 2.95 Hz. Secondary peaks, which are not always visible in all the responses, are recognisable even in this case. Higher frequencies are a consequence of the increasing stiffness brought about by retrofitting. It is interesting to observe that now the responses of a pair of accelerometers are basically identical, at least in the range of frequencies examined. This is a clear indication that the retrofitting had improved the link between the longitudinal walls. Other dynamic testing have been performed on the facade [34] which have permitted to evidence that out-of-plane local

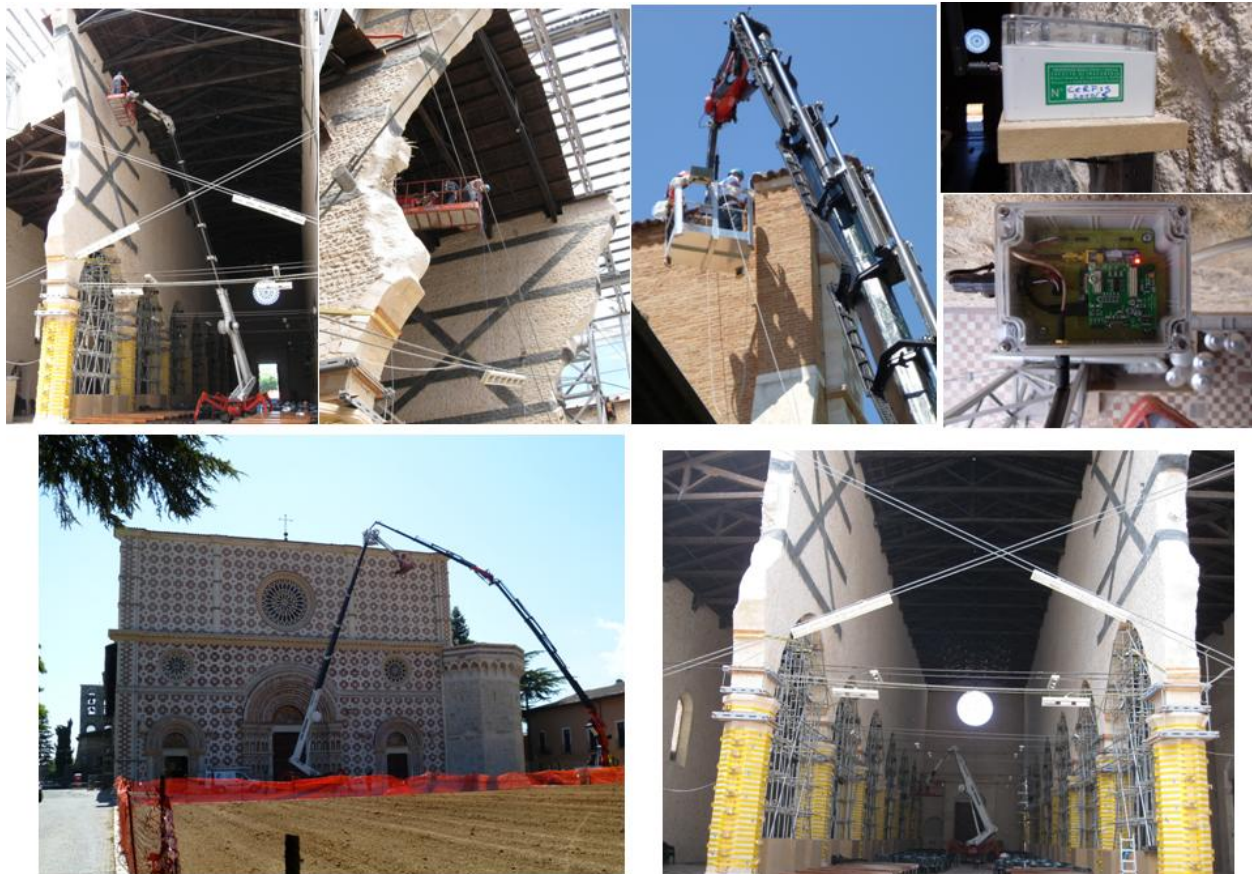

Figure 12. Installation phases of the monitoring system at the Basilica di S. Maria di Collemaggio: a) b) sensor positioning on the central walls of the nave, c) sensor positioning beyond the facade, d) f) sensor views, g) phase of on-site testing, h) sensor positioning at the end of the nave walls.

modes of this element are in a frequency range higher than the transversal mode of the nave. Recently, after the earthquake a strong effort has been made to use all the available data from the previous on-site dynamic campaign in order to develop a series of complete finite element models of the Basilica able to reproduce the main modal identified characteristics and the collapse scenario [35]. Starting from these models, a reproduction of the scenario after the collapse has been pursued [8, 36]. A campaign of numerical simulations has been conducted to evaluate the dynamic response of the Basilica together with the temporary retrofitting under small earthquakes characterizing the numerous aftershocks at L'Aquila.

The previous installation for the on-site dynamic testing campaigns together with the observation obtained by the modelling have driven the monitoring installation scheme reported in Figure 11. The wireless network composed by 16 smart sensors (see also Table 3) has been finally installed on June 2011. During the successive months the monitoring system has been enhanced and brought to complete and automatic management to sense seismic induced vibrations. During this path, several test campaigns have been conducted making use of different induced source of vibrations such as hammer, ambient vibrations and free-vibration tests [37]. Finally, in six cases, the seismic induced response of the structures of S. Maria di Collemaggio has been cleared measured, as reported in Table 5. The results of the identification process will be object of further publications.

Number	Earthquakes	Date	Time UTC	Magnitudo MI	Maximum recorded response acceleration (g)
1	Main shock Emilia	20/05/2012	2.03	5,9	0,0054
2	Aftershock Emilia	20/05/2012	13.18	5,1	0,0018
3	Shock Ravenna	06/06/2012	6.08	4,5	0,0014
4	L'Aquila	14/10/2012	16.32	2,8	0,0072
5	L'Aquila	30/10/2012	2.52	3,6	0,0073
6	L'Aquila	16/11/2012	3.37	3,2	0,0082

Table 6. Recorded structural response of S. Maria di Collemaggio.

7. Conclusions

The chapter aims to present the rapid development in the transfer to the real applications of the available technology in the sector of structural control and health monitoring, occurred at L'Aquila immediately after the 2009, L'Aquila earthquake. The benefits in the application of these emerging technologies are still under verification and observation. For the performance evaluation of the installed seismic protections systems, only the occurrence of a relative strong seismic motion, will clearly evidence the benefits introduced in the territory. Differently, the large amount of activities concerning material and in-situ testing together with small or long-term monitoring will surely increment the knowledge regarding the real behaviour of complex masonry or reinforce concrete structures. The amount of obtained data from this large campaign of testing, conducted with different techniques and aims, is in many cases larger

than the real possibility of a deep discerning. Indeed a complete extraction of valuable information useful for the understanding of the material and structural behaviour of the large amount of buildings, infrastructure and historical monuments is still undergoing. The presented overview, even if conducted more on an informative level than in a deep scientific manner, remains a valuable starting point for searching innovative procedures and devices in the considered research field. The above references will permit a deeper analysis on specific questions and further publications will make into evidence specific novel findings, developed during the difficult path of doing innovative research in a territory in which a natural disaster has strongly modified the habitual activities conducted before the event.

Acknowledgements

First of all, the author wishes to acknowledge with the numerous young students at any level (5yrs degree, MS and PhD) of the University of L'Aquila and coming from other Universities, which make realizable all the work synthesized in this chapter. Special thank goes to the co-authors of the above referenced publications produced at the University of L'Aquila, from which most of the material here presented is taken and re-arranged. Several research grants have permitted the development of the research such the MIVIS project financed by CARIS-PAQ, the RELUIS projects financed by DPC, the PRIN projects financed by MIUR, the RICOSTRUIRE project financed by the Development Italian Ministry.

Author details

Vincenzo Gattulli

DICEAA, CERFIS, University of L'Aquila, Italy

References

- [1] Ceci AM, Contento A, Fanale L, Galeota D, Gattulli V, Lepidi M, Potenza F. Structural performance of the historic and modern buildings of the University of L'Aquila during the seismic events of April 2009. *Engineering Structures* vol. 32(7), pp. 1899-1924, 2010.
- [2] Gattulli V. Role and perspective of computational structural analysis for sustainable reconstruction and seismic risk mitigation after an earthquake. in B.H.V. Topping and Y. Tsompanakis, (Editor), "*Civil and Structural Engineering Computational Technology*", Saxe-Coburg Publications, Stirlingshire, UK, Chapter 1, pp 1-34, 2011. doi: 10.4203/csets.28.1

- [3] Beolchini GC, Conflitti G, Contento A, D'Annibale F, Di Egidio A, Di Fabio F, Fanale L, Galeota D, Gattulli V, Lepidi M, Potenza F. Il comportamento degli edifici della Facoltà di Ingegneria dell'Aquila durante la sequenza sismica dell'Aprile 2009. *XIII Convegno di Ingegneria Sismica ANIDIS, Bologna (Italia), Giugno 2009* (in Italian).
- [4] Ceci AM, Gattulli V, Potenza F. Serviceability and damage scenario in RC irregular structures: post-earthquake observations and modelling predictions. *ASCE Journal of Performance of Constructed Facilities*, in press, 2013.
- [5] Foti D, Mongelli M, Gattulli V, Potenza F, Ceci A. Output-only structural identification of the Engineering Faculty Edifice A at L'Aquila. *Fourth IOMAC Conference, Istanbul, Turkey 2011*.
- [6] Gattulli V, Lepidi M, Potenza F, Ceci A. Nonlinear viscous dampers interconnecting adjacent structures for seismic retrofitting. *8th European Conference on Structural Dynamics, Eurodyn11, Leuven, Belgium, 2011*.
- [7] Castellano MG, Gattulli V, Borrella R, Infanti S. Experimental characterization of nonlinear fluid viscous dampers according to the New European Standard. *5th European Conference on Structural Control, EACS12, Genoa, Italy, 2012*.
- [8] Antonacci E, Gattulli V, Martinelli A, Vestroni F. "Analisi del comportamento dinamico della Basilica di Collemaggio per il progetto di un sistema di monitoraggio". *XIV Convegno di Ingegneria Sismica ANIDIS, Bari (Italia), Settembre 2011* (in Italian).
- [9] Antonacci E, Ceci AM, Colarieti A, Gattulli V, Graziosi F, Lepidi M, Potenza F. Dynamic testing and health monitoring via wireless sensor networks in the post-earthquake assessment of structural condition at L'Aquila. *8th European Conference on Structural Dynamics, Eurodyn11, Leuven, Belgium, 2011*.
- [10] Federici F, Graziosi F, Faccio M, Gattulli V, Lepidi M, Potenza F. An integrated approach to the design of Wireless Sensor Networks for structural health monitoring. *International Journal of Distributed Sensor Networks*, Volume 2012 (2012), Article ID 594842, 16 pages doi:10.1155/2012/594842
- [11] Antonacci E, De Stefano A, Gattulli V, Lepidi M, Matta E. Comparative study of vibration-based parametric identification techniques for a three-dimensional frame structure. *Journal of Structural Control and Health Monitoring*, Volume 19, Issue 5, pages 579–608, August 2012 doi: 10.1002/stc.449, 2012.
- [12] Calvi GM. L'Aquila earthquake 2009: reconstruction between temporary and definitive. *2010 NZSEE Conference*.
- [13] Salvatori A. Edifici con isolamento sismico alla base: la nuova Facoltà di Lettere, Filosofia e Scienze della Formazione dell'Università dell'Aquila. *XIII Convegno di Ingegneria Sismica ANIDIS, Bologna (Italia), Giugno 2009* (in Italian).
- [14] Cartapati E. L'intervento di miglioramento antisismico delle navate della Basilica di Santa Maria di Collemaggio. *Atti della Giornata di Studio: Patrimonio Storico Architetto-*

nico e Terremoto. *Diagnosi ed Interventi di recupero*, L'Aquila, November 2000, pp. 155–164 (in Italian).

- [15] Maugeri M, Simonelli AL, Ferraro A, Grasso S, Penna A. Recorded ground motion and site effects evaluation for the April 6, 2009 L'Aquila earthquake. *Bull Earth. Eng.* 9, 157–179, 2011.
- [16] Spina D, Lamonaca BG, Nicoletti M, Dolce M. Structural monitoring by the Italian Department of Civil Protection and the Case of 2009 Abruzzo Seismic Sequence. *Bull Earth. Eng.* 9, 325–346, 2011.
- [17] Russo S. On the monitoring of historic Anime Sante church damaged by earthquake in L'Aquila. *Journal of Structural Control and Health Monitoring*, doi: 10.1002/stc.1531, in press.
- [18] Luco JE, Francisco CP, Barros D. Optimal damping between two adjacent elastic structures. *Earthquake Engineering and Structural Dynamics*; 27:649-59, 1998.
- [19] Luco JE, F.C.P. De Barros. Control of the seismic response of a composite tall building modelled by two interconnected shear beams. *Earthquake Engineering and Structural Dynamics*; 27:205-33, 1998.
- [20] Xu YL, He Q, Ko JM. Dynamic response of damper-connected adjacent buildings under earthquake excitation. *Engineering Structures*; 21:135-48, 1999.
- [21] Zhang WS, Xu YL. Dynamic characteristics and seismic response of adjacent buildings linked by discrete dampers. *Earthquake Engineering and Structural Dynamics*; 28:1163-85, 1999.
- [22] Aida T, Aso T, Takeshita K, Takiuchi T, Fuji T. Improvement of the structure damping performance by interconnection. *J. of Sound and Vibration*; 242(2):333-53, 2001.
- [23] Zhu HP, Wen Y, H. Iemura. A study of interaction control for seismic response of parallel structures. *Computers & Structures*; 79:231-42, 2001.
- [24] Zhu HP, Xu YL. Optimum parameters of Maxwell model-defined dampers used to link adjacent structures. *J. of Sound and Vibration*; 279:253-74, 2005.
- [25] Kim K, Rye J, Chung L. Seismic performance of structures connected by viscoelastic dampers. *Engineering Structures*; 28:83-195, 2006.
- [26] Gattulli V. On the dissipative coupling of adjacent structures, XX Congresso Nazionale AIMETA'11, Bologna, Italy, 12-15 Settembre, 2011.
- [27] Gattulli V, Lepidi M, Potenza F, Ceci AM. Seismic protection and retrofitting through nonlinear fluid viscous damper interconnecting substructures, *EACS 2012, 5th European Conference on Structural Control*, Genoa, Italy – 18-20 June 2012.
- [28] Gattulli V, Potenza F, Lepidi M. Damping performance of two oscillators coupled by alternative dissipative connections. *Journal of Sound and Vibration*, in preparation.

- [29] NTC 08, Decreto Ministeriale 14/01/2008. Norme tecniche per le costruzioni, Gazzetta Ufficiale No. 29 (in Italian) Ministero delle Infrastrutture, 2008.
- [30] Lepidi M, Gattulli V, Foti D. Swinging-bell resonances and their cancellation identified by dynamical testing in a modern bell tower. *Engineering Structures*, vol. 31, p. 1486-1500, 2009.
- [31] Rice J, Spencer Jr B, Flexible smart sensor framework for autonomous full-scale structural health monitoring, NSEL Report Series 018, 2009.
- [32] Antonacci E, Beolchini GC, Di Fabio F, Gattulli V. The dynamic behavior of the Basilica S. Maria of Collemaggio, *Proc. 2nd Intern. Congr. on Studies in ancient Structures*, Istanbul, Turkey, 2001.
- [33] Antonacci E, Beolchini GC, Di Fabio F, Gattulli V. Retrofitting effects on the dynamic behaviour of S. Maria di Collemaggio, *Tenth International Conference on Computational Methods and Experimental Measurements*, Alicante, Spain, June 4-6, 2001.
- [34] Antonacci E, Beolchini GC, The dynamic behaviour of the facade of the Basilica di S. Maria di Collemaggio. *Proc. of Structural analysis of historical constructions, IV International Seminar*, Padova, Italy, 2004.
- [35] Gattulli V, Antonacci E, Vestroni F. Field observations and failure analysis of the Basilica S. Maria di Collemaggio after the 2009 L'Aquila earthquake. *Engineering Failure Analysis* submitted 2012.
- [36] Gattulli V, Lampis G, Antonacci E. Sviluppo di modelli strutturali ad elementi finiti ed analisi della risposta dinamica della Basilica di S. Maria di Collemaggio. Settembre 2011 *Pubblicazioni CERFIS*, Centro di Ricerca e Formazione in Ingegneria Sismica, Università degli studi dell'Aquila Rpt. 4/11, 2011 (http://www.cerfis.it/it/download/doc_download/82-report-cerfis-n4-2011.html).
- [37] Antonacci E, Colarieti A, Federici F, Gattulli V, Graziosi F, Lepidi M, Potenza F. Caratteristiche del sistema di monitoraggio della Basilica di S. Maria di Collemaggio. Settembre 2011 *Pubblicazioni CERFIS*, Centro di Ricerca e Formazione in Ingegneria Sismica, Università degli studi dell'Aquila Rpt. 6/11, 2011 (<https://www.box.com/s/209e12ac7373ebfd5200>)

