

# We are IntechOpen, the world's leading publisher of Open Access books Built by scientists, for scientists

## 4,800

Open access books available

## 122,000

International authors and editors

## 135M

Downloads

Our authors are among the

## 154

Countries delivered to

## TOP 1%

most cited scientists

## 12.2%

Contributors from top 500 universities

**WEB OF SCIENCE™**Selection of our books indexed in the Book Citation Index  
in Web of Science™ Core Collection (BKCI)

Interested in publishing with us?  
Contact [book.department@intechopen.com](mailto:book.department@intechopen.com)

Numbers displayed above are based on latest data collected.

For more information visit [www.intechopen.com](http://www.intechopen.com)

---

# **Evaluation of Soybean Straw as Litter Material in Poultry Production and Substrate in Composting of Broiler Carcasses**

Valeria Maria Nascimento Abreu,  
Paulo Giovanni de Abreu,  
Doralice Pedroso de Paiva, Arlei Coldebella,  
Fátima Regina Ferreira Jaenisch,  
Taiana Cestonaro and Virginia Santiago Silva

Additional information is available at the end of the chapter

<http://dx.doi.org/10.5772/54068>

---

## **1. Introduction**

The litter has never been a subject of extensive studies or considered a priority in large poultry company. However, due to the increasing lack of good litter material, more attention has been given to proper litter management, litter reuse, and to the search for new litter materials. In this context, the use of crop residues as poultry litter material seems to be promising. There is a current trend in poultry production to use alternative litter materials, that is, other than wood shavings. Despite being demonstrated by several authors that the use of these alternative materials do not interfere with flock live performance, most agree that they are more difficult to manage and may result in a higher incidence of carcass lesions. The effects of several many materials used as poultry litter substrate on poultry performance have been evaluated. It was shown that litter made of rice husks not only does not impair performance, but also reduced foot-pad and breast lesions [1, 2 – 9]. A study on the use of soybean crop residues as poultry litter did not show any influence of this material on broiler performance or on its agronomic value [10]. However, these bedding materials have not been evaluated as to the evolution of darkling beetle and enteric parasite populations. *Alphitobius diaperinus* (darkling beetle) adults and larvae are considered a problem in intensive broiler and turkey production.

These beetles replicate in the litter, becoming potential vectors of pathogens and parasites both on site and to the neighboring farms. Those insects have been associated to many pathogenic agents, and there are reports they carry *Escherichia coli*, *Salmonella spp*, avian leucosis virus, as well as internal parasites, such as coccidian, avian tapeworms, and helminths [11,12], enterobacteria [13] and *Clostridium perfringens* [14]. Attempts to control darkling beetles have been made by changing the litter pH using hydrated lime [15]) or applying insecticides in the entire poultry house during downtime [16] or as a management complement during rearing, with application in specific spots, as suggested by [17]. The continuous contact of birds with the excreta in the litter poses a risk of infection with parasites, and coccidiosis caused by *Eimeria spp* is one of the most significant diseases in this production system. The evolution of oocyst population may determine the need to change the litter, and an evaluation may aid decision-making regarding this need. Litter reutilization for more than one flock is practiced in several countries. However, aspects relative to the potential health risk posed by these alternative litter materials have been discussed, and their use may limit the international chicken meat trade due to the requirements of showing equivalence of production processes practiced among exporting and importing countries [18]. The study was divided into three parts, where the use of soybean straw as litter in the poultry production was compared with rice husk under two ventilation conditions, as follows.

## 2. The study

The experiment was carried out at the experimental field of Suruvi, belonging to Embrapa Swine & Poultry, Concórdia, Santa Catarina, Brazil. Four 12m×10m broiler houses were internally divided in four pens each (total of 16 pens), at a density of 200 birds/pen (28kg meat/m<sup>2</sup>), totaling 3,200 birds/flock. Four consecutive flocks were followed up. Each flock was reared to 42 days of age, and an interval between flocks (downtime) of 15 days was applied. Two ventilation systems (stationary or oscillating), reaching a distance of 10m, and two litter materials (soybean straw or rice husks) were tested. Rice husks and ventilation system using stationary fans are considered as standards as they are commonly used in broiler production. Fans were activated by a thermostat when the environmental temperature reached 25°C, and were equipped with a potentiometer and speed regulator matching the broiler house size. Treatments were distributed as follows (Figure 1): house 1 – stationary ventilation system, pens 2 and 3 with soybean straw; pens 1 and 4 with rice husks; house 2 – oscillating ventilation system, pens 2 and 3 with soybean straw; pens 1 and 4 with rice husks; house 3 - oscillating ventilation system, pens 1 and 4 with soybean straw; pens 2 and 3 with rice husks; house 4 – stationary ventilation system, pens 1 and 4 with soybean straw; pens 2 and 3 with rice husks. Birds and feeds were weekly weighed and the following parameters were evaluated: body weight, weight gain, feed intake and feed conversion ratio when birds were 21, 35 and 42 days of age. Performance data were analyzed according to the theory of mixed models for repeated measures, considering the effects of flock, ventilation system, litter material, bird age, and the interaction of these parameters up to third or-

der, and 16 types of variance and covariance matrices, using PROC MIXED procedure of SAS statistical package [19], according to [20].

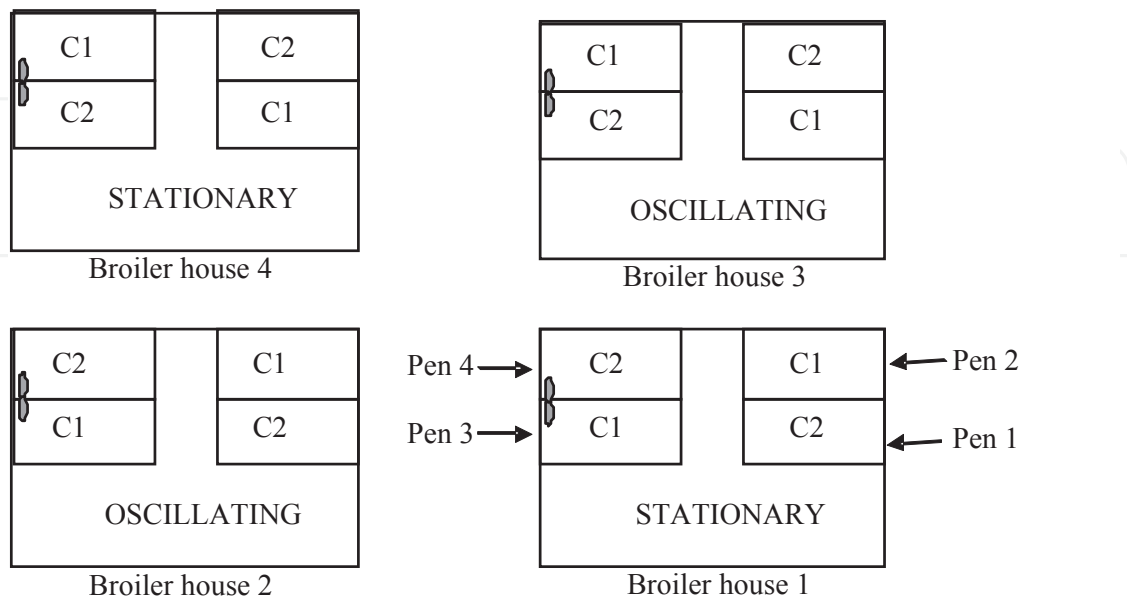

**Figure 1.** Fan (stationary and oscillating) and litter material (C1 – soybean straw and C2 – rice husks) distribution in the experimental facilities

The variance and covariance structure used for analysis was chosen based on the lowest value of the Akaike Information Criterion (AIC). The estimation method was that of restricted maximum likelihood. Mortality was daily recorded and assigned to ascitis, sudden death, or other causes. Total mortality was also evaluated. Breast and foot-pad lesions were evaluated by gross examination the last time birds were weighed, and scored as present or absent. Because mortality and presence of foot-pad lesion data have binomial distribution, these data were analyzed by logistic regression, using the LOGISTIC procedure of SAS statistical package [19], and considering the effects of flock, litter material, ventilation system, and their interactions. The overdispersion of the presence of foot-pad lesion was adjusted by the dispersion parameter estimated by Pearson's  $\chi^2$  statistics divided by degrees of freedom. Litter samples were collected at each flock, when chicks were housed (day 0) and when they were removed (day 42), and submitted to enterobacteria quantitative exam. Litter samples weighing 10g were diluted at 1:10 in PBS (phosphate buffer saline solution) and serially diluted to  $10^{-7}$ . Aliquots of 100  $\mu\text{L}$  of  $10^{-3}$  to  $10^{-7}$  dilutions were seeded in Mac Conkey agar and incubated at  $37^\circ\text{C}$  for 48h, and submitted to colony-forming unit (CFU) counting in plates containing 30 to 300 colony-forming units. CFU data analysis considered the effects of flock, litter material, ventilation system, and their interactions and used the theory of mixed models for repeated measures and nine variance and covariance matrix structures applied to the PROC MIXED procedure of SAS statistical package [19]. The following psychrometric parameters were recorded at the center of each pen and in the external environment: dry- and wet-bulb temperature, black globe temperature, and air velocity. Temperatures were

collected using copper-constantan thermocouples connected to a potentiometer and a 20-channel selecting key. The wet bulb thermometer was characterized by securing a cotton wick attached to the thermocouple terminal to the mercury bulb and immersing it in a flask with distilled water. Black globe temperature was collected by placing thermocouples inside a hollow 15cm-diameter PVC sphere painted with black mat spray paint. Air velocity was recorded using a digital anemometer (Pacer® Model DA40V), with a resolution of 0.01m/s. Data were collected every three hours, from 08:00 to 18:00h, when broilers were 4, 5, and 6 weeks. Based on the data collected at each time, wet bulb globe temperature (WBGT) and radiant heat load and a radiant heat load (RHL). Litter temperature was also measured using an infrared thermometer Raytec® in five different spots in each pen (two near the lateral pen wall, two near the central aisle, and at the geometrical center of the pen) every three hours, from 08:00 to 18:00 when broilers were 6 weeks of age. Based on the average data in each spot, isothermal maps of litter temperature using the kriging method of the SURFER software program were built. Internal thermal environmental parameters were evaluated as to the effects of flock, ventilation, litter, week, hour, and the interactions among the last four factors using mixed models for repeated measures and 19 variance and covariance matrix structures, applying PROC MIXED procedure of SAS statistical package [19], according to [20]. The structure used for analysis was chosen based on the lowest value of the Akaike Information Criterion (AIC). The estimation method was that of restricted maximum likelihood. The effect of hour was detailed using orthogonal polynomial analysis up to the polynomial of the third degree. For the external environment, parameter means were calculated as a function of hour and week in order to compare the internal with the external thermal environment. The soybean straw was chopped into approximately 3cm long particles. Litter was initially 10cm high and was reused for four consecutive flocks. Litter quality was evaluated in terms of physical-chemical composition, moisture, and compactness. The development of the population of darkling beetles and the evolution of the number of parasite eggs/oocysts was also observed. In order to evaluate darkling beetles population, three traps per pen made with 20 × 5cm PVC tubes filled with 20 × 50cm rolled-up corrugated cardboard, totaling 48 traps [21]. Traps were placed under the litter in three sites in each pen: at the center, between the external wall and the first line of feeders, and the other two between the feeders, equally distant from the drinkers. Traps remained in the pens for seven days and were removed after catching of each flock. Traps were then placed in 1L thick plastic bags, closed with thin plastic-coated wire, and submitted to the laboratory. *Alphitobius diaperinus* adults and larvae were identified and counted, and the total number of individuals was recorded. Litter samples were collected to count number of endoparasite eggs/oocysts per gram of litter (epg), and also submitted to physical-chemical analysis. Two samples were collected per flock: on the day chicks were housed and after catching. In each pen, 15 litter samples, weighing 50g each, were collected on the surface and under the surface of the litter centrally to the feeders, drinkers, and external and internal limits of the pens. In the laboratory, after homogenization, 50g aliquots were used for endoparasite counting. The remaining sample was submitted to the physical-chemical analyses lab to determine dry matter, ashes, and phosphorus contents. Phosphorus was colorimetrically determined by the molybdovanadate method [22]. Pre-dry matter or moisture was determined at 65°C. Copper,

zinc, calcium, manganese, and iron contents were determined by flame atomic absorption spectrometry after nitro-perchloric digestion [23]. Nitrogen was determined by the Kjeldahl method. Litter pH was measured according to the method described by [24]. Organic carbon was titered after chemical oxidation with sulfochromic solution [25]. Potassium was determined by flame photometry [24]. Litter temperature was recorded using an infrared thermometer (Raytec®) in five different spots in each pen (two near the lateral pen wall, two near the central aisle, and at the geometrical center of the pen). Darkling beetle counts were transformed into  $\log(y+1)$  and submitted to analysis of variance using a model that considered the effects of litter material, ventilation, flock, and the interaction among these factors. The GLM procedures of SAS statistical package were used [19]. Parasite egg and oocyst counts were used to characterize the presence or absence of parasite in the pens. Parasite presence was analyzed by logistic regression considering the effects of litter material, ventilation and flock, using LOGISTIC procedures of SAS statistical package [19]. Litter quality data were analyzed by mixed models for repeated measures, considering the effects of litter material, ventilation, and the interaction between litter material and ventilation (plot), sample sampling and respective interactions (subplot, and period (subplot), and three matrix structures of variance and covariance, using the PROC MIXED procedure of SAS statistical package [19], according to [20]. The structure used for analysis was chosen based on the lowest value of the Akaike Information Criterion (AIC). The estimation method was that of restricted maximum likelihood.

## **2.1. Evaluation poultry production using different ventilation systems and litter material: I – general performance**

According to statistical analysis results, flock, litter, and age significantly ( $p < 0.05$ ) influenced all evaluated parameters, whereas ventilation system had no effect on any variable. Two interactions significantly affected almost all parameters: litter  $\times$  age and flock  $\times$  ventilation  $\times$  age. The details of the litter  $\times$  age interactions indicated better results for rice husks litter as compared to soybean straw litter in all studied parameters at all ages (Table 1). These results are similar to those described by Mizubuti et al. (1994), who evaluated rice husks, guinea grass, and napier grass as litter material. On the other hand, opposite results were obtained by [27, 5, 27, 28, 9, 8, 10], who tested different broiler litter materials and did not find any differences in body weight or feed intake. Moreover, [29] studied five broiler litter materials and observed significant reduction of body weight, feed intake, and antibody titers in broilers reared on rice husks litter. [30] compared the use of rice husks, coconut hulls, and wood shavings as broiler litter material and low- and high-density diets, and concluded that weight gain and feed intake during the total experimental period were higher in broilers reared on coconut hulls litter. The evaluation of the details of the triple interaction among flock, ventilation and age indicated that there was no consistent effect of ventilation system on performance parameters. The analysis of the presence of foot-pad lesion showed a significant influence ( $p < 0.0001$ ) of the interaction between flock and litter and of the main effects litter and flock. Independently from the interaction, soybean straw litter caused higher incidence of foot-pad lesions as compared to rice husks, in all flocks (Figure 2).

Litter material	Bird age (days)		
	21	35	42
	Feed intake (g)		
Rice husks	1196 ± 3.90a	3373 ± 8.88a	4764 ± 13.15a
Soybean straw	1179 ± 3.90b	3310 ± 8.88b	4692 ± 13.15b
	Feed conversion ratio		
Rice husks	1.278 ± 0.004a	1.529 ± 0.003a	1.666 ± 0.004a
Soybean straw	1.306 ± 0.004b	1.543 ± 0.003b	1.683 ± 0.004b
	Weight gain (g)		
Rice husks	894 ± 3.75a	2164 ± 6.05a	2819 ± 9.44a
Soybean straw	861 ± 3.75b	2104 ± 6.05b	2749 ± 9.44b
	Body weight (g)		
Rice husks	937 ± 3.76a	2207 ± 6.05a	2862 ± 9.45a
Soybean straw	903 ± 3.76b	2146 ± 6.05b	2791 ± 9.45b

Means followed by different letters in the same columns are different ( $p < 0.05$ ) by the F test.

**Table 1.** Feed intake, feed conversion ratio, weight gain and body weight of broiler reared on two different litter materials and two different ventilation systems

These results are opposite to those found in other studies evaluating litter materials that concluded that litter material has not effect on carcass lesions [31]. The obtained results indicate that litter material causes foot-pad lesions, resulting in carcass condemnation in the processing plant and consequent economic losses. [1] also found higher incidence of foot-pad lesions when napier grass and coast-cross grass hays were used as litter material. However, [7] used sunflower crop residue and *Brachiaria* hay as litter, but did not find any effects on breast, hock, and foot-pad lesions. In the present study, it was also observed that the percentage of foot-pad lesions markedly increased from the first to the second flock, decreased in the third flock, and that this reduction was maintained in the fourth flock. We believe that, as the number of flocks increased, caked litter was removed and the remaining litter was turned, making litter softer, and thereby, reducing leg lesions. Mortality was influenced by flock ( $p < 0.0001$ ) and by the interaction between flock and litter ( $p < 0.05$ ). However, mortality was only significantly affected by litter material in the third flock in favor of soybean straw. Evaluating the use of wood shavings, rice husks, sugarcane residue and carnau-ba palm residue as broiler litter material, [32] did not find any differences in mortality, although in absolute numbers, values were higher in broilers reared on wood shavings and sugarcane residue. [5] and [29] reported similar results, that is, no mortality differences in studies on alternative broiler litter materials. According to [33], bacteria present in the litter may have different effects. Many Gram-positive bacteria, such as lactobacilli and bifidobacteria, are present in broiler excreta and in the litter, but are not necessarily related to prob-

lems. On the other hand, the frequent presence of pathogens in the litter, particularly of enterobacteria and zoonotic bacteria in general, is a reason of concern due to possible diseases transmitted both to the broiler flock itself and to consumers.

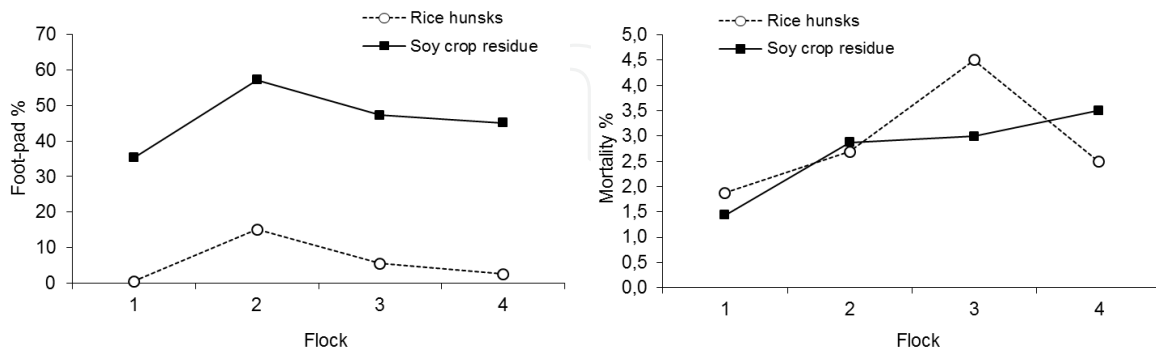

**Figure 2.** Presence of foot-pad lesions and mortality rate of broilers reared on two different litter materials for four consecutive flocks

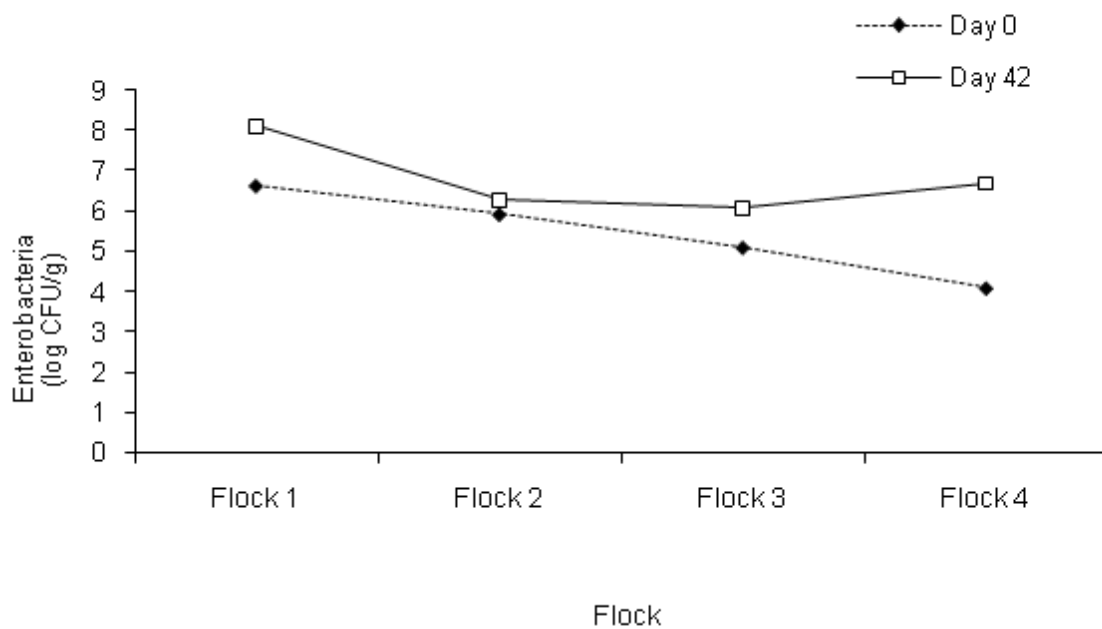
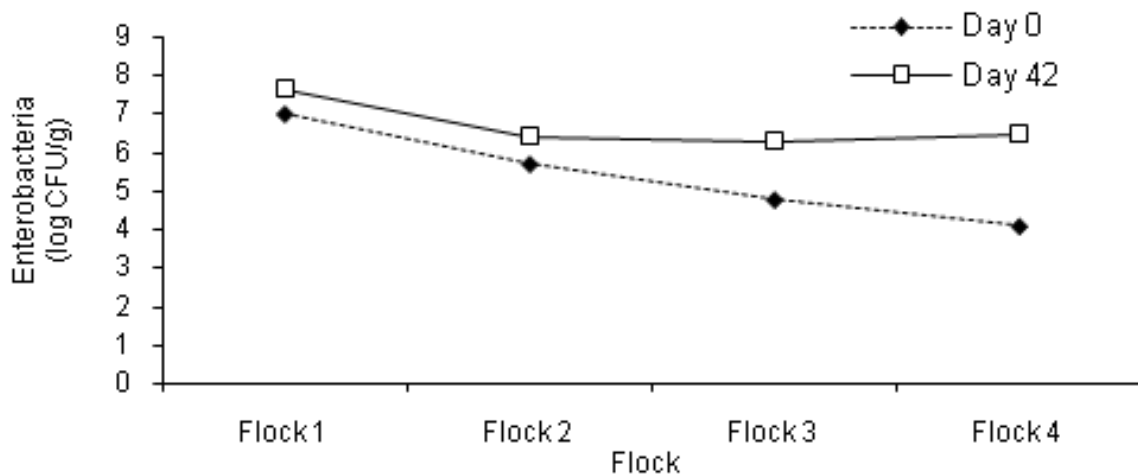

**Figure 3.** Enterobacteria (log CFU/g) in rice husks litter reused for four broiler flocks (flock housing and removal – Days 0 and 42)

Moreover, according to [33], the composition of the bacterial population in the litter is usually very similar to the composition of the physiological microbiota of the ileum of broilers,



and consists approximately of 70% lactobacilli, 11% *Clostridium* spp., 6.5% *Streptococcus* spp., and 6.5% *Enterococcus* spp. The litter presents, in average, 10 times less bacteria than the digesta, but this is still a high concentration of microorganisms. The digest contains between  $10^8$  and  $10^{10}$  of Gram-positive bacteria and  $10^6$  to  $10^7$  Gram-negative bacteria per gram. As the concentration of bacteria in the litter can increase 10 times per reared flock, it may achieve the same levels as the digesta. From the practical perspective, it may be assumed that bacterial concentration in the litter of broilers is similar to that in feces. In the present study, total enterobacteria counts (expressed as colony-forming units, CFU) per gram of litter for each treatment were carried out when each of the four flocks was removed (day 42) and when the following flocks were housed (day 0), aiming at evaluating the effect of downtime on litter bacterial load. Significant effects ( $p < 0.05$ ) of flock, evaluation day (0 or 42), and their interaction was observed, whereas litter material (rice husks or soybean straw) and ventilation system had no influence on litter enterobacterial load (Figures 3 and 4). The evaluation carried out on day 42 always presented better results as compared to that performed on day 0, as expected. However, the difference increased as the number of flocks increased (Figure 5), as shown by the lowest UFC count on day 42 (immediately after flock removal) in the third flock, whereas on day 0 (day of housing, after downtime), bacterial load the lowest only in the fourth flock. This suggests that the reduction of the load of enterobacteria after downtime (day 0), may continue to occur in subsequent flocks, as the reduction was linear and did not achieve a stabilization point.



**Figure 4.** Enterobacteria (log CFU/g) in soybean straw litter reused for four broiler flocks (flock housing and removal – Days 0 and 42)

It must be mentioned that, during downtime, flame-gun was used twice on the litter: immediately after bird removal and before the following flock was housed. However, during the 15-d

downtime, litter was not submitted to any management practice for the reduction or control of undesirable bacteria, including potentially pathogenic bacteria. Despite the reduction in the bacterial load along the four flocks, enterobacteria counts were high in all flocks, and therefore some method of litter treatment during downtime is recommended to reduce pathogen load. The initial enterobacteria counts in the litters used in the experiment before the first flocks were housed were considered high. When evaluating litter treatment methods for bacterial load reduction, [18] observed that average loads of enterobacteria and total mesophiles were high in new litters. According to those authors, these results call the attention to the quality of new litter, as high bacterial loads in that material are associated to their origin, possibly due to production, preservation, storage, and transport conditions to the broiler house. In addition, these high bacterial loads are a hazard to birds that will be housed in that environment, particularly considering that these will be day-old chicks. [34] determined bacterial levels in pine shavings and sand used as broiler litter, and found a marked increase in bacterial counts after birds were housed. Pine shavings reached a level of  $10_8$  CFU/g of aerobic bacteria in the second week, and this level remained stable up to six weeks, after which it increased approximately 1 log the next week, and remained at this level until birds were removed at the seventh week. Enteric bacteria in pine shavings reach a plateau at  $10_7$  to  $10_8$  CFU/g in the second week, and these values showed little variation until the seventh week. In the present study, enterobacteria counts were higher, in general, than those obtained in untreated wood shavings litter by [18], which were about  $10_5$  CFU/g. Therefore, the need to treat the litter during downtime is stressed, independently of the material used.

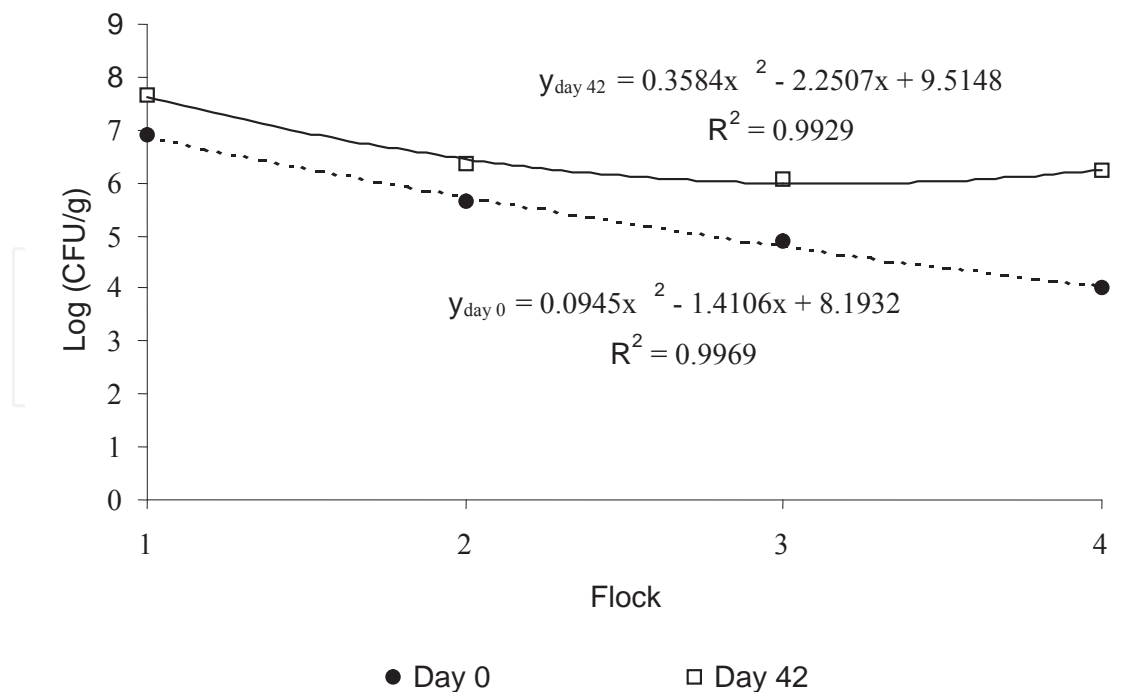

**Figure 5.** Enterobacteria load on days 0 and 42 of the evaluated flocks, considering all treatments

## 2.2. Poultry production using different ventilation systems and litter materials: II – thermal comfort

The main effects of flock, week and hour were significant ( $p < 0.05$ ) for all evaluated parameters. Litter material significantly influenced ( $p < 0.05$ ) only air relative humidity, whereas ventilation system did not affect any of the parameters. The hour  $\times$  week interaction significantly affected all parameters, whereas the effect of the ventilation  $\times$  hour interaction was significant only for air temperature and WBGT. Heat load inside the broiler house did not show much variation, and the results were more favorable to the birds as compared to the external environment. When rice husks litter was used, higher air relative humidity values were detected (Figure 6). According to [35] optimal air temperature values are between 23°C and 26°C; 20°C and 23°C; and 20°C for 4-, 5-, and 5-week-old broilers, respectively. On the other hand, the recommended air relative humidity is 60 to 70%, regardless bird age. In the present study, air relative humidity remained higher than the recommendations for broiler production in all studied weeks, times, and litter materials (Figure 6). Controlling air and litter humidity is important to reduce pathogens, ammonia, and parasite, such as coccidia, in the poultry house environment [36]. [37] did not find significant differences in breast blisters as a function of bird density (10 birds/m<sup>2</sup> or 14 birds/m<sup>2</sup>), litter material (wood shavings or saw dust) or by their interaction, as this part of the broiler body is not in permanent contact with the litter, and therefore is not influenced by litter humidity. Litter temperature presented the same behavior as air temperature, as expected, with a linear correlation of 0.95. At all evaluated times, litter temperature was, in average, 2°C to 3°C higher than air temperature. It must be noted that litter temperature was not affected by the used material, that is, independently of using soybean straw or rice husks, litter temperature remained similar (Figure 6). According to [38], temperature measured 5cm below litter surface was 23.5°C and 31.3°C at housing densities of 19 and 40 kg/m<sup>2</sup>, respectively, whereas air temperature 1m above litter surface was 22°C, indicating that litter temperatures were 1.5°C and 9.3°C higher than the environmental temperature. The higher litter temperature at higher bird densities may be explained by different effects. As bird density increases, nitrogen and humidity levels increase in the litter, allowing higher microbial activity and the heat transference from the litter surface to the environmental air is prevented when the litter surface area is covered by birds, particularly as birds reach market weight.

## 2.3. Poultry production using different ventilation systems and litter materials: III – effect of litter reuse on the populations of *Alphitobius diaperinus* and intestinal parasites

Considering the composition of rice husks and soybean straws before its utilization and the values established in [39] for simple organic fertilizers (Table 2), both materials are very different, except for organic carbon content, and do not comply with the recommendations of IN-23 for organic fertilizers. Rice husks humidity and pH values are different from those described by [40], who evaluated the reutilization of rice husks as litter material by 18 broiler flocks and reported 9.4% humidity, pH 7.0, 0.47% nitrogen, 0.03% phosphorus, and 0.27% potassium in the beginning of the experiment, that is, composition before utilization. According to [10], considering that plant nutrient requirements vary as a function of cultivar, soil, expected yield,

etc., and exceeding supplied quantities remain in the soil and are susceptible to leaching and percolation, it is essential to balance soil and litter compositions. Based on these considerations, the knowledge on the quality (physical-chemical composition, compactness, and reutilization) of litter materials used as alternative to wood shavings is essential as the disposal of such material is part of good production practices. Litter quality was evaluated according to chemical element levels and physical parameters. Litter chemical composition parameters were significantly affected ( $p < 0.05$ ) by litter material, except for humidity and zinc. Sampling affected only ashes and potassium content, whereas period significantly influenced ( $p < 0.05$ ) all parameters. The interaction litter material  $\times$  period  $\times$  sampling affected organic carbon, copper, iron, potassium, pH and zinc. In order to study litter chemical composition, samplings were performed in three different periods, as follows: period 1 – 15-day interval (downtime) between removal of flock 1 and housing of flock 2; period 2 - 15-day interval (downtime) between removal of flock 2 and housing of flock 3; and period 3 - 15-day interval (downtime) between removal of flock 3 and housing of flock 4.

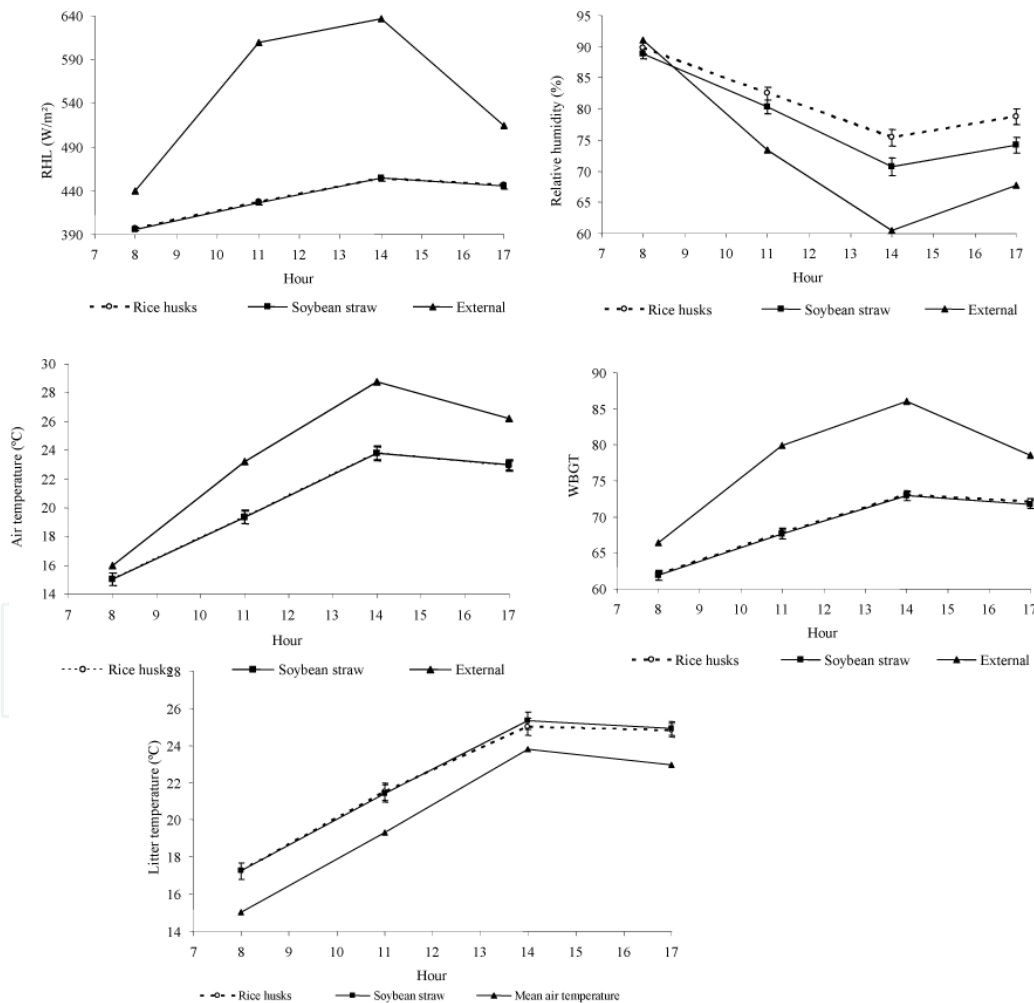

**Figure 6.** Air temperature, wet bulb globe temperature (WBGT), radiant heat load (RHL), air relative humidity and litter temperature inside broiler houses with two different litter materials

	Rice husks	Soybean straw	IN-23
Ashes (%)	15.18	4.33	
Organic carbon (%)	35.13	33.33	≥ 20
Copper (%)	traces	0.00065	
Iron (mg/kg)	433.25	607.63	
Potassium (%)	0.075	0.108	
Manganese (mg/kg)	169.85	32.75	
Humidity (%)	10.35	14.33	≤ 30
Nitrogen (%)	0.344	0.662	≥ 1
Phosphorus (%)	0.056	0.092	
pH	6.56	7.60	a.d.*
Zinc (mg/kg)	11.43	14.70	

\* c.d. – as declared.

**Table 2.** Chemical composition of rice husks and soybean straw before their utilization as litter and values established in Normative Instruction n. 23

The chemical composition of rice husks and soybean straw after utilization (Table 3) indicates a differentiation pattern of chemical element values. In general, values were high after the removal of flock, and decreased after 15 days of downtime in all studied periods. An exception was pH, which was higher at the end of downtime. Humidity values at flock removal were high, exceeding the recommendations both for poultry rearing and for organic fertilizer; however, at the end of downtime, values returned to acceptable levels. [40] observed that the moisture of rice husks litter varied between 23.4 and 29.1%, averaging 26.4%. Those authors found that litter pH increased from 7.05 to 8.59 after the first flock, and significantly increased between the first and the second flock, after which only minor changes were observed, with an average litter pH of 8.80 after 18 flocks. Similar pH values were obtained by [41] for rice husks litter reused by four flocks (pH 8.75); by [42], with pH values of 8.4-8.5; and by [10], with an average pH of 8.79. For soybean straw, [10] obtained an average pH of 8.97. Ammonia and nitrates are the most common chemical forms of nitrogen found in poultry waste. Nitrates can significantly contaminate underground waters when excessive levels of broiler litter as used as crop fertilizer [43]. Moreover, according to that author, phosphorus is found in large amounts in poultry excreta, and its excessive application for crop fertilization may exceed soil and plant capacity to use that nutrient, resulting in leaching and subsequent contamination of underground waters. [10] studied six different litter materials reused for six consecutive flocks and found nitrogen values of 2.46 and 2.63 and 0.84 and 1.00 of phosphorus in rice husks and soybean straw, respectively. [40] showed that nitrogen, phosphorus, and potassium contents significantly increased in the first seven to eight flocks. Nitrogen, phosphorus, and potassium values obtained in the litter of the fourth flock of the study of [40] were 3.56, 1.59, and 3.12%, respectively, and are used for the comparison with those obtained in the present study.

Period	Rice husks		Soybean straw	
	Removal	Housing	Removal	Housing
<b>Ashes (%DM)</b>				
1	20.86 ± 0.78	-	15.71 ± 0.35	-
2	20.84 ± 0.17 aA	21.13 ± 0.23 aA	17.29 ± 0.32 bA	17.04 ± 0.35 bA
3	21.40 ± 0.20 aA	21.77 ± 0.12 aA	18.95 ± 0.29 bA	18.39 ± 0.30 bA
<b>Organic carbon (%DM)</b>				
1	32.93 ± 0.32 bB	36.43 ± 0.24 bA	36.08 ± 0.43 aB	38.69 ± 0.33 aA
2	32.72 ± 0.45 bA	34.95 ± 1.53 aA	35.92 ± 0.28 aA	32.02 ± 0.64 bB
3	32.14 ± 1.41	-	28.45 ± 0.66	-
<b>Copper (%DM)</b>				
1	45.19 ± 0.84 bA	39.33 ± 1.33 bB	63.31 ± 1.26 aA	49.44 ± 1.64 aB
2	56.05 ± 1.09 bA	52.99 ± 1.65 bB	67.55 ± 0.91 aA	62.72 ± 1.20 aB
3	63.27 ± 1.34 bA	59.13 ± 0.98 bB	74.75 ± 1.22 aA	73.03 ± 1.43 aA
<b>Iron (mg/kg - DM)</b>				
1	911 ± 26 bA	608 ± 29 bB	1492 ± 57 aA	1469 ± 117 aA
2	1014 ± 28 bA	738 ± 16 bB	1452 ± 44 aA	1361 ± 59 aA
3	1035 ± 21 bA	507 ± 18 bB	1364 ± 49 aA	736 ± 44 aB
<b>Potassium (%DM)</b>				
1	2.04 ± 0.05 bA	1.97 ± 0.05 bA	2.78 ± 0.05 aA	2.73 ± 0.05 aA
2	2.35 ± 0.04 bA	2.00 ± 0.06 bB	2.81 ± 0.04 aA	2.78 ± 0.04 aA
3	2.16 ± 0.05 bB	2.57 ± 0.08 aA	2.69 ± 0.07 aA	2.62 ± 0.03 aA
<b>Manganese (mg/kg - DM)</b>				
1	351 ± 8 aA	356 ± 7 aA	311 ± 6 bA	252 ± 12 bB
2	427 ± 9 aB	448 ± 9 aA	386 ± 6 bA	375 ± 12 bA
3	420 ± 8 aA	421 ± 7 aA	404 ± 7 aA	383 ± 8 bB
<b>Nitrogen (%DM)</b>				
1	2.31 ± 0.09 bA	1.77 ± 0.05 bB	2.92 ± 0.02 aA	2.30 ± 0.06 aB
2	2.67 ± 0.04 bA	2.32 ± 0.02 bB	3.26 ± 0.04 aA	2.83 ± 0.03 aB
3	2.90 ± 0.07 bA	2.44 ± 0.03 bB	3.32 ± 0.04 aA	2.88 ± 0.05 aB
<b>pH</b>				
1	8.59 ± 0.08 aB	9.20 ± 0.01 bA	8.39 ± 0.09 aB	9.35 ± 0.02 aA
2	8.39 ± 0.04 bA	8.98 ± 0.02 bA	8.68 ± 0.05 aB	9.11 ± 0.03 aA
3	8.54 ± 0.06 aB	8.86 ± 0.01 bA	8.71 ± 0.04 aB	8.97 ± 0.02 aA
<b>Phosphorus (%DM)</b>				
1	1.38 ± 0.07 aA	0.88 ± 0.05 aB	1.54 ± 0.07 aA	1.06 ± 0.07 aB
2	1.65 ± 0.07 bA	1.43 ± 0.07 bB	1.91 ± 0.10 aA	1.66 ± 0.04 aB
3	1.43 ± 0.05 aA	1.35 ± 0.06 bA	1.46 ± 0.09 aA	1.54 ± 0.08 aA
<b>Humidity (%)</b>				
1	42.71 ± 3.22 aA	25.56 ± 1.31 aB	44.09 ± 1.01 aA	27.38 ± 0.94 aB
2	31.12 ± 1.01 aA	16.51 ± 0.50 bB	33.85 ± 0.98 aA	19.94 ± 0.49 aB
3	33.44 ± 0.79 aA	16.55 ± 0.21 bB	35.35 ± 0.93 aA	18.62 ± 0.22 aB
<b>Zinc (mg/kg DM)</b>				
1	227 ± 19 bA	145 ± 15 aB	286 ± 12 aA	80.57 ± 9.87 bB
2	266 ± 5 aA	254 ± 21 aA	285 ± 6 aA	254 ± 14 aA
3	266 ± 5 bA	141 ± 2 bB	299 ± 7 aA	158 ± 5 aB

Means followed by different small letters in the same row are different, within sampling, ( $p < 0.05$ ) by the F test.

**Table 3.** Chemical composition of broiler litter made of rice husks or soybean straw

There is little information on copper (Cu), iron (Fe), zinc (Zn), and manganese (Mn) levels in different poultry litter materials. According to [43], poultry feeds are rich in iron, and high levels of this mineral are commonly found in broiler litter. Excessive levels of those mineral in the soil affect plant root growth. That author presented a table with findings of several authors relative to the levels of those trace minerals in poultry litter, and those values (in mg/kg, dry weight) are used to compare with the results of the present study. That table presents average concentrations and ranges of 77 and 58-100 for copper, 1,625 and 1,026-2,288 for iron, 348 and 125-667 for manganese, and finally 315 and 106-669 for zinc. It must also be mentioned that the chemical characteristics of the litter materials after three flocks comply, in terms of their nutritional aspects, with the legislation relative to simple organic fertilizer. However, it is recommended that the litter removed from the poultry house is distributed in rows for an additional composting period in order to eliminate or reduce health risks. Despite the effect of litter material on the evaluated parameters, with higher averages promoted by soybean straw, litter made of these crop residues were similar and presented similar characteristics to those described in literature for wood shavings [44], showing that after three flocks, both materials presented excellent fertilizing characteristics. Relative to the physical aspects, when the first flock was removed, soybean straw litter was more compacted and caked as compared to rice husks litter, and this condition remained for the following three flocks, requiring labor interference to break the caked parts, including during the rearing period. At flock removal, soybean straw required more labor to allow its reuse due to the formation of a caked layer on the top of the litter. When the fourth and last flock was removed, the litter made with soybean straw had reached its maximum limit of reutilization, with decomposition of the lower layer, presenting fiber breakdown and humic matter formation. Rice husks litter, on the other hand, presented reuse conditions after the removal of the fourth flock. [45] recommended monitoring insect populations in poultry housed as a routine procedure of the management program, independently from the strategy used for insect control. However, according to [46], it is difficult to carry out darkling beetle population studies because their population is usually very high in poultry houses, and they have cryptic behavior. In the present study, one of the objectives was to know which litter material was more favorable to the dissemination of darkling beetles, as well as the evolution of this population as the litter was reused by several consecutive flocks. Darkling beetle count was significantly influenced ( $p < 0.05$ ) by litter material, flock, and the interactions between litter material and ventilation and between litter material and flock. Rice husks presented lower darkling beetle count ( $p < 0.05$ ) as compared to soybean straw, with oscillating ventilation in all flocks, and after the second flock, with stationary ventilation (Figure 7). Darkling beetle count increased from the first to the third flock, and decreased in the fourth flock, independently of litter material or ventilation. [47], studying darkling beetle distribution and population dynamics, observed that in broiler houses with cement floor covered with wood shavings litter reused for four flocks and equipped with automatic feeders the average numbers of insects trapped in the first flock were 385.4 larvae and 24.5 adults, and these figures increased to 615.3 larvae and 208.7 adults in the next flock. Those authors found that the population tended to become stable in the third flock (651.3 larvae and 248 adults), and found an apparent reduction to 422 larvae and 160.2 adults per trap in

the fourth flock. They also found that average litter temperature in flock 1 was 30.7°C, which favors the multiplication of saprophyte microorganisms. Air and litter temperatures directly influence the population of darkling beetles [48]: temperatures of 22 and 31°C determine incubation periods of 8.9 and 3 days, respectively. Below 17°C, eggs do not hatch. The larval stage can take 70.1 days when environmental temperature is 22°C or 33.2 days at 28°C, whereas the pupa stage takes 4 days at 31°C and 9.7 days at 22°C. Therefore, according to those authors, the complete life cycle of the darkling beetle at a constant temperature of 28°C is 42.5 days, and considering that a new flock is housed every 50 days, a new generation of darkling beetles may occur at each flock housed in the farm.

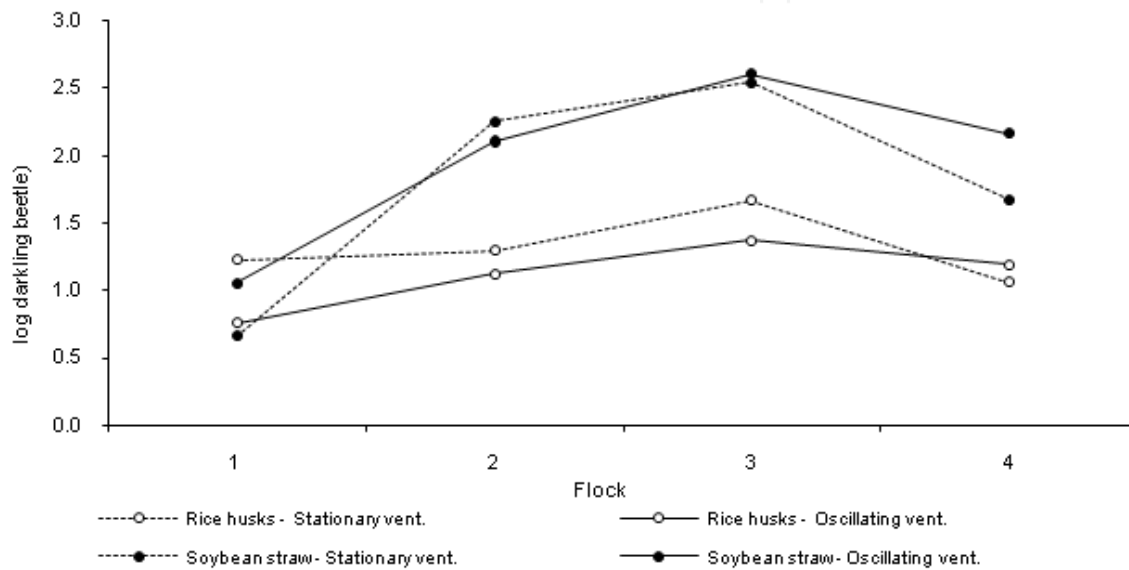

**Figure 7.** Average darkling beetle counts, transformed into  $\log(y+1)$ , in the litter of broilers reared on two different litter materials and under two ventilation systems.

In the present study, average air and litter temperatures were mild (Table 5), but nevertheless allowed the multiplication of darkling beetles. When the presence of parasites was investigated, only *Eimeria sp.* oocysts were identified, and significant effects ( $p < 0.05$ ) of litter material and of the interaction between litter material and ventilation on the presence of oocysts were determined. Rice husks submitted to oscillating ventilation presented the higher percentage of contaminated pens and 18.78 more chances of being contaminated as compared to soybean straw submitted to the same ventilation (Table 4). When ventilation was stationary, no differences between litter materials were observed. When comparing ventilation types, it was found that rice husks litter contamination was significantly higher when ventilation was oscillating (odds ratio = 7.22), whereas there was no significant influence of ( $p > 0.05$ ) ventilation type on the contamination of soybean straw by *Eimeria spp.* Other factors may have influenced litter contamination, such as the higher nutrient levels – particularly nitrogen levels – in soybean straw, explaining the lower oocyst count due to the negative effects of the release of ammonia levels that are lethal to oocysts [49]. As optimal *Eimeria spp.* oocyst sporulation, which makes it infective, occurs at temperatures of 28 to



30°C [49], data were tested to verify if oocyst counts could have changed with litter temperature variations (Table 5), but the results showed that litter temperature did not have any significant influence on oocyst counts.

Litter material	Ventilation		Odds ratio	P"/> $\chi^2$
	Oscillating	Stationary		
Rice husks	81.3%	37.5%	7.22	0.0163
Soybean straw	18.8%	31.3%	0.50	0.4182
Odds ratio	18.78	1.32		
P"/> $\chi^2$	0.0012	0.7100		

**Table 4.** Percentage of pens contaminated with *Eimeria spp* and odds ratio (probability) of being contaminated

Hour	Week			
	4	5	6	Média
<b>Air temperature (°C)</b>				
8:00	16.15 ± 0.45	13.03 ± 0.47	15.93 ± 0.59	15.04 ± 0.30
11:00	19.86 ± 0.48	17.08 ± 0.51	21.10 ± 0.63	19.34 ± 0.33
14:00	24.30 ± 0.49	21.14 ± 0.52	25.93 ± 0.65	23.79 ± 0.33
17:00	23.23 ± 0.39	20.64 ± 0.41	24.97 ± 0.52	22.95 ± 0.27
<b>Litter temperature (°C)</b>				
8:00	17.12 ± 0.36	14.86 ± 0.50	19.77 ± 0.51	17.25 ± 0.27
11:00	20.87 ± 0.38	19.39 ± 0.53	24.12 ± 0.54	21.46 ± 0.28
14:00	24.35 ± 0.37	23.48 ± 0.51	27.71 ± 0.52	25.18 ± 0.27
17:00	24.20 ± 0.27	22.84 ± 0.38	27.53 ± 0.38	24.86 ± 0.20

Means followed by different letters in the same column are different ( $p \leq 0.05$ ) by the F test.

**Table 5.** Means and standard error of the parameters air temperature (°C) and litter temperature (°C) as a function of measurement week and time

According to [43], poultry production generates nutrient-rich residues that can be utilized to generate energy or to fertilize crops; however, their application to the soil must follow nutrient management plans in order to prevent environmental impacts. Considering the composition of rice husks and soybean straws before its utilization and the values established in Normative Instruction n. 23 for simple organic fertilizers, both materials are very different, except for organic carbon content, and do not comply with the recommendations of IN-23 for organic fertilizers. According to [10], considering that plant nutrient requirements vary

as a function of cultivar, soil, expected yield, etc., and exceeding supplied quantities remain in the soil and are susceptible to leaching and percolation, it is essential to balance soil and litter compositions. Based on these considerations, the knowledge on the quality (physical-chemical composition, compactness, and reutilization) of litter materials used as alternative to wood shavings is essential as the disposal of such material is part of good production practices. It must also be mentioned that the chemical characteristics of the litter materials after three flocks comply, in terms of their nutritional aspects, with the legislation relative to simple organic fertilizer. However, it is recommended that the litter removed from the poultry house is distributed in rows for an additional composting period in order to eliminate or reduce health risks. Despite the effect of litter material on the evaluated parameters, with higher averages promoted by soybean straw, litter made of these crop residues were similar and presented similar characteristics to those described in literature for wood shavings [44], showing that after three flocks, both materials presented excellent fertilizing characteristics. Relative to the physical aspects, when the first flock was removed, soybean straw litter was more compacted and caked as compared to rice husks litter, and this condition remained for the following three flocks, requiring labor interference to break the caked parts, including during the rearing period. At flock removal, soybean straw required more labor to allow its reuse due to the formation of a caked layer on the top of the litter. When the fourth and last flock was removed, the litter made with soybean straw had reached its maximum limit of reutilization, with decomposition of the lower layer, presenting fiber breakdown and humic matter formation. Rice husks litter, on the other hand, presented reuse conditions after the removal of the fourth flock.

---

*At the same time also the same comparison was made using the two materials as substrate for the composting of broiler carcasses.*

---

#### **2.4. Rice husks and soy straw as substrate for composting of broiler carcasses.**

Considering the possibility of using rice husk and soybean straw as litter, the present study aimed to evaluate these products as substrates for broiler carcasses composting. The appropriate destination of waste from poultry production is a challenge for producers. Carcasses of broilers dead during the rearing period need to be managed so as not to cause problems like unpleasant odors and attraction of flies. One alternative for destination of carcasses considered economically and environmentally acceptable is the composting [50], a natural process of organic matter decay performed by bacteria and fungi that turn the carcasses into a useful product, the compost.

The experiment was conducted in the Experimental Field of Suruvi, of Embrapa Swine and Poultry, in Concórdia (Santa Catarina State) using a composter with six cameras, with internal measures: 0.80 m wide, 1.20 m depth and 1.50 m height of the wall. Cameras were constructed with concrete floor, wooden walls, and asbestos tiles. Two types of substrate were tested for composting: soybean straw (T1) and rice husk (T2). The experiment started with new substrates, which were reused in the composting, accompanying four flocks of broilers. Three repetitions of each treatment for each composting period were randomly selected. By

the end of each flocks, each camera received 10 newly slaughtered broilers adding up a total of 60 animals per flocks. The total of 10 broilers was weighed, calculating the amount of water to be added, equal to 30% of broilers weight. The composting pile was arranged on a 30 cm-layer of new substrate, placing at the beginning 5 carcasses in a same layer, and the other 5 in a second layer, covered by a new 20 cm-layer of the same substrate. After a composting period of 15 days, pile was tumbled carcasses and substrates were weighed separately, piles were rearranged and water was added in amount corresponding to 30% of carcasses weight. All the process was performed using equipment for individual protection (rubber gloves, dust mask, boots, hat and overalls). An electronic scale with capacity of 100 kg (Toledo 2124-C5) has weighed substrates and carcasses. Carcasses were placed into thick plastic bags (20 kg) and substrates into raffia bags (60 kg). For the substrate removal, it was used a rounded tip cupped shovel and a watering can to add water. The removal of carcasses waste was made with a garden spade and a polyethylene broom. Thermocouples (S. E. Test tools A20) were installed to monitor the temperature of the composting pile, with readers inserted into each camera, in the central portion of the pile, with reading at three points (top, middle and bottom) and record of data at 7, 15, 22 and 30 days after mounting the pile. On the 30<sup>th</sup> day after the start of composting, the second weighing of carcasses and substrate was performed separately, being mounted a new pile with the same substrate and the remaining waste was divided into two layers, allowing the composting for more 15 days. The procedure was repeated for four periods, reusing the same substrate, forming from the second period, three layers of carcasses, being the bottom made up by the remaining waste of the previous batch, and the other two with five newly slaughtered broilers each. By the end of 30 days of composting, samples were collected from each camera, at nine points per layers (subsamples) and taken a pool of these points at 5 layers per camera (totaling 30 samples per batch) for analyses. It was analyzed the content of dry matter, ash, phosphorus, Cu; Zn; Mn; Fe, Nitrogen, pH; Calcium and Magnesium. For the analysis of the organic carbon, with the homogenization of part of five samples of layers of each camera, it was formed a new sample for each camera, totaling six samples per period, being the analysis performed by the titration method after chemical oxidation with sulfochromic solution [25]. The variable "Carcass decomposition" was obtained by the ratio between the difference of the initial and final weight, divided by the initial weight multiplied by 100. The variable "Substrate decomposition" was obtained by the ratio between the difference of the initial and final weight of the substrate. These data were examined by an analysis of variance for the model considering the effect of the composting cycle, substrate and the interaction, using the procedure GLM of SAS [19]. Data of composting temperature were analyzed using the mixed model theory for repeated measures, considering the effects of the composting cycle, substrate, composting week and interaction of these latter two variables and 16 types of structures of matrices of variance and covariance, using the PROC MIXED of SAS [19]. The structure employed in the analysis was chosen based on the Akaike's Information Criterion (AIC). The estimation method used was the restricted maximum likelihood.

The analysis of variance for the percentage of decomposition of carcasses and substrates, a significant effect ( $p < 0.05$ ) was detected for the interaction between period and substrate for the variable "carcass decomposition", whereas for the "substrate decomposition", a signifi-

cant effect was observed only for the period. The Table 6 presents the mean values and standard errors of the % of decomposition of carcasses and substrates according to the type of substrate and period. A significant effect ( $p < 0.05$ ) was observed for the carcass decomposition on the 4<sup>th</sup> period in relation to the substrate type, being the soybean straw the substrate with the highest value. The variable “substrate decomposition” had values above 100 because it was added to the substrate part of the decomposed carcasses besides the addition of water and the natural process of formation of humic matter, characterized by being a complex of several elements [51] which works in the supply of nutrients to the plants, on the structure and compatibility of the soil and water retention capacity [52]. Nevertheless, the change in the shape and color of substrate particles indicate the decomposition of the substrate. The Figure 8 shows the mean profile of composting temperature according to substrates. No significant effect was observed for the interaction between week and treatment, but a significant effect ( $p < 0.05$ ) of the week and treatment separately. The rice husk maintained higher temperatures than the soybean straw, and in both substrates there was an increase of temperature with the tumbling of the pile from the 2<sup>nd</sup> to the 3<sup>rd</sup> week.

Substrate	Period			
	1	2	3	4
<b>Carcass Decomposition (%)</b>				
Rice husk	64.29 ± 1.90 a	65.25 ± 1.90a	60.18 ± 1.90 a	55.76 ± 1.90 b
Soybean straw	63.74 ± 1.90a	59.79 ± 1.90a	64.47 ± 1.90 a	62.70 ± 1.90a
<b>Substrate Decomposition (%)</b>				
Rice husk		106.79 ± 3.73	96.17 ± 3.73	102.79 ± 3.73
Soybean straw		104.97 ± 3.73	91.54 ± 3.73	100.90 ± 3.73

Means followed by different letters in the columns are significantly different by the F-test ( $p \leq 0.05$ )

**Table 6.** Mean values and standard errors of the % of decomposition of carcasses and substrates according to the type of substrate and period.

Nevertheless, the absolute maximum temperature registered inside the piles was higher in the camera with soybean straw, reaching 73.3°C, while the absolute maximum of the camera with rice husk reached 65.9°C. Both were close to the temperatures reported by [53] for composted mass on the fifth day after mounting the piles (57 - 71°C). [54] in the composting experiment with agroindustrial waste have obtained temperatures within the range of 40 - 60°C, with some peaks, with the highest temperature at 71°C. Biologically, the operating limits for the temperature can be classified as: > 55°C to maximize the sanitation; 45 - 55°C to maximize the biodegradation rate; and between 35 - 45°C to maxi-

mize the microbial diversity [55]. In this study, temperatures remained between 35 – 45°C, but as abovementioned, there were temperature peaks above 55°C promoting the sanitization of the composting mass. In the first week it was also found values indicative of the maximization of the degradation rate. [56] in a composting study using different stations obtained temperatures higher than 55°C for over 3 consecutive days, achieving the maximum reduction of pathogenic microorganisms and indicating the biosafety of the composting. [57] recommended that the conditions of time-temperature for the compost to meet the biosafety standards should be any of the following procedures: 53°C for 5 days, 55°C for 2.6 days or 70°C for 30 min. [58] with poultry carcasses composting in the climate of the United Kingdom, during the autumn and winter, for 8 weeks, have obtained positive results of carcass decomposition, as well as appropriate temperatures (60°C - 70°C) for the control of pathogens. [59] in studies on the biosafety of composting quoted that little attention has been given to strategies to evaluate the microbiological safety of composting systems, once there are different zones of the compost (e.g. the external edge of the pile) that usually have less organic matter and lower temperature. Thus the challenges for this type of benefit are greater than conventional. The analysis of variance for physical and chemical variables of the compost, are presented a significant effect ( $p < 0.05$ ) of the interaction between period and substrate for all variables, except for pH and K. The major effect of substrate was not significant only for the dry matter and the main effect of the period was significant for all variables. The significance effect of the interaction demonstrates that the effect of the substrate type depends on the period. The levels of physical and chemical variables measured in the substrate at the time zero, before its use as a composting substrate. In this way, it can be calculated the C/N ratio of the two substrates used, of 50.37 for the soybean straw and of 101.86 for the rice husk. Meanwhile, studies were performed using different sources of waste and residue from livestock and crop production, presenting a large variation in the initial C/N ratio, from 5/1 to 513/1 [60]. The mean values and standard errors of physical and chemical variables of composts according to periods and substrate type can be found in the Table 7. There was a significant difference between the substrate types for all variables in all periods, except for the dry matter, in the periods 2 and 4. Also there was an increase in the concentrations of the different parameters, expected given the addition of carcasses at each cycle. This increase was higher and statistically significant for the soybean straw, in the variables organic C, Cu, Fe, K, N, P, Zn and pH, besides the dry matter, although this difference had not been significant. The rice husk only presented levels of ash and Mn significantly higher than the soybean straw. The products obtained with carcass composting using two substrates tested can be classified as class D “compost organic fertilizer”, according to the Normative Instruction 23 [39] meeting the requirements set concerning the minimum levels of N, organic C and moisture. But in relation to the C/N ration considered an indicative of the process maturity level [61], only the compost with soybean straw presented desired levels on the 3<sup>rd</sup> (17.75) and 4<sup>th</sup> (13.29) periods. The compost with rice husk would need to be subjected to a secondary composting to reduce this ratio and meet the requirements of the IN (maximum C/N of 18) or be used for composting new carcasses until reaching the suitable C/N ratio.

Substrate	Period			
	1	2	3	4
<b>Ash (%)</b>				
Rice husk	14.45 ± 0.30a	15.55 ± 0.30a	15.05 ± 0.30 a	15.46 ± 0.30a
Soybean straw	6.19 ± 0.30 b	6.61 ± 0.30b	8.52 ± 0.30b	9.67 ± 0.30b
<b>Organic C (g/kg)</b>				
Rice husk	306 ± 3.19b	326 ± 3.19b	301 ± 3.19 b	296 ± 3.19b
Soybean straw	345 ± 3.19a	384 ± 3.19a	355 ± 3.19a	336 ± 3.19 a
<b>Cu (mg/kg)</b>				
Rice husk	1.78 ± 0.33b	2.95 ± 0.33b	2.29 ± 0.33b	3.62 ± 0.33 b
Soybean straw	7.04 ± 0.33a	6.82 ± 0.33a	6.88 ± 0.33a	9.92 ± 0.33a
<b>Fe (mg/kg)</b>				
Rice husk	224 ± 71.37 b	256±71.37b	263±71.37b	463±71.37b
Soybean straw	1384 ± 71.37a	852±71.37a	980±71.37a	1544±71.37 a
<b>K (mg/kg)</b>				
Rice husk	1828 ± 373.0b	2706±373.0b	3398±373.0 b	3688±373.0 b
Soybean straw	11983 ± 373.0a	13574±373.0a	13717±373.0 a	15226±373.0 a
<b>Dry matter (%)</b>				
Rice husk	81.74 ± 0.59 a	86.83 ± 0.59a	80.65 ± 0.59a	82.82 ± 0.59 a
Soybean straw	78.96 ± 0.59 b	86.70 ± 0.59a	83.02 ± 0.59 b	83.71 ± 0.59a
<b>Mn (mg/kg)</b>				
Rice husk	211 ± 7.48a	282 ± 7.48a	196 ± 7.48a	236 ± 7.48 a
Soybean straw	56.45 ± 7.48 b	48.21 ± 7.48b	61.25 ± 7.48 b	64.04 ± 7.48b
<b>N (mg/kg)</b>				
Rice husk	5058 ± 711.7b	7416±711.7b	11962±711.7b	14020±711.7b
Soybean straw	10233 ± 711.7a	13491±711.7a	19993±711.7a	25281±711.7a
<b>P (mg/kg)</b>				
Rice husk	714 ± 166.4b	1017±166.4b	1870±166.4a	1387±166.4b
Soybean straw	1295 ± 166.4a	1757±166.4 a	1247±166.4b	2096±166.4a
<b>pH</b>				
Rice husk	8.88 ± 0.06b	8.99 ± 0.06b	8.64 ± 0.06b	8.33 ± 0.06b
Soybean straw	9.20 ± 0.06a	9.30 ± 0.06a	8.95 ± 0.06a	8.64 ± 0.06a
<b>Zn (mg/kg)</b>				
Rice husk	13.87 ± 1.16 b	14.61 ± 1.16b	20.03 ± 1.16b	24.63 ± 1.16b
Soybean straw	19.52 ± 1.16a	20.21 ± 1.16a	29.36 ± 1.16a	41.89 ± 1.16a

Means followed by different letters in the columns are significantly different by the F-test ( $p \leq 0.05$ )

**Table 7.** Mean values and standard errors of physical and chemical variables of the composts according to the periods and type of substrate.

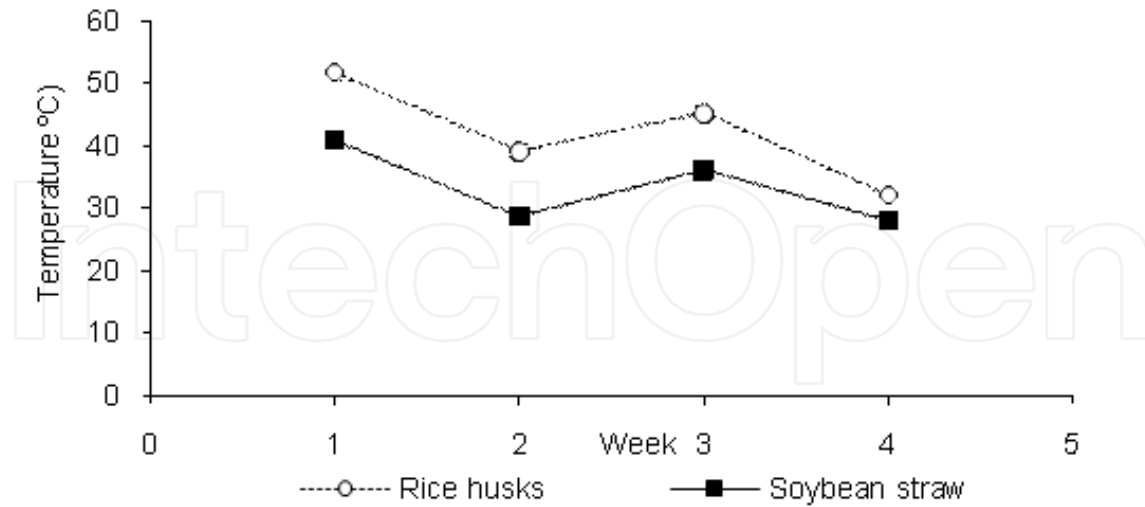

**Figure 8.** Mean profile of composting temperature according to substrates

Regarding the pH, both substrates presented varied values during the experimental period and reached the levels required by the IN-23 (pH 6.0) by the end of the 4<sup>th</sup> period. [62] found in the final compost in similar experiments, values of water pH in the range between 8.20 and 9.34. The levels of nitrogen increased at the end of composting periods. [54] achieved a compost with values of N, P, K between 17,710 -26,700 mg/Kg, 4,810-6,600 mg/Kg and 5,000-13,000 mg/Kg, respectively.

### 3. Conclusion

As compared to soybean straw, the use of rice husks as broiler litter material promotes better live performance of broilers up to 42 days of age. The use of soybean straw litter increases the incidence of footpad lesions relative to rice husks litter. Enterobacteria counts in broiler litter are reduced after downtime (day 0) when the litter is consecutively used by four flocks. Air relative humidity was higher when rice husks were used as litter material. Broiler litter used for three flocks, in average, complies with the minimal legal requirements to be traded as simple organic fertilizer, independently from the material. Soybean straw can be used as litter for rearing up to four flocks of broilers. At this same number of flocks, rice husks remain usable, whereas soybean straw is deteriorated and under humification. The number of darkling beetles was higher in the soybean straw litter and the rice husks litter presented 18.78 more chances of being contaminated with oocysts when ventilation was oscillating as compared to soybean straw litter. The soybean straw can represent an alternative of substrate for poultry carcasses composting, reaching values of C/N required by legislation with three reuses. Likewise, the rice husk can be used in composting broilers carcasses and can be reused for a greater number of times. The soybean straw presented a higher percentage of carcasses decomposition by the end of the 4<sup>th</sup> composting period ( $p < 0.05$ ).

## Acknowledgements

The authors thank Fundação de Apoio à Pesquisa de Santa Catarina - FAPESC, for funding this study, Unifrango Agroindustrial de Alimentos Ltda., in the person of the farmer Mr. Arsenio for supplying the litter material, and Roster Ind. e Com. Ltda for lending the fans.

## Author details

Valeria Maria Nascimento Abreu\*, Paulo Giovanni de Abreu, Doralice Pedroso de Paiva, Arlei Coldebella, Fátima Regina Ferreira Jaenisch, Taiana Cestonaro and Virginia Santiago Silva

\*Address all correspondence to: [Valeria.abreu@embrapa.br](mailto:Valeria.abreu@embrapa.br)

Brazilian Agricultural research Corporation, Embrapa Swine & Poultry, Concórdia, SC, Research DT CNPq, Brazil

## References

- [1] Angelo, J.C.; Gonzales, E.; Kondo, N. et al. Material de cama: qualidade, quantidade e efeito sobre o desempenho de frangos de corte. *Revista Brasileira de Zootecnia*, v. 26, n.1, p.121-130, 1997.
- [2] Benabdeljelil, K.; Ayachi, A. Evaluation of alternative litter materials for poultry. *Journal Applied Poultry Science*, v.5, p.203-209, 1996.
- [3] Mizubuti, I.Y.; Fonseca, N.A.N.; Pinheiro, J.W. Desempenho de duas linhagens comerciais de frangos de corte, criadas sob diferentes densidades populacionais and diferentes tipos de camas. *Revista da Sociedade Brasileira de Zootecnia*, v.23, n.3, p. 476-484, 1994.
- [4] Mouchrek, E.; Linhares, F.; Moulin, C.H.S. et al. Identificação de materiais de cama de frango de corte criados em diferentes densidades na época fria. In: *Reunião Anual Da Sociedade Brasileira De Zootecnia*, 29, 1992, Lavras. Anais... Lavras: SBZ, 1992. p. 344.
- [5] Santos, E.C.; Teixeira, C.J.T.B.; Muniz, J.A. et al. Avaliação de alguns materiais usados como cama sobre o desempenho de frangos de corte. *Ciência e Agrotecnologia*, v.14, n.4, p.1024-1030, 2000
- [6] Willis, W.L.; Murray, C.; Talbott, C. Evaluation of leaves as a litter material. *Poultry Science*, v.76, p.1138-1140, 1997.



- [7] Oliveira, M.C.; Carvalho, I.D. Rendimento e lesões em carcaça de frangos de corte criados em diferentes camas e densidades populacionais. *Ciência e Agrotecnologia*, v.26, n.5, p.1076-1081, 2002.
- [8] Araújo, J.C.; Oliveira, V.; Braga, G.C. Desempenho de frangos de corte criados em diferentes tipos de cama e taxa de lotação. *Ciência Animal Brasileira*, v.8, n.1, p.59-64, 2007.
- [9] Atapattu, N.S.B.M; Wickramasinghe, K.P. The use of refused tea as litter material for broiler chickens. *Poultry Science*, v.86, n.5, p.968-972, 2007.
- [10] Avila, V.S.; Oliveira, U.; Figueiredo, E.A.P. et al. Avaliação de materiais alternativos em substituição à maravalha como cama de aviário. *Revista Brasileira de Zootecnia / Brazilian Journal of Animal Science*, v.37, p.273-277, 2008.
- [11] Arends, J.J. Control, management of the litter beetle. *Poultry Digest*, v.46, n.542, p. 172-176, 1987.
- [12] Arends, J.J. External parasites and poultry pests. *In: CALNEK, B.W. Diseases of Poultry*. 9. ed. Ames: Iowa State Univ. Press. 1991. p.703-730 (710-712)
- [13] Chernaki-Leffer, A.M.; Biesdorf, S.M.; Almeida, L.M. et al. Isolamento de enterobactérias em *Alphitobius diaperinus* and na cama de aviários no oeste do Estado do Paraná, Brasil. *Revista Brasileira de Ciência Avícola/Brazilian Journal of Poultry Science*, v.4, n.3, p.243-247, 2002.
- [14] Vittori, J.; Schocken-Iturrino; R.P.; Trovó, K.P. et al. *Alphitobius diaperinus* como veiculador de *Clostridium perfringens* em granjas avícolas do interior paulista-Brasil. *Ciência Rural*, v.37, n.3, p.894-896, 2007.
- [15] Watson, D.W.; Denning, S.S.; Zurek, L. et al. Effects of lime hidrated on the growth and development of darkling beetle, *Alphitobius diaperinus*. *International Journal of Poultry Science*, v.2, n.2, p.91-96, 2003.
- [16] Salin, C.; Delettre, Y.R.; Vernon, P. Controlling the mealworm *Alphitobius diaperinus* (Coleoptera: Tenebrionidae) in broiler and turkey houses: field trials with a combined insecticide treatment: Insect Growth Regulator an Pyrethroid. *Journal of Economic Entomology*, v.96, n.1, p.126-130, 2003.
- [17] Surgeoner, G.A.; Romel, K. Control of the lesser mealworm in poultry houses (Coleoptera: Tenebrionidae). University of Ghelph. Disponível em: <<http://www.uoguelph.ca/pdc/Factsheets/FactsheetList.html>>. Acesso em: 10/11/05.
- [18] Silva, V.S.; Voss, D.; Coldebella, A. et al. Efeito de tratamentos sobre a carga bacteriana de cama de aviário reutilizada em frangos de corte. Concórdia: Embrapa Suínos e Aves, 2007. 4p. (Embrapa Suínos e Aves. Comunicado Técnico, 467).
- [19] Sas Institute Inc. System for Microsoft Windows: release 9.1. Cary, 2002-2003. 1 CD-ROM.

- [20] Xavier, L.H. Modelos univariado e multivariado para análise de medidas repetidas e verificação da acurácia do modelo univariado por meio de simulação. 2000. Tese (Mestrado) - Escola Superior de Agricultura "Luiz de Queiroz", Piracicaba.
- [21] Safrit, R.D.; Axtell, R.C. Evaluations of sampling methods for darkling beetles (*Alphitobius diaperinus*) in the litter of turkey and broiler houses. *Poultry Science*, v. 63, p. 2368-2375, 1984.
- [22] Windham, W.R. (Ed.) Animal feed. In: CUNNIFF, P. (Ed.) Official methods of analysis of AOAC international. 16. ed. Arlington: AOAC International, 1995. v. 1, cap. 4, p.1, 4, 27 (Method 965.17).
- [23] Sindicato Nacional Dos Fabricantes De Ração. Compêndio brasileiro de alimentação animal. São Paulo: SINDIRAÇÕES, 1998.
- [24] BRASIL. Ministério da Agricultura, Pecuária and Abastecimento (MAPA) Manual de métodos analíticos oficiais para fertilizantes minerais, orgânicos, organominerais and corretivos. Disponível em: <<http://www.agricultura.gov.br>>. Acesso em: 23 out.2007
- [25] Tedesco, M.J.; Gianelo, C.; Bissani, C.A. et al. Análise de solo, plantas and outros materiais. 2. ed. Porto Alegre: UFRGS/Dep de Solos, 1995.
- [26] Mendes, A.A.; Patricio, I.S.; Garcia, E.A. Utilização de fenos e gramíneas como material de cama para frangos de corte. In: Congresso Brasileiro De Avicultura, 10, 1987, Natal. Anais... Campinas: UBA, 1987. p.135.
- [27] Chamblee, T.N.; Yeatman, J.B. Evaluation of Rice hull ash as broiler litter. *The Journal of Applied Poultry Research*, v.12, n.4, p.424-427, 2003.
- [28] Grimes, J.L.; Carter, T.A.; Godwin, J.L. Use of a litter material made from cotton waste, gypsum and old newsprint for rearing broiler chickens. *Poultry Science*, v.85, v.4, p.563-568, 2006.
- [29] Toghyani, M.; Gheisari, A.; Modaresi, M. et al. Effect of different litter material on performance and behavior of broiler chickens. *Applied Animal Behaviour Science*, v. 122, p.48-52, 2010.
- [30] Huang, Y.; Yoo, J.S.; Kim, H.J. et al. Effect of bedding types and different nutrient densities on growth performance, visceral organ weight, and blood characteristics in broiler chickens. *The Journal of Applied Poultry Research*, v.18, n.1, p.1-7, 2009.
- [31] Paganini, F.J. Reutilização de cama na produção de frangos de corte: porquê, quando e como fazer. In: Conferência Apinco 2002 De Ciência E Tecnologia Avícolas, 2002, Campinas, SP. Anais... Campinas, SP: APINCO, 2002. p.194 – 206.
- [32] Azevedo, A.R.; Costa, A.M.; Alves, A.A. et al. Desempenho produtivo de frango de corte de linhagem Hubbard, criados sobre diferentes tipos de cama. *Revista Científica de Produção Animal*, v.2, n.1, p.52-57, 2000.

- [33] Fiorentin, L. Reutilização da cama de frangos e as implicações de ordem bacteriológica na saúde humana e animal. Concórdia: Embrapa suínos e Aves, 2005. 23p. (Embrapa Suínos e Aves. Documentos, 94).
- [34] Macklin, K.S.; Hess, J.B.; Bilgili, S.F. et al. Bacterial levels of pine shavings na sand used as poultry litter. *The Journal of Applied Poultry Research*, v.14, n.2, p.238-245, 2005.
- [35] Abreu P.G.; Abreu, V.M.N. Conforto térmico para aves. Concórdia: Embrapa Suínos e Aves, 2004, 5p. (Embrapa Suínos e Aves, Comunicado técnico, 365)
- [36] Soliman, E.S.; Taha, E.G.; Sobieh, M.A.A. et al. The influence of ambient environmental conditions on the survival of salmonella enteric serovar typhimurium in poultry litter. *International Journal of Poultry Science*, v.8, n.9, p.848-852, 2009.
- [37] Oliveira, M.C.; Goulart, R.B.; Silva, J.C.N. Efeito de duas densidades e dois tipos de cama sobre a umidade da cama e a incidência de lesões na carcaça de frango de corte. *Ciência Animal Brasileira*, v.3, n.2, p.7-12, 2002
- [38] BESSEL, W. Welfare of broilers: a review. *World's Poultry Science Journal*, Vol. 62, September 2006, n3, pp 455-466
- [39] BRASIL. Ministério da agricultura, Pecuária e Abastecimento. Secretária de Defesa Agropecuária. Instrução Normativa nº 23 de 31 agosto, 2005. Diário Oficial da República Federativa do Brasil, Brasília, 8 set. 2005. Seção 1. p. 12-15.
- [40] Coufal, C.D.; Chavez, C.; Niemeyer, P.R. et al. Effect of top-dressing recycled broiler litter on litter production, litter characteristic, and nitrogen mass balance. *Poultry Science*, v. 85, p.392-397, 2006.
- [41] Moore Jr, P.A.; Daniel, T.C; Eduards, D.R. et al. Evaluation of chemical amendments to reduce ammonia volatilization from poultry litter. *Poultry Science*, v.75, p.315-320, 1996.
- [42] Singh, A.; Bicudo, J.R.; Tinoco, A.L. et al. Characterization of nutrientes in built-up broiler litter using trench and random walk sampling methods. *The Journal of Applied Poultry Research*, v.13, p.426-432, 2004.
- [43] Oviedo-Rondón, E.O. Tecnologias para mitigar o impacto ambiental da produção de frangos de corte. *Revista Brasileira de Zootecnia*, v.37, suplemento especial, p. 239-252, 2008.
- [44] Turazi, C.M.V.; Junqueira, A.M.R.; Oliveira, A.S. et al. *Horticultura Brasileira*, v.24, n. 1, p.65-70, 2006.
- [45] Pinto, D.M.; Ribeiro, P.B.; Bernardi, E. Flutuação populacional de *Alphitobius diaperinus* (Panzer, 1879) (Coleoptera: Tenebrionidae), capturados por armadilha do tipo sanduíche, em granja avícola, no Município de Pelotas, RS. *Arquivos do Instituto Biológico*, v.72, n.2, p.199-203, 2005.

- [46] Godinho, R.P.; Alves, L.F.A. Método de avaliação de população de cascudinho (*Alphitobius diaperinus*) panzer em aviários de frango de corte. Arquivos do Instituto Biológico, v.76, n.1, p.107-110, 2009
- [47] Uemura, D.H.; Alves, L.F.A.; Opazo, M.U. et al. Distribuição and dinâmica populacional do cascudinho *Alphitobius diaperinus* (Coleoptera: Tenebrionidae) em aviários de frango de corte. Arquivos do Instituto Biológico, v.75, n.4, p.429-435, 2008.
- [48] Chernaki, A.M; Almeida, L.M. Exigências térmicas, period de desenvolvimento and sobrevivência de imaturos de *Alphitobius diaperinus* (Panzer) (Coleoptera: Tenebrionidae). Neotropical Entomology, v.30, n.3, p.365-8, 2001
- [49] Shirley, M.W. Epizootiologia. In: Simpósio Internacional Sobre Coccidiose, 1994, Santos. Anais... Santos: [s.n.], 1994, p.11-22.
- [50] Macsafley, L. M.; DUPOLDT, C.; GETER, F. Agricultural waste management system component design. In: Krider, J. N.; Rickman, J. D. (Ed.). Agricultural waste management field handbook. Washington, D.C.: Department of Agriculture, Soil Conservation Service, 1992. p. 1-85.
- [51] Diniz Filho, E. T.; Mesquita, L. X.; Oliveira, A. M.; Nunes, C. G. F.; Lira, J. F. B. A prática da compostagem no manejo sustentável de solos. Revista Verde de Agroecologia e Desenvolvimento Sustentável, v. 2, n. 2, p. 27-36, 2007.
- [52] Budziak, C. R.; Maia, C. M. B. F.; Mangrich, A. S. Transformações químicas da matéria orgânica durante a compostagem de resíduos da indústria madeireira. Química Nova, v. 27, n. 3, p. 399-403, 2004.
- [53] Rynk, R. ed. On farm composting handbook. Ithaca: Northeast Regional Agricultural Engineering Service, 1992. 186p. (Cooperative Extension. NRAES, 54).
- [54] Fiori, M. G. S.; Schoenhals, M.; Follador, F.A. C. Análise da evolução tempo-eficiência de duas composições de resíduos agroindustriais no processo de compostagem aeróbia. Engenharia Ambiental, v. 5, n. 3, p. 178-191, 2008.
- [55] Hassen, A.; Belguith, K.; Jedidi, N.; Cherif, A. Microbial characterization during composting of municipal solid waste. Bioresource Technology, v. 80, n. 3, p. 217-25, 2001.
- [56] Sivakumar, K.; Kumar, V. R. S.; Jagatheesan, P. N. R.; Viswanathan, K.; Chandrasekaran, D. Seasonal variations in composting process of dead poultry birds. Biore-source Technology, v. 99, n. 2, p. 3708-3713, 2008.
- [57] Haug, R. T. The practical handbook of compost engineering. Boca Raton: Lewis Publishers Press Inc., 1993.
- [58] Lawson, M. J.; Keeling, A. A. Production and physical characteristics of composted poultry carcasses. British Poultry Science, v. 40, n. 5, p. 706-708, 1999.
- [59] Wilkinson, K. G. The biosecurity of on-farm mortality composting. Journal of Applied Microbiology, v. 102, n. 3, p. 609-618, 2007.

- [60] Valente, B. S.; Xavier, E. G.; Morselli, T. B. G.A.; Jahnke, D. S.; Brum Jr., B. S.; Cabrera, B. R.; Moraes, P. O.; Lopes, D. C. N. Fatores que afetam o desenvolvimento da compostagem de resíduos orgânicos. *Archivos de Zootecnia*, v. 58, n. 1, p. 59-85, 2009.
- [61] Reis, M. F. P.; Escosteguy, P. V.; Selbach, P. Teoria e prática da compostagem de resíduos sólidos urbanos. Passo Fundo: UPF, 2004.
- [62] Kumar, V. R. S.; Sivakumar, K.; Purushothaman, M. R.; Natarajan, A.; Amanullah, M. M. Chemical changes during composting of dead birds with caged layer manure. *Journal of Applied Sciences Research*, v. 3, n. 10, p. 1100-1104, 2007.